Steelcase Health

Volume 6

Terms and Conditions	2
Sample Order Form	10
Participating Steelcase Dealers	12
Steelcase Showrooms and Manufacturing Locations	17

Product Information

Seating and Tables (SIN 711.11/711.16/711.17/ 711.18/711.19/711.99)	19
Casegoods (SIN 711.2/71.315)	223
Technology Support (SIN 71.315)	389
Tables (SIN 711.11)	397

Surface Materials	401
Resources	439
Lock and Keying	440
Style Number Index	442

► For a list of all trademarks, refer to the last page of this specification guide.

Terms and Conditions

Customer Information

For more information, please contact your participating Steelcase GSA dealer.

For more information, please contact your participating Steelcase GSA dealer.

For more information, please contact your participating Steelcase GSA dealer.

For more information, please contact your participating Steelcase GSA dealer.

For more information, please contact your participating Steelcase GSA dealer.

For more information, please contact your participating Steelcase GSA dealer.

For more information, please contact your participating Steelcase GSA dealer.

For more information, please contact your participating Steelcase GSA dealer.

Sample Order Form

Sample Order Form

ORDER FOR SUPPLIES OR SERVICES			PAGE	OF	PAGES
IMPORTANT: Mark all packages and papers with contract and/or order numbers.					
DATE OF ORDER 1 6-1-04	CONTRACT NO. (If any) 2 GS-27F-0014V	ORDER NO. 3 10 - 000	REQUISITION/REFERENCE NO.		
ISSUING OFFICE (Address correspondence to) 4 GSA 1 Town Street City, State, Zip Name and Telephone Number		SHIP TO: (Consignee and address, ZIP Code) 5 GSA 2 Town Street City, State, Zip Name and Telephone Number			
TO: CONTRACTOR (Name, address and ZIP Code) 6 Steelcase Inc. c/o Participating Dealer 901 44th Street, SE Grand Rapids, MI 49508 Attn: Solutions Fullfillment Team CH-2W-SS (GSA)		Cage Code: 39880		TYPE OF ORDER <input type="checkbox"/> A. PURCHASE — Reference your _____ Please furnish the following on the terms and conditions specified on both sides of this order and on the attached sheets, if any, including delivery as indicated. This purchase is negotiated under authority of: <input type="checkbox"/> B. DELIVERY — Except for billing instructions on the reverse, this delivery order is subject to instructions contained on this side only of this form and is issued subject to the terms and conditions of the above-numbered contract.	
ACCOUNTING AND APPROPRIATION DATA			REQUISITIONING OFFICE		
			BUSINESS CLASSIFICATION (Check appropriate box(es)) 20 <input type="checkbox"/> SMALL <input checked="" type="checkbox"/> OTHER THAN SMALL <input type="checkbox"/> DIS-ADVAN-TAGED <input type="checkbox"/> WOMEN-OWNED		
FCA DESTINATION 7		GOVERNMENT NO.	DELIVER TO FCA DESTINATION ON OR BEFORE (Date) 8 ARO date	DISCOUNT TERMS 9 Net 30 days	
PLACE OF INSPECTION AND ACCEPTANCE					

(See reverse for Rejections)

ITEM NO. (A)	SUPPLIES OR SERVICES (B)	QUANTITY ORDERED (C)	UNIT (D)	UNIT PRICE (E)	AMOUNT (F)	QUANTITY ACCEPTED (G)	
1	10 One lot of Steelcase Office Furniture: See attached specifications	13 1		14 \$000	15 \$000		
2	11 Design: \$55.41/hour	2 hrs		\$000	\$000		
3	12 Installation	1		\$000	\$000		
SEE BILLING INSTRUCTIONS ON REVERSE		SHIPPING POINT		GROSS SHIPPING WEIGHT		INVOICE NO.	
		MAIL INVOICE TO: (Include ZIP Code) 17 GSA, 3 Town Street, City, State, Zip				16 \$000	(H) TOT. (Cont. pages) ◀ (I) GRAND TOTAL ◀
UNITED STATES OF AMERICA BY (Signature) 18 Contracting Officer signature and telephone no.				NAME (Typed) 19 John Doe, Department Manager TITLE: CONTRACTING/ORDERING OFFICER			

NSN 7540_01_152_8083

50347-101

OPTIONAL FORM 347 (10-83)
Prescribed by GSA
FAR (48 CFR) 53.213 (e)

- 1 Order date
- 2 Contract number
- 3 Order number
- 4 Issuing office: Requester name and telephone number
- 5 Shipping address: Contact name and telephone number
- 6 Contractor:
Steelcase Inc.
c/o Participating Dealer
901 - 44th Street, S.E.
Grand Rapids, MI 49508
Attn: Solutions Fulfillment Team
- 7 FCA destination
- 8 ARO date (After Receipt of Order)
- 9 Terms: Net 30 days
- 10 Complete product description, including SIN number, style number, all applicable surface materials.
- 11 Separate line for design
- 12 Separate line for installation
- 13 Quantity ordered
- 14 Individual unit price
- 15 Amount (quantity x unit price)
- 16 Total cost
- 17 Invoice address
- 18 Authorized contracting officer signature and telephone number
- 19 Authorized contracting officer name and title (typed)
- 20 Steelcase is the seller of record and is not registered as "small," "disadvantaged," or "woman-owned." If one of these boxes is checked in error, a modification will be required.

Please note on order that all invoice payments must be sent to:

Steelcase Inc.
62087 Collection Center Dr.
Chicago, IL 60693-0620

Storage and Delays

(Open Market) In the event that the site is not accessible, or safe and adequate storage space is not available during installation, the furnishings will be stored until delivery or installation can be accomplished. Pricing for storage will be negotiated on a project-by-project basis. Invoices will be sent to the local government purchasing facility upon delivery of the furniture to a designated storage facility. Steelcase shall provide notice to the Government purchasing facility that the furnishings are available for inspection by the Government at the Storage facility. Upon this notice, the Government, or representative for the Government, must inspect and accept the furniture prior to payment of any invoice. The inspection and acceptance must be completed within reasonable time frame agreed upon by both parties. Payment will be made by the Government 30 days after acceptance of the furniture.

Participating Steelcase Dealers

Alabama

Dekalb Office of Alabama
2901 Second Ave South
Birmingham, AL 35233
Phone: (205) 933-9100

Kyser OfficeWorks Inc.
2400 Spruce Street
Montgomery, AL 36107-3150
Phone: (334) 834-9400
Fax: (334) 262-0701

OEC Business Interiors
104 East I-65 Service Road North
Mobile, AL 36607-2501
Phone: (251) 471-3368
Fax: (251) 471-0019

Office Interiors by OSCO
1300 Meridian Street
Suite 203
Huntsville, AL 35801
Phone: (256) 604-5696
Fax: (256) 604-5699

OSCO Inc.
229 Grant Street SE
Decatur, AL 35601-2511
Phone: (256) 340-5100
Fax: (256) 340-5108

Alaska

Capital Office Systems
1120 East 35th Avenue
Anchorage, AK 99508-4257
Phone: (907) 777-1500
Fax: (907) 777-1515

Capital Office Systems
3201 Industrial Avenue
Fairbanks, AK 99701-7370
Phone: (907) 456-3946
Fax: (907) 452-6257

Capital Office Systems
3143 Channel Drive
Juneau, AK 99801-7214
Phone: (907) 780-3636
Fax: (907) 780-2290

Arizona

Atmosphere Commercial Interiors
815 North Central Avenue
Phoenix, AZ 85004
Phone: (602) 252-6971

Atmosphere Commercial Interiors
Suite 100
88 East Broadway Boulevard
Tucson, Arizona 85701-1720
Phone: (520) 792-4200

Atmosphere Commercial Interiors
Suite 100
88 East Broadway Boulevard
Tucson, Arizona 85701-1720
Phone: (520) 792-4200
Fax: (540) 791-9568

Arkansas

ImageWorks
Suite B
1424 North Shackleford
Little Rock, AR 72211
Phone: (501) 944-7501

Today's Office Inc.
717 West 7th Street
Little Rock, AR 72201-4044
Phone: (501) 375-5050
Fax: (501) 375-1350

Today's Office Inc.
3157 West Sunset Avenue
Springdale, AR 72762-4945
Phone: (479) 751-5861
Fax: (479) 756-2233

California

BKM Office Environments
816 Via Alondra
Camarillo, CA 93012
Phone: (877) 256-1256
Fax: (805) 339-9032

BKM San Diego
Suite 100
9201 Spectrum Center Blvd.
San Diego, CA 92123-1407
Phone: (858) 569-4700
Fax: (858) 277-8931

One Workplace L. Ferrari
2500 De La Cruz Blvd.
Santa Clara, CA 95050
Phone: (669) 800-2500
Fax: (669) 800-2501

One Workplace L. Ferrari
7220 Edgewater Drive
Oakland, CA 94621
Phone: (510) 729-7800
Fax: (510) 729-7801

One Workplace L. Ferrari
475 Brannan Street
San Francisco, CA 94107-1731
Phone: (415) 357-2200
Fax: (415) 357-2201

Peninsula Business Interiors
325 Main Street
Salinas, CA 93901-2705
Phone: (831) 757-4107
Fax: (831) 757-1339

Tangram Interiors
Suite 102
4057 W Shaw Ave
Fresno, CA 93722-6212
Phone: (559) 275-7070
Fax: (559) 275-7080

Tangram Interiors
Suite 100
2850 South Red Hill Avenue
Santa Ana, CA 92705-5532
Phone: (949) 955-6700
Fax: (949) 955-6799

Tangram Interiors
9200 Sorensen Avenue
Santa Fe Springs, CA 90670-2645
Phone: (562) 365-5000
Fax: (562) 365-5399

United Corporate Furnishings
1780 North Market Blvd.
Sacramento, CA 95834-1997
Phone: (916) 553-5900
Fax: (916) 553-5800

Colorado

Office Outfitters & Planners Inc.
749 Main Street
Grand Junction, CO 81501-3535
Phone: (970) 245-6300
Fax: (970) 245-6301

OfficeScapes
2506 Zeppelin Rd
Colorado Springs, CO 80916
Phone: (719) 574-1113
Fax: (719) 574-1133

OfficeScapes
9900 East 51st Avenue
Denver, CO 80238-2430
Phone: (303) 574-1115
Fax: (303) 574-1116

OfficeScapes
Suite 180
4812 McMurry Avenue
Fort Collins, CO 80525-6222
Phone: (970) 223-5959
Fax: (970) 223-5858

Connecticut

Red Thread
300 East River Drive
East Hartford, CT 06108-4205
Phone: (860) 528-9981
Fax: (860) 528-1843

Red Thread
488 Wheelers Farm Rd.
Milford, CT 06461
Phone: (203) 874-7754
Fax: (203) 876-7915

Red Thread
700 Canal St 3rd Fl
Stamford, CT 06902
Phone: (860) 528-9981

Red Thread
40 Main Street
Torrington, CT 06790
Phone: (860) 482-2679
Fax: (860) 482-3590

Delaware

Corporate Interiors Inc.
223 Lisa Drive
New Castle, DE 19720-4193
Phone: (302) 323-9100
Fax: (302) 323-9251

Florida

American Business Interiors
215 Waverly Place
Melbourne, FL 32901-5444
Phone: (321) 723-5003
Fax: (321) 984-4221

Empire Office
Suite 140
2 Oakwood Boulevard
Hollywood, FL 33020
Phone: (954) 707-6200

Empire Office
South Florida
3201 Commerce Parkway
Miramar, FL 33025-3908
Phone: (954) 435-7300
Fax: (954) 435-7212

Empire Office
Suite 17
2315 Lynx Lane
Orlando, FL 32804
Phone: (407) 628-2400

Empire Office
5112 West Linebaugh Avenue
Tampa, FL 33624
Phone: (813) 418-3300

Empire Office
Suite 2
7830 Byron Drive
West Palm Beach, FL 33404-3332
Phone: (561) 840-8600
Fax: (561) 840-1873

Leitz & Reed Office Products
1119 Florida Avenue
Lynn Haven, FL 32444-4622
Phone: (850) 271-2600
Fax: (850) 271-0076

OEC Business Interiors
1601 NW 80th Boulevard
Gainesville, FL 32606-9140
Phone: (352) 332-1192
Fax: (352) 333-8002

· OEC Business Interiors
· 2393 SW College Road
· Ocala, FL 34474-1661
· Phone: (352) 620-2888
· Fax: (352) 620-2891

· OEC Business Interiors
· 6254 North W Street
· Pensacola, FL 32503-2746
· Phone: (850) 438-1100
· Fax: (850) 432-0003

· Office Furniture & Design Concepts
· 11866 Metro Parkway
· Ft. Myers, FL 33966-1307
· Phone: (239) 337-1212
· Fax: (239) 337-4910

· Perdue Office Interiors
· Suite 100
· 5 W Forsyth
· Jacksonville, FL 32256-7440
· Phone: (904) 737-5858
· Fax: (904) 737-6088

· Perdue Office Interiors
· Suite C7
· 1516 Capital Circle SE
· Tallahassee, FL 32301
· Phone: (850) 383-4225

Georgia

· Advent Business Interiors
· 1318 U.S. HWY 82 West
· Leesburg, GA 31721
· Phone: (229) 439-7418
· Fax: (229) 435-1279

· Advent Business Interiors
· 110 West Macon Park Dr.
· Macon, GA 31210
· Phone: (478) 471-0600

· DeKalb Office Environments
· 1320 Ridgeland Parkway
· Alpharetta, GA 30004-8442
· Phone: (770) 360-0200
· Fax: (770) 360-0305

· McWaters Inc.
· 3708 Benchmark Drive
· Augusta, GA 30907
· Phone: (706) 396-5400
· Fax: (706) 396-5401

· McWaters Inc.
· 117 Prosperity Drive
· Savannah, GA 31408-9551
· Phone: (912) 352-9000
· Fax: (912) 352-2034

Hawaii

· Interior Showplace Ltd.
· 956 Queen Street
· Honolulu, HI 96814-4118
· Phone: (808) 593-8420
· Fax: (808) 591-8324

Idaho

· Porter's Office Products
· 435 West Center Street
· Pocatello, ID 83204-3241
· Phone: (208) 232-1233
· Fax: (208) 232-8759

· Porter's Office Products
· 1050 North 2nd East
· Rexburg, ID 83440-5127
· Phone: (208) 356-4616
· Fax: (208) 356-8901

· Office Environment Company
· 623 South Americana Blvd.
· Boise, ID 83702-5120
· Phone: (208) 385-0507
· Fax: (208) 385-9392

Illinois

· A. Pomerantz
· Suite 940
· 222 Merchandise Mart Plaza
· Chicago, IL 60654-1223
· Phone: (312) 929-3335
· Fax: (312) 929-3311

· Atmosphere Commercial Interiors
· 801 North Perryville Road
· Rockford, IL 61107
· Phone: (815) 398-3300

· Egyptian Business Furniture
· 129 West Main Street
· Belleville, IL 62220-1501
· Phone: (618) 234-2323
· Fax: (618) 236-3295

· Interiors for Business Inc.
· 409 N River Street
· Batavia, IL 60510-2359
· Phone: (630) 761-1070
· Fax: (630) 761-1065

· Lincoln Office
· 205 Eastgate Drive
· Washington, IL 61571-9238
· Phone: (309) 427-2500
· Fax: (309) 427-2625

· Forward Space
· Suite 614
· 222 Merchandise Mart Plaza
· Chicago, IL 60654-1223
· Phone: (312) 563-5206

· Forward Space
· 1142 N North Branch Street
· Chicago, IL 60642
· Phone: (312) 942-1100
· Fax: (312) 942-9840

· Forward Space
· 13820 West Business Center Drive
· Lake Forest, IL 60045-1181
· Phone: (847) 573-8890
· Fax: (847) 573-8891

· Forward Space
· Suite 150
· 1111 West 22nd Street
· Oak Brook, IL 60523
· Phone: (312) 563-5206

Indiana

· Business Furnishings LLC
· 4102 Meghan Beeler Court
· South Bend, IN 46628
· Phone: (574) 243-3255
· Fax: (574) 243-3266

· Business Furniture LLC
· 6102 Victory Way
· Indianapolis, IN 46278-2934
· Phone: (317) 216-1600
· Fax: (317) 216-1601

· Corporate Design Inc.
· Suite 400
· 1419 West Lloyd Expressway
· Evansville, IN 47710-1002
· Phone: (812) 422-3000
· Fax: (812) 422-3413

· Lincoln Office
· 1200 Arrowhead Court
· Crown Point, IN 46307-8222
· Phone: (219) 662-2777
· Fax: (219) 662-7770

Iowa

· Lincoln Office
· 1026 Mound St
· Davenport, IA 52803
· Phone: (563) 322-5660

· Tallgrass Business Resources
· Highway 6 West
· 218 Second Street
· Coralville, IA 52241-2608
· Phone: (319) 338-3135
· Fax: (319) 338-7484

· Workspace Inc.
· 309 Locust Street
· Des Moines, IA 50309-1788
· Phone: (515) 288-7090
· Fax: (515) 288-0250

Kansas

· Design Central Inc.
· 152 South 5th Street
· Salina, KS 67401
· Phone: (785) 825-4131
· Fax: (785) 825-4778

· Scott Rice Office Interiors
· 224 East Douglas
· Wichita, KS 67211-1640
· Phone: (316) 269-2700
· Fax: (316) 269-3527

· Scott Rice Office Works
· 14720 West 105th Street
· Lenexa, KS 66215-4414
· Phone: (913) 888-7600
· Fax: (913) 227-7793

Kentucky

· Office Resources Inc.
· 530 Corvette Drive
· Bowling Green, KY 42101-7132
· Phone: (270) 781-5858
· Fax: (270) 781-5884

· Office Resources Inc.
· 101 Bradley Drive
· Nicholasville, KY 40356-9121
· Phone: (859) 885-6161
· Fax: (859) 885-9610

· Office Resources Inc.
· 816 East Broadway
· Louisville, KY 40204-1053
· Phone: (502) 589-8400
· Fax: (502) 589-8408

Louisiana

· Frost-Barber Inc.
· 9322 Interline Avenue
· Baton Rouge, LA 70809-1966
· Phone: (225) 926-5000
· Fax: (225) 926-5011

· Workplace Solutions
· 401 St. Joseph Street.
· New Orleans, LA 70130
· Phone: (504) 522-9558
· Fax: (504) 522-7070

Maine

· Red Thread
· One City Center
· Portland, ME 04101
· Phone: (207) 774-4900
· Fax: (207) 774-8155

Maryland

· Arbee Associates
· 6311 Ammendale Road
· Beltsville, MD 20705-1249
· Phone: (410) 385-5180
· Fax: (410) 385-5199

· Arbee Associates
· 9300 Gaither Road
· Gaithersburg, MD 20877
· Phone: (301) 963-3900
· Fax: (301) 977-1734

· Dancker, Sellow & Douglas Inc.
· Suite 309
· 509 Exeter Street
· Baltimore, MD 21202
· Phone: (301) 671-2541
· Fax: (301) 797-1504

Participating Steelcase Dealers, continued

Dancker, Sellaw & Douglas Inc.
9200 Alaking Court
Suite 100
Capitol Heights, MD 20743
Phone: (301) 350-8700
Fax: (301) 350-9393

Massachusetts

Red Thread
Suite 600
101 Seaport Blvd.
Boston, MA 02210-1838
Phone: (617) 439-4900
Fax: (617) 439-4131

Red Thread
Suite 150
293 Boston Post Road West
Marlborough, MA 01752-4615
Phone: (508) 449-6550
Fax: (508) 449-6570

Red Thread
Suite 1108
1350 Main Street
Springfield, MA 01103
Phone: (413) 736-1802

Red Thread
100 Fordham Road
Wilmington, MA 01887
Phone: (978) 658-3900
Fax: (978) 694-4107

Michigan

Custer Office Environments Inc.
2435 Plaza Drive
Benton Harbor, MI 49022-2229
Phone: (616) 926-8719
Fax: (616) 926-9482

Custer Office Environments Inc.
217 Grandville Ave SW
Grand Rapids, MI 49503-4013
Phone: (616) 458-6322
Fax: (616) 458-1117

Custer Office Environments Inc.
5737 East Cork Street
Kalamazoo, MI 49048-9668
Phone: (269) 342-3919
Fax: (269) 342-3923

Custer Office Environments
442 East Michigan
Marquette, MI 49885
Phone: (906) 226-1161
Fax: (906) 226-1164

Custer Office Environments
120 East Front Street
Traverse City, MI 49684
Phone: (616) 402-8489

NBS
701 Salzburg Avenue
Bay City, MI 48706-5390
Phone: (989) 895-8574
Fax: (989) 895-8545

NBS
5133 West Grand River Avenue
Lansing, MI 48906-9117
Phone: (517) 886-0072
Fax: (517) 886-0014

NBS
2595 Bellingham Drive
Troy, MI 48083-2036
Phone: (248) 823-5400
Fax: (248) 823-5401

Minnesota

Atmosphere Commercial Interiors
Suite 350
81 South 9th Street
Minneapolis, MN 55402-3226
Phone: (612) 343-0868
Fax: (612) 332-5733

Burgher Office Equipment Company
101 East Chestnut Street
Virginia, MN 55792-2512
Phone: (218) 749-2661
Fax: (218) 749-2662

Duluth Typewriter & Business Furniture
30 N 3rd. Ave W
Duluth, MN 55802-1607
Phone: (218) 722-5811
Fax: (218) 722-4876

General Office Products Company
4521 Highway 7
Minneapolis, MN 55416-4098
Phone: (952) 925-7500
Fax: (952) 925-7531

Mississippi

Workplace Solutions
251 West South Street
Jackson, MS 39203-3636
Phone: (601) 354-4960
Fax: (601) 353-6231

Workplace Solutions
2207 5th Street
Meridian, MS 38652
Phone: (601) 484-7279

Workplace Solutions
520 Main Street
Natchez, MS 39120
Phone: (601) 442-1494
Fax: (601) 442-0457

Workplace Solutions
718 West Bankhead St.
New Albany, MS 38652
Phone: (662) 534-0882
Fax: (662) 534-5753

OEC Business Interiors
12199 Highway 49 N.
Suite 300
Gulfport, MS 39503-3167
Phone: (228) 539-9575
Fax: (228) 539-9566

Missouri

Color-Art Integrated Interiors
1325 North Warson Road
Saint Louis, MO 63132-1807
Phone: (314) 432-3000
Fax: (314) 993-2752

Marathon Office Interiors
1715 Paris Road
Columbia, MO 65201-5571
Phone: (573) 875-7115
Fax: (573) 875-7116

Montana

KR Office Interiors
119 North 7th Avenue
Bozeman, MT 59715
Phone: (406) 587-3775
Fax: (406) 587-4636

KR Office Interiors
1710 North Montana Avenue
Helena, MT 59601
Phone: (406) 513-1004
Fax: (406) 513-1006

Missoula's Office City
115 West Broadway Street
Missoula, MT 59802-4217
Phone: (406) 543-7171
Fax: (406) 543-4254

Peterson's Quality Office Equipment
502 North 32nd Street
Billings, MT 59101-6003
Phone: (406) 245-5151
Fax: (406) 245-7516

Western Office Equipment
317 2nd Street South
Great Falls, MT 59405-1802
Phone: (406) 761-7473
Fax: (406) 761-0245

Nebraska

Eakes Office Plus
2911 13th Street
Columbus, NE 68601-4829
Phone: (402) 564-2679
Fax: (402) 564-0295

Eakes Office Plus
Suite 201
2630 North Yager Road
Fremont, NE 68025-7800
Phone: (402) 941-5001
Fax: (402) 941-5002

Eakes Office Plus
617 West Third Street
Grand Island, NE 68801-5946
Phone: (308) 382-8026
Fax: (308) 382-7401

Eakes Office Plus
839 West Second Street
Hastings, NE 68901-5099
Phone: (402) 463-2537
Fax: (402) 463-6802

Eakes Office Plus
2401 Avenue A
Kearney, NE 68847-5498
Phone: (308) 234-2538
Fax: (308) 234-2540

Eakes Office Plus
110 N 35th Street
Lincoln, NE 68503
Phone: (402) 438-6700
Fax: (402) 438-6701

Eakes Office Plus
1803 North 6th Street
Beatrice, NE 68310
Phone: (402) 228-7202
Fax: (402) 228-0262

Eakes Office Plus
120 Norris Avenue
McCook, NE 69001
Phone: (308) 345-5447
Fax: (308) 345-5237

Eakes Office Plus
510 W. 13th Street
Souix City, NE 68776
Phone: (402) 412-2334

Eakes Office Plus
201 South 1st Street
Norfolk, NE 68701-5303
Phone: (402) 371-4181
Fax: (402) 371-5139

Eakes Office Plus
520 North Vine Street
North Platte, NE 69101-3954
Phone: (308) 534-7800
Fax: (308) 534-3936

Eakes Office Plus
710 North Lincoln Ave.
York, NE 68467
Phone: (402) 362-5442
Fax: (402) 362-7530

Sheppard's Business Interiors Inc.
725 South 72nd Street
Omaha, NE 68114-4665
Phone: (402) 393-8888
Fax: (402) 393-0113

Nevada

Machabee Office Environments
6435 Sunset Corporate Drive
Las Vegas, NV 89120-2798
Phone: (702) 263-8800
Fax: (702) 263-8801

Machabee Office Environments
1335 Greg Parkway #101
Sparks, NV 89431
Phone: (775) 329-3145
Fax: (775) 786-5710

New Hampshire

Red Thread
Suite 103
650 Elm Street
Manchester, NH 03101-1160
Phone: (603) 668-5511
Fax: (603) 668-6851

New Jersey

Arbee Associates
1531 South Washington Avenue
Piscataway, NJ 08854-3815
Phone: (732) 424-3900
Fax: (732) 752-6034

Concepts Office Furnishings
280 North Midland Avenue
Building J
Saddle Brook, NJ 07663-5708
Phone: (201) 727-9110
Fax: (201) 727-9112

Dancker, Sellow, and Douglas
291 Evans Way
Somerville, NJ 08876-3766
Phone: (908) 231-1600
Fax: (908) 231-6469

W.S. Goff Company Inc.
5104 Oakland Blvd.
Mays Landing, NJ 08330-2016
Phone: (609) 625-5600
Fax: (609) 625-5633

New Mexico

Business Environments
5351 Wilshire Avenue, N.E.
Albuquerque, NM 87113-1834
Phone: (505) 888-4400
Fax: (505) 889-9146

New York

AFD Contract Furniture Inc
810 7th Avenue
New York, NY 10019
Phone: (212) 721-7100
Fax: (212) 721-7175

Merkel-Donohue
1 Interstate Avenue
Albany, NY 12205
Phone: (518) 273-9359
Fax: (518) 272-1552

Empire Office Inc.
105 Madison Avenue
New York, NY 10016-8810
Phone: (212) 607-5500
Fax: (212) 607-5654

Merkel-Donohue
1349 University Avenue Suite 2
Rochester, NY 14607
Phone: (585) 325-7696
Fax: (585) 325-3065

Prentice Office Environments
472 Franklin Street
Buffalo, NY 14202-1302
Phone: (716) 884-8452
Fax: (716) 884-0894

Stevens Office Interiors
6804 Manlius Center Road
East Syracuse, NY 13057-3902
Phone: (315) 479-5595
Fax: (315) 428-1688

Waldner's Business Environments
125 Route 110
Farmingdale, NY 11735-4864
Phone: (631) 844-9300
Fax: (631) 694-3503

Waldner's Business Environments
215 Lexington Avenue, 9th Floor
New York, NY 10016-6023
Phone: (212) 696-7500
Fax: (212) 696-7699

Waldner's Business Environments
411 Theodore Fremd Avenue
3rd Floor, South Building
Rye, NY 10580-1410
Phone: (914) 921-8500
Fax: (914) 921-0991

North Carolina

Office Environments Inc.
11407 Granite Street
Charlotte, NC 28273-6429
Phone: (704) 714-7200
Fax: (704) 714-7400

Young Office Environments
of Asheville Inc.
71 Thompson St
Asheville, NC 28803-2328
Phone: (888) 202-0508
Fax: (828) 505-1974

Storr Office Environments Inc.
496 Gallimore Dairy Road
Greensboro, NC 27409-9202
Phone: (336) 217-4500
Fax: (336) 217-4501

Storr Office Environments Inc.
10800 World Trade Blvd.
Raleigh, NC 27617-4200
Phone: (919) 313-3700
Fax: (919) 313-3701

Williams Office Environments Inc.
407 Ray Avenue
Fayetteville, NC 28301-4915
Phone: (910) 483-0354
Fax: (910) 486-4077

North Dakota

Fireside Office Products Inc.
1713 East Bismarck Expressway
Bismarck, ND 58504-6706
Phone: (701) 258-8586
Fax: (701) 223-9598

Hannaher's
1809 13th Avenue North
Grand Forks, ND 58203-2323
Phone: (701) 746-6466
Fax: (701) 746-0737

Hannaher's Inc.
4324 20th Avenue SW
Fargo, ND 58103-4434
Phone: (701) 277-7222
Fax: (701) 277-7097

Ohio

Business Furniture
8 North Main Street
Dayton, OH 45439
Phone: (937) 293-1010
Fax: (937) 293-7501

Loth Inc.
3574 East Kemper Road
Cincinnati, OH 45241-2009
Phone: (513) 554-4900
Fax: (513) 554-8737

Loth Company
855 Grandview Avenue
Columbus, OH 43215-1123
Phone: (614) 487-4000
Fax: (614) 487-4306

NBS
4 North St. Clair Street
Toledo, OH 43604
Phone: (419) 662-2040
Fax: (419) 662-2041

Ohio Desk
34 Swartz Road
Akron, OH 44319
Phone: (330) 499-1030

Ohio Desk
1122 Prospect Avenue
Cleveland, OH 44115-1292
Phone: (216) 623-0600
Fax: (216) 623-0611

Ohio Desk
5100 Market Street
Youngstown, OH 44512
Phone: (330) 782-3331

Oklahoma

Scott Rice
2900 North Hemlock Circle
Broken Arrow, OK 74012-1185
Phone: (918) 362-4300
Fax: (918) 362-4303

Scott Rice
7501 Broadway Ext
Oklahoma City, OK 73116-9015
Phone: (405) 848-2224
Fax: (405) 848-3999

Oregon

Hypn
Suite 103/104
150 SW Scalehouse Loop
Bend, OR 97702
Phone: (541) 317-8777
Fax: (541) 317-2833

Hypn
620 NE 19th Avenue
Portland, OR 97232-2832
Phone: (503) 226-4151
Fax: (503) 226-9233

Pennsylvania

A. Pomerantz & Company
Suite 7000
701 Market Street
Philadelphia, PA 19106-1597
Phone: (215) 408-2100
Fax: (215) 408-2110

Corporate Interiors
Suite 200
161 Washington Street
Conshohocken, PA 19428-2083
Phone: (610) 631-5400
Fax: (610) 631-2720

Interior Workplace Solutions LLC.
145 Stewart Road
Wilkes-Barre, PA 18706
Phone: (570) 288-7211
Fax: (570) 970-5817

Franklin Interiors
Suite 600
2740 Smallman Street
Pittsburgh, PA 15222-4720
Phone: (412) 261-2525
Fax: (412) 255-4089

Participating Steelcase Dealers, continued

Pennsylvania

Interior Workplace Solutions LLC.
6765 Ambassador Drive
Allentown, PA 18106-9510
Phone: (610) 391-0733
Fax: (610) 391-1155

Interior Workplace Solutions LLC.
Suite B-25
2209 Quarry Drive
Reading, PA 19609-1155
Phone: (610) 670-1800
Fax: (610) 670-8181

McCartney's Inc.
819 Howard Avenue
Altoona, PA 16601-4727
Phone: (814) 505-1111
Fax: (814) 949-6197

Phillips Workplace Interiors
6345 Flank Drive
Harrisburg, PA 17112
Phone: (844) 228-2600

South Carolina

Aiken Office Supply Inc.
2560 Whiskey Road
Aiken, SC 29803-9664
Phone: (803) 648-8339
Fax: (803) 649-4470

McWaters Inc.
1104 Shop Road
Columbia, SC 29201-4743
Phone: (803) 256-8303
Fax: (803) 252-5567

McWaters Inc.
3841 Commercial Center Drive
Ladson, SC 29456-4146
Phone: (843) 486-1823

Wulbern-Koval Company Inc.
1111 Morrison Drive
Charleston, SC 29403-3119
Phone: (843) 577-7666
Fax: (843) 577-7299

Young Office Environments
1280 Ridge Road
Greenville, SC 29607-4626
Phone: (864) 281-9500
Fax: (864) 281-9555

South Dakota

Interstate Office Products Inc.
228 South Main Avenue
Sioux Falls, SD 57104-6310
Phone: (605) 339-0300
Fax: (605) 339-1989

Western Stationers
714 Saint Joseph Street
Rapid City, SD 57701-2721
Phone: (605) 342-3310
Fax: (605) 342-4746

Tennessee

Bentco Office Solutions
1501 Stuart Street
Chattanooga, TN 37406
Phone: (423) 756-4437
Fax: (423) 756-6198

Memphis Business Interiors
4539 West Distriplex Drive
Memphis, TN 38118-7280
Phone: (901) 360-8899
Fax: (901) 360-8370

Office Resources Inc.
4020 Armory Oaks Drive
Nashville, TN 37204
Phone: (615) 376-1200
Fax: (615) 376-1245

Workspace Interiors
Suite 300
200 E. Main Street
Kingsport, TN 37660-4354
Phone: (423) 392-2600
Fax: (423) 392-2601

Workspace Interiors
2820 Middlebrook Pike
Knoxville, TN 39721
Phone: (865) 223-5404
Fax: (865) 223-5405

Texas

Abilene Printing & Stationery
218 Cedar Street
Abilene, TX 79601-5720
Phone: (915) 677-2673
Fax: (915) 675-6963

BKM Total Office of Texas
9755 Clifford Drive
Dallas, TX 75220
Phone: (214) 902-7200
Fax: (214) 902-7201

Business Interiors
1111 Valley View Lane
Irving, TX 75061-6008
Phone: (817) 858-2000
Fax: (817) 858-2020

McCoys Inc.
6869 Old Katy Road
Houston, TX 77024-2105
Phone: (713) 862-4600
Fax: (713) 862-7676

Rockford Business Interiors
211 East Riverside Drive
Austin, TX 78704-1203
Phone: (512) 442-0703
Fax: (512) 442-6555

Texas Wilson Office Furniture &
Services
5801 George McVay Drive
McAllen, Texas 78503
Phone: (210) 647-8800
Fax: (210) 647-3110

Texas Wilson Office Furniture &
Services

6812 Fairgrounds Pkwy
San Antonio, TX 78238-4536
Phone: (210) 647-8800
Fax: (210) 647-3110

West Supply Company
1601 Scurry
Big Spring, TX 79720
Phone: (432) 264-1788
Fax: (432) 264-1789

West Supply Company
2 South Chadbourne Street
San Angelo, TX 76903-5875
Phone: (325) 655-8181
Fax: (325) 655-5480

Utah

MidWest Office Furniture
987 South West Temple
Salt Lake City, UT 84101-2988
Phone: (801) 359-7681
Fax: (801) 355-2713

Vermont

Red Thread
180 Battery St Ste 210
Burlington, VT 05401-5212
Phone: (802) 862-0434
Fax: (802) 862-0729

Virginia

Barrows
1302 Rockland Avenue
Roanoke, VA 24012-3838
Phone: (540) 362-5700
Fax: (540) 362-4826

Creative Office Environments
11798 North Lakeridge Boulevard
Ashland, VA 23005-8152
Phone: (804) 329-0400
Fax: (804) 321-3134

Creative Office Environments LLC
650 Peter Jefferson Parkway #140
Charlottesville, VA 22911
Phone: (434) 327-1898
Fax: (434) 327-1896

Creative Office Environments LLC
Suite C
500 Woodlake Circle
Chesapeake, VA 23320-2807
Phone: (757) 549-4801
Fax: (757) 549-2795

reDistrict
Suite 30
66 Canal Center Plaza
Arlington, VA 22314
Phone: (703) 276-8901
Fax: (703) 276-8908

Washington

OpenSquare
6th Floor
5601 Sixth Avenue South
Seattle, WA 98108-2522
Phone: (206) 768-8000
Fax: (206) 768-0236

OpenSquare
126 South Sheridan Street
Spokane, WA 99202-1527
Phone: (509) 483-1000
Fax: (509) 483-1011

Wisconsin

Atmosphere Commercial Interiors
999 Fourier Drive Suite 200
Madison, WI 53717
Phone: (608) 257-0521
Fax: (608) 257-1859

Puerto Rico

AFD Contract Furnishings
Suite 250
350 Chardon Avenue
Torre Chardon
San Juan, Puerto Rico 00918-2123
Phone: (787) 754-2938
Fax: (787) 754-8076

Showrooms

Atlanta

Steelcase Inc.
Suite AL-175
303 Peachtree Center
Atlanta, GA 30303
Phone: (404) 523-2201

Chicago

Steelcase Worklife Chicago
Suite 300
222 Merchandise Mart
Chicago, IL 60654-1174
Phone: (312) 321-3720

Chicago

Coalesse
Suite 1032
222 Merchandise Mart
Chicago, IL 60654
Phone: (312) 467-1783

Dallas

Steelcase Inc.
1616 Hi Line Drive
Dallas, TX 75207
Phone: (214) 871-3044

Grand Rapids

Steelcase Inc.
901 44th Street, SE
Grand Rapids, MI 49508-7594
Phone: (616) 247-2710

New York

Steelcase Worklife New York
4 Columbus Circle
New York, NY 10019-1100
Phone: (212) 445-8800

Philadelphia

Steelcase Inc.
One Liberty Place
1650 Market Street, 3rd Floor
Philadelphia, PA 19103-7307
Phone: (215) 561-5331

San Francisco

Steelcase Inc.
Suite 110
475 Brannan Street
San Francisco, CA 94107
Phone: (415) 344-6700

Santa Monica

Steelcase Inc.
1217 2nd Street
Santa Monica, CA 90401-1180
Phone: (310) 633-2200

Washington D.C.

Steelcase Inc.
1121 14th Street NW
4th Floor
Washington, DC 20005

Manufacturing Sites

Amex de Mexico

Calle 5 Sur No.160
Ciudad Industrial
Tijuana, Mexico B.C. 22500
Phone: 52-662-342-6234

Athens

214 Durham Drive
Athens, AL 35611
Phone: (256) 232-8112

Grand Rapids Wood Furniture

4100 68th Street SE
Caledonia, MI 49316
Phone: (616) 698-5735

Kentwood Distribution Center

4384 52nd Street SE
Kentwood, MI 49512-9673

Kentwood West

4360 52nd Street SE
Kentwood, MI 49512

Details

901 44th Street SE
Grand Rapids, MI 49508
Phone: (616) 247-2710







Reynosa Plant

Ave. Prologis S/N Ed. 8 Suite
801 Prologis Park Pharr Bridge
Reynosa,
Tamaulipas, Mx CP. 88780
Phone: 52-899-263-9000



Steelcase Health Seating and Tables

► For more detailed product information, see the Steelcase Health Seating and Casegoods Specification Guides or consult your Steelcase dealer.

		
Statement of Line	20	
		
Families of Seating		
Aspekt Straight Arm (SIN 711.17)	38	
Aspekt Wave Arm (SIN 711.17)	48	
Aspekt Ganging Tables (SIN 711.17)	58	
Aspekt Freestanding Tables (SIN 711.17)	59	
Cura (SIN 711.17/711.18)	60	
Embold (SIN 711.16)	62	
Leela (SIN 711.16)	80	
Leela Tables (SIN 711.16)	82	
Mitra (SIN 711.17)	83	
Mitra Tables (SIN 711.11)	88	
Neighbor (SIN 711.16)	90	
Outlook Jarrah (SIN 711.17)	98	
Outlook Sequoia (SIN 711.17)	106	
Outlook Tables (SIN 711.11/711.17)	114	
Sieste (SIN 711.11/711.16/711.17)	115	
Tava (SIN 711.16)	118	
Tava Tables (SIN 711.16)	129	
Freestanding Tables (SIN 711.11/711.17)	131	
		
Lounge Seating		
Regard (SIN 711.16)	134	
		
Multi-Purpose Seating		
Verge Stool (SIN 711.99)	157	
		
Stackable Seating		
Sorrel (SIN 711.19)		158
		
Recliner Seating		
Empath Recliners (SIN 711.16)		168
Mineral Recliners (SIN 711.16)		171
Mitra Recliner (SIN 711.16)		172
		
Sleeper Seating		
Mitra Sleeper (SIN 711.16)		173
Sieste Sleeper (SIN 711.16)		174
Surround (SIN 711.16)		176
X-tenz Sleeper (SIN 711.16)		220

Statement of Line

Steelcase Health Seating

Families of Seating

Aspekt Straight Arm

Specifying
▶ Pages 38-47

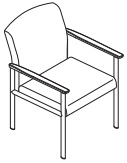

Single-Seat Chair

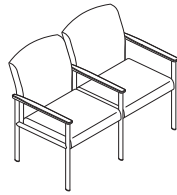

Two-Seat Chair

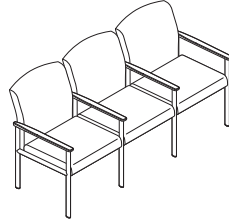

Three-Seat Chair

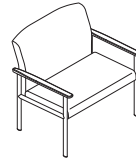

Bariatric Chair

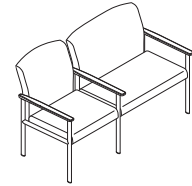

Two-Seat Bariatric
Combination Unit

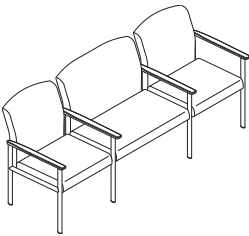

Three-Seat Bariatric
Combination Unit

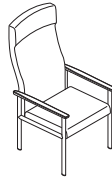

High-Back Chair

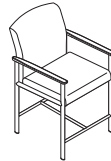

Easy Access
Arm Chair

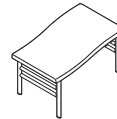

Bench



Footstool

Aspekt Wave Arm

Specifying
▶ Pages 48-57

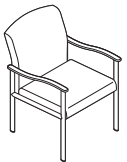

Single-Seat Chair

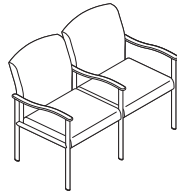

Two-Seat Chair

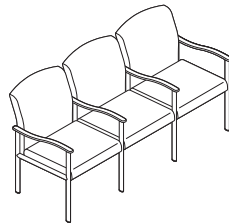

Three-Seat Chair

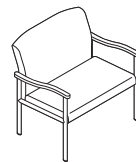

Bariatric Chair

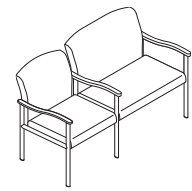

Two-Seat Bariatric
Combination Unit

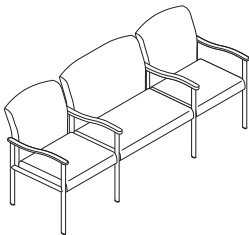

Three-Seat Bariatric
Combination Unit

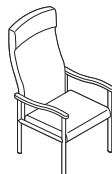

High-Back Chair

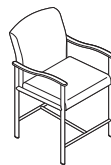

Easy Access
Arm Chair

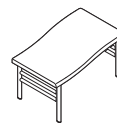

Bench



Footstool

Aspekt Ganging Tables

Specifying
▶ Page 58

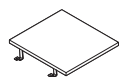

In-line
Table



Left-Hand
End Table



Right-Hand
End Table



Corner
Table



90°
Table

Families of Seating, continued

Aspekt Freestanding Tables

Specifying
▶ Page 59



Oval
Table

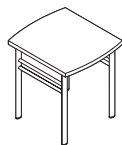

Bow
Table



Round
Table

Cura

Specifying
▶ Page 60



Four-Leg Base Chair



Sled-Base Chair



Ottoman

Tip: Chairs are available in mid- and high-back versions. Mid-back is shown.

Families of Seating, continued

Embold

Specifying
▶ Pages 62–79



21"W Single Seat

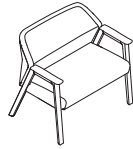

24"W Midsize Single Seat

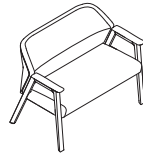

32"W Bariatric Single Seat

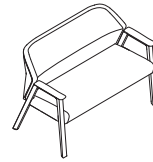

43"W Loveseat

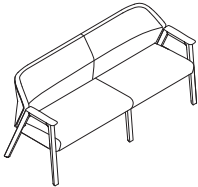

66"W Multiple Seat

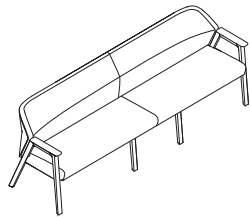

88"W Multiple Seat

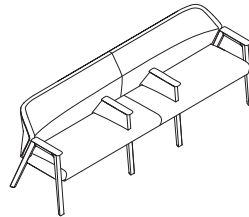

88"W Multiple Seat
Bariatric Combination



21"W Easy Access Seat

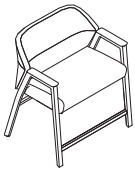

32"W Easy Access Seat



20" Diameter
Circular Table



19"D x 32"W Rounded
Rectangle Table



20"D x 42"W Racetrack
Table

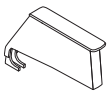

Midarm

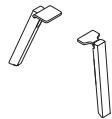

Midleg

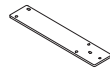

Midleg and Midarm
Support Plate

Families of Seating, continued

Leela

Specifying
▶ Pages 80–82

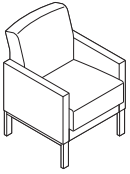

21"W Lounge Chair

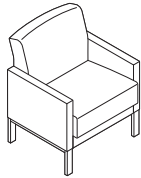

24"W Lounge Chair

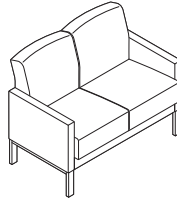

Loveseat

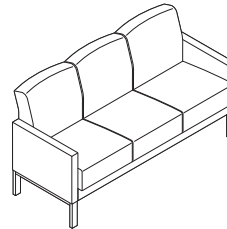

Sofa

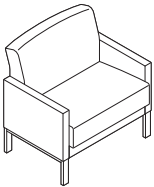

30"W Bariatric Lounge Chair

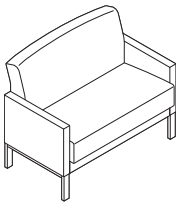

40"W Bariatric Lounge Chair

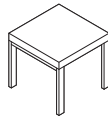

Square Freestanding Table

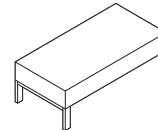

Rectangle Freestanding Table

Mitra

Specifying
▶ Pages 83–87



Single-Seat Chair

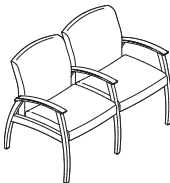

Two-Seat Chair

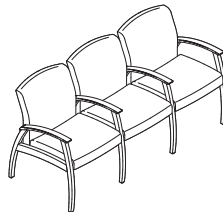

Three-Seat Chair

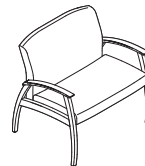

Bariatric Chair

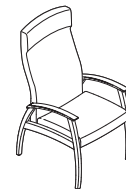

High-Back Chair

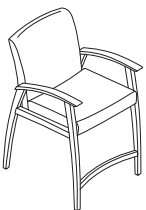

Easy Access Chair

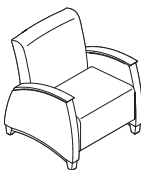

Lounge Chair

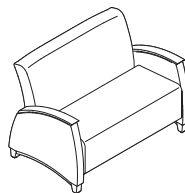

Loveseat

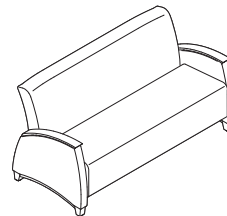

Sofa

Families of Seating, continued

Mitra Tables

Specifying
▶ Pages 88–89



Round Table



Oval Table

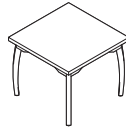

Square Table

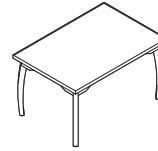

Rectangular
Table

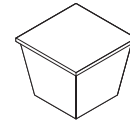

Square
Drum Table

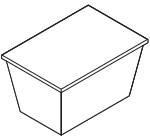

Rectangular
Drum Table



Round
Drum Table

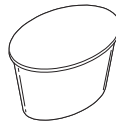

Oval
Drum Table

Neighbor

Specifying
▶ Pages 90–97

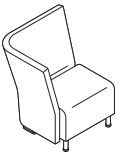

Wrap-Back Seating
Units

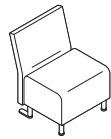

Armless Seating
Units

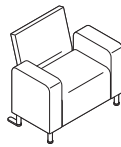

Seating Units with
Upholstered Arms

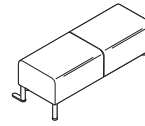

Benches



Ottoman



Corner Ganging
Units

Families of Seating, continued

Outlook Jarrah

Specifying
▶ Pages 98–105

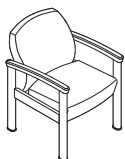

Single-Seat Chair

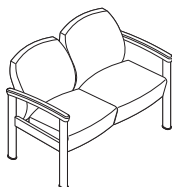

Two-Seat Chair

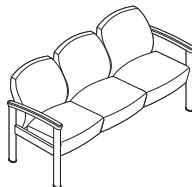

Three-Seat Chair

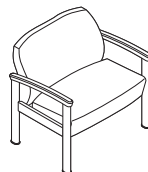

Bariatric Chair

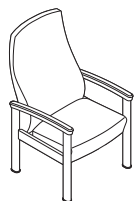

High-Back Chair

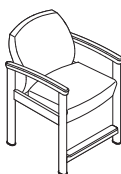

Easy Access Chair

Outlook Sequoia

Specifying
▶ Pages 106–113

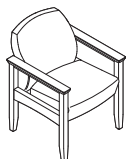

Single-Seat Chair

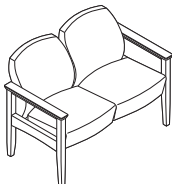

Two-Seat Chair

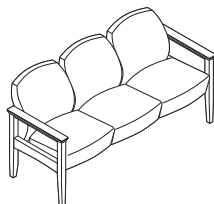

Three-Seat Chair

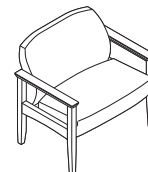

Bariatric Chair

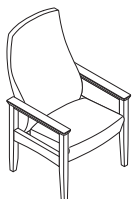

High-Back Chair

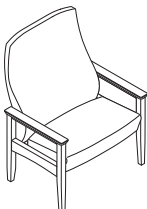

Bariatric High-Back
Chair

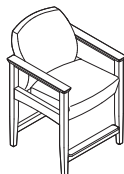

Easy Access Chair

Families of Seating, continued

Outlook Tables

Specifying
▶ Pages 114

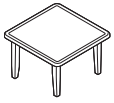

Freestanding
Square Table

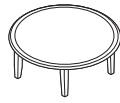

Freestanding
Round Table



Freestanding
Rectangular Table

Siesta

Specifying
▶ Pages 115–117

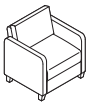

Lounge Chair

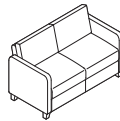

Loveseat

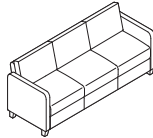

Sofa

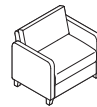

Bariatric Chair



Freestanding
Square Table

Families of Seating, continued

Tava

Specifying
▶ Pages 118–126

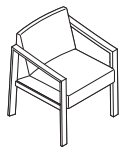

Open Arm Single-Seat Guest Chair

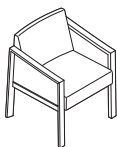

Closed Arm Single-Seat Guest Chair

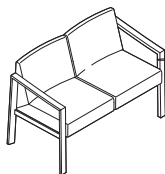

Open Arm Two-Seat Guest Chair

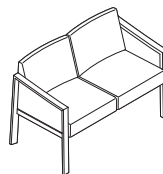

Closed Arm Two-Seat Guest Chair

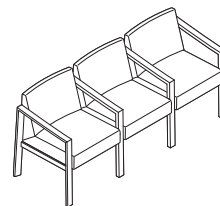

Open Arm Three-Seat Guest Chair

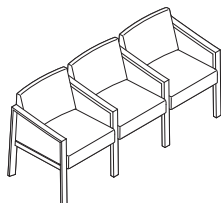

Closed Arm Three-Seat Guest Chair

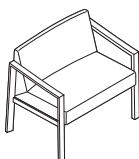

Open Arm Bariatric Guest Chair

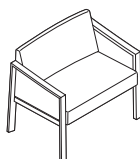

Closed Arm Bariatric Guest Chair

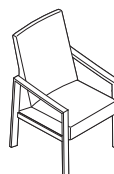

Open Arm High-Back Chair

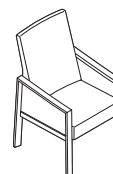

Closed Arm High-Back Chair

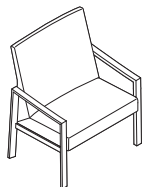

Open Arm Bariatric High-Back Chair

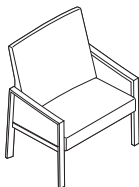

Closed Arm Bariatric High-Back Chair

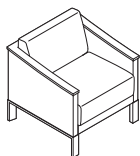

Lounge Chair

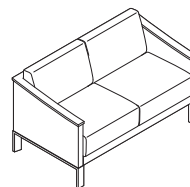

Loveseat

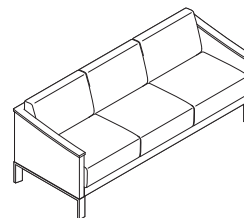

Sofa

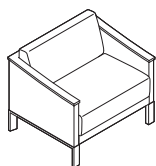

Bariatric Lounge

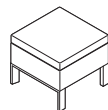

21"W Bench

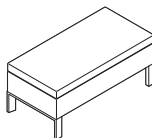

42"W Bench

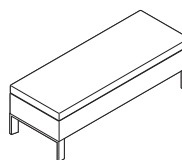

56"W Bench

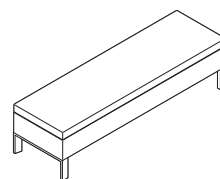

70"W Bench

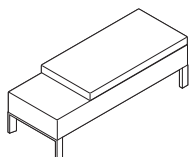

56"W Bench with One Table

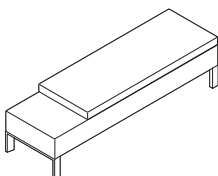

70"W Bench with One Table

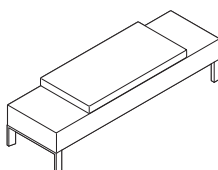

70"W Bench with Two Tables

Families of Seating, continued

Tava Tables

Specifying
▶ Pages 129 and 130

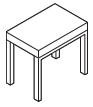

14"W Side Table

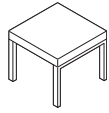

21"W Side Table

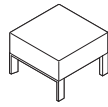

21"W Coffee Table

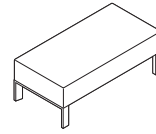

42"W Coffee Tab

Freestanding Tables

Specifying
▶ Pages 131–133

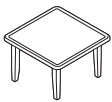

Freestanding
Square Table

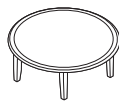

Freestanding
Round Table

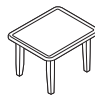

Freestanding
Rectangular Table



Drum Table

Lounge Seating

Regard

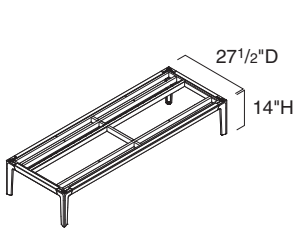

Single-Sided

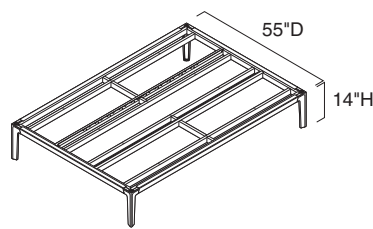

Double-Sided

Specifying
▶ Page 134

Base Frames

	44"W	55"W	60½"W	66"W	71½"W	77"W	82½"W	88"W
Single-sided	•	•	•	•	•	•	•	•
Double-sided	•	•	•	•	•	•	•	•

Lounge Seating, continued

Regard, continued

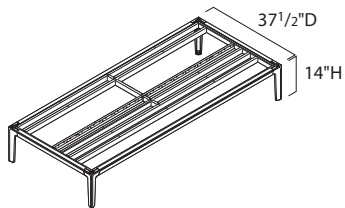

Specifying
▶ Page 134

Planter Frames

	44"W	55"W	60 1/2"W	66"W	71 1/2"W	77"W	82 1/2"W	88"W
Planter	●	●	●	●	●	●	●	●

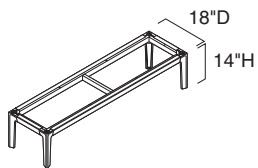

Specifying
▶ Page 134

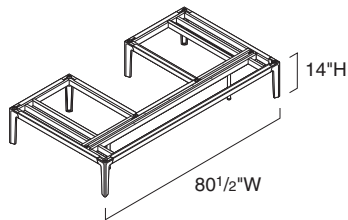

Specifying
▶ Page 134

Bench Frames

	44"W	66"W
Bench	●	●

Booth Frames

	44"W	55"W
Booth	●	●

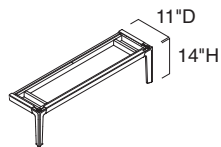

Specifying
▶ Page 134

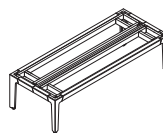

Specifying
▶ Page 134

Wall-Mounted Cabinet Frame

	55"W
Wall-mounted Cabinet	●

Freestanding Back-to-Back Cabinet

	55"W
Freestanding Back-to-Back Cabinet	●

Statement of Line Steelcase Health Seating, continued

Lounge Seating, continued

Regard, continued

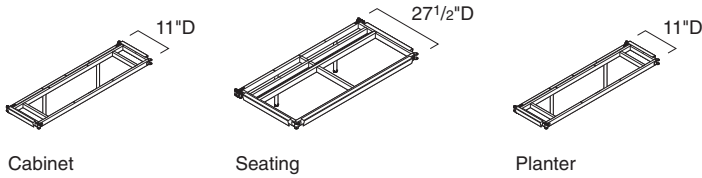

Specifying
▶ Page 136

Frame Extension

	44\"W	55\"W	60½\"W	66\"W	71½\"W	77\"W	82½\"W	88\"W
Cabinet Frame Extensions		●						
Seating Frame Extensions		●						
Planter Frame Extensions	●		●	●	●	●	●	●

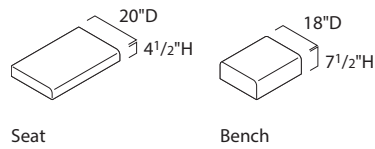

Specifying
▶ Page 138

Frame Brackets

Specifying
▶ Page 137

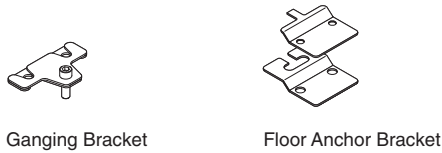

Seat and Bench Cushions

	22\"W	33\"W
Seat Cushions	●	●
Bench Cushions	●	●

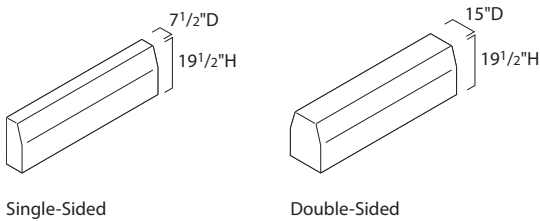

Specifying
▶ Page 140

Backs

	33\"W	38½\"W	44\"W	49½\"W	55\"W	60½\"W	66\"W	71½\"W	77\"W	82½\"W	88\"W
Single-sided	●		●		●	●	●	●	●	●	●
Double-sided	●	●	●	●	●	●	●	●	●	●	●

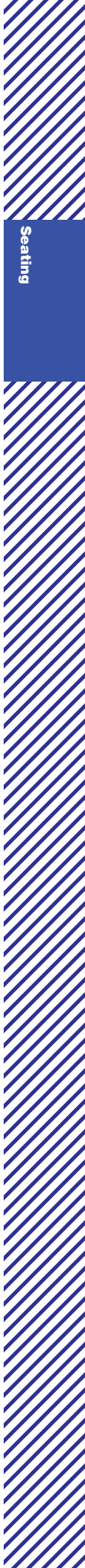

Seating

Lounge Seating, continued

Regard, continued

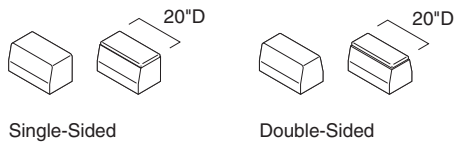

Specifying
▶ Page 143

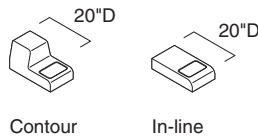

Specifying
▶ Page 144

Arms

	5½"W	11"W
Single-Sided Arms	●	●
Double-Sided Arms	●	●

Utility Arms

	11"W
Contour Arms	●
In-line Table	●

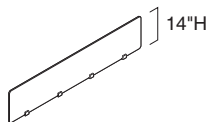

Specifying
▶ Page 145

Privacy Screens

	33"W	38½"W	44"W	49½"W	55"W	60½"W	66"W	71½"W	77"W	82½"W	88"W
Privacy Screens	●	●	●	●	●	●	●	●	●	●	●

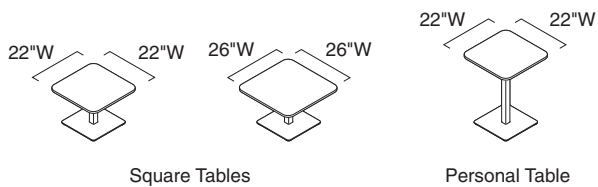

Specifying
▶ Page 146

Tables

	15"W	29"W
Square Tables	●	
Personal Table		●

Lounge Seating, continued

Regard, continued

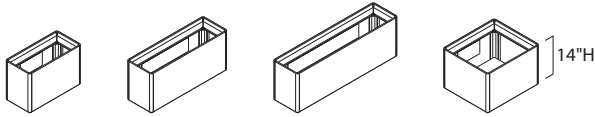

Specifying
▶ Page 147

Planters

	22"W	33"W	44"W
11"D	●	●	●
22"D	●	●	●

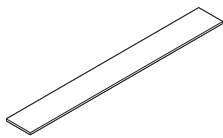

Specifying
▶ Page 148

Planter Shelves

	44"W	55"W	60½"W	66"W	71½"W	77"W	82½"W	88"W
11"D	●	●	●	●	●	●	●	●

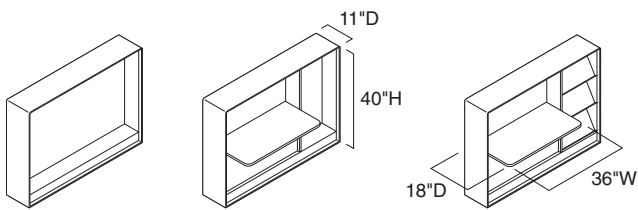

Media

Open Desk

Desk Cabinet with
Display Shelves

Specifying
▶ Page 150

Cabinets

	55"W
Media Cabinets	●
Desk Cabinets	●

Lounge Seating, continued

Regard, continued

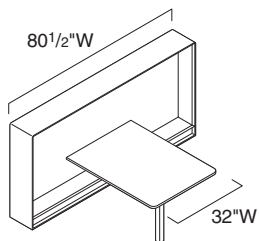

Specifying
▶ Page 152

Booth with Table

	44\"/>	
Booth with Table	●	●

Regard Electrical Components

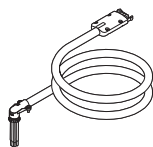

Hardwire Power Infeed

Specifying
▶ Page 153

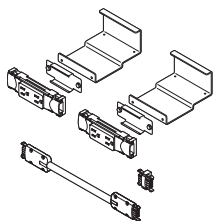

Power Kits

Specifying
▶ Page 153

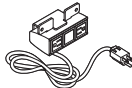

Power Strips

Specifying
▶ Page 154

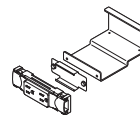

Receptacle Kits

Specifying
▶ Page 155

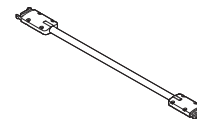

Modular Harness

Specifying
▶ Page 155



Connectors

Specifying
▶ Page 156

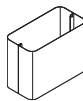

Vertical Cable Riser

Specifying
▶ Page 156



Cable Clamp

Specifying
▶ Page 156

Multi-Purpose Seating

Verge

Specifying
▶ Page 157



With Casters



With Glides



With Glides



With Glides

Stackable Seating

Sorrel

Specifying
▶ Pages 158–165



Stacking Chair
Without Arms*

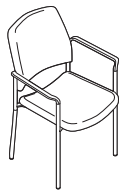

Stacking With Arms*

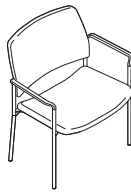

Bariatric Chair*

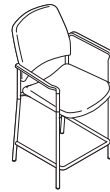

Easy Access Chair*

*Available with straight or wall saver legs.

Sorrel Table

Specifying
▶ Page 166



Laminate Square
Table

Recliner Seating

Empath Recliners

Specifying
▶ Page 168



With Fixed Arms*

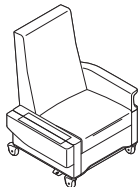

With Left Flip-Down Arm*

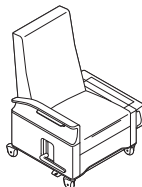

With Right Flip-Down Arm*

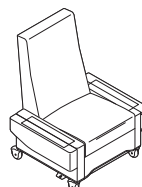

With Dual Flip-Down Arms*

*Available with Trendelenburg

Mineral Recliners

Specifying
▶ Page 171



With Fixed Arms

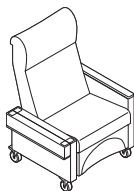

With Left Flip-Down Arm

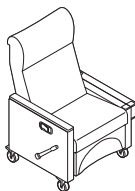

With Right Flip-Down Arm

Mitra Recliner

Specifying
▶ Page 172

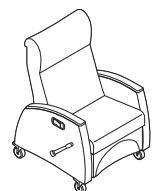

Recliner

Mitra Sleeper Chair

Specifying
▶ Page 173

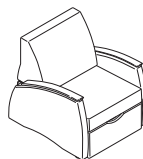

Sieste Sleeper

Specifying
▶ Page 174

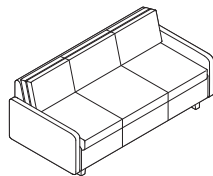

Sleeper with Arms

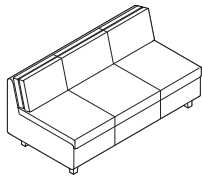

Sleeper with End Panels

Sleeper Seating

Surround

Specifying
▶ Pages 176–219

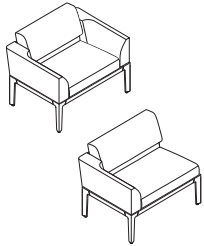

Lounge, 44" Frame Width

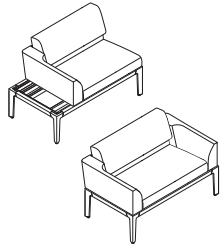

Lounge, 55" Frame Width

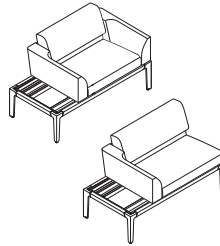

Lounge, 60 1/2" Frame Width

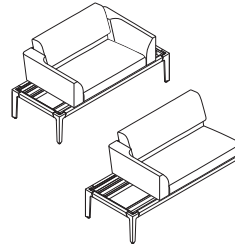

Lounge, 66" Frame Width

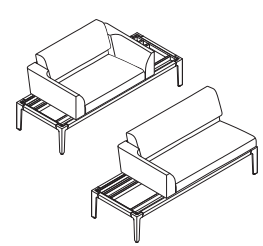

Lounge, 71 1/2" Frame Width

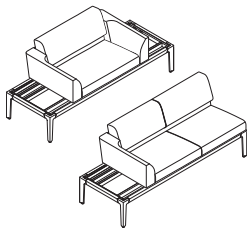

Lounge, 77" Frame Width

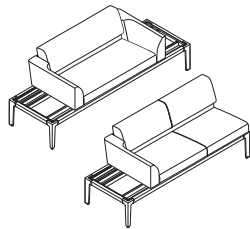

Lounge, 82 1/2" Frame Width

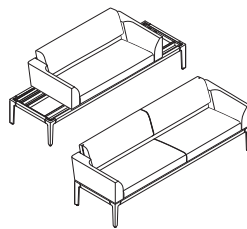

Lounge, 88" Frame Width

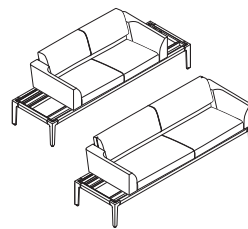

Lounge, 93 1/2" Frame Width

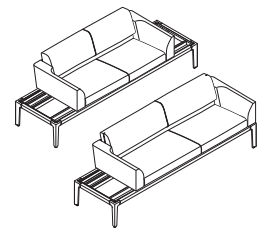

Lounge, 99" Frame Width

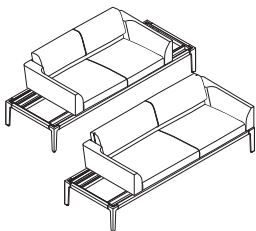

Lounge, 104 1/2" Frame Width

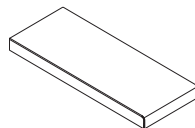

Storage, End Table

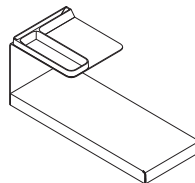

Storage, Two-Tier End Table

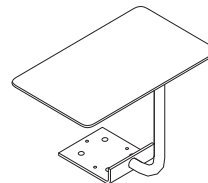

Mobile Tablet

X-tenz Sleeper Chairs

Specifying
▶ Pages 220–221

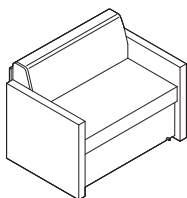

Single Sleeper Chair with Glides

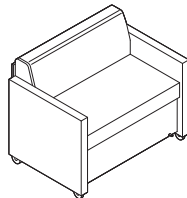

Single Sleeper Chair with Casters

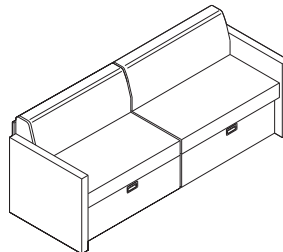

Double Sleeper Chair

Aspekt Straight Arm

SIN 711.17

Single-Seat Chair



Tip: Different fabrics for the seat and back can be specified. If the fabrics are in different price groups, calculate list price by adding the two price groups together and dividing by two.

Standard Includes	Required to Specify
-------------------	---------------------

- Seat and back: fabric
- Arm caps: plastic, maple wood, or solid surface
- Back style: convex
- Frame and legs: paint
- Glides: black nylon
- Ganging brackets, if selected: paint (ordered separately)

- 1 Style number
 - 2 Fabric color number for seat and back
 - 3 Plastic, wood, or solid surface color number for arm caps (see below under Required Selections)
 - 4 Leg style (see below under Required Selections)
 - 5 Paint color number for frame and legs
 - 6 Paint color number for ganging brackets, if selected
 - 7 Options, if selected (see below)
- ▶ See *Surface Materials*, page 402.

Required Selections	Price	Required to Specify
---------------------	-------	---------------------

Arm Caps	• Plastic	No cost	Specify <i>with plastic arm caps</i> and select plastic color number. Specify <i>with wood arm caps</i> and select wood color number. Specify <i>with solid surface arm caps</i> and select solid surface color number. Specify <i>with solid surface arm caps</i> and select solid surface color number. Specify <i>with solid surface arm caps</i> and select solid surface color number. Specify <i>with solid surface arm caps</i> and select solid surface color number.
	• Maple wood	No cost	
	• Solid surface price group A	+\$320	
	• Solid surface price group B	+\$344	
	• Solid surface price group C	+\$368	
	• Solid surface price group D	+\$392	

Leg Style	• Straight legs	No cost	Specify <i>with straight legs</i> . Specify <i>with wallsaver legs</i> .
	• Wallsaver legs	+\$ 30	

Options	Price	Required to Specify
---------	-------	---------------------

Surface Materials	• Moisture barrier	+\$ 96	Specify <i>with moisture barrier</i> .
Back Style	• Concave	No cost	Specify <i>with concave back</i> .

Specification Information

Base Prices

Style Number	Fabric Price Group 1	Fabric Price Group 2	Fabric Price Group 3	Fabric Price Group 4	Fabric Price Group 5	Fabric Price Group 6	Fabric Price Group 7	Fabric Price Group 8	Fabric Price Group 9	Fabric Price Group 10	COM
SC4210	\$711	\$769	\$815	\$861	\$903	\$937	\$979	\$1043	\$1127	\$1179	\$743

Related Product

Style Number	Price

Set of Ganging Brackets

SC4009	\$56
--------	------

Two-Seat Chairs



No Center Arm or Legs

Tip: Different fabrics for the seat and back can be specified. If the fabrics are in different price groups, calculate list price by adding the two price groups together and dividing by two.

Tip: Left and right is determined when facing the chair.

Standard Includes	Required to Specify
-------------------	---------------------

- Seat and back: fabric
- Arm caps: plastic, maple wood, or solid surface
- Back style: convex
- Frame and legs: paint
- Glides: black nylon
- Ganging brackets, if selected: paint (ordered separately)

- 1 Style number
 - 2 Fabric color number for seat and back
 - 3 Plastic, wood, or solid surface color number for arm caps (see below under Required Selections)
 - 4 Leg style (see below under Required Selections)
 - 5 Paint color number for frame and legs
 - 6 Paint color number for ganging brackets, if selected
 - 7 Options, if selected (see below)
- ▶ See *Surface Materials*, page 402.

Required Selections	Price	Required to Specify
---------------------	-------	---------------------

Arm Caps	• Plastic	No cost	Specify with <i>plastic arm caps</i> and select plastic color number.
	• Maple wood	No cost	Specify with <i>wood arm caps</i> and select wood color number.
	• Solid surface price group A	+\$160 per arm cap	Specify with <i>solid surface arm caps</i> and select solid surface color number.
	• Solid surface price group B	+\$172 per arm cap	Specify with <i>solid surface arm caps</i> and select solid surface color number.
	• Solid surface price group C	+\$184 per arm cap	Specify with <i>solid surface arm caps</i> and select solid surface color number.
	• Solid surface price group D	+\$196 per arm cap	Specify with <i>solid surface arm caps</i> and select solid surface color number.
Leg Style	• Straight legs	No cost	Specify with <i>straight legs</i> .
	• Wallsaver legs	+\$ 15 per back leg	Specify with <i>wallsaver legs</i> .

Options	Price	Required to Specify
---------	-------	---------------------

Surface Materials	• Moisture barrier	+\$192	Specify with <i>moisture barrier</i> .
Arms and Legs Configuration	• No center arm or legs	No cost	Specify with <i>no center arm or legs</i> .
	• Center arm	+\$104	Specify with <i>center arm</i> .
	• Center arm and center legs	+\$128	Specify with <i>center arm and legs</i> .
Back Style	• Concave	No cost	Specify with <i>concave back</i> .
	• Convex left, concave right	No cost	Specify with <i>convex left, concave right back</i> .
	• Concave left, convex right	No cost	Specify with <i>concave left, convex right back</i> .



Center Arm



Center Arm and Center Legs

Specification Information

• Style Number	Base Prices										• COM
	• Fabric Price Group 1	• Fabric Price Group 2	• Fabric Price Group 3	• Fabric Price Group 4	• Fabric Price Group 5	• Fabric Price Group 6	• Fabric Price Group 7	• Fabric Price Group 8	• Fabric Price Group 9	• Fabric Price Group 10	
SC4220	\$1129	\$1233	\$1345	\$1429	\$1511	\$1575	\$1659	\$1789	\$1961	\$2063	\$1161

Related Product

• Style Number	• Price

Set of Ganging Brackets

SC4009	\$56
---------------	------

Aspekt Straight Arm, continued

SIN 711.17

Three-Seat Chairs

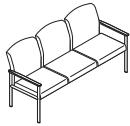

No Center Arms or Legs

Tip: Different fabrics for the seat and back can be specified. If the fabrics are in different price groups, calculate list price by adding the two price groups together and dividing by two.

Tip: Left and right is determined when facing the chair.

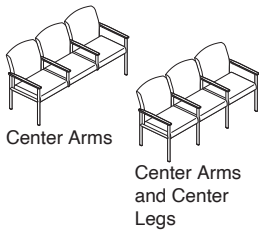

Center Arms

Center Arms and Center Legs

Standard Includes	Required to Specify
<ul style="list-style-type: none"> • Seat and back: fabric • Arm caps: plastic, maple wood, or solid surface • Back style: convex • Frame and legs: paint • Glides: black nylon • Ganging brackets, if selected: paint (ordered separately) 	<ol style="list-style-type: none"> 1 Style number 2 Fabric color number for seat and back 3 Plastic, wood, or solid surface color number for arm caps (see below under Required Selections) 4 Leg style (see below under Required Selections) 5 Paint color number for frame and legs 6 Paint color number for ganging brackets, if selected 7 Options, if selected (see below) <p>▶ See <i>Surface Materials</i>, page 402.</p>

Required Selections	Price	Required to Specify
Arm Caps		
• Plastic	No cost	Specify with <i>plastic arm caps</i> and select plastic color number.
• Maple wood	No cost	Specify with <i>wood arm caps</i> and select wood color number.
• Solid surface price group A	+\$160 per arm cap	Specify with <i>solid surface arm caps</i> and select solid surface color number.
• Solid surface price group B	+\$172 per arm cap	Specify with <i>solid surface arm caps</i> and select solid surface color number.
• Solid surface price group C	+\$184 per arm cap	Specify with <i>solid surface arm caps</i> and select solid surface color number.
• Solid surface price group D	+\$196 per arm cap	Specify with <i>solid surface arm caps</i> and select solid surface color number.
Leg Style		
• Straight legs	No cost	Specify with <i>straight legs</i> .
• Wallsaver legs	+\$ 15 per back leg	Specify with <i>wallsaver legs</i> .

Options	Price	Required to Specify
Surface Materials		
• Moisture barrier	+\$288	Specify with <i>moisture barrier</i> .
Arms and Legs Configuration		
• No center arms or legs	No cost	Specify with <i>no center arms or legs</i> .
• Center arms	+\$221	Specify with <i>center arms</i> .
• Center arms and center legs	+\$251	Specify with <i>center arms and legs</i> .
Back Style		
• Concave	No cost	Specify with <i>concave back</i> .
• Convex left, concave center, convex right	No cost	Specify with <i>convex left, concave center, convex right back</i> .
• Concave left, convex center concave right	No cost	Specify with <i>concave left, convex center, concave right back</i> .

Specification Information

Style Number	Base Prices										COM
	Fabric Price Group 1	Fabric Price Group 2	Fabric Price Group 3	Fabric Price Group 4	Fabric Price Group 5	Fabric Price Group 6	Fabric Price Group 7	Fabric Price Group 8	Fabric Price Group 9	Fabric Price Group 10	
SC4230	\$1540	\$1700	\$1858	\$1986	\$2118	\$2210	\$2342	\$2532	\$2784	\$2948	\$1572

Related Product

Style Number	Price

Set of Ganging Brackets

SC4009	\$56
--------	------

Bariatric Arm Chair

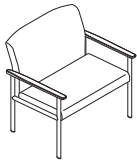

Tip: Bariatric chair is available with a convex back style only.

Tip: Different fabrics for the seat and back can be specified. If the fabrics are in different price groups, calculate list price by adding the two price groups together and dividing by two.

Standard Includes	Required to Specify
-------------------	---------------------

- Seat and back: fabric
- Arm caps: plastic, maple wood, or solid surface
- Back style: convex
- Frame and legs: paint
- Glides: black nylon
- Ganging brackets, if selected: paint (ordered separately)

- 1 Style number
 - 2 Fabric color number for seat and back
 - 3 Plastic, wood, or solid surface color number for arm caps (see below under Required Selections)
 - 4 Leg style (see below under Required Selections)
 - 5 Paint color number for frame and legs
 - 6 Paint color number for ganging brackets, if selected
 - 7 Options, if selected (see below)
- ▶ See *Surface Materials*, page 402.

	Required Selections	Price	Required to Specify
--	---------------------	-------	---------------------

Arm Caps	• Plastic	No cost	Specify with <i>plastic arm caps</i> and select plastic color number.
	• Maple wood	No cost	Specify with <i>wood arm caps</i> and select wood color number.
	• Solid surface price group A	+\$320	Specify with <i>solid surface arm caps</i> and select solid surface color number.
	• Solid surface price group B	+\$344	Specify with <i>solid surface arm caps</i> and select solid surface color number.
	• Solid surface price group C	+\$368	Specify with <i>solid surface arm caps</i> and select solid surface color number.
	• Solid surface price group D	+\$392	Specify with <i>solid surface arm caps</i> and select solid surface color number.

Leg Style	• Straight legs	No cost	Specify with <i>straight legs</i> .
	• Wallsaver legs	+\$ 30	Specify with <i>wallsaver legs</i> .

	Options	Price	Required to Specify
--	---------	-------	---------------------

Surface Materials	• Moisture barrier	+\$ 96	Specify with <i>moisture barrier</i> .
--------------------------	--------------------	--------	--

Specification Information

Style Number	Base Prices										COM
	Fabric Price	Fabric Price	Fabric Price	Fabric Price	Fabric Price	Fabric Price	Fabric Price	Fabric Price	Fabric Price	Fabric Price	
	Group 1	Group 2	Group 3	Group 4	Group 5	Group 6	Group 7	Group 8	Group 9	Group 10	
SC4260	\$969	\$1059	\$1145	\$1215	\$1287	\$1341	\$1413	\$1521	\$1661	\$1749	\$1001

Related Product

Style Number	Price

Set of Ganging Brackets

SC4009	\$56
---------------	------

Aspekt Straight Arm, continued

SIN 711.17

Bariatric Combination Units

Tip: Combination units are available with a convex back style only and include center arms and legs.

Tip: Left and right is determined when facing the chair.

Tip: Different fabrics for the seat and back can be specified. If the fabrics are in different price groups, calculate list price by adding the two price groups together and dividing by two.

Standard Includes	Required to Specify
-------------------	---------------------

- Seat and back: fabric
- Arm caps: plastic, maple wood, or solid surface
- Back style: convex
- Frame and legs: paint
- Glides: black nylon
- Ganging brackets, if selected: paint (ordered separately)

- 1 Style number
 - 2 Fabric color number for seat and back
 - 3 Plastic, wood, or solid surface color number for arm caps (see below under Required Selections)
 - 4 Leg style (see below under Required Selections)
 - 5 Bariatric seat location (see below under Required Selections)
 - 6 Paint color number for ganging brackets, if selected
 - 7 Options, if selected (see below)
- See *Surface Materials*, page 402.

Required Selections	Price	Required to Specify
---------------------	-------	---------------------

Arm Caps	• Plastic	No cost	Specify <i>with plastic arm caps</i> and select plastic color number.
	• Maple wood	No cost	Specify <i>with wood arm caps</i> and select wood color number.
	• Solid surface price group A	+\$160 per arm cap	Specify <i>with solid surface arm caps</i> and select solid surface color number.
	• Solid surface price group B	+\$172 per arm cap	Specify <i>with solid surface arm caps</i> and select solid surface color number.
	• Solid surface price group C	+\$184 per arm cap	Specify <i>with solid surface arm caps</i> and select solid surface color number.
	• Solid surface price group D	+\$196 per arm cap	Specify <i>with solid surface arm caps</i> and select solid surface color number.

Bariatric Seat Location	• Bariatric seat in left facing position	No cost	Specify <i>with bariatric seat left</i> .
	• Bariatric seat in right facing position	No cost	Specify <i>with bariatric seat right</i> .
	• Bariatric seat in center position (three-seat units only)	No cost	Specify <i>with bariatric seat center</i> .

Leg Style	• Straight legs	No cost	Specify <i>with straight legs</i> .
	• Wallsaver legs	+\$ 15 per back leg	Specify <i>with wallsaver legs</i> .

Options	Price	Required to Specify
---------	-------	---------------------

Surface Materials	Moisture barrier		
	• Two-seat combination units	+\$192	Specify <i>with moisture barrier</i> .
	• Three-seat combination units	+\$288	Specify <i>with moisture barrier</i> .

Specification Information

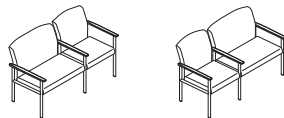

Base Prices

Style Number	Fabric Price Group 1	Fabric Price Group 2	Fabric Price Group 3	Fabric Price Group 4	Fabric Price Group 5	Fabric Price Group 6	Fabric Price Group 7	Fabric Price Group 8	Fabric Price Group 9	Fabric Price Group 10	COM

Two-Seat Combination Unit

SC4262	\$1515	\$1663	\$1795	\$1911	\$2025	\$2113	\$2227	\$2399	\$2623	\$2763	\$1547
---------------	--------	--------	--------	--------	--------	--------	--------	--------	--------	--------	--------

► **Specification Information, continued on next page**

► Specification Information, continued from previous page

Specification Information

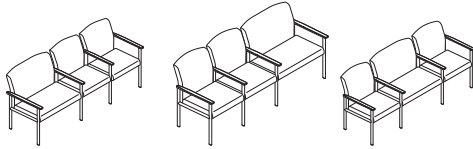

Base Prices

Style Number	Fabric Price Group 1	Fabric Price Group 2	Fabric Price Group 3	Fabric Price Group 4	Fabric Price Group 5	Fabric Price Group 6	Fabric Price Group 7	Fabric Price Group 8	Fabric Price Group 9	Fabric Price Group 10	COM
--------------	----------------------	----------------------	----------------------	----------------------	----------------------	----------------------	----------------------	----------------------	----------------------	-----------------------	-----

Three-Seat Combination Unit

SC4263	\$2049	\$2255	\$2433	\$2595	\$2751	\$2873	\$3029	\$3265	\$3573	\$3765	\$2081
---------------	--------	--------	--------	--------	--------	--------	--------	--------	--------	--------	--------

Seating

Aspekt Straight Arm, continued

SIN 711.17

High-Back Chair

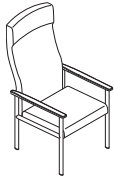

Tip: High-back chair is available with a convex back style only.

Tip: Different fabrics for the seat and back can be specified. If the fabrics are in different price groups, calculate list price by adding the two price groups together and dividing by two.

Standard Includes	Required to Specify
<ul style="list-style-type: none"> • Seat and back: fabric • Arm caps: plastic, maple wood, or solid surface • Back style: convex • Frame and legs: paint • Glides: black nylon • Ganging brackets, if selected: paint (ordered separately) 	<ol style="list-style-type: none"> 1 Style number 2 Fabric color number for seat and back 3 Plastic, wood, or solid surface color number for arm caps (see below under Required Selections) 4 Paint color number for frame and legs 5 Paint color number for ganging brackets, if selected 6 Options, if selected (see below) <p>▶ See <i>Surface Materials</i>, page 402.</p>

	Required Selections	Price	Required to Specify
Arm Caps	• Plastic	No cost	Specify <i>with plastic arm caps</i> and select plastic color number.
	• Maple wood	No cost	Specify <i>with wood arm caps</i> and select wood color number.
	• Solid surface price group A	+\$320	Specify <i>with solid surface arm caps</i> and select solid surface color number.
	• Solid surface price group B	+\$344	Specify <i>with solid surface arm caps</i> and select solid surface color number.
	• Solid surface price group C	+\$368	Specify <i>with solid surface arm caps</i> and select solid surface color number.
	• Solid surface price group D	+\$392	Specify <i>with solid surface arm caps</i> and select solid surface color number.

	Options	Price	Required to Specify
Surface Materials	• Moisture barrier	+\$ 96	Specify <i>with moisture barrier</i> .

Specification Information											
Base Prices											
Style Number	Fabric Price Group 1	Fabric Price Group 2	Fabric Price Group 3	Fabric Price Group 4	Fabric Price Group 5	Fabric Price Group 6	Fabric Price Group 7	Fabric Price Group 8	Fabric Price Group 9	Fabric Price Group 10	COM
SC4285	\$792	\$862	\$928	\$978	\$1032	\$1074	\$1126	\$1206	\$1312	\$1378	\$824

Easy Access Arm Chair



Tip: Easy access chair is available with a convex back style only.

Tip: Different fabrics for the seat and back can be specified. If the fabrics are in different price groups, calculate list price by adding the two price groups together and dividing by two.

Standard Includes	Required to Specify
-------------------	---------------------

- Seat and back: fabric
- Arm caps: plastic, maple wood, or solid surface
- Back style: convex
- Frame and legs: paint
- Glides: black nylon
- Ganging brackets, if selected: paint (ordered separately)

- 1 Style number
 - 2 Fabric color number for seat and back
 - 3 Plastic, wood, or solid surface color number for arm caps (see below under Required Selections)
 - 4 Leg style (see below under Required Selections)
 - 5 Paint color number for frame and legs
 - 6 Paint color number for ganging brackets, if selected
 - 7 Options, if selected (see below)
- ▶ See *Surface Materials*, page 402.

	Required Selections	Price	Required to Specify
--	---------------------	-------	---------------------

Arm Caps	• Plastic	No cost	Specify with <i>plastic arm caps</i> and select plastic color number.
	• Maple wood	No cost	Specify with <i>wood arm caps</i> and select wood color number.
	• Solid surface price group A	+\$320	Specify with <i>solid surface arm caps</i> and select solid surface color number.
	• Solid surface price group B	+\$344	Specify with <i>solid surface arm caps</i> and select solid surface color number.
	• Solid surface price group C	+\$368	Specify with <i>solid surface arm caps</i> and select solid surface color number.
	• Solid surface price group D	+\$392	Specify with <i>solid surface arm caps</i> and select solid surface color number.

Leg Style	• Straight legs	No cost	Specify with <i>straight legs</i> .
	• Wallsaver legs	+\$ 30	Specify with <i>wallsaver legs</i> .

	Options	Price	Required to Specify
--	---------	-------	---------------------

Surface Materials	• Moisture barrier	+\$ 96	Specify with <i>moisture barrier</i> .
--------------------------	--------------------	--------	--

Specification Information

Style Number	Base Prices										COM
	Fabric Price Group 1	Fabric Price Group 2	Fabric Price Group 3	Fabric Price Group 4	Fabric Price Group 5	Fabric Price Group 6	Fabric Price Group 7	Fabric Price Group 8	Fabric Price Group 9	Fabric Price Group 10	
	SC4207	\$796	\$854	\$900	\$946	\$988	\$1022	\$1064	\$1128	\$1212	

Aspekt Straight Arm, continued

SIN 711.17

Bench



Standard Includes	Required to Specify
<ul style="list-style-type: none"> • Seat: fabric • Frame and legs: paint • Glides: black nylon only 	<ol style="list-style-type: none"> 1 Style number 2 Fabric color number for seat 3 Paint color number for frame and legs 4 Options, if selected (see below) <p>▶ See <i>Surface Materials</i>, page 402.</p>

Options	Price	Required to Specify
Surface Materials <ul style="list-style-type: none"> • Moisture barrier 	+\$96	Specify <i>with moisture barrier</i> .

Specification Information											
Style Number	Base Prices										COM
	Fabric Price Group 1	Fabric Price Group 2	Fabric Price Group 3	Fabric Price Group 4	Fabric Price Group 5	Fabric Price Group 6	Fabric Price Group 7	Fabric Price Group 8	Fabric Price Group 9	Fabric Price Group 10	
SC4043	\$509	\$541	\$568	\$592	\$617	\$633	\$659	\$692	\$741	\$769	\$546

Footstool



Standard Includes	Required to Specify
<ul style="list-style-type: none"> • Cushion top: fabric • Frame and legs: paint • Glides: black nylon only 	<ul style="list-style-type: none"> 1 Style number 2 Fabric color number for cushion top 3 Paint color number for frame and legs 4 Options, if selected (see below) ▶ See <i>Surface Materials</i>, page 402.

Options	Price	Required to Specify
Surface Materials <ul style="list-style-type: none"> • Moisture barrier 	+\$96	Specify with moisture barrier.

Specification Information											
Style Number	Base Prices										COM
	Fabric Price Group 1	Fabric Price Group 2	Fabric Price Group 3	Fabric Price Group 4	Fabric Price Group 5	Fabric Price Group 6	Fabric Price Group 7	Fabric Price Group 8	Fabric Price Group 9	Fabric Price Group 10	
SC4045	\$321	\$340	\$357	\$370	\$386	\$397	\$410	\$433	\$461	\$477	\$358

Aspekt Wave Arm

SIN 711.17

Single-Seat Chairs

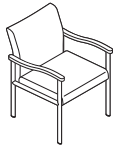

Tip: Different fabrics for the seat and back can be specified. If the fabrics are in different price groups, calculate list price by adding the two price groups together and dividing by two.

Standard Includes		Required to Specify	
<ul style="list-style-type: none"> • Seat and back: fabric • Arm caps: maple wood • Frame and legs: paint • Glides: black nylon only • Ganging brackets, if selected: paint (ordered separately) 		<ol style="list-style-type: none"> 1 Style number 2 Fabric color number for seat and back 3 Wood color number for arm caps 4 Leg style (see below under Required Selections) 5 Paint color number for frame and legs, if selected 6 Paint color number for ganging brackets, if selected 7 Options, if selected (see below) <p>▶ See <i>Surface Materials</i>, page 402.</p>	

	Required Selections	Price	Required to Specify
Arm Caps	• Plastisol	No cost	Specify with <i>plastisol arm caps</i> and select plastic color number.
	• Maple wood	No cost	Specify with <i>wood arm caps</i> and select wood color number.
Leg Style	• Straight legs	No cost	Specify with <i>straight legs</i> .
	• Wallsaver legs	+\$30	Specify with <i>wallsaver legs</i> .

	Options	Price	Required to Specify
Surface Materials	• Moisture barrier	+\$96	Specify with <i>moisture barrier</i> .
Back Style	• Concave	No cost	Specify with <i>concave back</i> .

Specification Information

Style Number	Base Prices										COM
	Fabric Price Group 1	Fabric Price Group 2	Fabric Price Group 3	Fabric Price Group 4	Fabric Price Group 5	Fabric Price Group 6	Fabric Price Group 7	Fabric Price Group 8	Fabric Price Group 9	Fabric Price Group 10	
SC4010	\$711	\$769	\$815	\$861	\$903	\$937	\$979	\$1043	\$1127	\$1179	\$743

Related Product

Style Number	Price

Set of Ganging Brackets

SC4009	\$56
--------	------

Two-Seat Chairs



No Center Arm or Legs

Standard Includes	Required to Specify
-------------------	---------------------

- Seat and back: fabric
- Arm caps: plastisol or maple wood
- Back style: convex
- Frame and legs: paint
- Glides: black nylon
- Ganging brackets, if selected: paint (ordered separately)

- 1 Style number
 - 2 Fabric color number for seat and back
 - 3 Plastic or wood color number for arm caps (see below under Required Selections)
 - 4 Leg style (see below under Required Selections)
 - 5 Paint color number for frame and legs
 - 6 Paint color number for ganging brackets, if selected
 - 7 Options, if selected (see below)
- ▶ See *Surface Materials*, page 402.

Tip: Different fabrics for the seat and back can be specified. If the fabrics are in different price groups, calculate list price by adding the two price groups together and dividing by two.

Tip: Left and right is determined when facing the chair.



Center Arm

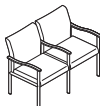

Center Arm and Center Legs

	Required Selections	Price	Required to Specify
--	---------------------	-------	---------------------

Arm Caps	• Plastisol	No cost	Specify with <i>plastisol arm caps</i> and select plastic color number. Specify with <i>wood arm caps</i> and select wood color number.
	• Maple wood	No cost	

Leg Style	• Straight legs	No cost	Specify with <i>straight legs</i> . Specify with <i>wallsaver legs</i> .
	• Wallsaver legs	+\$ 15 per back leg	

	Options	Price	Required to Specify
--	---------	-------	---------------------

Surface Materials	• Moisture barrier	+\$192	Specify with <i>moisture barrier</i> .
--------------------------	--------------------	--------	--

Arms and Legs Configuration	• No center arm or legs	No cost	Specify with <i>no center arm or legs</i> . Specify with <i>center arm</i> . Specify with <i>center arm and legs</i> .
	• Center arm	+\$104	
	• Center arm and center legs	+\$128	

Back Style	• Concave	No cost	Specify with <i>concave back</i> . Specify with <i>convex left, concave right back</i> . Specify with <i>concave left, convex right back</i> .
	• Convex left, concave right	No cost	
	• Concave left, convex right	No cost	

Specification Information

Base Prices

• Style Number	• Fabric Price										• COM
	• Group 1	• Group 2	• Group 3	• Group 4	• Group 5	• Group 6	• Group 7	• Group 8	• Group 9	• Group 10	
SC4020	\$1129	\$1233	\$1345	\$1429	\$1511	\$1575	\$1659	\$1789	\$1961	\$2063	\$1161

Related Product

• Style Number	• Price

Set of Ganging Brackets

SC4009	\$56
---------------	------

Aspekt Wave Arm, continued

SIN 711.17

Three-Seat Chairs

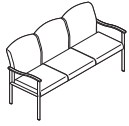

No Center Arms or Legs

Tip: Different fabrics for the seat and back can be specified. If the fabrics are in different price groups, calculate list price by adding the two price groups together and dividing by two.

Tip: Left and right is determined when facing the chair.

Tip: Wallsaver legs are not available with center arms only configuration.

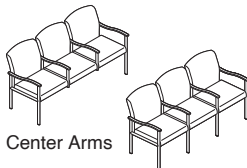

Center Arms

Center Arms and Center Legs

Standard Includes	Required to Specify
<ul style="list-style-type: none"> • Seat and back: fabric • Arm caps: plastisol or maple wood • Back style: convex • Frame and legs: paint • Glides: black nylon • Ganging brackets, if selected: paint (ordered separately) 	<ol style="list-style-type: none"> 1 Style number 2 Fabric color number for seat and back 3 Plastic or wood color number for arm caps (see below under Required Selections) 4 Leg style (see below under Required Selections) 5 Paint color number for frame and legs 6 Paint color number for ganging brackets, if selected 7 Options, if selected (see below) <p>▶ See <i>Surface Materials</i>, page 402.</p>

Required Selections	Price	Required to Specify
Arm Caps	<ul style="list-style-type: none"> • Plastisol • Maple wood 	No cost No cost Specify with <i>plastisol arm caps</i> and select plastic color number. Specify with <i>wood arm caps</i> and select wood color number.
Leg Style	<ul style="list-style-type: none"> • Straight legs • Wallsaver legs 	No cost +\$ 15 per back leg Specify with <i>straight legs</i> . Specify with <i>wallsaver legs</i> .

Options	Price	Required to Specify
Surface Materials	<ul style="list-style-type: none"> • Moisture barrier 	+\$288 Specify with <i>moisture barrier</i> .
Arms and Legs Configuration	<ul style="list-style-type: none"> • No center arms or legs • Center arms • Center arms and center legs 	No cost +\$221 +\$251 Specify with <i>no center arms or legs</i> . Specify with <i>center arms</i> . Specify with <i>center arms and legs</i> .
Back Style	<ul style="list-style-type: none"> • Concave • Convex left, concave center, convex right • Concave left, convex center concave right 	No cost No cost No cost Specify with <i>concave back</i> . Specify with <i>convex left, concave center, convex right back</i> . Specify with <i>concave left, convex center, concave right back</i> .

Specification Information

Style Number	Base Prices										COM
	Fabric Price Group 1	Fabric Price Group 2	Fabric Price Group 3	Fabric Price Group 4	Fabric Price Group 5	Fabric Price Group 6	Fabric Price Group 7	Fabric Price Group 8	Fabric Price Group 9	Fabric Price Group 10	
SC4030	\$1540	\$1700	\$1858	\$1986	\$2118	\$2210	\$2342	\$2532	\$2784	\$2948	\$1572

Related Product

Style Number	Price

Set of Ganging Brackets

SC4009	\$56
--------	------

Bariatric Arm Chair

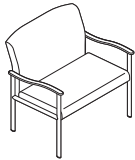

Tip: Bariatric chair is available with a convex back style only.

Tip: Different fabrics for the seat and back can be specified. If the fabrics are in different price groups, calculate list price by adding the two price groups together and dividing by two.

Standard Includes	Required to Specify
-------------------	---------------------

- Seat and back: fabric
- Arm caps: plastisol or maple wood
- Back style: convex
- Frame and legs: paint
- Glides: black nylon
- Ganging brackets, if selected: paint (ordered separately)

- 1 Style number
 - 2 Fabric color number for seat and back
 - 3 Plastic or wood color number for arm caps (see below under Required Selections)
 - 4 Leg style (see below under Required Selections)
 - 5 Paint color number for frame and legs
 - 6 Paint color number for ganging brackets, if selected
 - 7 Options, if selected (see below)
- ▶ See *Surface Materials*, page 402.

Required Selections	Price	Required to Specify
---------------------	-------	---------------------

Arm Caps	• Plastisol	No cost	Specify with <i>plastisol arm caps</i> and select plastic color number. Specify with <i>wood arm caps</i> and select wood color number.
	• Maple wood	No cost	
Leg Style	• Straight legs	No cost	Specify with <i>straight legs</i> . Specify with <i>wallsaver legs</i> .
	• Wallsaver legs	+\$30	

Options	Price	Required to Specify
---------	-------	---------------------

Surface Materials	• Moisture barrier	+\$96	Specify with <i>moisture barrier</i> .
--------------------------	--------------------	-------	--

Specification Information

• Style • Number	• Base Prices										• COM
	• Fabric • Price	• Fabric • Price	• Fabric • Price	• Fabric • Price	• Fabric • Price	• Fabric • Price	• Fabric • Price	• Fabric • Price	• Fabric • Price	• Fabric • Price	
	• Group 1	• Group 2	• Group 3	• Group 4	• Group 5	• Group 6	• Group 7	• Group 8	• Group 9	• Group 10	
SC4060	\$969	\$1059	\$1145	\$1215	\$1287	\$1341	\$1413	\$1521	\$1661	\$1749	\$1001

Related Product

• Style • Number	• Price

Set of Ganging Brackets

SC4009	\$56
---------------	------

Aspekt Wave Arm, continued

SIN 711.17

Bariatric Combination Units

Tip: Combination units are available with a convex back style only and include center arms and legs.

Tip: Left and right is determined when facing the chair.

Tip: Different fabrics for the seat and back can be specified. If the fabrics are in different price groups, calculate list price by adding the two price groups together and dividing by two.

Standard Includes	Required to Specify
<ul style="list-style-type: none"> • Seat and back: fabric • Arm caps: plastisol or maple wood • Back style: convex • Frame and legs: paint • Glides: black nylon • Ganging brackets, if selected: paint (ordered separately) 	<ol style="list-style-type: none"> 1 Style number 2 Fabric color number for seat and back 3 Plastic or wood color number for arm caps (see below under Required Selections) 4 Leg style (see below under Required Selections) 5 Bariatric seat location (see below under Required Selections) 6 Paint color number for frame and legs 7 Paint color number for ganging brackets, if selected 8 Options, if selected (see below) <p>▶ See <i>Surface Materials</i>, page 402.</p>

	Required Selections	Price	Required to Specify
Arm Caps	• Plastisol	No cost	Specify with <i>plastisol arm caps</i> and select plastic color number.
	• Maple wood	No cost	Specify with <i>wood caps</i> and select wood color number.
Bariatric Seat Location	• Bariatric seat in left facing position	No cost	Specify with <i>bariatric seat left</i> .
	• Bariatric seat in right facing position	No cost	Specify with <i>bariatric seat right</i> .
	• Bariatric seat in center position (three-seat units only)	No cost	Specify with <i>bariatric seat center</i> .
Leg Style	• Straight legs	No cost	Specify with <i>straight legs</i> .
	• Wallsaver legs	+\$ 15 per back leg	Specify with <i>wallsaver legs</i> .

	Options	Price	Required to Specify
Surface Materials	Moisture barrier		
	• Two-seat combination units	+\$192	Specify with <i>moisture barrier</i> .
	• Three-seat combination units	+\$288	Specify with <i>moisture barrier</i> .

Specification Information

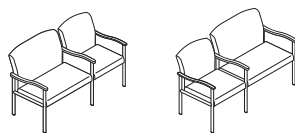

• Style Number	• Base Prices										• COM
	• Fabric Price	• Fabric Price	• Fabric Price	• Fabric Price	• Fabric Price	• Fabric Price	• Fabric Price	• Fabric Price	• Fabric Price	• Fabric Price	
	• Group 1	• Group 2	• Group 3	• Group 4	• Group 5	• Group 6	• Group 7	• Group 8	• Group 9	• Group 10	

Two-Seat Combination Unit

SC4062	\$1515	\$1663	\$1795	\$1911	\$2025	\$2113	\$2227	\$2399	\$2623	\$2763	\$1547
---------------	--------	--------	--------	--------	--------	--------	--------	--------	--------	--------	--------

▶ **Specification Information, continued on next page**

► Specification Information, continued from previous page

Specification Information

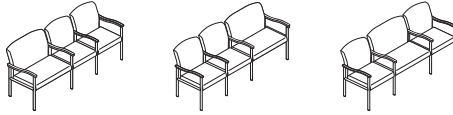

Base Prices

Style Number	Fabric Price Group 1	Fabric Price Group 2	Fabric Price Group 3	Fabric Price Group 4	Fabric Price Group 5	Fabric Price Group 6	Fabric Price Group 7	Fabric Price Group 8	Fabric Price Group 9	Fabric Price Group 10	COM
--------------	----------------------	----------------------	----------------------	----------------------	----------------------	----------------------	----------------------	----------------------	----------------------	-----------------------	-----

Three-Seat Combination Unit

SC4063	\$2049	\$2255	\$2433	\$2595	\$2751	\$2873	\$3029	\$3265	\$3573	\$3765	\$2081
---------------	--------	--------	--------	--------	--------	--------	--------	--------	--------	--------	--------

Aspekt Wave Arm, continued

SIN 711.17

High-Back Chair

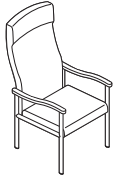

Tip: High-back chair is available with a convex back style only.

Tip: Different fabrics for the seat and back can be specified. If the fabrics are in different price groups, calculate list price by adding the two price groups together and dividing by two.

Standard Includes	Required to Specify
-------------------	---------------------

- Seat and back: fabric
- Arm caps: plastisol or maple wood
- Back style: convex
- Frame and legs: paint
- Glides: black nylon
- Ganging brackets, if selected: paint (ordered separately)

- 1 Style number
 - 2 Fabric color number for seat and back
 - 3 Plastic or wood color number for arm caps (see below under Required Selections)
 - 4 Paint color number for frame and leg
 - 5 Paint color number for ganging brackets, if selected
 - 6 Options, if selected (see below)
- ▶ See *Surface Materials*, page 402.

	Required Selections	Price	Required to Specify
--	---------------------	-------	---------------------

Arm Caps

- Plastisol No cost
- Maple wood No cost

Specify with *plastisol arm caps* and select plastic color number.
Specify with *wood arm caps* and select wood color number.

	Options	Price	Required to Specify
--	---------	-------	---------------------

Surface Materials

- Moisture barrier +\$96

Specify with *moisture barrier*.

Specification Information

Style Number	Base Prices										COM
	Fabric Price Group 1	Fabric Price Group 2	Fabric Price Group 3	Fabric Price Group 4	Fabric Price Group 5	Fabric Price Group 6	Fabric Price Group 7	Fabric Price Group 8	Fabric Price Group 9	Fabric Price Group 10	
	Price	Price	Price	Price	Price	Price	Price	Price	Price	Price	
SC4085	\$792	\$862	\$928	\$978	\$1032	\$1074	\$1126	\$1206	\$1312	\$1378	\$824

Easy Access Arm Chair



Tip: Easy access chair is available with a convex back style only.

Tip: Different fabrics for the seat and back can be specified. If the fabrics are in different price groups, calculate list price by adding the two price groups together and dividing by two.

Standard Includes	Required to Specify
-------------------	---------------------

- Seat and back: fabric
- Arm caps: plastisol or maple wood
- Back style: convex
- Frame and legs: paint
- Glides: black nylon
- Ganging brackets, if selected: paint (ordered separately)

- 1 Style number
 - 2 Fabric color number for seat and back
 - 3 Plastic or wood color number for arm caps (see below under Required Selections)
 - 4 Leg style (see below under Required Selections)
 - 5 Paint color number for frame and leg
 - 6 Paint color number for ganging brackets, if selected
 - 7 Options, if selected (see below)
- ▶ See *Surface Materials*, page 402.

	Required Selections	Price	Required to Specify
--	---------------------	-------	---------------------

Arm Caps	• Plastisol	No cost	Specify with <i>plastisol arm caps</i> and select plastic color number. Specify with <i>wood arm caps</i> and select wood color number.
	• Maple wood	No cost	

Leg Style	• Straight legs	No cost	Specify with <i>straight legs</i> . Specify with <i>wallsaver legs</i> .
	• Wallsaver legs	+\$30	

	Options	Price	Required to Specify
--	---------	-------	---------------------

Surface Materials	• Moisture barrier	+\$96	Specify with <i>moisture barrier</i> .
--------------------------	--------------------	-------	--

Specification Information

Style Number	Base Prices										COM
	Fabric Price	Fabric Price	Fabric Price	Fabric Price	Fabric Price	Fabric Price	Fabric Price	Fabric Price	Fabric Price	Fabric Price	
	Group 1	Group 2	Group 3	Group 4	Group 5	Group 6	Group 7	Group 8	Group 9	Group 10	
SC4007	\$796	\$854	\$900	\$946	\$988	\$1022	\$1064	\$1128	\$1212	\$1264	\$828

Aspekt Wave Arm, continued

SIN 711.17

Bench



Standard Includes	Required to Specify
-------------------	---------------------

- | | |
|---|--|
| <ul style="list-style-type: none"> • Seat: fabric • Frame and legs: paint • Glides: black nylon only | <ul style="list-style-type: none"> 1 Style number 2 Fabric color number for seat 3 Paint color number for frame and legs 4 Options, if selected (see below) ▶ See <i>Surface Materials</i>, page 402. |
|---|--|

Options	Price	Required to Specify
---------	-------	---------------------

Surface Materials	• Moisture barrier	+\$96 Specify with moisture barrier.
--------------------------	--------------------	---

Specification Information

Base Prices											
Style Number	Fabric Price Group 1	Fabric Price Group 2	Fabric Price Group 3	Fabric Price Group 4	Fabric Price Group 5	Fabric Price Group 6	Fabric Price Group 7	Fabric Price Group 8	Fabric Price Group 9	Fabric Price Group 10	COM
SC4043	\$509	\$541	\$568	\$592	\$617	\$633	\$659	\$692	\$741	\$769	\$546

Footstool



Standard Includes	Required to Specify
<ul style="list-style-type: none"> Cushion top: fabric Frame and legs: paint Glides: black nylon only 	<ul style="list-style-type: none"> 1 Style number 2 Fabric color number for cushion top 3 Paint color number for frame and legs 4 Options, if selected (see below) ▶ See <i>Surface Materials</i>, page 402.

Options	Price	Required to Specify
Surface Materials <ul style="list-style-type: none"> Moisture barrier 	+\$96	Specify with <i>moisture barrier</i> .

Specification Information

Style Number	Base Prices										COM
	Fabric Price Group 1	Fabric Price Group 2	Fabric Price Group 3	Fabric Price Group 4	Fabric Price Group 5	Fabric Price Group 6	Fabric Price Group 7	Fabric Price Group 8	Fabric Price Group 9	Fabric Price Group 10	
SC4045	\$321	\$340	\$357	\$370	\$386	\$397	\$410	\$433	\$461	\$477	\$358

Aspekt Ganging Tables

SIN 711.17

Tip: Ganging tables are compatible with chairs built after March 1, 2009.

Standard Includes	Required to Specify
<ul style="list-style-type: none"> Table top: High-Pressure Laminate with 3 mm plastic edge Ganging brackets: paint Leg on end table, 90° table, and corner table: paint Glides: black nylon only 	<ul style="list-style-type: none"> 1 Style number 2 Laminate color number for top 3 Paint color number for bracket and legs, if selected ▶ See <i>Surface Materials</i>, page 402.

Specification Information

Dimensions			Style Number	Price
D	W	H		

Inline Table

21¾"	20¼"	16"	SC4050	\$416
:	:	:	:	:

End Tables

Left-Hand Table

21¾"	16"	16"	SC4051L	\$547
:	:	:	:	:

Right-Hand Table

21¾"	16"	16"	SC4051R	\$547
:	:	:	:	:

90° Table

29¾"	29¾"	16"	SC4054	\$522
:	:	:	:	:

Corner Table

29¾"	29¾"	16"	SC4053	\$522
:	:	:	:	:

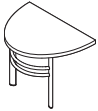
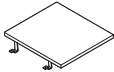

Aspekt Freestanding Tables

SIN 711.17

Standard Includes	Required to Specify
<ul style="list-style-type: none"> • Table top: High-Pressure Laminate with 3 mm plastic edge • Legs: paint • Glides: black nylon only 	<ul style="list-style-type: none"> 1 Style number 2 Laminate color number for top 3 Paint color number for legs ▶ See <i>Surface Materials</i>, page 402.

Specification Information

• Dimensions			• Style	• Price
D	W	H	Number	
:	:	:	:	:

Oval Table

22"	32"	16"	SC4055	\$688
:	:	:	:	:

Bow Table

18"	20"	21"	SC4057	\$611
:	:	:	:	:

Round Table

22" dia.		21"	SC4058	\$661
:	:	:	:	:

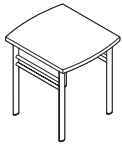

Cura

SIN 711.17/711.18

Chairs and Ottoman

Tip: Left and right determined when facing the chair.

Standard Includes	Required to Specify
-------------------	---------------------

- | | |
|--|---|
| <ul style="list-style-type: none"> • Frame: paint • Back: CuraNet mesh • Seat: mesh, fabric, or Promessa • Headrest: Promessa • Arm caps: Urethane in Sterling Dark Finish • Glides: stainless steel | <ul style="list-style-type: none"> 1 Style number 2 Paint color for frame 3 CuraNet color for back 4 Mesh, fabric, or Promessa color number for seat 5 Promessa color number for headrest 6 Options, if selected (see below) ▶ See <i>Surface Materials</i>, page 402. |
|--|---|

Options	Price	Required to Specify
---------	-------	---------------------

Surface Materials	Arm caps • Wood arm caps	+\$124	Specify <i>with wood arm caps</i> and select wood color.
Tablet arm	• Tablet arm	+\$272	Specify <i>with tablet</i> and indicate left or right facing.
Plastic glides	• Plastic glides	No cost	Specify <i>with plastic glides</i> .

Specification Information

Base Prices												
Style Number	Width	Fabric Price Group 1	Fabric Price Group 2	Fabric Price Group 3	Fabric Price Group 4	Fabric Price Group 5	Fabric Price Group 6	Fabric Price Group 7	Fabric Price Group 8	Fabric Price Group 9	Fabric Price Group 10	COM



Mid-Back, Sled-Base Chairs

CuraNet Seat

HN2305MM	21"	\$1562
HN2305EMM	24"	\$1622

Promessa Seat

HN2315ML	21"	\$1679
HN2315EML	24"	\$1736

Upholstered Seat

HN2315MU	21"	\$1540	\$1585	\$1629	\$1664	\$1700	\$1726	\$1762	\$1817	\$1887	\$1930	\$1599
HN2315EMU	24"	\$1597	\$1648	\$1703	\$1745	\$1783	\$1814	\$1857	\$1919	\$2002	\$2053	\$1656



High-Back, Sled-Base Chairs

CuraNet Seat

HN2306MM	21"	\$1632
HN2306EMM	24"	\$1690

Promessa Seat

HN2316ML	21"	\$1750
HN2316EML	24"	\$1807

Upholstered Seat

HN2316MU	21"	\$1609	\$1654	\$1698	\$1733	\$1769	\$1795	\$1831	\$1886	\$1956	\$1999	\$1668
-----------------	-----	--------	--------	--------	--------	--------	--------	--------	--------	--------	--------	--------

▶ **Specification Information, continued on next page**

► Specification Information, continued from previous page

Specification Information

Style Number	Width	Base Prices										COM
		Fabric Price	Fabric Price	Fabric Price	Fabric Price	Fabric Price	Fabric Price	Fabric Price	Fabric Price	Fabric Price	Fabric Price	
		Group 1	Group 2	Group 3	Group 4	Group 5	Group 6	Group 7	Group 8	Group 9	Group 10	



Mid-Back, Four-Leg Base Chairs

CuraNet Seat

HN2300MM 21" \$1388

HN2300EMM 24" \$1446

Promessa Seat

HN2310ML 21" \$1506

HN2310EML 24" \$1562

Upholstered Seat

HN2310MU 21" \$1366 \$1411 \$1455 \$1490 \$1526 \$1552 \$1588 \$1643 \$1713 \$1756 \$1425

HN2310EMU 24" \$1423 \$1474 \$1529 \$1571 \$1609 \$1640 \$1683 \$1745 \$1828 \$1879 \$1482



High-Back, Four-Leg Base Chairs

CuraNet Seat

HN2301MM 21" \$1457

HN2301EMM 24" \$1516

Promessa Seat

HN2311ML 21" \$1573

HN2311EML 24" \$1632

Upholstered Seat

HN2311MU 21" \$1435 \$1480 \$1524 \$1559 \$1595 \$1621 \$1657 \$1712 \$1782 \$1825 \$1494

HN2311EMU 24" \$1492 \$1543 \$1598 \$1640 \$1678 \$1709 \$1752 \$1814 \$1897 \$1948 \$1551



Ottoman

Promessa Seat

HN2305HL 16" \$ 810

Upholstered Seat

HN2305HS 16" \$ 694 \$ 726 \$ 753 \$ 777 \$ 802 \$ 818 \$ 844 \$ 877 \$ 926 \$ 954 \$ 753

Embold

SIN 711.16

Single Seat



Tip: Only one back color scheme can be chosen.
 ▶ For more information on the different color schemes, see Steelcase Health Volume 1 Seating Specification Guide

Tip: Fabrics with a repeating pattern will not remain aligned around the corners of the chair or in the boxing (the outer perimeter).

Tip: Wood chair frame and wood arm caps must be specified in the same finish.

Tip: Overhang arm is suggested for clinical applications to aid in user ingress and egress.

Standard Includes	Required to Specify
-------------------	---------------------

- Seat and back: fabric price group 1
- Plastic arm caps with overhang: 6527 Merle
- Frame finish: solid maple wood or paint
- Glides: standard adjustable, if selected: 6205 Black plastic or wallsaver, if selected: 6527 Merle plastic
- Bracket and cover, if high back selected: paint
- Flexing back

- 1 Style number
 - 2 Back color scheme (see below under Required Selections)
 - 3 Wallsaver or standard adjustable glides (see below under Required Selections)
 - 4 Fabric color number for seat and back
 - 5 Wood or paint color number for frame
 - 6 Paint color number for bracket and cover finish, if high back selected
 - 7 Options, if selected (see below)
- ▶ See *Surface Materials*, page 402.

Required Selections	Price	Required to Specify
---------------------	-------	---------------------

Back Color Scheme

- Monolithic
Prices at right
- Contrasting inner back/ outer back
Prices at right
- Contrasting upper back/ lower back
Prices at right

- Specify with *monolithic back*.
- Specify with *contrasting inner/outer back*.
- Specify with *contrasting upper/lower back*.

Glides

- Standard glides
No cost
- Wallsaver glides
No cost

- Specify with *standard adjustable glides*.
- Specify with *wallsaver glides*.

Options	Price	Required to Specify
---------	-------	---------------------

Surface Materials

Frame

- Solid maple wood
No cost
- Paint
No cost

- Select wood color number.
- Select paint color number.

Arm caps with no overhang

- Plastic
No cost
- Solid maple wood
+\$ 25 per arm
- Solid surface price group A
+\$227 per cap
- Solid surface price group B
+\$239 per cap
- Solid surface price group C
+\$251 per cap
- Solid surface price group D
+\$263 per cap

- Specify with *no arm cap overhang* and select plastic color number.
- Specify with *no arm cap overhang* and select wood color number.
- Specify with *no arm cap overhang* and select solid surface color number.
- Specify with *no arm cap overhang* and select solid surface color number.
- Specify with *no arm cap overhang* and select solid surface color number.
- Specify with *no arm cap overhang* and select solid surface color number.

Arm caps with overhang

- Plastic
No cost
- Solid maple wood
+\$ 53 per arm
- Solid surface price group A
+\$260 per cap
- Solid surface price group B
+\$272 per cap
- Solid surface price group C
+\$284 per cap
- Solid surface price group D
+\$296 per cap

- Specify with *arm cap overhang* and select plastic color number.
- Specify with *arm cap overhang* and select wood color number.
- Specify with *arm cap overhang* and select solid surface color number.
- Specify with *arm cap overhang* and select solid surface color number.
- Specify with *arm cap overhang* and select solid surface color number.
- Specify with *arm cap overhang* and select solid surface color number.

Moisture barrier on seat

- No moisture barrier
No cost
- Moisture barrier
+\$ 99

- Specify with *no moisture barrier*.
- Specify with *moisture barrier*.

▶ Options, continued on next page

► Options, continued from previous page

Tip: If monolithic or contrasting upper/lower upholstery is selected, then the high back will be specifiable in only one upholstery. If inner/outer contrasting upholstery is selected, then the upholstery selected on the chair back will be applied to the inner and outer high back.

Options	Price	Required to Specify
Surface Materials, continued	High back upholstery for 21"W single seat	
• Fabric price group 1	No cost	Specify fabric color number.
• Fabric price group 2	+\$ 6	Specify fabric color number.
• Fabric price group 3	+\$ 36	Specify fabric color number.
• Fabric price group 4	+\$ 79	Specify fabric color number.
• Fabric price group 5	+\$134	Specify fabric color number.
• Fabric price group 6	+\$196	Specify fabric color number.
• Fabric price group 7	+\$271	Specify fabric color number.
• Fabric price group 8	+\$371	Specify fabric color number.
• Fabric price group 9	+\$487	Specify fabric color number.
• Fabric price group 10	+\$617	Specify fabric color number.
• Customer's Own Material (COM)	+\$ 17	► See <i>Surface Materials Reference Manual</i> .
	High back upholstery for 32"W single seat	
• Fabric price group 1	No cost	Specify fabric color number.
• Fabric price group 2	+\$ 8	Specify fabric color number.
• Fabric price group 3	+\$ 27	Specify fabric color number.
• Fabric price group 4	+\$ 59	Specify fabric color number.
• Fabric price group 5	+\$ 111	Specify fabric color number.
• Fabric price group 6	+\$187	Specify fabric color number.
• Fabric price group 7	+\$292	Specify fabric color number.
• Fabric price group 8	+\$427	Specify fabric color number.
• Fabric price group 9	+\$589	Specify fabric color number.
• Fabric price group 10	+\$779	Specify fabric color number.
• Customer's Own Material (COM)	+\$ 17	► See <i>Surface Materials Reference Manual</i> .
High Back	High back for 21"W single seat	
	• No high back	Specify <i>without high back</i> .
	• With high back	Specify <i>with high back</i> .
	High back for 32"W single seat	
	• No high back	Specify <i>without high back</i> .
	• With high back	Specify <i>with high back</i> .
Related Products	• Multiple seat	► Page 68
	• Circular table	► Page 76
	• Rounded rectangle table	► Page 76
	• Racetrack table	► Page 76

Tip: High back is only available on 21"W and 32"W seats.

Specification Information													
Style Number	Base Price	Fabric Upcharges	Fabric Price Group 2	Fabric Price Group 3	Fabric Price Group 4	Fabric Price Group 5	Fabric Price Group 6	Fabric Price Group 7	Fabric Price Group 8	Fabric Price Group 9	Fabric Price Group 10	COM	



Tip: If a separate price grade is desired for upper back, lower back, inner back, or outer back for the contrasting back color schemes, divide the fabric upcharge in half to get the price of one back location in that price grade.

Tip: When specifying upper back and lower back or inner back and outer back, you may specify a different fabric color number for each surface separately. For example, one upholstery grade on the upper back and a different upholstery grade on the lower back.

21"W Single Seat

HSBS21	\$1044	Seat	+\$22	+\$44	+\$ 63	+\$ 80	+\$ 92	+\$111	+\$148	+\$170	+\$191	+\$10
		Monolithic back, if selected	+\$40	+\$80	+\$112	+\$146	+\$166	+\$198	+\$264	+\$306	+\$344	+\$24
		Upper back and lower back, if selected	+\$40	+\$80	+\$112	+\$146	+\$166	+\$198	+\$264	+\$306	+\$344	+\$24
		Inner back and outer back, if selected	+\$40	+\$80	+\$112	+\$146	+\$166	+\$198	+\$264	+\$306	+\$344	+\$24

► Specification Information, continued on next page

Embold, continued

SIN 711.16

► Specification Information, continued from previous page

Specification Information

Style Number	Base Price	Fabric Upcharges	Fabric Price Group 2	Fabric Price Group 3	Fabric Price Group 4	Fabric Price Group 5	Fabric Price Group 6	Fabric Price Group 7	Fabric Price Group 8	Fabric Price Group 9	Fabric Price Group 10	COM
--------------	------------	------------------	----------------------	----------------------	----------------------	----------------------	----------------------	----------------------	----------------------	----------------------	-----------------------	-----

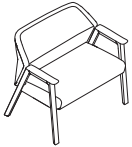

Tip: If a separate price grade is desired for upper back, lower back, inner back, or outer back for the contrasting back color schemes, divide the fabric upcharge in half to get the price of one back location in that price grade.

Tip: When specifying upper back and lower back or inner back and outer back, you may specify a different fabric color number for each surface separately. For example, one upholstery grade on the upper back and a different upholstery grade on the lower back.

24"W Midsize Single Seat

HSBS24	\$1082	Seat	+\$34	+\$ 59	+\$ 93	+\$134	+\$165	+\$207	+\$258	+\$325	+\$387	+\$10
		Monolithic back, if selected	+\$64	+\$106	+\$168	+\$240	+\$296	+\$370	+\$464	+\$580	+\$692	+\$24
		Upper back and lower back, if selected	+\$64	+\$106	+\$168	+\$240	+\$296	+\$370	+\$464	+\$580	+\$692	+\$24
		Inner back and outer back, if selected	+\$64	+\$106	+\$168	+\$240	+\$296	+\$370	+\$464	+\$580	+\$692	+\$24

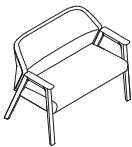

Tip: If a separate price grade is desired for upper back, lower back, inner back, or outer back for the contrasting back color schemes, divide the fabric upcharge in half to get the price of one back location in that price grade.

Tip: When specifying upper back and lower back or inner back and outer back, you may specify a different fabric color number for each surface separately. For example, one upholstery grade on the upper back and a different upholstery grade on the lower back.

32"W Bariatric Single Seat

HSBB32	\$1272	Seat	+\$40	+\$ 81	+\$115	+\$149	+\$170	+\$215	+\$277	+\$333	+\$391	+\$10
		Monolithic back, if selected	+\$72	+\$144	+\$206	+\$266	+\$302	+\$386	+\$496	+\$592	+\$696	+\$24
		Upper back and lower back, if selected	+\$72	+\$144	+\$206	+\$266	+\$302	+\$386	+\$496	+\$592	+\$696	+\$24
		Inner back and outer back, if selected	+\$72	+\$144	+\$206	+\$266	+\$302	+\$386	+\$496	+\$592	+\$696	+\$24

SIN 711.16

Loveseat

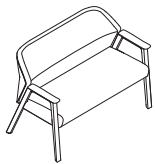

Tip: Fabrics with a repeating pattern will not remain aligned around the corners of the chair or in the boxing (the outer perimeter).

Tip: Only one back color scheme can be chosen. For more information on the different color schemes, see Steelcase Health Volume 1 Seating Specification Guide

Tip: Wood chair frame and wood arm caps must be specified in the same finish.

Tip: Overhang arm is suggested for clinical applications to aid in user ingress and egress.

Standard Includes	Required to Specify
-------------------	---------------------

- Seat and back: fabric price group 1
- Plastic arm caps with overhang: 6527 Merle
- Frame finish: solid maple wood or paint
- Glides: standard adjustable, if selected: 6205 Black plastic or wallsaver, if selected: 6527 Merle plastic
- Midarm, if selected: fabric price group 1

- 1 Style number
 - 2 Back color scheme (see below under Required Selections)
 - 3 Wallsaver or standard glides (see below for Required Selections)
 - 4 Fabric color number for seat and back
 - 5 Fabric color number for midarm, if selected
 - 6 Wood or paint color number for frame
 - 7 Options, if selected (see below)
- See *Surface Materials*, page 402.

Required Selections	Price	Required to Specify
---------------------	-------	---------------------

Back Color Scheme

- Monolithic
Prices at right
- Contrasting inner back/outer back
Prices at right
- Contrasting upper back/lower back
Prices at right

Specify with *monolithic back*.
Specify with *contrasting inner/outer back*.
Specify with *contrasting upper/lower back*.

Glides

- Standard glides
No cost
- Wallsaver glides
No cost

Specify with *standard adjustable glides*.
Specify with *wallsaver glides*.

Options	Price	Required to Specify
---------	-------	---------------------

Surface Materials

- Frame**
- Solid maple wood
No cost
 - Paint
No cost

Select wood color number.
Select paint color number.

Arm caps with no overhang

- Plastic
No cost
- Solid maple wood
+\$ 25 per arm
- Solid surface price group A
+\$227 per cap
- Solid surface price group B
+\$239 per cap
- Solid surface price group C
+\$251 per cap
- Solid surface price group D
+\$263 per cap

Specify with *no arm cap overhang* and select plastic color number.
Specify with *no arm cap overhang* and select wood color number.
Specify with *no arm cap overhang* and select solid surface color number.
Specify with *no arm cap overhang* and select solid surface color number.
Specify with *no arm cap overhang* and select solid surface color number.
Specify with *no arm cap overhang* and select solid surface color number.

Arm caps with overhang

- Plastic
No cost
- Solid maple wood
+\$ 53 per arm
- Solid surface price group A
+\$260 per cap
- Solid surface price group B
+\$272 per cap
- Solid surface price group C
+\$284 per cap
- Solid surface price group D
+\$296 per cap

Specify with *arm cap overhang* and select plastic color number.
Specify with *arm cap overhang* and select wood color number.
Specify with *arm cap overhang* and select solid surface color number.
Specify with *arm cap overhang* and select solid surface color number.
Specify with *arm cap overhang* and select solid surface color number.
Specify with *arm cap overhang* and select solid surface color number.

Moisture barrier on seat

- No moisture barrier
No cost
- Moisture barrier
+\$198

Specify with *no moisture barrier*.
Specify with *moisture barrier*.

► Options, continued on next page

► Options, continued from previous page

Tip: Midarms will include support plates when needed for configurations.

Options	Price	Required to Specify
Surface Materials, continued		
Midarm position		
• No midarm	No cost	Specify with <i>no midarm</i> .
• Midarm center	+\$248	Specify with <i>midarm center</i> .
Midleg position		
• No midleg	No cost	Specify with <i>no midleg</i> .
• Midleg center	+\$140	Specify with <i>midleg center</i> .

Tip: If monolithic or contrasting upper/lower upholstery is selected, then the high back will be specifiable in only one upholstery. If inner/outer contrasting upholstery is selected, then the upholstery will match the inner/outer contrasting upholstery selected on the chair back will be applied to the inner and outer high back.

Related Products	<ul style="list-style-type: none"> • Multiple seat • Circular table • Rounded rectangle table • Racetrack table 	<ul style="list-style-type: none"> ► Page 68 ► Page 76 ► Page 76 ► Page 76
-------------------------	---	--

Specification Information												
Style Number	Base Price	Fabric Upcharges	Fabric Price Group 2	Fabric Price Group 3	Fabric Price Group 4	Fabric Price Group 5	Fabric Price Group 6	Fabric Price Group 7	Fabric Price Group 8	Fabric Price Group 9	Fabric Price Group 10	COM

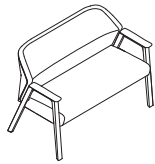

Tip: If a separate price grade is desired for upper back, lower back, inner back, or outer back for the contrasting back color schemes, divide the fabric upcharge in half to get the price of one back location in that price grade.

Tip: When specifying upper back and lower back or inner back and outer back, you may specify a different fabric color number for each surface separately. For example, one upholstery grade on the upper back and a different upholstery grade on the lower back.

43"W Loveseat

HSBL43	\$1721	Seat	+\$45	+\$ 90	+\$127	+\$163	+\$186	+\$224	+\$297	+\$344	+\$395	+\$24
		Monolithic back, if selected	+\$78	+\$158	+\$224	+\$292	+\$330	+\$396	+\$530	+\$612	+\$698	+\$40
		Upper back and lower back, if selected	+\$78	+\$158	+\$224	+\$292	+\$330	+\$396	+\$530	+\$612	+\$698	+\$40
		Inner back and outer back, if selected	+\$78	+\$158	+\$224	+\$292	+\$330	+\$396	+\$530	+\$612	+\$698	+\$40
		Midarm, if selected	+\$ 6	+\$ 20	+\$ 44	+\$ 83	+\$141	+\$216	+\$317	+\$432	+\$576	+\$17

SIN 711.16

Multiple Seat

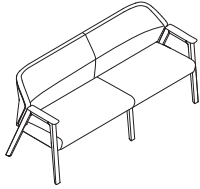

Tip: Fabrics with a repeating pattern will not remain aligned around the corners of the chair or in the boxing (the outer perimeter).

Tip: Only one back color scheme can be chosen.
 ▶ For more information on the different color schemes, see Steelcase Health Volume 1 Seating Specification Guide

Tip: Back and seat have vertical center seam on 66"W and 88"W seat units.

Tip: Wood chair frame and wood arm caps must be specified in the same finish.

Tip: Overhang arm is suggested for clinical applications to aid in user ingress and egress.

Standard Includes	Required to Specify
-------------------	---------------------

- Seat and back: fabric price group 1
- Plastic arm caps with overhang: 6527 Merle
- Frame finish: solid maple wood or paint
- Glides: standard adjustable, if selected: 6205 Black plastic or wallsaver, if selected: 6527 Merle plastic
- Midarm, if selected: fabric price group 1

- 1 Style number
 - 2 Back color scheme (see below under Required Selections)
 - 3 Wallsaver or standard glides (see below for Required Selections)
 - 4 Bariatric seat location (see below under Required Selections)
 - 5 Fabric color number for seat and back
 - 6 Fabric color number for midarm, if selected
 - 7 Wood or paint color number for frame
 - 8 Options, if selected (see below)
- ▶ See *Surface Materials*, page 402.

	Required Selections	Price	Required to Specify
Back Color Scheme	• Monolithic	Prices at right	Specify with <i>monolithic back</i> .
	• Contrasting inner back/ outer back	Prices at right	Specify with <i>contrasting inner/outer back</i> .
	• Contrasting upper back/ lower back	Prices at right	Specify with <i>contrasting upper/lower back</i> .
Glides	• Standard glides	No cost	Specify with <i>standard adjustable glides</i> .
	• Wallsaver glides	No cost	Specify with <i>wallsaver glides</i> .
Bariatric Seat Location	Bariatric multiple seat combination		
	• Left side facing and right side facing	No cost	Specify with <i>left side facing and right side facing</i> .
	• Left side facing and center	+\$ 36	Specify with <i>left side facing and center</i> .
	• Right side facing and center	+\$ 36	Specify with <i>right side facing and center</i> .

	Options	Price	Required to Specify
Surface Materials	Frame		
	• Solid maple wood	No cost	Select wood color number.
	• Paint	No cost	Select paint color number.
	Arm caps with no overhang		
	• Plastic	No cost	Specify with <i>no arm cap overhang</i> and select plastic color number.
	• Solid maple wood	+\$ 25 per arm	Specify with <i>no arm cap overhang</i> and select wood color number.
	• Solid surface price group A	+\$227 per cap	Specify with <i>no arm cap overhang</i> and select solid surface color number.
	• Solid surface price group B	+\$239 per cap	Specify with <i>no arm cap overhang</i> and select solid surface color number.
	• Solid surface price group C	+\$251 per cap	Specify with <i>no arm cap overhang</i> and select solid surface color number.
	• Solid surface price group D	+\$263 per cap	Specify with <i>no arm cap overhang</i> and select solid surface color number.
	Arm caps with overhang		
	• Plastic	No cost	Specify with <i>arm cap overhang</i> and select plastic color number.
	• Solid maple wood	+\$ 53 per arm	Specify with <i>arm cap overhang</i> and select wood color number.
	• Solid surface price group A	+\$260 per cap	Specify with <i>arm cap overhang</i> and select solid surface color number.
	• Solid surface price group B	+\$272 per cap	Specify with <i>arm cap overhang</i> and select solid surface color number.
	• Solid surface price group C	+\$284 per cap	Specify with <i>arm cap overhang</i> and select solid surface color number.
	• Solid surface price group D	+\$296 per cap	Specify with <i>arm cap overhang</i> and select solid surface color number.

▶ Options, continued on next page

► Options, continued from previous page

	Options	Price	Required to Specify	
Surface Materials, continued	Moisture barrier on seat			
	<ul style="list-style-type: none"> No moisture barrier Moisture barrier 	<p>No cost</p> <p>+\$297</p>	<p>Specify with no moisture barrier.</p> <p>Specify with moisture barrier.</p>	
Midarm Position	Midarm position for 66"W multiple seat			
	<ul style="list-style-type: none"> No midarm Midarm center Midarm left side facing Midarm right side facing Two midarms 	<p>No cost</p> <p>+\$212</p> <p>+\$248</p> <p>+\$248</p> <p>+\$496</p>	<p>Specify with no midarm.</p> <p>Specify with midarm center.</p> <p>Specify with midarm left side facing.</p> <p>Specify with midarm right side facing.</p> <p>Specify with two midarms.</p>	
	Midarm position for 88"W multiple seat			
	<ul style="list-style-type: none"> No midarm Midarm center Midarm left side facing and right side facing Midarm center and left side facing Midarm center and right side facing Three midarms 	<p>No cost</p> <p>+\$248</p> <p>+\$496</p> <p>+\$496</p> <p>+\$496</p> <p>+\$744</p>	<p>Specify with no midarm.</p> <p>Specify with midarm center.</p> <p>Specify with midarm left side facing and right side facing.</p> <p>Specify with midarm center and left side facing.</p> <p>Specify with midarm center and right side facing.</p> <p>Specify with three midarms.</p>	
	Midleg Position	Midleg position for 66"W multiple seat		
	<ul style="list-style-type: none"> Midleg left side facing Midleg right side facing Midleg center Two midlegs 	<p>+\$140</p> <p>+\$140</p> <p>+\$140</p> <p>+\$280</p>	<p>Specify with midleg left side facing.</p> <p>Specify with midleg right side facing.</p> <p>Specify with midleg center.</p> <p>Specify with two midlegs.</p>	
	Midleg position for 88"W multiple seat			
	<ul style="list-style-type: none"> Midleg center Midleg left side facing and right side facing Midleg center and left side facing Midleg center and right side facing Three midlegs 	<p>+\$140</p> <p>+\$280</p> <p>+\$280</p> <p>+\$280</p> <p>+\$420</p>	<p>Specify with midleg center.</p> <p>Specify with midleg left side facing and right side facing.</p> <p>Specify with midleg center and left side facing.</p> <p>Specify with midleg center and right side facing.</p> <p>Specify with three midlegs.</p>	
Related Products	<ul style="list-style-type: none"> Circular table Rounded rectangle table Racetrack table 		<ul style="list-style-type: none"> ► Page 76 ► Page 76 ► Page 76 	

► Specification Information, on next page

Tip: Midarms will include support plates when needed for configurations. All midarms require support plates except midarm center on 66"W multiple seating unit and the 88"W multiple seat bariatric combination unit with the left-side facing and right-side facing seat location.

Tip: If monolithic or contrasting upper/lower upholstery is selected, then the high back will be specifiable in only one upholstery. If inner/outer contrasting upholstery is selected, then the upholstery will match the inner/outer contrasting upholstery selected on the chair back will be applied to the inner and outer high back.

Tip: When midarm is selected, only left-side facing and right-side facing midlegs are available.

Tip: Two midlegs are required for a 88" wide unit without any midarms.

Families of Seating

Embold, continued

SIN 711.16

► Options, on previous page

Specification Information

Style Number	Base Price	Fabric Upcharges	Fabric Price Group 2	Fabric Price Group 3	Fabric Price Group 4	Fabric Price Group 5	Fabric Price Group 6	Fabric Price Group 7	Fabric Price Group 8	Fabric Price Group 9	Fabric Price Group 10	COM
--------------	------------	------------------	----------------------	----------------------	----------------------	----------------------	----------------------	----------------------	----------------------	----------------------	-----------------------	-----

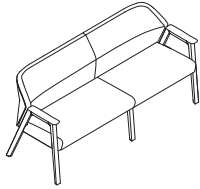

Tip: If a separate price grade is desired for upper back, lower back, inner back, or outer back for the contrasting back color schemes, divide the fabric upcharge in half to get the price of one back location in that price grade.

Tip: When specifying upper back and lower back or inner back and outer back, you may specify a different fabric color number for each surface separately. For example, one upholstery grade on the upper back and a different upholstery grade on the lower back.

66"W Multiple Seat

HSBM66	\$2394	Seat	+\$ 67	+\$131	+\$180	+\$224	+\$238	+\$270	+\$348	+\$378	+\$395	+\$24
		Monolithic back, if selected	+\$120	+\$234	+\$322	+\$400	+\$424	+\$478	+\$620	+\$674	+\$700	+\$40
		Upper back and lower back, if selected	+\$120	+\$234	+\$322	+\$400	+\$424	+\$478	+\$620	+\$674	+\$700	+\$40
		Inner back and outer back, if selected	+\$120	+\$234	+\$322	+\$400	+\$424	+\$478	+\$620	+\$674	+\$700	+\$40
		Midarm (per arm), if selected	+\$ 6	+\$ 20	+\$ 44	+\$ 83	+\$141	+\$216	+\$317	+\$432	+\$576	+\$17

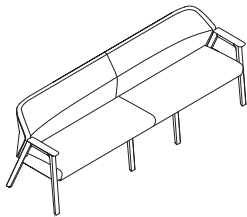

Tip: If a separate price grade is desired for upper back, lower back, inner back, or outer back for the contrasting back color schemes, divide the fabric upcharge in half to get the price of one back location in that price grade.

Tip: When specifying upper back and lower back or inner back and outer back, you may specify a different fabric color number for each surface separately. For example, one upholstery grade on the upper back and a different upholstery grade on the lower back.

Tip: Two midlegs are included in the base price of the 88"W multiple seat.

88"W Multiple Seat

HSBM88	\$3446	Seat	+\$ 92	+\$180	+\$251	+\$313	+\$339	+\$391	+\$510	+\$ 566	+\$ 605	+\$24
		Monolithic back, if selected	+\$162	+\$320	+\$442	+\$558	+\$604	+\$694	+\$908	+\$1006	+\$1074	+\$40
		Upper back and lower back, if selected	+\$162	+\$320	+\$442	+\$558	+\$604	+\$694	+\$908	+\$1006	+\$1074	+\$40
		Inner back and outer back, if selected	+\$162	+\$320	+\$442	+\$558	+\$604	+\$694	+\$908	+\$1006	+\$1074	+\$40
		Midarm (per arm), if selected	+\$ 6	+\$ 20	+\$ 44	+\$ 83	+\$141	+\$216	+\$317	+\$ 432	+\$ 576	+\$17

► Specification Information, continued on next page

► Specification Information, continued from previous page

Seating

Specification Information												
Style Number	Base Price	Fabric Upcharges	Fabric Price Group 2	Fabric Price Group 3	Fabric Price Group 4	Fabric Price Group 5	Fabric Price Group 6	Fabric Price Group 7	Fabric Price Group 8	Fabric Price Group 9	Fabric Price Group 10	COM

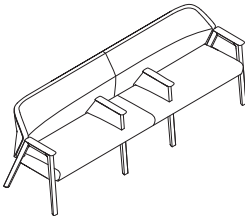

Tip: If a separate price grade is desired for upper back, lower back, inner back, or outer back for the contrasting back color schemes, divide the fabric upcharge in half to get the price of one back location in that price grade.

Tip: When specifying upper back and lower back or inner back and outer back, you may specify a different fabric color number for each surface separately. For example, one upholstery grade on the upper back and a different upholstery grade on the lower back.

Tip: Two midlegs and two midarms are included in the base price of the 88"W multiple seat bariatric combination.

88"W Multiple Seat Bariatric Combination

HSBM88C	\$3870	Seat	+\$ 92	+\$180	+\$251	+\$313	+\$339	+\$391	+\$510	+\$ 566	+\$ 605	+\$24
		Monolithic back, if selected	+\$162	+\$320	+\$442	+\$558	+\$604	+\$694	+\$908	+\$1006	+\$1074	+\$40
		Upper back and lower back, if selected	+\$162	+\$320	+\$442	+\$558	+\$604	+\$694	+\$908	+\$1006	+\$1074	+\$40
		Inner back and outer back, if selected	+\$162	+\$320	+\$442	+\$558	+\$604	+\$694	+\$908	+\$1006	+\$1074	+\$40
		Midarm (per arm)	+\$ 6	+\$ 20	+\$ 44	+\$ 83	+\$141	+\$216	+\$317	+\$ 432	+\$ 576	+\$17

SIN 711.16

Easy Access

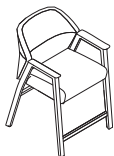

Tip: Fabrics with a repeating pattern will not remain aligned around the corners of the chair or in the boxing (the outer perimeter).

Tip: Only one back color scheme can be chosen.

► For more information on the different color schemes, see Steelcase Health Volume 1 Seating Specification Guide

Tip: Wood chair frame and wood arm caps must be specified in the same finish.

Tip: Overhang arm is suggested for clinical applications to aid in user ingress and egress.

Standard Includes	Required to Specify
<ul style="list-style-type: none"> • Seat and back: fabric price group 1 • Plastic arm caps with overhang: 6527 Merle • Frame finish: solid maple wood or paint • Glides: standard adjustable, if selected: 6205 Black plastic or wallsaver, if selected: 6527 Merle plastic • Bracket and cover, if high back selected: paint • Flexing back • Footrest 	<ol style="list-style-type: none"> 1 Style number 2 Back color scheme (see below under Required Selections) 3 Wallsaver or standard glides (see below for Required Selections) 4 Fabric color number for seat and back 5 Wood or paint color number for frame 6 Paint color number for bracket and cover finish, if high back selected. 7 Options, if selected (see below) <p>► See <i>Surface Materials</i>, page 402.</p>

	Required Selections	Price	Required to Specify
Back Color Scheme	• Monolithic	Prices at right	Specify with <i>monolithic back</i> .
	• Contrasting inner back/ outer back	Prices at right	Specify with <i>contrasting inner/outer back</i> .
	• Contrasting upper back/ lower back	Prices at right	Specify with <i>contrasting upper/lower back</i> .
Glides	• Standard glides	No cost	Specify with <i>standard adjustable glides</i> .
	• Wallsaver glides	No cost	Specify with <i>wallsaver glides</i> .

	Options	Price	Required to Specify
Surface Materials	Frame		
	• Solid maple wood	No cost	Select wood color number.
	• Paint	No cost	Select paint color number.
	Arm caps with no overhang		
	• Plastic	No cost	Specify with <i>no arm cap overhang</i> and select plastic color number.
	• Solid maple wood	+\$ 25 per arm	Specify with <i>no arm cap overhang</i> and select wood color number.
	• Solid surface price group A	+\$227 per cap	Specify with <i>no arm cap overhang</i> and select solid surface color number.
	• Solid surface price group B	+\$239 per cap	Specify with <i>no arm cap overhang</i> and select solid surface color number.
	• Solid surface price group C	+\$251 per cap	Specify with <i>no arm cap overhang</i> and select solid surface color number.
	• Solid surface price group D	+\$263 per cap	Specify with <i>no arm cap overhang</i> and select solid surface color number.
	Arm caps with overhang		
	• Plastic	No cost	Specify with <i>arm cap overhang</i> and select plastic color number.
	• Solid maple wood	+\$ 53 per arm	Specify with <i>arm cap overhang</i> and select wood color number.
	• Solid surface price group A	+\$260 per cap	Specify with <i>arm cap overhang</i> and select solid surface color number.
	• Solid surface price group B	+\$272 per cap	Specify with <i>arm cap overhang</i> and select solid surface color number.
	• Solid surface price group C	+\$284 per cap	Specify with <i>arm cap overhang</i> and select solid surface color number.
	• Solid surface price group D	+\$296 per cap	Specify with <i>arm cap overhang</i> and select solid surface color number.
	Moisture barrier on seat		
	• No moisture barrier	No cost	Specify with <i>no moisture barrier</i> .
	• Moisture barrier	+\$ 99	Specify with <i>moisture barrier</i> .

► Options, continued on next page

► Options, continued from previous page

Tip: If monolithic or contrasting upper/lower upholstery is selected, then the high back will be specifiable in only one upholstery. If inner/outer contrasting upholstery is selected, then the upholstery will match the inner/outer contrasting upholstery selected on the chair back will be applied to the inner and outer high back.

Options	Price	Required to Specify
Surface Materials, continued	High back upholstery for 21"W easy access	
• Fabric price group 1	No cost	Specify fabric color number.
• Fabric price group 2	+\$ 6	Specify fabric color number.
• Fabric price group 3	+\$ 36	Specify fabric color number.
• Fabric price group 4	+\$ 79	Specify fabric color number.
• Fabric price group 5	+\$134	Specify fabric color number.
• Fabric price group 6	+\$196	Specify fabric color number.
• Fabric price group 7	+\$271	Specify fabric color number.
• Fabric price group 8	+\$371	Specify fabric color number.
• Fabric price group 9	+\$487	Specify fabric color number.
• Fabric price group 10	+\$617	Specify fabric color number.
• Customer's Own Material (COM)	+\$ 17	► See <i>Surface Materials Reference Manual</i> .
	High back upholstery for 32"W easy access	
• Fabric price group 1	No cost	Specify fabric color number.
• Fabric price group 2	+\$ 8	Specify fabric color number.
• Fabric price group 3	+\$ 27	Specify fabric color number.
• Fabric price group 4	+\$ 59	Specify fabric color number.
• Fabric price group 5	+\$111	Specify fabric color number.
• Fabric price group 6	+\$187	Specify fabric color number.
• Fabric price group 7	+\$292	Specify fabric color number.
• Fabric price group 8	+\$427	Specify fabric color number.
• Fabric price group 9	+\$589	Specify fabric color number.
• Fabric price group 10	+\$779	Specify fabric color number.
• Customer's Own Material (COM)	+\$ 17	► See <i>Surface Materials Reference Manual</i> .
High Back	High back for 21"W easy access	
• No high back	No cost	Specify <i>without high back</i> .
• With high back	+\$100	Specify <i>with high back</i> .
	High back for 32"W easy access	
• No high back	No cost	Specify <i>without high back</i> .
• With high back	+\$160	Specify <i>with high back</i> .
Related Products	• Multiple seat	► Page 68
	• Circular table	► Page 76
	• Rounded rectangle table	► Page 76
	• Racetrack table	► Page 76

► Specification Information, on next page

Families of Seating

Embold, continued

SIN 711.16

► Options, on previous page

Specification Information

Style Number	Base Price	Fabric Upcharges	Fabric Price Group 2	Fabric Price Group 3	Fabric Price Group 4	Fabric Price Group 5	Fabric Price Group 6	Fabric Price Group 7	Fabric Price Group 8	Fabric Price Group 9	Fabric Price Group 10	COM
--------------	------------	------------------	----------------------	----------------------	----------------------	----------------------	----------------------	----------------------	----------------------	----------------------	-----------------------	-----



Tip: If a separate price grade is desired for upper back, lower back, inner back, or outer back for the contrasting back color schemes, divide the fabric upcharge in half to get the price of one back location in that price grade.

Tip: When specifying upper back and lower back or inner back and outer back, you may specify a different fabric color number for each surface separately. For example, one upholstery grade on the upper back and a different upholstery grade on the lower back.

21"W Easy Access

Style Number	Base Price	Item	Fabric Price Group 2	Fabric Price Group 3	Fabric Price Group 4	Fabric Price Group 5	Fabric Price Group 6	Fabric Price Group 7	Fabric Price Group 8	Fabric Price Group 9	Fabric Price Group 10	COM
HSBE21	\$1356	Seat	+\$23	+\$ 46	+\$ 66	+\$ 85	+\$ 96	+\$115	+\$154	+\$178	+\$201	+\$10
		Monolithic back, if selected	+\$42	+\$ 82	+\$116	+\$150	+\$172	+\$206	+\$274	+\$316	+\$356	+\$24
		Upper back and lower back, if selected	+\$42	+\$ 82	+\$116	+\$150	+\$172	+\$206	+\$274	+\$316	+\$356	+\$24
		Inner back and outer back, if selected	+\$42	+\$ 82	+\$116	+\$150	+\$172	+\$206	+\$274	+\$316	+\$356	+\$24

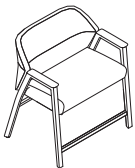

Tip: If a separate price grade is desired for upper back, lower back, inner back, or outer back for the contrasting back color schemes, divide the fabric upcharge in half to get the price of one back location in that price grade.

Tip: When specifying upper back and lower back or inner back and outer back, you may specify a different fabric color number for each surface separately. For example, one upholstery grade on the upper back and a different upholstery grade on the lower back.

32"W Easy Access

Style Number	Base Price	Item	Fabric Price Group 2	Fabric Price Group 3	Fabric Price Group 4	Fabric Price Group 5	Fabric Price Group 6	Fabric Price Group 7	Fabric Price Group 8	Fabric Price Group 9	Fabric Price Group 10	COM
HSBE32	\$1481	Seat	+\$48	+\$ 95	+\$135	+\$175	+\$199	+\$253	+\$324	+\$388	+\$455	+\$10
		Monolithic back, if selected	+\$84	+\$170	+\$240	+\$310	+\$352	+\$448	+\$578	+\$690	+\$812	+\$24
		Upper back and lower back, if selected	+\$84	+\$170	+\$240	+\$310	+\$352	+\$448	+\$578	+\$690	+\$812	+\$24
		Inner back and outer back, if selected	+\$84	+\$170	+\$240	+\$310	+\$352	+\$448	+\$578	+\$690	+\$812	+\$24

Embold Tables

SIN 711.16



Tip: Edge finish only applies to the High-Pressure Laminate worksurfaces.

For laminate price group 2 pricing, please refer to the electronic catalog or SmartTools.

Tip: Solid maple, solid oak, and solid walnut wood tops are only available for the circular table. Solid wood tops can only be specified with metal or matching species of wood legs.

Tip: Solid maple, solid oak, and solid walnut wood tops are solid cuts of wood, not veneered pieces. Natural variation occurs with wood products.

Tip: Solid wood circular tables have a low-sheen clear coat applied to them and will have intentional and natural variations that include, but are not limited to: character marks, grain pattern, color, and natural color aging.

Tip: Solid wood table tops should be specified for non-clinical areas only.

Standard Includes	Required to Specify
<ul style="list-style-type: none"> • Frame: paint price groups 1 and 2 • Table top: High-Pressure Laminate price group 1 with 3 mm plastic edge • Legs: solid maple wood or paint price groups 1 and 2 	<ol style="list-style-type: none"> 1 Style number 2 Paint color number for frame 3 Laminate color number for top 4 Plastic color number for edge 5 Wood or paint color number for legs 6 Options, if selected (see below) <p>▶ See <i>Surface Materials</i>, page 402.</p>

Surface Materials	Options	Price	Required to Specify
	Frame		
	• Paint price group 3		
	-Circular table	+\$ 25	Specify paint color number.
	-Rectangle table	+\$ 32	Specify paint color number.
	-Racetrack table	+\$ 41	Specify paint color number.
	Top surface for circular table		
	• High-Pressure Laminate price group 1	No cost	Specify with <i>laminate top surface</i> and select laminate color number.
	• High-Pressure Laminate price group 2	See information at left	Specify with <i>laminate top surface</i> and select laminate color number.
	• Open Line laminate	+\$ 71 plus cost of laminate	▶ See <i>Surface Materials Reference Manual</i> .
	• Solid maple wood	+\$ 238	Specify with <i>maple top surface</i> and select 3P51 OP Planked Maple.
	• Solid oak wood	+\$ 370	Specify with <i>oak top surface</i> and select 3P61 OP Planked Oak.
	• Solid walnut wood	+\$ 582	Specify with <i>walnut top surface</i> and select 3P71 OP Planked Walnut.
	• Solid surface price group A	+\$ 748	Specify with <i>solid surface top surface</i> and select solid surface color number.
	• Solid surface price group B	+\$ 829	Specify with <i>solid surface top surface</i> and select solid surface color number.
	• Solid surface price group C	+\$ 923	Specify with <i>solid surface top surface</i> and select solid surface color number.
	• Solid surface price group D	+\$1445	Specify with <i>solid surface top surface</i> and select solid surface color number.
	Top surface for rectangle table		
	• High-Pressure Laminate price group 1	No cost	Specify with <i>laminate top surface</i> and select laminate color number.
	• High-Pressure Laminate price group 2	See information at left	Specify with <i>laminate top surface</i> and select laminate color number.
	• Open Line laminate	+\$ 71 plus cost of laminate	▶ See <i>Surface Materials Reference Manual</i> .
	• Solid surface price group A	+\$ 870	Specify with <i>solid surface top surface</i> and select solid surface color number.
	• Solid surface price group B	+\$ 967	Specify with <i>solid surface top surface</i> and select solid surface color number.
	• Solid surface price group C	+\$1080	Specify with <i>solid surface top surface</i> and select solid surface color number.
	• Solid surface price group D	+\$1708	Specify with <i>solid surface top surface</i> and select solid surface color number.
	Top surface for racetrack table		
	• High-Pressure Laminate price group 1	No cost	Specify with <i>laminate top surface</i> and select laminate color number.
	• High-Pressure Laminate price group 2	See information at left	Specify with <i>laminate top surface</i> and select laminate color number.
	• Open Line laminate	+\$ 71 plus cost of laminate	▶ See <i>Surface Materials Reference Manual</i> .
	• Solid surface price group A	+\$1037	Specify with <i>solid surface top surface</i> and select solid surface color number.
	• Solid surface price group B	+\$1151	Specify with <i>solid surface top surface</i> and select solid surface color number.
	• Solid surface price group C	+\$1284	Specify with <i>solid surface top surface</i> and select solid surface color number.
	• Solid surface price group D	+\$2025	Specify with <i>solid surface top surface</i> and select solid surface color number.

▶ Options, continued on next page

► Options, continued from previous page

Tip: Steelcase recommends to check with all local and facility authorities prior to specification and order to confirm acceptance of proposed product and applications.

Tip: Power location is centered on the circular table. Power location is located at the side on the rounded rectangle table and racetrack table.

Tip: Cutout is only available for solid oak, solid walnut, solid maple, and solid surface tops and follows power location.

Tip: Braided cords should be specified for non-clinical spaces only.

Tip: Braided cords are not available when USB option is selected.

Options	Price	Required to Specify
Surface Materials, continued Legs <ul style="list-style-type: none"> • Paint • Solid maple wood • Solid oak wood • Solid walnut wood 	No cost No cost +\$ 25 +\$ 55	Specify paint color number. Specify wood color number. Specify with 3P61 OP Planked Oak. Specify with 3P71 OP Planked Walnut.
Power <ul style="list-style-type: none"> • No power • Power • Dual USB 	No cost +\$100 +\$175	Specify with no power. Specify with power. Specify with dual USB.
Power Cord (If power selected) <ul style="list-style-type: none"> • Standard cord • Braided cord 	No cost +\$ 40	Specify with standard cord. Specify with braided cord.
Cutout <ul style="list-style-type: none"> • No cutout • With cutout 	No cost +\$ 18	Specify with no cutout. Specify with cutout.
Related Products <ul style="list-style-type: none"> • Single seat • Multiple seat 		► Page 62 ► Page 68

Specification Information				
Dimensions			Style	Base
D	W	H	Number	Price

Circular Table

20" Dia. N.A. 19" **HSBT20** \$612



Rounded Rectangle Table

19" 32" 19" **HSBT3219** \$765

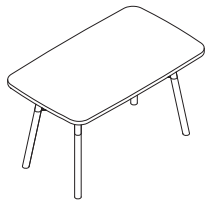

Racetrack Table

20" 42" 19" **HSBT4220** \$893



Embold Accessories

SIN 711.16

Midarm

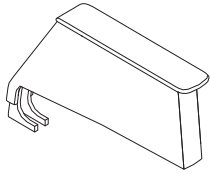

Tip: A support plate may need to be ordered depending on configuration desired.

Standard Includes	Required to Specify
-------------------	---------------------

- Midarm: fabric price group 1
- Plastic arm caps with overhang: 6527 Merle

- 1 Style number
 - 2 Fabric color number for midarm
 - 3 Options, if selected (see below)
- ▶ See *Surface Materials*, page 402.

Arm Cap Overhang	Options	Price	Required to Specify
------------------	---------	-------	---------------------

Arm Cap Overhang	Plastic arm		
	• No overhang	No cost	Specify <i>with no overhang</i> .
	• Overhang	No cost	Specify <i>with overhang</i> .

	Solid maple wood arm		
	• No overhang	+\$ 25	Specify <i>with no overhang</i> .
	• Overhang	+\$ 53	Specify <i>with overhang</i> .

	Solid surface arm caps with no overhang		
	• Solid surface price group A	+\$227 per cap	Specify <i>with solid surface arm caps</i> and select solid surface color number. Specify <i>with solid surface arm caps</i> and select solid surface color number. Specify <i>with solid surface arm caps</i> and select solid surface color number. Specify <i>with solid surface arm caps</i> and select solid surface color number.
	• Solid surface price group B	+\$239 per cap	
	• Solid surface price group C	+\$251 per cap	
	• Solid surface price group D	+\$263 per cap	

	Solid surface arm caps with overhang		
	• Solid surface price group A	+\$260 per cap	Specify <i>with solid surface arm caps</i> and select solid surface color number. Specify <i>with solid surface arm caps</i> and select solid surface color number. Specify <i>with solid surface arm caps</i> and select solid surface color number. Specify <i>with solid surface arm caps</i> and select solid surface color number.
	• Solid surface price group B	+\$272 per cap	
	• Solid surface price group C	+\$284 per cap	
	• Solid surface price group D	+\$296 per cap	

Specification Information											
Style Number	Base Price	Fabric Price Group 2	Fabric Price Group 3	Fabric Price Group 4	Fabric Price Group 5	Fabric Price Group 6	Fabric Price Group 7	Fabric Price Group 8	Fabric Price Group 9	Fabric Price Group 10	COM

HSBARM	\$212	+\$6	+\$20	+\$44	+\$83	+\$141	+\$216	+\$317	+\$432	+\$576	+\$17
--------	-------	------	-------	-------	-------	--------	--------	--------	--------	--------	-------

Midleg

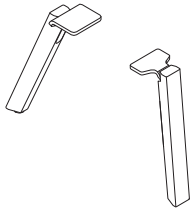

Tip: A support plate may need to be ordered depending on configuration desired.

Standard Includes	Required to Specify
-------------------	---------------------

- Midleg: paint or solid maple wood
- Glides: adjustable, if selected: 6205 Black plastic or wallsaver, if selected: 6527 Merle plastic

- 1 Style number
- 2 Paint or wood color number
- 3 Wallsaver or standard glides (see below for Required Selections)
- ▶ See *Surface Materials*, page 402.

Required Selections	Price	Required to Specify
---------------------	-------	---------------------

- | | | |
|---------------|---|--|
| Glides | <ul style="list-style-type: none"> • Standard glides • Wallsaver glides | No cost
No cost
Specify with <i>standard adjustable glides</i> .
Specify with <i>wallsaver glides</i> . |
|---------------|---|--|

Specification Information	
---------------------------	--

Style Number	Price
HSBLEG	\$140
.	.
.	.

Midleg and Midarm Support Plate

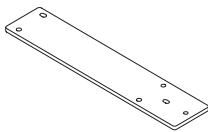

Standard Includes	Required to Specify
-------------------	---------------------

- Support plate

- Style number

Specification Information	
---------------------------	--

Style Number	Price
HSBLEGP	\$36
.	.
.	.

Leela

SIN 711.16

Lounge Seating

Tip: Different fabrics for the seat and back can be specified. If the fabrics are in different price groups, calculate list price by adding the two price groups together and dividing by two.

Standard Includes	Required to Specify
-------------------	---------------------

- Seat and back: fabric
- Arm panels: fabric to match back
- Legs: painted steel
- Glides: black

- 1 Style number
 - 2 Fabric color number for back and seat
 - 3 Paint color number for legs
 - 4 Options, if selected (see below)
- ▶ See *Surface Materials*, page 402.

Options	Price	Required to Specify
---------	-------	---------------------

Surface Materials

Moisture barrier

- Lounge chair +\$ 96
- Loveseat +\$192
- Sofa +\$288

Specify with *moisture barrier*.
Specify with *moisture barrier*.
Specify with *moisture barrier*.

Arm caps

- Plastisol arm caps: black only +\$102
- Maple wood arm caps +\$159

Specify with *plastisol arm caps*.
Specify with *wood arm caps* and select wood color number.

Specification Information

Base Prices

Style Number	Width	Fabric Price										COM
		Group 1	Group 2	Group 3	Group 4	Group 5	Group 6	Group 7	Group 8	Group 9	Group 10	

21"W Lounge Chair

HS2L121	21"	\$1317	\$1441	\$1553	\$1649	\$1743	\$1819	\$1911	\$2055	\$2243	\$2357	\$1349
----------------	-----	--------	--------	--------	--------	--------	--------	--------	--------	--------	--------	--------

24"W Lounge Chair

HS2L124	24"	\$1448	\$1572	\$1684	\$1780	\$1874	\$1950	\$2042	\$2186	\$2374	\$2488	\$1480
----------------	-----	--------	--------	--------	--------	--------	--------	--------	--------	--------	--------	--------

Loveseat

HS2L2	40"	\$2125	\$2279	\$2423	\$2539	\$2655	\$2753	\$2871	\$3047	\$3285	\$3425	\$2157
--------------	-----	--------	--------	--------	--------	--------	--------	--------	--------	--------	--------	--------

Sofa

HS2L3	56"	\$2975	\$3219	\$3449	\$3637	\$3825	\$3977	\$4169	\$4449	\$4829	\$5055	\$3007
--------------	-----	--------	--------	--------	--------	--------	--------	--------	--------	--------	--------	--------

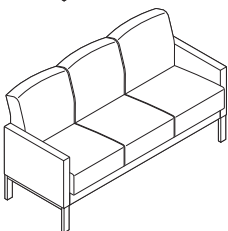
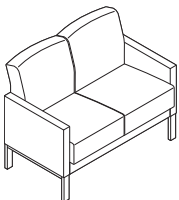
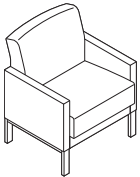
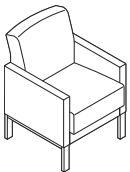

Bariatric Lounge Seating

Standard Includes	Required to Specify
-------------------	---------------------

- Seat and back: fabric
- Arm panels: fabric to match back
- Legs: painted steel
- Glides: black

- 1 Style number
 - 2 Fabric color number for back and seat
 - 3 Paint color number for legs
 - 4 Options, if selected (see below)
- ▶ See *Surface Materials*, page 402.

Tip: Different fabrics for the seat and back can be specified. If the fabrics are in different price groups, calculate list price by adding the two price groups together and dividing by two.

Options	Price	Required to Specify
---------	-------	---------------------

Surface Materials

Moisture barrier

- Moisture barrier +\$ 96

Specify with *moisture barrier*.

Arm caps

- Plastisol arm caps: black only +\$102
- Maple wood arm caps +\$159

Specify with *plastisol arm caps*.
Specify with *wood arm caps* and select wood color number.

Specification Information

Base Prices

Style Number	Width	Fabric Price Group 1	Fabric Price Group 2	Fabric Price Group 3	Fabric Price Group 4	Fabric Price Group 5	Fabric Price Group 6	Fabric Price Group 7	Fabric Price Group 8	Fabric Price Group 9	Fabric Price Group 10	COM
--------------	-------	----------------------	----------------------	----------------------	----------------------	----------------------	----------------------	----------------------	----------------------	----------------------	-----------------------	-----

Bariatric Lounge Chair

HS2L130	30"	\$1784	\$1938	\$2082	\$2198	\$2314	\$2412	\$2530	\$2706	\$2944	\$3084	\$1816
----------------	-----	--------	--------	--------	--------	--------	--------	--------	--------	--------	--------	--------

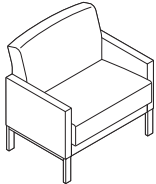

HS2L140	40"	\$2441	\$2625	\$2795	\$2939	\$3081	\$3193	\$3335	\$3549	\$3833	\$4003	\$2473
----------------	-----	--------	--------	--------	--------	--------	--------	--------	--------	--------	--------	--------

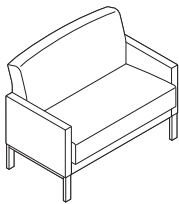

Leela Tables

SIN 711.16

Freestanding Tables

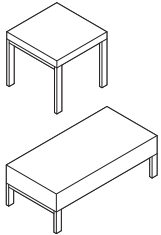

Tip: For finish codes and more information on the solid surface graded-in program see Surface Materials Reference Manual.

Standard Includes	Required to Specify
-------------------	---------------------

- Table: steel
- Top: metal or solid surface

- 1 Style number
 - 2 Paint color number for metal top, if selected
 - 3 Solid surface color number for top, if selected
 - 4 Paint color number for legs
 - 5 Options, if selected (see below)
- ▶ See *Surface Materials*, page 402.

Surface Materials	Options	Price	Required to Specify
-------------------	---------	-------	---------------------

Surface Materials	Options	Price	Required to Specify
	Square tables		
	• Solid surface price group A	No cost	Specify solid surface color number or finish code.
	• Solid surface price group B	Prices below	Specify solid surface color number or finish code.
	• Solid surface price group C	Prices below	Specify solid surface color number or finish code.
	• Solid surface price group D	Prices below	Specify solid surface color number or finish code.

Specification Information							
Dimensions			Style Number	Prices			
D	W	H	Number	Price Group A	Price Group B	Price Group C	Price Group D

D	W	H	Number	Price Group A	Price Group B	Price Group C	Price Group D
---	---	---	--------	---------------	---------------	---------------	---------------

Table with Metal Top

21"	21"	21"	HS2T212121C	\$1048	N.A.	N.A.	N.A.
21"	42"	16"	HS2T422116C	\$1570	N.A.	N.A.	N.A.

Table with Solid Surface Top

21"	21"	21"	HS2T212121S	\$1675	\$1708	\$1754	\$1866
21"	42"	16"	HS2T422116S	\$2513	\$2578	\$2684	\$2917

Mitra

SIN 711.17

Guest Seating

Tip: Two- and three-seat chairs have arms and legs between each seat.

Tip: Different fabrics for the seat and back can be specified. If the fabrics are in different price groups, calculate list price by adding the two price groups together and dividing by two.

Standard Includes	Required to Specify
-------------------	---------------------

- Seat and back: fabric
- Arm caps: maple wood
- Legs and frame: maple wood
- Glides: brown plastic

- 1 Style number
 - 2 Fabric color number for seat and back
 - 3 Wood color number for frame, legs, and arm caps
 - 4 Options, if selected (see below)
- ▶ See *Surface Materials*, page 402.

Surface Materials	Options	Price	Required to Specify
-------------------	---------	-------	---------------------

Surface Materials	Moisture barrier		
	<ul style="list-style-type: none"> • Single-seat chairs • Two-seat chairs • Three-seat chairs 	<ul style="list-style-type: none"> +\$ 96 +\$192 +\$288 	<ul style="list-style-type: none"> Specify with <i>moisture barrier</i>. Specify with <i>moisture barrier</i>. Specify with <i>moisture barrier</i>.
Surface Materials	Arm caps		
	<ul style="list-style-type: none"> • Plastic arm caps 	<ul style="list-style-type: none"> +\$ 51 per cap 	<ul style="list-style-type: none"> Specify with <i>plastic arm caps</i> and select plastic color number.
	<ul style="list-style-type: none"> • Solid surface price group A 	<ul style="list-style-type: none"> +\$208 per cap 	<ul style="list-style-type: none"> Specify with <i>solid surface arm caps</i> and select solid surface color number.
	<ul style="list-style-type: none"> • Solid surface price group B 	<ul style="list-style-type: none"> +\$220 per cap 	<ul style="list-style-type: none"> Specify with <i>solid surface arm caps</i> and select solid surface color number.
	<ul style="list-style-type: none"> • Solid surface price group C 	<ul style="list-style-type: none"> +\$232 per cap 	<ul style="list-style-type: none"> Specify with <i>solid surface arm caps</i> and select solid surface color number.
	<ul style="list-style-type: none"> • Solid surface price group D 	<ul style="list-style-type: none"> +\$244 per cap 	<ul style="list-style-type: none"> Specify with <i>solid surface arm caps</i> and select solid surface color number.

Specification Information



Single-Seat Chair



Two-Seat Chair



Three-Seat Chair

Base Prices

Style Number	Fabric Price Group 1	Fabric Price Group 2	Fabric Price Group 3	Fabric Price Group 4	Fabric Price Group 5	Fabric Price Group 6	Fabric Price Group 7	Fabric Price Group 8	Fabric Price Group 9	Fabric Price Group 10	COM
--------------	----------------------	----------------------	----------------------	----------------------	----------------------	----------------------	----------------------	----------------------	----------------------	-----------------------	-----

Single-Seat Chair

SC6010A	\$ 905	\$ 967	\$1023	\$1071	\$1121	\$1151	\$1203	\$1269	\$1365	\$1425	\$ 967
----------------	--------	--------	--------	--------	--------	--------	--------	--------	--------	--------	--------

Two-Seat Chair

SC6026A	\$1546	\$1664	\$1782	\$1878	\$1972	\$2044	\$2136	\$2280	\$2468	\$2586	\$1608
----------------	--------	--------	--------	--------	--------	--------	--------	--------	--------	--------	--------

Three-Seat Chair

SC6036A	\$2208	\$2384	\$2562	\$2706	\$2848	\$2954	\$3096	\$3308	\$3590	\$3770	\$2270
----------------	--------	--------	--------	--------	--------	--------	--------	--------	--------	--------	--------

Mitra, continued

SIN 711.17

Bariatric Seating

Tip: Combination units have arms and legs between each seat.

Tip: Different fabrics for the seat and back can be specified. If the fabrics are in different price groups, calculate list price by adding the two price groups together and dividing by two.

Standard Includes	Required to Specify
-------------------	---------------------

- Seat and back: fabric
- Arm caps: maple wood
- Legs and frame: maple wood
- Glides: brown plastic

- 1 Style number
 - 2 Fabric color number for seat and back
 - 3 Wood color number for frame, legs, and arm caps
 - 4 Options, if selected (see below)
- ▶ See *Surface Materials*, page 402.

Surface Materials	Options	Price	Required to Specify
-------------------	---------	-------	---------------------

Surface Materials

Moisture barrier

- Single-seat chairs +\$ 96
- Combination units +\$288

Specify *with moisture barrier*.
Specify *with moisture barrier*.

Arm caps

- Plastic arm caps +\$ 51 per cap
- Solid surface price group A +\$208 per cap
- Solid surface price group B +\$220 per cap
- Solid surface price group C +\$232 per cap
- Solid surface price group D +\$244 per cap

Specify *with plastic arm caps* and select plastic color number.
Specify *with solid surface arm caps* and select solid surface color number.
Specify *with solid surface arm caps* and select solid surface color number.
Specify *with solid surface arm caps* and select solid surface color number.
Specify *with solid surface arm caps* and select solid surface color number.

Specification Information



Single-Seat Chair



Combination Unit

Base Prices

Style Number	Fabric Price Group 1	Fabric Price Group 2	Fabric Price Group 3	Fabric Price Group 4	Fabric Price Group 5	Fabric Price Group 6	Fabric Price Group 7	Fabric Price Group 8	Fabric Price Group 9	Fabric Price Group 10	COM
--------------	----------------------	----------------------	----------------------	----------------------	----------------------	----------------------	----------------------	----------------------	----------------------	-----------------------	-----

Single-Seat Chair

SC6060A	\$1088	\$1178	\$1264	\$1334	\$1406	\$1460	\$1532	\$1640	\$1780	\$1868	\$1150
----------------	--------	--------	--------	--------	--------	--------	--------	--------	--------	--------	--------

Combination Unit

SC6046A	\$2388	\$2600	\$2802	\$2968	\$3134	\$3258	\$3424	\$3674	\$4002	\$4210	\$2450
----------------	--------	--------	--------	--------	--------	--------	--------	--------	--------	--------	--------

High-Back Chair

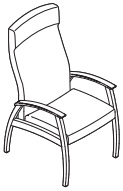

Tip: Different fabrics for the seat and back can be specified. If the fabrics are in different price groups, calculate list price by adding the two price groups together and dividing by two.

Standard Includes	Required to Specify
-------------------	---------------------

- Seat and back: fabric
- Arm caps: maple wood
- Legs and frame: maple wood
- Glides: brown plastic

- 1 Style number
 - 2 Fabric color number for seat and back
 - 3 Wood color number for frame, legs, and arm caps
 - 4 Options, if selected (see below)
- ▶ See *Surface Materials*, page 402.

Surface Materials	Options	Price	Required to Specify
-------------------	---------	-------	---------------------

Surface Materials	Moisture barrier		
	• Moisture barrier	+\$ 96	Specify with <i>moisture barrier</i> .
	Arm caps		
	• Plastic arm caps	+\$102	Specify with <i>plastic arm caps</i> and select plastic color number.
	• Solid surface price group A	+\$416	Specify with <i>solid surface arm caps</i> and select solid surface color number.
	• Solid surface price group B	+\$440	Specify with <i>solid surface arm caps</i> and select solid surface color number.
	• Solid surface price group C	+\$464	Specify with <i>solid surface arm caps</i> and select solid surface color number.
	• Solid surface price group D	+\$488	Specify with <i>solid surface arm caps</i> and select solid surface color number.

Specification Information

Style Number	Base Prices										COM
	Fabric Price Group 1	Fabric Price Group 2	Fabric Price Group 3	Fabric Price Group 4	Fabric Price Group 5	Fabric Price Group 6	Fabric Price Group 7	Fabric Price Group 8	Fabric Price Group 9	Fabric Price Group 10	
	SC6085A	\$958	\$1034	\$1108	\$1170	\$1226	\$1270	\$1328	\$1416	\$1536	

Mitra, continued

SIN 711.17

Easy Access Chair



Tip: Different fabrics for the seat and back can be specified. If the fabrics are in different price groups, calculate list price by adding the two price groups together and dividing by two.

Standard Includes	Required to Specify
<ul style="list-style-type: none"> ▶ Need help? Product details, see <i>Steelcase Health Volume 1 Specification Guide</i> • Seat and back: fabric • Arm caps: maple wood • Legs and frame: maple wood • Glides: brown plastic • Footrest cover: black plastic 	<ol style="list-style-type: none"> 1 Style number 2 Fabric color number for seat and back 3 Wood color number for frame, legs, and arm caps 4 Options, if selected (see below) <p>▶ See <i>Surface Materials</i>, page 402.</p>

Options	Price	Required to Specify
Surface Materials <ul style="list-style-type: none"> • Moisture barrier 	+\$ 96	Specify <i>with moisture barrier</i> .
<ul style="list-style-type: none"> • Arm caps 		
<ul style="list-style-type: none"> • Plastic arm caps 	+\$102	Specify <i>with plastic arm caps</i> and select plastic color number.
<ul style="list-style-type: none"> • Solid surface price group A 	+\$416	Specify <i>with solid surface arm caps</i> and select solid surface color number.
<ul style="list-style-type: none"> • Solid surface price group B 	+\$440	Specify <i>with solid surface arm caps</i> and select solid surface color number.
<ul style="list-style-type: none"> • Solid surface price group C 	+\$464	Specify <i>with solid surface arm caps</i> and select solid surface color number.
<ul style="list-style-type: none"> • Solid surface price group D 	+\$488	Specify <i>with solid surface arm caps</i> and select solid surface color number.

Specification Information											
Base Prices											
•Style •Number	•Fabric •Price	•Fabric •Price	•Fabric •Price	•Fabric •Price	•Fabric •Price	•Fabric •Price	•Fabric •Price	•Fabric •Price	•Fabric •Price	•Fabric •Price	•COM •Price
	Group 1	Group 2	Group 3	Group 4	Group 5	Group 6	Group 7	Group 8	Group 9	Group 10	
SC6067EA	\$1155	\$1217	\$1273	\$1321	\$1371	\$1401	\$1453	\$1519	\$1615	\$1675	\$1217

Mitra Lounge Chairs

SIN 711.16

Tip: Different fabrics for the seat and back can be specified. If the fabrics are in different price groups, calculate list price by adding the two price groups together and dividing by two.

Standard Includes	Required to Specify
<ul style="list-style-type: none"> • Seat and back: fabric • Legs and base: maple wood • Arm caps: maple wood • Glides: brown plastic 	<ol style="list-style-type: none"> 1 Style number 2 Fabric color number for seat and back 3 Wood color number for legs, base, and arm caps 4 Options, if selected (see below) <p>▶ See <i>Surface Materials</i>, page 402.</p>

Options	Price	Required to Specify
Surface Materials Moisture barrier <ul style="list-style-type: none"> • Lounge chair • Loveseat • Sofa 	+\$ 96 +\$192 +\$288	Specify with <i>moisture barrier</i> . Specify with <i>moisture barrier</i> . Specify with <i>moisture barrier</i> .
Arm caps <ul style="list-style-type: none"> • Plastisol arm caps 	+\$102	Specify with <i>plastisol arm caps</i> and select plastic color number.

Specification Information



Lounge Chair



Loveseat

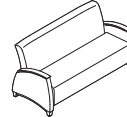

Sofa

Base Prices

Style Number	Fabric Price Group 1	Fabric Price Group 2	Fabric Price Group 3	Fabric Price Group 4	Fabric Price Group 5	Fabric Price Group 6	Fabric Price Group 7	Fabric Price Group 8	Fabric Price Group 9	Fabric Price Group 10	COM
--------------	----------------------	----------------------	----------------------	----------------------	----------------------	----------------------	----------------------	----------------------	----------------------	-----------------------	-----

Lounge Chair

SC6110L	\$1545	\$1701	\$1857	\$1979	\$2105	\$2199	\$2321	\$2507	\$2755	\$2911	\$1607
----------------	--------	--------	--------	--------	--------	--------	--------	--------	--------	--------	--------

Loveseat

SC6120L	\$1925	\$2119	\$2313	\$2463	\$2617	\$2735	\$2887	\$3119	\$3425	\$3615	\$1987
----------------	--------	--------	--------	--------	--------	--------	--------	--------	--------	--------	--------

Sofa

SC6130L	\$2321	\$2551	\$2779	\$2965	\$3145	\$3283	\$3467	\$3743	\$4109	\$4339	\$2383
----------------	--------	--------	--------	--------	--------	--------	--------	--------	--------	--------	--------

Mitra Tables

SIN 711.11

Freestanding Tables

Standard Includes	Required to Specify
<ul style="list-style-type: none"> • Table top: High-Pressure Laminate with 3 mm plastic edge • Curved legs: wood 	<ul style="list-style-type: none"> 1 Style number 2 Laminate color number for top 3 Wood color number for legs ▶ See <i>Surface Materials</i>, page 402.

Specification Information

• Dimensions			• Style	• Price
D	W	H	Number	



Oval Table

22"	32"	16"	SC6055	\$937

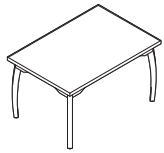

Rectangular Table

22"	32"	16"	SC6056	\$861



Square Table

22"	22"	16"	SC6057	\$786



Round Table

22" dia.		16"	SC6058	\$845

Freestanding Drum Tables

Standard Includes	Required to Specify
<ul style="list-style-type: none"> • Table top: High-Pressure Laminate • 3 mm plastic edge • Laminate-wrapped base 	<ul style="list-style-type: none"> 1 Style number 2 Laminate color number for top and base 3 Options, if selected (see below) ▶ See <i>Surface Materials</i>, page 402.

Options	Price	Required to Specify
Surface Materials <ul style="list-style-type: none"> • Veneer-wrapped base 	No cost	Specify <i>with veneer-wrapped base</i> and select laminate color for top and wood color for base.

Specification Information

• Dimensions			• Style	• Price
D	W	H	Number	
:	:	:	:	:
:	:	:	:	:

Oval table

22"	32"	18"	SC6155	\$1563
:	:	:	:	:

Rectangular table

22"	32"	18"	SC6156	\$1409
:	:	:	:	:

Square table

22"	22"	18"	SC6157	\$1294
:	:	:	:	:

Round table

22" dia.		18"	SC6158	\$1421
:	:	:	:	:

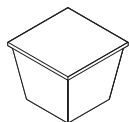
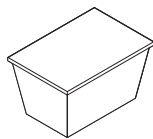

Neighbor

SIN 711.16

Wrap-Back Seating Units

Standard Includes	Required to Specify
-------------------	---------------------

- Base and legs: 4799 Platinum paint
- Seat, back, and armrest, if selected: fabric
- Adjustable glides on front legs: plastic
- Non-adjustable glides on back legs: steel

- 1 Style number
- 2 Fabric color number for seat, back, and armrest, if selected
- 3 Options, if selected (see below)
 - ▶ See *Surface Materials*, page 402.

Options	Price	Required to Specify
---------	-------	---------------------

Surface Materials	Moisture barrier	Price	Required to Specify
	• Moisture barrier	+\$96 per seat	Specify with moisture barrier.

Tip: Left and right determined when facing the unit.

Tip: Different fabrics for the seat and back can be specified. If the fabrics are in different price groups, calculate list price by adding the two price groups together and dividing by two.

Specification Information

Style Number	Base Prices										COM
	Fabric Price	Fabric Price	Fabric Price	Fabric Price	Fabric Price	Fabric Price	Fabric Price	Fabric Price	Fabric Price	Fabric Price	
	Group 1	Group 2	Group 3	Group 4	Group 5	Group 6	Group 7	Group 8	Group 9	Group 10	



Single-Seat, Left Wrap-Back Unit

HN5810HCL	\$2295	\$2437	\$2577	\$2691	\$2803	\$2885	\$2997	\$3169	\$3391	\$3531	\$2357

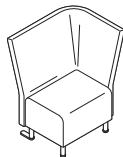

Single-Seat, Right Wrap-Back Unit

HN5810HCR	\$2295	\$2437	\$2577	\$2691	\$2803	\$2885	\$2997	\$3169	\$3391	\$3531	\$2357

Neighbor, continued

SIN 711.16

Armless Seating Units

Standard Includes	Required to Specify
-------------------	---------------------

- Base and legs: 4799 Platinum paint
- Seat and back: fabric
- Adjustable glides on front legs: plastic
- Non-adjustable glides on back legs: steel

- 1 Style number
- 2 Fabric color number for seat and back
- 3 Options, if selected (see below)
- ▶ See *Surface Materials*, page 402.

Tip: Different fabrics for the seat and back can be specified. If the fabrics are in different price groups, calculate list price by adding the two price groups together and dividing by two.

Options	Price	Required to Specify
---------	-------	---------------------

Surface Materials	Moisture barrier	
	• Moisture barrier	+\$96 per seat
		Specify with moisture barrier.

Specification Information											
Base Prices											
Style Number	Fabric Price	Fabric Price	Fabric Price	Fabric Price	Fabric Price	Fabric Price	Fabric Price	Fabric Price	Fabric Price	Fabric Price	COM
	Group 1	Group 2	Group 3	Group 4	Group 5	Group 6	Group 7	Group 8	Group 9	Group 10	

Single-Seat, Straight-Back Unit

Low-Back

HN5810LS	\$1942	\$2044	\$2154	\$2234	\$2314	\$2376	\$2460	\$2586	\$2752	\$2852	\$2004
-----------------	--------	--------	--------	--------	--------	--------	--------	--------	--------	--------	--------

High-Back

HN5810HS	\$2024	\$2134	\$2248	\$2336	\$2426	\$2490	\$2580	\$2712	\$2890	\$3004	\$2086
-----------------	--------	--------	--------	--------	--------	--------	--------	--------	--------	--------	--------

Two-Seat, Straight-Back Unit

Low-Back

HN5820LSS	\$3117	\$3329	\$3531	\$3697	\$3863	\$3987	\$4153	\$4403	\$4731	\$4939	\$3179
------------------	--------	--------	--------	--------	--------	--------	--------	--------	--------	--------	--------

High-Back

HN5820HSS	\$3198	\$3422	\$3642	\$3822	\$4000	\$4128	\$4308	\$4572	\$4930	\$5150	\$3260
------------------	--------	--------	--------	--------	--------	--------	--------	--------	--------	--------	--------

▶ **Specification Information, continued on next page**

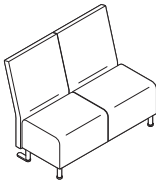
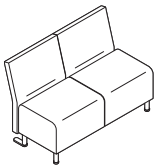
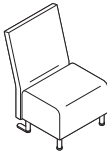
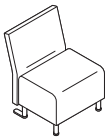

► Specification Information, continued from previous page

Specification Information

Style Number	Base Prices										COM
	Fabric Price	Fabric Price	Fabric Price	Fabric Price	Fabric Price	Fabric Price	Fabric Price	Fabric Price	Fabric Price	Fabric Price	
	Group 1	Group 2	Group 3	Group 4	Group 5	Group 6	Group 7	Group 8	Group 9	Group 10	

Two-Seat, Straight-Back Unit with 12" Center Armrest

Low-Back

HN5825LSAS	\$3574	\$3818	\$4064	\$4256	\$4452	\$4600	\$4796	\$5086	\$5476	\$5720	\$3636
-------------------	--------	--------	--------	--------	--------	--------	--------	--------	--------	--------	--------

High-Back

HN5825HSAS	\$3655	\$3915	\$4171	\$4381	\$4583	\$4741	\$4949	\$5259	\$5671	\$5931	\$3717
-------------------	--------	--------	--------	--------	--------	--------	--------	--------	--------	--------	--------

Three-Seat, Straight-Back Unit

Low-Back

HN5830LSSS	\$4291	\$4603	\$4915	\$5161	\$5411	\$5597	\$5843	\$6215	\$6715	\$7023	\$4353
-------------------	--------	--------	--------	--------	--------	--------	--------	--------	--------	--------	--------

High-Back

HN5830HSSS	\$4373	\$4707	\$5039	\$5303	\$5573	\$5771	\$6037	\$6437	\$6969	\$7305	\$4435
-------------------	--------	--------	--------	--------	--------	--------	--------	--------	--------	--------	--------

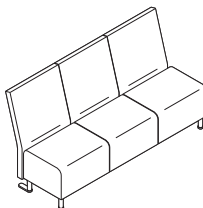
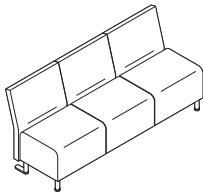
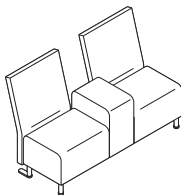
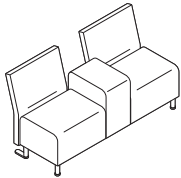

Neighbor, continued

SIN 711.16

Seating Units With 6" Upholstered Arms

Standard Includes	Required to Specify
<ul style="list-style-type: none"> • Base and legs: 4799 Platinum paint • Seat, back, and arms: fabric • Adjustable glides on front legs: plastic • Non-adjustable glides on back legs: steel 	<ul style="list-style-type: none"> 1 Style number 2 Fabric color number for seat and back 3 Options, if selected (see below) ▶ See <i>Surface Materials</i>, page 402.

Options	Price	Required to Specify
Surface Materials • Moisture barrier	+\$96 per seat	Specify with moisture barrier.

Tip: Different fabrics for the seat and back can be specified. If the fabrics are in different price groups, calculate list price by adding the two price groups together and dividing by two.

Specification Information											
Base Prices											
Style Number	Fabric Price Group 1	Fabric Price Group 2	Fabric Price Group 3	Fabric Price Group 4	Fabric Price Group 5	Fabric Price Group 6	Fabric Price Group 7	Fabric Price Group 8	Fabric Price Group 9	Fabric Price Group 10	COM

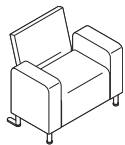

Single-Seat Unit with 6" Upholstered Arms

Low-Back

HN5811LS	\$2649	\$2799	\$2947	\$3063	\$3179	\$3273	\$3391	\$3567	\$3803	\$3949	\$2711
-----------------	--------	--------	--------	--------	--------	--------	--------	--------	--------	--------	--------

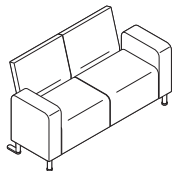

Two-Seat Unit with 6" Upholstered Arms

Low-Back

HN5821LSS	\$3823	\$4073	\$4329	\$4527	\$4729	\$4883	\$5079	\$5383	\$5783	\$6033	\$3885
------------------	--------	--------	--------	--------	--------	--------	--------	--------	--------	--------	--------

Benches

Standard Includes	Required to Specify
-------------------	---------------------

- Base and legs: 4799 Platinum paint
- Seat and armrest, if selected: fabric
- Adjustable glides on legs: plastic

- 1 Style number
- 2 Fabric color number for seat and armrest, if selected
- 3 Options, if selected (see below)
- ▶ See *Surface Materials*, page 402.

Options	Price	Required to Specify
---------	-------	---------------------

Surface Materials	Moisture barrier	+\$96 per seat	Specify with moisture barrier.
--------------------------	-------------------------	----------------	--------------------------------

Specification Information

Style Number	Base Prices										COM
	Fabric Price	Fabric Price	Fabric Price	Fabric Price	Fabric Price	Fabric Price	Fabric Price	Fabric Price	Fabric Price	Fabric Price	
	Group 1	Group 2	Group 3	Group 4	Group 5	Group 6	Group 7	Group 8	Group 9	Group 10	

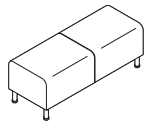

Two-Seat Bench

HN5820BB	\$2112	\$2201	\$2289	\$2361	\$2432	\$2486	\$2557	\$2663	\$2804	\$2893	\$2171
-----------------	--------	--------	--------	--------	--------	--------	--------	--------	--------	--------	--------

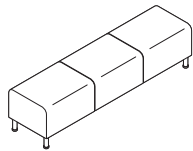

Three-Seat Bench

HN5830BBB	\$2805	\$2940	\$3072	\$3179	\$3285	\$3366	\$3473	\$3631	\$3843	\$3976	\$2864
------------------	--------	--------	--------	--------	--------	--------	--------	--------	--------	--------	--------

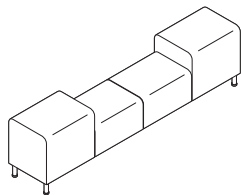

Two-Seat Bench with Two 24" Armrests

HN5840BBD	\$3507	\$3731	\$3949	\$4129	\$4307	\$4439	\$4615	\$4883	\$5239	\$5457	\$3537
------------------	--------	--------	--------	--------	--------	--------	--------	--------	--------	--------	--------

Neighbor, continued

SIN 711.16

Ottoman



Standard Includes	Required to Specify
-------------------	---------------------

- | | |
|---|--|
| <ul style="list-style-type: none"> Ottoman: fabric Legs: silver to match casters Non-locking casters: silver finish Glides on two legs of single ottoman: plastic | <ul style="list-style-type: none"> 1 Style number 2 Fabric color number for ottoman 3 Options, if selected (see below) ▶ See <i>Surface Materials</i>, page 402. |
|---|--|

Options	Price	Required to Specify
---------	-------	---------------------

Surface Materials	Moisture barrier • Moisture barrier	+\$96 Specify <i>with moisture barrier</i> .
--------------------------	---	---

Specification Information											
---------------------------	--	--	--	--	--	--	--	--	--	--	--

Style Number	Base Prices										COM
	Fabric Price	Fabric Price	Fabric Price	Fabric Price	Fabric Price	Fabric Price	Fabric Price	Fabric Price	Fabric Price	Fabric Price	
	Group 1	Group 2	Group 3	Group 4	Group 5	Group 6	Group 7	Group 8	Group 9	Group 10	
HN5801H	\$524	\$569	\$613	\$648	\$684	\$710	\$746	\$801	\$871	\$914	\$583

Ottoman

HN5801H	\$524	\$569	\$613	\$648	\$684	\$710	\$746	\$801	\$871	\$914	\$583
---------	-------	-------	-------	-------	-------	-------	-------	-------	-------	-------	-------

Corner Ganging Units

Tip: Corner ganging units are not freestanding. They must be ganged to a free-standing unit.

Standard Includes	Required to Specify
<ul style="list-style-type: none"> • Base and leg on bench, if selected: 4799 Platinum paint • Seat on bench, if selected: fabric • Upper-tier table surface, if selected: laminate • Edge on upper-tier surface: wood • Lower-tier table surface: Solid surface • Frame on table, if selected: powdercoat 4799 Platinum paint 	<ol style="list-style-type: none"> 1 Style number 2 Fabric color number for seat, if selected 3 Laminate color for upper-tier table surface, if selected 4 Wood color number for edge on upper-tier table surface 5 Solid surface color for lower-tier table surface: flint or linen 6 Options, if selected (see below) <p>▶ See <i>Surface Materials</i>, page 402.</p>

Options	Price	Required to Specify
Surface Materials • Moisture barrier	+\$96	Specify with moisture barrier.

Specification Information											
Base Prices											
Style Number	Fabric Price Group 1	Fabric Price Group 2	Fabric Price Group 3	Fabric Price Group 4	Fabric Price Group 5	Fabric Price Group 6	Fabric Price Group 7	Fabric Price Group 8	Fabric Price Group 9	Fabric Price Group 10	COM

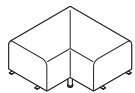

Corner Ganging Bench

HN5801CU	\$1297	\$1373	\$1447	\$1505	\$1564	\$1610	\$1669	\$1756	\$1874	\$1947	\$1356
-----------------	--------	--------	--------	--------	--------	--------	--------	--------	--------	--------	--------

Specification Information	
Price	
Style Number	Laminate



Corner Ganging Table

HN5801CT	\$1897
-----------------	--------

Outlook Jarrah

SIN 711.17

Single-Seat Chairs



SC2210

Tip: Different fabrics for the seat and back can be specified. If the fabrics are in different price groups, calculate list price by adding the two price groups together and dividing by two.

Standard Includes	Required to Specify
-------------------	---------------------

- Seat and back: fabric
- Arm caps, if selected: wood
- Oval legs: paint
- Glides: black

- 1 Style number
 - 2 Fabric color number for seat and back
 - 3 Wood color number for side stretcher and arm caps
 - 4 Paint color number for oval legs
 - 5 Options, if selected (see below)
- ▶ See *Surface Materials*, page 402.

Options	Price	Required to Specify
---------	-------	---------------------

Surface Materials	Moisture barrier • Moisture barrier	+\$ 96	Specify with moisture barrier.
	Plastisol arm cap • Arm cap	+\$ 51 per cap	Specify with plastisol arm caps and select plastic color number.
Higher Back	• 4" higher back	+\$ 42	Specify with 4" higher back.
	• 12½" higher back	+\$ 79	Specify with 12½" higher back.
Wallsaver Legs	• Wallsaver legs	+\$124	Specify with wallsaver legs.
Floor Glide Inserts	• Floor glide inserts	No cost	Specify with floor glide inserts.

Specification Information

Style Number	Base Prices										COM
	Fabric Price Group 1	Fabric Price Group 2	Fabric Price Group 3	Fabric Price Group 4	Fabric Price Group 5	Fabric Price Group 6	Fabric Price Group 7	Fabric Price Group 8	Fabric Price Group 9	Fabric Price Group 10	

Stand-Alone Arm Chair

SC2210	\$1044	\$1106	\$1162	\$1210	\$1260	\$1290	\$1342	\$1408	\$1504	\$1564	\$1076
---------------	--------	--------	--------	--------	--------	--------	--------	--------	--------	--------	--------

24"W Single-Seat Chair

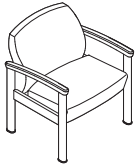

Tip: Different fabrics for the seat and back can be specified. If the fabrics are in different price groups, calculate list price by adding the two price groups together and dividing by two.

Standard Includes	Required to Specify
-------------------	---------------------

- Seat and back: fabric
- Arm caps: wood
- Oval legs: paint
- Glides: black

- 1 Style number
 - 2 Fabric color number for seat and back
 - 3 Wood color number for side stretcher and arm caps
 - 4 Paint color number for oval legs
 - 5 Options, if selected (see below)
- ▶ See *Surface Materials*, page 402.

Options	Price	Required to Specify
---------	-------	---------------------

Surface Materials	Moisture barrier	+\$ 96	Specify with moisture barrier.
	Plastisol arm cap	+\$102	Specify with plastisol arm caps and select plastic color number.
Higher Back	• 4" higher back	+\$ 42	Specify with 4" higher back.
	• 12½" higher back	+\$ 79	Specify with 12½" higher back.
Wallsaver Legs	• Wallsaver legs	+\$124	Specify with wallsaver legs.
Floor Glide Inserts	• Floor glide inserts	No cost	Specify with floor glide inserts.

Specification Information

Style Number	Base Prices										COM
	Fabric Price Group 1	Fabric Price Group 2	Fabric Price Group 3	Fabric Price Group 4	Fabric Price Group 5	Fabric Price Group 6	Fabric Price Group 7	Fabric Price Group 8	Fabric Price Group 9	Fabric Price Group 10	
	SC2210W	\$1149	\$1217	\$1283	\$1331	\$1385	\$1425	\$1477	\$1555	\$1659	

Outlook Jarrah, continued

SIN 711.17

Two-Seat Chairs

Standard Includes	Required to Specify
-------------------	---------------------

- Seat and back: fabric
- Arm caps: wood
- Oval legs: paint
- Glides: black

- 1 Style number
 - 2 Fabric color number for seat and back
 - 3 Wood color number for side stretcher and arm caps
 - 4 Paint color number for oval legs
 - 5 Options, if selected (see below)
- ▶ See *Surface Materials*, page 402.

Tip: Different fabrics for the seat and back can be specified. If the fabrics are in different price groups, calculate list price by adding the two price groups together and dividing by two.

Options	Price	Required to Specify
---------	-------	---------------------

Surface Materials	Moisture barrier	+\$192	Specify with moisture barrier.
	Plastisol arm cap		
	• Moisture barrier	+\$ 51 per cap	Specify with plastisol arm caps and select plastic color number.
Higher Back	• 4" higher back	+\$ 84	Specify with 4" higher back.
	• 12½" higher back	+\$158	Specify with 12½" higher back.
Wallsaver Legs	• Wallsaver legs	+\$124	Specify with wallsaver legs.
Floor Glide Inserts	• Floor glide inserts	No cost	Specify with floor glide inserts.

Specification Information

Stand Alone



SC2223

Base Prices

Style Number	Fabric Price Group 1	Fabric Price Group 2	Fabric Price Group 3	Fabric Price Group 4	Fabric Price Group 5	Fabric Price Group 6	Fabric Price Group 7	Fabric Price Group 8	Fabric Price Group 9	Fabric Price Group 10	COM
SC2223	\$1780	\$1898	\$2016	\$2112	\$2206	\$2278	\$2370	\$2514	\$2702	\$2820	\$1812

Two-Seat Stand-Alone Arm Chair with Center Arm

SC2223	\$1780	\$1898	\$2016	\$2112	\$2206	\$2278	\$2370	\$2514	\$2702	\$2820	\$1812
--------	--------	--------	--------	--------	--------	--------	--------	--------	--------	--------	--------

Stand Alone



SC2220

Two-Seat Stand-Alone Arm Chair without Center Arm

SC2220	\$1684	\$1802	\$1920	\$2016	\$2110	\$2182	\$2274	\$2418	\$2606	\$2724	\$1716
--------	--------	--------	--------	--------	--------	--------	--------	--------	--------	--------	--------

Three-Seat Chairs

Standard Includes	Required to Specify
-------------------	---------------------

- Seat and back: fabric
- Arm caps: wood
- Oval legs: paint
- Glides: black only

- 1 Style number
 - 2 Fabric color number for seat and back
 - 3 Wood color number for side stretcher and arm caps
 - 4 Paint color number for oval legs
 - 5 Options, if selected (see below)
- ▶ See *Surface Materials*, page 402.

Tip: Different fabrics for the seat and back can be specified. If the fabrics are in different price groups, calculate list price by adding the two price groups together and dividing by two.

Options	Price	Required to Specify
Surface Materials <ul style="list-style-type: none"> • Moisture barrier • Plastisol arm cap 	<ul style="list-style-type: none"> • Moisture barrier +\$288 • Arm cap +\$ 51 per cap 	<ul style="list-style-type: none"> Specify with <i>moisture barrier</i>. Specify with <i>plastisol arm caps</i> and select plastic color number.
Higher Back <ul style="list-style-type: none"> • 4" higher back • 12½" higher back 	<ul style="list-style-type: none"> • 4" higher back +\$126 • 12½" higher back +\$237 	<ul style="list-style-type: none"> Specify with <i>4" higher back</i>. Specify with <i>12½" higher back</i>.
Wallsaver Legs <ul style="list-style-type: none"> • Wallsaver legs 	<ul style="list-style-type: none"> • Wallsaver legs +\$124 	<ul style="list-style-type: none"> Specify with <i>wallsaver legs</i>.
Floor Glide Inserts <ul style="list-style-type: none"> • Floor glide inserts 	<ul style="list-style-type: none"> • Floor glide inserts No cost 	<ul style="list-style-type: none"> Specify with <i>floor glide inserts</i>.

Specification Information

Stand Alone

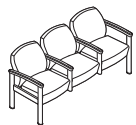

SC2233

Base Prices

Style Number	Fabric Price Group 1	Fabric Price Group 2	Fabric Price Group 3	Fabric Price Group 4	Fabric Price Group 5	Fabric Price Group 6	Fabric Price Group 7	Fabric Price Group 8	Fabric Price Group 9	Fabric Price Group 10	COM
--------------	----------------------	----------------------	----------------------	----------------------	----------------------	----------------------	----------------------	----------------------	----------------------	-----------------------	-----

Three-Seat Stand-Alone Arm Chair with Center Arms

SC2233	\$2544	\$2720	\$2898	\$3042	\$3184	\$3290	\$3432	\$3644	\$3926	\$4106	\$2576
---------------	--------	--------	--------	--------	--------	--------	--------	--------	--------	--------	--------

Stand Alone



SC2230

Three-Seat Stand-Alone Arm Chair without Center Arms

SC2230	\$2361	\$2537	\$2715	\$2859	\$3001	\$3107	\$3249	\$3461	\$3743	\$3923	\$2393
---------------	--------	--------	--------	--------	--------	--------	--------	--------	--------	--------	--------

Outlook Jarrah, continued

SIN 711.17

Bariatric Seating

Standard Includes	Required to Specify
-------------------	---------------------

- Seat and back: fabric
- Arm caps: wood
- Oval legs: paint
- Glides: black

- 1 Style number
 - 2 Fabric color number for seat and back
 - 3 Wood color number for side stretcher and arm caps
 - 4 Paint color number for oval legs
 - 5 Options, if selected (see below)
- ▶ See *Surface Materials*, page 402.

Tip: Different fabrics for the seat and back can be specified. If the fabrics are in different price groups, calculate list price by adding the two price groups together and dividing by two.

Options	Price	Required to Specify
---------	-------	---------------------

Surface Materials	Moisture barrier	+\$ 96	Specify with moisture barrier.
	Plastisol arm cap	+\$ 51 per cap	Specify with plastisol arm caps and select plastic color number.
Higher Back	• 4" higher back on 30"W bariatric chairs only	+\$ 42	Specify with 4" higher back.
Wallsaver Legs	• Wallsaver legs	+\$124	Specify with wallsaver legs.
Floor Glide Inserts	• Floor glide inserts	No cost	Specify with floor glide inserts.

Specification Information

Stand Alone



SC2260

Base Prices

Style Number	Fabric Price Group 1	Fabric Price Group 2	Fabric Price Group 3	Fabric Price Group 4	Fabric Price Group 5	Fabric Price Group 6	Fabric Price Group 7	Fabric Price Group 8	Fabric Price Group 9	Fabric Price Group 10	COM
--------------	----------------------	----------------------	----------------------	----------------------	----------------------	----------------------	----------------------	----------------------	----------------------	-----------------------	-----

30"W Stand-Alone Arm Chair

SC2260	\$1443	\$1533	\$1619	\$1689	\$1761	\$1815	\$1887	\$1995	\$2135	\$2223	\$1475
---------------	--------	--------	--------	--------	--------	--------	--------	--------	--------	--------	--------

Stand Alone



SC2265

40 1/2"W Stand-Alone Arm Chair

SC2265	\$2036	\$2154	\$2272	\$2368	\$2462	\$2534	\$2626	\$2770	\$2958	\$3076	\$2068
---------------	--------	--------	--------	--------	--------	--------	--------	--------	--------	--------	--------

High-Back Chairs

Standard Includes	Required to Specify
-------------------	---------------------

- Seat and back: fabric
- Arm caps: wood
- Oval legs: paint
- Glides: black

- 1 Style number
 - 2 Fabric color number for seat and back
 - 3 Wood color number for side stretcher and arm caps
 - 4 Paint color number for oval legs
 - 5 Options, if selected (see below)
- ▶ See *Surface Materials*, page 402.

Tip: Different fabrics for the seat and back can be specified. If the fabrics are in different price groups, calculate list price by adding the two price groups together and dividing by two.

Options	Price	Required to Specify
Surface Materials		
• Moisture barrier	+\$ 96	Specify with moisture barrier.
• Plastisol arm cap	+\$102	Specify with plastisol arm caps and select plastic color number.
• Wallsaver Legs	+\$124	Specify with wallsaver legs.
• Floor Glide Inserts	No cost	Specify with floor glide inserts.

Specification Information

Style Number	Base Prices										COM
	Fabric Price Group 1	Fabric Price Group 2	Fabric Price Group 3	Fabric Price Group 4	Fabric Price Group 5	Fabric Price Group 6	Fabric Price Group 7	Fabric Price Group 8	Fabric Price Group 9	Fabric Price Group 10	

High-Back Chair with Flared Back

SC2283	\$1139	\$1215	\$1289	\$1351	\$1407	\$1451	\$1509	\$1597	\$1717	\$1791	\$1171
---------------	--------	--------	--------	--------	--------	--------	--------	--------	--------	--------	--------

High-Back Chair with Tapered Back

SC2285	\$1139	\$1215	\$1289	\$1351	\$1407	\$1451	\$1509	\$1597	\$1717	\$1791	\$1171
---------------	--------	--------	--------	--------	--------	--------	--------	--------	--------	--------	--------

High-Back Chair with Straight Back

SC2286	\$1139	\$1221	\$1301	\$1369	\$1435	\$1483	\$1547	\$1647	\$1777	\$1855	\$1171
---------------	--------	--------	--------	--------	--------	--------	--------	--------	--------	--------	--------

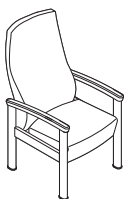
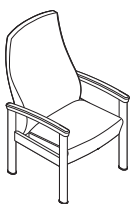
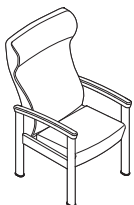

Outlook Jarrah, continued

SIN 711.17

Bariatric High-Back Chair

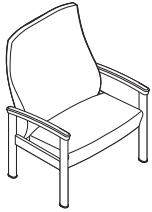

Tip: Different fabrics for the seat and back can be specified. If the fabrics are in different price groups, calculate list price by adding the two price groups together and dividing by two.

Standard Includes	Required to Specify
-------------------	---------------------

- Seat and back: fabric
- Arm caps: wood
- Oval legs: paint
- Glides: black

- 1 Style number
 - 2 Fabric color number for seat and back
 - 3 Wood color number for side stretcher and arm caps
 - 4 Paint color number for oval legs
 - 5 Options, if selected (see below)
- ▶ See *Surface Materials*, page 402.

Options	Price	Required to Specify
---------	-------	---------------------

Surface Materials	Moisture barrier		
	• Moisture barrier	+\$ 96	Specify with moisture barrier.
	Plastisol arm cap		
	• Arm cap	+\$102	Specify with plastisol arm caps and select plastic color number.
Wallsaver Legs	• Wallsaver legs	+\$124	Specify with wallsaver legs.
Floor Glide Inserts	• Floor glide inserts	No cost	Specify with floor glide inserts.

Specification Information

Style Number	Base Prices										COM
	Fabric Price Group 1	Fabric Price Group 2	Fabric Price Group 3	Fabric Price Group 4	Fabric Price Group 5	Fabric Price Group 6	Fabric Price Group 7	Fabric Price Group 8	Fabric Price Group 9	Fabric Price Group 10	
	Price	Price	Price	Price	Price	Price	Price	Price	Price	Price	
SC2295	\$1583	\$1685	\$1795	\$1875	\$1955	\$2017	\$2101	\$2227	\$2393	\$2493	\$1615

Easy Access Chair

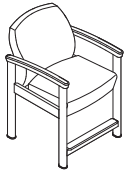

Tip: Different fabrics for the seat and back can be specified. If the fabrics are in different price groups, calculate list price by adding the two price groups together and dividing by two.

Standard Includes	Required to Specify
-------------------	---------------------

- Seat and back: fabric
- Arm caps: wood
- Oval legs: black paint
- Glides: black only

- 1 Style number
 - 2 Fabric color number for seat and back
 - 3 Wood color number for side stretcher and arm caps
 - 4 Paint color number for oval legs
 - 5 Options, if selected (see below)
- ▶ See *Surface Materials*, page 402.

Options	Price	Required to Specify
---------	-------	---------------------

Surface Materials	Moisture barrier • Moisture barrier	+\$ 96	Specify with <i>moisture barrier</i> .
	Plastisol arm cap • Arm cap	+\$102	Specify with <i>plastisol arm caps</i> and select plastic color number.
Floor Glide Inserts	• Floor glide inserts	No cost	Specify with <i>floor glide inserts</i> .

Specification Information

Style Number	Base Prices										COM
	Fabric Price	Fabric Price	Fabric Price	Fabric Price	Fabric Price	Fabric Price	Fabric Price	Fabric Price	Fabric Price	Fabric Price	
	Group 1	Group 2	Group 3	Group 4	Group 5	Group 6	Group 7	Group 8	Group 9	Group 10	
SC2207	\$1304	\$1366	\$1422	\$1470	\$1520	\$1550	\$1602	\$1668	\$1764	\$1824	\$1336

Outlook Sequoia

SIN 711.17

Single-Seat Chairs

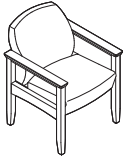

Tip: Different fabrics for the seat and back can be specified. If the fabrics are in different price groups, calculate list price by adding the two price groups together and dividing by two.

Standard Includes	Required to Specify
-------------------	---------------------

- Seat and back: fabric
- Arm and leg assemblies: wood
- Glides: brown

- 1 Style number
 - 2 Fabric color number for seat and back
 - 3 Wood color number for arm and leg assemblies
 - 4 Options, if selected (see below)
- ▶ See *Surface Materials*, page 402.

Options	Price	Required to Specify
---------	-------	---------------------

Surface Materials	Moisture barrier	+\$96	Specify with <i>moisture barrier</i> .
	Plastisol arm cap		
	• Arm cap	+\$51 per cap	Specify with <i>plastisol arm caps</i> and select plastic color number.
Higher Back	• 4" higher back	+\$42	Specify with <i>4" higher back</i> .
	• 12½" higher back	+\$79	Specify with <i>12½" higher back</i> .
Perimeter Guard	• Perimeter guard	+\$27 per leg	Specify with <i>perimeter guard</i> and designate front and/or back.

Specification Information

Base Prices

Style Number	Fabric Price Group 1	Fabric Price Group 2	Fabric Price Group 3	Fabric Price Group 4	Fabric Price Group 5	Fabric Price Group 6	Fabric Price Group 7	Fabric Price Group 8	Fabric Price Group 9	Fabric Price Group 10	COM
--------------	----------------------	----------------------	----------------------	----------------------	----------------------	----------------------	----------------------	----------------------	----------------------	-----------------------	-----

Stand-Alone Arm Chair

SC2510	\$1047	\$1109	\$1165	\$1213	\$1263	\$1293	\$1345	\$1411	\$1507	\$1567	\$1079
---------------	--------	--------	--------	--------	--------	--------	--------	--------	--------	--------	--------

24"W Single-Seat Chair

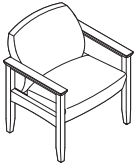

Tip: Different fabrics for the seat and back can be specified. If the fabrics are in different price groups, calculate list price by adding the two price groups together and dividing by two.

Standard Includes	Required to Specify
-------------------	---------------------

- Seat and back: fabric
- Arm and leg assemblies: wood
- Glides: brown

- 1 Style number
 - 2 Fabric color number for seat and back
 - 3 Wood color number for arm and leg assemblies
 - 4 Options, if selected (see below)
- ▶ See *Surface Materials*, page 402.

Options	Price	Required to Specify
---------	-------	---------------------

Surface Materials	Moisture barrier	+\$ 96	Specify with moisture barrier.
	Plastisol arm cap	+\$102	Specify with plastisol arm caps and select plastic color number.
Higher Back	• 4" higher back	+\$ 42	Specify with 4" higher back.
	• 12½" higher back	+\$ 79	Specify with 12½" higher back.
Perimeter Guard	• Perimeter guard	+\$ 54 per set	Specify with perimeter guard and designate front and/or back.

Specification Information

Style Number	Base Prices										COM
	Fabric Price	Fabric Price	Fabric Price	Fabric Price	Fabric Price	Fabric Price	Fabric Price	Fabric Price	Fabric Price	Fabric Price	
	Group 1	Group 2	Group 3	Group 4	Group 5	Group 6	Group 7	Group 8	Group 9	Group 10	
SC2510W	\$1152	\$1228	\$1302	\$1364	\$1420	\$1464	\$1522	\$1610	\$1730	\$1804	\$1184

Outlook Sequoia, continued

SIN 711.17

Two-Seat Chairs

Standard Includes	Required to Specify
<ul style="list-style-type: none"> • Seat and back: fabric • Arm and leg assemblies: wood • Glides: brown 	<ol style="list-style-type: none"> 1 Style number 2 Fabric color number for seat and back 3 Wood color number for arm and leg assemblies 4 Options, if selected (see below) <p>▶ See <i>Surface Materials</i>, page 402.</p>

Tip: Different fabrics for the seat and back can be specified. If the fabrics are in different price groups, calculate list price by adding the two price groups together and dividing by two.

Options	Price	Required to Specify
Surface Materials <ul style="list-style-type: none"> • Moisture barrier • Moisture barrier 	+\$192	Specify with moisture barrier.
<ul style="list-style-type: none"> • Plastisol arm cap • Arm cap 	+\$ 51 per cap	Specify with plastisol arm caps and select plastic color number.
Higher Back <ul style="list-style-type: none"> • 4" higher back • 12½" higher back 	+\$ 84 +\$158	Specify with 4" higher back. Specify with 12½" higher back.
Perimeter Guard <ul style="list-style-type: none"> • Perimeter guard 	+\$ 27 per leg	Specify with perimeter guard and designate front and/or back.

Specification Information

Stand Alone



SC2523

Base Prices

Style Number	Fabric Price Group 1	Fabric Price Group 2	Fabric Price Group 3	Fabric Price Group 4	Fabric Price Group 5	Fabric Price Group 6	Fabric Price Group 7	Fabric Price Group 8	Fabric Price Group 9	Fabric Price Group 10	COM
SC2523	\$1784	\$1902	\$2020	\$2116	\$2210	\$2282	\$2374	\$2518	\$2706	\$2824	\$1816

Two-Seat Stand-Alone Arm Chair with Center Arm

SC2523	\$1784	\$1902	\$2020	\$2116	\$2210	\$2282	\$2374	\$2518	\$2706	\$2824	\$1816
--------	--------	--------	--------	--------	--------	--------	--------	--------	--------	--------	--------

Stand Alone



SC2520

Two-Seat Stand-Alone Arm Chair without Center Arm

SC2520	\$1694	\$1812	\$1930	\$2026	\$2120	\$2192	\$2284	\$2428	\$2616	\$2734	\$1726
--------	--------	--------	--------	--------	--------	--------	--------	--------	--------	--------	--------

Three-Seat Chairs

Standard Includes	Required to Specify
<ul style="list-style-type: none"> • Seat and back: fabric • Arm and leg assemblies: wood • Glides: brown only 	<ol style="list-style-type: none"> 1 Style number 2 Fabric color number for seat and back 3 Wood color number for arm and leg assemblies 4 Options, if selected (see below) <p>▶ See <i>Surface Materials</i>, page 402.</p>

Tip: Different fabrics for the seat and back can be specified. If the fabrics are in different price groups, calculate list price by adding the two price groups together and dividing by two.

Options	Price	Required to Specify
Surface Materials <ul style="list-style-type: none"> • Moisture barrier • Plastisol arm cap 	<ul style="list-style-type: none"> • Moisture barrier +\$288 • Arm cap +\$ 51 per cap 	<ul style="list-style-type: none"> Specify with <i>moisture barrier</i>. Specify with <i>plastisol arm caps</i> and select plastic color number.
Higher Back <ul style="list-style-type: none"> • 4" higher back • 12½" higher back 	<ul style="list-style-type: none"> • 4" higher back +\$126 • 12½" higher back +\$237 	<ul style="list-style-type: none"> Specify with <i>4" higher back</i>. Specify with <i>12½" higher back</i>.
Perimeter Guard <ul style="list-style-type: none"> • Perimeter guard 	<ul style="list-style-type: none"> • Perimeter guard +\$ 27 per leg 	<ul style="list-style-type: none"> Specify with <i>perimeter guard</i> and designate front and/or back.

Specification Information

Stand Alone

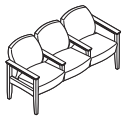

SC2533

Base Prices

Style Number	Fabric Price Group 1	Fabric Price Group 2	Fabric Price Group 3	Fabric Price Group 4	Fabric Price Group 5	Fabric Price Group 6	Fabric Price Group 7	Fabric Price Group 8	Fabric Price Group 9	Fabric Price Group 10	COM

Three-Seat Stand-Alone Arm Chair with Center Arms

SC2533	\$2554	\$2730	\$2908	\$3052	\$3194	\$3300	\$3442	\$3654	\$3936	\$4116	\$2586

Stand Alone

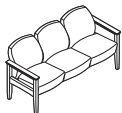

SC2530

Three-Seat Stand-Alone Arm Chair without Center Arms

SC2530	\$2370	\$2546	\$2724	\$2868	\$3010	\$3116	\$3258	\$3470	\$3752	\$3932	\$2402

Outlook Sequoia, continued

SIN 711.17

Bariatric Seating

Standard Includes	Required to Specify
-------------------	---------------------

- Seat and back: fabric
- Arm and leg assemblies: wood
- Glides: brown

- 1 Style number
 - 2 Fabric color number for seat and back
 - 3 Wood color number for arm and leg assemblies
 - 4 Options, if selected (see below)
- ▶ See *Surface Materials*, page 402.

Tip: Different fabrics for the seat and back can be specified. If the fabrics are in different price groups, calculate list price by adding the two price groups together and dividing by two.

Options	Price	Required to Specify
---------	-------	---------------------

Surface Materials	Moisture barrier	+\$96	Specify with <i>moisture barrier</i> .
	Plastisol arm cap		
	• Moisture barrier		
	• Arm cap	+\$51 per cap	Specify with <i>plastisol arm caps</i> and select plastic color number.
Higher Back	• 4" higher back on 30"W bariatric chairs only	+\$42	Specify with <i>4" higher back</i> .
Perimeter Guard	• Perimeter guard	+\$27 per leg	Specify with <i>perimeter guard</i> and designate front and/or back.

Specification Information

Stand Alone



SC2560

Base Prices

• Style Number	• Fabric Price Group 1	• Fabric Price Group 2	• Fabric Price Group 3	• Fabric Price Group 4	• Fabric Price Group 5	• Fabric Price Group 6	• Fabric Price Group 7	• Fabric Price Group 8	• Fabric Price Group 9	• Fabric Price Group 10	• COM
----------------	------------------------	------------------------	------------------------	------------------------	------------------------	------------------------	------------------------	------------------------	------------------------	-------------------------	-------

30"W Stand-Alone Arm Chair

SC2560	\$1402	\$1492	\$1578	\$1648	\$1720	\$1774	\$1846	\$1954	\$2094	\$2182	\$1434
---------------	--------	--------	--------	--------	--------	--------	--------	--------	--------	--------	--------

Stand Alone



SC2565

40 1/2"W Stand-Alone Arm Chair

SC2565	\$2006	\$2124	\$2242	\$2338	\$2432	\$2504	\$2596	\$2740	\$2928	\$3046	\$2038
---------------	--------	--------	--------	--------	--------	--------	--------	--------	--------	--------	--------

High-Back Chairs

Standard Includes	Required to Specify
-------------------	---------------------

- Seat and back: fabric
- Arm and leg assemblies: wood
- Glides: brown

- 1 Style number
 - 2 Fabric color number for seat and back
 - 3 Wood color number for arm and leg assemblies
 - 4 Options, if selected (see below)
- ▶ See *Surface Materials*, page 402.

Tip: Different fabrics for the seat and back can be specified. If the fabrics are in different price groups, calculate list price by adding the two price groups together and dividing by two.

Options	Price	Required to Specify
---------	-------	---------------------

Surface Materials	Moisture barrier		
	• Moisture barrier	+\$ 96	Specify with moisture barrier.
	Plastisol arm cap		
	• Arm cap	+\$102	Specify with plastisol arm caps and select plastic color number.
Perimeter Guard	• Perimeter guard	+\$ 54 per set	Specify with perimeter guard and designate front and/or back.

Specification Information

• Style Number	• Base Prices										• COM
	• Fabric Price	• Fabric Price	• Fabric Price	• Fabric Price	• Fabric Price	• Fabric Price	• Fabric Price	• Fabric Price	• Fabric Price	• Fabric Price	
	• Group 1	• Group 2	• Group 3	• Group 4	• Group 5	• Group 6	• Group 7	• Group 8	• Group 9	• Group 10	

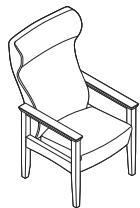

High-Back Chair with Flared Back

SC2583	\$1111	\$1187	\$1261	\$1323	\$1379	\$1423	\$1481	\$1569	\$1689	\$1763	\$1143
---------------	--------	--------	--------	--------	--------	--------	--------	--------	--------	--------	--------

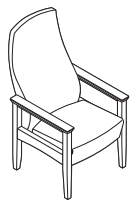

High-Back Chair with Tapered Back

SC2585	\$1111	\$1187	\$1261	\$1323	\$1379	\$1423	\$1481	\$1569	\$1689	\$1763	\$1143
---------------	--------	--------	--------	--------	--------	--------	--------	--------	--------	--------	--------

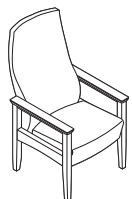

High-Back Chair with Straight Back

SC2586	\$1111	\$1193	\$1273	\$1341	\$1407	\$1455	\$1519	\$1619	\$1749	\$1827	\$1143
---------------	--------	--------	--------	--------	--------	--------	--------	--------	--------	--------	--------

Outlook Sequoia, continued

SIN 711.17

Bariatric High-Back Chair

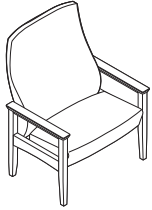

Tip: Different fabrics for the seat and back can be specified. If the fabrics are in different price groups, calculate list price by adding the two price groups together and dividing by two.

Standard Includes	Required to Specify
-------------------	---------------------

- Seat and back: fabric
- Arm and leg assemblies: wood
- Glides: brown

- 1 Style number
 - 2 Fabric color number for seat and back
 - 3 Wood color number for arm and leg assemblies
 - 4 Options, if selected (see below)
- ▶ See *Surface Materials*, page 402.

Options	Price	Required to Specify
---------	-------	---------------------

Surface Materials

Moisture barrier

- Moisture barrier +\$ 96

Specify with *moisture barrier*.

Plastisol arm cap

- Arm cap +\$102

Specify with *plastisol arm caps* and select plastic color number.

Perimeter Guard

- Perimeter guard +\$ 54 per set

Specify with *perimeter guard* and designate front and/or back.

Specification Information

Base Prices

•Style •Number	•Fabric •Price •Group 1	•Fabric •Price •Group 2	•Fabric •Price •Group 3	•Fabric •Price •Group 4	•Fabric •Price •Group 5	•Fabric •Price •Group 6	•Fabric •Price •Group 7	•Fabric •Price •Group 8	•Fabric •Price •Group 9	•Fabric •Price •Group 10	•COM
SC2595	\$1567	\$1669	\$1779	\$1859	\$1939	\$2001	\$2085	\$2211	\$2377	\$2477	\$1599

Easy Access Chair

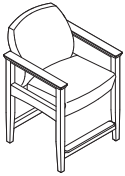

Tip: Different fabrics for the seat and back can be specified. If the fabrics are in different price groups, calculate list price by adding the two price groups together and dividing by two.

Standard Includes	Required to Specify
-------------------	---------------------

- Seat and back: fabric
- Arm and leg assemblies: wood
- Glides: black only

- 1 Style number
 - 2 Fabric color number for seat and back
 - 3 Wood color number for arm and leg assemblies
 - 4 Options, if selected (see below)
- ▶ See *Surface Materials*, page 402.

Options	Price	Required to Specify
---------	-------	---------------------

Surface Materials	Moisture barrier	• Moisture barrier	+\$ 96	Specify with <i>moisture barrier</i> .
	Plastisol arm cap	• Arm cap	+\$102	Specify with <i>plastisol arm caps</i> and select plastic color number.
Perimeter Guard	• Perimeter guard	+\$54 per set	Specify with <i>perimeter guard</i> and designate front and/or back.	

Specification Information

Style Number	Base Prices										COM
	Fabric Price	Fabric Price	Fabric Price	Fabric Price	Fabric Price	Fabric Price	Fabric Price	Fabric Price	Fabric Price	Fabric Price	
	Group 1	Group 2	Group 3	Group 4	Group 5	Group 6	Group 7	Group 8	Group 9	Group 10	
SC2507	\$1400	\$1462	\$1518	\$1566	\$1616	\$1646	\$1698	\$1764	\$1860	\$1920	\$1432

Outlook Tables

SIN 711.11/711.17

Freestanding Tables with Wood Edge

Standard Includes	Required to Specify
<ul style="list-style-type: none"> • Top: High-Pressure Laminate • Edge: maple wood to match top • Legs: wood or paint (if metal leg selected) • Attachment brackets: black only • Glides: black nylon 	<ul style="list-style-type: none"> 1 Style number 2 Laminate color number for top 3 Paint color for legs, if metal leg selected ▶ See <i>Surface Materials</i>, page 402.

Specification Information				
Dimensions			Style	Price
D	W	H	Number	

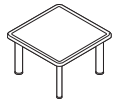

Square Tables with Metal Legs

26"	26"	16"	HTM262616W	\$990
26"	26"	21"	HTM262621W	\$990

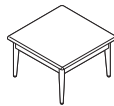

Square Tables with Tapered Legs

18"	18"	21"	HTT181821W	\$710
26"	26"	21"	HTT262621W	\$797



Rectangular Table with Metal Legs

20"	24"	21"	HTM242021W	\$789
-----	-----	-----	-------------------	-------



Rectangular Table with Tapered Legs

20"	24"	21"	HTT242021W	\$713
-----	-----	-----	-------------------	-------



Round Table with Tapered Legs

24" dia	21"	HTT24R21W	\$793
---------	-----	------------------	-------

Sieste

SIN 711.11/711.16/711.17

Lounge Seating

Seating

Standard Includes	Required to Specify
<ul style="list-style-type: none"> • Legs: maple wood • Seat, back, and closed arms: fabric • Nylon glides 	<ul style="list-style-type: none"> 1 Style number 2 Wood color for legs 3 Fabric color number for seat and back 4 Options, if selected (see below) ▶ See <i>Surface Materials</i>, page 402.

Tip: Different fabrics for the seat and back can be specified. If the fabrics are in different price groups, calculate list price by adding the two price groups together and dividing by two.

Tip: Wood arm cap finish color will match leg color selection.

Options	Price	Required to Specify
Surface Materials <ul style="list-style-type: none"> • Lounge chair • Loveseat • Sofa 	<ul style="list-style-type: none"> +\$ 96 +\$192 +\$288 	<ul style="list-style-type: none"> Specify with <i>moisture barrier</i>. Specify with <i>moisture barrier</i>. Specify with <i>moisture barrier</i>.
Arm caps <ul style="list-style-type: none"> • Wood arm caps • Platisol arm caps: black only 	<ul style="list-style-type: none"> +\$240 +\$292 	<ul style="list-style-type: none"> Specify with <i>wood arm caps</i>. Specify with <i>platisol arm caps</i>.

Specification Information											
Base Prices											
Style Number	Fabric Price Group 1	Fabric Price Group 2	Fabric Price Group 3	Fabric Price Group 4	Fabric Price Group 5	Fabric Price Group 6	Fabric Price Group 7	Fabric Price Group 8	Fabric Price Group 9	Fabric Price Group 10	COM

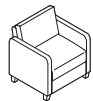

Lounge Chair

HN240	\$2012	\$2154	\$2294	\$2408	\$2520	\$2602	\$2714	\$2886	\$3108	\$3248	\$2074
--------------	--------	--------	--------	--------	--------	--------	--------	--------	--------	--------	--------

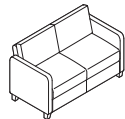

Loveseat

HN2402	\$3007	\$3207	\$3409	\$3567	\$3727	\$3847	\$4005	\$4245	\$4567	\$4763	\$3069
---------------	--------	--------	--------	--------	--------	--------	--------	--------	--------	--------	--------

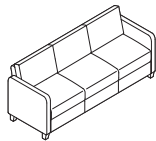

Sofa

HN2403	\$3778	\$4046	\$4308	\$4524	\$4736	\$4898	\$5110	\$5430	\$5854	\$6120	\$3840
---------------	--------	--------	--------	--------	--------	--------	--------	--------	--------	--------	--------

Sieste, continued

SIN 711.11/711.16/711.17

Bariatric Seating

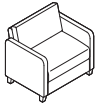

Standard Includes	Required to Specify
-------------------	---------------------

- Legs: maple wood
- Seat, back, and closed arms: fabric
- Nylon glides

- 1 Style number
- 2 Wood color for legs
- 3 Fabric color number for seat and back
- 4 Options, if selected (see below)
- ▶ See *Surface Materials*, page 402.

Tip: Different fabrics for the seat and back can be specified. If the fabrics are in different price groups, calculate list price by adding the two price groups together and dividing by two.

Options	Price	Required to Specify
---------	-------	---------------------

Surface Materials

Moisture barrier

- Moisture barrier +\$ 96

Specify with moisture barrier.

Arm caps

- Wood arm caps +\$240
- Platisol arm caps: black only +\$292

Specify with wood arm caps.
Specify with platisol arm caps.

Specification Information

Base Prices

Style Number	Fabric Price Group 1	Fabric Price Group 2	Fabric Price Group 3	Fabric Price Group 4	Fabric Price Group 5	Fabric Price Group 6	Fabric Price Group 7	Fabric Price Group 8	Fabric Price Group 9	Fabric Price Group 10	COM
--------------	----------------------	----------------------	----------------------	----------------------	----------------------	----------------------	----------------------	----------------------	----------------------	-----------------------	-----

Single-Seat Chair

HN240B30	\$2836	\$2992	\$3148	\$3270	\$3396	\$3490	\$3612	\$3798	\$4046	\$4202	\$2898
----------	--------	--------	--------	--------	--------	--------	--------	--------	--------	--------	--------

Tables



Standard Includes	Required to Specify
-------------------	---------------------

- Frame and legs: maple wood
- Top: laminate
- Nylon glides on legs, if selected

- 1 Style number
 - 2 Wood color for frame and legs
 - 3 Laminate color number for top
 - 4 Options, if selected (see below)
- ▶ See *Surface Materials*, page 402.

Options	Price	Required to Specify
---------	-------	---------------------

Top	• Wood	+\$67	Specify <i>with wood top</i> and select wood color number.
------------	--------	-------	--

Specification Information				
Dimensions			Style	Base
D	W	H	Number	Price

Freestanding Square Tables

26"	26"	18"	HN24T1L	\$1173
26"	26"	23"	HN24T1H	\$1213

Tava

SIN 711.16

Guest Seating

Standard Includes	Required to Specify
<ul style="list-style-type: none"> • Seat and back: fabric • Arm panels, if selected: fabric • Leg and arm assemblies: wood • Glides: black 	<ul style="list-style-type: none"> 1 Style number 2 Fabric color number for back and seat 3 Wood color number for leg and arm assemblies 4 Options, if selected (see below) ▶ See <i>Surface Materials</i>, page 402.

Tip: Different fabrics for the seat and back can be specified. If the fabrics are in different price groups, calculate list price by adding the two price groups together and dividing by two.

Options	Price	Required to Specify
Surface Materials		
• Moisture barrier		
• Single-seat chair	+\$ 96	Specify with moisture barrier.
• Two-seat chair	+\$192	Specify with moisture barrier.
• Three-seat chair	+\$288	Specify with moisture barrier.
• Arm caps		
• Plastic arm caps: black only	+\$ 74 per cap	Specify with plastic arm caps.

Specification Information											
Base Prices											
Style Number	Fabric Price Group 1	Fabric Price Group 2	Fabric Price Group 3	Fabric Price Group 4	Fabric Price Group 5	Fabric Price Group 6	Fabric Price Group 7	Fabric Price Group 8	Fabric Price Group 9	Fabric Price Group 10	COM

Single-Seat Guest Chair

Open Arm

HS1C1	\$1702	\$1760	\$1804	\$1848	\$1888	\$1924	\$1962	\$2024	\$2110	\$2158	\$1764
--------------	--------	--------	--------	--------	--------	--------	--------	--------	--------	--------	--------

Closed Arm

HS1CU1	\$2047	\$2131	\$2209	\$2277	\$2343	\$2393	\$2459	\$2557	\$2687	\$2763	\$2109
---------------	--------	--------	--------	--------	--------	--------	--------	--------	--------	--------	--------

Two-Seat Guest Chair without Center Arm

Open Arm

HS1C2	\$2556	\$2656	\$2750	\$2826	\$2904	\$2966	\$3040	\$3154	\$3310	\$3402	\$2618
--------------	--------	--------	--------	--------	--------	--------	--------	--------	--------	--------	--------

Closed Arm

HS1CU2	\$2901	\$3025	\$3137	\$3233	\$3327	\$3403	\$3495	\$3639	\$3827	\$3941	\$2963
---------------	--------	--------	--------	--------	--------	--------	--------	--------	--------	--------	--------

▶ **Specification Information, continued on next page**

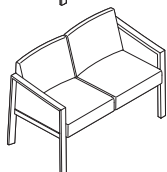
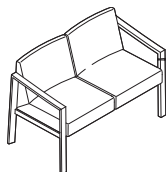
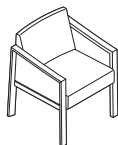
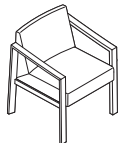

► Specification Information, continued from previous page

Specification Information

Style Number	Base Prices										COM
	Fabric Price Group 1	Fabric Price Group 2	Fabric Price Group 3	Fabric Price Group 4	Fabric Price Group 5	Fabric Price Group 6	Fabric Price Group 7	Fabric Price Group 8	Fabric Price Group 9	Fabric Price Group 10	

Two-Seat Guest Chair with Center Arm

Open Arm

HS1CA2	\$2977	\$3077	\$3171	\$3247	\$3325	\$3387	\$3461	\$3575	\$3731	\$3823	\$3039
---------------	--------	--------	--------	--------	--------	--------	--------	--------	--------	--------	--------

Closed Arm

HS1CAU2	\$3494	\$3634	\$3762	\$3866	\$3974	\$4060	\$4164	\$4326	\$4536	\$4664	\$3556
----------------	--------	--------	--------	--------	--------	--------	--------	--------	--------	--------	--------

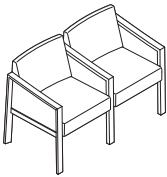
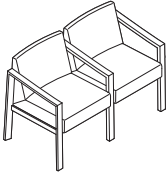

Three-Seat Guest Chair with Center Arm

Open Arm

HS1CA3	\$4251	\$4391	\$4519	\$4623	\$4731	\$4817	\$4921	\$5083	\$5293	\$5421	\$4313
---------------	--------	--------	--------	--------	--------	--------	--------	--------	--------	--------	--------

Closed Arm

HS1CAU3	\$4942	\$5118	\$5284	\$5420	\$5552	\$5666	\$5800	\$6006	\$6278	\$6440	\$5004
----------------	--------	--------	--------	--------	--------	--------	--------	--------	--------	--------	--------

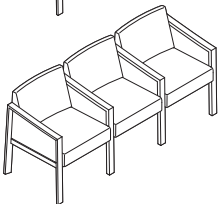
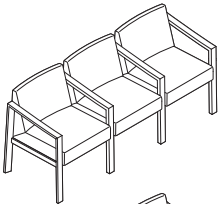

Seating

SIN 711.16

Guest Bariatric Seating

Standard Includes	Required to Specify
<ul style="list-style-type: none"> • Seat and back: fabric • Arm panels, if selected: fabric • Leg and arm assemblies: wood • Glides: black 	<ul style="list-style-type: none"> 1 Style number 2 Fabric color number for back and seat 3 Wood color number for leg and arm assemblies 4 Options, if selected (see below) ▶ See <i>Surface Materials</i>, page 402.

Tip: Different fabrics for the seat and back can be specified. If the fabrics are in different price groups, calculate list price by adding the two price groups together and dividing by two.

Options	Price	Required to Specify
Surface Materials		
• Moisture barrier	+\$ 96	Specify with moisture barrier.
Arm caps		
• Plastic arm caps: black only	+\$148	Specify with plastic arm caps.

Specification Information											
Base Prices											
Style Number	Fabric Price Group 1	Fabric Price Group 2	Fabric Price Group 3	Fabric Price Group 4	Fabric Price Group 5	Fabric Price Group 6	Fabric Price Group 7	Fabric Price Group 8	Fabric Price Group 9	Fabric Price Group 10	COM

Guest Chair 30" Wide Bariatric

Open Arm

HS1C130	\$2418	\$2490	\$2554	\$2604	\$2658	\$2702	\$2754	\$2834	\$2940	\$3004	\$2480
----------------	--------	--------	--------	--------	--------	--------	--------	--------	--------	--------	--------

Closed Arm

HS1CU130	\$2763	\$2855	\$2939	\$3009	\$3081	\$3137	\$3209	\$3317	\$3457	\$3543	\$2825
-----------------	--------	--------	--------	--------	--------	--------	--------	--------	--------	--------	--------

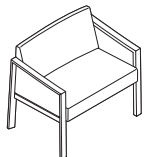
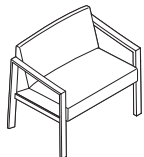

Guest Chair 40" Wide Bariatric

Open Arm

HS1C140	\$2590	\$2674	\$2752	\$2820	\$2886	\$2936	\$3002	\$3100	\$3230	\$3306	\$2652
----------------	--------	--------	--------	--------	--------	--------	--------	--------	--------	--------	--------

Closed Arm

HS1CU140	\$2936	\$3036	\$3130	\$3206	\$3284	\$3346	\$3420	\$3534	\$3690	\$3782	\$2998
-----------------	--------	--------	--------	--------	--------	--------	--------	--------	--------	--------	--------

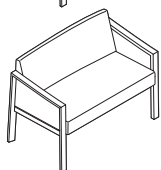
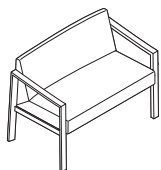

High-Back Seating

Standard Includes	Required to Specify
-------------------	---------------------

- Seat and back: fabric
- Arm panels, if selected: fabric
- Leg and arm assemblies: wood
- Glides: black

- 1 Style number
 - 2 Fabric color number for back and seat
 - 3 Wood color number for leg and arm assemblies
 - 4 Options, if selected (see below)
- ▶ See *Surface Materials*, page 402.

Tip: Different fabrics for the seat and back can be specified. If the fabrics are in different price groups, calculate list price by adding the two price groups together and dividing by two.

Options	Price	Required to Specify
---------	-------	---------------------

Surface Materials	<ul style="list-style-type: none"> • Moisture barrier • Single-seat and single-seat bariatric chairs 	+\$ 96	Specify with moisture barrier.
	<ul style="list-style-type: none"> • Arm caps • Plastic arm caps: black only 	+\$148	Specify with plastic arm caps.

Specification Information

Style Number	Base Prices										COM
	Fabric Price Group 1	Fabric Price Group 2	Fabric Price Group 3	Fabric Price Group 4	Fabric Price Group 5	Fabric Price Group 6	Fabric Price Group 7	Fabric Price Group 8	Fabric Price Group 9	Fabric Price Group 10	

High-Back Chair

Open Arm											
HS1P1	\$2059	\$2137	\$2209	\$2271	\$2327	\$2373	\$2431	\$2519	\$2639	\$2711	\$2121

Closed Arm											
HS1PU1	\$2404	\$2488	\$2566	\$2634	\$2700	\$2750	\$2816	\$2914	\$3044	\$3120	\$2466

High-Back 30" Wide Bariatric Chair

Open Arm											
HS1P130	\$2924	\$3024	\$3118	\$3194	\$3272	\$3334	\$3408	\$3522	\$3678	\$3770	\$2986

Closed Arm											
HS1PU130	\$3270	\$3378	\$3482	\$3562	\$3642	\$3708	\$3792	\$3918	\$4082	\$4180	\$3332

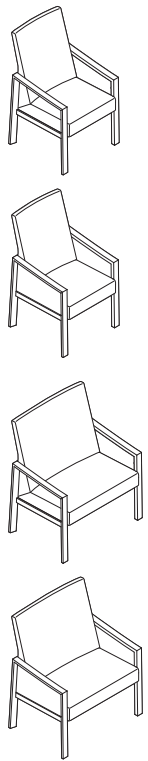

SIN 711.16

Lounge Seating

Standard Includes	Required to Specify
-------------------	---------------------

- | | |
|---|--|
| <ul style="list-style-type: none"> • Seat and back: fabric • Arm and back panels: fabric to match back • Legs: wood • Arm caps: wood to match legs • Glides: black | <ul style="list-style-type: none"> 1 Style number 2 Fabric color number for seat and back 3 Wood color number for legs 4 Options, if selected (see below) ▶ See <i>Surface Materials</i>, page 402. |
|---|--|

Tip: Different fabrics for the seat and back can be specified. If the fabrics are in different price groups, calculate list price by adding the two price groups together and dividing by two.

Options	Price	Required to Specify
---------	-------	---------------------

Surface Materials	Moisture barrier		
	• Lounge chair	+\$ 96	Specify with moisture barrier.
	• Loveseat	+\$192	Specify with moisture barrier.
	• Sofa	+\$288	Specify with moisture barrier.
	Arm caps		
	• Plastic arm caps: black only	+\$148	Specify with plastic arm caps.

Specification Information

Style Number	Base Prices										COM
	Fabric Price Group 1	Fabric Price Group 2	Fabric Price Group 3	Fabric Price Group 4	Fabric Price Group 5	Fabric Price Group 6	Fabric Price Group 7	Fabric Price Group 8	Fabric Price Group 9	Fabric Price Group 10	
	Price	Price	Price	Price	Price	Price	Price	Price	Price	Price	

Lounge Chair

HS1L1	\$2215	\$2369	\$2513	\$2629	\$2745	\$2843	\$2961	\$3137	\$3375	\$3515	\$2277
--------------	--------	--------	--------	--------	--------	--------	--------	--------	--------	--------	--------

Loveseat

HS1L2	\$3433	\$3677	\$3907	\$4095	\$4283	\$4435	\$4627	\$4907	\$5287	\$5513	\$3495
--------------	--------	--------	--------	--------	--------	--------	--------	--------	--------	--------	--------

Sofa

HS1L3	\$4320	\$4658	\$4972	\$5230	\$5490	\$5696	\$5962	\$6348	\$6868	\$7182	\$4382
--------------	--------	--------	--------	--------	--------	--------	--------	--------	--------	--------	--------

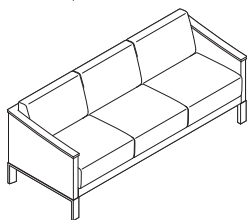
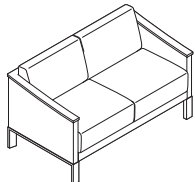
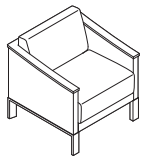

Bariatric Lounge Seating

Standard Includes	Required to Specify
-------------------	---------------------

- Seat and back: fabric
- Arm and back panels: fabric to match back
- Legs: wood
- Arm caps: wood to match legs
- Glides: black

- 1 Style number
- 2 Fabric color number for seat and back
- 3 Wood color number for legs
- 4 Options, if selected (see below)
- ▶ See *Surface Materials*, page 402.

Tip: Different fabrics for the seat and back can be specified. If the fabrics are in different price groups, calculate list price by adding the two price groups together and dividing by two.

Options	Price	Required to Specify
---------	-------	---------------------

Surface Materials	Moisture barrier • Moisture barrier	+\$ 96	Specify with moisture barrier.
	Arm caps • Plastic arm caps: black only	+\$148	Specify with plastic arm caps.

Specification Information

Style Number	Width	Base Prices										COM	
		Fabric Price	Fabric Price	Fabric Price	Fabric Price	Fabric Price	Fabric Price	Fabric Price	Fabric Price	Fabric Price	Fabric Price		
		Group 1	Group 2	Group 3	Group 4	Group 5	Group 6	Group 7	Group 8	Group 9	Group 10		

Bariatric Lounge

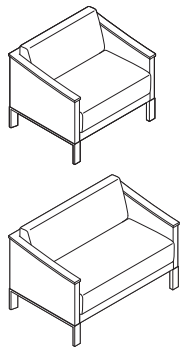

HS1L130	30"	\$3144	\$3328	\$3498	\$3642	\$3784	\$3896	\$4038	\$4252	\$4536	\$4706	\$3206
HS1L140	40"	\$3369	\$3587	\$3783	\$3949	\$4115	\$4247	\$4411	\$4661	\$4989	\$5191	\$3431

SIN 711.16

Benches

Powder Coated Steel

Standard Includes	Required to Specify
<ul style="list-style-type: none"> • Seat: fabric • Bench body: powdercoated steel • Legs: wood • Table, if selected: paint to match bench body • Glides: black 	<ol style="list-style-type: none"> 1 Style number 2 Fabric color number for seat 3 Paint color number for bench body 4 Wood color number for legs 5 Options, if selected (see below) <p>▶ See <i>Surface Materials</i>, page 402.</p>

Options	Price	Required to Specify
Surface Materials Moisture barrier <ul style="list-style-type: none"> • 21"W Bench • 42"W Bench, 56"W Bench with table unit • 56"W and 70"W Benches, 70"W Bench with table unit 	+\$ 96 +\$192 +\$288	Specify with <i>moisture barrier</i> . Specify with <i>moisture barrier</i> . Specify with <i>moisture barrier</i> .

Specification Information

Base Prices												
Style Number	Width	Fabric Price Group 1	Fabric Price Group 2	Fabric Price Group 3	Fabric Price Group 4	Fabric Price Group 5	Fabric Price Group 6	Fabric Price Group 7	Fabric Price Group 8	Fabric Price Group 9	Fabric Price Group 10	COM

Benches

HS1B21C	21"	\$1740	\$1765	\$1785	\$1804	\$1820	\$1834	\$1853	\$1879	\$1914	\$1936	\$1799
HS1B42C	42"	\$2213	\$2259	\$2301	\$2336	\$2372	\$2400	\$2436	\$2490	\$2560	\$2603	\$2272
HS1B56C	56"	\$2681	\$2735	\$2787	\$2827	\$2867	\$2900	\$2942	\$3005	\$3087	\$3136	\$2740
HS1B70C	70"	\$3066	\$3136	\$3200	\$3252	\$3306	\$3349	\$3401	\$3482	\$3587	\$3651	\$3125

Benches with Table

56"W Bench with One Table

HS1B56T1C	56"	\$2681	\$2727	\$2769	\$2804	\$2840	\$2868	\$2904	\$2958	\$3028	\$3071	\$2740
------------------	-----	--------	--------	--------	--------	--------	--------	--------	--------	--------	--------	--------

70"W Bench with One Table

HS1B70T1C	70"	\$3066	\$3120	\$3172	\$3212	\$3252	\$3285	\$3327	\$3390	\$3472	\$3521	\$3125
------------------	-----	--------	--------	--------	--------	--------	--------	--------	--------	--------	--------	--------

70"W Bench with Two Tables

HS1B70T2C	70"	\$3066	\$3112	\$3154	\$3189	\$3225	\$3253	\$3289	\$3343	\$3413	\$3456	\$3125
------------------	-----	--------	--------	--------	--------	--------	--------	--------	--------	--------	--------	--------

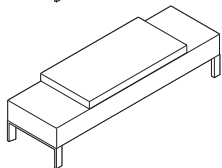
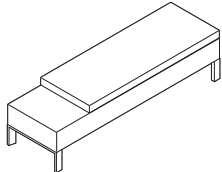
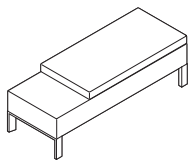
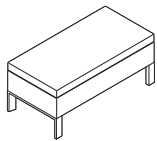

SIN 711.16

Benches

Solid Surface

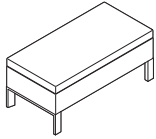

Tip: For deal codes and more information on the solid surface graded-in program see Surface Materials.
 ▶ Page 402

Standard Includes	Required to Specify
-------------------	---------------------

- Seat: fabric
- Bench body: solid surface
- Legs: wood
- Table, if selected: solid surface to match bench body
- Glides: black

- 1 Style number
 - 2 Fabric color number for seat
 - 3 Solid surface color number for bench body
 - 4 Wood color number for legs
 - 5 Options, if selected (see below)
- ▶ See *Surface Materials*, page 402.

Surface Materials	Options	Price	Required to Specify
-------------------	---------	-------	---------------------

- Moisture barrier**
- 21"W Bench +\$ 96
 - 42"W Bench, 56"W Bench with table unit +\$192
 - 56"W and 70"W Benches, 70"W Bench with table unit +\$288

Specify *with moisture barrier*.
 Specify *with moisture barrier*.
 Specify *with moisture barrier*.

- Solid surface**
- Solid surface price group A Prices at right
 - Solid surface price group B Prices at right
 - Solid surface price group C Prices at right
 - Solid surface price group D Prices at right

Specify solid surface color number or finish code.
 Specify solid surface color number or finish code.
 Specify solid surface color number or finish code.
 Specify solid surface color number or finish code.

Specification Information

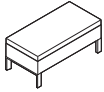

Style Number	Width	Solid Surface Grade	Base Prices										COM
			Fabric Price Group 1	Fabric Price Group 2	Fabric Price Group 3	Fabric Price Group 4	Fabric Price Group 5	Fabric Price Group 6	Fabric Price Group 7	Fabric Price Group 8	Fabric Price Group 9	Fabric Price Group 10	
HS1B21S	21"	A	\$2787	\$2812	\$2832	\$2851	\$2867	\$2881	\$2900	\$2926	\$2961	\$2983	\$2846
		B	\$2827	\$2852	\$2872	\$2891	\$2907	\$2921	\$2940	\$2966	\$3001	\$3023	\$2886
		C	\$2888	\$2913	\$2933	\$2952	\$2968	\$2982	\$3001	\$3027	\$3062	\$3084	\$2947
		D	\$3022	\$3047	\$3067	\$3086	\$3102	\$3116	\$3135	\$3161	\$3196	\$3218	\$3081
HS1B42S	42"	A	\$3541	\$3587	\$3629	\$3664	\$3700	\$3728	\$3764	\$3818	\$3888	\$3931	\$3600
		B	\$3606	\$3652	\$3694	\$3729	\$3765	\$3793	\$3829	\$3883	\$3953	\$3996	\$3665
		C	\$3708	\$3754	\$3796	\$3831	\$3867	\$3895	\$3931	\$3985	\$4055	\$4098	\$3767
		D	\$3939	\$3985	\$4027	\$4062	\$4098	\$4126	\$4162	\$4216	\$4286	\$4329	\$3998
HS1B56S	56"	A	\$4291	\$4345	\$4397	\$4437	\$4477	\$4510	\$4552	\$4615	\$4697	\$4746	\$4350
		B	\$4361	\$4415	\$4467	\$4507	\$4547	\$4580	\$4622	\$4685	\$4767	\$4816	\$4420
		C	\$4482	\$4536	\$4588	\$4628	\$4668	\$4701	\$4743	\$4806	\$4888	\$4937	\$4541
		D	\$4744	\$4798	\$4850	\$4890	\$4930	\$4963	\$5005	\$5068	\$5150	\$5199	\$4803
HS1B70S	70"	A	\$4905	\$4975	\$5039	\$5091	\$5145	\$5188	\$5240	\$5321	\$5426	\$5490	\$4964
		B	\$4989	\$5059	\$5123	\$5175	\$5229	\$5272	\$5324	\$5405	\$5510	\$5574	\$5048
		C	\$5131	\$5201	\$5265	\$5317	\$5371	\$5414	\$5466	\$5547	\$5652	\$5716	\$5190
		D	\$5443	\$5513	\$5577	\$5629	\$5683	\$5726	\$5778	\$5859	\$5964	\$6028	\$5502

► Specification Information, continued on next page

Tava, continued

SIN 711.16

► Specification Information, continued from previous page

Specification Information

Style Number	Width	Solid Surface Grade	Base Prices										COM
			Fabric Price Group 1	Fabric Price Group 2	Fabric Price Group 3	Fabric Price Group 4	Fabric Price Group 5	Fabric Price Group 6	Fabric Price Group 7	Fabric Price Group 8	Fabric Price Group 9	Fabric Price Group 10	

Bench with Table

56"W Bench with One Table

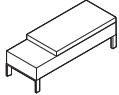

Style Number	Width	Surface Grade	Fabric Price Group 1	Fabric Price Group 2	Fabric Price Group 3	Fabric Price Group 4	Fabric Price Group 5	Fabric Price Group 6	Fabric Price Group 7	Fabric Price Group 8	Fabric Price Group 9	Fabric Price Group 10	COM
HS1B56T1S	56"	A	\$4291	\$4337	\$4379	\$4414	\$4450	\$4478	\$4514	\$4568	\$4638	\$4681	\$4350
		B	\$4361	\$4407	\$4449	\$4484	\$4520	\$4548	\$4584	\$4638	\$4708	\$4751	\$4420
		C	\$4470	\$4516	\$4558	\$4593	\$4629	\$4657	\$4693	\$4747	\$4817	\$4860	\$4529
		D	\$4722	\$4768	\$4810	\$4845	\$4881	\$4909	\$4945	\$4999	\$5069	\$5112	\$4781

70"W Bench with One Table

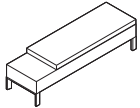

Style Number	Width	Surface Grade	Fabric Price Group 1	Fabric Price Group 2	Fabric Price Group 3	Fabric Price Group 4	Fabric Price Group 5	Fabric Price Group 6	Fabric Price Group 7	Fabric Price Group 8	Fabric Price Group 9	Fabric Price Group 10	COM
HS1B70T1S	70"	A	\$4905	\$4959	\$5011	\$5051	\$5091	\$5124	\$5166	\$5229	\$5311	\$5360	\$4964
		B	\$4989	\$5043	\$5095	\$5135	\$5175	\$5208	\$5250	\$5313	\$5395	\$5444	\$5048
		C	\$5131	\$5185	\$5237	\$5277	\$5317	\$5350	\$5392	\$5455	\$5537	\$5586	\$5190
		D	\$5443	\$5497	\$5549	\$5589	\$5629	\$5662	\$5704	\$5767	\$5849	\$5898	\$5502

70"W Bench with Two Tables

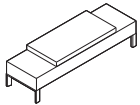

Style Number	Width	Surface Grade	Fabric Price Group 1	Fabric Price Group 2	Fabric Price Group 3	Fabric Price Group 4	Fabric Price Group 5	Fabric Price Group 6	Fabric Price Group 7	Fabric Price Group 8	Fabric Price Group 9	Fabric Price Group 10	COM
HS1B70T2S	70"	A	\$4905	\$4951	\$4993	\$5028	\$5064	\$5092	\$5128	\$5182	\$5252	\$5295	\$4964
		B	\$4989	\$5035	\$5077	\$5112	\$5148	\$5176	\$5212	\$5266	\$5336	\$5379	\$5048
		C	\$5131	\$5177	\$5219	\$5254	\$5290	\$5318	\$5354	\$5408	\$5478	\$5521	\$5190
		D	\$5443	\$5489	\$5531	\$5566	\$5602	\$5630	\$5666	\$5720	\$5790	\$5833	\$5502

Tava Tables

SIN 711.16

Freestanding Tables

Powder Coated Steel Top

Seating

Standard Includes	Required to Specify
<ul style="list-style-type: none"> • Top: powder coated steel • Legs: wood 	<ul style="list-style-type: none"> 1 Style number 2 Paint color number for top 3 Wood color number for legs ▶ See <i>Surface Materials</i>, page 402.

Specification Information

• Dimensions			• Style	• Price
D	W	H	Number	

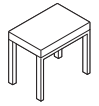

Side Tables

21"	14"	18"	HS1T1418C	\$1183
21"	21"	18"	HS1T2118C	\$1354

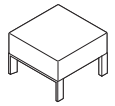

Coffee Tables

21"	21"	15"	HS1T2115C	\$1511
21"	42"	15"	HS1T4215C	\$1754

Tava Tables, continued

SIN 711.16

Freestanding Tables

Solid Surface Top

Standard Includes	Required to Specify
-------------------	---------------------

- | | |
|--|---|
| <ul style="list-style-type: none"> • Top: solid surface • Legs: wood | <ul style="list-style-type: none"> 1 Style number 2 Solid surface color number for top 3 Wood color number for legs ▶ See <i>Surface Materials</i>, page 402. |
|--|---|

Tip: For deal codes and more information on the solid surface graded-in program see Surface Materials.
▶ Page 402

Surface Materials	Options	Price	Required to Specify
-------------------	---------	-------	---------------------

Surface Materials	<ul style="list-style-type: none"> • Solid surface price group A • Solid surface price group B • Solid surface price group C • Solid surface price group D 	<ul style="list-style-type: none"> No cost Prices below Prices below Prices below 	<ul style="list-style-type: none"> Specify solid surface color number or finish code. Specify solid surface color number or finish code. Specify solid surface color number or finish code. Specify solid surface color number or finish code.
-------------------	--	---	--

Specification Information							
Dimensions			Style	Prices			
D	W	H	Number	Price Group A	Price Group B	Price Group C	Price Group D

D	W	H	Number	Price Group A	Price Group B	Price Group C	Price Group D
---	---	---	--------	---------------	---------------	---------------	---------------

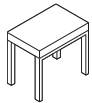

Side Tables

21"	14"	18"	HS1T1418S	\$1892	\$1921	\$1966	\$2067
21"	21"	18"	HS1T2118S	\$2169	\$2202	\$2248	\$2360

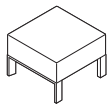

Coffee Tables

21"	21"	15"	HS1T2115S	\$2419	\$2452	\$2498	\$2610
21"	42"	15"	HS1T4215S	\$2805	\$2870	\$2976	\$3209

Freestanding Tables

SIN 711.11/711.17

Freestanding Tables with Wood Edge

Seating

Standard Includes	Required to Specify
<ul style="list-style-type: none"> • Top: High-Pressure Laminate • Edge: maple wood to match top • Legs: wood or paint (if metal leg selected) • Attachment brackets: black only • Glides: black nylon 	<ul style="list-style-type: none"> 1 Style number 2 Laminate color number for top 3 Paint color for legs, if metal leg selected ▶ See <i>Surface Materials</i>, page 402.

Specification Information				
Dimensions			Style	Price
D	W	H	Number	
:	:	:	:	:

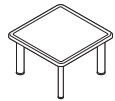

Square Tables with Metal Legs

26"	26"	16"	HTM262616W	\$990
26"	26"	21"	HTM262621W	\$990
:	:	:	:	:

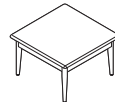

Square Tables with Tapered Legs

18"	18"	21"	HTT181821W	\$710
26"	26"	21"	HTT262621W	\$797
:	:	:	:	:



Rectangular Table with Metal Legs

20"	24"	21"	HTM242021W	\$789
:	:	:	:	:

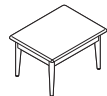

Rectangular Table with Tapered Legs

20"	24"	21"	HTT242021W	\$713
:	:	:	:	:



Round Table with Tapered Legs

24"dia	21"	HTT24R21W	\$793
:	:	:	:

Freestanding Tables, continued

SIN 711.11/711.17

Freestanding Tables with Plastic Edge

Standard Includes	Required to Specify
<ul style="list-style-type: none"> • Top: High-Pressure Laminate • Edge: plastic to match • Legs: wood or paint (if metal leg selected) • Glides: black nylon 	<ul style="list-style-type: none"> 1 Style number 2 Laminate color number for top 3 Paint color for legs, if metal selected ▶ See <i>Surface Materials</i>, page 402.

Specification Information

Dimensions			Style	Price
D	W	H	Number	
:	:	:	:	:

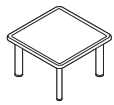

Square Tables with Metal Legs

26"	26"	16"	HTM262616P	\$721
26"	26"	21"	HTM262621P	\$721
:	:	:	:	:

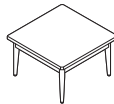

Square Table with Tapered Legs

26"	26"	21"	HTT262621P	\$728
:	:	:	:	:



Rectangular Table with Metal Legs

20"	24"	21"	HTM242021P	\$599
:	:	:	:	:



Rectangular Table with Tapered Legs

20"	24"	21"	HTT242021P	\$604
:	:	:	:	:

Drum Table

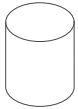

Standard Includes	Required to Specify
-------------------	---------------------

- Top: High-Pressure Laminate
- Edge: plastic to match

- 1 Style number
- 2 Laminate color number for top
- ▶ See *Surface Materials*, page 402.

Specification Information			
Dimensions		Style	Price
D	H	Number	

D	H	Style Number	Price
18"	18"	SC27DT18D	\$488
24"	18"	SC27DT24D	\$644

Regard Base, Bench, Booth, and Wall-Mounted Frames

SIN 711.16

Standard Includes	Required to Specify
-------------------	---------------------

- Legs and trim: paint price group 1
- Adjustable glides on legs: platinum solid plastic

- 1 Style number
- 2 Paint color for legs and trim
- 3 Options, if selected (see below)
- ▶ See *Surface Materials*, page 402.

Surface Materials	Options	Price	Required to Specify
-------------------	---------	-------	---------------------

Surface Materials

- Paint price group 1
No cost
- Paint price group 2 for wall-mounted base frame
+\$28
- Paint price group 2 for single-sided, double-sided, bench, planter, booth base, and freestanding back-to-back cabinet frames
+\$49
- Paint price group 3
+\$99

Specify paint color number.
Specify paint color number.

Specify paint color number.

- Specify paint color number.
- ▶ See *Surface Materials*, page 402.

Specification Information			
Dimensions		Style	Base
D	W	Number	Price

Frames

Single-Sided

27½"	44"	HS4FS44	\$ 921
27½"	55"	HS4FS55	\$1003
27½"	60½"	HS4FS61	\$1030
27½"	66"	HS4FS66	\$1057
27½"	71½"	HS4FS72	\$1083
27½"	77"	HS4FS77	\$1145
27½"	82½"	HS4FS83	\$1186
27½"	88"	HS4FS88	\$1227

Double-Sided

55"	44"	HS4FD44	\$1179
55"	55"	HS4FD55	\$1300
55"	60½"	HS4FD61	\$1346
55"	66"	HS4FD66	\$1392
55"	71½"	HS4FD72	\$1438
55"	77"	HS4FD77	\$1484
55"	82½"	HS4FD83	\$1530
55"	88"	HS4FD88	\$1576

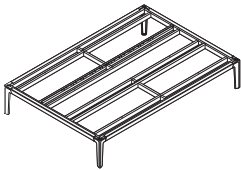
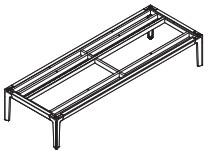

▶ **Specification Information, continued on next page**

► Specification Information, continued from previous page

Specification Information

Dimensions			Style	Base
D	W	H	Number	Price

Frames, continued

Planter

37½"	44"		HS4FSP44	\$1177
37½"	55"		HS4FSP55	\$1293
37½"	60½"		HS4FSP61	\$1375
37½"	66"		HS4FSP66	\$1410
37½"	71½"		HS4FSP72	\$1600
37½"	77"		HS4FSP77	\$1652
37½"	82½"		HS4FSP83	\$1738
37½"	88"		HS4FSP88	\$1793

Bench

18"	44"		HS4FB44	\$ 811
18"	66"		HS4FB66	\$ 942

Booth

44"	80½"		HS4FC4481	\$1949
55"	80½"		HS4FC5581	\$2069

Wall-Mounted

11"	55"		HS4FW1155	\$ 921
-----	-----	--	------------------	--------

Freestanding Back-to-Back Cabinet

22"	55"	14"	HS4FD2255	\$1300
-----	-----	-----	------------------	--------

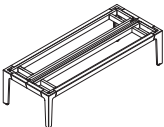
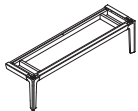
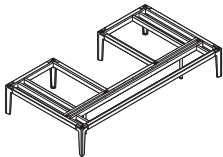
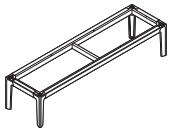
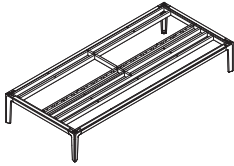

Regard Frame Extensions

SIN 711.16

Tip: Extensions can be added to either side of double-sided frames or back of 55"W single-sided frame.

Standard Includes	Required to Specify
<ul style="list-style-type: none"> • Frame extensions: paint price group 1 • Adjustable glides on legs: platinum solid plastic 	<ul style="list-style-type: none"> 1 Style number 2 Paint color for extensions 3 Options, if selected (see below) ▶ See <i>Surface Materials</i>, page 402.

Surface Materials	Options	Price	Required to Specify
	<ul style="list-style-type: none"> • Paint price group 1 	No cost	Specify paint color number.
	<ul style="list-style-type: none"> • Paint price group 2 for cabinet frame extension and seating frame extension 	+\$28	Specify paint color number.
	<ul style="list-style-type: none"> • Paint price group 2 for planter frame extensions 	+\$49	Specify paint color number.
	<ul style="list-style-type: none"> • Paint price group 3 	+\$99	Specify paint color number. ▶ See <i>Surface Materials</i> , page 402.

Specification Information			
Dimensions	Style	Base	Price
D	W	Number	Price
:	:	:	:

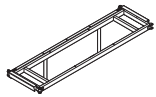

Cabinet Frame Extension

11"	55"	HS4FE1155	\$545
:	:	:	:

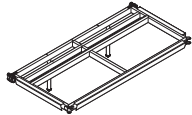

Seating Frame Extension

27½"	55"	HS4FE2855	\$727
:	:	:	:

Tip: Perpendicular seating can only be added using HS4FE2855.

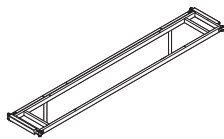

Planter Frame Extensions

11"	44"	HS4FE1144	\$513
11"	61"	HS4FE1161	\$578
11"	66"	HS4FE1166	\$611
11"	72"	HS4FE1172	\$644
11"	77"	HS4FE1177	\$677
11"	83"	HS4FE1183	\$709
11"	88"	HS4FE1188	\$742
:	:	:	:

Tip: Only for use on single-sided frames.

Regard Frame Brackets

SIN 711.16

Seating

Standard Includes	Required to Specify
<ul style="list-style-type: none"> Ganging bracket, if selected: quantity 2 Floor anchor bracket, if selected 	Style number

Specification Information

•Style Number	•Price



Ganging Bracket

HS4FG	\$37

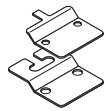

Floor Anchor Bracket

98769	\$35

Regard Seat and Bench Cushions

SIN 711.16

Tip: Contrasting fabrics can be specified on the bench cushions only.

Standard Includes	Required to Specify
-------------------	---------------------

- Seat, bench cushion, bench side panel: fabric
- Frame attachment brackets

- 1 Style number
 - 2 Fabric color number for seat or bench cushion
 - 3 Fabric color number for bench side panel, if selected
 - 4 Options, if selected (see below)
- ▶ See *Surface Materials*, page 402.

Options	Price	Required to Specify
---------	-------	---------------------

Surface Materials

Moisture barrier

+\$96 per cushion

Specify with *moisture barrier*.

Specification Information

• Dimensions		• Style Number	• Base Prices											
D	W		Fabric 1	Fabric 2	Fabric 3	Fabric 4	Fabric 5	Fabric 6	Fabric 7	Fabric 8	Fabric 9	Fabric 10	COM	
:	:	:	Price	Price	Price	Price	Price	Price	Price	Price	Price	Price	Price	:
:	:	:	Group 1	Group 2	Group 3	Group 4	Group 5	Group 6	Group 7	Group 8	Group 9	Group 10	:	

Seat Cushions

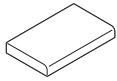

20"	22"	HS4H22	Seat fabric	\$267	\$300	\$331	\$355	\$382	\$401	\$426	\$ 464	\$ 515	\$ 546	\$283
20"	33"	HS4H33	Seat fabric	\$322	\$361	\$398	\$429	\$458	\$482	\$513	\$ 559	\$ 618	\$ 655	\$338

Bench Cushion



18"	22"	HS4HB	Seat fabric	\$308	\$343	\$376	\$402	\$429	\$449	\$477	\$ 517	\$ 570	\$ 603	\$316
:	:	:	Side fabric	No cost	+\$18	+\$36	+\$49	+\$66	+\$76	+\$89	+\$112	+\$140	+\$158	+\$ 8

Regard Backs

SIN 711.16

Tip: Inner and outer fabrics may be contrasting.

Tip: Back fabric patterns may not match seats and arms.

▶ See *Surface Materials*, page 402

Tip: Fabric is applied warp horizontal only.

Tip: Privacy screen attachment option must be specified when mounting a glass screen to a back. Screens are ordered separately.

Standard Includes		Required to Specify
<ul style="list-style-type: none"> Inner and outer back: fabric Frame attachment brackets 		1 Style number 2 Fabric color number for inner back 3 Fabric color number for outer back 4 Options, if selected (see below) ▶ See <i>Surface Materials</i> , page 402.

Options	Price	Required to Specify
Privacy Screen Attachment	<ul style="list-style-type: none"> For backs 33" – 60½" For backs 66" – 88" 	+\$103 per back +\$123 per back Specify with screen attachment. Specify with screen attachment.
Related Products	<ul style="list-style-type: none"> Privacy Screens 	▶ Page 145

Specification Information													
Dimensions		Style Number		Base Prices									
D	W			Fabric	Fabric	Fabric	Fabric	Fabric	Fabric	Fabric	Fabric	Fabric	COM
				Price	Price	Price	Price	Price	Price	Price	Price	Price	
				Group 1	Group 2	Group 3	Group 4	Group 5	Group 6	Group 7	Group 8	Group 9	Group 10

Single-Sided

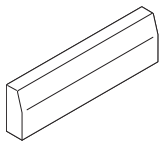

7½"	33"	HS4BS33	Inner fabric	\$701	\$ 738	\$ 772	\$ 799	\$ 829	\$ 851	\$ 878	\$ 920	\$ 978	\$1012	\$717
			Outer fabric	No cost	+\$ 55	+\$107	+\$149	+\$191	+\$222	+\$265	+\$329	+\$414	+\$465	+\$16
7½"	44"	HS4BS44	Inner fabric	\$773	\$ 814	\$ 851	\$ 883	\$ 914	\$ 939	\$ 970	\$1017	\$1081	\$1117	\$789
			Outer fabric	No cost	+\$ 60	+\$117	+\$165	+\$212	+\$248	+\$295	+\$366	+\$460	+\$517	+\$16
7½"	55"	HS4BS55	Inner fabric	\$845	\$ 890	\$ 931	\$ 967	\$1002	\$1028	\$1063	\$1116	\$1185	\$1228	\$861
			Outer fabric	No cost	+\$ 69	+\$130	+\$182	+\$237	+\$277	+\$329	+\$406	+\$511	+\$575	+\$16
7½"	60½"	HS4BS61	Inner fabric	\$896	\$ 943	\$ 988	\$1025	\$1062	\$1090	\$1126	\$1181	\$1256	\$1299	\$912
			Outer fabric	No cost	+\$ 72	+\$137	+\$193	+\$248	+\$290	+\$345	+\$427	+\$539	+\$604	+\$16
7½"	66"	HS4BS66	Inner fabric	\$962	\$1011	\$1058	\$1097	\$1136	\$1166	\$1205	\$1261	\$1339	\$1386	\$978
			Outer fabric	No cost	+\$ 75	+\$144	+\$203	+\$260	+\$304	+\$364	+\$450	+\$568	+\$637	+\$16

▶ Specification Information, continued on next page

► Specification Information, continued from previous page

Seating

Specification Information														
Dimensions D	W	Style Number		Base Prices										COM
				Fabric Price Group 1	Fabric Price Group 2	Fabric Price Group 3	Fabric Price Group 4	Fabric Price Group 5	Fabric Price Group 6	Fabric Price Group 7	Fabric Price Group 8	Fabric Price Group 9	Fabric Price Group 10	

Single-Sided, continued

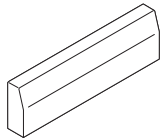

7 1/2"	71 1/2"	HS4BS72	Inner fabric	\$1029	\$1081	\$1130	\$1171	\$1211	\$1243	\$1284	\$1346	\$1427	\$1476	\$1045
			Outer fabric	No cost	+\$ 79	+\$153	+\$213	+\$276	+\$322	+\$383	+\$474	+\$597	+\$670	+\$ 16
7 1/2"	77"	HS4BS77	Inner fabric	\$1096	\$1151	\$1204	\$1246	\$1289	\$1322	\$1364	\$1428	\$1515	\$1565	\$1112
			Outer fabric	No cost	+\$ 83	+\$160	+\$224	+\$289	+\$338	+\$404	+\$499	+\$627	+\$705	+\$ 16
7 1/2"	82 1/2"	HS4BS83	Inner fabric	\$1162	\$1220	\$1275	\$1320	\$1366	\$1401	\$1445	\$1512	\$1602	\$1657	\$1178
			Outer fabric	No cost	+\$ 87	+\$169	+\$238	+\$303	+\$356	+\$424	+\$526	+\$661	+\$743	+\$ 16
7 1/2"	88"	HS4BS88	Inner fabric	\$1229	\$1291	\$1347	\$1395	\$1443	\$1479	\$1526	\$1597	\$1693	\$1749	\$1245
			Outer fabric	No cost	+\$ 92	+\$177	+\$249	+\$321	+\$375	+\$447	+\$552	+\$696	+\$782	+\$ 16

Double-Sided

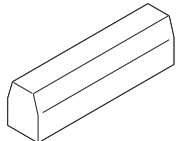

15"	33"	HS4BD33	Inner fabric	\$ 871	\$ 923	\$ 972	\$1012	\$1053	\$1085	\$1126	\$1187	\$1268	\$1317	\$ 887
			Outer fabric	No cost	+\$ 35	+\$ 68	+\$ 95	+\$122	+\$142	+\$170	+\$210	+\$264	+\$297	+\$ 16
15"	38 1/2"	HS4BD39	Inner fabric	\$ 958	\$1020	\$1077	\$1125	\$1173	\$1210	\$1257	\$1329	\$1425	\$1482	\$ 974
			Outer fabric	No cost	+\$ 41	+\$ 79	+\$112	+\$144	+\$168	+\$201	+\$247	+\$312	+\$350	+\$ 16
15"	44"	HS4BD44	Inner fabric	\$1033	\$1106	\$1172	\$1230	\$1286	\$1329	\$1386	\$1469	\$1582	\$1650	\$1049
			Outer fabric	No cost	+\$ 48	+\$ 93	+\$131	+\$169	+\$198	+\$236	+\$291	+\$367	+\$411	+\$ 16
15"	49 1/2"	HS4BD50	Inner fabric	\$1108	\$1189	\$1264	\$1326	\$1390	\$1437	\$1500	\$1593	\$1719	\$1793	\$1124
			Outer fabric	No cost	+\$ 54	+\$104	+\$146	+\$187	+\$219	+\$261	+\$324	+\$407	+\$457	+\$ 16
15"	55"	HS4BD55	Inner fabric	\$1183	\$1272	\$1356	\$1426	\$1496	\$1549	\$1619	\$1722	\$1862	\$1945	\$1199
			Outer fabric	No cost	+\$ 59	+\$116	+\$163	+\$209	+\$244	+\$290	+\$360	+\$453	+\$507	+\$ 16
15"	60 1/2"	HS4BD61	Inner fabric	\$1258	\$1357	\$1451	\$1527	\$1605	\$1665	\$1742	\$1857	\$2012	\$2104	\$1274
			Outer fabric	No cost	+\$ 67	+\$128	+\$179	+\$232	+\$271	+\$323	+\$400	+\$502	+\$564	+\$ 16

► Specification Information, continued on next page

Regard Backs, continued

SIN 711.16

► Specification Information, continued from previous page

Specification Information											
Dimensions D W	Style Number	Base Prices									
		Fabric Price Group 1	Fabric Price Group 2	Fabric Price Group 3	Fabric Price Group 4	Fabric Price Group 5	Fabric Price Group 6	Fabric Price Group 7	Fabric Price Group 8	Fabric Price Group 9	Fabric Price Group 10

Double-Sided, continued

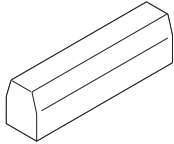

15"	66"	HS4BD66	Inner fabric	\$1333	\$1439	\$1536	\$1617	\$1699	\$1760	\$1842	\$1962	\$2126	\$2224	\$1349
			Outer fabric	No cost	+\$ 71	+\$135	+\$190	+\$244	+\$286	+\$339	+\$420	+\$530	+\$593	+\$ 16
15"	71½"	HS4BD72	Inner fabric	\$1407	\$1518	\$1620	\$1705	\$1792	\$1857	\$1944	\$2070	\$2242	\$2344	\$1423
			Outer fabric	No cost	+\$ 74	+\$141	+\$200	+\$256	+\$299	+\$358	+\$443	+\$557	+\$625	+\$ 16
15"	77"	HS4BD77	Inner fabric	\$1482	\$1599	\$1705	\$1798	\$1887	\$1956	\$2047	\$2180	\$2360	\$2468	\$1498
			Outer fabric	No cost	+\$ 78	+\$150	+\$210	+\$271	+\$317	+\$376	+\$465	+\$586	+\$658	+\$ 16
15"	82½"	HS4BD83	Inner fabric	\$1557	\$1679	\$1794	\$1888	\$1983	\$2056	\$2150	\$2291	\$2483	\$2596	\$1573
			Outer fabric	No cost	+\$ 81	+\$157	+\$220	+\$285	+\$332	+\$396	+\$491	+\$617	+\$692	+\$ 16
15"	88"	HS4BD88	Inner fabric	\$1632	\$1761	\$1880	\$1981	\$2081	\$2158	\$2257	\$2405	\$2606	\$2725	\$1648
			Outer fabric	No cost	+\$ 85	+\$166	+\$233	+\$299	+\$351	+\$417	+\$516	+\$649	+\$729	+\$ 16







Regard Arms

SIN 711.16

Seating

Standard Includes	Required to Specify
<ul style="list-style-type: none"> • Inner and outer arms: fabric • Arm cap, if selected: plastic • Frame attachment brackets 	<ol style="list-style-type: none"> 1 Style number 2 Fabric color number for inner arm 3 Fabric color number for outer arm 4 Plastic color number for arm cap, if selected <p>▶ See <i>Surface Materials</i>, page 402.</p>

Specification Information

Single-Sided		Double-Sided		Single-Sided with Plastic Arm Cap				Double-Sided with Plastic Arm Cap					
													
Dimensions	Style	Prices											
D	W	Number	Fabric Price Group 1	Fabric Price Group 2	Fabric Price Group 3	Fabric Price Group 4	Fabric Price Group 5	Fabric Price Group 6	Fabric Price Group 7	Fabric Price Group 8	Fabric Price Group 9	Fabric Price Group 10	COM

Single-Sided

20"	5 1/2"	HS4AS6	Inner fabric	\$221	\$244	\$263	\$280	\$ 298	\$ 310	\$ 329	\$ 354	\$ 388	\$ 408	\$229
			Outer fabric	No cost	+\$34	+\$65	+\$89	+\$116	+\$135	+\$161	+\$200	+\$250	+\$282	+\$ 8
20"	11"	HS4AS11	Inner fabric	\$271	\$294	\$313	\$330	\$ 348	\$ 360	\$ 379	\$ 404	\$ 438	\$ 458	\$279
			Outer fabric	No cost	+\$34	+\$65	+\$89	+\$116	+\$135	+\$161	+\$200	+\$250	+\$282	+\$ 8

Double-Sided

20"	5 1/2"	HS4AD6	Inner fabric	\$244	\$266	\$284	\$300	\$ 317	\$ 329	\$ 345	\$ 369	\$ 402	\$ 421	\$252
			Outer fabric	No cost	+\$32	+\$60	+\$84	+\$110	+\$128	+\$152	+\$188	+\$238	+\$264	+\$ 8
20"	11"	HS4AD11	Inner fabric	\$297	\$319	\$337	\$353	\$ 370	\$ 382	\$ 398	\$ 422	\$ 455	\$ 474	\$305
			Outer fabric	No cost	+\$32	+\$60	+\$84	+\$110	+\$128	+\$152	+\$188	+\$238	+\$264	+\$ 8

Single-Sided with Plastic Arm Cap

20"	5 1/2"	HS4AS6C	Inner fabric	\$308	\$323	\$340	\$352	\$ 365	\$ 376	\$ 388	\$ 406	\$ 432	\$ 447	\$316
			Outer fabric	No cost	+\$19	+\$38	+\$52	+\$ 70	+\$ 80	+\$ 96	+\$119	+\$150	+\$168	+\$ 8
20"	11"	HS4AS11C	Inner fabric	\$357	\$372	\$389	\$401	\$ 414	\$ 425	\$ 437	\$ 455	\$ 481	\$ 496	\$365
			Outer fabric	No cost	+\$19	+\$38	+\$52	+\$ 70	+\$ 80	+\$ 96	+\$119	+\$150	+\$168	+\$ 8

Double-Sided with Plastic Arm Cap

20"	5 1/2"	HS4AD6C	Inner fabric	\$330	\$353	\$371	\$388	\$ 405	\$ 417	\$ 434	\$ 459	\$ 493	\$ 511	\$338
			Outer fabric	No cost	+\$10	+\$22	+\$30	+\$ 38	+\$ 43	+\$ 51	+\$ 66	+\$ 81	+\$ 91	+\$ 8
20"	11"	HS4AD11C	Inner fabric	\$383	\$406	\$424	\$441	\$ 458	\$ 470	\$ 487	\$ 512	\$ 546	\$ 564	\$391
			Outer fabric	No cost	+\$10	+\$22	+\$30	+\$ 38	+\$ 43	+\$ 51	+\$ 66	+\$ 81	+\$ 91	+\$ 8

Regard Utility Arms

SIN 711.16

Tip: Contour arm is only to be used between seat cushions.

Tip: In-line table can be used in between seat cushions or on either end of a frame.

Tip: Specify power strip separately.
▶ See page 154

Standard Includes		Required to Specify
<ul style="list-style-type: none"> Outer arm: fabric Arm cap: plastic Frame attachment brackets 		1 Style number 2 Fabric color number for outer arm 3 Plastic color number for arm cap 4 Options, if selected (see below) ▶ See <i>Surface Materials</i> , page 402.
Options	Price	Required to Specify
Power Cutout	• With power cutout	No cost
		Specify with power cutout.

Specification Information

Contour Arm



In-Line Table



Dimensions		Style Number	Prices									
D	W		Fabric Price Group 1	Fabric Price Group 2	Fabric Price Group 3	Fabric Price Group 4	Fabric Price Group 5	Fabric Price Group 6	Fabric Price Group 7	Fabric Price Group 8	Fabric Price Group 9	Fabric Price Group 10

Contour Arm

20"	11"	HS4AU11	Outer fabric	\$451	\$477	\$498	\$518	\$536	\$550	\$570	\$599	\$636	\$659	\$467
-----	-----	----------------	--------------	-------	-------	-------	-------	-------	-------	-------	-------	-------	-------	-------

In-Line Table

20"	11"	HS4TL11	Outer fabric	\$390	\$404	\$420	\$431	\$442	\$454	\$465	\$482	\$506	\$520	\$406
-----	-----	----------------	--------------	-------	-------	-------	-------	-------	-------	-------	-------	-------	-------	-------

Regard Privacy Screens

SIN 711.16

Tip: Must specify the privacy screen attachment option for each back, as well as the privacy screen style number. Screens can only be attached when the option is selected on each back.

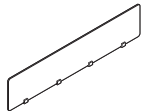

Tip: Screen width must match width of back width.

Tip: When using custom screen materials, screen widths must be ordered 2" less than widths shown at right. All edges must be rounded and beveled.

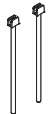

Tip: Screen brackets and stanchions can be specified separately to allow users to supply own screens.

Tip: When specifying custom screen materials, screen lengths 33"–55" require two brackets and stanchions and screen lengths 60½"–88" require four brackets and stanchions.

Tip: When using custom screen materials, the installer must attach glass tabs to the screen. Glass connection tabs come with screen brackets and stanchions.

Standard Includes

- Glass screen: 6530 Frosted Glass
- Two brackets, 33"W – 55"W: paint
- Four brackets, 60½"W – 88"W: paint

Required to Specify

- 1 Style number
- 2 Paint color number for brackets
- ▶ See *Surface Materials*, page 402.

Specification Information

• Dimensions		• Style Number	• Price
W	H		

Screens with Brackets

33"	14"	HS4S33G	\$ 523
38½"	14"	HS4S39G	\$ 572
44"	14"	HS4S44G	\$ 621
49½"	14"	HS4S50G	\$ 693
55"	14"	HS4S55G	\$ 742
60½"	14"	HS4S61G	\$ 791
66"	14"	HS4S66G	\$ 841
71½"	14"	HS4S72G	\$ 890
77"	14"	HS4S77G	\$ 939
82½"	14"	HS4S83G	\$ 988
88"	14"	HS4S88G	\$1037

Screen Brackets and Stanchions

Two brackets and stanchions	HS4SA2	\$ 154
Four brackets and stanchions	HS4SA4	\$ 287

Regard Tables

SIN 711.16

Standard Includes	Required to Specify
<ul style="list-style-type: none"> Table top: High-Pressure Laminate, or solid surface Metal support leg and base: paint Edges on laminate table, if selected; 3 mm plastic 	<ol style="list-style-type: none"> Style number Laminate color number for top, if selected Solid surface color number for top, if selected Plastic color number for laminate table edge, if selected Paint color for leg and base Options, if selected (see below) <p>▶ See <i>Surface Materials</i>, page 402.</p>

Tip: Open Line laminate requires a selection of standard edge band finish.

Tip: Table top is 3/4" thick for laminate and 1 1/4" thick for solid surfaces.

Surface Materials	Options	Price	Required to Specify
	Laminate <ul style="list-style-type: none"> Steelcase Health laminate Steelcase laminate Open Line laminate 	No cost No cost +\$91 plus the cost of laminate	▶ See <i>Surface Materials</i> , page 402. ▶ See <i>Surface Materials</i> , page 402. ▶ See <i>Surface Materials</i> , page 402.
	Paint <ul style="list-style-type: none"> Paint price group 1 Paint price group 2 for 22"H square tables Paint price group 2 for 26"H square tables and personal tables Paint price group 3 for square and personal tables 	No cost +\$28 +\$49 +\$99	Specify paint color number. Specify paint color number. Specify paint color number. Specify paint color number. ▶ See <i>Surface Materials</i> , page 402.

Specification Information									
Dimensions			Style Number	Base Prices					
D	W	H		Laminate	Solid Surface Price Group A	Solid Surface Price Group B	Solid Surface Price Group C	Solid Surface Price Group D	
:	:	:	:	:	:	:	:	:	:
:	:	:	:	:	:	:	:	:	:
:	:	:	:	:	:	:	:	:	:
:	:	:	:	:	:	:	:	:	:

Square Tables

Laminate									
22"	22"	15"	HS4T2218L	\$778	N.A.	N.A.	N.A.	N.A.	N.A.
26"	26"	15"	HS4T2618L	\$896	N.A.	N.A.	N.A.	N.A.	N.A.
Solid Surface									
22"	22"	15"	HS4T2218S	N.A.	\$1277	\$1308	\$1350	\$1450	
26"	26"	15"	HS4T2618S	N.A.	\$1392	\$1433	\$1481	\$1587	
:	:	:	:	:	:	:	:	:	:

Personal Tables

Laminate									
22"	22"	29"	HS4T2228L	\$797	N.A.	N.A.	N.A.	N.A.	N.A.
Solid Surface									
22"	22"	29"	HS4T2228S	N.A.	\$1301	\$1332	\$1374	\$1474	
:	:	:	:	:	:	:	:	:	:

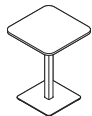
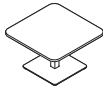

Regard Planters

SIN 711.16



Tip: When mounting to frame, planter must be specified with shelf bracket option.

Tip: 22"D x 22"W planter is for use on the floor only.

Standard Includes	Required to Specify
<ul style="list-style-type: none"> Planter: paint price group 1 Adjustable glides on planter: platinum solid plastic 	<ul style="list-style-type: none"> 1 Style number 2 Paint color for planter 3 Options, if selected (see below) ▶ See <i>Surface Materials</i>, page 402.

Options	Price	Required to Specify
Surface Materials <ul style="list-style-type: none"> Paint price group 1 Paint price group 2 Paint price group 3 	No cost +\$49 +\$99	Specify paint color number. Specify paint color number. Specify paint color number.
Shelf Bracket <ul style="list-style-type: none"> Bracket: black paint only 	+\$51	Specify with <i>shelf bracket option</i> .

Specification Information					
Dimensions			Style	Base	
D	W	H	Number	Price	
11"	22"	14"	HS4P1122	\$692	
11"	33"	14"	HS4P1133	\$769	
11"	44"	14"	HS4P1144	\$820	
22"	22"	14"	HS4P2222	\$718	

Seating

Regard Planter Shelves

SIN 711.16

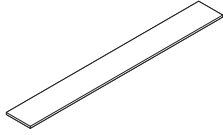

Standard Includes	Required to Specify
<ul style="list-style-type: none"> Shelf: Steelcase Health laminate or Steelcase laminate Edge: plastic 	<ol style="list-style-type: none"> Style number Laminate color number for shelf Plastic color number for laminate shelf edge Options, if selected (see below) <p>▶ See <i>Surface Materials</i>, page 402.</p>

Options	Price	Required to Specify
Surface Materials <ul style="list-style-type: none"> Steelcase Health laminate Steelcase laminate Open Line laminate 	No cost No cost +\$91 plus cost of laminate	<p>▶ See <i>Surface Materials</i>, page 402</p> <p>▶ See <i>Surface Materials</i>, page 402</p> <p>▶ See <i>Surface Materials</i>, page 402</p>

Specification Information			
Dimensions		Style	Base
D	W	Number	Price
11"	44"	HS4LSP44	\$314
11"	55"	HS4LSP55	\$352
11"	60½"	HS4LSP61	\$355
11"	66"	HS4LSP66	\$378
11"	71½"	HS4LSP72	\$381
11"	77"	HS4LSP77	\$424
11"	82½"	HS4LSP83	\$427
11"	88"	HS4LSP88	\$432
:	:	:	:

Regard Planter Liners

SIN 711.16



Tip: Liners come in package of two.

Tip: Liners are recommended when using artificial plants.

Tip: Liners strongly recommended when using live plants.

Standard Includes	Required to Specify
<ul style="list-style-type: none"> Liner: package of two 	Style number

Specification Information

• Dimensions		• Style	• Price
D	W	Number	
11"	22"	HS42L1122	\$190
11"	33"	HS42L1133	\$172
11"	44"	HS42L1144	\$186
22"	22"	HS42L2222	\$262

Seating

Regard Desk and Media Cabinets

SIN 711.16

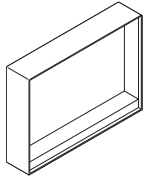

Standard Includes	Required to Specify
<ul style="list-style-type: none"> • Worksurface: laminate or solid surface • Edges on laminate worksurface, if selected: 3 mm plastic • Vertical surfaces: laminate • Back panel, if selected: laminate • Shroud: paint • Display shelves, if selected: paint 	<ol style="list-style-type: none"> 1 Style number 2 Laminate color number for worksurface, if selected 3 Solid surface color number for worksurface, if selected 4 Plastic color number for laminate worksurface edges, if selected 5 Laminate color number for vertical surfaces and back panel, if selected 6 Paint color number for shroud 7 Paint color number for display shelves, if selected 8 Options, if selected (see below) <p>▶ See <i>Surface Materials</i>, page 402.</p>

Options	Price	Required to Specify
<p>Surface Materials</p> <p>Laminate</p> <ul style="list-style-type: none"> • Steelcase Health laminate • Steelcase laminate • Open Line laminate <p>Solid Surface</p> <ul style="list-style-type: none"> • Solid surface price group A • Solid surface price group B • Solid surface price group C • Solid surface price group D 	<p>No cost</p> <p>No cost</p> <p>+\$ 91 plus the cost of laminate</p> <p>No cost</p> <p>+\$117</p> <p>+\$138</p> <p>+\$155</p>	<p>▶ See <i>Surface Materials</i>, page 402.</p> <p>▶ See <i>Surface Materials</i>, page 402.</p> <p>▶ See <i>Surface Materials</i>, page 402.</p> <p>▶ See <i>Surface Materials</i>, page 402.</p> <p>▶ See <i>Surface Materials</i>, page 402.</p> <p>▶ See <i>Surface Materials</i>, page 402.</p> <p>▶ See <i>Surface Materials</i>, page 402.</p>
<p>Omit Back Panel</p> <ul style="list-style-type: none"> • Omit back panel 	<p>-\$154</p>	<p>Specify with no back panel.</p>
<p>Monitor Bracket</p> <ul style="list-style-type: none"> • Small monitor bracket • Large monitor bracket 	<p>+\$123</p> <p>+\$144</p>	<p>Specify with small monitor bracket.</p> <p>Specify with large monitor bracket.</p>
<p>Power Cutout</p> <ul style="list-style-type: none"> • With power cutout 	<p>No cost</p>	<p>Specify with power cutout.</p>
<p>Coat Hook and Bag Retainer</p> <ul style="list-style-type: none"> • Coat hook only with 4799 Platinum • Coat hook only with 4750 Champagne • Bag retainer only with 4799 Platinum • Bag retainer only with 4750 Champagne • Coat hook and bag retainer with 4799 Platinum • Coat hook and bag retainer with 4750 Champagne 	<p>+\$ 51</p> <p>+\$ 51</p> <p>+\$154</p> <p>+\$154</p> <p>+\$205</p> <p>+\$205</p>	<p>Specify with 4799 Platinum coat hook.</p> <p>Specify with 4750 Champagne coat hook.</p> <p>Specify with 4799 Platinum bag retainer.</p> <p>Specify with 4750 Champagne bag retainer.</p> <p>Specify with 4799 Platinum coat hook and bag retainer.</p> <p>Specify with 4750 Champagne coat hook and bag retainer.</p>
<p>Lighting</p> <ul style="list-style-type: none"> • LED lighting 	<p>+\$308</p>	<p>Specify with 6009 Arctic White LED lighting.</p>
<p>Related Products</p> <ul style="list-style-type: none"> • Base frames and frame extensions 		<p>▶ Page 134</p>

Tip: Monitor bracket is available in two sizes for media cabinet only.

Tip: 46"W monitor is recommended for media cabinet.

Tip: Power cutout is available on desk cabinets only.

Tip: Coat hook and bag retainer available on open desk cabinets only.

Tip: LED light is available on desk cabinets only.

Tip: Base frame and frame extensions are ordered separately.

Specification Information

Dimensions			Style Number	Base Price
D	W	H		
		Cabinet Height	Worksurface Height	

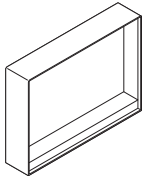

Media Cabinet

11"	55"	40"	N.A.	HS4CM	\$2686
-----	-----	-----	------	--------------	--------

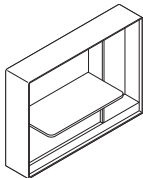

Open Desk Cabinet

Laminate

11"	55"	40"	28 1/2"	HS4D1828L	\$3326
11"	55"	40"	30"	HS4D1830L	\$3326
11"	55"	40"	36"	HS4D1836L	\$3326

Solid Surface

11"	55"	40"	28 1/2"	HS4D1828S	\$3558
11"	55"	40"	30"	HS4D1830S	\$3558
11"	55"	40"	36"	HS4D1836S	\$3558

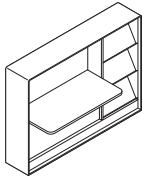

Desk Cabinet with Display Shelves

Laminate

11"	55"	40"	28 1/2"	HS4DR1828L	\$3589
11"	55"	40"	30"	HS4DR1830L	\$3589
11"	55"	40"	36"	HS4DR1836L	\$3589

Solid Surface

11"	55"	40"	28 1/2"	HS4DR1828S	\$3928
11"	55"	40"	30"	HS4DR1830S	\$3928
11"	55"	40"	36"	HS4DR1836S	\$3928

Regard Booth with Table

SIN 711.16

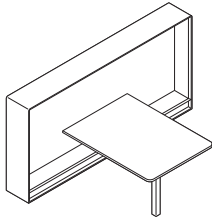

Standard Includes	Required to Specify
<ul style="list-style-type: none"> • Table: laminate or solid surface • Edges on laminate table, if selected: 3 mm plastic • Vertical surfaces: laminate • Back panel, if selected: laminate • Shroud: paint 	<ol style="list-style-type: none"> 1 Style number 2 Laminate color number for table, if selected 3 Solid surface color number for table, if selected 4 Plastic color number for laminate table edges, if selected 5 Laminate color number for vertical surfaces and back panel, if selected 6 Paint color number for shroud 7 Options, if selected (see below) <p>▶ See <i>Surface Materials</i>, page 402.</p>

Options	Price	Required to Specify
Surface Materials Laminate <ul style="list-style-type: none"> • Steelcase Health laminate • Steelcase laminate • Open Line laminate 	No cost No cost +\$ 91 plus the cost of laminate	▶ See <i>Surface Materials</i> , page 402. ▶ See <i>Surface Materials</i> , page 402. ▶ See <i>Surface Materials</i> , page 402.
Solid Surface <ul style="list-style-type: none"> • Solid surface price group A • Solid surface price group B • Solid surface price group C • Solid surface price group D 	No cost +\$117 +\$138 +\$155	▶ See <i>Surface Materials</i> , page 402. ▶ See <i>Surface Materials</i> , page 402. ▶ See <i>Surface Materials</i> , page 402. ▶ See <i>Surface Materials</i> , page 402.
Power Cutout <ul style="list-style-type: none"> • With power cutout 	No cost	Specify with <i>monitor cutout</i> .
Omit Back Panel <ul style="list-style-type: none"> • Omit back panel 	-\$154	Specify with <i>no back panel</i> .
Monitor Bracket <ul style="list-style-type: none"> • Small monitor bracket 	+\$123	Specify with <i>small monitor bracket</i> .
Lighting <ul style="list-style-type: none"> • LED lighting 	+\$308	Specify with <i>6009 Arctic White LED lighting</i> .
Related Products <ul style="list-style-type: none"> • Booth frames 		▶ Page 134

Tip: Monitor bracket is available for monitors 32"W or smaller. 27"W monitor is recommended.

Tip: Booth frame is ordered separately.

Specification Information

• Dimensions		• Style	• Base
D	W	Number	Price
Laminate			
44"	80½"	HS4TC4481L	\$3883
55"	80½"	HS4TC5581L	\$4059
Solid Surface			
44"	80½"	HS4TC4481S	\$3960
55"	80½"	HS4TC5581S	\$4139

Regard Electrical Components

SIN 711.16

Hardwire Power Infeed

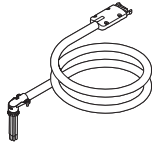

Tip: Vertical cable riser recommended when specifying infeed.
▶ See page 156

Standard Includes		Required to Specify
<ul style="list-style-type: none"> • Circuit 1 and 2 hardwired base power-in • Male modular connector • Strain-relief cable clamp 		Style number
Specification Information		
Dimensions	Style Number	Price
L		
108"	HS4VBPH	\$100

Power Kits

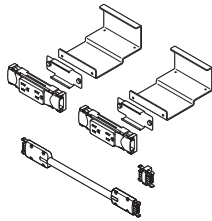

Tip: Power kits are available only with circuit 1. When circuit 2 is required a unique kit is required.

Standard Includes		Required to Specify	
<ul style="list-style-type: none"> • Single power module: 6000 Black 		1 Style number 2 Options, if selected (see below)	
Options	Price	Required to Specify	
Power Modules <ul style="list-style-type: none"> • 2 power modules • 3 power modules • 4 power modules 	Prices below Prices below Prices below	Specify with 2 power modules. Specify with 3 power modules. Specify with 4 power modules.	
Specification Information			
Dimensions	Style Number	Base Price	Options
W			(Add \$ to Base Price)
			2 Power Modules : 3 Power Modules : 4 Power Modules

Single-Sided

	HS4VKS	\$67	+\$ 92	N.A.	N.A.
--	--------	------	--------	------	------

Double-Sided

44"	HS4VKD44	\$67	+\$172	N.A.	N.A.
55"	HS4VKD55	\$67	+\$ 92	N.A.	N.A.
60 1/2"	HS4VKD61	\$67	+\$172	+\$329	N.A.
66"	HS4VKD66	\$67	+\$172	+\$329	N.A.
71 1/2"	HS4VKD72	\$67	+\$ 92	+\$255	N.A.
77"	HS4VKD77	\$67	+\$ 92	+\$255	N.A.
82 1/2"	HS4VKD83	\$67	+\$ 92	+\$255	N.A.
88"	HS4VKD88	\$67	+\$ 92	+\$255	+\$357

Regard Electrical Components, continued

SIN 711.16

Power Strips

Standard Includes	Required to Specify
<ul style="list-style-type: none"> • Frame-mounted power strip: clear anodized aluminum only • Utility power strip faceplate: paint • Power cord 	<ol style="list-style-type: none"> 1 Style number 2 Paint color number for utility power strip faceplate, if selected 3 Power cord (see below under Required Selections) 4 Options, if selected (see below) <p>▶ See <i>Surface Materials</i>, page 402.</p>

Power Cord	Required Selections	Price	Required to Specify
	<ul style="list-style-type: none"> • 6'L Axil Z power cord • 6'L over current protection cord 	<p>No cost</p> <p>+\$26</p>	<p>Specify with 6' power cord.</p> <p>Specify with 6' power cord with over current protection.</p>
	<ul style="list-style-type: none"> • 10'L Axil Z power cord • 10'L over current protection cord 	<p>+\$46</p> <p>+\$72</p>	<p>Specify with 10' power cord.</p> <p>Specify with 10' power cord with over current protection.</p>

Tip: 10'L cord option available on corded power strips only.

Tip: California requires over current protection on corded power strips.

Tip: California does not require over current protection on hardwire power strips.

Tip: USB/USB configurations are not available.

Tip: 6' and 10' cord options are available with all power configurations.

Power Configuration	Options	Price	Required to Specify
	<ul style="list-style-type: none"> • Power/power • Tamper resistant • Power/USB • Tamper resistant/USB 	<p>No cost</p> <p>+\$14</p> <p>+\$79</p> <p>+\$86</p>	<p>Specify with power/power.</p> <p>Specify 2 tamper resistant.</p> <p>Specify with 1 power/1 USB.</p> <p>Specify with 1 tamper resistant/1 USB.</p>

Specification Information		
Dimensions	Style	Base
L	Number	Price

For Use with Frame Assembly

Corded		
6'	HS4VPSFC	\$205
Hardwire		
	HS4VPSFH	\$205

For Use with Utility Arms/Desk/Booth

Corded		
6'	HS4VPSDC	\$205
Hardwire		
	HS4VPSDH	\$205

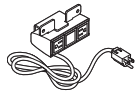

Receptacle Kits

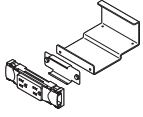

Tip: Receptacle kits are used when adding circuit 2 or when assembling a unique kit.

► See power kits, page 153 for standard configurations.

Standard Includes	Required to Specify
<ul style="list-style-type: none"> Single power module: 6000 Black 	Style number

Specification Information

Dimensions W	Style Number	Price
1-Circuit		
11 ³ / ₄ "	HS4VK1	\$67
2-Circuit		
11 ³ / ₄ "	HS4VK2	\$67

Modular Harness

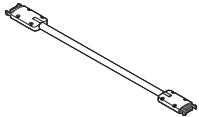

Tip: Modular harness only required when assembling a unique kit.

► See power kits, page 153 for standard configurations.

Standard Includes	Required to Specify
<ul style="list-style-type: none"> Non-PVC modular harness 	Style number

Specification Information

Dimensions L	Style Number	Price
12"	HS4VH12	\$ 90
15"	HS4VH15	\$ 93
18"	HS4VH18	\$ 96
21"	HS4VH21	\$ 99
24"	HS4VH24	\$103
27"	HS4VH27	\$106
30"	HS4VH30	\$109
33"	HS4VH33	\$112
36"	HS4VH36	\$115
39"	HS4VH39	\$118
42"	HS4VH42	\$121

Regard Electrical Components, continued

SIN 711.16

Connectors

Standard Includes	Required to Specify
<ul style="list-style-type: none"> • Connector 	Style number

Specification Information

• Style Number	• Price



In-Line

HS4VNL	\$26



Branching

HS4VNB	\$31

Vertical Cable Riser

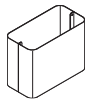

Tip: Vertical cable riser is bolted to the floor and includes attachment hardware. Vertical cable riser is recommended when specifying hardwire power infeed.

Standard Includes	Required to Specify
<ul style="list-style-type: none"> • Cable riser: paint • Attachment hardware 	1 Style number 2 Paint color number for cable riser ▶ See <i>Surface Materials</i> , page 402.

Specification Information

• Dimensions		• Style Number	• Price
D	W		
11 1/8"	6"	HS4VCR	\$154

Cable Clamp



Tip: Cable clamp is included with hardwire power infeed. Cable clamp can be in used in place of cable ties provided with power kits if required.

Standard Includes	Required to Specify
<ul style="list-style-type: none"> • Cable clamp 	Style number

Specification Information

• Style Number	• Price
HS4VCC	\$24

Verge Stool

SIN 711.99

Seating

Standard Includes	Required to Specify
<ul style="list-style-type: none"> • Seat: self-skinning urethane in non-metallic steel finish • Four-leg base and foot ring: paint • Glides, if selected: plastic in metallic steel finish • Casters, if selected: black 	<ul style="list-style-type: none"> 1 Style number 2 Paint color number for base and foot ring ▶ See <i>Surface Materials</i>, page 402.

Specification Information

• Dimensions		• Style	• Price
W	H	Number	
:	:	:	:

Tip: Stool is 19"H when glides are specified.



With Glides

18¼"	19"	HS21G	\$437
18¼"	27"	HS27G	\$437
18¼"	31"	HS31G	\$481
:	:	:	:



With Casters

18¼"	21"	HS21C	\$437
:	:	:	:

Sorrel

SIN 711.19

18" Wide Stacking Chairs

With Arms and Armless

Standard Includes	Required to Specify
-------------------	---------------------

- | | | |
|--|--|--|
| <ul style="list-style-type: none"> ▶ Need help? Product details, see <i>Steelcase Health Volume 1 Specification Guide</i> | <ul style="list-style-type: none"> • Seat: fabric • Back: fabric or maple wood • Arm caps, if selected: plastic to coordinate with frame • Legs and frame: paint • Glides: black plastic • Ganging brackets, if selected: paint (ordered separately) | <ol style="list-style-type: none"> 1 Style number 2 Fabric color number for seat 3 Fabric or wood color number for back 4 Paint color number for legs and frame 5 Leg style (see below under Required Selections) 6 Paint color for ganging brackets, if selected 7 Options, if selected (see below) <p>▶ See <i>Surface Materials</i>, page 402.</p> |
|--|--|--|

Tip: Different fabrics for the seat and back can be specified. If the fabrics are in different price groups, calculate list price by adding the two price groups together and dividing by two.

Tip: Chairs stack six high alone. Straight leg chairs stack ten high on a dolly.

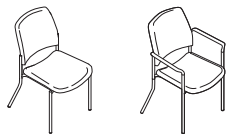

Wallsaver
Legs without
Arms

Wallsaver
Legs with
Arms

Tip: Stackability is not affected by thick seat option.

Tip: Leg guard finish will coordinate with frame finish selection.

Required Selections	Price	Required to Specify
Leg Style		
• Straight legs	No cost	Specify with straight legs.
• Wallsaver legs	+\$16	Specify with wallsaver legs.

Options	Price	Required to Specify
Surface Materials		
• Moisture barrier	+\$96	Specify with moisture barrier.
Seat		
• Thick seat	+\$38	Specify with thick seat.
Leg Guards		
• Leg guards	+\$33	Specify with leg guards.
Glides		
• Soft felt glides	+\$ 6	Specify with soft glides.

Specification Information

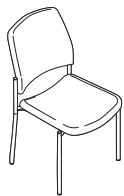

Straight Legs

Base Prices

Style Number	Fabric Price Group 1	Fabric Price Group 2	Fabric Price Group 3	Fabric Price Group 4	Fabric Price Group 5	Fabric Price Group 6	Fabric Price Group 7	Fabric Price Group 8	Fabric Price Group 9	Fabric Price Group 10	COM
--------------	----------------------	----------------------	----------------------	----------------------	----------------------	----------------------	----------------------	----------------------	----------------------	-----------------------	-----

18" Wide Stacking Chair without Arms, With Upholstered Back

SC1060SN	\$325	\$353	\$387	\$407	\$429	\$453	\$475	\$509	\$557	\$583	\$357
----------	-------	-------	-------	-------	-------	-------	-------	-------	-------	-------	-------

18" Wide Stacking Chair without Arms, With Wood Back

SC1060SN	\$458	\$472	\$489	\$499	\$510	\$522	\$533	\$550	\$574	\$587	\$474
----------	-------	-------	-------	-------	-------	-------	-------	-------	-------	-------	-------

Specification Information

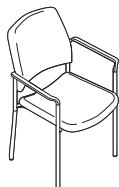

Straight Legs

Base Prices

Style Number	Fabric Price Group 1	Fabric Price Group 2	Fabric Price Group 3	Fabric Price Group 4	Fabric Price Group 5	Fabric Price Group 6	Fabric Price Group 7	Fabric Price Group 8	Fabric Price Group 9	Fabric Price Group 10	COM
--------------	----------------------	----------------------	----------------------	----------------------	----------------------	----------------------	----------------------	----------------------	----------------------	-----------------------	-----

18" Wide Stacking Chair with Arms, With Upholstered Back

SC1060SA	\$343	\$371	\$405	\$425	\$447	\$471	\$493	\$527	\$575	\$601	\$375
----------	-------	-------	-------	-------	-------	-------	-------	-------	-------	-------	-------

18" Wide Stacking Chair with Arms, With Wood Back

SC1060SA	\$476	\$490	\$507	\$517	\$528	\$540	\$551	\$568	\$592	\$605	\$492
----------	-------	-------	-------	-------	-------	-------	-------	-------	-------	-------	-------

Specification Information

Style Number	Price
--------------	-------

Pair of Ganging Brackets

SC1080	\$39
--------	------

Sorrel, continued

SIN 711.19

22" Wide Stacking Chairs

With Arms and Armless

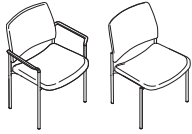

Tip: Different fabrics for the seat and back can be specified. If the fabrics are in different price groups, calculate list price by adding the two price groups together and dividing by two.

Tip: Chairs stack six high alone.

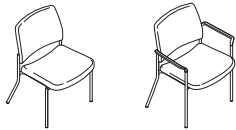

Wallsaver
Legs without
Arms

Wallsaver
Legs with
Arms

Tip: Stackability is not affected by thick seat option.

Tip: Leg guard finish will coordinate with frame finish selection.

Standard Includes	Required to Specify
<ul style="list-style-type: none"> • Seat: fabric • Back: fabric or maple wood • Arm caps, if selected: plastic to coordinate with frame • Legs and frame: paint • Glides: black plastic • Ganging brackets, if selected: paint (ordered separately) 	<ol style="list-style-type: none"> 1 Style number 2 Fabric color number for seat 3 Fabric or wood color number for back 4 Paint color number for legs and frame 5 Leg style (see below under Required Selections) 6 Paint color for ganging brackets, if selected 7 Options, if selected (see below) <p>▶ See <i>Surface Materials</i>, page 402.</p>

Required Selections	Price	Required to Specify
Leg Style	<ul style="list-style-type: none"> • Straight legs • Wallsaver legs 	<p>No cost</p> <p>+\$16</p> <p>Specify <i>with straight legs</i>. Specify <i>with wallsaver legs</i>.</p>

Options	Price	Required to Specify
Surface Materials	<ul style="list-style-type: none"> • Moisture barrier 	<p>+\$96</p> <p>Specify <i>with moisture barrier</i>.</p>
Seat	<ul style="list-style-type: none"> • Thick seat 	<p>+\$38</p> <p>Specify <i>with thick seat</i>.</p>
Leg Guards	<ul style="list-style-type: none"> • Leg guards 	<p>+\$33</p> <p>Specify <i>with leg guards</i>.</p>
Glides	<ul style="list-style-type: none"> • Soft felt glides 	<p>+\$ 6</p> <p>Specify <i>with soft glides</i>.</p>

Specification Information



Straight Legs

• Style Number	• Base Prices										• COM
	• Fabric Price Group 1	• Fabric Price Group 2	• Fabric Price Group 3	• Fabric Price Group 4	• Fabric Price Group 5	• Fabric Price Group 6	• Fabric Price Group 7	• Fabric Price Group 8	• Fabric Price Group 9	• Fabric Price Group 10	

22" Wide Stacking Chair without Arms, With Upholstered Back

• SC1062SN	\$387	\$429	\$469	\$501	\$531	\$561	\$591	\$639	\$707	\$745	\$419
------------	-------	-------	-------	-------	-------	-------	-------	-------	-------	-------	-------

22" Wide Stacking Chair without Arms, With Wood Back

• SC1062SN	\$520	\$541	\$561	\$577	\$592	\$607	\$622	\$646	\$680	\$699	\$536
------------	-------	-------	-------	-------	-------	-------	-------	-------	-------	-------	-------



Straight Legs

• Style Number	• Base Prices										• COM
	• Fabric Price Group 1	• Fabric Price Group 2	• Fabric Price Group 3	• Fabric Price Group 4	• Fabric Price Group 5	• Fabric Price Group 6	• Fabric Price Group 7	• Fabric Price Group 8	• Fabric Price Group 9	• Fabric Price Group 10	

22" Wide Stacking Chair with Arms, With Upholstered Back

• SC1062SA	\$405	\$447	\$487	\$519	\$549	\$579	\$609	\$657	\$725	\$763	\$437
------------	-------	-------	-------	-------	-------	-------	-------	-------	-------	-------	-------

22" Wide Stacking Chair with Arms, With Wood Back

• SC1062SA	\$538	\$559	\$579	\$595	\$610	\$625	\$640	\$664	\$698	\$717	\$554
------------	-------	-------	-------	-------	-------	-------	-------	-------	-------	-------	-------

Specification Information

• Style Number	• Price
----------------	---------

Pair of Ganging Brackets

• SC1080	\$39
----------	------

Sorrel, continued

SIN 711.19

Bariatric Stacking Chair



Tip: Different fabrics for the seat and back can be specified. If the fabrics are in different price groups, calculate list price by adding the two price groups together and dividing by two.

Tip: Chairs stack four high alone. Straight leg chairs stack six high on a dolly.



Wallsaver Legs

Tip: Stackability is not affected by thick seat option.

Tip: Leg guard finish will coordinate with frame finish selection.

Standard Includes	Required to Specify
<ul style="list-style-type: none"> ▶ Need help? Product details, see <i>Steelcase Health Volume 1 Specification Guide</i> • Seat: fabric • Back: fabric or maple wood • Arm caps: plastic to coordinate with frame • Legs and frame: paint • Glides: black plastic • Ganging brackets, if selected: paint (ordered separately) 	<ol style="list-style-type: none"> 1 Style number 2 Fabric color number for seat 3 Fabric or wood color number for back 4 Paint color number for legs and frame 5 Leg style (see below under Required Selections) 6 Paint color for ganging brackets, if selected 7 Options, if selected (see below) <p>▶ See <i>Surface Materials</i>, page 402.</p>

Required Selections	Price	Required to Specify
Leg Style		
• Straight legs	No cost	Specify with <i>straight legs</i> .
• Wallsaver legs	+\$16	Specify with <i>wallsaver legs</i> .

Options	Price	Required to Specify
Surface Materials		
• Moisture barrier	+\$96	Specify with <i>moisture barrier</i> .
Seat		
• Thick seat	+\$38	Specify with <i>thick seat</i> .
Leg Guards		
• Leg guards	+\$33	Specify with <i>leg guards</i> .
Glides		
• Soft felt glides	+\$ 6	Specify with <i>soft glides</i> .

Specification Information

Style Number	Base Prices										COM
	Fabric Price Group 1	Fabric Price Group 2	Fabric Price Group 3	Fabric Price Group 4	Fabric Price Group 5	Fabric Price Group 6	Fabric Price Group 7	Fabric Price Group 8	Fabric Price Group 9	Fabric Price Group 10	

Bariatric Stacking Chair With Upholstered Back

Style Number	Fabric Price Group 1	Fabric Price Group 2	Fabric Price Group 3	Fabric Price Group 4	Fabric Price Group 5	Fabric Price Group 6	Fabric Price Group 7	Fabric Price Group 8	Fabric Price Group 9	Fabric Price Group 10	COM
SC1065SA	\$474	\$528	\$576	\$620	\$658	\$694	\$732	\$794	\$880	\$930	\$506

Bariatric Stacking Chair With Wood Back

Style Number	Fabric Price Group 1	Fabric Price Group 2	Fabric Price Group 3	Fabric Price Group 4	Fabric Price Group 5	Fabric Price Group 6	Fabric Price Group 7	Fabric Price Group 8	Fabric Price Group 9	Fabric Price Group 10	COM
SC1065SA	\$607	\$634	\$658	\$680	\$699	\$717	\$736	\$767	\$810	\$835	\$623

Specification Information

Style Number	Price

Pair of Ganging Brackets

Style Number	Price
SC1080	\$39

18"W Easy Access Chairs

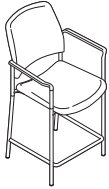

Tip: Different fabrics for the seat and back can be specified. If the fabrics are in different price groups, calculate list price by adding the two price groups together and dividing by two.

Tip: Leg guard finish will coordinate with frame finish selection.

Standard Includes	Required to Specify
<ul style="list-style-type: none"> Need help? Product details, see <i>Steelcase Health Volume 1 Specification Guide</i> Seat: fabric Back: fabric or maple wood Arm caps: plastic to coordinate with frame Legs and frame: paint Glides: black plastic Ganging brackets, if selected: paint (ordered separately) 	<ol style="list-style-type: none"> Style number Fabric color number for seat Fabric or wood color number for back Paint color number for legs and frame Paint color for ganging brackets, if selected Options, if selected (see below) <p>▶ See <i>Surface Materials</i>, page 402.</p>

Options	Price	Required to Specify
Surface Materials • Moisture barrier	+\$96	Specify with moisture barrier.
Seat • Thick seat	+\$38	Specify with thick seat.
Leg Guards • Leg guards	+\$33	Specify with leg guards.
Glides • Soft felt glides	+\$ 6	Specify with soft glides.

Specification Information

Style Number	Base Prices										COM
	Fabric Price Group 1	Fabric Price Group 2	Fabric Price Group 3	Fabric Price Group 4	Fabric Price Group 5	Fabric Price Group 6	Fabric Price Group 7	Fabric Price Group 8	Fabric Price Group 9	Fabric Price Group 10	

18"W Easy Access Chairs With Upholstered Back

Style Number	Fabric Price Group 1	Fabric Price Group 2	Fabric Price Group 3	Fabric Price Group 4	Fabric Price Group 5	Fabric Price Group 6	Fabric Price Group 7	Fabric Price Group 8	Fabric Price Group 9	Fabric Price Group 10	COM
SC1067EA	\$437	\$465	\$499	\$519	\$541	\$565	\$587	\$621	\$669	\$695	\$469

18"W Easy Access Chairs With Wood Back

Style Number	Fabric Price Group 1	Fabric Price Group 2	Fabric Price Group 3	Fabric Price Group 4	Fabric Price Group 5	Fabric Price Group 6	Fabric Price Group 7	Fabric Price Group 8	Fabric Price Group 9	Fabric Price Group 10	COM
SC1067EA	\$570	\$584	\$601	\$611	\$622	\$634	\$645	\$662	\$686	\$699	\$586

Specification Information

Style Number	Price
--------------	-------

Pair of Ganging Brackets

Style Number	Price
SC1080	\$39

Sorrel, continued

SIN 711.19

22" Wide Easy Access Chairs



Standard Includes **Required to Specify**

- | | |
|---|---|
| <ul style="list-style-type: none"> • Seat: fabric • Back: fabric or maple wood • Arm caps: plastic to coordinate with frame • Legs and frame: paint • Glides: black plastic • Ganging brackets, if selected: paint (ordered separately) | <ol style="list-style-type: none"> 1 Style number 2 Fabric color number for seat 3 Fabric or wood color number for back 4 Paint color number for legs and frame 5 Paint color for ganging brackets, if selected 6 Options, if selected (see below) <p>▶ See <i>Surface Materials</i>, page 402.</p> |
|---|---|

Tip: Different fabrics for the seat and back can be specified. If the fabrics are in different price groups, calculate list price by adding the two price groups together and dividing by two.

Tip: Leg guard finish will coordinate with frame finish selection.

	Options	Price	Required to Specify
Surface Materials	• Moisture barrier	+\$96	Specify with <i>moisture barrier</i> .
Seat	• Thick seat	+\$38	Specify with <i>thick seat</i> .
Leg Guards	• Leg guards	+\$33	Specify with <i>leg guards</i> .
Glides	• Soft felt glides	+\$ 6	Specify with <i>soft glides</i> .

Specification Information

Style Number	Base Prices										COM
	Fabric Price Group 1	Fabric Price Group 2	Fabric Price Group 3	Fabric Price Group 4	Fabric Price Group 5	Fabric Price Group 6	Fabric Price Group 7	Fabric Price Group 8	Fabric Price Group 9	Fabric Price Group 10	

22" Wide Easy Access Chairs With Upholstered Back

SC1069EA	\$499	\$541	\$581	\$613	\$643	\$673	\$703	\$751	\$819	\$857	\$531
----------	-------	-------	-------	-------	-------	-------	-------	-------	-------	-------	-------

22" Wide Easy Access Chairs With Wood Back

SC1069EA	\$632	\$653	\$673	\$689	\$704	\$719	\$734	\$758	\$792	\$811	\$648
----------	-------	-------	-------	-------	-------	-------	-------	-------	-------	-------	-------

Specification Information

Style Number	Price
--------------	-------

Pair of Ganging Brackets

SC1080	\$39
--------	------

Dolly Carts

Standard Includes	Required to Specify
<ul style="list-style-type: none"> ▶ Need help? Product details, see <i>Steelcase Health Volume 1 Specification Guide</i> • Dolly frame: black • Casters: black only 	<ul style="list-style-type: none"> • Style number

Specification Information				
• Dimensions			• Style	• Price
D	W	H	Number	

Dolly for 18" Wide Stacking Chairs

31 ⁵ / ₈ "	21 ¹ / ₂ "	43 ¹ / ₄ "	SC1060D	\$360

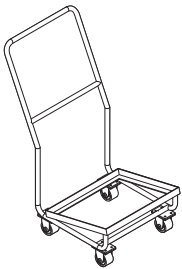

Tip: Dolly cart can hold 10 18"W straight leg stacked chairs.

Dolly for Bariatric Stacking Chairs

31 ⁵ / ₈ "	29 ¹ / ₂ "	43 ¹ / ₄ "	SC1065D	\$402

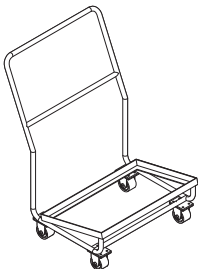

Tip: Dolly cart can hold six stacked bariatric chairs.

Tip: Dolly carts do not accommodate Sorrel wall-saver styles.

Sorrel Table

SIN 711.19



Tip: Open Line laminate requires a selection of standard edge band finish.

Tip: Leg guard finish will coordinate with frame finish selection.

Standard Includes	Required to Specify
<ul style="list-style-type: none"> Table top and edge: High-Pressure Laminate with 3 mm plastic edge Round legs: paint Glides: black plastic 	<ol style="list-style-type: none"> Style number High-Pressure Laminate color number for top Plastic color number for laminate table edge Paint color number for legs Options, if selected (see below) <p>▶ See <i>Surface Materials</i>, page 402.</p>

Options	Price	Required to Specify
Surface Materials Laminate <ul style="list-style-type: none"> Steelcase Health laminate Steelcase laminate Open Line laminate 	No cost No cost +\$91 plus the cost of laminate	<p>▶ See <i>Surface Materials</i>, page 402.</p> <p>▶ See <i>Surface Materials</i>, page 402.</p> <p>▶ See <i>Surface Materials</i>, page 402.</p>
Leg Guards <ul style="list-style-type: none"> Leg guards 	+\$33	Specify with leg guards.
Glides <ul style="list-style-type: none"> Soft felt glides 	+\$ 6	Specify with soft glides.

Specification Information				
Dimensions			Style Number	Base Price
D	W	H		
18"	18"	16"	SC10621818	\$314

Empath Recliners

SIN 711.16



Tip: Left and right for flip-down arms, tablet, and IV pole holder are determined when facing the front of the chair.

Tip: Different fabrics for the seat, back, sides, and front can be specified. If the fabrics are in different price groups, calculate list price by adding the price groups for each surface together and dividing by four. For example, if specifying seat and front fabric both in group 2, sides in group 4, and back in group 6, add the list price in price group 2 twice (seat + front), price group 4 once (sides), and price group 6 (back) once then divide by four.

Tip: Tablet can be located on a fixed arm only. It is not available on dual flip-down arm models. If specified on right flip-down arm models or on the left side facing arm of fixed arm models, the footrest lever will be placed on the right side facing arm panel, opposite the tablet.

Tip: Directional steering, push bar, and pull out footrest are ordered separately.

Tip: IV pole option does not include pole holder. Must order IV pole holder option and specify location in order to attach IV pole to the chair.

Tip: Drainage bag hanger is available on fixed arm and left flip-down arm models only and will be positioned on the arm opposite of the footrest control lever.

Standard Includes	Required to Specify
<ul style="list-style-type: none"> • Seat, back, and arm panels: fabric • Upper arms: urethane over molded foam • Bumpers: plastic to match upper arms • Footrest scallop: plastic to match upper arms • Dual backrest recline activation • 4" central locking casters with activation pedals on both sides: housing color to match upper arms • Headrest, if selected: fabric 	<ol style="list-style-type: none"> 1 Style number 2 Fabric color number for seat and back 3 Urethane color number for upper arms 4 Options, if selected (see below) <p>▶ See <i>Surface Materials</i>, page 402.</p>

Options	Price	Required to Specify
Surface Materials <ul style="list-style-type: none"> • Moisture barrier 	+\$ 192	Specify with <i>moisture barrier</i> .
Adjustable Headrest <ul style="list-style-type: none"> • Adjustable headrest 	+\$ 190	Specify with <i>headrest</i> and select fabric color number.
Heat and Massage <ul style="list-style-type: none"> • Heat only • Heat and massage 	+\$ 891 +\$1188	Specify with <i>heat</i> . Specify with <i>heat and massage</i> .
Tablet Arm <ul style="list-style-type: none"> • Flip up tablet arm 	+\$ 613	Specify with <i>flip up tablet arm</i> , indicate left or right facing, and select thermoform color number.
Directional Seating <ul style="list-style-type: none"> • Directional steering 	+\$ 410	Specify with <i>directional steering</i> .
Push Bar <ul style="list-style-type: none"> • Push bar 	+\$ 177	Specify with <i>push bar</i> .
Pull Out Footrest <ul style="list-style-type: none"> • Pull out footrest 	+\$ 442	Specify with <i>pull out footrest</i> .
IV Pole Holder <ul style="list-style-type: none"> • IV pole holder 	+\$ 101	Specify with <i>IV pole holder</i> and indicate left or right facing.
IV Pole <ul style="list-style-type: none"> • IV pole 	+\$ 305	Specify with <i>IV pole</i> .
Drainage Bag Hanger <ul style="list-style-type: none"> • Drainage bag hanger 	+\$ 56	Specify with <i>drainage bag hanger</i> .

Specification Information

Style Number	Base Prices										COM
	Fabric Price Group 1	Fabric Price Group 2	Fabric Price Group 3	Fabric Price Group 4	Fabric Price Group 5	Fabric Price Group 6	Fabric Price Group 7	Fabric Price Group 8	Fabric Price Group 9	Fabric Price Group 10	

Recliner

With Fixed Arms

HR223	\$4291	\$4461	\$4617	\$4747	\$4879	\$4979	\$5111	\$5303	\$5569	\$5723	\$4353
--------------	--------	--------	--------	--------	--------	--------	--------	--------	--------	--------	--------



With Left Flip-Down Arm

HR223L	\$4710	\$4880	\$5036	\$5166	\$5298	\$5398	\$5530	\$5722	\$5988	\$6142	\$4772
---------------	--------	--------	--------	--------	--------	--------	--------	--------	--------	--------	--------

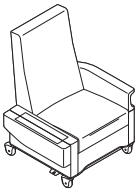

With Right Flip-Down Arm

HR223R	\$4710	\$4880	\$5036	\$5166	\$5298	\$5398	\$5530	\$5722	\$5988	\$6142	\$4772
---------------	--------	--------	--------	--------	--------	--------	--------	--------	--------	--------	--------



With Dual Flip-Down Arms

HR223D	\$5078	\$5248	\$5404	\$5534	\$5666	\$5766	\$5898	\$6090	\$6356	\$6510	\$5140
---------------	--------	--------	--------	--------	--------	--------	--------	--------	--------	--------	--------

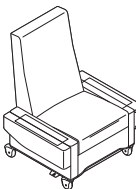

► Specification Information, continued on next page

Empath Recliners, continued

SIN 711.16

► Specification Information, continued from previous page

Specification Information

Style Number	Base Prices										COM
	Fabric Price Group 1	Fabric Price Group 2	Fabric Price Group 3	Fabric Price Group 4	Fabric Price Group 5	Fabric Price Group 6	Fabric Price Group 7	Fabric Price Group 8	Fabric Price Group 9	Fabric Price Group 10	

Recliner with Trendelenburg

With Fixed Arms

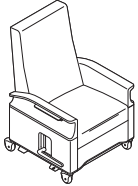

HR223T	\$4631	\$4801	\$4957	\$5087	\$5219	\$5319	\$5451	\$5643	\$5909	\$6063	\$4693
---------------	--------	--------	--------	--------	--------	--------	--------	--------	--------	--------	--------

With Left Flip-Down Arm

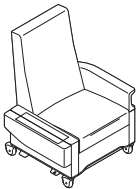

HR223TL	\$5050	\$5220	\$5376	\$5506	\$5638	\$5738	\$5870	\$6062	\$6328	\$6482	\$5112
----------------	--------	--------	--------	--------	--------	--------	--------	--------	--------	--------	--------

With Right Flip-Down Arm



HR223TR	\$5050	\$5220	\$5376	\$5506	\$5638	\$5738	\$5870	\$6062	\$6328	\$6482	\$5112
----------------	--------	--------	--------	--------	--------	--------	--------	--------	--------	--------	--------

With Dual Flip-Down Arms

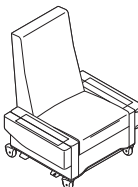

HR223TD	\$5418	\$5588	\$5744	\$5874	\$6006	\$6106	\$6238	\$6430	\$6696	\$6850	\$5480
----------------	--------	--------	--------	--------	--------	--------	--------	--------	--------	--------	--------

Mineral Recliners

SIN 711.16

Tip: Left and right for flip-down arms, tablet arm, IV pole holder, and drainage bag hanger are determined when facing the front of the chair.

Tip: Different fabrics for the seat, back, sides, and front can be specified. If the fabrics are in different price groups, calculate list price by adding the price groups for each surface together and dividing by four. For example, if specifying seat and front fabric both in group 2, sides in group 4, and back in group 6, add the list price in price group 2 twice (seat + front), price group 4 once (sides), and price group 6 (back) once then divide by four.

Tip: Tablet can only be specified on fixed arm model. If mounted on the left, recline levers will be placed on the right arm panel when facing the front of the chair.

Tip: Tablet arm option can be specified in conjunction with the IV pole holder and/or drainage bag hanger.

Tip: On flip-down arm models, the IV pole holder and/or drainage bag hanger will be positioned on the arm opposite of the flip-down arm.

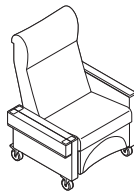

Standard Includes	Required to Specify
<ul style="list-style-type: none"> • Seat, back, and arm panels: fabric • Arm caps: wood • 4" non-marring casters: grey 	1 Style number 2 Fabric color number for seat and back 3 Wood color number for arm cap 4 Options, if selected (see below) ▶ See <i>Surface Materials</i> , page 402.

Options	Price	Required to Specify
Surface Materials		
• Moisture barrier	+\$ 192	Specify with moisture barrier.
Heat and Massage		
• Heat only	+\$ 891	Specify with heat.
• Heat and massage	+\$1188	Specify with heat and massage.
Arm Caps		
• Plastisol arm caps	+\$ 103	Specify with plastisol arm caps and select plastic color number.
Tablet arm		
• Tablet arm	+\$ 405	Specify with tablet and indicate left or right facing.
Push Bar		
• Push bar	+\$ 177	Specify with push bar.
Pull Out Footrest		
• Pull out footrest	+\$ 442	Specify with pull out footrest.
IV Pole Holder		
• IV pole holder	+\$ 101	Specify with IV pole holder and for fixed arm model, indicate left or right facing.
Drainage Bag Hanger		
• Drainage bag hanger	+\$ 56	Specify with drainage bag hanger and for fixed arm model, indicate left or right facing.
Legs		
• Casters	No cost	Specify with casters.
• Legs	No cost	Specify with legs and select wood color number.

Specification Information											
Style Number	Base Prices										COM
	Fabric Price Group 1	Fabric Price Group 2	Fabric Price Group 3	Fabric Price Group 4	Fabric Price Group 5	Fabric Price Group 6	Fabric Price Group 7	Fabric Price Group 8	Fabric Price Group 9	Fabric Price Group 10	

With Fixed Arms											
SC2091	\$3187	\$3343	\$3499	\$3621	\$3747	\$3841	\$3963	\$4149	\$4397	\$4553	\$3249

With Left Flip-Down Arm											
SC2091L	\$3731	\$3887	\$4043	\$4165	\$4291	\$4385	\$4507	\$4693	\$4941	\$5097	\$3793

With Right Flip-Down Arm											
SC2091R	\$3731	\$3887	\$4043	\$4165	\$4291	\$4385	\$4507	\$4693	\$4941	\$5097	\$3793

Seating

Mitra Recliner

SIN 711.16

Standard Includes	Required to Specify
<ul style="list-style-type: none"> • Seat, back, and arm panels: fabric • Arm caps: wood • Casters: 4" non-marring 	<ol style="list-style-type: none"> 1 Style number 2 Fabric color number for seat and back 3 Wood color number for arm cap 4 Options, if selected (see below) <p>▶ See <i>Surface Materials</i>, page 402.</p>

Tip: Different fabrics for the seat, back, sides, and front can be specified. If the fabrics are in different price groups, calculate list price by adding the price groups for each surface together and dividing by four. For example, if specifying seat and front fabric both in group 2, sides in group 4, and back in group 6, add the list price in price group 2 twice (seat + front), price group 4 once (sides), and price group 6 (back) once then divide by four.

Tip: If tablet is specified on the left, the recline levers will be positioned on the right arm panel when facing the front of the chair.

Tip: IV pole holder and/or drainage bag hanger will be positioned on the arm opposite the recline levers.

Options	Price	Required to Specify
Surface Materials	Moisture barrier	
	• Moisture barrier	+\$ 192
		Specify with moisture barrier.
Heat and Massage		
	• Heat only	+\$ 891
	• Heat and massage	+\$1188
		Specify with heat.
		Specify with heat and massage
Arm caps		
	• Plastisol arm caps	+\$ 102
		Specify with plastisol arm caps and select plastic color number.
Tablet arm		
	• Tablet arm	+\$ 405
		Specify with tablet and indicate left or right facing.
Push Bar		
	• Push bar	+\$ 177
		Specify with push bar.
Pull Out Footrest		
	• Pull out footrest	+\$ 442
		Specify with pull out footrest.
IV Pole Holder		
	• IV pole holder	+\$ 101
		Specify with IV pole holder.
Drainage Bag Hanger		
	• Drainage bag hanger	+\$ 56
		Specify with drainage bag hanger.
Legs		
	• Casters	No cost
	• Legs	No cost
		Specify with casters.
		Specify with legs and select wood color number.

Specification Information

Base Prices											
Style Number	Fabric Price Group 1	Fabric Price Group 2	Fabric Price Group 3	Fabric Price Group 4	Fabric Price Group 5	Fabric Price Group 6	Fabric Price Group 7	Fabric Price Group 8	Fabric Price Group 9	Fabric Price Group 10	COM

Recliner

SC6091	\$3571	\$3727	\$3883	\$4005	\$4131	\$4225	\$4347	\$4533	\$4787	\$4937	\$3633
---------------	--------	--------	--------	--------	--------	--------	--------	--------	--------	--------	--------

Recliner with Trendelenburg

SC6091T	\$4131	\$4287	\$4443	\$4565	\$4691	\$4785	\$4907	\$5093	\$5347	\$5497	\$4193
----------------	--------	--------	--------	--------	--------	--------	--------	--------	--------	--------	--------

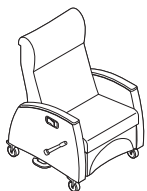
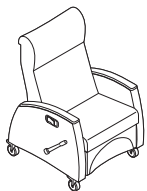

Mitra Sleeper Chair

SIN 711.16

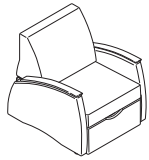

Tip: Back, seat, and front panel fabric will match. Different fabrics for the center cushions and side panels can be specified. If the fabrics are in different price groups, calculate list price by adding the two price groups together and dividing by two.

Tip: Fabrics can only be upholstered in a vertical (top out or down roll) direction because of the size of the center cushions.

Standard Includes	Required to Specify
-------------------	---------------------

- Seat, back, and front panel: fabric
- Center and side panels: fabric
- Arm caps: maple wood or plastisol
- Casters: black

- 1 Style number
 - 2 Fabric color number for seat, back, and front panel
 - 3 Fabric color number for center and side panels
 - 4 Wood or plastisol color number for arm caps (see below under Required Selections)
 - 5 Options, if selected (see below)
- ▶ See *Surface Materials*, page 402.

Required Selections	Price	Required to Specify
---------------------	-------	---------------------

Arm Caps	• Maple wood	No cost	Specify with <i>wood arm caps</i> and select plastic color number. Specify with <i>plastisol arm caps</i> and select wood color number.
	• Plastisol	+\$102	

Options	Price	Required to Specify
---------	-------	---------------------

Surface Materials	• Moisture barrier	+\$384	Specify with <i>moisture barrier</i> .
--------------------------	--------------------	--------	--

Specification Information

Style Number	Base Prices										COM
	Fabric Price Group 1	Fabric Price Group 2	Fabric Price Group 3	Fabric Price Group 4	Fabric Price Group 5	Fabric Price Group 6	Fabric Price Group 7	Fabric Price Group 8	Fabric Price Group 9	Fabric Price Group 10	
	SC6140S	\$3193	\$3411	\$3623	\$3791	\$3965	\$4093	\$4267	\$4521	\$4863	

Sieste Sleeper

SIN 711.16

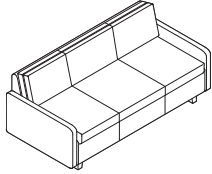

Standard Includes	Required to Specify
<ul style="list-style-type: none"> • Legs: wood • Seat and back: fabric • Closed arms, if selected: fabric • Nylon glides • Storage drawer • Bolster: fabric 	<ol style="list-style-type: none"> 1 Style number 2 Wood color for legs 3 Fabric color number for seat, back, and bolster, if selected 4 Leg position 5 Options, if selected (see below) <p>▶ See <i>Surface Materials</i>, page 402.</p>

Options	Price	Required to Specify
Surface Materials Moisture barrier <ul style="list-style-type: none"> • Moisture barrier on seat 	+\$480	Specify <i>with moisture barrier</i> .
Legs <ul style="list-style-type: none"> • Legs outside position • Legs underframe position 	No cost No cost	Specify <i>with outside position on legs</i> . Specify <i>with underframe position on legs</i> .
Storage Drawer <ul style="list-style-type: none"> • Omit storage drawer 	No cost	Specify <i>omit storage drawer</i> .
Attachment Device <ul style="list-style-type: none"> • Attachment ring on bolster • Attachment device on sleeper 	+\$ 64 No cost	Specify <i>with attachment ring</i> . Specify <i>with attachment device</i> .

Tip: Must specify attachment device on sleeper when specifying attachment ring on bolster.

Specification Information

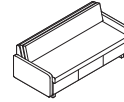
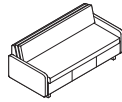
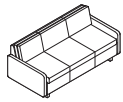

Base Prices

Style Number	Width	Fabric Price Group 1	Fabric Price Group 2	Fabric Price Group 3	Fabric Price Group 4	Fabric Price Group 5	Fabric Price Group 6	Fabric Price Group 7	Fabric Price Group 8	Fabric Price Group 9	Fabric Price Group 10	COM
--------------	-------	----------------------	----------------------	----------------------	----------------------	----------------------	----------------------	----------------------	----------------------	----------------------	-----------------------	-----

Sleepers with Arms

HN26276SA	76"	\$4104	\$4492	\$4872	\$5180	\$5486	\$5718	\$6026	\$6486	\$7106	\$7486	\$4166
HN26280SA	80"	\$4264	\$4738	\$5210	\$5586	\$5966	\$6252	\$6628	\$7200	\$7952	\$8428	\$4326
HN26284SA	84"	\$4438	\$5002	\$5562	\$6012	\$6460	\$6798	\$7246	\$7920	\$8820	\$9382	\$4500

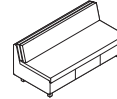
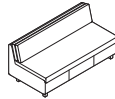
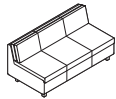

Sleepers with End Panels

HN26276SP	76"	\$3929	\$4241	\$4553	\$4799	\$5049	\$5235	\$5481	\$5853	\$6353	\$6661	\$3991
HN26280SP	80"	\$4104	\$4492	\$4872	\$5180	\$5486	\$5718	\$6026	\$6486	\$7106	\$7486	\$4166
HN26284SP	84"	\$4264	\$4738	\$5210	\$5586	\$5966	\$6252	\$6628	\$7200	\$7952	\$8428	\$4326



Round Bolster

HN262A	17½"D	\$ 207	\$ 239	\$ 266	\$ 290	\$ 315	\$ 331	\$ 357	\$ 390	\$ 439	\$ 467	\$ 266
---------------	-------	--------	--------	--------	--------	--------	--------	--------	--------	--------	--------	--------

Surround Lounge

44" Frame Width

SIN 711.16

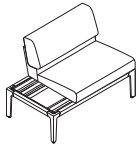

Tip: 33"W seat, back, and outer back, with two low arms; and 38 1/2"W seat, back, and outer back with one left-facing low arm shown above.

Tip: Left and right determined when facing the unit.

Tip: Understand that standard requires further specification to complete unit.

Tip: For additional specification information, refer to Surround Configuration Charts.

► See *Steelcase Health Volume 1 Seating Specification Guide*.

Tip: An additional upcharge will be applied if high arm is desired instead of low arm.

Tip: Fabric upcharges are applied separately for seat, back, and outer back.

Tip: High arm includes a pillow.

Tip: Arm height upcharge is per high arm selected.

Tip: Only four USB ports total may be specified in a unit.

Standard Includes	Required to Specify
-------------------	---------------------

- Frame: paint price group 1
- Seat, back, and outer back: fabric price group 1
- Adjustable glides: platinum solid plastic

- 1 Style number
 - 2 Seat, back, and outer back width (see below under Required Selections)
 - 3 Paint color number for frame
 - 4 Fabric color number for seat, back, and outer back
 - 5 Arm position (see below under Required Selections)
 - 6 Options, if selected (see below)
- See *Surface Materials*, page 402.

Required Selections	Price	Required to Specify
---------------------	-------	---------------------

Seat, Back, and Outer Back Width	• 33"W seat, back, and outer back	Price at right	Specify with 33"W seat, back, and outer back.
	• 38 1/2"W seat, back, and outer back	Price at right	Specify with 38 1/2"W seat, back, and outer back.
	• 44"W seat, back, and outer back	Price at right	Specify with 44"W seat, back, and outer back.
Arm	• No arms	Prices at right	Specify with no arms.
	• One arm	Prices at right	Specify with arm right- or left-facing.
	• Two arms	Prices at right	Specify with two arms right- and left-facing.

Options	Price	Required to Specify
---------	-------	---------------------

Surface Materials	Frame		
	• Paint price group 1	No cost	Specify paint color number.
	• Paint price group 2	+\$ 28	Specify paint color number.
	• Paint price group 3	+\$ 99	Specify paint color number.
	Seat, back, and outer back		
	• Fabric	Prices at right	Specify fabric color number.
	Arm(s)		
	• Fabric	Prices at right	Specify fabric color number.
	High arm pillow (if high arm(s) selected)		
	• Fabric	Prices at right	Specify fabric color number.
Arm Height(s)	Right		
	• Right arm low	No cost	Specify with right arm low.
	• Right arm high	+\$150	Specify with right arm high.
	Left		
	• Left arm low	No cost	Specify with left arm low.
	• Left arm high	+\$150	Specify with left arm high.
Power	Right		
	• Right arm no power	No cost	Specify with right arm no power.
	• Right arm two power	+\$375	Specify with right arm two power.
	• Right arm one power, two USB	+\$445	Specify with right arm one power, two USB.
	• Right arm, four USB	+\$445	Specify with right arm, four USB.
	Left		
	• Left arm no power	No cost	Specify with left arm no power.
	• Left arm two power	+\$375	Specify with left arm two power.
	• Left arm one power, two USB	+\$445	Specify with left arm one power, two USB.
	• Left arm, four USB	+\$445	Specify with left arm, four USB.

► Options, continued on next page

► Options, continued from previous page

Options	Price	Required to Specify
Mobility • Two glides and two casters	+\$510	Specify with two glides and two casters.
Tablet Rail • Tablet rail	+\$435	Specify with tablet rail.
Related Products • Mobile tablet		► Page 219

Tip: Mobile tablet is specified separately.
► See page 219.

Fabric Upcharges

Style Number	Width	Fabric Price	Fabric Price Group 1	Fabric Price Group 2	Fabric Price Group 3	Fabric Price Group 4	Fabric Price Group 5	Fabric Price Group 6	Fabric Price Group 7	Fabric Price Group 8	Fabric Price Group 9	Fabric Price Group 10	COM
HLS44 Seat													
33"	No cost	+\$57	+\$105	+\$172	+\$252	+\$352	+\$682	+\$831	+\$ 965	+\$1113	+\$ 57		
38½"	No cost	+\$57	+\$105	+\$172	+\$252	+\$352	+\$682	+\$831	+\$ 965	+\$1113	+\$ 57		
44"	No cost	+\$72	+\$132	+\$218	+\$319	+\$447	+\$772	+\$950	+\$1110	+\$1286	+\$ 72		
Back													
33"	No cost	+\$57	+\$105	+\$172	+\$252	+\$352	+\$682	+\$831	+\$ 965	+\$1113	+\$ 57		
38½"	No cost	+\$57	+\$105	+\$172	+\$252	+\$352	+\$682	+\$831	+\$ 965	+\$1113	+\$ 57		
44"	No cost	+\$72	+\$132	+\$218	+\$319	+\$447	+\$772	+\$950	+\$1110	+\$1286	+\$ 72		
Outer Back													
33"	No cost	+\$57	+\$105	+\$172	+\$252	+\$352	+\$682	+\$831	+\$ 965	+\$1113	+\$ 57		
38½"	No cost	+\$57	+\$105	+\$172	+\$252	+\$352	+\$682	+\$831	+\$ 965	+\$1113	+\$ 57		
44"	No cost	+\$72	+\$132	+\$218	+\$319	+\$447	+\$772	+\$950	+\$1110	+\$1286	+\$ 72		
Arm													
Low	No cost	+\$55	+\$ 74	+\$145	+\$188	+\$219	+\$262	+\$325	+\$ 387	+\$ 457	+\$ 74		
High	No cost	+\$85	+\$115	+\$225	+\$291	+\$339	+\$406	+\$504	+\$ 600	+\$ 708	+\$115		
High Arm Pillow													
Pillow	No cost	+\$55	+\$ 74	+\$145	+\$188	+\$219	+\$262	+\$325	+\$ 387	+\$ 457	+\$ 74		

Tip: Seat, back, and outer back fabrics may be specified in different choices.
► See Understanding Lounge in Steelcase Health Volume 1 Seating Specification Guide.

Tip: Arm fabric and high arm pillow fabric is per arm selected.

Tip: High arm and pillow fabrics may be specified in different choices.
► See Understanding Lounge in Steelcase Health Volume 1 Seating Specification Guide.

Tip: Arm pillow fabric upcharge is per high arm selected.

Specification Information

Style Number	Frame Dimensions		Seat, Back, and Outer Back Width	Base Prices Low Arms		
	W	D		No arm(s)	One arm	Two arms

44" Frame Width

HLS44	44"	27½"	33"	\$1650	N.A.	\$2150
			38½"	N.A.	\$1930	N.A.
			44"	\$2031	N.A.	N.A.



Surround Lounge

55" Frame Width

SIN 711.16

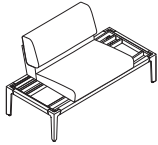

Standard Includes	Required to Specify
-------------------	---------------------

- Frame: paint price group 1
- Seat, back, and outer back: fabric price group 1
- Adjustable glides: platinum solid plastic

- 1 Style number
 - 2 Seat, back, and outer back width (see below under Required Selections)
 - 3 Paint color number for frame
 - 4 Fabric color number for seat, back, and outer back
 - 5 Arm position (see below under Required Selections)
 - 6 Options, if selected (see below)
- ▶ See *Surface Materials*, page 402.

Required Selections	Price	Required to Specify
Seat, Back, and Outer Back Width	• 33"W seat, back, and outer back	Price at right Specify with 33"W seat, back, and outer back.
	• 38 1/2"W seat, back, and outer back	Price at right Specify with 38 1/2"W seat, back, and outer back.
	• 44"W seat, back, and outer back	Price at right Specify with 44"W seat, back, and outer back.
	• 49 1/2"W seat, back, and outer back	Price at right Specify with 49 1/2"W seat, back, and outer back.
	• 55"W seat, back, and outer back	Price at right Specify with 55"W seat, back, and outer back.
Arm Position	• No arms	Prices at right Specify with no arms.
	• One arm	Prices at right Specify with arm right- or left-facing.
	• Two arms	Prices at right Specify with two arms right- and left-facing.

Tip: Left and right determined when facing the unit.

Tip: Understand that standard requires further specification to complete unit.

Tip: For additional specification information, refer to Surround Configuration Charts.

▶ See *Steelcase Health Volume 1 Seating Specification Guide*.

Tip: Fabric upcharges are applied separately for seat, back, and outer back.

Options	Price	Required to Specify
Surface Materials	Frame	
	• Paint price group 1 • Paint price group 2 • Paint price group 3	No cost +\$28 +\$99
Seat, back, and outer back	• Fabric	Prices at right Specify fabric color number.
	Arm(s)	
	• Fabric	Prices at right Specify fabric color number.
High arm pillow (if high arm(s) selected)	• Fabric	Prices at right Specify fabric color number.
	Storage Size(s) and Location(s)	
Storage Size(s) and Location(s)	• No storage	No cost Specify with no storage.
	• 11"W right-facing storage	No cost Specify with 11"W right-facing storage.
	• 16 1/2"W right-facing storage	No cost Specify with 16 1/2"W right-facing storage.
	• 11"W left-facing storage	No cost Specify with 11"W left-facing storage.
	• 16 1/2"W left-facing storage	No cost Specify with 16 1/2"W left-facing storage.
Storage Type	Right	
	• Right one-tier end table	No cost Specify with right one-tier end table.
	• Right two-tier end table	No cost Specify with right two-tier end table.
	Left	
	• Left one-tier end table	No cost Specify with left one-tier end table.
	• Left two-tier end table	No cost Specify with left two-tier end table.

Tip: Storage is specified separately.

▶ See pages 217–218.

Tip: Storage not available if 49 1/2"W seat, back, and outer back is specified.

Tip: Storage type is only specified when storage size and location is chosen.

▶ Options, continued on next page

► Options, continued from previous page

	Options	Price	Required to Specify
Arm Height(s)	Right		
	• Right arm low	No cost	Specify with right arm low.
	• Right arm high	+\$150	Specify with right arm high.
	Left		
	• Left arm low	No cost	Specify with left arm low.
	• Left arm high	+\$150	Specify with left arm high.
Power and Light	Right		
	• Right arm no power	No cost	Specify with right arm no power.
	• Right arm two power	+\$375	Specify with right arm two power.
	• Right arm one power, two USB	+\$445	Specify with right arm one power, two USB.
	• Right arm, four USB	+\$445	Specify with right arm, four USB.
	• Right arm two power, with light capability	+\$375	Specify with right arm two power, with light capability.
	• Right arm one power, two USB, with light capability	+\$445	Specify with right arm one power, two USB, with light capability.
	• Right arm, four USB, with light capability	+\$445	Specify with right arm, four USB, with light capability.
	Left		
	• Left arm no power	No cost	Specify with left arm no power.
	• Left arm two power	+\$375	Specify with left arm two power.
	• Left arm one power, two USB	+\$445	Specify with left arm one power, two USB.
	• Left arm, four USB	+\$445	Specify with left arm, four USB.
	• Left arm two power, with light capability	+\$375	Specify with left arm two power, with light capability.
• Left arm one power, two USB, with light capability	+\$445	Specify with left arm one power, two USB, with light capability.	
• Left arm, four USB, with light capability	+\$445	Specify with left arm, four USB, with light capability.	
Mobility	• Two glides and two casters	+\$510	Specify with two glides and two casters.
Tablet Rail	• Tablet rail	+\$435	Specify with tablet rail.
Related Products	• Storage, one-tier end table		► Page 217
	• Storage, two-tier end table		► Page 218
	• Mobile tablet		► Page 219

► Options, continued on next page

Tip: Power with light can only be specified if adjacent two-tier storage and light are specified. There is an upcharge for the light option on two-tier storage.
► See page 218.

Tip: Only one power with light may be specified in a unit.

Tip: Only four USB ports total may be specified in a unit.

Tip: Mobile tablet is specified separately.
► See page 219.

Surround Lounge, 55" Frame Width, continued

SIN 711.16

► Options, continued from previous page

Fabric Upcharges

Style Number	Width	Fabric Price Group 1	Fabric Price Group 2	Fabric Price Group 3	Fabric Price Group 4	Fabric Price Group 5	Fabric Price Group 6	Fabric Price Group 7	Fabric Price Group 8	Fabric Price Group 9	Fabric Price Group 10	COM
HLS55 Seat												
33"	No cost	+\$57	+\$105	+\$172	+\$252	+\$352	+\$682	+\$ 831	+\$ 965	+\$1113	+\$ 57	
38½"	No cost	+\$57	+\$105	+\$172	+\$252	+\$352	+\$682	+\$ 831	+\$ 965	+\$1113	+\$ 57	
44"	No cost	+\$72	+\$132	+\$218	+\$319	+\$447	+\$772	+\$ 950	+\$1110	+\$1286	+\$ 72	
49½"	No cost	+\$85	+\$156	+\$256	+\$375	+\$525	+\$818	+\$1015	+\$1193	+\$1388	+\$ 85	
55"	No cost	+\$87	+\$161	+\$264	+\$387	+\$543	+\$857	+\$1069	+\$1255	+\$1460	+\$ 87	
Back												
33"	No cost	+\$57	+\$105	+\$172	+\$252	+\$352	+\$682	+\$ 831	+\$ 965	+\$1113	+\$ 57	
38½"	No cost	+\$57	+\$105	+\$172	+\$252	+\$352	+\$682	+\$ 831	+\$ 965	+\$1113	+\$ 57	
44"	No cost	+\$72	+\$132	+\$218	+\$319	+\$447	+\$772	+\$ 950	+\$1110	+\$1286	+\$ 72	
49½"	No cost	+\$85	+\$156	+\$256	+\$375	+\$525	+\$818	+\$1015	+\$1193	+\$1388	+\$ 85	
55"	No cost	+\$87	+\$161	+\$264	+\$387	+\$543	+\$857	+\$1069	+\$1255	+\$1460	+\$ 87	
Outer Back												
33"	No cost	+\$57	+\$105	+\$172	+\$252	+\$352	+\$682	+\$ 831	+\$ 965	+\$1113	+\$ 57	
38½"	No cost	+\$57	+\$105	+\$172	+\$252	+\$352	+\$682	+\$ 831	+\$ 965	+\$1113	+\$ 57	
44"	No cost	+\$72	+\$132	+\$218	+\$319	+\$447	+\$772	+\$ 950	+\$1110	+\$1286	+\$ 72	
49½"	No cost	+\$85	+\$156	+\$256	+\$375	+\$525	+\$818	+\$1015	+\$1193	+\$1388	+\$ 85	
55"	No cost	+\$87	+\$161	+\$264	+\$387	+\$543	+\$857	+\$1069	+\$1255	+\$1460	+\$ 87	
Arm												
Low	No cost	+\$55	+\$ 74	+\$145	+\$188	+\$219	+\$262	+\$ 325	+\$ 387	+\$ 457	+\$ 74	
High	No cost	+\$85	+\$115	+\$225	+\$291	+\$339	+\$406	+\$ 504	+\$ 600	+\$ 708	+\$115	
High Arm Pillow												
Pillow	No cost	+\$55	+\$ 74	+\$145	+\$188	+\$219	+\$262	+\$ 325	+\$ 387	+\$ 457	+\$ 74	

Tip: Seat, back, and outer back fabrics may be specified in different choices. ► See Understanding Lounge in Steelcase Health Volume 1 Seating Specification Guide.

Tip: Arm fabric and high arm pillow fabric is per arm selected.

Tip: High arm and pillow fabrics may be specified in different choices. ► See Understanding Lounge in Steelcase Health Volume 1 Seating Specification Guide.

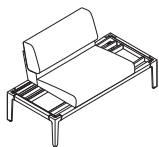

Specification Information

Style Number	Frame Dimensions		Seat, Back, and Outer Back Width	Base Prices Low Arms		
	W	D		No arm(s)	One arm	Two arms

55" Frame Width

HLS55	55"	27½"	33"	\$1745	\$1995	N.A.
			38½"	\$1775	\$2025	N.A.
			44"	\$2126	N.A.	\$2626
			49½"	N.A.	\$2667	N.A.
			55"	\$2474	N.A.	N.A.

Surround Lounge

60¹/₂" Frame Width

SIN 711.16

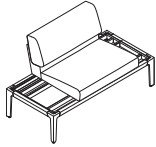

Standard Includes	Required to Specify
-------------------	---------------------

- Frame: paint price group 1
- Seat, back, and outer back: fabric price group 1
- Adjustable glides: platinum solid plastic

- 1 Style number
 - 2 Seat, back, and outer back width (see below under Required Selections)
 - 3 Paint color number for frame
 - 4 Fabric color number for seat, back, and outer back
 - 5 Arm position (see below under Required Selections)
 - 6 Options, if selected (see below)
- ▶ See *Surface Materials*, page 402.

Required Selections	Price	Required to Specify
Seat, Back, and Outer Back Width		
• 33"W seat, back, and outer back	Price at right	Specify with 33"W seat, back, and outer back.
• 38 ¹ / ₂ "W seat, back, and outer back	Price at right	Specify with 38 ¹ / ₂ "W seat, back, and outer back.
• 44"W seat, back, and outer back	Price at right	Specify with 44"W seat, back, and outer back.
• 49 ¹ / ₂ "W seat, back, and outer back	Price at right	Specify with 49 ¹ / ₂ "W seat, back, and outer back.
• 55"W seat, back, and outer back	Price at right	Specify with 55"W seat, back, and outer back.
• 60 ¹ / ₂ "W seat, back, and outer back	Price at right	Specify with 60 ¹ / ₂ "W seat, back, and outer back.

Arm Position	<ul style="list-style-type: none"> • No arms • One arm • Two arms 	Prices at right Prices at right Prices at right	Specify with <i>no arms</i> . Specify with <i>arm right- or left-facing</i> . Specify with <i>two arms right- and left-facing</i> .
---------------------	--	---	---

Tip: Left and right determined when facing the unit.

Tip: Understand that standard requires further specification to complete unit.

Tip: For additional specification information, refer to Surround Configuration Charts.

▶ See *Steelcase Health Volume 1 Seating Specification Guide*.

Tip: Fabric upcharges are applied separately for seat, back, and outer back.

Options	Price	Required to Specify
Surface Materials		
Frame		
• Paint price group 1	No cost	Specify paint color number.
• Paint price group 2	+\$28	Specify paint color number.
• Paint price group 3	+\$99	Specify paint color number.
		▶ See <i>Surface Materials</i> , page 402.
Seat, back, and outer back		
• Fabric	Prices at right	Specify fabric color number.
Arm(s)		
• Fabric	Prices at right	Specify fabric color number.
High arm pillow (if high arm(s) selected)		
• Fabric	Prices at right	Specify fabric color number.

Storage Size(s) and Location(s)	<ul style="list-style-type: none"> • No storage • 11"W right-facing storage • 16¹/₂"W right-facing storage • 11"W left-facing storage • 16¹/₂"W left-facing storage 	No cost No cost No cost No cost No cost	Specify with <i>no storage</i> . Specify with <i>11"W right-facing storage</i> . Specify with <i>16¹/₂"W right-facing storage</i> . Specify with <i>11"W left-facing storage</i> . Specify with <i>16¹/₂"W left-facing storage</i> .
--	--	---	--

Tip: Storage is specified separately.

▶ See pages 217–218.

Tip: Storage not available if 55"W seat, back, and outer back is specified.

▶ Options, continued on next page

► Options, continued from previous page

	Options	Price	Required to Specify
Storage Type	Right		
	• Right one-tier end table	No cost	Specify with right one-tier end table.
	• Right two-tier end table	No cost	Specify with right two-tier end table.
	Left		
	• Left one-tier end table	No cost	Specify with left one-tier end table.
	• Left two-tier end table	No cost	Specify with left two-tier end table.
Arm Height(s)	Right		
	• Right arm low	No cost	Specify with right arm low.
	• Right arm high	+\$150	Specify with right arm high.
	Left		
	• Left arm low	No cost	Specify with left arm low.
	• Left arm high	+\$150	Specify with left arm high.
Power and Light	Right		
	• Right arm no power	No cost	Specify with right arm no power.
	• Right arm two power	+\$375	Specify with right arm two power.
	• Right arm one power, two USB	+\$445	Specify with right arm one power, two USB.
	• Right arm, four USB	+\$445	Specify with right arm, four USB.
	• Right arm two power, with light capability	+\$375	Specify with right arm two power, with light capability.
	• Right arm one power, two USB, with light capability	+\$445	Specify with right arm one power, two USB, with light capability.
	• Right arm, four USB, with light capability	+\$445	Specify with right arm, four USB, with light capability.
	Left		
	• Left arm no power	No cost	Specify with left arm no power.
	• Left arm two power	+\$375	Specify with left arm two power.
	• Left arm one power, two USB	+\$445	Specify with left arm one power, two USB.
	• Left arm, four USB	+\$445	Specify with left arm, four USB.
	• Left arm two power, with light capability	+\$375	Specify with left arm two power, with light capability.
• Left arm one power, two USB, with light capability	+\$445	Specify with left arm one power, two USB, with light capability.	
• Left arm, four USB, with light capability	+\$445	Specify with left arm, four USB, with light capability.	
Mobility	• Two glides and two casters	+\$510	Specify with two glides and two casters.
Tablet Rail	• Tablet rail	+\$435	Specify with tablet rail.
Related Products	• Storage, one-tier end table		► Page 217
	• Storage, two-tier end table		► Page 218
	• Mobile tablet		► Page 219

► Options, continued on next page

Tip: Storage type is only specified when storage size and location is chosen.

Tip: Power with light can only be specified if adjacent two-tier storage and light are specified. There is an upcharge for the light option on two-tier storage.

► See page 218.

Tip: Only one power with light may be specified in a unit.

Tip: Only four USB ports total may be specified in a unit.

Tip: Mobile tablet is specified separately.

► See page 219.

Surround Lounge, 60 1/2" Frame Width, continued

SIN 711.16

► Options, continued from previous page

Fabric Upcharges

Style Number	Width	Fabric Price Group 1	Fabric Price Group 2	Fabric Price Group 3	Fabric Price Group 4	Fabric Price Group 5	Fabric Price Group 6	Fabric Price Group 7	Fabric Price Group 8	Fabric Price Group 9	Fabric Price Group 10	COM
--------------	-------	----------------------	----------------------	----------------------	----------------------	----------------------	----------------------	----------------------	----------------------	----------------------	-----------------------	-----

Tip: Seat, back, and outer back fabrics may be specified in different choices.
 ► See Understanding Lounge in Steelcase Health Volume 1 Seating Specification Guide.

HLS61 Seat												
33"	No cost	+\$57	+\$105	+\$172	+\$252	+\$352	+\$682	+\$ 831	+\$ 965	+\$1113	+\$ 57	
38 1/2"	No cost	+\$57	+\$105	+\$172	+\$252	+\$352	+\$682	+\$ 831	+\$ 965	+\$1113	+\$ 57	
44"	No cost	+\$72	+\$132	+\$218	+\$319	+\$447	+\$772	+\$ 950	+\$1110	+\$1286	+\$ 72	
49 1/2"	No cost	+\$85	+\$156	+\$256	+\$375	+\$525	+\$818	+\$1015	+\$1193	+\$1388	+\$ 85	
55"	No cost	+\$87	+\$161	+\$264	+\$387	+\$543	+\$857	+\$1069	+\$1255	+\$1460	+\$ 87	
60 1/2"	No cost	+\$98	+\$179	+\$295	+\$431	+\$604	+\$863	+\$1080	+\$1276	+\$1491	+\$ 98	

Back												
33"	No cost	+\$57	+\$105	+\$172	+\$252	+\$352	+\$682	+\$ 831	+\$ 965	+\$1113	+\$ 57	
38 1/2"	No cost	+\$57	+\$105	+\$172	+\$252	+\$352	+\$682	+\$ 831	+\$ 965	+\$1113	+\$ 57	
44"	No cost	+\$72	+\$132	+\$218	+\$319	+\$447	+\$772	+\$ 950	+\$1110	+\$1286	+\$ 72	
49 1/2"	No cost	+\$85	+\$156	+\$256	+\$375	+\$525	+\$818	+\$1015	+\$1193	+\$1388	+\$ 85	
55"	No cost	+\$87	+\$161	+\$264	+\$387	+\$543	+\$857	+\$1069	+\$1255	+\$1460	+\$ 87	
60 1/2"	No cost	+\$98	+\$179	+\$295	+\$431	+\$604	+\$863	+\$1080	+\$1276	+\$1491	+\$ 98	

Outer Back												
33"	No cost	+\$57	+\$105	+\$172	+\$252	+\$352	+\$682	+\$ 831	+\$ 965	+\$1113	+\$ 57	
38 1/2"	No cost	+\$57	+\$105	+\$172	+\$252	+\$352	+\$682	+\$ 831	+\$ 965	+\$1113	+\$ 57	
44"	No cost	+\$72	+\$132	+\$218	+\$319	+\$447	+\$772	+\$ 950	+\$1110	+\$1286	+\$ 72	
49 1/2"	No cost	+\$85	+\$156	+\$256	+\$375	+\$525	+\$818	+\$1015	+\$1193	+\$1388	+\$ 85	
55"	No cost	+\$87	+\$161	+\$264	+\$387	+\$543	+\$857	+\$1069	+\$1255	+\$1460	+\$ 87	
60 1/2"	No cost	+\$98	+\$179	+\$295	+\$431	+\$604	+\$863	+\$1080	+\$1276	+\$1491	+\$ 98	

Arm												
Low	No cost	+\$55	+\$ 74	+\$145	+\$188	+\$219	+\$262	+\$ 325	+\$ 387	+\$ 457	+\$ 74	
High	No cost	+\$85	+\$115	+\$225	+\$291	+\$339	+\$406	+\$ 504	+\$ 600	+\$ 708	+\$115	

High Arm Pillow												
Pillow	No cost	+\$55	+\$ 74	+\$145	+\$188	+\$219	+\$262	+\$ 325	+\$ 387	+\$ 457	+\$ 74	

Tip: Arm fabric and high arm pillow fabric is per arm selected.

Tip: High arm and pillow fabrics may be specified in different choices.
 ► See Understanding Lounge in Steelcase Health Volume 1 Seating Specification Guide.

Specification Information

Style Number	Frame Dimensions		Seat, Back, and Outer Back Width	Base Prices Low Arms		
	W	D		No arm(s)	One arm	Two arms

60½" Frame Width

HLS61	60½"	27½"	33"	\$1777	\$2027	\$2277
			38½"	\$1807	\$2057	\$2307
			44"	\$2158	\$2408	N.A.
			49½"	\$2449	N.A.	\$2949
			55"	N.A.	\$2756	N.A.
			60½"	\$2740	N.A.	N.A.

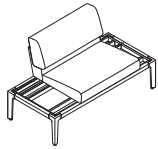

Surround Lounge

66" Frame Width

SIN 711.16

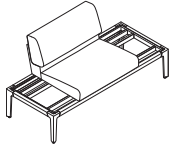

Standard Includes	Required to Specify
<ul style="list-style-type: none"> • Frame: paint price group 1 • Seat, back, and outer back: fabric price group 1 • Adjustable glides: platinum solid plastic 	<ol style="list-style-type: none"> 1 Style number 2 Seat, back, and outer back width (see below under Required Selections) 3 Paint color number for frame 4 Fabric color number for seat, back, and outer back 5 Arm position (see below under Required Selections) 6 Options, if selected (see below) <p>▶ See <i>Surface Materials</i>, page 402.</p>

Required Selections	Price	Required to Specify	
Seat, Back, and Outer Back Width	• 33"W seat, back, and outer back	Price at right	Specify with 33"W seat, back, and outer back.
	• 38 1/2"W seat, back, and outer back	Price at right	Specify with 38 1/2"W seat, back, and outer back.
	• 44"W seat, back, and outer back	Price at right	Specify with 44"W seat, back, and outer back.
	• 49 1/2"W seat, back, and outer back	Price at right	Specify with 49 1/2"W seat, back, and outer back.
	• 55"W seat, back, and outer back	Price at right	Specify with 55"W seat, back, and outer back.
	• 60 1/2"W seat, back, and outer back	Price at right	Specify with 60 1/2"W seat, back, and outer back.
	• 66"W seat, back, and outer back	Price at right	Specify with 66"W seat, back, and outer back.
Arm Position	• No arms	Prices at right	Specify with no arms.
	• One arm	Prices at right	Specify with arm right- or left-facing.
	• Two arms	Prices at right	Specify with two arms right- and left-facing.

Tip: Left and right determined when facing the unit.

Tip: Understand that standard requires further specification to complete unit.

Tip: For additional specification information, refer to Surround Configuration Charts.

▶ See *Steelcase Health Volume 1 Seating Specification Guide*.

Tip: Fabric upcharges are applied separately for seat, back, and outer back.

Options	Price	Required to Specify	
Surface Materials	Frame		
	• Paint price group 1	No cost	Specify paint color number.
	• Paint price group 2	+\$28	Specify paint color number.
	• Paint price group 3	+\$99	Specify paint color number.
	Seat, back, and outer back		
	• Fabric	Prices at right	Specify fabric color number.
	Arm(s)		
	• Fabric	Prices at right	Specify fabric color number.
	High arm pillow (if high arm(s) selected)		
	• Fabric	Prices at right	Specify fabric color number.

▶ Options, continued on next page

► Options, continued from previous page

	Options	Price	Required to Specify
Storage Size(s) and Location(s)	• No storage	No cost	Specify with no storage.
	• 11"W right-facing storage	No cost	Specify with 11"W right-facing storage.
	• 16 1/2"W right-facing storage	No cost	Specify with 16 1/2"W right-facing storage.
	• 11"W left-facing storage	No cost	Specify with 11"W left-facing storage.
	• 16 1/2"W left-facing storage	No cost	Specify with 16 1/2"W left-facing storage.
Storage Type	Right		
	• Right one-tier end table	No cost	Specify with right one-tier end table.
	• Right two-tier end table	No cost	Specify with right two-tier end table.
	Left		
Arm Height(s)	Right		
	• Right arm low	No cost	Specify with right arm low.
	• Right arm high	+\$150	Specify with right arm high.
	Left		
Power and Light	Right		
	• Right arm no power	No cost	Specify with right arm no power.
	• Right arm two power	+\$375	Specify with right arm two power.
	• Right arm one power, two USB	+\$445	Specify with right arm one power, two USB.
	• Right arm, four USB	+\$445	Specify with right arm, four USB.
	• Right arm two power, with light capability	+\$375	Specify with right arm two power, with light capability.
	• Right arm one power, two USB, with light capability	+\$445	Specify with right arm one power, two USB, with light capability.
	• Right arm, four USB, with light capability	+\$445	Specify with right arm, four USB, with light capability.
	Left		
	• Left arm no power	No cost	Specify with left arm no power.
	• Left arm two power	+\$375	Specify with left arm two power.
	• Left arm one power, two USB	+\$445	Specify with left arm one power, two USB.
	• Left arm, four USB	+\$445	Specify with left arm, four USB.
	• Left arm two power, with light capability	+\$375	Specify with left arm two power, with light capability.
• Left arm one power, two USB, with light capability	+\$445	Specify with left arm one power, two USB, with light capability.	
• Left arm, four USB, with light capability	+\$445	Specify with left arm, four USB, with light capability.	
Mobility	• Two glides and two casters	+\$510	Specify with two glides and two casters.
Tablet Rail	• Tablet rail	+\$435	Specify with tablet rail.
Related Products	• Storage, one-tier end table • Storage, two-tier end table • Mobile tablet		► Page 217 ► Page 218 ► Page 219

Tip: Storage is specified separately.
► See pages 217–218.

Tip: Storage not available if 60 1/2"W seat, back, and outer back is specified.

Tip: Storage type is only specified when storage size and location is chosen.

Tip: Power with light can only be specified if adjacent two-tier storage and light are specified. There is an upcharge for the light option on two-tier storage.
► See page 218.

Tip: Only one power with light may be specified in a unit.

Tip: Only four USB ports total may be specified in a unit.

Tip: Mobile tablet is specified separately.
► See page 219.

► Options, continued on next page

Surround Lounge, 66" Frame Width, continued

SIN 711.16

► Options, continued from previous page

Fabric Upcharges

Style Number	Width	Fabric Price Group 1	Fabric Price Group 2	Fabric Price Group 3	Fabric Price Group 4	Fabric Price Group 5	Fabric Price Group 6	Fabric Price Group 7	Fabric Price Group 8	Fabric Price Group 9	Fabric Price Group 10	COM
HLS66												
Seat												
33"	No cost	+\$ 57	+\$105	+\$172	+\$252	+\$352	+\$682	+\$ 831	+\$ 965	+\$1113	+\$ 57	
38½"	No cost	+\$ 57	+\$105	+\$172	+\$252	+\$352	+\$682	+\$ 831	+\$ 965	+\$1113	+\$ 57	
44"	No cost	+\$ 72	+\$132	+\$218	+\$319	+\$447	+\$772	+\$ 950	+\$1110	+\$1286	+\$ 72	
49½"	No cost	+\$ 85	+\$156	+\$256	+\$375	+\$525	+\$818	+\$1015	+\$1193	+\$1388	+\$ 85	
55"	No cost	+\$ 87	+\$161	+\$264	+\$387	+\$543	+\$857	+\$1069	+\$1255	+\$1460	+\$ 87	
60½"	No cost	+\$ 98	+\$179	+\$295	+\$431	+\$604	+\$863	+\$1080	+\$1276	+\$1491	+\$ 98	
66"	No cost	+\$108	+\$199	+\$327	+\$479	+\$670	+\$875	+\$1086	+\$1292	+\$1518	+\$108	
Back												
33"	No cost	+\$ 57	+\$105	+\$172	+\$252	+\$352	+\$682	+\$ 831	+\$ 965	+\$1113	+\$ 57	
38½"	No cost	+\$ 57	+\$105	+\$172	+\$252	+\$352	+\$682	+\$ 831	+\$ 965	+\$1113	+\$ 57	
44"	No cost	+\$ 72	+\$132	+\$218	+\$319	+\$447	+\$772	+\$ 950	+\$1110	+\$1286	+\$ 72	
49½"	No cost	+\$ 85	+\$156	+\$256	+\$375	+\$525	+\$818	+\$1015	+\$1193	+\$1388	+\$ 85	
55"	No cost	+\$ 87	+\$161	+\$264	+\$387	+\$543	+\$857	+\$1069	+\$1255	+\$1460	+\$ 87	
60½"	No cost	+\$ 98	+\$179	+\$295	+\$431	+\$604	+\$863	+\$1080	+\$1276	+\$1491	+\$ 98	
66"	No cost	+\$108	+\$199	+\$327	+\$479	+\$670	+\$875	+\$1086	+\$1292	+\$1518	+\$108	
Outer Back												
33"	No cost	+\$ 57	+\$105	+\$172	+\$252	+\$352	+\$682	+\$ 831	+\$ 965	+\$1113	+\$ 57	
38½"	No cost	+\$ 57	+\$105	+\$172	+\$252	+\$352	+\$682	+\$ 831	+\$ 965	+\$1113	+\$ 57	
44"	No cost	+\$ 72	+\$132	+\$218	+\$319	+\$447	+\$772	+\$ 950	+\$1110	+\$1286	+\$ 72	
49½"	No cost	+\$ 85	+\$156	+\$256	+\$375	+\$525	+\$818	+\$1015	+\$1193	+\$1388	+\$ 85	
55"	No cost	+\$ 87	+\$161	+\$264	+\$387	+\$543	+\$857	+\$1069	+\$1255	+\$1460	+\$ 87	
60½"	No cost	+\$ 98	+\$179	+\$295	+\$431	+\$604	+\$863	+\$1080	+\$1276	+\$1491	+\$ 98	
66"	No cost	+\$108	+\$199	+\$327	+\$479	+\$670	+\$875	+\$1086	+\$1292	+\$1518	+\$108	
Arm												
Low	No cost	+\$ 55	+\$ 74	+\$145	+\$188	+\$219	+\$262	+\$ 325	+\$ 387	+\$ 457	+\$ 74	
High	No cost	+\$ 85	+\$115	+\$225	+\$291	+\$339	+\$406	+\$ 504	+\$ 600	+\$ 708	+\$115	
High Arm Pillow												
Pillow	No cost	+\$ 55	+\$ 74	+\$145	+\$188	+\$219	+\$262	+\$ 325	+\$ 387	+\$ 457	+\$ 74	

Tip: Seat, back, and outer back fabrics may be specified in different choices.

► See Understanding Lounge in Steelcase Health Volume 1 Seating Specification Guide.

Tip: Arm fabric and high arm pillow fabric is per arm selected.

Tip: High arm and pillow fabrics may be specified in different choices.

► See Understanding Lounge in Steelcase Health Volume 1 Seating Specification Guide.

Specification Information

Style Number	Frame Dimensions		Seat, Back, and Outer Back Width	Base Prices Low Arms		
	W	D		No arm(s)	One arm	Two arms

66" Frame Width

HLS66	66"	27½"	33"	\$1808	\$2058	\$2308
			38½"	\$1838	\$2088	\$2338
			44"	\$2189	\$2439	\$2689
			49½"	\$2480	\$2730	N.A.
			55"	\$2537	N.A.	\$3037
			60½"	N.A.	\$3021	N.A.
			66"	\$3002	N.A.	N.A.

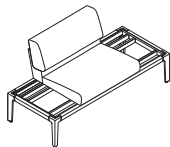

Surround Lounge

71¹/₂" Frame Width

SIN 711.16

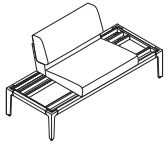

Standard Includes	Required to Specify
-------------------	---------------------

- Frame: paint price group 1
- Seat, back, and outer back: fabric price group 1
- Adjustable glides: platinum solid plastic

- 1 Style number
 - 2 Seat, back, and outer back width (see below under Required Selections)
 - 3 Sleep surface (see below under Required Selections)
 - 4 Paint color number for frame
 - 5 Fabric color number for seat, back, and outer back
 - 6 Arm position (see below under Required Selections)
 - 7 Options, if selected (see below)
- ▶ See *Surface Materials*, page 402.

Required Selections	Price	Required to Specify
---------------------	-------	---------------------

Seat, Back, and Outer Back Width	• 33"W seat, back, and outer back	Price at right	Specify with 33"W seat, back, and outer back.
	• 38 ¹ / ₂ "W seat, back, and outer back	Price at right	Specify with 38 ¹ / ₂ "W seat, back, and outer back.
	• 44"W seat, back, and outer back	Price at right	Specify with 44"W seat, back, and outer back.
	• 49 ¹ / ₂ "W seat, back, and outer back	Price at right	Specify with 49 ¹ / ₂ "W seat, back, and outer back.
	• 55"W seat, back, and outer back	Price at right	Specify with 55"W seat, back, and outer back.
	• 60 ¹ / ₂ "W seat, back, and outer back	Price at right	Specify with 60 ¹ / ₂ "W seat, back, and outer back.
	• 66"W seat, back, and outer back	Price at right	Specify with 66"W seat, back, and outer back.
Sleep Surface	• No sleep surface	No cost	Specify with no sleep surface.
	• Sleep surface with 60 ¹ / ₂ "W seat, back, and outer back	+\$600	Specify with sleep surface.

Arm Position	• No arms	Prices at right	Specify with no arms.
	• One arm	Prices at right	Specify with arm right- or left-facing.
	• Two arms	Prices at right	Specify with two arms right- and left-facing.

Tip: Left and right determined when facing the unit.

Tip: Understand that standard requires further specification to complete unit.

Tip: For additional specification information, refer to Surround Configuration Charts.

▶ See *Steelcase Health Volume 1 Seating Specification Guide*.

Tip: An additional upcharge will be applied if high arm is desired instead of low arm.

Tip: Fabric upcharges are applied separately for seat, back, and outer back.

Options	Price	Required to Specify
---------	-------	---------------------

Surface Materials	Frame		
	• Paint price group 1	No cost	Specify paint color number.
	• Paint price group 2	+\$ 28	Specify paint color number.
	• Paint price group 3	+\$ 99	Specify paint color number.
	Seat, back, and outer back		
	• Fabric	Prices at right	Specify fabric color number.
	Arm(s)		
	• Fabric	Prices at right	Specify fabric color number.
	High arm pillow (if high arm(s) selected)		
	• Fabric	Prices at right	Specify fabric color number.

▶ Options, continued on next page

► Options, continued from previous page

	Options	Price	Required to Specify
Storage Size(s) and Location(s)	• No storage	No cost	Specify with no storage.
	• 11"W right-facing storage	No cost	Specify with 11"W right-facing storage.
	• 16 ¹ / ₂ "W right-facing storage	No cost	Specify with 16 ¹ / ₂ "W right-facing storage.
	• 11"W left-facing storage	No cost	Specify with 11"W left-facing storage.
	• 16 ¹ / ₂ "W left-facing storage	No cost	Specify with 16 ¹ / ₂ "W left-facing storage.
	• 11"W left- and 11"W right-facing storage	No cost	Specify with 11"W left- and 11"W right-facing storage.
	• 11"W left- and 16 ¹ / ₂ "W right-facing storage	No cost	Specify with 11"W left- and 16 ¹ / ₂ "W right-facing storage.
Storage Type	Right		
	• Right one-tier end table	No cost	Specify with right one-tier end table.
	• Right two-tier end table	No cost	Specify with right two-tier end table.
	Left		
• Left one-tier end table	No cost	Specify with left one-tier end table.	
• Left two-tier end table	No cost	Specify with left two-tier end table.	
Arm Height(s)	Right		
	• Right arm low	No cost	Specify with right arm low.
	• Right arm high	+\$150	Specify with right arm high.
	Left		
• Left arm low	No cost	Specify with left arm low.	
• Left arm high	+\$150	Specify with left arm high.	
Power and Light	Right		
	• Right arm no power	No cost	Specify with right arm no power.
	• Right arm two power	+\$375	Specify with right arm two power.
	• Right arm one power, two USB	+\$445	Specify with right arm one power, two USB.
	• Right arm, four USB	+\$445	Specify with right arm, four USB.
	• Right arm two power, with light capability	+\$375	Specify with right arm two power, with light capability.
	• Right arm one power, two USB, with light capability	+\$445	Specify with right arm one power, two USB, with light capability.
	• Right arm, four USB, with light capability	+\$445	Specify with right arm, four USB, with light capability.
	Left		
	• Left arm no power	No cost	Specify with left arm no power.
	• Left arm two power	+\$375	Specify with left arm two power.
	• Left arm one power, two USB	+\$445	Specify with left arm one power, two USB.
• Left arm, four USB	+\$445	Specify with left arm, four USB.	
• Left arm two power, with light capability	+\$375	Specify with left arm two power, with light capability.	
• Left arm one power, two USB, with light capability	+\$445	Specify with left arm one power, two USB, with light capability.	
• Left arm, four USB, with light capability	+\$445	Specify with left arm, four USB, with light capability.	
Mobility	• Two glides and two casters	+\$510	Specify with two glides and two casters.
Tablet Rail	• Tablet rail	+\$435	Specify with tablet rail.
Related Products	• Storage, one-tier end table		► Page 217
	• Storage, two-tier end table		► Page 218
	• Mobile tablet		► Page 219

Tip: Storage is specified separately.

► See pages 217–218.

Tip: Storage not available if 66"W seat, back, and outer back is specified.

Tip: Storage type is only specified when storage size and location is chosen.

Tip: Power with light can only be specified if adjacent two-tier storage and light are specified. There is an upcharge for the light option on two-tier storage.

► See page 218.

Tip: Only one power with light may be specified in a unit.

Tip: Only four USB ports total may be specified in a unit.

Tip: Mobile tablet is specified separately.

► See page 219.

► Options, continued on next page

Surround Lounge, 71 1/2" Frame Width, continued

SIN 711.16

► Options, continued from previous page

Fabric Upcharges

Style Number	Width	Fabric Price Group 1	Fabric Price Group 2	Fabric Price Group 3	Fabric Price Group 4	Fabric Price Group 5	Fabric Price Group 6	Fabric Price Group 7	Fabric Price Group 8	Fabric Price Group 9	Fabric Price Group 10	COM
HLS72												
Seat												
33"	No cost	+\$ 57	+\$105	+\$172	+\$252	+\$352	+\$682	+\$ 831	+\$ 965	+\$1113	+\$ 57	
38 1/2"	No cost	+\$ 57	+\$105	+\$172	+\$252	+\$352	+\$682	+\$ 831	+\$ 965	+\$1113	+\$ 57	
44"	No cost	+\$ 72	+\$132	+\$218	+\$319	+\$447	+\$772	+\$ 950	+\$1110	+\$1286	+\$ 72	
49 1/2"	No cost	+\$ 85	+\$156	+\$256	+\$375	+\$525	+\$818	+\$1015	+\$1193	+\$1388	+\$ 85	
55"	No cost	+\$ 87	+\$161	+\$264	+\$387	+\$543	+\$857	+\$1069	+\$1255	+\$1460	+\$ 87	
60 1/2"	No cost	+\$ 98	+\$179	+\$295	+\$431	+\$604	+\$863	+\$1080	+\$1276	+\$1491	+\$ 98	
66"	No cost	+\$108	+\$199	+\$327	+\$479	+\$670	+\$875	+\$1086	+\$1292	+\$1518	+\$108	
Back												
33"	No cost	+\$ 57	+\$105	+\$172	+\$252	+\$352	+\$682	+\$ 831	+\$ 965	+\$1113	+\$ 57	
38 1/2"	No cost	+\$ 57	+\$105	+\$172	+\$252	+\$352	+\$682	+\$ 831	+\$ 965	+\$1113	+\$ 57	
44"	No cost	+\$ 72	+\$132	+\$218	+\$319	+\$447	+\$772	+\$ 950	+\$1110	+\$1286	+\$ 72	
49 1/2"	No cost	+\$ 85	+\$156	+\$256	+\$375	+\$525	+\$818	+\$1015	+\$1193	+\$1388	+\$ 85	
55"	No cost	+\$ 87	+\$161	+\$264	+\$387	+\$543	+\$857	+\$1069	+\$1255	+\$1460	+\$ 87	
60 1/2"	No cost	+\$ 98	+\$179	+\$295	+\$431	+\$604	+\$863	+\$1080	+\$1276	+\$1491	+\$ 98	
66"	No cost	+\$108	+\$199	+\$327	+\$479	+\$670	+\$875	+\$1086	+\$1292	+\$1518	+\$108	
Outer Back												
33"	No cost	+\$ 57	+\$105	+\$172	+\$252	+\$352	+\$682	+\$ 831	+\$ 965	+\$1113	+\$ 57	
38 1/2"	No cost	+\$ 57	+\$105	+\$172	+\$252	+\$352	+\$682	+\$ 831	+\$ 965	+\$1113	+\$ 57	
44"	No cost	+\$ 72	+\$132	+\$218	+\$319	+\$447	+\$772	+\$ 950	+\$1110	+\$1286	+\$ 72	
49 1/2"	No cost	+\$ 85	+\$156	+\$256	+\$375	+\$525	+\$818	+\$1015	+\$1193	+\$1388	+\$ 85	
55"	No cost	+\$ 87	+\$161	+\$264	+\$387	+\$543	+\$857	+\$1069	+\$1255	+\$1460	+\$ 87	
60 1/2"	No cost	+\$ 98	+\$179	+\$295	+\$431	+\$604	+\$863	+\$1080	+\$1276	+\$1491	+\$ 98	
66"	No cost	+\$108	+\$199	+\$327	+\$479	+\$670	+\$875	+\$1086	+\$1292	+\$1518	+\$108	
Arm												
Low	No cost	+\$ 55	+\$ 74	+\$145	+\$188	+\$219	+\$262	+\$ 325	+\$ 387	+\$ 457	+\$ 74	
High	No cost	+\$ 85	+\$115	+\$225	+\$291	+\$339	+\$406	+\$ 504	+\$ 600	+\$ 708	+\$115	
High Arm Pillow												
Pillow	No cost	+\$ 55	+\$ 74	+\$145	+\$188	+\$219	+\$262	+\$ 325	+\$ 387	+\$ 457	+\$ 74	

Tip: Seat, back, and outer back fabrics may be specified in different choices.

► See Understanding Lounge in Steelcase Health Volume 1 Seating Specification Guide.

Tip: Arm fabric and high arm pillow fabric is per arm selected.

Tip: High arm and pillow fabrics may be specified in different choices.

► See Understanding Lounge in Steelcase Health Volume 1 Seating Specification Guide.

Specification Information

Style Number	Frame Dimensions		Seat, Back, and Outer Back Width	Base Prices Low Arms		
	W	D		No arm(s)	One arm	Two arms

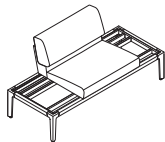

71½" Frame Width

HLS72	71½"	27½"	33"	N.A.	\$2088	\$2338
			38½"	\$1868	\$2118	\$2368
			44"	\$2219	\$2469	\$2719
			49½"	\$2510	\$2760	\$3010
			55"	\$2567	\$2817	N.A.
			60½"	\$2801	N.A.	\$3301
			66"	N.A.	\$3282	N.A.

Surround Lounge

77" Frame Width

SIN 711.16

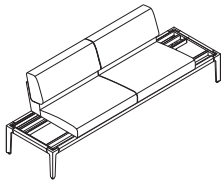

Standard Includes	Required to Specify
-------------------	---------------------

- Frame: paint price group 1
- Seat, back, and outer back: fabric price group 1
- Adjustable glides: platinum solid plastic

- 1 Style number
 - 2 Seat, back, and outer back width (see below under Required Selections)
 - 3 Sleep surface (see below under Required Selections)
 - 4 Paint color number for frame
 - 5 Fabric color number for seat, back, and outer back
 - 6 Arm position (see below under Required Selections)
 - 7 Options, if selected (see below)
- ▶ See *Surface Materials*, page 402.

Required Selections	Price	Required to Specify
---------------------	-------	---------------------

Seat, Back, and Outer Back Width

- | | |
|---------------------------------------|----------------|
| • 33"W seat, back, and outer back | Price at right |
| • 38 1/2"W seat, back, and outer back | Price at right |
| • 44"W seat, back, and outer back | Price at right |
| • 49 1/2"W seat, back, and outer back | Price at right |
| • 55"W seat, back, and outer back | Price at right |
| • 60 1/2"W seat, back, and outer back | Price at right |
| • 66"W seat, back, and outer back | Price at right |

- Specify with 33"W seat, back, and outer back.
Specify with 38 1/2"W seat, back, and outer back.
Specify with 44"W seat, back, and outer back.
Specify with 49 1/2"W seat, back, and outer back.
Specify with 55"W seat, back, and outer back.
Specify with 60 1/2"W seat, back, and outer back.
Specify with 66"W seat, back, and outer back.

Sleep Surface

- | | |
|--|---------|
| • No sleep surface | No cost |
| • Sleep surface with 66"W seat, back, and outer back | +\$625 |

- Specify with no sleep surface.
Specify with sleep surface.

Arm Position

- | | |
|------------|-----------------|
| • No arms | Prices at right |
| • One arm | Prices at right |
| • Two arms | Prices at right |

- Specify with no arms.
Specify with arm right- or left-facing.
Specify with two arms right- and left-facing.

Options	Price	Required to Specify
---------	-------	---------------------

Surface Materials

- | | |
|-----------------------|---------|
| Frame | |
| • Paint price group 1 | No cost |
| • Paint price group 2 | +\$ 28 |
| • Paint price group 3 | +\$ 99 |

- Specify paint color number.
Specify paint color number.
Specify paint color number.
▶ See *Surface Materials*, page 402.

Seat, back, and outer back

- | | |
|----------|-----------------|
| • Fabric | Prices at right |
|----------|-----------------|

- Specify fabric color number.

Arm(s)

- | | |
|----------|-----------------|
| • Fabric | Prices at right |
|----------|-----------------|

- Specify fabric color number.

High arm pillow (if high arm(s) selected)

- | | |
|----------|-----------------|
| • Fabric | Prices at right |
|----------|-----------------|

- Specify fabric color number.

▶ Options, continued on next page

Tip: Lounge will have a fixed back when no sleep surface is specified.

Tip: Sleep surface requires the specification of two arms.

Tip: Left and right determined when facing the unit.

Tip: Understand that standard requires further specification to complete unit.

Tip: For additional specification information, refer to Surround Configuration Charts.

▶ See *Steelcase Health Volume 1 Seating Specification Guide*.

Tip: Fabric upcharges are applied separately for seat, back, and outer back.

► Options, continued from previous page

Tip: Storage is specified separately.

► See pages 217–218.

	Options	Price	Required to Specify
Storage Size(s) and Location(s)	• No storage	No cost	Specify with no storage.
	• 11"W right-facing storage	No cost	Specify with 11"W right-facing storage.
	• 16 ¹ / ₂ "W right-facing storage	No cost	Specify with 16 ¹ / ₂ "W right-facing storage.
	• 11"W left-facing storage	No cost	Specify with 11"W left-facing storage.
	• 16 ¹ / ₂ "W left-facing storage	No cost	Specify with 16 ¹ / ₂ "W left-facing storage.
	• 11"W left- and 11"W right-facing storage	No cost	Specify with 11"W left- and 11"W right-facing storage.
	• 11"W left- and 16 ¹ / ₂ "W right-facing storage	No cost	Specify with 11"W left- and 16 ¹ / ₂ "W right-facing storage.
	• 16 ¹ / ₂ "W left- and 11"W right-facing storage	No cost	Specify with 16 ¹ / ₂ "W left- and 11"W right-facing storage.
	• 16 ¹ / ₂ "W left- and 16 ¹ / ₂ "W right-facing storage	No cost	Specify with 16 ¹ / ₂ "W left- and 16 ¹ / ₂ "W right-facing storage.
Storage Type	Right		
	• Right one-tier end table	No cost	Specify with right one-tier end table.
	• Right two-tier end table	No cost	Specify with right two-tier end table.
	Left		
	• Left one-tier end table	No cost	Specify with left one-tier end table.
	• Left two-tier end table	No cost	Specify with left two-tier end table.
Arm Height(s)	Right		
	• Right arm low	No cost	Specify with right arm low.
	• Right arm high	+\$150	Specify with right arm high.
	Left		
	• Left arm low	No cost	Specify with left arm low.
	• Left arm high	+\$150	Specify with left arm high.
Power and Light	Right		
	• Right arm no power	No cost	Specify with right arm no power.
	• Right arm two power	+\$375	Specify with right arm two power.
	• Right arm one power, two USB	+\$445	Specify with right arm one power, two USB.
	• Right arm, four USB	+\$445	Specify with right arm, four USB.
	• Right arm two power, with light capability	+\$375	Specify with right arm two power, with light capability.
	• Right arm one power, two USB, with light capability	+\$445	Specify with right arm one power, two USB, with light capability.
	• Right arm, four USB, with light capability	+\$445	Specify with right arm, four USB, with light capability.
	Left		
	• Left arm no power	No cost	Specify with left arm no power.
	• Left arm two power	+\$375	Specify with left arm two power.
	• Left arm one power, two USB	+\$445	Specify with left arm one power, two USB.
	• Left arm, four USB	+\$445	Specify with left arm, four USB.
	• Left arm two power, with light capability	+\$375	Specify with left arm two power, with light capability.
	• Left arm one power, two USB, with light capability	+\$445	Specify with left arm one power, two USB, with light capability.
• Left arm, four USB, with light capability	+\$445	Specify with left arm, four USB, with light capability.	
Mobility	• Two glides and two casters	+\$510	Specify with two glides and two casters.
Tablet Rail	• Tablet rail	+\$435	Specify with tablet rail.
Related Products	• Storage, one-tier end table		► Page 217
	• Storage, two-tier end table		► Page 218
	• Mobile tablet		► Page 219

Tip: Storage type is only specified when storage size and location is chosen.

Tip: Power with light can only be specified if adjacent two-tier storage and light are specified. There is an upcharge for the light option on two-tier storage.

► See page 218.

Tip: Only one power with light may be specified in a unit.

Tip: Only four USB ports total may be specified in a unit.

Tip: Mobile tablet is specified separately.

► See page 219.

► Options, continued on next page

Surround Lounge, 77" Frame Width, continued

SIN 711.16

► Options, continued from previous page

Fabric Upcharges

Style Number	Width	Fabric Price Group 1	Fabric Price Group 2	Fabric Price Group 3	Fabric Price Group 4	Fabric Price Group 5	Fabric Price Group 6	Fabric Price Group 7	Fabric Price Group 8	Fabric Price Group 9	Fabric Price Group 10	COM
HLS77												
Seat												
33"	No cost	+\$ 57	+\$105	+\$172	+\$252	+\$352	+\$682	+\$ 831	+\$ 965	+\$1113	+\$ 57	
38½"	No cost	+\$ 57	+\$105	+\$172	+\$252	+\$352	+\$682	+\$ 831	+\$ 965	+\$1113	+\$ 57	
44"	No cost	+\$ 72	+\$132	+\$218	+\$319	+\$447	+\$772	+\$ 950	+\$1110	+\$1286	+\$ 72	
49½"	No cost	+\$ 85	+\$156	+\$256	+\$375	+\$525	+\$818	+\$1015	+\$1193	+\$1388	+\$ 85	
55"	No cost	+\$ 87	+\$161	+\$264	+\$387	+\$543	+\$857	+\$1069	+\$1255	+\$1460	+\$ 87	
60½"	No cost	+\$ 98	+\$179	+\$295	+\$431	+\$604	+\$863	+\$1080	+\$1276	+\$1491	+\$ 98	
66"	No cost	+\$108	+\$199	+\$327	+\$479	+\$670	+\$875	+\$1086	+\$1292	+\$1518	+\$108	
Back												
33"	No cost	+\$ 57	+\$105	+\$172	+\$252	+\$352	+\$682	+\$ 831	+\$ 965	+\$1113	+\$ 57	
38½"	No cost	+\$ 57	+\$105	+\$172	+\$252	+\$352	+\$682	+\$ 831	+\$ 965	+\$1113	+\$ 57	
44"	No cost	+\$ 72	+\$132	+\$218	+\$319	+\$447	+\$772	+\$ 950	+\$1110	+\$1286	+\$ 72	
49½"	No cost	+\$ 85	+\$156	+\$256	+\$375	+\$525	+\$818	+\$1015	+\$1193	+\$1388	+\$ 85	
55"	No cost	+\$ 87	+\$161	+\$264	+\$387	+\$543	+\$857	+\$1069	+\$1255	+\$1460	+\$ 87	
60½"	No cost	+\$ 98	+\$179	+\$295	+\$431	+\$604	+\$863	+\$1080	+\$1276	+\$1491	+\$ 98	
66"	No cost	+\$108	+\$199	+\$327	+\$479	+\$670	+\$875	+\$1086	+\$1292	+\$1518	+\$108	
Outer Back												
33"	No cost	+\$ 57	+\$105	+\$172	+\$252	+\$352	+\$682	+\$ 831	+\$ 965	+\$1113	+\$ 57	
38½"	No cost	+\$ 57	+\$105	+\$172	+\$252	+\$352	+\$682	+\$ 831	+\$ 965	+\$1113	+\$ 57	
44"	No cost	+\$ 72	+\$132	+\$218	+\$319	+\$447	+\$772	+\$ 950	+\$1110	+\$1286	+\$ 72	
49½"	No cost	+\$ 85	+\$156	+\$256	+\$375	+\$525	+\$818	+\$1015	+\$1193	+\$1388	+\$ 85	
55"	No cost	+\$ 87	+\$161	+\$264	+\$387	+\$543	+\$857	+\$1069	+\$1255	+\$1460	+\$ 87	
60½"	No cost	+\$ 98	+\$179	+\$295	+\$431	+\$604	+\$863	+\$1080	+\$1276	+\$1491	+\$ 98	
66"	No cost	+\$108	+\$199	+\$327	+\$479	+\$670	+\$875	+\$1086	+\$1292	+\$1518	+\$108	
Arm												
Low	No cost	+\$ 55	+\$ 74	+\$145	+\$188	+\$219	+\$262	+\$ 325	+\$ 387	+\$ 457	+\$ 74	
High	No cost	+\$ 85	+\$115	+\$225	+\$291	+\$339	+\$406	+\$ 504	+\$ 600	+\$ 708	+\$115	
High Arm Pillow												
Pillow	No cost	+\$ 55	+\$ 74	+\$145	+\$188	+\$219	+\$262	+\$ 325	+\$ 387	+\$ 457	+\$ 74	

Tip: Seat, back, and outer back fabrics may be specified in different choices.

► See Understanding Lounge in Steelcase Health Volume 1 Seating Specification Guide.

Tip: Arm fabric and high arm pillow fabric is per arm selected.

Tip: High arm and pillow fabrics may be specified in different choices.

► See Understanding Lounge in Steelcase Health Volume 1 Seating Specification Guide.

Specification Information

Style Number	Frame Dimensions		Seat, Back, and Outer Back Width	Base Prices Low Arms		
	W	D		No arm(s)	One arm	Two arms

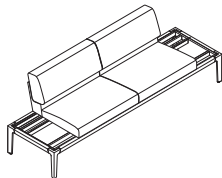

77" Frame Width

Style Number	W	D	Base Prices Low Arms			
			No arm(s)	One arm	Two arms	
HLS77	77"	27 1/2"	33"	N.A.	N.A.	\$2410
			38 1/2"	N.A.	\$2190	\$2440
			44"	\$2291	\$2541	\$2791
			49 1/2"	\$2582	\$2832	\$3082
			55"	\$2639	\$2889	\$3139
			60 1/2"	\$2873	\$3123	N.A.
			66"	\$3104	N.A.	\$3604

Surround Lounge

82½" Frame Width

SIN 711.16

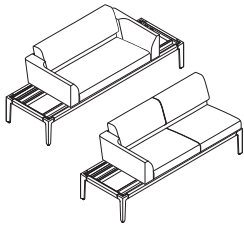

Standard Includes	Required to Specify
-------------------	---------------------

- Frame: paint price group 1
- Seat, back, and outer back: fabric price group 1
- Sleep surface (if 71½"W seat, back, and outer back selected): 5031 Light Merle
- Adjustable glides: platinum solid plastic

- 1 Style number
 - 2 Seat, back, and outer back width (see below under Required Selections)
 - 3 Sleep surface (see below under Required Selections)
 - 4 Paint color number for frame
 - 5 Fabric color number for seat, back, and outer back
 - 6 Arm position (see below under Required Selections)
 - 7 Options, if selected (see below)
- ▶ See *Surface Materials*, page 402.

Required Selections	Price	Required to Specify
---------------------	-------	---------------------

Seat, Back, and Outer Back Width

- 38½"W seat, back, and outer back Price at right
- 44"W seat, back, and outer back Price at right
- 49½"W seat, back, and outer back Price at right
- 55"W seat, back, and outer back Price at right
- 60½"W seat, back, and outer back Price at right
- 66"W seat, back, and outer back Price at right
- 71½"W seat, back, and outer back Price at right

- Specify with 38½"W seat, back, and outer back.
Specify with 44"W seat, back, and outer back.
Specify with 49½"W seat, back, and outer back.
Specify with 55"W seat, back, and outer back.
Specify with 60½"W seat, back, and outer back.
Specify with 66"W seat, back, and outer back.
Specify with 71½"W seat, back, and outer back.

Sleep Surface

- No sleep surface No cost
- Sleep surface with 60½"W seat, back, and outer back +\$600
- Sleep surface with 71½"W seat, back, and outer back \$ 650
Included in Base Price

- Specify with no sleep surface.
Specify with sleep surface.
Specify with sleep surface.

Arm Position

- No arms Prices at right
- One arm Prices at right
- Two arms Prices at right

- Specify with no arms.
Specify with arm right- or left-facing.
Specify with two arms right- and left-facing.

Options	Price	Required to Specify
---------	-------	---------------------

Surface Materials

- Frame**
- Paint price group 1 No cost
 - Paint price group 2 +\$ 28
 - Paint price group 3 +\$ 99

- Specify paint color number.
Specify paint color number.
Specify paint color number.
▶ See *Surface Materials*, page 402.

Seat, back, and outer back

- Fabric Prices at right

- Specify fabric color number.

Arm(s)

- Fabric Prices at right

- Specify fabric color number.

High arm pillow (if high arm(s) selected)

- Fabric Prices at right

- Specify fabric color number.

▶ Options, continued on next page

Tip: When specifying no sleep surface, a fixed back will be received.

Tip: Sleep surface is included and the only back available with 71½"W seat, back, and outer back selection.

Tip: Sleep surface requires the specification of two arms.

Tip: Left and right determined when facing the unit.

Tip: Understand that standard requires further specification to complete unit.

Tip: For additional specification information, refer to Surround Configuration Charts.

▶ See *Steelcase Health Volume 1 Seating Specification Guide*.

Tip: Fabric upcharges are applied separately for seat, back, and outer back.

► Options, continued from previous page

	Options	Price	Required to Specify
Storage Size(s) and Location(s)	• No storage	No cost	Specify with no storage.
	• 11"W right-facing storage	No cost	Specify with 11"W right-facing storage.
	• 16 ¹ / ₂ "W right-facing storage	No cost	Specify with 16 ¹ / ₂ "W right-facing storage.
	• 11"W left-facing storage	No cost	Specify with 11"W left-facing storage.
	• 16 ¹ / ₂ "W left-facing storage	No cost	Specify with 16 ¹ / ₂ "W left-facing storage.
	• 11"W left- and 11"W right-facing storage	No cost	Specify with 11"W left- and 11"W right-facing storage.
	• 11"W left- and 16 ¹ / ₂ "W right-facing storage	No cost	Specify with 11"W left- and 16 ¹ / ₂ "W right-facing storage.
	• 16 ¹ / ₂ "W left- and 11"W right-facing storage	No cost	Specify with 16 ¹ / ₂ "W left- and 11"W right-facing storage.
	• 16 ¹ / ₂ "W left- and 16 ¹ / ₂ "W right-facing storage	No cost	Specify with 16 ¹ / ₂ "W left- and 16 ¹ / ₂ "W right-facing storage.
Storage Type	Right		
	• Right one-tier end table	No cost	Specify with right one-tier end table.
	• Right two-tier end table	No cost	Specify with right two-tier end table.
	Left		
	• Left one-tier end table	No cost	Specify with left one-tier end table.
	• Left two-tier end table	No cost	Specify with left two-tier end table.
Arm Height(s)	Right		
	• Right arm low	No cost	Specify with right arm low.
	• Right arm high	+\$150	Specify with right arm high.
	Left		
	• Left arm low	No cost	Specify with left arm low.
	• Left arm high	+\$150	Specify with left arm high.
Power and Light	Right		
	• Right arm no power	No cost	Specify with right arm no power.
	• Right arm two power	+\$375	Specify with right arm two power.
	• Right arm one power, two USB	+\$445	Specify with right arm one power, two USB.
	• Right arm, four USB	+\$445	Specify with right arm, four USB.
	• Right arm two power, with light capability	+\$375	Specify with right arm two power, with light capability.
	• Right arm one power, two USB, with light capability	+\$445	Specify with right arm one power, two USB, with light capability.
	• Right arm, four USB, with light capability	+\$445	Specify with right arm, four USB, with light capability.
	Left		
	• Left arm no power	No cost	Specify with left arm no power.
	• Left arm two power	+\$375	Specify with left arm two power.
	• Left arm one power, two USB	+\$445	Specify with left arm one power, two USB.
	• Left arm, four USB	+\$445	Specify with left arm, four USB.
	• Left arm two power, with light capability	+\$375	Specify with left arm two power, with light capability.
• Left arm one power, two USB, with light capability	+\$445	Specify with left arm one power, two USB, with light capability.	
• Left arm, four USB, with light capability	+\$445	Specify with left arm, four USB, with light capability.	
Mobility	• Two glides and two casters	+\$510	Specify with two glides and two casters.
Tablet Rail	• Tablet rail	+\$435	Specify with tablet rail.
Related Products	• Storage, one-tier end table • Storage, two-tier end table • Mobile tablet		► Page 217 ► Page 218 ► Page 219

Tip: Storage not available if 71¹/₂"W seat, back, and outer back is specified.

Tip: Storage is specified separately.

► See pages 217–218.

Tip: Storage type is only specified when storage size and location is chosen.

Tip: Power with light can only be specified if adjacent two-tier storage and light are specified. There is an upcharge for the light option on two-tier storage.

► See page 218.

Tip: Only one power with light may be specified in a unit.

Tip: Only four USB ports total may be specified in a unit.

Tip: Mobile tablet is specified separately.

► See page 219.

► Options, continued on next page

Surround Lounge, 82 1/2" Frame Width, continued

SIN 711.16

► Options, continued from previous page

Fabric Upcharges

Style Number	Width	Fabric Price Group 1	Fabric Price Group 2	Fabric Price Group 3	Fabric Price Group 4	Fabric Price Group 5	Fabric Price Group 6	Fabric Price Group 7	Fabric Price Group 8	Fabric Price Group 9	Fabric Price Group 10	COM
HLS83	Seat											
	38 1/2"	No cost	+\$ 57	+\$105	+\$172	+\$252	+\$352	+\$ 682	+\$ 831	+\$ 965	+\$1113	+\$ 57
	44"	No cost	+\$ 72	+\$132	+\$218	+\$319	+\$447	+\$ 772	+\$ 950	+\$1110	+\$1286	+\$ 72
	49 1/2"	No cost	+\$ 85	+\$156	+\$256	+\$375	+\$525	+\$ 818	+\$1015	+\$1193	+\$1388	+\$ 85
	55"	No cost	+\$ 87	+\$161	+\$264	+\$387	+\$543	+\$ 857	+\$1069	+\$1255	+\$1460	+\$ 87
	60 1/2"	No cost	+\$ 98	+\$179	+\$295	+\$431	+\$604	+\$ 863	+\$1080	+\$1276	+\$1491	+\$ 98
	66"	No cost	+\$108	+\$199	+\$327	+\$479	+\$670	+\$ 875	+\$1086	+\$1292	+\$1518	+\$108
	71 1/2"	No cost	+\$127	+\$234	+\$385	+\$563	+\$789	+\$1008	+\$1277	+\$1520	+\$1786	+\$127
	Back											
	38 1/2"	No cost	+\$ 57	+\$105	+\$172	+\$252	+\$352	+\$ 682	+\$ 831	+\$ 965	+\$1113	+\$ 57
	44"	No cost	+\$ 72	+\$132	+\$218	+\$319	+\$447	+\$ 772	+\$ 950	+\$1110	+\$1286	+\$ 72
	49 1/2"	No cost	+\$ 85	+\$156	+\$256	+\$375	+\$525	+\$ 818	+\$1015	+\$1193	+\$1388	+\$ 85
	55"	No cost	+\$ 87	+\$161	+\$264	+\$387	+\$543	+\$ 857	+\$1069	+\$1255	+\$1460	+\$ 87
	60 1/2"	No cost	+\$ 98	+\$179	+\$295	+\$431	+\$604	+\$ 863	+\$1080	+\$1276	+\$1491	+\$ 98
	66"	No cost	+\$108	+\$199	+\$327	+\$479	+\$670	+\$ 875	+\$1086	+\$1292	+\$1518	+\$108
	71 1/2"	No cost	+\$127	+\$234	+\$385	+\$563	+\$789	+\$1008	+\$1277	+\$1520	+\$1786	+\$127
	Outer Back											
	38 1/2"	No cost	+\$ 57	+\$105	+\$172	+\$252	+\$352	+\$ 682	+\$ 831	+\$ 965	+\$1113	+\$ 57
	44"	No cost	+\$ 72	+\$132	+\$218	+\$319	+\$447	+\$ 772	+\$ 950	+\$1110	+\$1286	+\$ 72
	49 1/2"	No cost	+\$ 85	+\$156	+\$256	+\$375	+\$525	+\$ 818	+\$1015	+\$1193	+\$1388	+\$ 85
	55"	No cost	+\$ 87	+\$161	+\$264	+\$387	+\$543	+\$ 857	+\$1069	+\$1255	+\$1460	+\$ 87
60 1/2"	No cost	+\$ 98	+\$179	+\$295	+\$431	+\$604	+\$ 863	+\$1080	+\$1276	+\$1491	+\$ 98	
66"	No cost	+\$108	+\$199	+\$327	+\$479	+\$670	+\$ 875	+\$1086	+\$1292	+\$1518	+\$108	
71 1/2"	No cost	+\$127	+\$234	+\$385	+\$563	+\$789	+\$1008	+\$1277	+\$1520	+\$1786	+\$127	
Arm												
Low	No cost	+\$ 55	+\$ 74	+\$145	+\$188	+\$219	+\$ 262	+\$ 325	+\$ 387	+\$ 457	+\$ 74	
High	No cost	+\$ 85	+\$115	+\$225	+\$291	+\$339	+\$ 406	+\$ 504	+\$ 600	+\$ 708	+\$115	
High Arm Pillow												
Pillow	No cost	+\$ 55	+\$ 74	+\$145	+\$188	+\$219	+\$ 262	+\$ 325	+\$ 387	+\$ 457	+\$ 74	

Tip: Seat, back, and outer back fabrics may be specified in different choices.

► See Understanding Lounge in Steelcase Health Volume 1 Seating Specification Guide.

Tip: Arm fabric and high arm pillow fabric is per arm selected.

Tip: High arm and pillow fabrics may be specified in different choices.

► See Understanding Lounge in Steelcase Health Volume 1 Seating Specification Guide.

Specification Information

Style Number	Frame Dimensions		Seat, Back, and Outer Back Width	Base Prices Low Arms		
	W	D		No arm(s)	One arm	Two arms

82½" Frame Width

HLS83	82½"	27½"	38½"	N.A.	N.A.	\$2295
			44"	N.A.	\$2396	\$2646
			49½"	\$2437	\$2687	\$2937
			55"	\$2494	\$2744	\$2994
			60½"	\$2728	\$2978	\$3228
			66"	\$2959	\$3209	N.A.
			71½"	N.A.	N.A.	\$3933

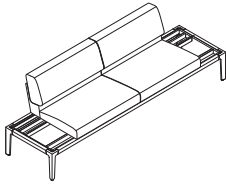

Tip: Sleep surface upcharge is included in base price for 71½"W seat, back, and outer back.

Surround Lounge

88" Frame Width

SIN 711.16

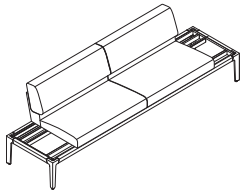

Standard Includes	Required to Specify
<ul style="list-style-type: none"> • Frame: paint price group 1 • Seat, back, and outer back: fabric price group 1 • Sleep surface (if 77"W seat, back, and outer back selected): 5031 Light Merle • Adjustable glides: platinum solid plastic 	<ol style="list-style-type: none"> 1 Style number 2 Seat, back, and outer back width (see below under Required Selections) 3 Sleep surface (see below under Required Selections) 4 Paint color number for frame 5 Fabric color number for seat, back, and outer back 6 Arm position (see below under Required Selections) 7 Options, if selected (see below) <p>▶ See <i>Surface Materials</i>, page 402.</p>

Required Selections	Price	Required to Specify	
Seat, Back, and Outer Back Width	• 44"W seat, back, and outer back	Price at right	Specify with 44"W seat, back, and outer back.
	• 49 1/2"W seat, back, and outer back	Price at right	Specify with 49 1/2"W seat, back, and outer back.
	• 55"W seat, back, and outer back	Price at right	Specify with 55"W seat, back, and outer back.
	• 60 1/2"W seat, back, and outer back	Price at right	Specify with 60 1/2"W seat, back, and outer back.
	• 66"W seat, back, and outer back	Price at right	Specify with 66"W seat, back, and outer back.
	• 77"W seat, back, and outer back	Price at right	Specify with 77"W seat, back, and outer back.

Sleep Surface	• No sleep surface	No cost	Specify with no sleep surface.
	• Sleep surface with 60 1/2"W seat, back, and outer back	+\$600	Specify with sleep surface.
	• Sleep surface with 66"W seat, back, and outer back	+\$625	Specify with sleep surface.
	• Sleep surface with 77"W seat, back, and outer back	\$ 675 Included in Base Price	Specify with sleep surface.

Arm Position	• No arms	Prices at right	Specify with no arms.
	• One arm	Prices at right	Specify with arm right- or left-facing.
	• Two arms	Prices at right	Specify with two arms right- and left-facing.

Options	Price	Required to Specify	
Surface Materials	Frame		
	• Paint price group 1	No cost	Specify paint color number.
	• Paint price group 2	+\$ 28	Specify paint color number.
	• Paint price group 3	+\$ 99	Specify paint color number.
	Seat, back, and outer back		
	• Fabric	Prices at right	Specify fabric color number.
	Arms		
	• Fabric	Prices at right	Specify fabric color number.
	High arm pillow (if high arm(s) selected)		
	• Fabric	Prices at right	Specify fabric color number.

▶ Options, continued on next page

Tip: When specifying no sleep surface, a fixed back will be received.

Tip: Sleep surface is included and the only back available with 77"W seat, back, and outer back selection.

Tip: Sleep surface requires the specification of two arms.

Tip: Left and right determined when facing the unit.

Tip: Understand that standard requires further specification to complete unit.

Tip: For additional specification information, refer to Surround Configuration Charts.

▶ See *Steelcase Health Volume 1 Seating Specification Guide*.

Tip: Fabric upcharges are applied separately for seat, back, and outer back.

► Options, continued from previous page

	Options	Price	Required to Specify
Storage Size(s) and Location(s)	• No storage	No cost	Specify with no storage.
	• 11"W right-facing storage	No cost	Specify with 11"W right-facing storage.
	• 16 1/2"W right-facing storage	No cost	Specify with 16 1/2"W right-facing storage.
	• 11"W left-facing storage	No cost	Specify with 11"W left-facing storage.
	• 16 1/2"W left-facing storage	No cost	Specify with 16 1/2"W left-facing storage.
	• 11"W left- and 11"W right-facing storage	No cost	Specify with 11"W left- and 11"W right-facing storage.
	• 11"W left- and 16 1/2"W right-facing storage	No cost	Specify with 11"W left- and 16 1/2"W right-facing storage.
	• 16 1/2"W left- and 11"W right-facing storage	No cost	Specify with 16 1/2"W left- and 11"W right-facing storage.
	• 16 1/2"W left- and 16 1/2"W right-facing storage	No cost	Specify with 16 1/2"W left- and 16 1/2"W right-facing storage.
	Storage Type	Right	
• Right one-tier end table		No cost	Specify with right one-tier end table.
• Right two-tier end table		No cost	Specify with right two-tier end table.
Left			
• Left one-tier end table		No cost	Specify with left one-tier end table.
• Left two-tier end table		No cost	Specify with left two-tier end table.
Arm Height(s)	Right		
	• Right arm low	No cost	Specify with right arm low.
	• Right arm high	+\$150	Specify with right arm high.
	Left		
	• Left arm low	No cost	Specify with left arm low.
	• Left arm high	+\$150	Specify with left arm high.
Power and Light	Right		
	• Right arm no power	No cost	Specify with right arm no power.
	• Right arm two power	+\$375	Specify with right arm two power.
	• Right arm one power, two USB	+\$445	Specify with right arm one power, two USB.
	• Right arm, four USB	+\$445	Specify with right arm, four USB.
	• Right arm two power, with light capability	+\$375	Specify with right arm two power, with light capability.
	• Right arm one power, two USB, with light capability	+\$445	Specify with right arm one power, two USB, with light capability.
	• Right arm, four USB, with light capability	+\$445	Specify with right arm, four USB, with light capability.
	Left		
	• Left arm no power	No cost	Specify with left arm no power.
	• Left arm two power	+\$375	Specify with left arm two power.
	• Left arm one power, two USB	+\$445	Specify with left arm one power, two USB.
	• Left arm, four USB	+\$445	Specify with left arm, four USB.
	• Left arm two power, with light capability	+\$375	Specify with left arm two power, with light capability.
• Left arm one power, two USB, with light capability	+\$445	Specify with left arm one power, two USB, with light capability.	
• Left arm, four USB, with light capability	+\$445	Specify with left arm, four USB, with light capability.	
Mobility	• Two glides and two casters	+\$510	Specify with two glides and two casters.
Tablet Rail	• Tablet rail	+\$435	Specify with tablet rail.
Related Products	• Storage, one-tier end table		► Page 217
	• Storage, two-tier end table		► Page 218
	• Mobile tablet		► Page 219

► Options, continued on next page

Tip: Storage is specified separately.

► See pages 217–218.

Tip: Storage not available if 77"W seat, back, and outer back is specified.

Tip: Sleep surface requires the specification of two arms.

Tip: Storage type is only specified when storage size and location is chosen.

Tip: Mobile tablet is specified separately.

► See page 219.

Surround Lounge, 88" Frame Width, continued

SIN 711.16

► Options, continued from previous page

Fabric Upcharges

Style Number	Width	Fabric Price Group 1	Fabric Price Group 2	Fabric Price Group 3	Fabric Price Group 4	Fabric Price Group 5	Fabric Price Group 6	Fabric Price Group 7	Fabric Price Group 8	Fabric Price Group 9	Fabric Price Group 10	COM
HLS88												
Seat												
44"	No cost	+\$ 72	+\$132	+\$218	+\$319	+\$447	+\$ 772	+\$ 950	+\$1110	+\$1286	+\$ 72	
49½"	No cost	+\$ 85	+\$156	+\$256	+\$375	+\$525	+\$ 818	+\$1015	+\$1193	+\$1388	+\$ 85	
55"	No cost	+\$ 87	+\$161	+\$264	+\$387	+\$543	+\$ 857	+\$1069	+\$1255	+\$1460	+\$ 87	
60½"	No cost	+\$ 98	+\$179	+\$295	+\$431	+\$604	+\$ 863	+\$1080	+\$1276	+\$1491	+\$ 98	
66"	No cost	+\$108	+\$199	+\$327	+\$479	+\$670	+\$ 875	+\$1086	+\$1292	+\$1518	+\$108	
77"	No cost	+\$140	+\$257	+\$423	+\$619	+\$867	+\$1109	+\$1405	+\$1671	+\$1964	+\$140	
Back												
44"	No cost	+\$ 72	+\$132	+\$218	+\$319	+\$447	+\$ 772	+\$ 950	+\$1110	+\$1286	+\$ 72	
49½"	No cost	+\$ 85	+\$156	+\$256	+\$375	+\$525	+\$ 818	+\$1015	+\$1193	+\$1388	+\$ 85	
55"	No cost	+\$ 87	+\$161	+\$264	+\$387	+\$543	+\$ 857	+\$1069	+\$1255	+\$1460	+\$ 87	
60½"	No cost	+\$ 98	+\$179	+\$295	+\$431	+\$604	+\$ 863	+\$1080	+\$1276	+\$1491	+\$ 98	
66"	No cost	+\$108	+\$199	+\$327	+\$479	+\$670	+\$ 875	+\$1086	+\$1292	+\$1518	+\$108	
77"	No cost	+\$140	+\$257	+\$423	+\$619	+\$867	+\$1109	+\$1405	+\$1671	+\$1964	+\$140	
Outer Back												
44"	No cost	+\$ 72	+\$132	+\$218	+\$319	+\$447	+\$ 772	+\$ 950	+\$1110	+\$1286	+\$ 72	
49½"	No cost	+\$ 85	+\$156	+\$256	+\$375	+\$525	+\$ 818	+\$1015	+\$1193	+\$1388	+\$ 85	
55"	No cost	+\$ 87	+\$161	+\$264	+\$387	+\$543	+\$ 857	+\$1069	+\$1255	+\$1460	+\$ 87	
60½"	No cost	+\$ 98	+\$179	+\$295	+\$431	+\$604	+\$ 863	+\$1080	+\$1276	+\$1491	+\$ 98	
66"	No cost	+\$108	+\$199	+\$327	+\$479	+\$670	+\$ 875	+\$1086	+\$1292	+\$1518	+\$108	
77"	No cost	+\$140	+\$257	+\$423	+\$619	+\$867	+\$1109	+\$1405	+\$1671	+\$1964	+\$140	
Arm												
Low	No cost	+\$ 55	+\$ 74	+\$145	+\$188	+\$219	+\$ 262	+\$ 325	+\$ 387	+\$ 457	+\$ 74	
High	No cost	+\$ 85	+\$115	+\$225	+\$291	+\$339	+\$ 406	+\$ 504	+\$ 600	+\$ 708	+\$115	
High Arm Pillow												
Pillow	No cost	+\$ 55	+\$ 74	+\$145	+\$188	+\$219	+\$ 262	+\$ 325	+\$ 387	+\$ 457	+\$ 74	

Tip: Seat, back, and outer back fabrics may be specified in different choices.

► See Understanding Lounge in Steelcase Health Volume 1 Seating Specification Guide.

Tip: Arm fabric and high arm pillow fabric is per arm selected.

Tip: High arm and pillow fabrics may be specified in different choices.

► See Understanding Lounge in Steelcase Health Volume 1 Seating Specification Guide.

Specification Information

Style Number	Frame Dimensions		Seat, Back, and Outer Back Width	Base Prices Low Arms		
	W	D		No arm(s)	One arm	Two arms

88" Frame Width

HLS88	88"	27½"	44"	N.A.	N.A.	\$2687
			49½"	N.A.	\$2728	\$2978
			55"	\$2535	\$2785	\$3035
			60½"	\$2769	\$3019	\$3269
			66"	\$3000	\$3250	\$3500
			77"	N.A.	N.A.	\$4277

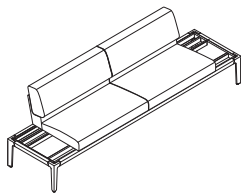

Tip: Sleep surface upcharge is included in base price for 77"W seat, back, and outer back.

Surround Lounge

93½" Frame Width

SIN 711.16

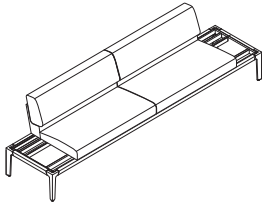

Standard Includes	Required to Specify
-------------------	---------------------

- Frame: paint price group 1
- Seat, back, and outer back: fabric price group 1
- Sleep surface (if 71½"W seat, back and outer back selected): 5031 Light Merle
- Adjustable glides: platinum solid plastic

- 1 Style number
 - 2 Seat, back, and outer back width (see below under Required Selections)
 - 3 Sleep surface (see below under Required Selections)
 - 4 Paint color number for frame
 - 5 Fabric color number for seat, back, and outer back
 - 6 Arm position (see below under Required Selections)
 - 7 Options, if selected (see below)
- ▶ See *Surface Materials*, page 402.

Required Selections	Price	Required to Specify
---------------------	-------	---------------------

Seat, Back, and Outer Back Width

- 49½"W seat, back, and outer back Prices at right
- 55"W seat, back, and outer back Prices at right
- 60½"W seat, back, and outer back Prices at right
- 66"W seat, back, and outer back Prices at right
- 71½"W seat, back, and outer back Prices at right

Specify with 49½"W seat, back, and outer back.
Specify with 55"W seat, back, and outer back.
Specify with 60½"W seat, back, and outer back.
Specify with 66"W seat, back, and outer back.
Specify with 71½"W seat, back, and outer back.

Sleep Surface

- No sleep surface No cost
- Sleep surface with 60½"W seat, back, and outer back +\$600
- Sleep surface with 66"W seat, back, and outer back +\$625
- Sleep surface with 71½"W seat, back, and outer back \$ 650
Included in Base Price

Specify with no sleep surface.
Specify with sleep surface.
Specify with sleep surface.
Specify with sleep surface.

Arm Position

- No arms Prices at right
- One arm Prices at right
- Two arms Prices at right

Specify with no arms.
Specify with arm right- or left-facing.
Specify with two arms right- and left-facing.

Options	Price	Required to Specify
---------	-------	---------------------

Surface Materials

- Frame**
- Paint price group 1 No cost
 - Paint price group 2 +\$ 28
 - Paint price group 3 +\$ 99

Specify paint color number.
Specify paint color number.
Specify paint color number.
▶ See *Surface Materials*, page 402.

Seat, back, and outer back

- Fabric Prices at right

Specify fabric color number.

Arms

- Fabric Prices at right

Specify fabric color number.

High arm pillow (if high arm(s) selected)

- Fabric Prices at right

Specify fabric color number.

▶ Options, continued on next page

Tip: When specifying no sleep surface, a fixed back will be received.

Tip: Sleep surface is included and the only back available with 71½"W seat, back, and outer back selection.

Tip: Sleep surface requires the specification of two arms.

Tip: Left and right determined when facing the unit.

Tip: Understand that standard requires further specification to complete unit.

Tip: For additional specification information, refer to Surround Configuration Charts.

▶ See *Steelcase Health Volume 1 Seating Specification Guide*.

Tip: Fabric upcharges are applied separately for seat, back, and outer back.

Tip: Sleep surface requires the specification of two arms.

► Options, continued from previous page

	Options	Price	Required to Specify
Storage Size(s) and Location(s)	• 11"W right-facing storage	No cost	Specify with 11"W right-facing storage.
	• 16 ¹ / ₂ "W right-facing storage	No cost	Specify with 16 ¹ / ₂ "W right-facing storage.
	• 11"W left-facing storage	No cost	Specify with 11"W left-facing storage.
	• 16 ¹ / ₂ "W left-facing storage	No cost	Specify with 16 ¹ / ₂ "W left-facing storage.
	• 11"W left- and 11"W right-facing storage	No cost	Specify with 11"W left- and 11"W right-facing storage.
	• 16 ¹ / ₂ "W left- and 11"W right-facing storage	No cost	Specify with 16 ¹ / ₂ "W left- and 11"W right-facing storage.
	• 11"W left- and 16 ¹ / ₂ "W right-facing storage	No cost	Specify with 11"W left- and 16 ¹ / ₂ "W right-facing storage.
	• 16 ¹ / ₂ "W left- and 16 ¹ / ₂ "W right-facing storage	No cost	Specify with 16 ¹ / ₂ "W left- and 16 ¹ / ₂ "W right-facing storage.
Storage Type	Right		
	• Right one-tier end table	No cost	Specify with right one-tier end table.
	• Right two-tier end table	No cost	Specify with right two-tier end table.
	Left		
• Left one-tier end table	No cost	Specify with left one-tier end table.	
• Left two-tier end table	No cost	Specify with left two-tier end table.	
Arm Height(s)	Right		
	• Right arm low	No cost	Specify with right arm low.
	• Right arm high	+\$150	Specify with right arm high.
	Left		
• Left arm low	No cost	Specify with left arm low.	
• Left arm high	+\$150	Specify with left arm high.	
Power and Light	Right		
	• Right arm no power	No cost	Specify with right arm no power.
	• Right arm two power	+\$375	Specify with right arm two power.
	• Right arm one power, two USB	+\$445	Specify with right arm one power, two USB.
	• Right arm, four USB	+\$445	Specify with right arm, four USB.
	• Right arm two power, with light capability	+\$375	Specify with right arm two power, with light capability.
	• Right arm one power, two USB, with light capability	+\$445	Specify with right arm one power, two USB, with light capability.
	• Right arm, four USB, with light capability	+\$445	Specify with right arm, four USB, with light capability.
	Left		
	• Left arm no power	No cost	Specify with left arm no power.
	• Left arm two power	+\$375	Specify with left arm two power.
	• Left arm one power, two USB	+\$445	Specify with left arm one power, two USB.
	• Left arm, four USB	+\$445	Specify with left arm, four USB.
	• Left arm two power, with light capability	+\$375	Specify with left arm two power, with light capability.
• Left arm one power, two USB, with light capability	+\$445	Specify with left arm one power, two USB, with light capability.	
• Left arm, four USB, with light capability	+\$445	Specify with left arm, four USB, with light capability.	
Mobility	• Two glides and two casters	+\$510	Specify with two glides and two casters.
Tablet Rail	• Tablet rail	+\$435	Specify with tablet rail.
Related Products	• Storage, one-tier end table		► Page 217
	• Storage, two-tier end table		► Page 218
	• Mobile tablet		► Page 219

► Options, continued on next page

Tip: Storage is specified separately.

► See pages 217–218.

Tip: Storage type is only specified when storage size and location is chosen.

Tip: Power with light can only be specified if adjacent two-tier storage and light are specified. There is an upcharge for the light option on two-tier storage.

► See page 218.

Tip: Only one power with light may be specified in a unit.

Tip: Only four USB ports total may be specified in a unit.

Tip: Mobile tablet is specified separately.

► See page 219.

Surround Lounge, 93¹/₂" Frame Width, continued

SIN 711.16

► Options, continued from previous page

Fabric Upcharges

Style Number	Width	Fabric Price										COM
		Group 1	Group 2	Group 3	Group 4	Group 5	Group 6	Group 7	Group 8	Group 9	Group 10	
HLS94	Seat											
	49 ¹ / ₂ "	No cost	+\$ 85	+\$156	+\$256	+\$375	+\$525	+\$ 818	+\$1015	+\$1193	+\$1388	+\$ 85
	55"	No cost	+\$ 87	+\$161	+\$264	+\$387	+\$543	+\$ 857	+\$1069	+\$1255	+\$1460	+\$ 87
	60 ¹ / ₂ "	No cost	+\$ 98	+\$179	+\$295	+\$431	+\$604	+\$ 863	+\$1080	+\$1276	+\$1491	+\$ 98
	66"	No cost	+\$108	+\$199	+\$327	+\$479	+\$670	+\$ 875	+\$1086	+\$1292	+\$1518	+\$108
	71 ¹ / ₂ "	No cost	+\$127	+\$234	+\$385	+\$563	+\$789	+\$1008	+\$1277	+\$1520	+\$1786	+\$127
	Back											
	49 ¹ / ₂ "	No cost	+\$ 85	+\$156	+\$256	+\$375	+\$525	+\$ 818	+\$1015	+\$1193	+\$1388	+\$ 85
	55"	No cost	+\$ 87	+\$161	+\$264	+\$387	+\$543	+\$ 857	+\$1069	+\$1255	+\$1460	+\$ 87
	60 ¹ / ₂ "	No cost	+\$ 98	+\$179	+\$295	+\$431	+\$604	+\$ 863	+\$1080	+\$1276	+\$1491	+\$ 98
	66"	No cost	+\$108	+\$199	+\$327	+\$479	+\$670	+\$ 875	+\$1086	+\$1292	+\$1518	+\$108
	71 ¹ / ₂ "	No cost	+\$127	+\$234	+\$385	+\$563	+\$789	+\$1008	+\$1277	+\$1520	+\$1786	+\$127
	Outer Back											
	49 ¹ / ₂ "	No cost	+\$ 85	+\$156	+\$256	+\$375	+\$525	+\$ 818	+\$1015	+\$1193	+\$1388	+\$ 85
	55"	No cost	+\$ 87	+\$161	+\$264	+\$387	+\$543	+\$ 857	+\$1069	+\$1255	+\$1460	+\$ 87
	60 ¹ / ₂ "	No cost	+\$ 98	+\$179	+\$295	+\$431	+\$604	+\$ 863	+\$1080	+\$1276	+\$1491	+\$ 98
	66"	No cost	+\$108	+\$199	+\$327	+\$479	+\$670	+\$ 875	+\$1086	+\$1292	+\$1518	+\$108
	71 ¹ / ₂ "	No cost	+\$127	+\$234	+\$385	+\$563	+\$789	+\$1008	+\$1277	+\$1520	+\$1786	+\$127
Arm												
Low	No cost	+\$ 55	+\$ 74	+\$145	+\$188	+\$219	+\$ 262	+\$ 325	+\$ 387	+\$ 457	+\$ 74	
High	No cost	+\$ 85	+\$115	+\$225	+\$291	+\$339	+\$ 406	+\$ 504	+\$ 600	+\$ 708	+\$115	
High Arm Pillow												
Pillow	No cost	+\$ 55	+\$ 74	+\$145	+\$188	+\$219	+\$ 262	+\$ 325	+\$ 387	+\$ 457	+\$ 74	

Tip: Seat, back, and outer back fabrics may be specified in different choices. ► See Understanding Lounge in Steelcase Health Volume 1 Seating Specification Guide.

Tip: Arm fabric and high arm pillow fabric is per arm selected.

Tip: High arm and pillow fabrics may be specified in different choices. ► See Understanding Lounge in Steelcase Health Volume 1 Seating Specification Guide.

Specification Information

Style Number	Frame Dimensions		Seat, Back, and Outer Back Width	Base Price Low Arms		
	W	D		No arm(s)	One arm	Two arms

93¹/₂" Frame Width

HLS94	93 ¹ / ₂ "	27 ¹ / ₂ "	49 ¹ / ₂ "	N.A.	N.A.	\$3008
			55"	N.A.	\$2815	\$3065
			60 ¹ / ₂ "	\$2799	\$3049	\$3299
			66"	\$3030	\$3280	\$3530
			71 ¹ / ₂ "	N.A.	N.A.	\$4004

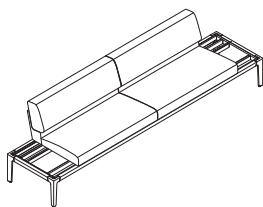

Tip: Sleep surface upcharge is included in base price for 71¹/₂"W seat, back, and outer back.

Surround Lounge

99" Frame Width

SIN 711.16

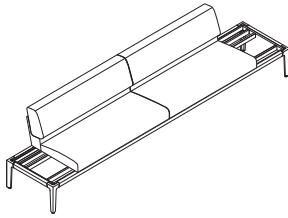

Standard Includes	Required to Specify
-------------------	---------------------

- Frame: paint price group 1
- Seat, back, and outer back: fabric price group 1
- Sleep surface (if 71¹/₂"W or 77"W seat, back and outer back selected): 5031 Light Merle
- Adjustable glides: platinum solid plastic

- 1 Style number
 - 2 Seat, back, and outer back width (see below under Required Selections)
 - 3 Sleep surface (see below under Required Selections)
 - 4 Paint color number for frame
 - 5 Fabric color number for seat, back, and outer back
 - 6 Arm position (see below under Required Selections)
 - 7 Options, if selected (see below)
- ▶ See *Surface Materials*, page 402.

Required Selections	Price	Required to Specify
---------------------	-------	---------------------

Seat, Back, and Outer Back Width

- 55"W seat, back, and outer back Price at right
- 60¹/₂"W seat, back, and outer back Price at right
- 66"W seat, back, and outer back Price at right
- 71¹/₂"W seat, back, and outer back Price at right
- 77"W seat, back, and outer back Price at right

- Specify with 55"W seat, back, and outer back.
Specify with 60¹/₂"W seat, back, and outer back.
Specify with 66"W seat, back, and outer back.
Specify with 71¹/₂"W seat, back, and outer back.
Specify with 77"W seat, back, and outer back.

Sleep Surface

- No sleep surface No cost
- Sleep surface with 60¹/₂"W seat, back, and outer back +\$600
- Sleep surface with 66"W seat, back, and outer back +\$625
- Sleep surface with 71¹/₂"W seat, back, and outer back \$ 650
Included in Base Price
- Sleep surface with 77"W seat, back, and outer back \$ 675
Included in Base Price

- Specify with no sleep surface.
Specify with sleep surface.
Specify with sleep surface.
Specify with sleep surface.
Specify with sleep surface.

Arm Position

- No arms Prices at right
- One arm Prices at right
- Two arms Prices at right

- Specify with no arms.
Specify with arm right- or left-facing.
Specify with two arms right- and left-facing.

Options	Price	Required to Specify
---------	-------	---------------------

Surface Materials

- Frame**
- Paint price group 1 No cost
 - Paint price group 2 +\$ 28
 - Paint price group 3 +\$ 99

- Specify paint color number.
Specify paint color number.
Specify paint color number.
▶ See *Surface Materials*, page 402.

Seat, back, and outer back

- Fabric Prices at right

- Specify fabric color number.

Arms

- Fabric Prices at right

- Specify fabric color number.

High arm pillow (if high arm(s) selected)

- Fabric Prices at right

- Specify fabric color number.

▶ Options, continued on next page

Tip: When specifying no sleep surface, a fixed back will be received.

Tip: Sleep surface is included and the only back available with 71¹/₂"W or 77"W seat, back, and outer back selection.

Tip: Sleep surface requires the specification of two arms.

Tip: Left and right determined when facing the unit.

Tip: Understand that standard requires further specification to complete unit.

Tip: For additional specification information, refer to Surround Configuration Charts.

▶ See *Steelcase Health Volume 1 Seating Specification Guide*.

Tip: Fabric upcharges are applied separately for seat, back, and outer back.

Tip: Sleep surface requires the specification of two arms.

► Options, continued from previous page

	Options	Price	Required to Specify
Storage Size(s) and Location(s)	• 11"W right-facing storage	No cost	Specify with 11"W right-facing storage.
	• 16 ¹ / ₂ "W right-facing storage	No cost	Specify with 16 ¹ / ₂ "W right-facing storage.
	• 11"W left-facing storage	No cost	Specify with 11"W left-facing storage.
	• 16 ¹ / ₂ "W left-facing storage	No cost	Specify with 16 ¹ / ₂ "W left-facing storage.
	• 11"W left- and 11"W right-facing storage	No cost	Specify with 11"W left- and 11"W right-facing storage.
	• 16 ¹ / ₂ "W left- and 11"W right-facing storage	No cost	Specify with 16 ¹ / ₂ "W left- and 11"W right-facing storage.
	• 11"W left- and 16 ¹ / ₂ "W right-facing storage	No cost	Specify with 11"W left- and 16 ¹ / ₂ "W right-facing storage.
	• 16 ¹ / ₂ "W left- and 16 ¹ / ₂ "W right-facing storage	No cost	Specify with 16 ¹ / ₂ "W left- and 16 ¹ / ₂ "W right-facing storage.
Storage Type	Right		
	• Right one-tier end table	No cost	Specify with right one-tier end table.
	• Right two-tier end table	No cost	Specify with right two-tier end table.
	Left		
• Left one-tier end table	No cost	Specify with left one-tier end table.	
• Left two-tier end table	No cost	Specify with left two-tier end table.	
Arm Height(s)	Right		
	• Right arm low	No cost	Specify with right arm low.
	• Right arm high	+\$150	Specify with right arm high.
	Left		
• Left arm low	No cost	Specify with left arm low.	
• Left arm high	+\$150	Specify with left arm high.	
Power and Light	Right		
	• Right arm no power	No cost	Specify with right arm no power.
	• Right arm two power	+\$375	Specify with right arm two power.
	• Right arm one power, two USB	+\$455	Specify with right arm one power, two USB.
	• Right arm, four USB	+\$445	Specify with right arm, four USB.
	• Right arm two power, with light capability	+\$375	Specify with right arm two power, with light capability.
	• Right arm one power, two USB, with light capability	+\$445	Specify with right arm one power, two USB, with light capability.
	• Right arm, four USB, with light capability	+\$445	Specify with right arm, four USB, with light capability.
	Left		
	• Left arm no power	No cost	Specify with left arm no power.
	• Left arm two power	+\$375	Specify with left arm two power.
	• Left arm one power, two USB	+\$445	Specify with left arm one power, two USB.
	• Left arm, four USB	+\$445	Specify with left arm, four USB.
	• Left arm two power, with light capability	+\$375	Specify with left arm two power, with light capability.
• Left arm one power, two USB, with light capability	+\$445	Specify with left arm one power, two USB, with light capability.	
• Left arm, four USB, with light capability	+\$445	Specify with left arm, four USB, with light capability.	
Mobility	• Two glides and two casters	+\$510	Specify with two glides and two casters.
Tablet Rail	• Tablet rail	+\$435	Specify with tablet rail.
Related Products	• Storage, one-tier end table		► Page 217
	• Storage, two-tier end table		► Page 218
	• Mobile tablet		► Page 219

Tip: Storage is specified separately.

► See pages 217–218.

Tip: Storage type is only specified when storage size and location is chosen.

Tip: Power with light can only be specified if adjacent two-tier storage and light are specified. There is an upcharge for the light option on two-tier storage.

► See page 218.

Tip: Only one power with light may be specified in a unit.

Tip: Only four USB ports total may be specified in a unit.

Tip: Mobile tablet is specified separately.

► See page 219.

► Options, continued on next page

Surround Lounge, 99" Frame Width, continued

SIN 711.16

► Options, continued from previous page

Fabric Upcharges

Style Number	Width	Fabric Price	Fabric Price	Fabric Price	Fabric Price	Fabric Price	Fabric Price	Fabric Price	Fabric Price	Fabric Price	Fabric Price	COM
		Group 1	Group 2	Group 3	Group 4	Group 5	Group 6	Group 7	Group 8	Group 9	Group 10	
HLS99 Seat												
55"	No cost	+\$ 87	+\$161	+\$264	+\$387	+\$543	+\$ 857	+\$1069	+\$1255	+\$1460	+\$ 87	
60½"	No cost	+\$ 98	+\$179	+\$295	+\$431	+\$604	+\$ 863	+\$1080	+\$1276	+\$1491	+\$ 98	
66"	No cost	+\$108	+\$199	+\$327	+\$479	+\$670	+\$ 875	+\$1086	+\$1292	+\$1518	+\$108	
71½"	No cost	+\$127	+\$234	+\$385	+\$563	+\$789	+\$1008	+\$1277	+\$1520	+\$1786	+\$127	
77"	No cost	+\$140	+\$257	+\$423	+\$619	+\$867	+\$1109	+\$1405	+\$1671	+\$1964	+\$140	
Back												
55"	No cost	+\$ 87	+\$161	+\$264	+\$387	+\$543	+\$ 857	+\$1069	+\$1255	+\$1460	+\$ 87	
60½"	No cost	+\$ 98	+\$179	+\$295	+\$431	+\$604	+\$ 863	+\$1080	+\$1276	+\$1491	+\$ 98	
66"	No cost	+\$108	+\$199	+\$327	+\$479	+\$670	+\$ 875	+\$1086	+\$1292	+\$1518	+\$108	
71½"	No cost	+\$127	+\$234	+\$385	+\$563	+\$789	+\$1008	+\$1277	+\$1520	+\$1786	+\$127	
77"	No cost	+\$140	+\$257	+\$423	+\$619	+\$867	+\$1109	+\$1405	+\$1671	+\$1964	+\$140	
Outer Back												
55"	No cost	+\$ 87	+\$161	+\$264	+\$387	+\$543	+\$ 857	+\$1069	+\$1255	+\$1460	+\$ 87	
60½"	No cost	+\$ 98	+\$179	+\$295	+\$431	+\$604	+\$ 863	+\$1080	+\$1276	+\$1491	+\$ 98	
66"	No cost	+\$108	+\$199	+\$327	+\$479	+\$670	+\$ 875	+\$1086	+\$1292	+\$1518	+\$108	
71½"	No cost	+\$127	+\$234	+\$385	+\$563	+\$789	+\$1008	+\$1277	+\$1520	+\$1786	+\$127	
77"	No cost	+\$140	+\$257	+\$423	+\$619	+\$867	+\$1109	+\$1405	+\$1671	+\$1964	+\$140	
Arm												
Low	No cost	+\$ 55	+\$ 74	+\$145	+\$188	+\$219	+\$ 262	+\$ 325	+\$ 387	+\$ 457	+\$ 74	
High	No cost	+\$ 85	+\$115	+\$225	+\$291	+\$339	+\$ 406	+\$ 504	+\$ 600	+\$ 708	+\$115	
High Arm Pillow												
Pillow	No cost	+\$ 55	+\$ 74	+\$145	+\$188	+\$219	+\$ 262	+\$ 325	+\$ 387	+\$ 457	+\$ 74	

Tip: Seat, back, and outer back fabrics may be specified in different choices. ► See Understanding Lounge in Steelcase Health Volume 1 Seating Specification Guide.

Tip: Arm fabric and high arm pillow fabric is per arm selected.

Tip: High arm and pillow fabrics may be specified in different choices. ► See Understanding Lounge in Steelcase Health Volume 1 Seating Specification Guide.

Specification Information

Style Number	Frame Dimensions		Seat, Back, and Outer Back Width	Base Prices Low Arms		
	W	D		No arm(s)	One arm	Two arms

99" Frame Width

HLS99	99"	27½"	55"	N.A.	N.A.	\$3095
			60½"	N.A.	\$3079	\$3329
			66"	\$3060	\$3310	\$3560
			71½"	N.A.	N.A.	\$4034
			77"	N.A.	N.A.	\$4337

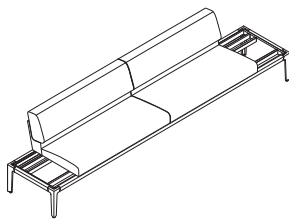

Tip: Sleep surface upcharge is included in base price for 71½"W and 77"W seat, back, and outer back.

Surround Lounge

104¹/₂" Frame Width

SIN 711.16

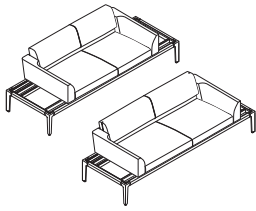

Standard Includes	Required to Specify
-------------------	---------------------

- Frame: paint price group 1
- Seat, back, and outer back: fabric price group 1
- Sleep surface (if 71¹/₂"W or 77"W seat, back and outer back selected): 5031 Light Merle
- Adjustable glides: platinum solid plastic

- 1 Style number
 - 2 Seat, back, and outer back width (see below under Required Selections)
 - 3 Sleep surface (see below under Required Selections)
 - 4 Paint color number for frame
 - 5 Fabric color number for seat, back, and outer back
 - 6 Arm position (see below under Required Selections)
 - 7 Options, if selected (see below)
- ▶ See *Surface Materials*, page 402.

Tip: When specifying no sleep surface, a fixed back will be received.

Tip: Sleep surface is included and the only back available with 71¹/₂"W or 77"W seat, back, and outer back selection.

Tip: Sleep surface requires the specification of two arms.

Required Selections	Price	Required to Specify
Seat, Back, and Outer Back Width		
• 60 ¹ / ₂ "W seat, back, and outer back	Price at right	Specify with 60 ¹ / ₂ "W seat, back, and outer back.
• 66"W seat, back, and outer back	Price at right	Specify with 66"W seat, back, and outer back.
• 71 ¹ / ₂ "W seat, back, and outer back	Price at right	Specify with 71 ¹ / ₂ "W seat, back, and outer back.
• 77"W seat, back, and outer back	Price at right	Specify with 77"W seat, back, and outer back.
Sleep Surface		
• No sleep surface	No cost	Specify with no sleep surface.
• Sleep surface with 60 ¹ / ₂ "W seat, back, and outer back	+\$600	Specify with sleep surface.
• Sleep surface with 66"W seat, back, and outer back	+\$625	Specify with sleep surface.
• Sleep surface with 71 ¹ / ₂ "W seat, back, and outer back	\$ 650 Included in Base Price	Specify with sleep surface.
• Sleep surface with 77"W seat, back, and outer back	\$ 675 Included in Base Price	Specify with sleep surface.
Arm Position		
• No arms	Prices at right	Specify with no arms.
• One arm	Prices at right	Specify with arm right- or left-facing.
• Two arms	Prices at right	Specify with two arms right- and left-facing.

Options	Price	Required to Specify
Surface Materials		
Frame		
• Paint price group 1	No cost	Specify paint color number.
• Paint price group 2	+\$ 28	Specify paint color number.
• Paint price group 3	+\$ 99	Specify paint color number. ▶ See <i>Surface Materials</i> , page 402.
Seat, back, and outer back		
• Fabric	Prices at right	Specify fabric color number.
Arms		
• Fabric	Prices at right	Specify fabric color number.
High arm pillow (if high arm(s) selected)		
• Fabric	Prices at right	Specify fabric color number.

Tip: Fabric upcharges are applied separately for seat, back, and outer back.

Tip: Storage is specified separately.
▶ See pages 217–218.

Tip: Storage type is only specified when storage size and location is chosen.

Storage Size(s) and Location(s)		
• 16 ¹ / ₂ "W right-facing storage	No cost	Specify with 16 ¹ / ₂ "W right-facing storage.
• 11"W left-facing storage	No cost	Specify with 11"W left-facing storage.
• 16 ¹ / ₂ "W left-facing storage	No cost	Specify with 16 ¹ / ₂ "W left-facing storage.
• 11"W left- and 11"W right-facing storage	No cost	Specify with 11"W left- and 11"W right-facing storage.
• 16 ¹ / ₂ "W left- and 11"W right-facing storage	No cost	Specify with 16 ¹ / ₂ "W left- and 11"W right-facing storage.
• 11"W left- and 16 ¹ / ₂ "W right-facing storage	No cost	Specify with 11"W left- and 16 ¹ / ₂ "W right-facing storage.
• 16 ¹ / ₂ "W left- and 16 ¹ / ₂ "W right-facing storage	No cost	Specify with 16 ¹ / ₂ "W left- and 16 ¹ / ₂ "W right-facing storage.

▶ Options, continued on next page

► Options, continued from previous page

	Options	Price	Required to Specify
Storage Type	Right		
	• Right one-tier end table	No cost	Specify with right one-tier end table.
	• Right two-tier end table	No cost	Specify with right two-tier end table.
	Left		
	• Left one-tier end table	No cost	Specify with left one-tier end table.
	• Left two-tier end table	No cost	Specify with left two-tier end table.
Arm Height(s)	Right		
	• Right arm low	No cost	Specify with right arm low.
	• Right arm high	+\$150	Specify with right arm high.
	Left		
	• Left arm low	No cost	Specify with left arm low.
	• Left arm high	+\$150	Specify with left arm high.
Power and Light	Right		
	• Right arm no power	No cost	Specify with right arm no power.
	• Right arm two power	+\$375	Specify with right arm two power.
	• Right arm one power, two USB	+\$445	Specify with right arm one power, two USB.
	• Right arm, four USB	+\$445	Specify with right arm, four USB.
	• Right arm two power, with light capability	+\$375	Specify with right arm two power, with light capability.
	• Right arm two power, with light capability	+\$375	Specify with right arm two power, with light capability.
	• Right arm one power, two USB, with light capability	+\$445	Specify with right arm one power, two USB, with light capability.
	• Right arm, four USB, with light capability	+\$445	Specify with right arm, four USB, with light capability.
	Left		
	• Left arm no power	No cost	Specify with left arm no power.
	• Left arm two power	+\$375	Specify with left arm two power.
	• Left arm one power, two USB	+\$445	Specify with left arm one power, two USB.
	• Left arm, four USB	+\$445	Specify with left arm, four USB.
• Left arm two power, with light capability	+\$375	Specify with left arm two power, with light capability.	
• Left arm one power, two USB, with light capability	+\$445	Specify with left arm one power, two USB, with light capability.	
• Left arm, four USB, with light capability	+\$445	Specify with left arm, four USB, with light capability.	
Mobility	• Two glides and two casters	+\$510	Specify with two glides and two casters.
Tablet Rail	• Tablet rail	+\$435	Specify with tablet rail.
Related Products	• Storage, one-tier end table		► Page 217
	• Storage, two-tier end table		► Page 218
	• Mobile tablet		► Page 219

► Options, continued on next page

Tip: Storage type is only specified when storage size and location is chosen.

Tip: Sleep surface requires the specification of two arms.

Tip: Power with light can only be specified if adjacent two-tier storage and light are specified. There is an upcharge for the light option on two-tier storage.
► See page 218.

Tip: Only one power with light may be specified in a unit.

Tip: Only four USB ports total may be specified in a unit.

Tip: Mobile tablet is specified separately.
► See page 219.

Surround Lounge, 104 1/2" Frame Width, continued

SIN 711.16

► Options, continued from previous page

Fabric Upcharges

• Style Number	• Width	• Fabric	• Fabric	• Fabric	• Fabric	• Fabric	• Fabric	• Fabric	• Fabric	• Fabric	• Fabric	• COM
		Price	Price	Price	Price	Price	Price	Price	Price	Price	Price	
		Group 1	Group 2	Group 3	Group 4	Group 5	Group 6	Group 7	Group 8	Group 9	Group 10	
HLS105 Seat												
60 1/2"	No cost	+\$ 98	+\$179	+\$295	+\$431	+\$604	+\$ 863	+\$1080	+\$1276	+\$1491	+\$ 98	
66"	No cost	+\$108	+\$199	+\$327	+\$479	+\$670	+\$ 875	+\$1086	+\$1292	+\$1518	+\$108	
71 1/2"	No cost	+\$127	+\$234	+\$385	+\$563	+\$789	+\$1008	+\$1277	+\$1520	+\$1786	+\$127	
77"	No cost	+\$140	+\$257	+\$423	+\$619	+\$867	+\$1109	+\$1405	+\$1671	+\$1964	+\$140	
Back												
60 1/2"	No cost	+\$ 98	+\$179	+\$295	+\$431	+\$604	+\$ 863	+\$1080	+\$1276	+\$1491	+\$ 98	
66"	No cost	+\$108	+\$199	+\$327	+\$479	+\$670	+\$ 875	+\$1086	+\$1292	+\$1518	+\$108	
71 1/2"	No cost	+\$127	+\$234	+\$385	+\$563	+\$789	+\$1008	+\$1277	+\$1520	+\$1786	+\$127	
77"	No cost	+\$140	+\$257	+\$423	+\$619	+\$867	+\$1109	+\$1405	+\$1671	+\$1964	+\$140	
Outer Back												
60 1/2"	No cost	+\$ 98	+\$179	+\$295	+\$431	+\$604	+\$ 863	+\$1080	+\$1276	+\$1491	+\$ 98	
66"	No cost	+\$108	+\$199	+\$327	+\$479	+\$670	+\$ 875	+\$1086	+\$1292	+\$1518	+\$108	
71 1/2"	No cost	+\$127	+\$234	+\$385	+\$563	+\$789	+\$1008	+\$1277	+\$1520	+\$1786	+\$127	
77"	No cost	+\$140	+\$257	+\$423	+\$619	+\$867	+\$1109	+\$1405	+\$1671	+\$1964	+\$140	
Arm												
Low	No cost	+\$ 55	+\$ 74	+\$145	+\$188	+\$219	+\$ 262	+\$ 325	+\$ 387	+\$ 457	+\$ 74	
High	No cost	+\$ 85	+\$115	+\$225	+\$291	+\$339	+\$ 406	+\$ 504	+\$ 600	+\$ 708	+\$115	
High Arm Pillow												
Pillow	No cost	+\$ 55	+\$ 74	+\$145	+\$188	+\$219	+\$ 262	+\$ 325	+\$ 387	+\$ 457	+\$ 74	

Tip: Seat, back, and outer back fabrics may be specified in different choices. ► See Understanding Lounge in Steelcase Health Volume 1 Seating Specification Guide.

Tip: Arm fabric and high arm pillow fabric is per arm selected.

Tip: High arm and pillow fabrics may be specified in different choices. ► See Understanding Lounge in Steelcase Health Volume 1 Seating Specification Guide.

Specification Information

• Style Number	• Frame Dimensions		• Seat, Back, and Outer Back Width	• Base Prices Low Arms		
	W	D		No arm(s)	One arm	Two arms

104 1/2" Frame Width

HLS105	104 1/2"	27 1/2"	60 1/2"	N.A.	N.A.	\$3359
			66"	N.A.	\$3340	\$3590
			71 1/2"	N.A.	N.A.	\$4064
			77"	N.A.	N.A.	\$4367

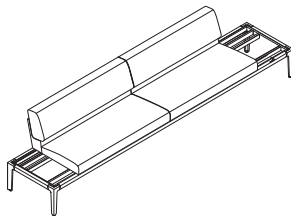

Tip: Sleep surface upcharge is included in base price for 71 1/2"W and 77"W seat, back, and outer back.

Surround Storage

One-Tier End Table

SIN 711.16

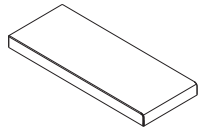

Tip: Storage width must match storage size specified on frame.

Tip: Storage cannot be specified adjacent to other storage.

Standard Includes	Required to Specify
<ul style="list-style-type: none"> Table: paint 	<ol style="list-style-type: none"> Style number Table width (see below under Required Selections) Storage location (see below under Required Selections) Paint color number for table <p>▶ See <i>Surface Materials</i>, page 402.</p>

	Required Selections	Price	Required to Specify
Table Width	<ul style="list-style-type: none"> 11"W 16 1/2"W 	Price below Price below	Specify with 11"W. Specify with 16 1/2"W.
Storage Location	<ul style="list-style-type: none"> Left-facing storage Right-facing storage 	No cost No cost	Specify with <i>left-facing storage</i> . Specify with <i>right-facing storage</i> .

Specification Information		
Style Number	Prices	
	11"W	16 1/2"W
HLSET	\$500	\$600

Seating

Surround Storage

Two-Tier End Table

SIN 711.16

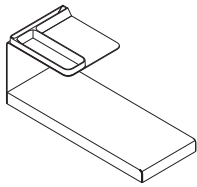

Tip: Two-tier storage requires the specification of an adjacent arm.

Tip: Storage tray with picture rail is not available when light is specified.

Tip: Storage width must match storage size specified on frame.

Tip: Storage location is determined when frame is specified.

Tip: Light requires the specification of power with light in arm adjacent to storage.

Tip: Upper storage refers to the entire second tier, and lower storage refers to the bottom tier.

Tip: Storage cannot be specified adjacent to other storage.

Standard Includes	Required to Specify
<ul style="list-style-type: none"> Table: paint Storage tray with picture rail: 6527 Merle 	<ol style="list-style-type: none"> Style number Table width (see below under Required Selections) Paint color number for table Coat hanger (see below under Required Selections) Light (see below under Required Selections) Storage location (see below under Required Selections) Color scheme (see below under Required Selections) <p>▶ See <i>Surface Materials</i>, page 402.</p>

	Required Selections	Price	Required to Specify
Table Width	<ul style="list-style-type: none"> 11"W 16¹/₂"W 	Price below Price below	Specify with 11"W. Specify with 16 ¹ / ₂ "W.
Coat Hanger	<ul style="list-style-type: none"> Coat hanger 	+\$100	Specify with coat hanger and select paint color number. ▶ See <i>Surface Materials</i> , page 402.
Light	<ul style="list-style-type: none"> Light 	+\$450	Specify with light (power in arm).
Storage Location	<ul style="list-style-type: none"> Left-facing storage Right-facing storage 	No cost No cost	Specify with left-facing storage. Specify with right-facing storage.
Color Scheme	<ul style="list-style-type: none"> Contrasting finish 	+\$ 25	Specify with contrasting and select paint color number for upper and lower storage. ▶ See <i>Surface Materials</i> , page 402.

Specification Information		
	Base Prices	
Style Number	11"W	16 ¹ / ₂ "W
HLSTTT	\$1400	\$1500

Surround Mobile Tablet

SIN 711.16

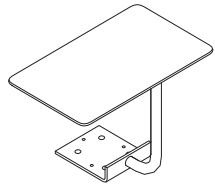

Tip: Tablet arm and tablet attach to the unit on site.

Tip: Tablet rail is specified on the frame.

Tip: Only one tablet rail and mobile tablet can be specified per unit.

Standard Includes	Required to Specify
<ul style="list-style-type: none"> • Tablet surface: plastic • Tablet arm: paint 	<ul style="list-style-type: none"> 1 Style number 2 Plastic color number for tablet surface 3 Paint color number for tablet arm ▶ See <i>Surface Materials</i>, page 402.

Specification Information

•Style Number	•Price
HLSMT	\$1315

Seating

X-tenz Sleeper Chairs

Single Sleeper Chairs

SIN 711.16

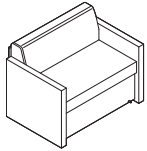

Tip: Specify the rollout section opening to the left or right as you face the front of the sleeper chair.

Tip: Different fabrics for the seat and back can be specified. If the fabrics are in different price groups, calculate list price by adding the two price groups together and dividing by two.

Standard Includes	Required to Specify
-------------------	---------------------

- Seat cushion and back bolsters: fabric
- Arm caps: fabric
- Back and front kick panels: laminate
- Glides or casters: black only

- 1 Style number
 - 2 Fabric color number for seat cushion and back bolsters
 - 3 Laminate color number for back panel and front kick panel
 - 4 Options, if selected (see below)
- ▶ See *Surface Materials*, page 402.

Options	Price	Required to Specify
---------	-------	---------------------

Surface Materials

Arm caps

- Plastisol arm caps: +\$103
- Maple wood arm caps: +\$159

Specify with *plastisol arm caps* and select plastic color number.
Specify with *wood arm caps* and select wood color number.

Moisture barrier on seat/mattress only

- Moisture barrier: +\$359

Specify with *moisture barrier*.

Specification Information

Base Prices

Style Number	Fabric Price	Fabric Price	Fabric Price	Fabric Price	Fabric Price	Fabric Price	Fabric Price	Fabric Price	Fabric Price	Fabric Price	COM
	Group 1	Group 2	Group 3	Group 4	Group 5	Group 6	Group 7	Group 8	Group 9	Group 10	

With Glides

With Rollout Section Opening to the Left

SC8141L	\$3056	\$3368	\$3680	\$3926	\$4176	\$4362	\$4608	\$4980	\$5480	\$5788	\$3118
----------------	--------	--------	--------	--------	--------	--------	--------	--------	--------	--------	--------

With Rollout Section Opening to the Right

SC8141R	\$3056	\$3368	\$3680	\$3926	\$4176	\$4362	\$4608	\$4980	\$5480	\$5788	\$3118
----------------	--------	--------	--------	--------	--------	--------	--------	--------	--------	--------	--------

With Casters

With Rollout Section Opening to the Left

SC8141LC	\$3384	\$3696	\$4008	\$4254	\$4504	\$4690	\$4936	\$5308	\$5808	\$6116	\$3446
-----------------	--------	--------	--------	--------	--------	--------	--------	--------	--------	--------	--------

With Rollout Section Opening to the Right

SC8141RC	\$3384	\$3696	\$4008	\$4254	\$4504	\$4690	\$4936	\$5308	\$5808	\$6116	\$3446
-----------------	--------	--------	--------	--------	--------	--------	--------	--------	--------	--------	--------

X-tenz Sleeper Chairs

Double Sleeper Chairs

SIN 711.16

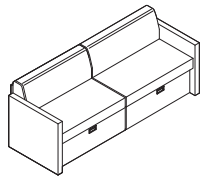

Tip: Different fabrics for the seat and back can be specified. If the fabrics are in different price groups, calculate list price by adding the two price groups together and dividing by two.

Standard Includes	Required to Specify
-------------------	---------------------

- Seat cushion and back bolsters: fabric
- Arm caps: fabric
- Back and front kick panels: laminate
- Glides: black only

- 1 Style number
 - 2 Fabric color number for seat cushion and back bolsters
 - 3 Laminate color number for back panel and front kick panel
 - 4 Options, if selected (see below)
- ▶ See *Surface Materials*, page 402.

Seating

Options	Price	Required to Specify
---------	-------	---------------------

Surface Materials

Arm caps

- Plastisol arm caps: +\$103
- Maple wood arm caps: +\$159

Specify with *plastisol arm caps* and select plastic color number.
Specify with *wood arm caps* and select wood color number.

Moisture barrier on seat/mattress only

- Moisture barrier: +\$481

Specify with *moisture barrier*.

Specification Information											
Base Prices											
Style Number	Fabric Price Group 1	Fabric Price Group 2	Fabric Price Group 3	Fabric Price Group 4	Fabric Price Group 5	Fabric Price Group 6	Fabric Price Group 7	Fabric Price Group 8	Fabric Price Group 9	Fabric Price Group 10	COM

SC8241	\$5292	\$5744	\$6196	\$6552	\$6916	\$7186	\$7548	\$8086	\$8808	\$9258	\$5354
---------------	--------	--------	--------	--------	--------	--------	--------	--------	--------	--------	--------

Steelcase Health Casegoods

Modular Casegoods

Opus (SIN 71.315)	225
Sonata (SIN 711.3)	253
Sync (SIN 711.2)	273
Folio (SIN 71.315)	287
Wall-Mounted Folio (SIN 71.315)	327

Freestanding Casegoods

Ainsley (SIN 71.315)	343
Davenport (SIN 71.315)	347
Park (SIN 71.315)	353
Senza (SIN 71.315)	359
Waldorf (SIN 71.315)	371



Opus

► For more detailed product information, see the Steelcase Health Seating and Caseloads Specification Guides, or consult your Steelcase dealer.

Statement of Line 226

Specifying

Cabinets

Cabinets with 36"H Storage Unit (SIN 71.315)	232
Cabinets with 36"H Hinged-Door Storage Unit for Use with Sink (SIN 71.315)	233
Cabinets with 30"H Storage Unit (SIN 71.315)	234
Cabinets with 24"H Storage Unit (SIN 71.315)	235
Cabinets with 18½"H Storage Unit (SIN 71.315)	236
Desk Cabinets (SIN 71.315)	237
Conference Table Cabinets (SIN 71.315)	238
Wardrobe Cabinet with Sliding Door (SIN 71.315)	239
Wardrobe Cabinets with Swing Door (SIN 71.315)	240

Bedside Tables (SIN 71.315) 241

Overhead Shelves and Cabinets

Overhead Shelves (SIN 71.315)	242
Overhead Shelves with Box Unit (SIN 71.315)	243
Overhead Storage Cabinets with Doors (SIN 71.315)	244

Accessories

Common Tops (SIN 71.315)	245
Inside Corner Fillers (SIN 71.315)	246
Wall Trim Packages (SIN 71.315)	246
Ceiling Tracks (SIN 71.315)	247
Mounting Boards (SIN 71.315)	248
Cushions (SIN 71.315)	249
Coat Hooks (SIN 71.315)	249
Wall-Anchor Brackets (SIN 71.315)	250
Floor-Anchor Brackets (SIN 71.315)	250
OSHPD Brackets (SIN 71.315)	251
Transformer (SIN 71.315)	251

Mobile Overbed Table (SIN 71.315) 380

Statement of Line

Opus

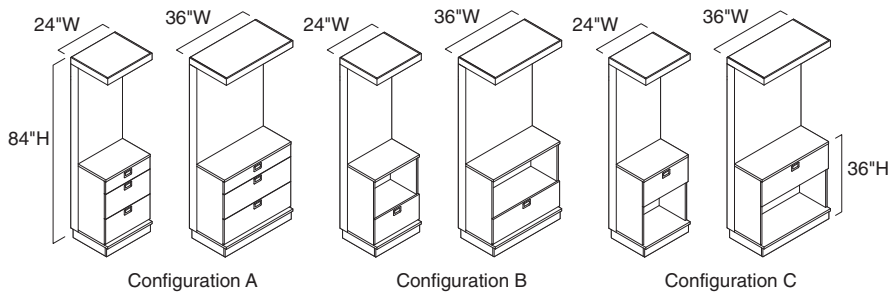

Specifying
▶ Page 232

Cabinets with 36\"/>

	24\"/>	
Configuration A	●	●
Configuration B	●	●
Configuration C	●	●

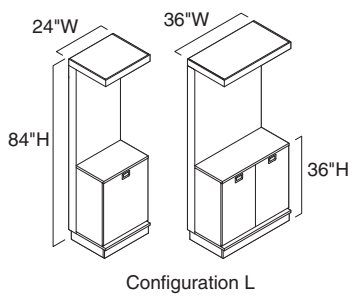

Specifying
▶ Page 233

Cabinets with 36\"/>

	24\"/>	
Configuration L	●	●

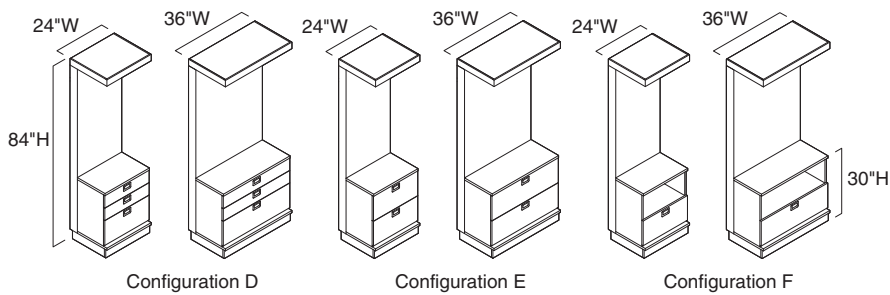

Specifying
▶ Page 234

Cabinets with 30\"/>

	24\"/>	
Configuration D	●	●
Configuration E	●	●
Configuration F	●	●

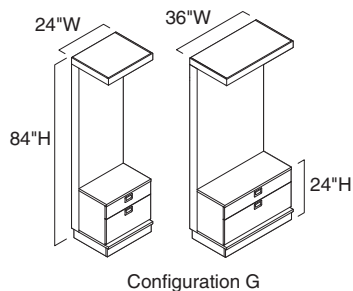

Specifying
▶ Page 235

Cabinets with 24"H Storage Unit

	24"W	36"W
Configuration G	●	●

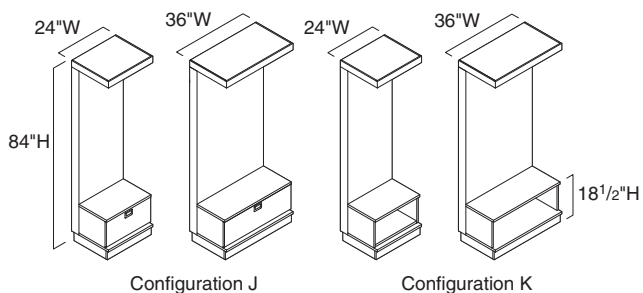

Specifying
▶ Page 236

Cabinets with 18 1/2"H Storage Unit

	24"W	36"W
Configuration J	●	●
Configuration K	●	●

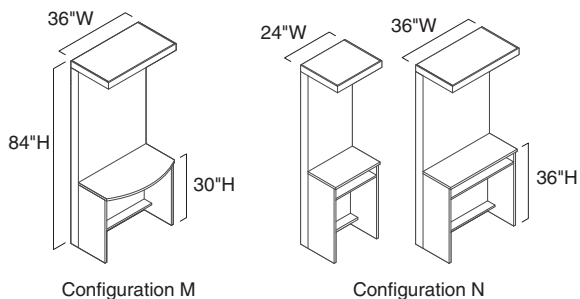

Specifying
▶ Page 237

Desk Cabinets

	24"W	36"W
Configuration M—Sitting Height		●
Configuration N—Standing Height	●	●

Statement of Line Opus, continued

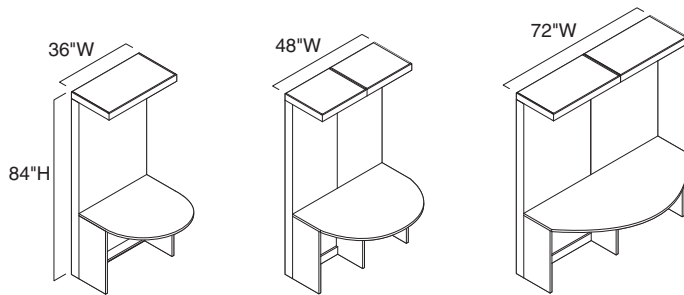

Specifying
▶ Page 238

Conference Table Cabinets

	36"W	48"W	72"W
Configuration P	●	●	●

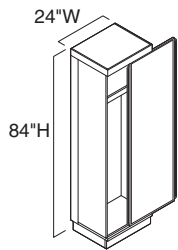

Specifying
▶ Page 239

Wardrobe Cabinet with Sliding Door

	24"W
Wardrobe Cabinet	●

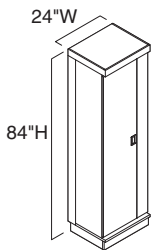

Specifying
▶ Page 240

Wardrobe Cabinets with Swing Door*

	24"W
Wardrobe Cabinet	●

*Left-hand cabinet shown. Right-hand cabinets available.

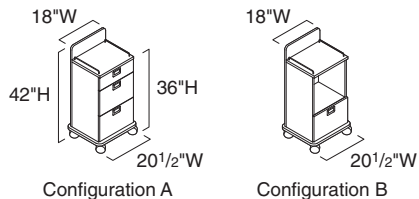

Specifying
▶ Page 241

Bedside Tables

	18"W
Configuration A	●
Configuration B	●

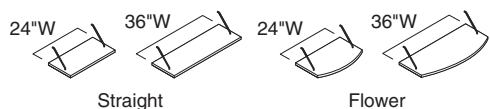

Specifying
▶ Page 242

Overhead Shelves

	24"W	36"W
Straight	●	●
Flower	●	●

Tip: 36"W flower shelf is non-handed. Shelf can be reversed in the field.

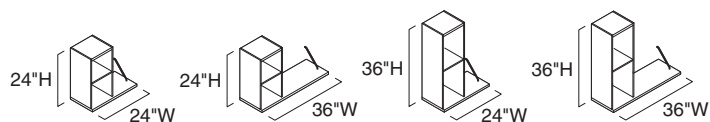

Specifying
▶ Page 243

Overhead Straight Shelves with Box Unit

	24"W	36"W
24"H	●	●
36"H	●	●

Tip: Box unit can be field installed in either the left- or right-hand location.

Statement of Line Opus, continued

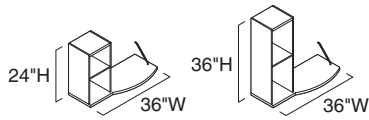

Specifying
▶ Page 243

Overhead Flower Shelves with Box Unit

	36"W
24"H	●
36"H	●

Tip: 36"W flower shelf with box unit is non-handed. Shelf can be reversed in the field so that the box unit can be field installed in either the left- or right-hand location.

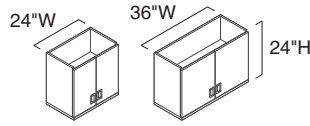

Specifying
▶ Page 244

Overhead Storage Cabinets with Doors

	24"W	36"W
24"H	●	●

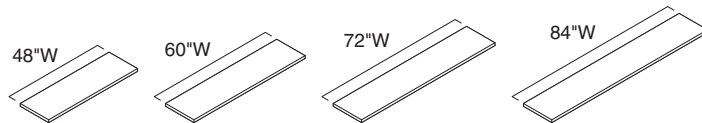

Specifying
▶ Page 245

Common Tops

	48"W	60"W	72"W	84"W
15"D	●	●	●	●

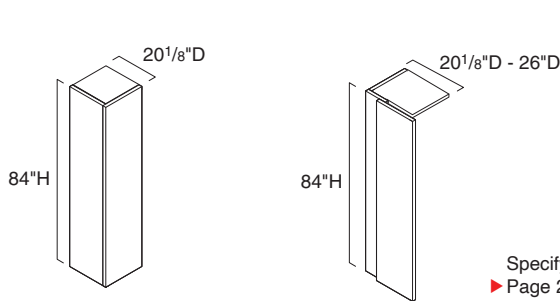

Specifying
▶ Page 246

Inside Corner Filler Panels

	20 1/8"D	20 1/8"-26"D
84"H	●	●

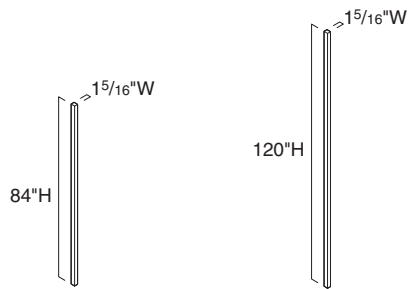

Specifying
▶ Page 246

Wall Trim Packages

	15/16"W
84"H	●
120"H	●

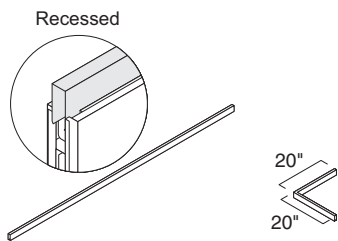

Specifying
▶ Page 247

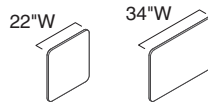

Specifying
▶ Page 248

Ceiling Tracks*

Length

120" to cut on site

*Corner ceiling track is also available.

Mounting Boards

	22"W	34"W
32"H	●	●

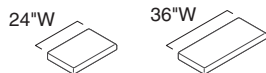

Specifying
▶ Page 249

Cushions

	24"W	36"W
15"D	●	●

Opus Cabinets with 36"H Storage Unit

Laminate
SIN 71.315

Tip: The melamine color matches the selected laminate color, so it does not need to be specified.

Standard Includes	Required to Specify
<ul style="list-style-type: none"> • Base unit and storage unit case: melamine • Storage unit top and drawer front: laminate • Edge band on storage unit top and drawer: 3 mm plastic • Drawer body: white plastic and melamine only • Flush pull(s): champagne only • 3/4" depth drawer slides • Base: black melamine only • Adjustable glides 	<ol style="list-style-type: none"> 1 Style number 2 Laminate color number for cabinet with storage unit 3 Edge band color number for storage unit top and drawers 4 Options, if selected (see below) <p>▶ See <i>Surface Materials</i>, page 402.</p>

Options	Price	Required to Specify
Surface Materials <ul style="list-style-type: none"> • Laminate • Open Line laminate 	No cost +\$91	▶ See <i>Surface Materials Reference Manual</i> . ▶ See <i>Surface Materials Reference Manual</i> .
Storage Unit Top <ul style="list-style-type: none"> • Omit top 	-\$59	Specify <i>with no top</i> .
Light Cutouts <ul style="list-style-type: none"> • Left, right, or center cutout • Left and right cutout 	+\$23 each +\$28	Specify <i>with left, right, or center light cutout</i> . Specify <i>with left and right light cutout</i> .
Switch Cutouts <ul style="list-style-type: none"> • Single and double cutouts 	+\$11 each	Specify cutout location and select single or double cutout.
Lock and Keying <ul style="list-style-type: none"> • Lock • Polished Chrome • Keying • Standard keying • Specific keying • Master keying 	+\$23 No cost No cost +\$24	Specify <i>with lock</i> . Specify <i>with standard keying</i> . Specify <i>with field installed locks</i> . Specify <i>with master keying</i> .
Related Products <ul style="list-style-type: none"> • Bedside Tables • Overhead Shelves and Cabinets • Accessories 		▶ Page 241 ▶ Pages 242–244 ▶ Pages 245–251

*Must order lock plugs from Service Parts (4678420SR).

Tip: See accessories for common tops.

Specification Information

• Dimensions			• Style	• Base
D	W	H	Number	Price

Configuration A Cabinets

20"	24"	84"	HC2484AL	\$1905
20"	36"	84"	HC3684AL	\$2224

Configuration B Cabinets

20"	24"	84"	HC2484BL	\$1630
20"	36"	84"	HC3684BL	\$1895

Configuration C Cabinets

20"	24"	84"	HC2484CL	\$1630
20"	36"	84"	HC3684CL	\$1895

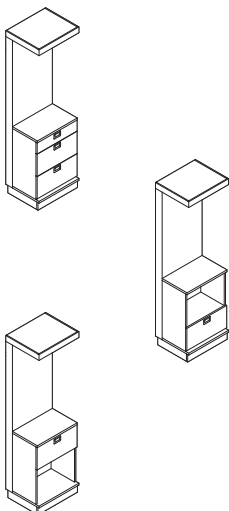

Opus Cabinets with 36"H Hinged-Door Storage Unit for Use with Sink

Opus
Cabinets with 36"H
Hinged-Door Storage
Unit for Use with Sink

Laminate

SIN 71.315

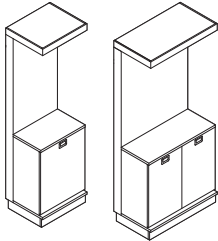

Tip: The melamine color matches the selected laminate color, so it does not need to be specified.

Tip: Sink must be independently purchased and field installed. Sink cutout must be cut in the field.

*Must order lock plugs from Service Parts (4678420SR).

Tip: See accessories for common tops.

Standard Includes	Required to Specify
<ul style="list-style-type: none"> • Base unit, storage unit case, and adjustable shelf: melamine • Storage unit top and door front: laminate • Edge band of storage unit top and door: 3 mm plastic • Flush pull(s): champagne only • Base: black melamine only • Adjustable glides 	<ol style="list-style-type: none"> 1 Style number 2 Laminate color number for cabinet with storage unit 3 Edge band color number for storage unit top and door 4 Options, if selected (see below) <p>▶ See <i>Surface Materials</i>, page 402.</p>

Options	Price	Required to Specify	
Surface Materials <ul style="list-style-type: none"> • Laminate • Open Line laminate 	No cost +\$91	▶ See <i>Surface Materials Reference Manual</i> . ▶ See <i>Surface Materials Reference Manual</i> .	
Storage Unit Top <ul style="list-style-type: none"> • Omit top 	-\$59	Specify with no top.	
Light Cutouts <ul style="list-style-type: none"> • Left, right, or center cutout • Left and right cutout 	+\$23 each +\$28	Specify with left, right, or center light cutout. Specify with left and right light cutout.	
Switch Cutouts <ul style="list-style-type: none"> • Single and double cutouts 	+\$11 each	Specify cutout location and select single or double cutout.	
Door Direction for 24"W Cabinet <ul style="list-style-type: none"> • Left-hand door • Right-hand door 	No cost No cost	Specify with left-hand door. Specify with right-hand door.	
Lock and Keying	Lock <ul style="list-style-type: none"> • Polished Chrome 	+\$23 No cost No cost +\$24	Specify with lock. Specify with standard keying. Specify with field installed locks.* Specify with master keying.
Related Products	<ul style="list-style-type: none"> • Bedside Tables • Overhead Shelves and Cabinets • Accessories 	▶ Page 241 ▶ Pages 242–244 ▶ Pages 245–251	

Specification Information

Dimensions			Style Number	Base Price
D	W	H		

Configuration L Cabinets

20"	24"	84"	HC2484LL	\$1608
20"	36"	84"	HC3684LL	\$1919

Opus

Opus Cabinets with 30"H Storage Unit

Laminate
SIN 71.315

Tip: The melamine color matches the selected laminate color, so it does not need to be specified.

Standard Includes	Required to Specify
<ul style="list-style-type: none"> • Base unit and storage unit case: melamine • Storage unit top and drawer front: laminate • Edge band on storage unit top and drawer: 3 mm plastic • Drawer body: white plastic and melamine only • Flush pull(s): champagne only • 3/4" depth drawer slides • Base: black melamine only • Adjustable glides 	<ol style="list-style-type: none"> 1 Style number 2 Laminate color number for cabinet with storage unit 3 Edge band color number for storage unit top and drawers 4 Options, if selected (see below) <p>▶ See <i>Surface Materials</i>, page 402.</p>

Options	Price	Required to Specify
Surface Materials <ul style="list-style-type: none"> • Laminate • Open Line laminate 	No cost +\$91	▶ See <i>Surface Materials Reference Manual</i> . ▶ See <i>Surface Materials Reference Manual</i> .
Light Cutouts <ul style="list-style-type: none"> • Left, right, or center cutout • Left and right cutout 	+\$23 each +\$28	Specify with <i>left, right, or center light cutout</i> . Specify with <i>left and right light cutout</i> .
Switch Cutouts <ul style="list-style-type: none"> • Single and double cutouts 	+\$11 each	Specify cutout location and select single or double cutout.
Lock and Keying <ul style="list-style-type: none"> Lock <ul style="list-style-type: none"> • Polished Chrome Keying <ul style="list-style-type: none"> • Standard keying • Specific keying • Master keying 	+\$23 No cost No cost +\$24	Specify with <i>lock</i> . Specify with <i>standard keying</i> . Specify with <i>field installed locks</i> . Specify with <i>master keying</i> .
Related Products <ul style="list-style-type: none"> • Bedside Tables • Overhead Shelves and Cabinets • Accessories 		▶ Page 241 ▶ Pages 242–244 ▶ Pages 245–251

*Must order lock plugs from Service Parts (4678420SR).

Specification Information

Dimensions			Style Number	Base Price
D	W	H		

Configuration D Cabinets

20"	24"	84"	HC2484DL	\$1864
20"	36"	84"	HC3684DL	\$2060

Configuration E Cabinets

20"	24"	84"	HC2484EL	\$1696
20"	36"	84"	HC3684EL	\$1952

Configuration F Cabinets

20"	24"	84"	HC2484FL	\$1612
20"	36"	84"	HC3684FL	\$1881

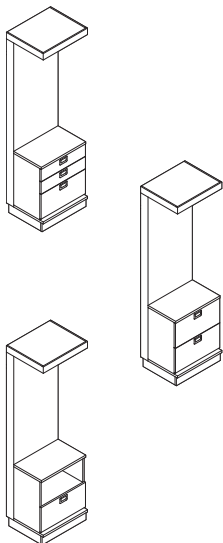

Opus Cabinets with 24"H Storage Unit

Laminate

SIN 71.315

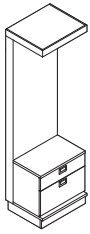

Tip: The melamine color matches the selected laminate color, so it does not need to be specified.

*Must order lock plugs from Service Parts (4678420SR).

Standard Includes		Required to Specify	
<ul style="list-style-type: none"> • Base unit and storage unit case: melamine • Storage unit top and drawer front: laminate • Edge band on storage unit top and drawer: 3 mm plastic • Drawer body: white plastic and melamine only • Flush pull(s): champagne only • ¾" depth drawer slides • Base: black melamine only • Adjustable glides 		<ol style="list-style-type: none"> 1 Style number 2 Laminate color number for cabinet with storage unit 3 Edge band color number for storage unit top and drawers 4 Options, if selected (see below) <p>▶ See <i>Surface Materials</i>, page 402.</p>	
Options	Price	Required to Specify	
Surface Materials	• Laminate	No cost	▶ See <i>Surface Materials Reference Manual</i> .
	• Open Line laminate	+\$91	▶ See <i>Surface Materials Reference Manual</i> .
Light Cutouts	• Left, right, or center cutout	+\$23 each	Specify with <i>left, right, or center light cutout</i> .
	• Left and right cutout	+\$28	Specify with <i>left and right light cutout</i> .
Switch Cutouts	• Single and double cutouts	+\$11 each	Specify cutout location and select single or double cutout.
Lock and Keying	Lock		
	• Polished Chrome	+\$23	Specify with <i>lock</i> .
	Keying		
	• Standard keying	No cost	Specify with <i>standard keying</i> .
	• Specific keying	No cost	Specify with <i>field installed locks</i> .*
	• Master keying	+\$24	Specify with <i>master keying</i> .
Related Products	<ul style="list-style-type: none"> • Bedside Tables • Overhead Shelves and Cabinets • Accessories 		<p>▶ Page 241</p> <p>▶ Pages 242–244</p> <p>▶ Pages 245–251</p>

Specification Information				
Dimensions			Style	Base
D	W	H	Number	Price
..

Configuration G Cabinets				
20"	24"	84"	HC2484GL	\$1654
20"	36"	84"	HC3684GL	\$1924
..



Opus Cabinets with 18½"H Storage Unit

Laminate
SIN 71.315

Tip: The melamine color matches the selected laminate color, so it does not need to be specified.

Tip: Overhead storage cabinet or shelf is not recommended on cabinets with 18½"H storage unit. There is not sufficient clearance for a person to sit.

Standard Includes		Required to Specify	
	<ul style="list-style-type: none"> • Base unit and storage unit case: melamine • Storage unit top and drawer front: laminate • Edge band on storage unit top and drawer: 3 mm plastic • Drawer body: white plastic and melamine only • Flush pull: champagne only • ¾" depth drawer slides • Base: black melamine only • Adjustable glides 		<ol style="list-style-type: none"> 1 Style number 2 Laminate color number for cabinet with storage unit 3 Edge band color number for storage unit top and drawer 4 Options, if selected (see below) <p>▶ See <i>Surface Materials</i>, page 402.</p>
Surface Materials	Options	Price	Required to Specify
	<ul style="list-style-type: none"> • Laminate • Open Line laminate 	<p>No cost</p> <p>+\$91</p>	<p>▶ See <i>Surface Materials Reference Manual</i>.</p> <p>▶ See <i>Surface Materials Reference Manual</i>.</p>
Light Cutouts	<ul style="list-style-type: none"> • Left, right, or center cutout • Left and right cutout 	<p>+\$23 each</p> <p>+\$28</p>	<p>Specify with <i>left, right, or center light cutout</i>.</p> <p>Specify with <i>left and right light cutout</i>.</p>
Switch Cutouts	<ul style="list-style-type: none"> • Single and double cutouts 	<p>+\$11 each</p>	<p>Specify cutout location and select single or double cutout.</p>
Lock and Keying	Lock	<ul style="list-style-type: none"> • Polished Chrome 	<p>+\$23</p> <p>Specify with <i>lock</i>.</p>
	Keying	<ul style="list-style-type: none"> • Standard keying • Specific keying • Master keying 	<p>No cost</p> <p>No cost</p> <p>+\$24</p> <p>Specify with <i>standard keying</i>.</p> <p>Specify with <i>field installed locks</i>.*</p> <p>Specify with <i>master keying</i>.</p>
Related Products	<ul style="list-style-type: none"> • Bedside Tables • Cushions • Coat hooks • Wall-anchor brackets 		<p>▶ Page 241</p> <p>▶ Page 249</p> <p>▶ Page 249</p> <p>▶ Page 250</p>

*Must order lock plugs from Service Parts (4678420SR).

Specification Information

Dimensions			Style Number	Base Price
D	W	H		

Configuration J Cabinets

20"	24"	84"	HC2484JL	\$1445
20"	36"	84"	HC3684JL	\$1713
:	:	:	:	:

Configuration K Cabinets

20"	24"	84"	HC2484KL	\$1313
20"	36"	84"	HC3684KL	\$1547
:	:	:	:	:

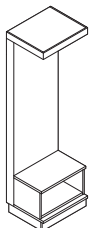
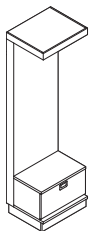

Opus Desk Cabinets

Laminate

SIN 71.315

Tip: The melamine color matches the selected laminate color, so it does not need to be specified.

Tip: Desk cabinets cannot be used adjacent to a sliding door wardrobe cabinet. The desk cabinet doesn't have the 1" space required for the wardrobe's sliding door.

Standard Includes		Required to Specify	
	<ul style="list-style-type: none"> Base unit and desk unit: melamine Desk worksurface: laminate Edge band on worksurface: 3 mm plastic Shelf on standing-height desk only: melamine Adjustable glides 		<ul style="list-style-type: none"> 1 Style number 2 Laminate color number for desk cabinet 3 Edge band color number for worksurface 4 Options, if selected (see below) ▶ See <i>Surface Materials</i>, page 402.
Options	Price	Required to Specify	
Surface Materials	<ul style="list-style-type: none"> Laminate: No cost Open Line laminate: +\$91 	<ul style="list-style-type: none"> ▶ See <i>Surface Materials Reference Manual</i>. ▶ See <i>Surface Materials Reference Manual</i>. 	
Light Cutouts	<ul style="list-style-type: none"> Left, right, or center cutout: +\$23 each Left and right cutout: +\$28 	<ul style="list-style-type: none"> Specify with <i>left, right, or center light cutout</i>. Specify with <i>left and right light cutout</i>. 	
Switch Cutouts	<ul style="list-style-type: none"> Single and double cutouts: +\$11 each 	<ul style="list-style-type: none"> Specify cutout location and select single or double cutout. 	
Related Products	<ul style="list-style-type: none"> Bedside Tables Overhead Shelves and Cabinets Accessories 	<ul style="list-style-type: none"> ▶ Page 241 ▶ Pages 242–244 ▶ Pages 245–251 	

Specification Information

Dimensions			Style	Base
D	W	H	Number	Price

Configuration M—Sitting-Height Desk Cabinet

D	W	H	Style Number	Base Price
20"	36"	84"	HC3684ML	\$1517

Configuration N—Standing-Height Desk Cabinets

D	W	H	Style Number	Base Price
20"	24"	84"	HC2484NL	\$1435
20"	36"	84"	HC3684NL	\$1594

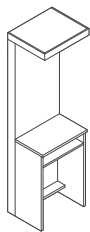
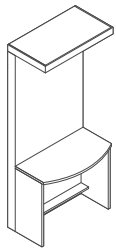

Opus

Opus Conference Table Cabinets

Laminate

SIN 71.315

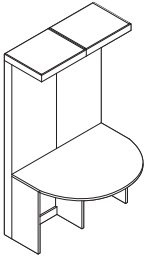

Tip: The melamine color matches the selected laminate color, so it does not need to be specified.

Tip: Conference table cabinets cannot be used adjacent to a sliding door wardrobe cabinet. The desk cabinet doesn't have the 1" space required for the wardrobe's sliding door.

Tip: When the conference table cabinet is used as a stand alone unit, a wall-anchor bracket must be used. Check local codes.

Tip: More than four light cutouts are not recommended on 48"W cabinets.

Standard Includes	Required to Specify
<ul style="list-style-type: none"> • Base unit and conference table unit: melamine • Conference table worksurface: laminate • Edge band on worksurface: 3 mm plastic • Adjustable glides 	<ol style="list-style-type: none"> 1 Style number 2 Laminate color number for conference table worksurface 3 Edge band color number for worksurface 4 Options, if selected (see below) <p>▶ See <i>Surface Materials</i>, page 402.</p>

	Options	Price	Required to Specify
Surface Materials	• Laminate	No cost	▶ See <i>Surface Materials Reference Manual</i> .
	• Open Line laminate	+\$91	▶ See <i>Surface Materials Reference Manual</i> .
Light Cutouts	• Left, right, or center cutout on 36"W cabinet	+\$23 each	Specify with left, right, or center light cutout.
	• Left and right cutout on 36"W cabinet	+\$28	Specify with left and right light cutout.
	• Cutouts on 48"W and 72"W cabinets	+\$23 each	Specify with light cutout positions.
Switch Cutouts	• Single and double cutouts	+\$11 each	Specify cutout location and select single or double cutout.
Related Products	<ul style="list-style-type: none"> • Overhead Shelves and Cabinets • Accessories 		<p>▶ Pages 242–244</p> <p>▶ Pages 245–251</p>

Specification Information				
• Dimensions			• Style	• Base
D	W	H	Number	Price

Configuration P Conference Table Cabinets				
30"	36"	84"	HC3684PL	\$2582
30"	48"	84"	HC4884PL	\$2731
30"	72"	84"	HC7284PL	\$3035

Opus Wardrobe Cabinet with Sliding Door

Laminate

SIN 71.315

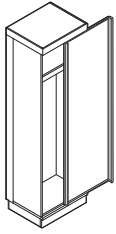

Tip: The melamine color matches the selected laminate color, so it does not need to be specified.

Tip: Wardrobe cabinets must be used adjacent to another cabinet. They cannot be used adjacent to desk cabinets or bedside table. They do not have the 1" space required for the wardrobe's sliding door.

*Must order lock plugs from Service Parts (4678420SR).

Standard Includes	Required to Specify
<ul style="list-style-type: none"> • Wardrobe cabinet and fixed shelf: melamine • Door front: melamine • Fixed shelf: melamine • Edge band on melamine door: 3 mm plastic • Base: black melamine only • Full-length, integral pulls: champagne paint only • Hanger bar: white paint only • Adjustable glides 	<ol style="list-style-type: none"> 1 Style number 2 Laminate color number for wardrobe cabinet 3 Edge band color number for melamine door 4 Options, if selected (see below) <p>▶ See <i>Surface Materials</i>, page 402.</p>

Options	Price	Required to Specify
Surface Materials <ul style="list-style-type: none"> • Laminate • Open Line laminate 	No cost +\$ 91	▶ See <i>Surface Materials</i> , page 402. ▶ See <i>Surface Materials Reference Manual</i> .
Door <ul style="list-style-type: none"> • Split-door package • Markerboard 	+\$215 +\$298	Specify with <i>split door markerboard top/melamine bottom</i> . Specify with <i>markerboard</i> .
Shelf Package <ul style="list-style-type: none"> • Shelves: melamine 	+\$215	Specify with <i>shelf package</i> .
Lock and Keying <p>Lock and location</p> <ul style="list-style-type: none"> • Polished Chrome lock located on left side of cabinet • Polished Chrome lock located on right side of cabinet <p>Keying</p> <ul style="list-style-type: none"> • Standard keying • Specific keying • Master keying 	+\$ 23 +\$ 23 No cost No cost +\$ 24	Specify with <i>lock located left</i> . Specify with <i>lock located right</i> . Specify with <i>standard keying</i> . Specify with <i>field installed locks</i> . Specify with <i>master keying</i> .
Related Products <ul style="list-style-type: none"> • Cabinets 		▶ Pages 232–238

Specification Information				
Dimensions			Style Number	Base Price
D	W	H		
20"	24"	84"	HC2484WSL	\$2160

sno

Opus Wardrobe Cabinets with Swing Door

Laminate
SIN 71.315

Tip: The melamine color matches the selected laminate color, so it does not need to be specified.

Standard Includes	Required to Specify
<ul style="list-style-type: none"> • Wardrobe cabinet and fixed shelf: melamine • Door front: melamine • Fixed shelf: melamine • Edge band on melamine door: 3 mm plastic • Base: black melamine only • Rail pulls on melamine door: champagne paint only • Hanger bar: white paint only • Adjustable glides 	<ol style="list-style-type: none"> 1 Style number 2 Laminate color number for wardrobe cabinet 3 Edge band color number for melamine door 4 Options, if selected (see below) <p>▶ See <i>Surface Materials</i>, page 402.</p>

Options	Price	Required to Specify
Surface Materials <ul style="list-style-type: none"> • Laminate • Open Line laminate 	No cost +\$ 91	▶ See <i>Surface Materials</i> , page 402. ▶ See <i>Surface Materials Reference Manual</i> .
Shelf Package <ul style="list-style-type: none"> • Shelves: melamine 	+\$215	Specify with shelf package.
Lock and Keying <p>Lock</p> <ul style="list-style-type: none"> • Polished Chrome <p>Keying</p> <ul style="list-style-type: none"> • Standard keying • Specific keying • Master keying 	No cost +\$ 23 No cost +\$ 24	Specify with lock Specify with standard keying. Specify with field installed locks.* Specify with master keying.
Related Products <ul style="list-style-type: none"> • Cabinets 		▶ Pages 232–238

*Must order lock plugs from Service Parts (4678420SR).

Specification Information					
• Dimensions			• Style	• Base	
D	W	H	Number	Price	

Left-Hand Door

20"	24"	84"	HC2484WHLL	\$2034

Right-Hand Door

20"	24"	84"	HC2484WHRL	\$2034

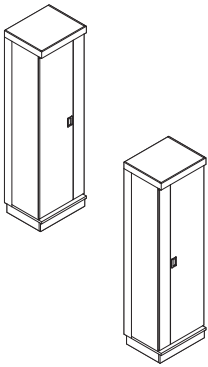

Opus Bedside Tables

Laminate

SIN 71.315

Tip: The melamine and plastic color matches the selected laminate color, so it does not need to be specified.

Standard Includes	Required to Specify
<ul style="list-style-type: none"> • Bedside table case: melamine • Table top and drawer front: laminate • Edge band on table top, drawer, and base: 3 mm plastic • Drawer body: white plastic and melamine only • Flush pull(s): champagne only • Rails: champagne paint only • Casters: black only 	<ol style="list-style-type: none"> 1 Style number 2 Laminate color number for bedside table 3 Edge band color number for table top, drawer, and base 4 Options, if selected (see below) <p>▶ See <i>Surface Materials</i>, page 402.</p>

Options	Price	Required to Specify
Surface Materials <ul style="list-style-type: none"> • Laminate • Open Line laminate 	No cost +\$91	▶ See <i>Surface Materials Reference Manual</i> . ▶ See <i>Surface Materials Reference Manual</i> .
Lock and Keying <ul style="list-style-type: none"> • Lock <ul style="list-style-type: none"> • Polished Chrome • Keying <ul style="list-style-type: none"> • Standard keying • Specific keying • Master keying 	+\$23 No cost No cost +\$24	Specify <i>with lock</i> . Specify <i>with standard keying</i> . Specify <i>with field installed locks</i> .* Specify <i>with master keying</i> .
Related Products <ul style="list-style-type: none"> • Cabinets 		▶ Pages 232–238

*Must order lock plugs from Service Parts (4678420SR).

Specification Information					
Dimensions			Style		Base
D	W	H	Number	Price	

Configuration A					
20 ³ / ₄ "	20 ¹ / ₂ "	42"	HT18MAL	\$1121	

Configuration B					
20 ³ / ₄ "	20 ¹ / ₂ "	42"	HT18MBL	\$ 906	

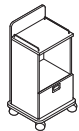
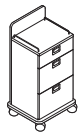

Opus Overhead Shelves

Laminate

SIN 71.315

Tip: When a cabinet has an overhead shelf installed on it and it is not ganged to another cabinet, a wall-anchor bracket must be used. Check local codes.

Tip: Overhead shelf is not recommended on cabinets with 18½"H storage unit. There is not sufficient clearance for a person to sit.

Standard Includes	Required to Specify
-------------------	---------------------

- Shelf: laminate
- Edge band on shelf: 3 mm plastic
- Cantilevers: champagne paint only

- 1 Style number
- 2 Laminate color number for shelf
- 3 Edge band color number for shelf
- 4 Options, if selected (see below)
- ▶ See *Surface Materials*, page 402.

Options	Price	Required to Specify
---------	-------	---------------------

Surface Materials

- Laminate No cost
- Open Line laminate +\$91

- ▶ See *Surface Materials Reference Manual*.
- ▶ See *Surface Materials Reference Manual*.

Related Products

- Cabinets
- Wall-anchor brackets

- ▶ Pages 232–238
- ▶ Page 250

Specification Information

• Dimensions			• Style	• Base
D	W	H	Number	Price
•	•	•	•	•
•	•	•	•	•

Straight Shelves

12"	24"	1"	HS24SL	\$224
12"	36"	1"	HS36SL	\$248
•	•	•	•	•

Flower Shelves

12"/15"	24"	1"	HS24FL	\$258
12"/15"	36"	1"	HS36FL	\$287
•	•	•	•	•

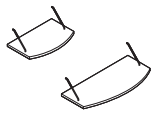
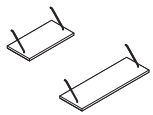

Tip: 36"W flower shelf is non-handed. Shelf can be reversed in the field.

Opus Overhead Shelves with Box Unit

Laminate

SIN 71.315

Tip: The melamine color matches the selected laminate color, so it does not need to be specified.

Tip: When a cabinet has an overhead shelf with box unit installed on it and it is not ganged to another cabinet, a wall-anchor bracket must be used. Check local codes.

Tip: Overhead shelf with box unit is not recommended on cabinets with 18½"H storage unit. There is not sufficient clearance for a person to sit.

Standard Includes	Required to Specify
-------------------	---------------------

- Shelf: laminate
- Box unit: melamine
- Edge band on shelf: 3 mm plastic
- Cantilevers: champagne paint only

- 1 Style number
 - 2 Laminate color number for shelf with box unit
 - 3 Edge band color number for shelf
 - 4 Options, if selected (see below)
- ▶ See *Surface Materials*, page 402.

Options	Price	Required to Specify
---------	-------	---------------------

Surface Materials

- Laminate: No cost
- Open Line laminate: +\$91

- ▶ See *Surface Materials Reference Manual*.
▶ See *Surface Materials Reference Manual*.

Related Products

- Cabinets
- Wall-anchor brackets

- ▶ Pages 232–238
▶ Page 250

Specification Information					
Dimensions			Style	Base	
D	W	H	Number	Price	

Straight Shelves with Box Unit

12"	24"	24"	HS2423SBL	\$491
12"	36"	24"	HS3623SBL	\$516
12"	24"	36"	HS2435SBL	\$549
12"	36"	36"	HS3635SBL	\$571

Flower Shelves with Box Unit

12"/15"	36"	24"	HS3623FBL	\$554
12"/15"	36"	36"	HS3635FBL	\$611

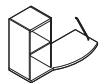

Tip: 36"W flower shelf with a box unit is non-handed. Shelf can be reversed in the field so that the box unit can be field installed in either the left- or right-hand location.

Opus

Opus Overhead Storage Cabinets with Doors

Laminate

SIN 71.315

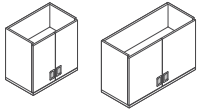

Tip: The melamine color matches the selected laminate color, so it does not need to be specified.

Tip: When a cabinet has an overhead storage cabinet on it and it is not ganged to another cabinet, a wall-anchor bracket must be used. Check local codes.

Tip: When all of the cabinets in a multi-unit configuration have overhead storage cabinets installed on them, a wall-anchor bracket must be used. Check local codes.

Tip: Overhead storage cabinet is not recommended on cabinets with 18½"H storage unit. There is not sufficient clearance for a person to sit.

*Must order lock plugs from Service Parts (4678420SR).

Standard Includes	Required to Specify
-------------------	---------------------

- Cabinet, door fronts, and adjustable shelf: melamine
- Cabinet bottom: laminate
- Edge band on cabinet bottom and doors: 3 mm plastic
- Flush pulls: champagne only
- Attachment hardware

- 1 Style number
 - 2 Laminate color number for storage cabinet
 - 3 Edge band color number for cabinet bottom and doors
 - 4 Options, if selected (see below)
- ▶ See *Surface Materials*, page 402.

Options	Price	Required to Specify
---------	-------	---------------------

Surface Materials	• Laminate	No cost	▶ See <i>Surface Materials Reference Manual</i> .
	• Open Line laminate	+\$91	▶ See <i>Surface Materials Reference Manual</i> .

Lock and Keying	Lock		
	• Polished Chrome	+\$23	Specify <i>with lock</i> .

Lock and Keying	Keying		
	• Standard keying	No cost	Specify <i>with standard keying</i> .
	• Specific keying	No cost	Specify <i>with field installed locks</i> .*
	• Master keying	+\$24	Specify <i>with master keying</i> .

Related Products	• Cabinets	▶ Pages 232–238
	• Wall-anchor brackets	▶ Page 250

Specification Information

• Dimensions			• Style	• Base
D	W	H	Number	Price
15"	24"	24"	HS2424BL	\$735
15"	36"	24"	HS3624BL	\$857

Opus Accessories

SIN 71.315

Common Tops

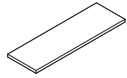

Standard Includes	Required to Specify
<ul style="list-style-type: none"> • Top: laminate • Edge band: plastic 	<ul style="list-style-type: none"> 1 Style number 2 Laminate color number for top 3 Edge band color number 4 Options, if selected (see below) ▶ See <i>Surface Materials</i>, page 402.

Options	Price	Required to Specify
Surface Materials <ul style="list-style-type: none"> • Laminate • Open Line laminate 	<ul style="list-style-type: none"> No cost +\$91 	<ul style="list-style-type: none"> ▶ See <i>Surface Materials Reference Manual</i>. ▶ See <i>Surface Materials Reference Manual</i>.

Specification Information			
Dimensions		Style Number	Base Price
D	W		
15"	48"	HW1548L	\$161
15"	60"	HW1560L	\$199
15"	72"	HW1572L	\$259
15"	84"	HW1584L	\$376
:	:	:	:



Opus Accessories, continued

SIN 71.315

Inside Corner Filler Panels

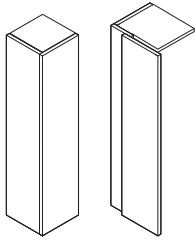

Tip: Inside corner fillers cannot be used next to a conference table.

Standard Includes	Required to Specify
-------------------	---------------------

- Inside corner filler panel: melamine
- Edge band: plastic

- 1 Style number
 - 2 Melamine color number for inside corner filler panel
 - 3 Edge band color number
 - 4 Options, if selected (see below)
- ▶ See *Surface Materials*, page 402.

Surface Materials	Options	Price	Required to Specify
-------------------	---------	-------	---------------------

- Laminate
 - Open Line laminate
- No cost
+\$91

- ▶ See *Surface Materials*, page 402.
▶ See *Surface Materials Reference Manual*.

Specification Information				
• Dimensions			• Style	• Base
D	W	H	Number	Price

Inside Corner Filler

20 1/8"	7"	84"	HB84XL	\$644

Adjustable Corner Filler

20 1/8"-26"	7"	84"	HB84XAL	\$740

Wall Trim Packages



Standard Includes	Required to Specify
-------------------	---------------------

- Wall trim package of two: plastic

- 1 Style number
 - 2 Plastic color number for wall trim
- ▶ See *Surface Materials*, page 402.

Specification Information			
• Dimensions		• Style	• Price
W	H	Number	

1 5/16"	84"	HBT284	\$ 99
1 5/16"	120"	HBT2120	\$145

Ceiling Tracks

Standard Includes	Required to Specify
-------------------	---------------------

- Recessed ceiling track: 7241 Arctic White paint only

- 1 Style number
- 2 Options, if selected (see below)
- ▶ See *Surface Materials*, page 402.

Tip: No ceiling clip is included unless selected as an option.

Options	Price	Required to Specify
---------	-------	---------------------

Ceiling Clip

Clips for use on ceiling tracks

- | | |
|-------------------------------|---------|
| • No fastener | No cost |
| • 1" x 1/4"D tegular | No cost |
| • 1" x 3/8"D tegular | No cost |
| • 1" x 1/2"D tegular | No cost |
| • 1" x 5/8"D tegular | No cost |
| • Donn Finline 1/4" slot | No cost |
| • Donn Finline 1/8" slot | No cost |
| • 1"W exposed T | No cost |
| • 1" fluted runner 1/4" – 20" | No cost |
| • 1" tee quick clip | No cost |
| • 9/16"W exposed tee | No cost |
| • 9/16" x 1/4"D tegular | No cost |
| • 9/16" x 5/16"D tegular | No cost |

- Specify with *no fastener*.
- Specify with *1" x 1/4"D tegular clip*.
- Specify with *1" x 3/8"D tegular clip*.
- Specify with *1" x 1/2"D tegular clip*.
- Specify with *1" x 5/8"D tegular clip*.
- Specify with *Donn Finline with 1/4" slot clip*.
- Specify with *Donn Finline with 1/8" slot clip*.
- Specify with *1"W exposed T clip*.
- Specify with *1" fluted runner 1/4" – 20" clip*.
- Specify with *1" tee quick clip*.
- Specify with *9/16"W exposed tee clip*.
- Specify with *9/16" x 1/4"D tegular clip*.
- Specify with *9/16" x 5/16"D tegular clip*.

Specification Information		
Width	Style Number	Price

•	•	•
:	:	:
:	:	:

Straight Ceiling Track

120"	HPCTS	\$173
:	:	:

Corner L Ceiling Track

20"	HPCTLS20	\$173
:	:	:

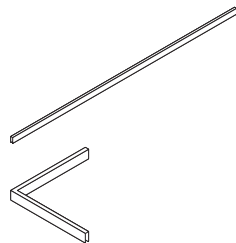

sno

SIN 71.315

Mounting Boards



Standard Includes	Required to Specify
<ul style="list-style-type: none"> • Mounting board: melamine • Edge band on mounting board: 3 mm plastic • Attachment hardware 	<ol style="list-style-type: none"> 1 Style number 2 Melamine color number for mounting board 3 Edge band color number for mounting board 4 Options, if selected (see below) <p>▶ See <i>Surface Materials</i>, page 402.</p>

Options	Price	Required to Specify
Surface Materials <ul style="list-style-type: none"> • Laminate • Open Line laminate 	No cost +\$23	<p>▶ See <i>Surface Materials</i>, page 402.</p> <p>▶ See <i>Surface Materials Reference Manual</i>.</p>

Specification Information			
• Dimensions		• Style	• Base
W	H	Number	Price
22"	32"	HAB2232	\$110
34"	32"	HAB3432	\$126
•	•	•	•

Cushions



Tip: Cushions are for use with 18½"H storage unit.

Standard Includes		Required to Specify	
<ul style="list-style-type: none"> Cushion, upholstery: price group 1 		1 Style number 2 Fabric color number for cushion upholstery 3 Options, if selected (see below) ▶ See <i>Surface Materials</i> , page 402.	
Surface Materials	Options	Price	Required to Specify
	<ul style="list-style-type: none"> Fabric price group 1 Fabric price group 2 Fabric price group 3 Fabric price group 4 Fabric price group 5 Fabric price group 6 Fabric price group 7 Fabric price group 8 Fabric price group 9 Fabric price group 10 Fabric price group COM 	No cost +\$ 26 +\$ 48 +\$ 68 +\$ 85 +\$121 +\$171 +\$226 +\$268 +\$312 No cost	Specify fabric color number. Specify fabric color number. Specify fabric color number. Specify fabric color number. Specify fabric color number. Specify fabric color number. Specify fabric color number. Specify fabric color number. Specify fabric color number. Specify fabric color number. Specify fabric color number. ▶ See <i>Surface Materials Reference Manual</i> to specify.
Related Products	<ul style="list-style-type: none"> Cabinets with 18½"H Storage Unit 		▶ Page 236

Specification Information			
Dimensions		Style Number	Base Price
D	W		
15"	24"	HAC24	\$235
15"	36"	HAC36	\$259

Coat Hooks



Tip: Coat hooks are intended for cabinets with 18½"H storage units.

Standard Includes		Required to Specify	
<ul style="list-style-type: none"> Coat hooks: champagne paint only Package of two 		Style number	
Related Products			
<ul style="list-style-type: none"> Cabinets with 18½"H Storage Unit 		▶ Page 236	

Specification Information	
Style Number	Price
HAH	\$68

Opus Accessories, continued

SIN 71.315

Wall-Anchor Brackets

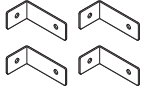

*Tip: Wall-anchor brackets should be used when a single cabinet has an overhead storage cabinet or shelf installed in it. Wall-anchor brackets are also necessary when all of the cabinets in a multi-unit configuration have overhead storage cabinets installed on them. Check local codes.
▶ See Application Topics.*

Standard Includes	Required to Specify
<ul style="list-style-type: none"> • Wall-anchor brackets • Package of four 	Style number

Specification Information

•Style Number	•Price
HAW4	\$60
•	•

Floor-Anchor Brackets

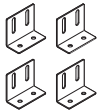

Standard Includes	Required to Specify
<ul style="list-style-type: none"> • Floor-anchor brackets • Package of four 	Style number

Specification Information

•Style Number	•Price
HAF4	\$86
•	•

OSHPD Brackets

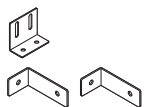

Standard Includes	Required to Specify
<ul style="list-style-type: none"> • One floor bracket • Two wall brackets • Attachment hardware 	Style number

Specification Information

Style Number	Price
HAFW	\$59

Transformer

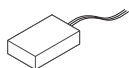

Standard Includes	Required to Specify
<ul style="list-style-type: none"> • Transformer 	Style number

Specification Information

Style Number	Price

UL Transformer

HTRANSU	\$235



Sonata

► For more detailed product information, see the Steelcase Health Seating and Caseloads Specification Guides or consult your Steelcase dealer.



Statement of Line **254**



Specifying

Modules

Nurse Servers (SIN 711.3)	256
Islands (SIN 711.3)	262
Bench (SIN 711.3)	268
Media Units (SIN 711.3)	269
Wardrobes (SIN 711.3)	270

Bases (SIN 711.3)	271
--------------------------	------------

Accessories

Coat Hooks (SIN 711.3)	272
Flat Screen Monitor Arm (SIN 711.3)	272

Statement of Line

Sonata

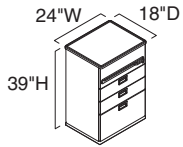

Single-Sided
Left-Hand with
Drawer Storage

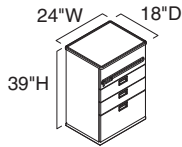

Single-Sided
Right-Hand with
Drawer Storage

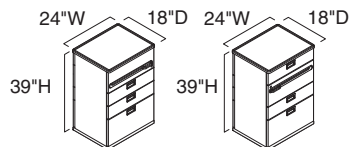

Double-Sided with
Drawer Storage

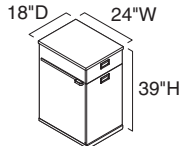

Single-Sided
Left-Hand with
Waste Bin Storage

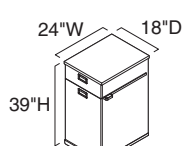

Single-Sided
Right-Hand with
Waste Bin Storage

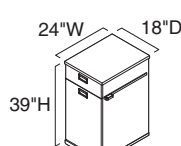

Double-Sided with
Waste Bin Storage

Specifying
▶ Pages 256–261

Nurse Servers

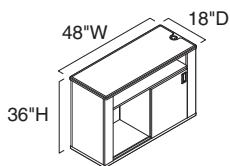

Single-Sided
Left-Hand with
Sliding Door

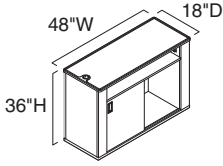

Single-Sided
Right-Hand with
Sliding Door

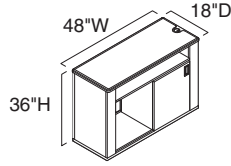

Double-Sided with
Sliding Door

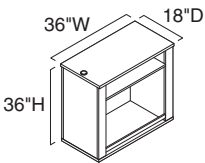

Single-Sided
Left-Hand with Open
Storage

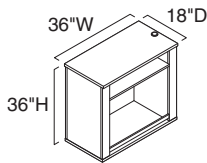

Single-Sided
Right-Hand with
Open Storage

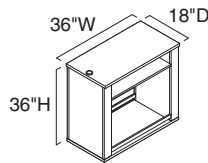

Double-Sided
with Open Storage

Specifying
▶ Pages 262–268

Islands

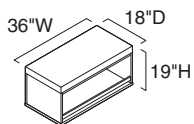

Single-Sided with Open Storage

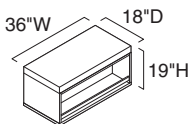

Double-Sided Open Storage

Specifying
▶ Page 268

Benches

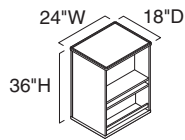

Specifying
▶ Page 269

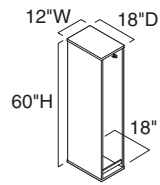

Single-Sided

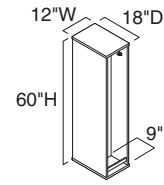

Double-Sided

Specifying
▶ Page 270

Media Units

Wardrobes

*Media units are available in double-sided models.

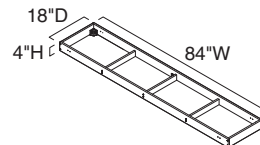
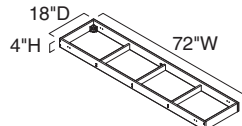
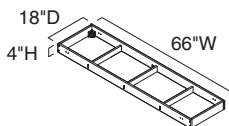
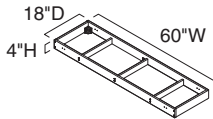
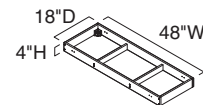
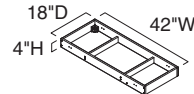
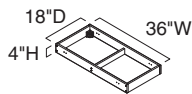
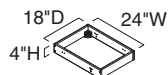
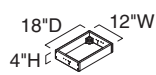

Specifying
▶ Page 271

Bases



Specifying
▶ Page 272

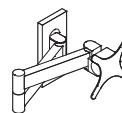

Specifying
▶ Page 272

Coat Hooks

Flat Screen Monitor Arm

Sonata Nurse Servers with Drawer Storage

Laminate

SIN 711.3

Standard Includes	Required to Specify
<ul style="list-style-type: none"> Nurse server: laminate Rigid thermoform pull-out worksurface: sand only Top: laminate Edge band: 3 mm plastic Flush pull: Champagne only 	<ol style="list-style-type: none"> Style number Laminate color number for nurse server cabinet Edge band color number for nurse server cabinet Laminate color number for top Edge band color number for top Options, if selected (see below) <p>▶ See <i>Surface Materials</i>, page 402.</p>

Options	Price	Required to Specify
Lock and Keying <ul style="list-style-type: none"> Lock Polished Chrome for single-sided Polished Chrome for double-sided 	<ul style="list-style-type: none"> +\$ 55 +\$110 	<ul style="list-style-type: none"> Specify <i>with lock</i>. Specify <i>with lock</i>.
<ul style="list-style-type: none"> Keying Standard key random Specific keying Master keying for single-sided Master keying for double-sided 	<ul style="list-style-type: none"> No cost No cost +\$ 24 +\$ 48 	<ul style="list-style-type: none"> Specify <i>with standard keying</i>. Specify <i>with field installed locks</i>.* Specify <i>with master keying</i>. Specify <i>with master keying</i>.

*Must order lock plugs from Service Parts (4678420SR).

Specification Information

Dimensions	Style Number	Base Price
D W H	Number	Price

Single-Sided Nurse Server

Left-Hand					
18"	24"	39"	HM1NA2439LL	\$2082	

Right-Hand					
18"	24"	39"	HM1NA2439RL	\$2082	

Double-Sided Nurse Server

18"	24"	39"	HM2NA2439L	\$2660	
-----	-----	-----	-------------------	--------	--

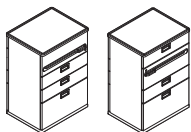

Sonata Nurse Servers with Waste Bin Storage

Laminate
SIN 711.3

Sonata
Nurse Servers with
Waste Bin Storage

Standard Includes	Required to Specify
<ul style="list-style-type: none"> Nurse server: laminate Rigid thermoform pull-out worksurface: sand only Top: laminate Edge band: 3 mm plastic Flush pull and toe pull: Champagne only 	<ol style="list-style-type: none"> Style number Laminate color number for nurse server cabinet Edge band color number for nurse server cabinet Laminate color number for top Edge band color number for top Options, if selected (see below) <p>▶ See <i>Surface Materials</i>, page 402.</p>

Options	Price	Required to Specify
Lock and Keying <ul style="list-style-type: none"> Lock <ul style="list-style-type: none"> Polished Chrome for single-sided Keying <ul style="list-style-type: none"> Standard key random Specific keying Master keying for single-sided 	+\$55 No cost No cost +\$24	Specify <i>with lock</i> . Specify <i>with standard keying</i> . Specify <i>with field installed locks</i> . Specify <i>with master keying</i> .

*Must order lock plugs from Service Parts (4678420SR).

Specification Information					
Dimensions			Style	Base	
D	W	H	Number	Price	
:	:	:	:	:	:

Single-Sided Nurse Server

Left-Hand

18"	24"	39"	HM1NC2439LL	\$2528
-----	-----	-----	--------------------	--------

Right-Hand

18"	24"	39"	HM1NC2439RL	\$2528
-----	-----	-----	--------------------	--------

Double-Sided Nurse Server

18"	24"	39"	HM2NC2439L	\$2660
-----	-----	-----	-------------------	--------

Nurse Server without Pullouts

18"	24"	39"	HMND2439L	\$2393
-----	-----	-----	------------------	--------

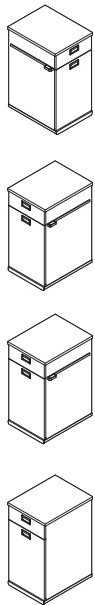

Sonata

Sonata Nurse Servers with Drawer Storage

Rigid Thermoform

SIN 711.3

Tip: Rigid thermoform top is standard with a spill edge.

Standard Includes	Required to Specify
<ul style="list-style-type: none"> Nurse server: laminate Rigid thermoform pull-out worksurface: sand only Rigid thermoform top: sand only Edge band: 3 mm plastic Flush pull: Champagne only 	<ol style="list-style-type: none"> Style number Laminate color number for nurse server Edge band color number Options, if selected (see below) <p>▶ See <i>Surface Materials</i>, page 402.</p>

Options	Price	Required to Specify
Lock and Keying		
<ul style="list-style-type: none"> Lock Polished Chrome for single-sided Polished Chrome for double-sided 	<ul style="list-style-type: none"> +\$ 55 +\$110 	<ul style="list-style-type: none"> Specify <i>with lock</i>. Specify <i>with lock</i>.
<ul style="list-style-type: none"> Keying Standard key random Specific keying Master keying for single-sided Master keying for double-sided 	<ul style="list-style-type: none"> No cost No cost +\$ 24 +\$ 48 	<ul style="list-style-type: none"> Specify <i>with standard keying</i>. Specify <i>with field installed locks</i>.* Specify <i>with master keying</i>. Specify <i>with master keying</i>.

*Must order lock plugs from Service Parts (4678420SR).

Specification Information

Dimensions	Style Number	Base Price
D W H	Number	Price

Single-Sided Nurse Server

Left-Hand

18"	24"	39"	HM1NA2439LR	\$2166
-----	-----	-----	--------------------	--------

Right-Hand

18"	24"	39"	HM1NA2439RR	\$2166
-----	-----	-----	--------------------	--------

Double-Sided Nurse Server

18"	24"	39"	HM2NA2439R	\$2766
-----	-----	-----	-------------------	--------

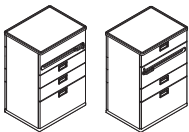

Sonata Nurse Servers with Waste Bin Storage

Rigid Thermoform

SIN 711.3

Tip: Rigid thermoform top is standard with a spill edge.

Standard Includes	Required to Specify
<ul style="list-style-type: none"> Nurse server: laminate Rigid thermoform pull-out worksurface: sand only Rigid thermoform top: sand only Edge band: 3 mm plastic Flush pull and toe pull: Champagne only 	<ul style="list-style-type: none"> 1 Style number 2 Laminate color number for nurse server 3 Edge band color number 4 Options, if selected (see below) ▶ See <i>Surface Materials</i>, page 402.

Options	Price	Required to Specify
Junction Box Cutout <ul style="list-style-type: none"> Junction box cutout 	+\$96	Specify with <i>junction box cutout</i> .
Lock and Keying <ul style="list-style-type: none"> Lock <ul style="list-style-type: none"> Polished Chrome for single-sided Keying <ul style="list-style-type: none"> Standard key random Specific keying Master keying for single-sided 	<ul style="list-style-type: none"> No cost No cost +\$24 	<ul style="list-style-type: none"> Specify with <i>lock</i>. Specify with <i>standard keying</i>. Specify with <i>field installed locks</i>.* Specify with <i>master keying</i>.

*Must order lock plugs from Service Parts (4678420SR).

Specification Information					
Dimensions			Style	Base	
D	W	H	Number	Price	

Single-Sided Nurse Server

Left-Hand

18"	24"	39"	HM1NC2439LR	\$2629
-----	-----	-----	--------------------	--------

Right-Hand

18"	24"	39"	HM1NC2439RR	\$2629
-----	-----	-----	--------------------	--------

Double-Sided Nurse Server

18"	24"	39"	HM2NC2439R	\$2766
-----	-----	-----	-------------------	--------

Nurse Server without Pullouts

18"	24"	39"	HMND2439R	\$2491
-----	-----	-----	------------------	--------

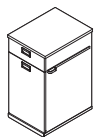

Sonata Nurse Servers with Drawer Storage

Solid Surface

SIN 711.3

Standard Includes	Required to Specify
<ul style="list-style-type: none"> Nurse server: laminate Rigid thermoform pull-out worksurface: sand only Top: solid surface Edge band: 3 mm plastic Flush pull: Champagne only 	<ol style="list-style-type: none"> Style number Laminate color number for nurse server Solid surface color number for top Edge band color number Options, if selected (see below) <p>▶ See <i>Surface Materials</i>, page 402.</p>

Tip: For finish codes and more information on the solid surface Graded-In program, see *Surface Materials*.
▶ Page 402

Options	Price	Required to Specify
Surface Materials		
Solid Surface		
• Solid surface price group A	No cost	Specify solid surface color number or finish code.
• Solid surface price group B	+\$ 97	Specify solid surface color number or finish code.
• Solid surface price group C	+\$ 97	Specify solid surface color number or finish code.
• Solid surface price group D	+\$110	Specify solid surface color number or finish code.
• Solid surface price group E	+\$120	Specify solid surface color number or finish code.
Lock and Keying		
Lock		
• Polished Chrome for single-sided	+\$ 55	Specify <i>with lock</i> .
• Polished Chrome for double-sided	+\$110	Specify <i>with lock</i> .
Keying		
• Standard key random	No cost	Specify <i>with standard keying</i> .
• Specific keying	No cost	Specify <i>with field installed locks</i> .*
• Master keying for single-sided	+\$ 24	Specify <i>with master keying</i> .
• Master keying for double-sided	+\$ 48	Specify <i>with master keying</i> .

*Must order lock plugs from Service Parts (4678420SR).

Specification Information

Dimensions	Style	Base
D W H	Number	Price

Single-Sided Nurse Server

Left-Hand

18"	24"	39"	HM1NA2439LS	\$2591
-----	-----	-----	--------------------	--------

Right-Hand

18"	24"	39"	HM1NA2439RS	\$2591
-----	-----	-----	--------------------	--------

Double-Sided Nurse Server

18"	24"	39"	HM2NA2439S	\$3237
-----	-----	-----	-------------------	--------



Sonata Nurse Servers with Waste Bin Storage

Solid Surface

SIN 711.3

Standard Includes	Required to Specify
<ul style="list-style-type: none"> Nurse server: laminate Rigid thermoform pull-out worksurface: sand only Top: solid surface Edge band: 3 mm plastic Flush pull and toe pull: Champagne only 	<ol style="list-style-type: none"> Style number Laminate color number for nurse server Solid surface color number for top Edge band color number Options, if selected (see below) <p>▶ See <i>Surface Materials</i>, page 402.</p>

Options	Price	Required to Specify
Surface Materials Solid Surface <ul style="list-style-type: none"> Solid surface price group A Solid surface price group B Solid surface price group C Solid surface price group D Solid surface price group E 	No cost +\$ 97 +\$ 97 +\$110 +\$120	Specify solid surface color number or finish code. Specify solid surface color number or finish code. Specify solid surface color number or finish code. Specify solid surface finish code. Specify solid surface finish code.
Junction Box Cutout <ul style="list-style-type: none"> Junction box cutout 	+\$192	Specify <i>with junction box cutout</i> .
Lock and Keying Lock <ul style="list-style-type: none"> Polished Chrome for single-sided Keying <ul style="list-style-type: none"> Standard key random Specific keying Master keying for single-sided 	+\$ 55 No cost No cost +\$ 24	Specify <i>with lock</i> . Specify <i>with standard keying</i> . Specify <i>with field installed locks</i> . Specify <i>with master keying</i> .

Tip: For finish codes and more information on the solid surface Graded-In program, see Surface Materials.
▶ Page 402

**Must order lock plugs from Service Parts (4678420SR).*

Specification Information					
Dimensions			Style	Base	
D	W	H	Number	Price	

Single-Sided Nurse Server

Left-Hand

18"	24"	39"	HM1NC2439LS	\$3075
-----	-----	-----	--------------------	--------

Right-Hand

18"	24"	39"	HM1NC2439RS	\$3075
-----	-----	-----	--------------------	--------

Double-Sided Nurse Server

18"	24"	39"	HM2NC2439S	\$3237
-----	-----	-----	-------------------	--------

Nurse Server without Pullouts

18"	24"	39"	HMND2439S	\$2914
-----	-----	-----	------------------	--------

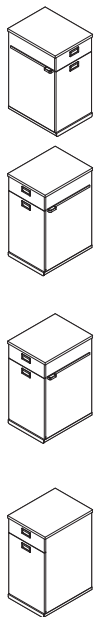

Sonata Islands with Sliding Door

Laminate
SIN 711.3

Standard Includes	Required to Specify
<ul style="list-style-type: none"> Island: laminate Island divider: laminate Top: laminate Edge band: 3 mm plastic Flush pull: Champagne only Grommet: black only Waste bin slide-out 	<ol style="list-style-type: none"> Style number Laminate color number for island, cabinet and divider Edge band color number for island cabinet Laminate color number for top Edge band color number for top Options, if selected (see below) <p>▶ See <i>Surface Materials</i>, page 402.</p>

Options	Price	Required to Specify
Island Divider <ul style="list-style-type: none"> Laminate Fusion price group 1 Fusion price group 2 Fusion price group 3 Fusion price group 4 	No cost +\$419 +\$459 +\$499 +\$540	Specify <i>with island divider</i> . Specify <i>with island divider</i> and select fusion color number or finish code. Specify <i>with island divider</i> and select fusion finish code. Specify <i>with island divider</i> and select fusion color number or finish code. Specify <i>with island divider</i> and select fusion color number or finish code. ▶ See <i>Surface Materials</i> , page 402.

Tip: Fusion island divider available on double-sided island only.

Tip: For finish codes and more information on the acrylic panel Graded-In program, see *Surface Materials*.
▶ Page 402

Specification Information

Dimensions	Style	Base
D W H	Number	Price

Single-Sided, Sliding Door Island

Left-Hand

18"	48"	36"	HM1LA4836LL	\$2601
-----	-----	-----	--------------------	--------

Right-Hand

18"	48"	36"	HM1LA4836RL	\$2601
-----	-----	-----	--------------------	--------

Double-Sided, Sliding Door Island

18"	48"	36"	HM2LA4836L	\$2732
-----	-----	-----	-------------------	--------

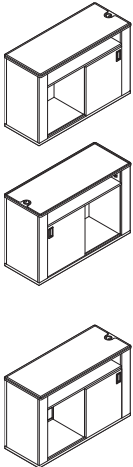

Sonata Islands with Open Storage

Laminate
SIN 711.3

Sonata
Islands with
Open Storage

Standard Includes	Required to Specify
<ul style="list-style-type: none"> Island: laminate Island divider: laminate Top: laminate Edge band: 3 mm plastic Rails: champagne only Grommet: black only 	<ol style="list-style-type: none"> Style number Laminate color number for island, cabinet and divider Edge band color number for island cabinet Laminate color number for top Edge band color number for top Options, if selected (see below) <p>▶ See <i>Surface Materials</i>, page 402.</p>

Options	Price	Required to Specify
Island Divider <ul style="list-style-type: none"> Laminate Fusion price group 1 Fusion price group 2 Fusion price group 3 Fusion price group 4 	No cost +\$343 +\$383 +\$425 +\$465	Specify <i>with island divider</i> . Specify <i>with island divider</i> and select fusion color number or finish code. Specify <i>with island divider</i> and select fusion finish code. Specify <i>with island divider</i> and select fusion color number or finish code. Specify <i>with island divider</i> and select fusion color number or finish code. ▶ See <i>Surface Materials</i> , page 402.

Tip: Fusion island divider available on double-sided island only.

Tip: For finish codes and more information on the acrylic panel Graded-In program, see *Surface Materials*.
▶ Page 402

Specification Information

Dimensions			Style	Base
D	W	H	Number	Price

Single-Sided Island

Left-Hand

18"	36"	36"	HM1LB3636LL	\$1948
-----	-----	-----	--------------------	--------

Right-Hand

18"	36"	36"	HM1LB3636RL	\$1948
-----	-----	-----	--------------------	--------

Double-Sided Island

18"	36"	36"	HM2LB3636L	\$2050
-----	-----	-----	-------------------	--------

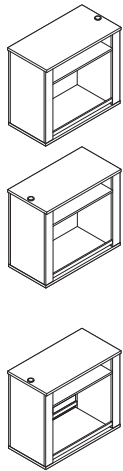

Sonata

Sonata Islands with Sliding Door

Rigid Thermoform

SIN 711.3

Tip: Rigid thermoform top is standard with a spill edge.

Tip: Fusion island divider available on double-sided island only.

Tip: For finish codes and more information on the acrylic panel Graded-In program, see Surface Materials.

▶ Page 402

Standard Includes	Required to Specify
<ul style="list-style-type: none"> Island: laminate Island divider: laminate Rigid thermoform top: sand only Edge band: 3 mm plastic Flush pull: Champagne only Grommet: black only Waste bin slide-out 	<ol style="list-style-type: none"> Style number Laminate color number for island, and divider Edge band color number Options, if selected (see below) <p>▶ See <i>Surface Materials</i>, page 402.</p>

Options	Price	Required to Specify
Island <ul style="list-style-type: none"> Laminate 	No cost	Specify <i>with island divider</i> .
Divider <ul style="list-style-type: none"> Fusion price group 1 Fusion price group 2 Fusion price group 3 Fusion price group 4 	+\$419 +\$459 +\$499 +\$540	Specify <i>with island divider</i> and select fusion color number or finish code. Specify <i>with island divider</i> and select fusion finish code. Specify <i>with island divider</i> and select fusion color number finish code. Specify <i>with island divider</i> and select fusion color number or finish code. ▶ See <i>Surface Materials</i> , page 402.

Specification Information

Dimensions	Style	Base
D W H	Number	Price

Single-Sided, Sliding Door Island

Left-Hand

18"	48"	36"	HM1LA4836LR	\$2707
-----	-----	-----	--------------------	--------

Right-Hand

18"	48"	36"	HM1LA4836RR	\$2707
-----	-----	-----	--------------------	--------

Double-Sided, Sliding Door Island

18"	48"	36"	HM2LA4836R	\$2841
-----	-----	-----	-------------------	--------

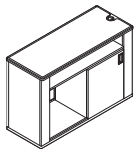
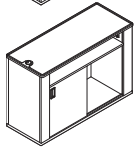
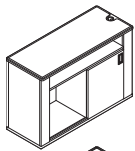

Sonata Islands with Open Storage

Rigid Thermoform

SIN 711.3

Tip: Rigid thermoform top is standard with a spill edge.

Tip: Fusion island divider available on double-sided island only.

Tip: For finish codes and more information on the acrylic panel Graded-In program, see Surface Materials.

▶ Page 402

Standard Includes	Required to Specify
<ul style="list-style-type: none"> Island: laminate Island divider: laminate Rigid thermoform top: sand only Edge band: 3 mm plastic Rails: Champagne only Grommet: black only 	<ol style="list-style-type: none"> Style number Laminate color number for island, and divider Edge band color number Options, if selected (see below) <p>▶ See <i>Surface Materials</i>, page 402.</p>

Options	Price	Required to Specify
Island Divider <ul style="list-style-type: none"> Laminate Fusion price group 1 Fusion price group 2 Fusion price group 3 Fusion price group 4 	No cost +\$343 +\$383 +\$425 +\$465	Specify with <i>island divider</i> . Specify with <i>island divider</i> and select fusion color number or finish code. Specify with <i>island divider</i> and select fusion finish code. Specify with <i>island divider</i> and select fusion color number finish code. Specify with <i>island divider</i> and select fusion color number or finish code. ▶ See <i>Surface Materials</i> , page 402.

Specification Information

Dimensions	Style	Base
D W H	Number	Price

Single-Sided Island

Left-Hand

18"	36"	36"	HM1LB3636LR	\$2022
-----	-----	-----	--------------------	--------

Right-Hand

18"	36"	36"	HM1LB3636RR	\$2022
-----	-----	-----	--------------------	--------

Double-Sided Island

18"	36"	36"	HM2LB3636R	\$2131
-----	-----	-----	-------------------	--------

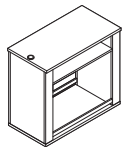
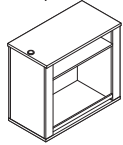
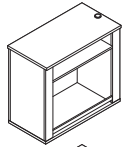

Sonata

Sonata Islands with Sliding Door

Solid Surface

SIN 711.3

Standard Includes	Required to Specify
<ul style="list-style-type: none"> Island: laminate Island divider: laminate Top: solid surface Edge band: 3 mm plastic Flush pull: Champagne only Grommet: black only Waste bin slide-out 	<ol style="list-style-type: none"> Style number Laminate color number for island, and divider Solid surface color number for top Edge band color number Options, if selected (see below) <p>▶ See <i>Surface Materials</i>, page 402.</p>

Tip: For finish codes and more information on the solid surface Graded-In program, see Surface Materials.
▶ Page 402

Surface Materials	Options	Price	Required to Specify
Surface Materials	Solid Surface		
	• Solid surface price group A	No cost	Specify solid surface color number or finish code.
	• Solid surface price group B	+\$182	Specify solid surface color number or finish code.
	• Solid surface price group C	+\$182	Specify solid surface color number or finish code.
	• Solid surface price group D	+\$218	Specify solid surface color number or finish code.
• Solid surface price group E	+\$248	Specify solid surface color number or finish code.	
Island Divider	• Laminate	No cost	Specify <i>with island divider</i> .
	• Fusion price group 1	+\$419	Specify <i>with island divider</i> and select fusion color number or finish code.
	• Fusion price group 2	+\$459	Specify <i>with island divider</i> and select fusion finish code.
	• Fusion price group 3	+\$499	Specify <i>with island divider</i> and select fusion color number or finish code.
	• Fusion price group 4	+\$540	Specify <i>with island divider</i> and select fusion color number or finish code. ▶ See <i>Surface Materials</i> , page 402.

Tip: Fusion island divider available on double-sided island only.

Specification Information

Dimensions	Style	Base
D W H	Number	Price

Single-Sided, Sliding Door Island

Left-Hand

18"	48"	36"	HM1LA4836LS	\$3670
-----	-----	-----	--------------------	--------

Right-Hand

18"	48"	36"	HM1LA4836RS	\$3670
-----	-----	-----	--------------------	--------

Double-Sided, Sliding Door Island

18"	48"	36"	HM2LA4836S	\$3857
-----	-----	-----	-------------------	--------

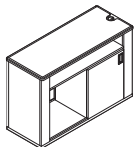
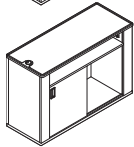
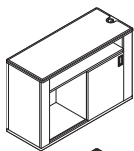

Sonata Islands with Open Storage

Solid Surface

SIN 711.3

Sonata Islands with Open Storage

Standard Includes	Required to Specify
<ul style="list-style-type: none"> Island: laminate Island divider: laminate Top: solid surface Edge band: 3 mm plastic Rails: Champagne only Grommet: black only 	<ol style="list-style-type: none"> Style number Laminate color number for island, and divider Solid surface color number for top Edge band color number Options, if selected (see below) <p>▶ See <i>Surface Materials</i>, page 402.</p>

Tip: For finish codes and more information on the solid surface Graded-In program, see *Surface Materials*.
▶ Page 402

Options	Price	Required to Specify
Surface Materials	Solid Surface	
• Solid surface price group A	No cost	Specify solid surface color number or finish code.
• Solid surface price group B	+\$138	Specify solid surface color number or finish code.
• Solid surface price group C	+\$138	Specify solid surface color number or finish code.
• Solid surface price group D	+\$167	Specify solid surface color number or finish code.
• Solid surface price group E	+\$191	Specify solid surface color number or finish code.
Island Divider		
• Laminate	No cost	Specify <i>with island divider</i> .
• Fusion price group 1	+\$343	Specify <i>with island divider</i> and select fusion color number or finish code.
• Fusion price group 2	+\$383	Specify <i>with island divider</i> and select fusion finish code.
• Fusion price group 3	+\$425	Specify <i>with island divider</i> and select fusion color number or finish code.
• Fusion price group 4	+\$465	Specify <i>with island divider</i> and select fusion color number or finish code.

▶ See *Surface Materials*, page 402.

Tip: Fusion island divider available on double-sided island only.

Specification Information

Dimensions	Style	Base
D W H	Number	Price

Single-Sided Island

Left-Hand					
18"	36"	36"	HM1LB3636LS	\$2748	

Right-Hand					
18"	36"	36"	HM1LB3636RS	\$2748	

Double-Sided Island

18"	36"	36"	HM2LB3636S	\$2892	
-----	-----	-----	-------------------	--------	--

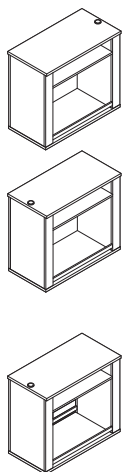

Sonata

Sonata Bench

SIN 711.3

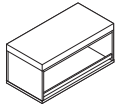

Tip: For finish codes and more information on the solid surface Graded-In program, see *Surface Materials*.
▶ Page 402

Standard Includes	Required to Specify
<ul style="list-style-type: none"> Bench: laminate Edge band: 3 mm plastic Top: upholstered cushion, if selected Top: solid surface, if selected 	<ol style="list-style-type: none"> Style number Laminate color number for bench Edge band color number Fabric color number for cushion, if selected Solid surface color number, if selected Options, if selected (see below) <p>▶ See <i>Surface Materials</i>, page 402.</p>

Surface Materials	Options	Price	Required to Specify
	Solid Surface		
	• Solid surface price group A	No cost	Specify solid surface color number or finish code.
	• Solid surface price group B	+\$161	Specify solid surface color number or finish code.
	• Solid surface price group C	+\$161	Specify solid surface color number or finish code.
	• Solid surface price group D	+\$201	Specify solid surface color number or finish code.
	• Solid surface price group E	+\$223	Specify solid surface color number or finish code.
	Upholstery		
	• Fabric price group 1	No cost	Specify fabric color number.
	• Fabric price group 2	+\$ 31	Specify fabric color number.
	• Fabric price group 3	+\$ 59	Specify fabric color number.
	• Fabric price group 4	+\$ 83	Specify fabric color number.
	• Fabric price group 5	+\$108	Specify fabric color number.
	• Fabric price group 6	+\$123	Specify fabric color number.
	• Fabric price group 7	+\$149	Specify fabric color number.
	• Fabric price group 8	+\$182	Specify fabric color number.
	• Fabric price group 9	+\$230	Specify fabric color number.
	• Fabric price group 10	+\$260	Specify fabric color number.
	• Fabric price group COM	No cost	▶ See <i>Surface Materials Reference Manual</i> to specify.

Specification Information

• Dimensions			• Style	• Base
D	W	H	Number	Price

Cushion Top Bench with Open Storage

Single-Sided

18"	36"	19"	HM1BB3619	\$1030
-----	-----	-----	------------------	--------

Double-Sided

18"	36"	19"	HM2BB3619	\$1055
-----	-----	-----	------------------	--------

Solid Surface Top Bench with Open Storage

Single-Sided

18"	36"	19"	HM1BC3619	\$1715
-----	-----	-----	------------------	--------

Double-Sided

18"	36"	19"	HM2BC3619	\$1806
-----	-----	-----	------------------	--------

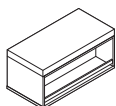
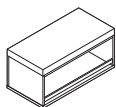
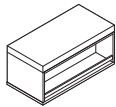
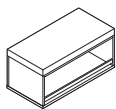

Sonata Media Units

SIN 711.3

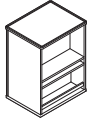

Tip: For finish codes and more information on the solid surface Graded-In program, see Surface Materials.
▶ Page 402

Standard Includes	Required to Specify
<ul style="list-style-type: none"> Media unit: laminate Top: laminate or solid surface Top: rigid thermoform, if selected: sand only Edge band: 3 mm plastic Rail: Champagne only 	<ol style="list-style-type: none"> Style number Laminate color number for media unit cabinet Edge band color number for media unit Laminate color number for top, if selected Edge band color number for laminate top, if selected Solid surface color number for top, if selected Options, if selected (see below) <p>▶ See <i>Surface Materials</i>, page 402.</p>

Options	Price	Required to Specify
Surface Materials	Solid Surface	
• Solid surface price group A	No cost	Specify solid surface color number or finish code.
• Solid surface price group B	+\$ 97	Specify solid surface color number or finish code.
• Solid surface price group C	+\$ 97	Specify solid surface color number or finish code.
• Solid surface price group D	+\$110	Specify solid surface color number or finish code.
• Solid surface price group E	+\$120	Specify solid surface color number or finish code.

Specification Information

Dimensions	Style	Base
D W H	Number	Price
:	:	:

With Laminate Top

Single-Sided

18"	24"	36"	HM1MA2436L	\$1235
-----	-----	-----	-------------------	--------

Double-Sided

18"	24"	36"	HM2MA2436L	\$1297
-----	-----	-----	-------------------	--------

With Rigid Thermoform Top

Single-Sided

18"	24"	36"	HM1MA2436R	\$1285
-----	-----	-----	-------------------	--------

Double-Sided

18"	24"	36"	HM2MA2436R	\$1348
-----	-----	-----	-------------------	--------

With Solid Surface Top

Single-Sided

18"	24"	36"	HM1MA2436S	\$1760
-----	-----	-----	-------------------	--------

Double-Sided

18"	24"	36"	HM2MA2436S	\$1846
-----	-----	-----	-------------------	--------

Tip: Rigid thermoform top is standard with a spill edge.

Sonata Wardrobes

SIN 711.3

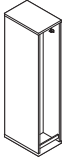

Standard Includes	Required to Specify
<ul style="list-style-type: none"> • Wardrobe: laminate • Edge band: 3 mm plastic • Coat hook: champagne only • Rail: champagne only 	<ul style="list-style-type: none"> 1 Style number 2 Laminate color number for wardrobe 3 Edge band color number ▶ See <i>Surface Materials</i>, page 402.

Specification Information

• Dimensions			• Style	• Price
D	W	H	Number	

Single-Sided Wardrobe

18"	12"	60"	HM1WA1260	\$ 959

Double-Sided Wardrobe

18"	12"	60"	HM2WA1260	\$1010

Sonata Bases

SIN 711.3

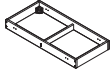

Tip: Base width should equal the total width of the modules to be placed on it.

Standard Includes	Required to Specify
<ul style="list-style-type: none"> • Base frame: black laminate only • Leveler 	<ul style="list-style-type: none"> • Style number

Specification Information				
• Dimensions			• Style	• Price
D	W	H	Number	
18"	12"	4"	HB12	\$254
18"	24"	4"	HB24	\$254
18"	36"	4"	HB36	\$267
18"	42"	4"	HB42	\$267
18"	48"	4"	HB48	\$267
18"	60"	4"	HB60	\$280
18"	66"	4"	HB66	\$280
18"	72"	4"	HB72	\$280
18"	84"	4"	HB84	\$291



Sonata Accessories

SIN 711.3

Coat Hooks



Standard Includes	Required to Specify
-------------------	---------------------

- Coat hooks: champagne paint only
- Package of two

Style number

Related Products

- Wardrobes

▶ Page 270

Specification Information	
---------------------------	--

• Style Number	• Price
HAH	\$68

Flat Screen Monitor Arm

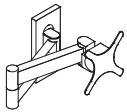

Standard Includes	Required to Specify
-------------------	---------------------

- Monitor arm: silver only

Style number

Related Products

- Media unit module

▶ Page 269

Specification Information	
---------------------------	--

• Style Number	• Price
HAMA1	\$254

Sync

► For more detailed product information, see the Steelcase Health Seating and Caseloads Specification Guides, or consult your Steelcase dealer.



Statement of Line **274**



Specifying

Double-Sided Bases (SIN 711.2)	276
Worksurfaces For Use with Double-Sided Bases (SIN 711.2)	278
Single-Sided Bases (SIN 711.2)	280
Worksurfaces For Use with Single-Sided Bases (SIN 711.2)	281
Single Leg Bases For Use with Full Arc and Scoop Worksurfaces (SIN 711.2)	282
Full Arc and Scoop Worksurfaces For Use with Single Leg Bases (SIN 711.2)	283
Accessories (SIN 711.2)	284

Statement of Line

Sync

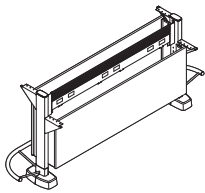

Upper Height 36"
Lower Height 28 1/2"

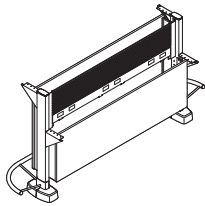

Upper Height 42"
Lower Height 28 1/2"

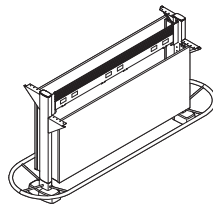

Upper Height 42"
Lower Height 36"

Specifying
▶ Page 276

Double-Sided Bases

Upper Height	Lower Height	72"W	84"W	96"W	108"W
36"	28 1/2"H	●	●	●	●
42"	28 1/2"H	●	●	●	●
42"	36"H	●	●	●	●



Interaction

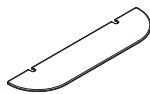

Process

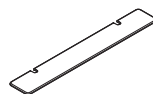

Transaction

Specifying
▶ Page 278

Upper Worksurfaces for use with Double-Sided Bases

	72"W	84"W	96"W	108"W
Interaction	●	●	●	●
Process	●	●	●	●
Transaction	●	●	●	●



Interaction



Process

Specifying
▶ Page 278

Lower Worksurfaces for use with Double-Sided Bases

	72"W	84"W	96"W	108"W
Interaction	●	●	●	●
Process	●	●	●	●

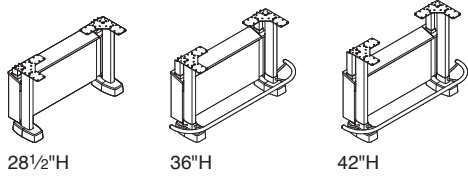

Specifying
▶ Page 280

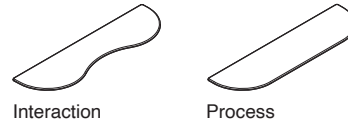

Specifying
▶ Page 281

Single-Sided Bases

	72"W	84"W	96"W	108"W
28 1/2"H	●	●	●	●
36"H	●	●	●	●
42"H	●	●	●	●

Worksurfaces for use with Single-Sided Bases

	72"W	84"W	96"W	108"W
Interaction	●	●	●	●
Process	●	●	●	●

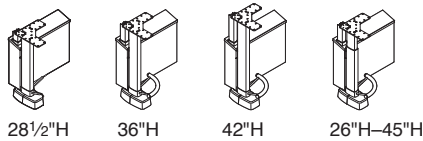

Specifying
▶ Page 282

Single Leg Bases

	Fixed	Electronically Adjustable
28 1/2"H	●	
36"H	●	
42"H	●	
26"H–45"H		●

Left-hand units shown. Right-hand units available.

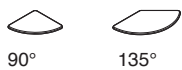

Specifying
▶ Page 283



Specifying
▶ Page 283

Full Arc Worksurfaces for use with Leg Bases

	90°	135°
Full Arc	●	●

Tip: Full arc worksurfaces are for use with single leg bases.

Scoop Worksurface for use with Leg Bases

	135°
Scoop	●

Tip: Scoop worksurfaces are for use with single leg bases.

Sync Double-Sided Bases

SIN 711.2

Tip: Worksurface heights are in fixed positions. Units can not be adjusted.

Tip: Up to two large CPUs and eight thin client computers can fit in each technology stretcher.

Tip: Frame tile should be specified when using custom inserts.

Tip: Transaction top available on 36"H and 42"H sides only.

Tip: Dimensions shown represent interaction and process top depths. When transaction top is specified overall depth is 40½".

Tip: The width of the work-surface must match the width of the base.

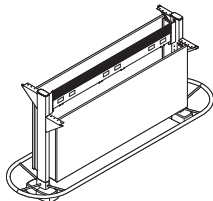
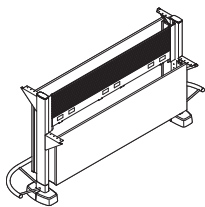
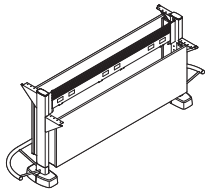

Standard Includes	Required to Specify
-------------------	---------------------

Standard Includes	Required to Specify
<ul style="list-style-type: none"> Legs: 4799 Platinum only Foot ring: 4799 Platinum only Foot cover Tile: laminate Tile edge band: 3 mm plastic Cantilever CPU hanging straps Base power-in cover: 4798 Sterling 	<ol style="list-style-type: none"> Style number Laminate color number for tile Plastic color number for tile edge band Options, if selected (see below) <p>▶ See <i>Surface Materials</i>, page 402.</p>

Options	Price	Required to Specify
---------	-------	---------------------

Surface Materials	<ul style="list-style-type: none"> Steelcase Health laminate Steelcase laminate 	No cost +\$69	▶ See <i>Surface Materials Reference Manual</i> . ▶ See <i>Surface Materials Reference Manual</i> .
Monitor Arm	<ul style="list-style-type: none"> Monitor arm mounting package 	+\$97	Specify for use with monitor arm.
Cantilever	<ul style="list-style-type: none"> For use with transaction tops 	No cost	Specify with cantilever.
Tile	<ul style="list-style-type: none"> Frame tile: 4799 Platinum only 	No cost	Specify with frame tile.
Related Products	<ul style="list-style-type: none"> Monitor arms Accessories 		▶ Page 284 ▶ Page 284

Specification Information					
---------------------------	--	--	--	--	--

Dimensions		Upper Base		Lower Base		Style Number	Base Price
D	W	Base Height	Base Height				

Upper Base 36"H, Lower Base 28½"H

49½"	72"	36"	28½"	HBB723628	\$5089
49½"	84"	36"	28½"	HBB843628	\$5153
49½"	96"	36"	28½"	HBB963628	\$5218
49½"	108"	36"	28½"	HBB1083628	\$5286

Upper Base 42"H, Lower Base 28½"H

49½"	72"	42"	28½"	HBB724228	\$5242
49½"	84"	42"	28½"	HBB844228	\$5307
49½"	96"	42"	28½"	HBB964228	\$5376
49½"	108"	42"	28½"	HBB1084228	\$5445

Upper Base 42"H, Lower Base 36"H

49½"	72"	42"	36"	HBB724236	\$5345
49½"	84"	42"	36"	HBB844236	\$5415
49½"	96"	42"	36"	HBB964236	\$5483
49½"	108"	42"	36"	HBB1084236	\$5553

SIN 711.2

Sync Worksurfaces

For Use with Double-Sided Bases

SIN 711.2

Tip: The width of the work-surface must match the width of the base.

Standard Includes	Required to Specify
-------------------	---------------------

- Laminate worksurface, if selected: laminate
- Solid surface worksurface, if selected: price group A
- Edge band on laminate worksurface, if selected: 3 mm plastic

- 1 Style number
 - 2 Laminate or solid surface color number for worksurface
 - 3 Plastic color number for edge band, if selected
 - 4 Options, if selected (see below)
- ▶ See *Surface Materials*, page 402.

Options	Price	Required to Specify
---------	-------	---------------------

Surface Materials

- Laminate
- Solid surface

No cost
Prices below and at right

▶ See *Surface Materials Reference Manual*. Specify solid surface color number.

Specification Information

Dimensions		Style Number	Base Price	Options		
D	W			(Add \$ to Base Price)		
				Solid Surface		
				Price Group B	Price Group C	Price Group D

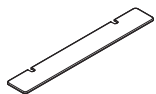

Tip: Transaction top available on 36"H and 42"H sides only.

Upper Transaction Worksurfaces

Laminate

Dimensions (D x W)	Style Number	Base Price	Option 1	Option 2	Option 3
15" x 72"	HT72UTL	\$ 339	N.A.	N.A.	N.A.
15" x 84"	HT84UTL	\$ 350	N.A.	N.A.	N.A.
15" x 96"	HT96UTL	\$ 373	N.A.	N.A.	N.A.
15" x 108"	HT108UTL	\$ 406	N.A.	N.A.	N.A.

Solid Surface

Dimensions (D x W)	Style Number	Base Price	Option 1	Option 2	Option 3
15" x 72"	HT72UTS	\$ 830	+\$122	+\$146	+\$162
15" x 84"	HT84UTS	\$1114	+\$179	+\$216	+\$238
15" x 96"	HT96UTS	\$1232	+\$202	+\$240	+\$264
15" x 108"	HT108UTS	\$1402	+\$240	+\$288	+\$319



Upper Interaction Worksurfaces

Laminate

Dimensions (D x W)	Style Number	Base Price	Option 1	Option 2	Option 3
24" x 72"	HT72UNL	\$ 479	N.A.	N.A.	N.A.
24" x 84"	HT84UNL	\$ 513	N.A.	N.A.	N.A.
24" x 96"	HT96UNL	\$ 558	N.A.	N.A.	N.A.
24" x 108"	HT108UNL	\$ 615	N.A.	N.A.	N.A.

Solid Surface

Dimensions (D x W)	Style Number	Base Price	Option 1	Option 2	Option 3
24" x 72"	HT72UNS	\$1400	+\$236	+\$252	+\$275
24" x 84"	HT84UNS	\$1608	+\$288	+\$311	+\$346
24" x 96"	HT96UNS	\$1818	+\$334	+\$367	+\$406
24" x 108"	HT108UNS	\$2182	+\$532	+\$582	+\$634

▶ **Specification Information, continued on next page**

► Specification Information, continued from previous page

SIN 711.2

Specification Information

Dimensions		Style Number	Base Price	Options (Add \$ to Base Price)		
D	W			Solid Surface Price Group B	Price Group C	Price Group D

Upper Process Worksurfaces

Laminate

24"	72"	HT72UPL	\$ 479	N.A.	N.A.	N.A.
24"	84"	HT84UPL	\$ 513	N.A.	N.A.	N.A.
24"	96"	HT96UPL	\$ 558	N.A.	N.A.	N.A.
24"	108"	HT108UPL	\$ 615	N.A.	N.A.	N.A.

Solid Surface

24"	72"	HT72UPS	\$1400	+\$236	+\$252	+\$275
24"	84"	HT84UPS	\$1608	+\$288	+\$311	+\$346
24"	96"	HT96UPS	\$1818	+\$334	+\$367	+\$406
24"	108"	HT108UPS	\$2182	+\$532	+\$582	+\$634

Lower Interaction Worksurfaces

Laminate

27 ³ / ₈ "	72"	HT72LNL	\$ 479	N.A.	N.A.	N.A.
27 ³ / ₈ "	84"	HT84LNL	\$ 513	N.A.	N.A.	N.A.
27 ³ / ₈ "	96"	HT96LNL	\$ 558	N.A.	N.A.	N.A.
27 ³ / ₈ "	108"	HT108LNL	\$ 615	N.A.	N.A.	N.A.

Solid Surface

27 ³ / ₈ "	72"	HT72LNS	\$1477	+\$164	+\$202	+\$228
27 ³ / ₈ "	72"	HT84LNS	\$1637	+\$262	+\$312	+\$346
27 ³ / ₈ "	72"	HT96LNS	\$1827	+\$325	+\$382	+\$422
27 ³ / ₈ "	72"	HT108LNS	\$2209	+\$507	+\$584	+\$637

Lower Process Worksurfaces

Laminate

27 ³ / ₈ "	72"	HT72LPL	\$ 479	N.A.	N.A.	N.A.
27 ³ / ₈ "	84"	HT84LPL	\$ 513	N.A.	N.A.	N.A.
27 ³ / ₈ "	96"	HT96LPL	\$ 558	N.A.	N.A.	N.A.
27 ³ / ₈ "	108"	HT108LPL	\$ 615	N.A.	N.A.	N.A.

Solid Surface

27 ³ / ₈ "	72"	HT72LPS	\$1477	+\$164	+\$202	+\$228
27 ³ / ₈ "	84"	HT84LPS	\$1637	+\$262	+\$312	+\$346
27 ³ / ₈ "	84"	HT96LPS	\$1827	+\$325	+\$382	+\$422
27 ³ / ₈ "	84"	HT108LPS	\$2209	+\$507	+\$584	+\$637

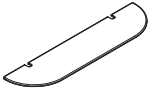

Sync Single-Sided Bases

SIN 711.2

Tip: Worksurface heights are in fixed positions. Units can not be adjusted.

Tip: Up to two desk top CPUs or two thin client computers can fit in each technology stretcher.

Tip: Frame tile should be specified when using custom insert.

Tip: Foot ring is not standard on 28½"H fixed height bases.

Tip: The width of the work-surface must match the width of the base.

Standard Includes	Required to Specify
-------------------	---------------------

<ul style="list-style-type: none"> • Legs: 4799 Platinum only • Foot ring: 4799 Platinum only • Foot cover • Tile: laminate • Tile edge band for laminate tile, if selected: 3 mm plastic • Worksurface mounting plate • CPU hanging straps • Four cable trays: 4799 Platinum 	<ol style="list-style-type: none"> 1 Style number 2 Appropriate tile 3 Laminate color number for tile, if selected 4 Plastic color number for tile edge band, if selected 5 Options, if selected (see below) <p>▶ See <i>Surface Materials</i>, page 402.</p>
---	--

Surface Materials	Options	Price	Required to Specify
-------------------	---------	-------	---------------------

<ul style="list-style-type: none"> • Steelcase Health laminate • Steelcase laminate 		No cost +\$69	▶ See <i>Surface Materials Reference Manual</i> . ▶ See <i>Surface Materials Reference Manual</i> .
Tile	<ul style="list-style-type: none"> • Laminate tile 	No cost	Specify with <i>laminate tile</i> , select laminate color and plastic color number for edge.
	<ul style="list-style-type: none"> • Frame tile: 4799 Platinum only 	No cost	Specify with <i>frame tile</i> .

Related Products	<ul style="list-style-type: none"> • Monitor arms • Accessories 	▶ Page 284 ▶ Page 284
-------------------------	---	--------------------------

Specification Information

• Dimensions			• Style	• Base
D	W	H	Number	Price

28½"H				
27¾"	72"	28½"	HBA7228	\$3523
27¾"	84"	28½"	HBA8428	\$3567
27¾"	96"	28½"	HBA9628	\$3615
27¾"	108"	28½"	HBA10828	\$3711

36"H				
27¾"	72"	36"	HBA7236	\$3627
27¾"	84"	36"	HBA8436	\$3675
27¾"	96"	36"	HBA9636	\$3724
27¾"	108"	36"	HBA10836	\$3820

42"H				
27¾"	72"	42"	HBA7242	\$3700
27¾"	84"	42"	HBA8442	\$3748
27¾"	96"	42"	HBA9642	\$3797
27¾"	108"	42"	HBA10842	\$3895

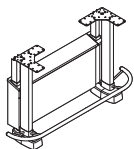
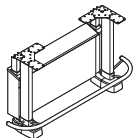
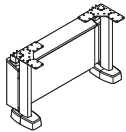

Sync Worksurfaces

For Use with Single-Sided Bases
SIN 711.2

Tip: The width of the work-surface must match the width of the base.

Standard Includes	Required to Specify
<ul style="list-style-type: none"> Laminate worksurface, if selected: laminate Solid surface worksurface, if selected: price group A Edge band for laminate worksurface, if selected: 3 mm plastic 	<ol style="list-style-type: none"> Style number Laminate or solid surface color number for worksurface Plastic color number for edge band, if selected Options, if selected (see below) <p>▶ See <i>Surface Materials</i>, page 402.</p>

Options	Price	Required to Specify
Surface Materials <ul style="list-style-type: none"> Laminate Solid surface 	No cost Prices below	▶ See <i>Surface Materials Reference Manual</i> . Specify solid surface color number.

Specification Information						
Dimensions		Style Number	Base Price	Options		
D	W			(Add \$ to Base Price)		
				Solid Surface		
				Price Group B	Price Group C	Price Group D

Interaction Worksurfaces

Laminate						
27 ³ / ₈ "	72"	HT72NL	\$ 479	N.A.	N.A.	N.A.
27 ³ / ₈ "	84"	HT84NL	\$ 513	N.A.	N.A.	N.A.
27 ³ / ₈ "	96"	HT96NL	\$ 558	N.A.	N.A.	N.A.
27 ³ / ₈ "	108"	HT108NL	\$ 615	N.A.	N.A.	N.A.
Solid Surface						
27 ³ / ₈ "	72"	HT72NS	\$1394	+\$232	+\$270	+\$297
27 ³ / ₈ "	84"	HT84NS	\$1654	+\$289	+\$340	+\$373
27 ³ / ₈ "	96"	HT96NS	\$1895	+\$328	+\$388	+\$428
27 ³ / ₈ "	108"	HT108NS	\$2297	+\$457	+\$536	+\$586

Process Worksurfaces

Laminate						
27 ³ / ₈ "	72"	HT72PL	\$ 479	N.A.	N.A.	N.A.
27 ³ / ₈ "	84"	HT84PL	\$ 513	N.A.	N.A.	N.A.
27 ³ / ₈ "	96"	HT96PL	\$ 558	N.A.	N.A.	N.A.
27 ³ / ₈ "	108"	HT108PL	\$ 615	N.A.	N.A.	N.A.
Solid Surface						
27 ³ / ₈ "	72"	HT72PS	\$1394	+\$232	+\$270	+\$297
27 ³ / ₈ "	84"	HT84PS	\$1654	+\$289	+\$340	+\$373
27 ³ / ₈ "	96"	HT96PS	\$1895	+\$328	+\$388	+\$428
27 ³ / ₈ "	108"	HT108PS	\$2297	+\$457	+\$536	+\$586



Sync Single Leg Bases

For Use With Full Arc and Scoop Worksurfaces

SIN 711.2

Standard Includes	Required to Specify
<ul style="list-style-type: none"> • Legs: 4799 Platinum only • Foot ring: 4799 Platinum only • Foot cover • Tile: laminate or frame • Tile edge band for laminate tile, if selected: 3 mm plastic • Worksurface mounting plate • CPU hanging straps • Two cable trays: 4799 Platinum • Simple touch controller, if adjustable-height leg base is selected 	<ol style="list-style-type: none"> 1 Style number 2 Appropriate foot ring 3 Appropriate tile 4 Laminate color number for tile, if selected 5 Plastic color number for tile edge band, if selected 6 Options, if selected (see below) <p>▶ See <i>Surface Materials</i>, page 402.</p>

Options	Price	Required to Specify
Surface Materials <ul style="list-style-type: none"> • Steelcase Health laminate • Steelcase laminate 	No cost +\$69	▶ See <i>Surface Materials Reference Manual</i> . ▶ See <i>Surface Materials Reference Manual</i> .
Foot Ring <ul style="list-style-type: none"> • 90° foot ring • 135° foot ring 	No cost +\$53	Specify with 90° foot ring. Specify with 135° foot ring.
Tile <ul style="list-style-type: none"> • Laminate tile • Frame tile: 4799 Platinum only 	No cost No cost	Specify with laminate tile, select laminate color and plastic color number for edge. Specify with frame tile.
Related Products <ul style="list-style-type: none"> • Monitor arms • Accessories 		▶ Page 284 ▶ Page 284

Tip: Frame tile should be specified when using custom insert. Custom inserts are provided by dealer or customer and are field installed.

Tip: Left or right is determined when facing Sync.

Specification Information				
Dimensions			Style Number	Base Price
D	W	H		

Adjustable-Height Leg Bases

Left

25 ³ / ₄ "	24"	26"-45"	HBC24AL	\$2598
----------------------------------	-----	---------	----------------	--------

Right

25 ³ / ₄ "	24"	26"-45"	HBC24AR	\$2598
----------------------------------	-----	---------	----------------	--------

Fixed-Height Leg Bases

Left

25 ³ / ₄ "	24"	28 ¹ / ₂ "	HBC2428L	\$1534
----------------------------------	-----	----------------------------------	-----------------	--------

25 ³ / ₄ "	24"	36"	HBC2436L	\$1580
----------------------------------	-----	-----	-----------------	--------

25 ³ / ₄ "	24"	42"	HBC2442L	\$1624
----------------------------------	-----	-----	-----------------	--------

Right

25 ³ / ₄ "	24"	28 ¹ / ₂ "	HBC2428R	\$1534
----------------------------------	-----	----------------------------------	-----------------	--------

25 ³ / ₄ "	24"	36"	HBC2436R	\$1580
----------------------------------	-----	-----	-----------------	--------

25 ³ / ₄ "	24"	42"	HBC2442R	\$1624
----------------------------------	-----	-----	-----------------	--------

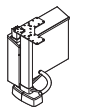
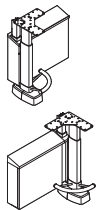

Sync Full Arc and Scoop Worksurfaces

For Use With Single Leg Bases

SIN 711.2

Sync
Full Arc and Scoop
Worksurfaces

Standard Includes	Required to Specify
<ul style="list-style-type: none"> Laminate worksurface, if selected Solid surface worksurface, if selected: price group A Edge band on laminate worksurface, if selected: 3 mm plastic 	<ol style="list-style-type: none"> Style number Laminate or solid surface color number for worksurface Plastic color number for edge band, if selected Options, if selected (see below) <p>▶ See <i>Surface Materials</i>, page 402.</p>

Options	Price	Required to Specify
Surface Materials <ul style="list-style-type: none"> Laminate Solid surface 	No cost Prices below	▶ See <i>Surface Materials Reference Manual</i> . Specify solid surface color number.
Related Products <ul style="list-style-type: none"> Accessories 		▶ Page 284

Specification Information						
Dimensions		Style Number	Base Price	Options		
D	W			(Add \$ to Base Price)		
				Solid Surface		
				Price Group B	Price Group C	Price Group D

90° Full Arc Worksurfaces

Laminate						
25¾"	25½"	HT90FL	\$260	N.A.	N.A.	N.A.
Solid Surface						
25¾"	25½"	HT90FS	\$810	+\$137	+\$271	+\$295

135° Full Arc Worksurfaces

Laminate						
25¾"	43½"	HT135FL	\$335	N.A.	N.A.	N.A.
Solid Surface						
25¾"	43½"	HT135FS	\$969	+\$188	+\$209	+\$224

135° Scoop Worksurfaces

Laminate Left-Hand						
25¾"	43½"	HT135SLHL	\$335	N.A.	N.A.	N.A.
Laminate Right-Hand						
25¾"	43½"	HT135SRHL	\$335	N.A.	N.A.	N.A.
Solid Surface Left-Hand						
25¾"	43½"	HT135SLHS	\$969	+\$188	+\$209	+\$224
Solid Surface Right-Hand						
25¾"	43½"	HT135SRHS	\$969	+\$188	+\$209	+\$224



Sync Accessories

SIN 711.2

Upper and Lower Monitor Arms

Tip: To use upper or lower monitor arms, specify for use with monitor arm option on the base unit.

Tip: Slatwall monitor arm (FPASYNCSWR) cannot be used on 42"H/36"H double-sided units.

Standard Includes	Required to Specify
<ul style="list-style-type: none"> • Monitor arm: 4799 Platinum only • Attachment hardware 	Style number

Related Products
<ul style="list-style-type: none"> • Worktools

Specification Information

Style Number	Base Price

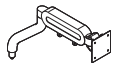

Upper Monitor Arm

FPASYNCU	\$346

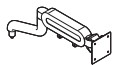

Lower Monitor Arm

FPASYNCL	\$346

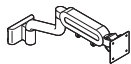

Slatwall Monitor Arm

FPASYNCSWR	\$394

Single Flat Panel Monitor Arm with C-Clamp Mounting Bracket

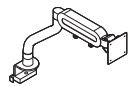

Tip: C-clamp bracket is for use with worksurfaces with a thickness of 3/4" to 1 3/8".

Tip: The colors for upper arm and cable cover are defaulted by monitor arm.
 ▶ See *Worktools Specification Guide* for default paint matrix.

Standard Includes	Required to Specify
<ul style="list-style-type: none"> • Monitor arm: paint • 75 mm/100 mm VESA plate • Mounting bracket • Upper arm and cable cover: color defaulted by monitor arm color 	1 Style number 2 Paint color number for monitor arm: 4231 Arctic White 4710 Low Gloss Black 4799 Platinum Metallic 3 Options, if selected (see below)

Options	Price	Required to Specify
Surface Materials <ul style="list-style-type: none"> • Paint price group 3 	+\$45	Specify paint color number. ▶ See <i>Surface Materials Reference Manual</i> for accent paint options.

Specification Information

Style Number	Base Price

FPASINGLECC	\$394

Products on this page are Steelcase worktools, not Steelcase Health.

They are included here to simplify your planning. Remember that Steelcase worktools has different pricing terms than Steelcase Health products.

Monitor Arm Hardware Package

Tip: Monitor arm hardware package is for use with upper and lower monitor arm models. Must be ordered separately.

Tip: Monitor arm hardware package is needed only when not specified on the base unit. Monitor arm hardware package will accommodate one to four monitors.

Standard Includes	Required to Specify
<ul style="list-style-type: none"> Attachment hardware: platinum only 	Style number

Specification Information

Style Number	Price
FPASYNMT	\$49

Monitor Handle

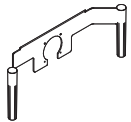

Standard Includes	Required to Specify
<ul style="list-style-type: none"> Monitor handle: 4799 Platinum only Attachment hardware 	Style number

Specification Information

Style Number	Price
FPAHANDLE	\$232

LED Monitor Lights with Bracket

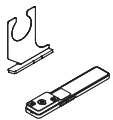

Standard Includes	Required to Specify
<ul style="list-style-type: none"> Light: 4799 Platinum only Attachment hardware Power block 	Style number

Specification Information

Style Number	Price
FPASYNLED	\$287

Products on this page are Steelcase worktools, not Steelcase Health.

They are included here to simplify your planning. Remember that Steelcase worktools has different pricing terms than Steelcase Health products.

Sync Accessories, continued

SIN 711.2

Solid Top Bridge Bracket

Tip: When using the WFCS Slatwall Stanchion, Eyesite LCD arms, and the FYI c-clamp design (i.e. FPASINGLECC) on solid surface tops, a filler bracket (HBRKTS) also needs to be specified.

Standard Includes	Required to Specify
• Bracket: 7207 Black only	Style number

Specification Information

• Style Number	• Price
HBRKTS	\$49
:	:

Folio

► For more detailed product information, see the Steelcase Health Seating and Caseloads Specification Guides, or consult your Steelcase dealer.



Statement of Line **288**



Specifying

28"H Base Cabinets (SIN 71.315)	294
33"H ADA Base Cabinets (SIN 71.315)	296
36"H Base Cabinets (SIN 71.315)	300
Sink Cabinets (SIN 71.315)	303
84"H Storage Cabinets (SIN 71.315)	304
92"H Storage Cabinets with Sloped Top (SIN 71.315)	306
84"H Wardrobe Cabinets (SIN 71.315)	308
92"H Wardrobe Cabinets with Sloped Top (SIN 71.315)	309
84"H Bookcases (SIN 71.315)	310
89"H Bookcases with Sloped Top (SIN 71.315)	312
Upper Storage Cabinets (SIN 71.315)	314
Upper Storage Cabinets with Sloped Top (SIN 71.315)	316
Laminate Worksurfaces (SIN 71.315)	318
4"H Laminate Sidesplash (SIN 71.315)	319
Solid Surface Worksurfaces (SIN 71.315)	320
4"H Solid Surface Sidesplash (SIN 71.315)	321
Desk Frames (SIN 71.315)	322
Accessories (SIN 71.315)	323

Statement of Line

Folio

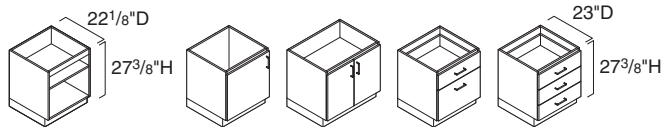

*Cabinet depth without the doors or drawers is 22 1/8".

Specifying
▶ Page 294

28"H Base Cabinets

	12"W	18"W	21"W	24"W	30"W	36"W
Open with one adjustable shelf	●	●	●	●	●	●
With single door and one adjustable shelf	●	●	●	●		
With double doors and one adjustable shelf					●	●
With one small drawer and one large drawer	●	●	●	●	●	●
With three small drawers	●	●	●	●	●	●

Tip: Dimensions are for reference only. See shop drawings for actual measurements at village.steelcase.com.

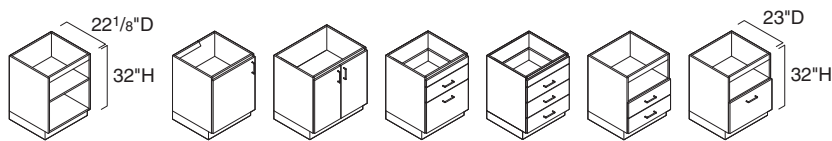

*Cabinet depth without the doors or drawers is 22 1/8".

Specifying
▶ Page 296

33"H ADA Base Cabinets

	12"W	18"W	21"W	24"W	30"W	36"W
Open with one adjustable shelf	●	●	●	●	●	●
With single door and one adjustable shelf	●	●	●	●		
With double doors and one adjustable shelf					●	●
With one small drawer and one large drawer	●	●	●	●	●	●
With three small drawers	●	●	●	●	●	●
With open shelf and two small drawers	●	●	●	●	●	●
With open shelf and one large drawer	●	●	●	●	●	●

Tip: Dimensions are for reference only. See shop drawings for actual measurements at village.steelcase.com.

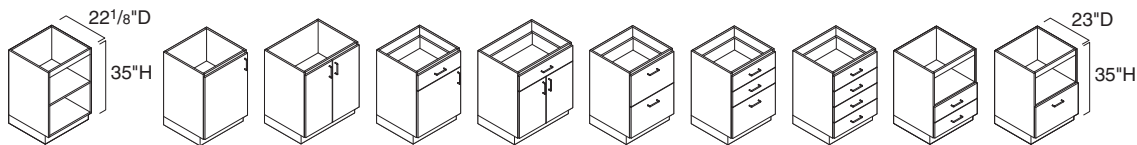

*Cabinet depth without the doors or drawers is 22 1/8".

Specifying
▶ Page 300

36"H Base Cabinets

	12"W	18"W	21"W	24"W	30"W	36"W
Open with one adjustable shelf	●	●	●	●	●	●
With single door and one adjustable shelf	●	●	●	●		
With double doors and one adjustable shelf					●	●
With one small drawer, single door, and one adjustable shelf	●	●	●	●		
With one small drawer, double doors, and one adjustable shelf					●	●
With two large drawers	●	●	●	●	●	●
With two small drawers and one large drawer	●	●	●	●	●	●
With four small drawers	●	●	●	●	●	●
With open shelf and two small drawers	●	●	●	●	●	●
With open shelf and one large drawer	●	●	●	●	●	●

Tip: Dimensions are for reference only. See shop drawings for actual measurements at village.steelcase.com.

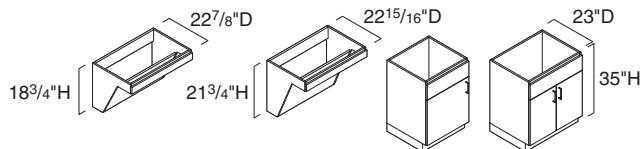

*Cabinet depth without the doors or drawers is 22 1/8".

Specifying
▶ Page 303

Sink Cabinets

	24"W	30"W	36"W
32"H with angled front			●
35"H with angled front			●
35"H with single door	●		
35"H with double doors		●	●

Tip: Dimensions are for reference only. See shop drawings for actual measurements at village.steelcase.com.

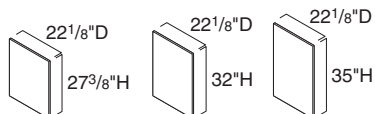

Specifying
▶ Pages 295, 298,
and 302

Support End Panels

Adjacent Cabinet Height	28"H	33"H	36"H
24"D	●	●	●

Tip: Dimensions are for reference only. See shop drawings for actual measurements at village.steelcase.com.

Statement of Line Folio, continued

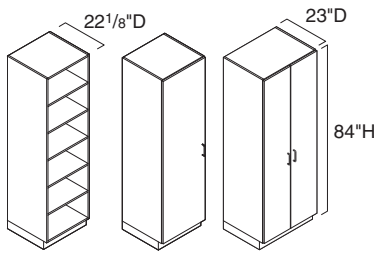

*Cabinet depth without the doors or drawers is 22 1/8".

Specifying
▶ Page 304

84"H Storage Cabinets

	12"W	18"W	21"W	24"W	30"W	36"W
Open with five shelves	●	●	●	●	●	●
With single door and five shelves	●	●	●	●		
With double doors and five shelves					●	●

Tip: Dimensions are for reference only. See shop drawings for actual measurements at village.steelcase.com.

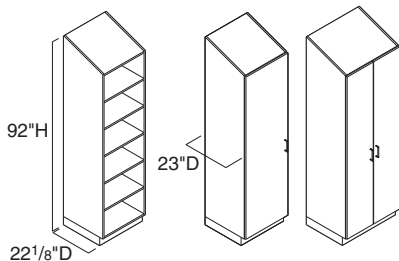

*Cabinet depth without the doors or drawers is 22 1/8".

Specifying
▶ Page 306

92"H Storage Cabinets with Sloped Top

	12"W	18"W	21"W	24"W	30"W	36"W
Open with five shelves	●	●	●	●	●	●
With single door and five shelves	●	●	●	●		
With double doors and five shelves					●	●

Tip: Dimensions are for reference only. See shop drawings for actual measurements at village.steelcase.com.

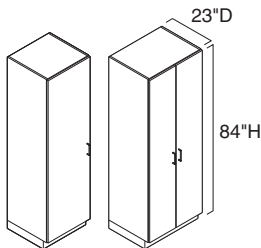

*Cabinet depth without the doors or drawers is 22 1/8".

Specifying
▶ Page 308

84"H Wardrobe Cabinets

	12"W	18"W	21"W	24"W	30"W	36"W
With single door and one fixed shelf	●	●	●	●		
With double doors and one fixed shelf					●	●

Tip: Dimensions are for reference only. See shop drawings for actual measurements at village.steelcase.com.

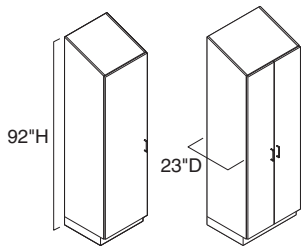

*Cabinet depth without the doors or drawers is 22¹/₁₆".

Specifying
▶ Page 309

92"H Wardrobe Cabinets with Sloped Top

	12"W	18"W	21"W	24"W	30"W	36"W
With single door and one fixed shelf	●	●	●	●		
With double doors and one fixed shelf					●	●

Tip: Dimensions are for reference only. See shop drawings for actual measurements at village.steelcase.com.

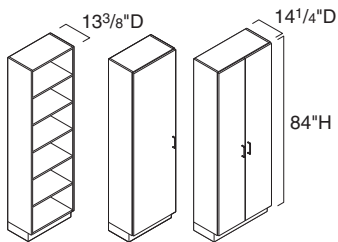

*Cabinet depth without the doors or drawers is 13³/₈".

Specifying
▶ Page 310

84"H Bookcases

	12"W	18"W	21"W	24"W	30"W	36"W
Open with five shelves	●	●	●	●	●	●
With single door and five shelves	●	●	●	●		
With double doors and five shelves					●	●

Tip: Dimensions are for reference only. See shop drawings for actual measurements at village.steelcase.com.

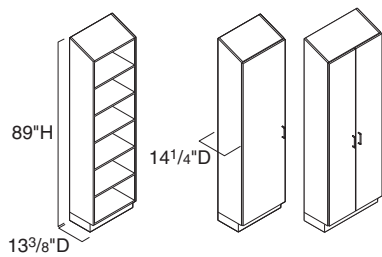

*Cabinet depth without the doors or drawers is 13³/₈".

Specifying
▶ Page 312

89"H Bookcases with Sloped Top

	12"W	18"W	21"W	24"W	30"W	36"W
Open with five shelves	●	●	●	●	●	●
With single door and five shelves	●	●	●	●		
With double doors and five shelves					●	●

Tip: Dimensions are for reference only. See shop drawings for actual measurements at village.steelcase.com.

Statement of Line Folio, continued

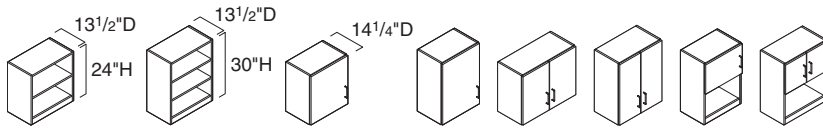

*Cabinet depth without the doors or drawers is 13 1/2\".

Specifying
▶ Page 314

Upper Storage Cabinets

	12\"W	18\"W	21\"W	24\"W	30\"W	36\"W
24\"H open storage cabinet	●	●	●	●	●	●
30\"H open storage cabinet	●	●	●	●	●	●
24\"H with single door	●	●	●			
30\"H with single door	●	●	●			
24\"H with double doors				●	●	●
30\"H with double doors				●	●	●
30\"H with single door and open shelf	●	●	●			
30\"H with double doors and open shelf				●	●	●

Tip: Dimensions are for reference only. See shop drawings for actual measurements at village.steelcase.com.

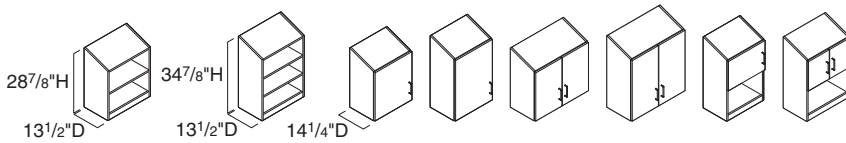

*Cabinet depth without the doors or drawers is 13 1/2\".

Specifying
▶ Page 316

Upper Storage Cabinets with Sloped Top

	12\"W	18\"W	21\"W	24\"W	30\"W	36\"W
29\"H open storage cabinet	●	●	●	●	●	●
35\"H open storage cabinet	●	●	●	●	●	●
29\"H with single door	●	●	●			
35\"H with single door	●	●	●			
29\"H with double doors				●	●	●
35\"H with double doors				●	●	●
35\"H with single door and open shelf	●	●	●			
35\"H with double doors and open shelf				●	●	●

Tip: Dimensions are for reference only. See shop drawings for actual measurements at village.steelcase.com.

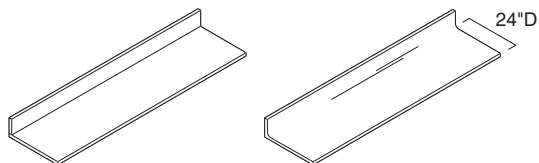

Specifying
▶ Pages 318 and 320

Worksurfaces

24"D Laminate worksurfaces with 4" backsplash

12"W	18"W	21"W	24"W	27"W	30"W	33"W	36"W	39"W	42"W	45"W	48"W	51"W
●	●	●	●	●	●	●	●	●	●	●	●	●
54"W	60"W	66"W	72"W	78"W	84"W	90"W	96"W	102"W	108"W	114"W	120"W	
●	●	●	●	●	●	●	●	●	●	●	●	

24"D Solid surface worksurfaces with integrated backsplash

12"W	18"W	21"W	24"W	27"W	30"W	33"W	36"W	39"W	42"W	45"W	48"W	51"W
●	●	●	●	●	●	●	●	●	●	●	●	●
54"W	60"W	66"W	72"W	78"W	84"W	90"W	96"W	102"W	108"W	114"W	120"W	
●	●	●	●	●	●	●	●	●	●	●	●	

Tip: Dimensions are for reference only. See shop drawings for actual measurements at village.steelcase.com.

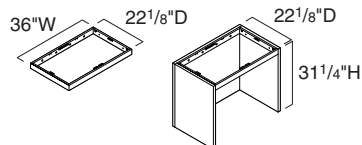

Specifying
▶ Page 322

Desk Frames

	12"W	18"W	24"W	30"W	36"W	42"W	48"W	54"W	60"W	72"W
Without back panel for use with common top	●	●	●	●	●	●	●	●	●	●
With back panel for use with common top			●	●	●					

Tip: Dimensions are for reference only. See shop drawings for actual measurements at village.steelcase.com.

Folio 28"H Base Cabinets

SIN 71.315

Standard Includes	Required to Specify
<ul style="list-style-type: none"> • Base cabinet, door and drawer fronts, and shelves: melamine • D pull, if selected: nickel only • Euro hinge, if selected: nickel only • Edges: matching 3 mm plastic on doors and drawers and matching 1 mm plastic on all other edges • Shelf pins • Adjustable glides 	<ol style="list-style-type: none"> 1 Style number 2 Laminate color number for base cabinet 3 Options, if selected (see below) <p>▶ See <i>Surface Materials</i>, page 402.</p>

Options	Price	Required to Specify
Door and Drawer Pulls <ul style="list-style-type: none"> • Contemporary: nickel only • Opus: champagne only • Jazz: nickel only 	No cost +\$15 per pull +\$17 per pull	Specify with <i>contemporary pull</i> . Specify with <i>Opus pull</i> . Specify with <i>jazz pull</i> .
Five-Knuckle Hinges <ul style="list-style-type: none"> • For cabinet with single door: nickel only • For cabinet with double doors: nickel only 	+\$21 +\$42	Specify with <i>five-knuckle hinge</i> . Specify with <i>five-knuckle hinge</i> .
Lock and Keying <ul style="list-style-type: none"> • 9201 Polished Chrome only 	+\$34	Specify with <i>lock</i> .
	Keying <ul style="list-style-type: none"> • Factory and field-installed keying 	▶ Page 440
Related Products <ul style="list-style-type: none"> • Shelves for base cabinets • Fillers for base cabinets • Plastic drawer liners 		▶ Page 323 ▶ Page 324 ▶ Page 325

Tip: Lock secures top drawer only on units with multiple drawers or a drawer and door combination.

Tip: Additional shelves are available and must be specified separately.

Tip: Dimensions are for reference only. See shop drawings for actual measurements at village.steelcase.com.

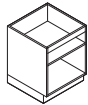

Tip: Height is for base cabinet without worksurface.

Specification Information				
Dimensions			Style	Base
D	W	H	Number	Price

Open Cabinets with One Adjustable Shelf

22 ¹ / ₈ "	12"	27 ³ / ₈ "	HXBP1228	\$584
22 ¹ / ₈ "	18"	27 ³ / ₈ "	HXBP1828	\$617
22 ¹ / ₈ "	21"	27 ³ / ₈ "	HXBP2128	\$637
22 ¹ / ₈ "	24"	27 ³ / ₈ "	HXBP2428	\$660
22 ¹ / ₈ "	30"	27 ³ / ₈ "	HXBP3028	\$687
22 ¹ / ₈ "	36"	27 ³ / ₈ "	HXBP3628	\$709

Cabinets with Single Door and One Adjustable Shelf

Hinged Left

23"	12"	27 ³ / ₈ "	HXBD1228L	\$711
23"	18"	27 ³ / ₈ "	HXBD1828L	\$763
23"	21"	27 ³ / ₈ "	HXBD2128L	\$797
23"	24"	27 ³ / ₈ "	HXBD2428L	\$823

Hinged Right

23"	12"	27 ³ / ₈ "	HXBD1228R	\$711
23"	18"	27 ³ / ₈ "	HXBD1828R	\$763
23"	21"	27 ³ / ₈ "	HXBD2128R	\$797
23"	24"	27 ³ / ₈ "	HXBD2428R	\$823

▶ Specification Information, continued on next page

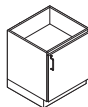
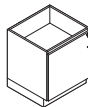

SIN 71.315

► Specification Information, continued from previous page

Specification Information

Dimensions			Style	Base
D	W	H	Number	Price

Cabinets With Double Doors and One Adjustable Shelf

23"	30"	27 ³ / ₈ "	HXBD3028	\$ 983
23"	36"	27 ³ / ₈ "	HXBD3628	\$1025

Cabinets With One Small Drawer and One Large Drawer

23"	12"	27 ³ / ₈ "	HXBC1228	\$1078
23"	18"	27 ³ / ₈ "	HXBC1828	\$1148
23"	21"	27 ³ / ₈ "	HXBC2128	\$1194
23"	24"	27 ³ / ₈ "	HXBC2428	\$1230
23"	30"	27 ³ / ₈ "	HXBC3028	\$1272
23"	36"	27 ³ / ₈ "	HXBC3628	\$1314

Cabinets With Three Small Drawers

23"	12"	27 ³ / ₈ "	HXBM1228	\$1164
23"	18"	27 ³ / ₈ "	HXBM1828	\$1271
23"	21"	27 ³ / ₈ "	HXBM2128	\$1354
23"	24"	27 ³ / ₈ "	HXBM2428	\$1400
23"	30"	27 ³ / ₈ "	HXBM3028	\$1438
23"	36"	27 ³ / ₈ "	HXBM3628	\$1484

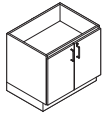

Support End Panel

For 28"H Base Cabinets
SIN 71.315



Tip: An end panel must be attached to a worksurface. When ordering a worksurface for attachment to an end panel, the extended worksurface option must be specified. Worksurfaces are specified separately.

Tip: Height is for support end panel without worksurface attached.

Tip: Dimensions are for reference only. See shop drawings for actual measurements at village.steelcase.com.

Standard Includes

- Support end panel: melamine
- Edges: matching 1 mm plastic

Required to Specify

- 1 Style number
 - 2 Laminate color number for support end panel
- See *Surface Materials*, page 402.

Specification Information

Dimensions			Style	Price
D	W	H	Number	

22 ¹ / ₈ "	1 ³ / ₁₆ "	27 ³ / ₈ "	HXBE28	\$166
----------------------------------	----------------------------------	----------------------------------	---------------	-------

Folio 33"H ADA Base Cabinets

SIN 71.315

Standard Includes	Required to Specify
<ul style="list-style-type: none"> Storage cabinet, door and drawer fronts, and shelves: melamine D pull, if selected: nickel only Euro hinge, if selected: nickel only Edges: matching 3 mm plastic on doors and drawers and matching 1 mm plastic on all other edges Shelf pins Adjustable glides 	<ul style="list-style-type: none"> 1 Style number 2 Laminate color number for base cabinet 3 Options, if selected (see below) ▶ See <i>Surface Materials</i>, page 402.

Options	Price	Required to Specify
Door and Drawer Pulls <ul style="list-style-type: none"> Contemporary: nickel only Opus: champagne only Jazz: nickel only 	No cost +\$15 per pull +\$17 per pull	Specify with <i>contemporary pull</i> . Specify with <i>Opus pull</i> . Specify with <i>jazz pull</i> .
Five-Knuckle Hinges <ul style="list-style-type: none"> For cabinet with single door: nickel only For cabinet with double doors: nickel only 	+\$21 +\$42	Specify with <i>five-knuckle hinge</i> . Specify with <i>five-knuckle hinge</i> .
Lock and Keying <ul style="list-style-type: none"> Lock <ul style="list-style-type: none"> 9201 Polished Chrome only Keying <ul style="list-style-type: none"> Factory and field-installed keying 	+\$34	Specify with <i>lock</i> . ▶ Page 440
Related Products <ul style="list-style-type: none"> Shelves for base cabinets Fillers for base cabinets Plastic drawer liners 		▶ Page 323 ▶ Page 324 ▶ Page 325

Tip: Lock secures top drawer only on units with multiple drawers or a drawer and door combination.

Tip: Additional shelves are available and must be specified separately.

Specification Information				
Dimensions			Style	Base
D	W	H	Number	Price

Open Cabinets with One Adjustable Shelf				
22 ¹ / ₈ "	12"	32"	HXBP1233A	\$594
22 ¹ / ₈ "	18"	32"	HXBP1833A	\$627
22 ¹ / ₈ "	21"	32"	HXBP2133A	\$650
22 ¹ / ₈ "	24"	32"	HXBP2433A	\$673
22 ¹ / ₈ "	30"	32"	HXBP3033A	\$698
22 ¹ / ₈ "	36"	32"	HXBP3633A	\$724

Cabinets with Single Door and One Adjustable Shelf				
Hinged Left				
23"	12"	32"	HXBD1233AL	\$665
23"	18"	32"	HXBD1833AL	\$710
23"	21"	32"	HXBD2133AL	\$744
23"	24"	32"	HXBD2433AL	\$766
Hinged Right				
23"	12"	32"	HXBD1233AR	\$665
23"	18"	32"	HXBD1833AR	\$710
23"	21"	32"	HXBD2133AR	\$744
23"	24"	32"	HXBD2433AR	\$766

▶ Specification Information, continued on next page

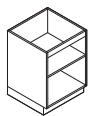

Tip: Height is for base cabinet without worksurface.

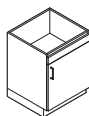
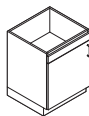

SIN 71.315

► Specification Information, continued from previous page

Specification Information

Dimensions			Style	Base
D	W	H	Number	Price

Cabinets with Double Doors and One Adjustable Shelf

23"	30"	32"	HXBD3033A	\$ 917
23"	36"	32"	HXBD3633A	\$ 957

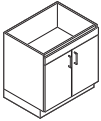

Cabinets with One Small Drawer and One Large Drawer

23"	12"	32"	HXBC1233A	\$1088
23"	18"	32"	HXBC1833A	\$1158
23"	21"	32"	HXBC2133A	\$1207
23"	24"	32"	HXBC2433A	\$1243
23"	30"	32"	HXBC3033A	\$1283
23"	36"	32"	HXBC3633A	\$1329



Cabinets with Three Small Drawers

23"	12"	32"	HXBM1233A	\$1174
23"	18"	32"	HXBM1833A	\$1281
23"	21"	32"	HXBM2133A	\$1367
23"	24"	32"	HXBM2433A	\$1413
23"	30"	32"	HXBM3033A	\$1449
23"	36"	32"	HXBM3633A	\$1499



Cabinets with Open Shelf and Two Small Drawers

23"	12"	32"	HXCN1233A	\$1018
23"	18"	32"	HXCN1833A	\$1105
23"	21"	32"	HXCN2133A	\$1172
23"	24"	32"	HXCN2433A	\$1213
23"	30"	32"	HXCN3033A	\$1250
23"	36"	32"	HXCN3633A	\$1296



► Specification Information, continued on next page

Folio 33"H ADA Base Cabinets, continued

SIN 71.315

► Specification Information, continued from previous page

Specification Information

• Dimensions			• Style	• Base
D	W	H	Number	Price

Cabinets with Open Shelf and One Large Drawer

23"	12"	32"	HXBL1233A	\$ 932
23"	18"	32"	HXBL1833A	\$ 982
23"	21"	32"	HXBL2133A	\$1012
23"	24"	32"	HXBL2433A	\$1043
23"	30"	32"	HXBL3033A	\$1084
23"	36"	32"	HXBL3633A	\$1126

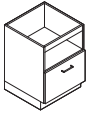

Support End Panel

For 33"H ADA Base Cabinets

SIN 71.315

Standard Includes **Required to Specify**

- Support end panel: melamine
- Edges: matching 1 mm plastic

- 1 Style number
- 2 Laminate color number for support end panel
- See *Surface Materials*, page 402.



Tip: An end panel must be attached to a worksurface. When ordering a worksurface for attachment to an end panel, the extended worksurface option must be specified. Worksurfaces are specified separately.

Tip: Height is for support end panel without worksurface attached.

Tip: Dimensions are for reference only. See shop drawings for actual measurements at village.steelcase.com.

Specification Information

• Dimensions			• Style	• Price
D	W	H	Number	Price

22 ¹ / ₈ "	13 ¹ / ₁₆ "	32"	HXBE33A	\$166
----------------------------------	-----------------------------------	-----	----------------	-------

Folio 36"H Base Cabinets

SIN 71.315

Standard Includes	Required to Specify
<ul style="list-style-type: none"> Base cabinet, door and drawer fronts, and shelves: melamine D pull, if selected: nickel only Euro hinge, if selected: nickel only Edges: matching 3 mm plastic on doors and drawers and matching 1 mm plastic on all other edges Shelf pins Adjustable glides 	<ol style="list-style-type: none"> Style number Laminate color number for base cabinet Options, if selected (see below) <p>▶ See <i>Surface Materials</i>, page 402.</p>

Options	Price	Required to Specify
Door and Drawer Pulls <ul style="list-style-type: none"> Contemporary: nickel only Opus: champagne only Jazz: nickel only 	No cost +\$15 per pull +\$17 per pull	Specify with <i>contemporary pull</i> . Specify with <i>Opus pull</i> . Specify with <i>jazz pull</i> .
Five-Knuckle Hinges <ul style="list-style-type: none"> For cabinet with single door: nickel only For cabinet with double doors: nickel only 	+\$21 +\$42	Specify with <i>five-knuckle hinge</i> . Specify with <i>five-knuckle hinge</i> .
Lock and Keying <ul style="list-style-type: none"> Lock <ul style="list-style-type: none"> 9201 Polished Chrome only Keying <ul style="list-style-type: none"> Factory and field-installed keying 	+\$34	Specify with <i>lock</i> . ▶ Page 440
Related Products <ul style="list-style-type: none"> Shelves for base cabinets Fillers for base cabinets Plastic drawer liners 		▶ Page 323 ▶ Page 324 ▶ Page 325

Tip: Lock secures top drawer only on units with multiple drawers or a drawer and door combination.

Tip: Additional shelves are available and must be specified separately.

Tip: Dimensions are for reference only. See shop drawings for actual measurements at village.steelcase.com.

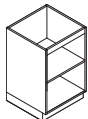

Tip: Height is for base cabinet without worksurface.

Tip: Depth is 22 1/8" without door and drawer fronts.

Specification Information				
Dimensions			Style	Base
D	W	H	Number	Price
:	:	:	:	:

Open Cabinets with One Adjustable Shelf

22 1/8"	12"	35"	HXBP1236	\$605
22 1/8"	18"	35"	HXBP1836	\$638
22 1/8"	21"	35"	HXBP2136	\$662
22 1/8"	24"	35"	HXBP2436	\$684
22 1/8"	30"	35"	HXBP3036	\$709
22 1/8"	36"	35"	HXBP3636	\$737
:	:	:	:	:

Cabinets with Single Door and One Adjustable Shelf

Hinged Left

23"	12"	35"	HXBD1236L	\$732
23"	18"	35"	HXBD1836L	\$784
23"	21"	35"	HXBD2136L	\$822
23"	24"	35"	HXBD2436L	\$847

Hinged Right

23"	12"	35"	HXBD1236R	\$732
23"	18"	35"	HXBD1836R	\$784
23"	21"	35"	HXBD2136R	\$822
23"	24"	35"	HXBD2436R	\$847
:	:	:	:	:

▶ Specification Information, continued on next page

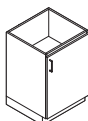
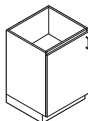

SIN 71.315

► Specification Information, continued from previous page

Specification Information

Dimensions			Style Number	Base Price
D	W	H		

Cabinets With Double Doors and One Adjustable Shelf

23"	30"	35"	HXBD3036	\$1005
23"	36"	35"	HXBD3636	\$1053

Cabinets with One Small Drawer, Single Door, and One Adjustable Shelf

Hinged Left

23"	12"	35"	HXBG1236L	\$ 944
23"	18"	35"	HXBG1836L	\$1023
23"	21"	35"	HXBG2136L	\$1083
23"	24"	35"	HXBG2436L	\$1117

Hinged Right

23"	12"	35"	HXBG1236R	\$ 944
23"	18"	35"	HXBG1836R	\$1023
23"	21"	35"	HXBG2136R	\$1083
23"	24"	35"	HXBG2436R	\$1117

Cabinets with One Small Drawer, Double Doors, and One Adjustable Shelf

23"	30"	35"	HXBG3036	\$1281
23"	36"	35"	HXBG3636	\$1339

Cabinets with Two Large Drawers

23"	12"	35"	HXBF1236	\$1225
23"	18"	35"	HXBF1836	\$1285
23"	21"	35"	HXBF2136	\$1320
23"	24"	35"	HXBF2436	\$1354
23"	30"	35"	HXBF3036	\$1404
23"	36"	35"	HXBF3636	\$1458

Cabinets with Two Small Drawers and One Large Drawer

23"	12"	35"	HXBC1236	\$1311
23"	18"	35"	HXBC1836	\$1408
23"	21"	35"	HXBC2136	\$1480
23"	24"	35"	HXBC2436	\$1524
23"	30"	35"	HXBC3036	\$1570
23"	36"	35"	HXBC3636	\$1628

► Specification Information, continued on next page

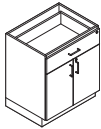
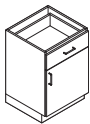
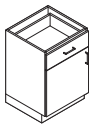
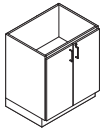

Folio 36"H Base Cabinets, continued

SIN 71.315

► Specification Information, continued from previous page

Specification Information

Dimensions			Style	Base
D	W	H	Number	Price



Cabinets with Four Small Drawers

23"	12"	35"	HXBR1236	\$1397
23"	18"	35"	HXBR1836	\$1531
23"	21"	35"	HXBR2136	\$1640
23"	24"	35"	HXBR2436	\$1694
23"	30"	35"	HXBR3036	\$1736
23"	36"	35"	HXBR3636	\$1798



Cabinets with Open Shelf and Two Small Drawers

23"	12"	35"	HXBN1236	\$1029
23"	18"	35"	HXBN1836	\$1116
23"	21"	35"	HXBN2136	\$1184
23"	24"	35"	HXBN2436	\$1224
23"	30"	35"	HXBN3036	\$1261
23"	36"	35"	HXBN3636	\$1309

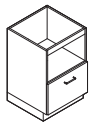

Cabinets with Open Shelf and One Large Drawer

23"	12"	35"	HXBL1236	\$ 943
23"	18"	35"	HXBL1836	\$ 993
23"	21"	35"	HXBL2136	\$1024
23"	24"	35"	HXBL2436	\$1054
23"	30"	35"	HXBL3036	\$1095
23"	36"	35"	HXBL3636	\$1139

Support End Panel

For 36"H Base Cabinets

SIN 71.315



Tip: An end panel must be attached to a worksurface. When ordering a worksurface for attachment to an end panel, the extended worksurface option must be specified. Worksurfaces are specified separately.

Tip: Height is for support end panel without worksurface attached.

Standard Includes **Required to Specify**

- Support end panel: melamine
- Edges: matching 1 mm plastic

- 1 Style number
- 2 Laminate color number for support end panel
- See *Surface Materials*, page 402.

Specification Information

Dimensions			Style	Price
D	W	H	Number	

22 ¹ / ₈ "	13 ¹ / ₁₆ "	35"	HXBE36	\$166
----------------------------------	-----------------------------------	-----	---------------	-------

Tip: Dimensions are for reference only. See shop drawings for actual measurements at village.steelcase.com.

Folio Sink Cabinets

SIN 71.315

Tip: ADA sink cabinets meet the guidelines as set forth in the United States Department of Justice 2010 ADA Standards for Accessible Design (www.ada.gov/2010adastandards). Floor to underside of cabinet clear dimension is 27"H.

Tip: Dimensions are for reference only. See shop drawings for actual measurements at village.steelcase.com.

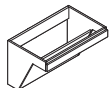

Tip: Height is for sink cabinet without worksurface.

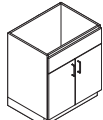
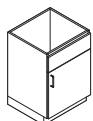
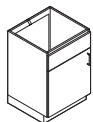
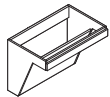

Standard Includes		Required to Specify	
	<ul style="list-style-type: none"> Sink cabinet: melamine D pull, if selected: nickel only Euro hinge, if selected: nickel only Edges: matching 3 mm plastic on doors and drawers and matching 1 mm plastic on all other edges Shelf pins Adjustable glides 		1 Style number 2 Laminate color number for sink cabinet 3 Options, if selected (see below) ▶ See <i>Surface Materials</i> , page 402.
Options	Price	Required to Specify	
Door Pulls	<ul style="list-style-type: none"> Contemporary: nickel only No cost Opus: champagne only +\$15 per pull Jazz: nickel only +\$17 per pull 	Specify with <i>contemporary pull</i> . Specify with <i>Opus pull</i> . Specify with <i>jazz pull</i> .	
Five-Knuckle Hinges	<ul style="list-style-type: none"> For cabinet with single door: nickel only +\$21 For cabinet with double doors: nickel only +\$42 	Specify with <i>five-knuckle hinge</i> . Specify with <i>five-knuckle hinge</i> .	
Lock and Keying	Lock <ul style="list-style-type: none"> 9201 Polished Chrome only +\$34 Keying <ul style="list-style-type: none"> Factory and field-installed keying 	Specify with <i>lock</i> . ▶ Page 440	
Related Products	<ul style="list-style-type: none"> Fillers for sink cabinets 	▶ Page 324	

Specification Information

Dimensions			Style	Base
D	W	H	Number	Price
:	:	:	:	:

Sink Cabinets with Angled Front

33"H ADA Sink Cabinet

22 ⁷ / ₈ "	36"	18 ³ / ₄ "	HXBK3633A	\$ 958
----------------------------------	-----	----------------------------------	------------------	--------

36"H Sink Cabinet

22 ¹⁵ / ₁₆ "	36"	21 ³ / ₄ "	HXBK3636	\$ 979
------------------------------------	-----	----------------------------------	-----------------	--------

Sink Cabinets with Single Door

Hinged Left

23"	24"	35"	HXBKD2436L	\$ 911
-----	-----	-----	-------------------	--------

Hinged Right

23"	24"	35"	HXBKD2436R	\$ 911
-----	-----	-----	-------------------	--------

Sink Cabinets with Double Doors

23"	30"	35"	HXBKD3036	\$1067
-----	-----	-----	------------------	--------

23"	36"	35"	HXBKD3636	\$1112
-----	-----	-----	------------------	--------

Folio 84"H Storage Cabinets

SIN 71.315

Standard Includes	Required to Specify
<ul style="list-style-type: none"> Storage cabinet, door fronts, and shelves: melamine D pull, if selected: nickel only Euro hinge, if selected: nickel only Edges: matching 3 mm plastic on doors and drawers and matching 1 mm plastic on all other edges Shelf pins Adjustable glides 	<ol style="list-style-type: none"> Style number Laminate color number for storage cabinet Options, if selected (see below) <ul style="list-style-type: none"> ▶ See <i>Surface Materials</i>, page 402.

Options	Price	Required to Specify
Door Pulls <ul style="list-style-type: none"> Contemporary: nickel only Opus: champagne only Jazz: nickel only 	No cost +\$15 per pull +\$17 per pull	Specify with <i>contemporary pull</i> . Specify with <i>Opus pull</i> . Specify with <i>jazz pull</i> .
Five-Knuckle Hinges <ul style="list-style-type: none"> For cabinet with single door: nickel only For cabinet with double doors: nickel only 	+\$42 +\$84	Specify with <i>five-knuckle hinge</i> . Specify with <i>five-knuckle hinge</i> .
Lock and Keying <ul style="list-style-type: none"> Lock <ul style="list-style-type: none"> 9201 Polished Chrome only Keying <ul style="list-style-type: none"> Factory and field-installed keying 	+\$34	Specify with <i>lock</i> . ▶ Page 440
Related Products <ul style="list-style-type: none"> Shelves for storage cabinets 		▶ Page 323

Tip: Additional shelves are available and must be specified separately.

Tip: One shelf is fixed at 36"H. All other shelves are adjustable.

Tip: Dimensions are for reference only. See shop drawings for actual measurements at village.steelcase.com.

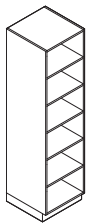

Specification Information				
Dimensions			Style	Base
D	W	H	Number	Price

Open Cabinets with Five Shelves

22 1/8"	12"	84"	HXCP1284	\$ 974
22 1/8"	18"	84"	HXCP1884	\$1169
22 1/8"	21"	84"	HXCP2184	\$1309
22 1/8"	24"	84"	HXCP2484	\$1449
22 1/8"	30"	84"	HXCP3084	\$1645
22 1/8"	36"	84"	HXCP3684	\$1870

▶ **Specification Information, continued on next page**

SIN 71.315

► Specification Information, continued from previous page

Specification Information

Dimensions			Style	Base
D	W	H	Number	Price

Cabinets with Single Door and Five Shelves

Hinged Left

23"	12"	84"	HXCD1284L	\$1201
23"	18"	84"	HXCD1884L	\$1440
23"	21"	84"	HXCD2184L	\$1615
23"	24"	84"	HXCD2484L	\$1791

Hinged Right

23"	12"	84"	HXCD1284R	\$1201
23"	18"	84"	HXCD1884R	\$1440
23"	21"	84"	HXCD2184R	\$1615
23"	24"	84"	HXCD2484R	\$1791

Cabinets with Double Doors and Five Shelves

23"	30"	84"	HXCD3084	\$2030
23"	36"	84"	HXCD3684	\$2315

Tip: Depth is 22 1/8" without doors.

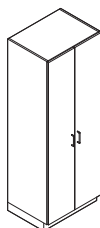
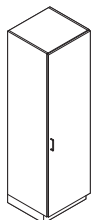

Folio 92"H Storage Cabinets with Sloped Top

SIN 71.315

Standard Includes	Required to Specify
<ul style="list-style-type: none"> Storage cabinet, sloped top, door fronts, and shelves: melamine D pull, if selected: nickel only Euro hinge, if selected: nickel only Edges: matching 3 mm plastic on doors and matching 1 mm plastic on all other edges Shelf pins Adjustable glides 	<ol style="list-style-type: none"> Style number Laminate color number for storage cabinet Options, if selected (see below) <ul style="list-style-type: none"> ▶ See <i>Surface Materials</i>, page 402.

Options	Price	Required to Specify
Door Pulls <ul style="list-style-type: none"> Contemporary: nickel only Opus: champagne only Jazz: nickel only 	No cost +\$15 per pull +\$17 per pull	Specify with <i>contemporary pull</i> . Specify with <i>Opus pull</i> . Specify with <i>jazz pull</i> .
Five-Knuckle Hinges <ul style="list-style-type: none"> For cabinet with single door: nickel only For cabinet with double doors: nickel only 	+\$42 +\$84	Specify with <i>five-knuckle hinge</i> . Specify with <i>five-knuckle hinge</i> .
Lock and Keying <ul style="list-style-type: none"> Lock <ul style="list-style-type: none"> 9201 Polished Chrome only Keying <ul style="list-style-type: none"> Factory and field-installed keying 	+\$34	Specify with <i>lock</i> . ▶ Page 440
Related Products <ul style="list-style-type: none"> Shelves for storage cabinets 		▶ Page 323

Tip: Additional shelves are available and must be specified separately.

Tip: One shelf is fixed at 36"H. All other shelves are adjustable.

Tip: Dimensions are for reference only. See shop drawings for actual measurements at village.steelcase.com.

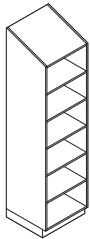

Specification Information				
Dimensions			Style	Base
D	W	H	Number	Price

Open Cabinets with Five Shelves

22 ¹ / ₈ "	12"	92"	HXCP1292S	\$1069
22 ¹ / ₈ "	18"	92"	HXCP1892S	\$1285
22 ¹ / ₈ "	21"	92"	HXCP2192S	\$1554
22 ¹ / ₈ "	24"	92"	HXCP2492S	\$1595
22 ¹ / ₈ "	30"	92"	HXCP3092S	\$1808
22 ¹ / ₈ "	36"	92"	HXCP3692S	\$2056

▶ Specification Information, continued on next page

► Specification Information, continued from previous page

Specification Information

Dimensions			Style	Base
D	W	H	Number	Price

Cabinets with Single Door and Five Shelves

Hinged Left

23"	12"	92"	HXCD1292LS	\$1322
23"	18"	92"	HXCD1892LS	\$1584
23"	21"	92"	HXCD2192LS	\$1776
23"	24"	92"	HXCD2492LS	\$1970

Hinged Right

23"	12"	92"	HXCD1292RS	\$1322
23"	18"	92"	HXCD1892RS	\$1584
23"	21"	92"	HXCD2192RS	\$1776
23"	24"	92"	HXCD2492RS	\$1970

Cabinets with Double Doors and Five Shelves

23"	30"	92"	HXCD3092S	\$2230
23"	36"	92"	HXCD3692S	\$2546

Tip: Depth is 22¹/₁₆" without doors.

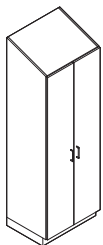
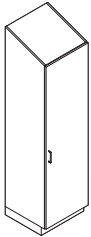
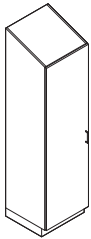

Folio 84"H Wardrobe Cabinets

SIN 71.315

Standard Includes	Required to Specify
<ul style="list-style-type: none"> Wardrobe, door fronts, and fixed shelf: melamine D pull, if selected: nickel only Euro hinge, if selected: nickel only Edges: matching 3 mm plastic on doors and matching 1 mm plastic on all other edges Adjustable glides Hanger bar: chrome 	<ol style="list-style-type: none"> Style number Laminate color number for wardrobe cabinet Options, if selected (see below) <ul style="list-style-type: none"> ▶ See <i>Surface Materials</i>, page 402.

Options	Price	Required to Specify
Door Pulls <ul style="list-style-type: none"> Contemporary: nickel only Opus: champagne only Jazz: nickel only 	No cost +\$15 per pull +\$17 per pull	Specify <i>with contemporary pull</i> . Specify <i>with Opus pull</i> . Specify <i>with jazz pull</i> .
Five-Knuckle Hinges <ul style="list-style-type: none"> For cabinet with single door: nickel only For cabinet with double doors: nickel only 	+\$42 +\$84	Specify <i>with five-knuckle hinge</i> . Specify <i>with five-knuckle hinge</i> .
Lock and Keying	Lock <ul style="list-style-type: none"> 9201 Polished Chrome only Keying <ul style="list-style-type: none"> Factory and field-installed keying 	+\$34 Specify <i>with lock</i> . ▶ Page 440

Tip: Dimensions are for reference only. See shop drawings for actual measurements at village.steelcase.com.

Tip: Depth is 22 1/16" without doors and drawer fronts.

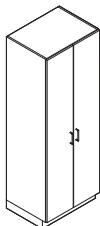
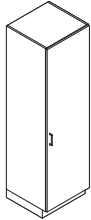
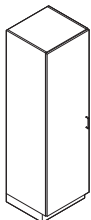

Specification Information				
Dimensions			Style	Base
D	W	H	Number	Price
:	:	:	:	:
:	:	:	:	:

Wardrobe Cabinets with Single Door and One Fixed Shelf

Hinged Left

23"	12"	84"	HXCW1284L	\$1068
23"	18"	84"	HXCW1884L	\$1248
23"	21"	84"	HXCW2184L	\$1387
23"	24"	84"	HXCW2484L	\$1523

Hinged Right

23"	12"	84"	HXCW1284R	\$1068
23"	18"	84"	HXCW1884R	\$1248
23"	21"	84"	HXCW2184R	\$1387
23"	24"	84"	HXCW2484R	\$1523

Wardrobe Cabinets with Double Doors and One Fixed Shelf

23"	30"	84"	HXCW3084	\$1705
23"	36"	84"	HXCW3684	\$1885

Folio

92"H Wardrobe Cabinets with Sloped Top

Folio
92"H Wardrobe
Cabinets with
Sloped Top

SIN 71.315

Standard Includes		Required to Specify	
	<ul style="list-style-type: none"> Wardrobe, sloped top, door fronts, and fixed shelf: melamine D pull, if selected: nickel only Euro hinge, if selected: nickel only Edges: matching 3 mm plastic on doors and matching 1 mm plastic on all other edges Adjustable glides Hanger bar: chrome 		<ul style="list-style-type: none"> 1 Style number 2 Laminate color number for wardrobe cabinet 3 Options, if selected (see below) ▶ See <i>Surface Materials</i>, page 402.
Options	Price	Required to Specify	
Door Pulls	<ul style="list-style-type: none"> Contemporary: nickel only Opus: champagne only Jazz: nickel only 	No cost +\$15 per pull +\$17 per pull	Specify with <i>contemporary pull</i> . Specify with <i>Opus pull</i> . Specify with <i>jazz pull</i> .
Five-Knuckle Hinges	<ul style="list-style-type: none"> For cabinet with single door: nickel only For cabinet with double doors: nickel only 	+\$42 +\$84	Specify with <i>five-knuckle hinge</i> . Specify with <i>five-knuckle hinge</i> .
Lock and Keying	Lock <ul style="list-style-type: none"> 9201 Polished Chrome only Keying <ul style="list-style-type: none"> Factory and field-installed keying 	+\$34	Specify with <i>lock</i> . ▶ Page 440

Specification Information

Dimensions			Style	Base
D	W	H	Number	Price
.
.

Wardrobe Cabinets with Single Door and One Fixed Shelf

Hinged Left

24"	12"	92"	HXCW1292LS	\$1175
24"	18"	92"	HXCW1892LS	\$1374
24"	21"	92"	HXCW2192LS	\$1524
24"	24"	92"	HXCW2492LS	\$1678

Hinged Right

24"	12"	92"	HXCW1292RS	\$1175
24"	18"	92"	HXCW1892RS	\$1374
24"	21"	92"	HXCW2192RS	\$1524
24"	24"	92"	HXCW2492RS	\$1678

Wardrobe Cabinets with Double Doors and One Fixed Shelf

24"	30"	92"	HXCW3092S	\$1875
24"	36"	92"	HXCW3692S	\$2075

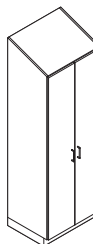
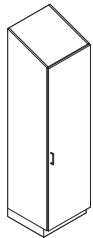
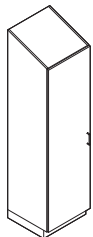

Folio 84"H Bookcases

SIN 71.315

Tip: One shelf is fixed at 36"H. All other shelves are adjustable.

Standard Includes	Required to Specify
<ul style="list-style-type: none"> Bookcase, door fronts, and shelves: melamine D pull, if selected: nickel only Euro hinge, if selected: nickel only Edges: matching 3 mm plastic on doors and matching 1 mm plastic on all other edges Shelf pins Adjustable glides 	<ol style="list-style-type: none"> Style number Laminate color number for bookcase Options, if selected (see below) <p>▶ See <i>Surface Materials</i>, page 402.</p>

Options	Price	Required to Specify
Door Pulls <ul style="list-style-type: none"> Contemporary: nickel only Opus: champagne only Jazz: nickel only 	No cost +\$15 per pull +\$17 per pull	Specify with <i>contemporary pull</i> . Specify with <i>Opus pull</i> . Specify with <i>jazz pull</i> .
Five-Knuckle Hinges <ul style="list-style-type: none"> For bookcase with single door: nickel only For bookcase with double doors: nickel only 	+\$42 +\$84	Specify with <i>five-knuckle hinge</i> . Specify with <i>five-knuckle hinge</i> .
Lock and Keying <p>Lock</p> <ul style="list-style-type: none"> 9201 Polished Chrome only <p>Keying</p> <ul style="list-style-type: none"> Factory and field-installed keying 	+\$34	Specify with <i>lock</i> . ▶ Page 440
Related Products <ul style="list-style-type: none"> Shelves for bookcases 		▶ Page 323

Tip: Additional shelves are available and must be specified separately.

Tip: Dimensions are for reference only. See shop drawings for actual measurements at village.steelcase.com.

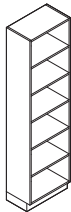

Specification Information				
Dimensions			Style	Base
D	W	H	Number	Price

Open Bookcase with Five Shelves				
13 ³ / ₈ "	12"	84"	HXCBP1284	\$ 826
13 ³ / ₈ "	18"	84"	HXCBP1884	\$ 992
13 ³ / ₈ "	21"	84"	HXCBP2184	\$1113
13 ³ / ₈ "	24"	84"	HXCBP2484	\$1232
13 ³ / ₈ "	30"	84"	HXCBP3084	\$1397
13 ³ / ₈ "	36"	84"	HXCBP3684	\$1590

▶ Specification Information, continued on next page

SIN 71.315

► Specification Information, continued from previous page

Specification Information

Dimensions			Style	Base
D	W	H	Number	Price

Bookcases with Single Door and Five Shelves

Hinged Left

14 1/4"	12"	84"	HXCBD1284L	\$1022
14 1/4"	18"	84"	HXCBD1884L	\$1225
14 1/4"	21"	84"	HXCBD2184L	\$1374
14 1/4"	24"	84"	HXCBD2484L	\$1521

Hinged Right

14 1/4"	12"	84"	HXCBD1284R	\$1022
14 1/4"	18"	84"	HXCBD1884R	\$1225
14 1/4"	21"	84"	HXCBD2184R	\$1374
14 1/4"	24"	84"	HXCBD2484R	\$1521

Bookcases with Double Doors and Five Shelves

14 1/4"	30"	84"	HXCBD3084	\$1723
14 1/4"	36"	84"	HXCBD3684	\$1969

Tip: Depth is 13 3/8" without doors and drawer fronts.

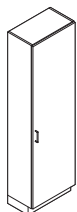

Folio 89"H Bookcases with Sloped Top

SIN 71.315

Tip: One shelf is fixed at 36"H. All other shelves are adjustable.

Standard Includes	Required to Specify
<ul style="list-style-type: none"> Bookcase, sloped top, door fronts, and shelves: melamine D pull, if selected: nickel only Euro hinge, if selected: nickel only Edges: matching 3 mm plastic on doors and matching 1 mm plastic on all other edges Shelf pins Adjustable glides 	<ol style="list-style-type: none"> Style number Laminate color number for bookcase Options, if selected (see below) <p>▶ See <i>Surface Materials</i>, page 402.</p>

Options	Price	Required to Specify
Door Pulls <ul style="list-style-type: none"> Contemporary: nickel only Opus: champagne only Jazz: nickel only 	No cost +\$15 per pull +\$17 per pull	Specify with <i>contemporary pull</i> . Specify with <i>Opus pull</i> . Specify with <i>jazz pull</i> .
Five-Knuckle Hinges <ul style="list-style-type: none"> For bookcase with single door: nickel only For bookcase with double doors: nickel only 	+\$42 +\$84	Specify with <i>five-knuckle hinge</i> . Specify with <i>five-knuckle hinge</i> .
Lock and Keying <p>Lock</p> <ul style="list-style-type: none"> 9201 Polished Chrome only <p>Keying</p> <ul style="list-style-type: none"> Factory and field-installed keying 	+\$34	Specify with <i>lock</i> . ▶ Page 440
Related Products <ul style="list-style-type: none"> Shelves for bookcases 		▶ Page 323

Tip: Additional shelves are available and must be specified separately.

Tip: Dimensions are for reference only. See shop drawings for actual measurements at village.steelcase.com.

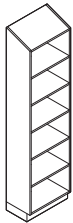

Specification Information				
Dimensions			Style	Base
D	W	H	Number	Price

Open Bookcase with Five Shelves

13 ³ / ₈ "	12"	88 ⁷ / ₈ "	HXCBP1289S	\$ 910
13 ³ / ₈ "	18"	88 ⁷ / ₈ "	HXCBP1889S	\$1092
13 ³ / ₈ "	21"	88 ⁷ / ₈ "	HXCBP2189S	\$1224
13 ³ / ₈ "	24"	88 ⁷ / ₈ "	HXCBP2489S	\$1354
13 ³ / ₈ "	30"	88 ⁷ / ₈ "	HXCBP3089S	\$1539
13 ³ / ₈ "	36"	88 ⁷ / ₈ "	HXCBP3689S	\$1749

▶ **Specification Information, continued on next page**

► Specification Information, continued from previous page

Specification Information

Dimensions			Style	Base
D	W	H	Number	Price

Bookcases with Single Door and Five Shelves

Hinged Left

14 1/4"	12"	88 7/8"	HXCBD1289LS	\$1122
14 1/4"	18"	88 7/8"	HXCBD1889LS	\$1347
14 1/4"	21"	88 7/8"	HXCBD2189LS	\$1511
14 1/4"	24"	88 7/8"	HXCBD2489LS	\$1674

Hinged Right

14 1/4"	12"	88 7/8"	HXCBD1289RS	\$1122
14 1/4"	18"	88 7/8"	HXCBD1889RS	\$1347
14 1/4"	21"	88 7/8"	HXCBD2189RS	\$1511
14 1/4"	24"	88 7/8"	HXCBD2489RS	\$1674

Bookcases with Double Doors and Five Shelves

14 1/4"	30"	88 7/8"	HXCBD3089S	\$1896
14 1/4"	36"	88 7/8"	HXCBD3689S	\$2166

Tip: Depth is 13 3/8" without doors and drawer fronts.

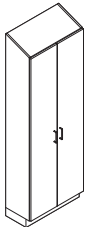
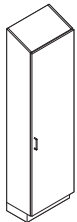

Folio Upper Storage Cabinets

SIN 71.315

Tip: Shelves in open upper storage cabinet are adjustable.

Standard Includes	Required to Specify
<ul style="list-style-type: none"> Upper storage cabinet, door fronts, and shelves: melamine D pull, if selected: nickel only Euro hinge, if selected: nickel only Edges: matching 3 mm plastic on doors and matching 1 mm plastic on all other edges Wall attachment brackets Shelf pins 	<ol style="list-style-type: none"> Style number Laminate color number for upper storage cabinet Options, if selected (see below) <ul style="list-style-type: none"> ▶ See <i>Surface Materials</i>, page 402.

Options	Price	Required to Specify
Door Pulls <ul style="list-style-type: none"> Contemporary: nickel only Opus: champagne only Jazz: nickel only 	No cost +\$15 per pull +\$17 per pull	Specify with <i>contemporary pull</i> . Specify with <i>Opus pull</i> . Specify with <i>jazz pull</i> .
Five-Knuckle Hinges <ul style="list-style-type: none"> For cabinet with single door: nickel only For cabinet with double doors: nickel only 	+\$21 +\$42	Specify with <i>five-knuckle hinge</i> . Specify with <i>five-knuckle hinge</i> .
Lock and Keying <p>Lock</p> <ul style="list-style-type: none"> 9201 Polished Chrome only <p>Keying</p> <ul style="list-style-type: none"> Factory and field-installed keying 	+\$34	Specify with <i>lock</i> . ▶ Page 440
Related Products <ul style="list-style-type: none"> Shelves for upper storage cabinets Fillers for upper storage cabinets 		▶ Page 323 ▶ Page 324

Tip: Dimensions are for reference only. See shop drawings for actual measurements at village.steelcase.com.



Specification Information

Dimensions			Style	Number	Base
D	W	H	Number	of Shelves	Price
Open Upper Storage Cabinets					
13 ³ / ₈ "	12"	24"	HXUP1224	1	\$273
13 ³ / ₈ "	18"	24"	HXUP1824	1	\$337
13 ³ / ₈ "	21"	24"	HXUP2124	1	\$365
13 ³ / ₈ "	24"	24"	HXUP2424	1	\$394
13 ³ / ₈ "	30"	24"	HXUP3024	1	\$459
13 ³ / ₈ "	36"	24"	HXUP3624	1	\$544
13 ³ / ₈ "	12"	30"	HXUP1230	2	\$300
13 ³ / ₈ "	18"	30"	HXUP1830	2	\$366
13 ³ / ₈ "	21"	30"	HXUP2130	2	\$400
13 ³ / ₈ "	24"	30"	HXUP2430	2	\$431
13 ³ / ₈ "	30"	30"	HXUP3030	2	\$503
13 ³ / ₈ "	36"	30"	HXUP3630	2	\$592

▶ **Specification Information, continued on next page**

SIN 71.315

► Specification Information, continued from previous page

Specification Information

Dimensions			Style Number	Number of Shelves	Base Price
D	W	H			

Upper Storage Cabinets with Single Door

Hinged Left

14 1/4"	12"	24"	HXUD1224L	1	\$417
14 1/4"	18"	24"	HXUD1824L	1	\$518
14 1/4"	21"	24"	HXUD2124L	1	\$564
14 1/4"	12"	30"	HXUD1230L	2	\$460
14 1/4"	18"	30"	HXUD1830L	2	\$571
14 1/4"	21"	30"	HXUD2130L	2	\$619

Hinged Right

14 1/4"	12"	24"	HXUD1224R	1	\$417
14 1/4"	18"	24"	HXUD1824R	1	\$518
14 1/4"	21"	24"	HXUD2124R	1	\$564
14 1/4"	12"	30"	HXUD1230R	2	\$460
14 1/4"	18"	30"	HXUD1830R	2	\$571
14 1/4"	21"	30"	HXUD2130R	2	\$619

Upper Storage Cabinets with Double Doors

14 1/4"	24"	24"	HXUD2424	1	\$605
14 1/4"	30"	24"	HXUD3024	1	\$692
14 1/4"	36"	24"	HXUD3624	1	\$804
14 1/4"	24"	30"	HXUD2430	2	\$664
14 1/4"	30"	30"	HXUD3030	2	\$761
14 1/4"	36"	30"	HXUD3630	2	\$883

Upper Storage Cabinets with Single Door and Open Shelf

Hinged Left

14 1/4"	12"	30"	HXUDP1230L	1	\$483
14 1/4"	18"	30"	HXUDP1830L	1	\$599
14 1/4"	21"	30"	HXUDP2130L	1	\$649

Hinged Right

14 1/4"	12"	30"	HXUDP1230R	1	\$483
14 1/4"	18"	30"	HXUDP1830R	1	\$599
14 1/4"	21"	30"	HXUDP2130R	1	\$649

Upper Storage Cabinets with Double Doors and Open Shelf

14 1/4"	24"	30"	HXUDP2430	1	\$698
14 1/4"	30"	30"	HXUDP3030	1	\$798
14 1/4"	36"	30"	HXUDP3630	1	\$927



Tip: Shelves behind full doors are adjustable.



Tip: Shelves on upper storage cabinets with single or double doors and open shelf are fixed.



Folio Upper Storage Cabinets with Sloped Top

SIN 71.315

Tip: Shelves in open upper storage cabinet are adjustable.

Standard Includes	Required to Specify
<ul style="list-style-type: none"> Upper storage cabinet, sloped top, door fronts, and shelves: melamine D pull, if selected: nickel only Euro hinge, if selected: nickel only Edges: matching 3 mm plastic on doors and matching 1 mm plastic on all other edges Wall attachment brackets Shelf pins 	<ol style="list-style-type: none"> Style number Laminate color number for upper storage cabinet Options, if selected (see below) <ul style="list-style-type: none"> ▶ See <i>Surface Materials</i>, page 402.

Options	Price	Required to Specify
Door Pulls <ul style="list-style-type: none"> Contemporary: nickel only Opus: champagne only Jazz: nickel only 	No cost +\$15 per pull +\$17 per pull	Specify with <i>contemporary pull</i> . Specify with <i>Opus pull</i> . Specify with <i>jazz pull</i> .
Five-Knuckle Hinges <ul style="list-style-type: none"> For cabinet with single door: nickel only For cabinet with double doors: nickel only 	+\$21 +\$42	Specify with <i>five-knuckle hinge</i> . Specify with <i>five-knuckle hinge</i> .
Lock and Keying <ul style="list-style-type: none"> Lock <ul style="list-style-type: none"> 9201 Polished Chrome only Keying <ul style="list-style-type: none"> Factory and field-installed keying 	+\$34	Specify with <i>lock</i> . ▶ Page 440
Related Products <ul style="list-style-type: none"> Shelves for upper storage cabinets Fillers for upper storage cabinets 		▶ Page 323 ▶ Page 324

Tip: Dimensions are for reference only. See shop drawings for actual measurements at village.steelcase.com.

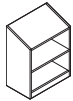

Specification Information					
Dimensions			Style	Number	Base
D	W	H	Number	of Shelves	Price

Open Upper Storage Cabinets

13 ³ / ₈ "	12"	28 ⁷ / ₈ "	HXUP1229S	1	\$298
13 ³ / ₈ "	18"	28 ⁷ / ₈ "	HXUP1829S	1	\$371
13 ³ / ₈ "	21"	28 ⁷ / ₈ "	HXUP2129S	1	\$402
13 ³ / ₈ "	24"	28 ⁷ / ₈ "	HXUP2429S	1	\$432
13 ³ / ₈ "	30"	28 ⁷ / ₈ "	HXUP3029S	1	\$504
13 ³ / ₈ "	36"	28 ⁷ / ₈ "	HXUP3629S	1	\$601
13 ³ / ₈ "	12"	28 ⁷ / ₈ "	HXUP1235S	2	\$330
13 ³ / ₈ "	18"	28 ⁷ / ₈ "	HXUP1835S	2	\$403
13 ³ / ₈ "	21"	28 ⁷ / ₈ "	HXUP2135S	2	\$439
13 ³ / ₈ "	24"	28 ⁷ / ₈ "	HXUP2435S	2	\$474
13 ³ / ₈ "	30"	28 ⁷ / ₈ "	HXUP3035S	2	\$555
13 ³ / ₈ "	36"	28 ⁷ / ₈ "	HXUP3635S	2	\$651

▶ Specification Information, continued on next page

► Specification Information, continued from previous page

Specification Information

Dimensions			Style Number	Number of Shelves	Base Price
D	W	H			

Upper Storage Cabinets with Single Door

Hinged Left

14¼"	12"	28⅞"	HXUD1229LS	1	\$ 460
14¼"	18"	28⅞"	HXUD1829LS	1	\$ 571
14¼"	21"	28⅞"	HXUD2129LS	1	\$ 619
14¼"	12"	28⅞"	HXUD1235LS	2	\$ 506
14¼"	18"	28⅞"	HXUD1835LS	2	\$ 628
14¼"	21"	28⅞"	HXUD2135LS	2	\$ 682

Hinged Right

14¼"	12"	28⅞"	HXUD1229RS	1	\$ 460
14¼"	18"	28⅞"	HXUD1829RS	1	\$ 571
14¼"	21"	28⅞"	HXUD2129RS	1	\$ 619
14¼"	12"	28⅞"	HXUD1235RS	2	\$ 506
14¼"	18"	28⅞"	HXUD1835RS	2	\$ 628
14¼"	21"	28⅞"	HXUD2135RS	2	\$ 682

Upper Storage Cabinets with Double Doors

14¼"	24"	28⅞"	HXUD2429S	1	\$ 664
14¼"	30"	28⅞"	HXUD3029S	1	\$ 761
14¼"	36"	28⅞"	HXUD3629S	1	\$ 883
14¼"	24"	28⅞"	HXUD2435S	2	\$ 732
14¼"	30"	28⅞"	HXUD3035S	2	\$ 836
14¼"	36"	28⅞"	HXUD3635S	2	\$ 972

Upper Storage Cabinets with Single Door and Open Shelf

Hinged Left

14¼"	12"	34⅞"	HXUDP1235LS	1	\$ 531
14¼"	18"	34⅞"	HXUDP1835LS	1	\$ 659
14¼"	21"	34⅞"	HXUDP2135LS	1	\$ 715

Hinged Right

14¼"	12"	34⅞"	HXUDP1235RS	1	\$ 531
14¼"	18"	34⅞"	HXUDP1835RS	1	\$ 659
14¼"	21"	34⅞"	HXUDP2135RS	1	\$ 715

Upper Storage Cabinets with Double Doors and Open Shelf

14¼"	24"	34⅞"	HXUDP2435S	1	\$ 767
14¼"	30"	34⅞"	HXUDP3035S	1	\$ 879
14¼"	36"	34⅞"	HXUDP3635S	1	\$1021

Tip: Depth is 13⅜" without doors and drawer fronts.

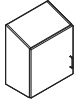

Tip: Shelves behind full doors are adjustable.

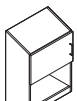
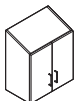

Tip: Shelves on upper storage cabinets with single or double doors and open shelf are fixed.

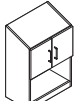
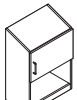

Folio Laminate Worksurfaces

SIN 71.315

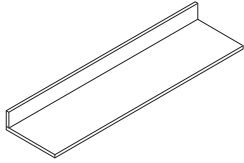

Standard Includes	Required to Specify
<ul style="list-style-type: none"> Standard length laminate worksurface with backsplash: laminate Edge band: 3 mm plastic on front and 1 mm plastic on sides, back, and all backsplash edges 	<ol style="list-style-type: none"> Style number Laminate color number for worksurface and backsplash Plastic color number for edge on worksurface Options, if selected (see below) <p>▶ See <i>Surface Materials</i>, page 402.</p>

Options	Price	Required to Specify
Surface Materials <ul style="list-style-type: none"> Steelcase Health laminate Steelcase laminate Open Line laminate 	No cost No cost +\$69 plus the cost of laminate	<p>▶ See <i>Surface Materials</i>, page 402.</p> <p>▶ See <i>Surface Materials</i>, page 402.</p> <p>▶ See <i>Surface Materials</i>, page 402.</p>
Extended Worksurface <ul style="list-style-type: none"> Extended worksurface 	No cost	Specify with extended worksurface.

Tip: Extended worksurface option adds 1³/₁₆" length to worksurface for use with one end panel.

Tip: 12"W, 18"W, 21"W, and 120"W worksurfaces are not available with the extended worksurface option.

Tip: Worksurfaces must be attached to base cabinets or desk frames.

Tip: Dimensions are for reference only. See shop drawings for actual measurements at village.steelcase.com.

Specification Information		
Dimensions	Style	Base
D W	Number	Price

Laminate Worksurfaces with 4" Backsplash

24"	12"	HXW1224L	\$260
24"	18"	HXW1824L	\$278
24"	21"	HXW2124L	\$294
24"	24"	HXW2424L	\$312
24"	27"	HXW2724L	\$328
24"	30"	HXW3024L	\$344
24"	33"	HXW3324L	\$362
24"	36"	HXW3624L	\$379
24"	39"	HXW3924L	\$395
24"	42"	HXW4224L	\$413
24"	45"	HXW4524L	\$428
24"	48"	HXW4824L	\$446
24"	51"	HXW5124L	\$463
24"	54"	HXW5424L	\$480
24"	60"	HXW6024L	\$496
24"	66"	HXW6624L	\$525
24"	72"	HXW7224L	\$552
24"	78"	HXW7824L	\$581
24"	84"	HXW8424L	\$608
24"	90"	HXW9024L	\$637
24"	96"	HXW9624L	\$664
24"	102"	HXW10224L	\$693
24"	108"	HXW10824L	\$720
24"	114"	HXW11424L	\$748
24"	120"	HXW12024L	\$776

Folio 4"H Laminate Sidesplash

SIN 71.315



Tip: Overall length of 21"D sidesplash is intended to be used adjacent to tall cabinets.

Tip: Dimensions are for reference only. See shop drawings for actual measurements at village.steelcase.com.

Standard Includes	Required to Specify
-------------------	---------------------

- Laminate sidesplash: laminate
- Edge band: 1 mm plastic

- 1 Style number
 - 2 Laminate color number for sidesplash
 - 3 Plastic color number for edge on sidesplash
 - 4 Options, if selected (see below)
- ▶ See *Surface Materials*, page 402.

Options	Price	Required to Specify
---------	-------	---------------------

Surface Materials

- Laminate
- Steelcase laminate
- Open Line laminate

No cost
No cost
+\$23
plus the cost of laminate

- ▶ See *Surface Materials*, page 402.
- ▶ See *Surface Materials*, page 402.
- ▶ See *Surface Materials*, page 402.

Specification Information			
Dimensions		Style	Base
D	W	Number	Price

21"	4"	HXWS421L	\$56
24"	4"	HXWS424L	\$64



Folio Solid Surface Worksurfaces

SIN 71.315

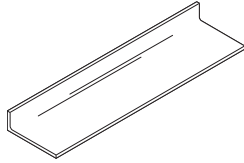

Tip: Extended work surface option adds 1³/₁₆" length to work surface for use with one end panel.

Tip: 12"W, 18"W, 21"W, and 120"W work surfaces are not available with the extended work surface option.

Tip: Worksurfaces must be attached to base cabinets or desk frames.

Tip: Dimensions are for reference only. See shop drawings for actual measurements at village.steelcase.com.

Standard Includes	Required to Specify
<ul style="list-style-type: none"> Solid surface work surface with integrated backsplash 	<ol style="list-style-type: none"> Style number Solid surface color number for work surface and backsplash Options, if selected (see below) <p>▶ See <i>Surface Materials</i>, page 402.</p>

Options	Price	Required to Specify
Extended Worksurface <ul style="list-style-type: none"> Extended work surface 	No cost	Specify with extended work surface.

Specification Information

Dimensions		Style Number	Prices			
D	W		Price Group A	Price Group B	Price Group C	Price Group D

Solid Surface Worksurfaces with Integrated Backsplash

24"	12"	HXW1224S	\$ 604	\$ 651	\$ 669	\$ 745
24"	18"	HXW1824S	\$ 642	\$ 692	\$ 711	\$ 793
24"	21"	HXW2124S	\$ 681	\$ 733	\$ 755	\$ 841
24"	24"	HXW2424S	\$ 714	\$ 770	\$ 791	\$ 882
24"	27"	HXW2724S	\$ 769	\$ 828	\$ 852	\$ 948
24"	30"	HXW3024S	\$ 821	\$ 886	\$ 909	\$1014
24"	33"	HXW3324S	\$ 977	\$1045	\$1071	\$1182
24"	36"	HXW3624S	\$1035	\$1108	\$1134	\$1252
24"	39"	HXW3924S	\$1096	\$1173	\$1203	\$1325
24"	42"	HXW4224S	\$1154	\$1235	\$1265	\$1396
24"	45"	HXW4524S	\$1214	\$1299	\$1330	\$1468
24"	48"	HXW4824S	\$1273	\$1361	\$1394	\$1538
24"	51"	HXW5124S	\$1331	\$1424	\$1457	\$1611
24"	54"	HXW5424S	\$1392	\$1488	\$1526	\$1682
24"	60"	HXW6024S	\$1522	\$1629	\$1668	\$1841
24"	66"	HXW6624S	\$1654	\$1769	\$1813	\$1998
24"	72"	HXW7224S	\$1786	\$1909	\$1957	\$2159
24"	78"	HXW7824S	\$1961	\$2098	\$2151	\$2371
24"	84"	HXW8424S	\$2134	\$2284	\$2339	\$2581
24"	90"	HXW9024S	\$2307	\$2468	\$2528	\$2789
24"	96"	HXW9624S	\$2481	\$2654	\$2718	\$3000
24"	102"	HXW10224S	\$2656	\$2839	\$2911	\$3211
24"	108"	HXW10824S	\$2829	\$3027	\$3099	\$3421
24"	114"	HXW11424S	\$2968	\$3175	\$3253	\$3590
24"	120"	HXW12024S	\$3107	\$3324	\$3405	\$3757

Folio 4"H Solid Surface Sidesplash

Folio
4"H Solid Surface
Sidesplash

SIN 71.315

Tip: Overall length of 21"D sidesplash is intended to be used adjacent to tall cabinets.

Tip: Dimensions are for reference only. See shop drawings for actual measurements at village.steelcase.com.



Standard Includes	Required to Specify
<ul style="list-style-type: none"> Solid surface sidesplash 	<ul style="list-style-type: none"> 1 Style number 2 Solid surface color number for sidesplash ▶ See <i>Surface Materials</i>, page 402.

Specification Information

Dimensions		Style Number	Prices			
D	W		Price Group A	Price Group B	Price Group C	Price Group D

Left-Hand Sidesplash

21"	4"	HXWS421LS	\$157	\$168	\$173	\$194
24"	4"	HXWS424LS	\$179	\$190	\$195	\$216
:	:	:	:	:	:	:

Right-Hand Sidesplash

21"	4"	HXWS421RS	\$157	\$168	\$173	\$194
24"	4"	HXWS424RS	\$179	\$190	\$195	\$216
:	:	:	:	:	:	:

Folio Desk Frames

For Use with Common Tops

SIN 71.315

Standard Includes	Required to Specify
<ul style="list-style-type: none"> • Desk frame without back panel, if selected: melamine • Desk frame, back panel, and side panel, if selected: melamine • Door, if selected: melamine • D pull, if door option selected: nickel only • Euro hinge, if door option selected: nickel only 	<ol style="list-style-type: none"> 1 Style number 2 Laminate color number for desk frame, and back panel 3 Options, if selected (see below) <ul style="list-style-type: none"> ▶ See <i>Surface Materials</i>, page 402.

Tip: If door option is selected, door color will default to match desk frame.

Tip: When door option is specified, a garage application is created.

Tip: Door pulls may only be specified when door option has been specified.

Tip: Five-knuckle hinge may only be specified when door option has been specified.

Options	Price	Required to Specify
Door		
• Left hand door for use on 24"W desk frame with back panel only	+\$122	Specify with left hand door.
• Right hand door for use on 24"W desk frame with back panel only	+\$122	Specify with right hand door.
• Double doors for use on 30"W and 36"W desk frame with back panel only	+\$244	Specify with double doors.
Door Pulls		
• Contemporary: nickel only	No cost	Specify with contemporary pull.
• Opus: champagne only	+\$ 15 per pull	Specify with Opus pull.
• Jazz: nickel only	+\$ 17 per pull	Specify with jazz pull.
Five-Knuckle Hinges		
• For desk frames with one door: nickel only	+\$ 21	Specify with five-knuckle hinge.
• For desk frames with double doors: nickel only	+\$ 42	Specify with five-knuckle hinge.
Related Products		
• Storage cabinets		▶ Page 304
• Wardrobes		▶ Page 308
• Base cabinets		▶ Page 294
• Worksurfaces		▶ Page 318

Tip: Dimensions are for reference only. See shop drawings for actual measurements at village.steelcase.com.

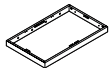

Tip: Desk frames must be attached to adjacent 24"D cabinet or structural wall.

Tip: Desk frames must be attached to worksurface. Specify worksurfaces separately.

Tip: 31"H desk frames are to be used with 36"H base cabinets or end panels. Not to be used in freestanding applications.

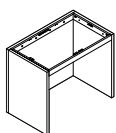

Specification Information					
Dimensions			Style		Base
D	W	H	Number	Price	

Desk Frames without Back Panel for use with Common Top

22 1/8"	12"	2 1/2"	HXDF1224	\$188
22 1/8"	18"	2 1/2"	HXDF1824	\$192
22 1/8"	24"	2 1/2"	HXDF2424	\$197
22 1/8"	30"	2 1/2"	HXDF3024	\$202
22 1/8"	36"	2 1/2"	HXDF3624	\$208
22 1/8"	42"	2 1/2"	HXDF4224	\$217
22 1/8"	48"	2 1/2"	HXDF4824	\$222
22 1/8"	54"	2 1/2"	HXDF5424	\$230
22 1/8"	60"	2 1/2"	HXDF6024	\$235
22 1/8"	72"	2 1/2"	HXDF7224	\$240

Desk Frames with Back Panel for use with Common Top

22 1/8"	24"	31 1/4"	HXDFB2424	\$744
22 1/8"	30"	31 1/4"	HXDFB3024	\$811
22 1/8"	36"	31 1/4"	HXDFB3624	\$833

Folio Accessories

SIN 71.315

Storage Shelves

Tip: Dimensions are for reference only. See shop drawings for actual measurements at village.steelcase.com.



Tip: For use with base cabinets only.



Tip: For use with storage cabinets only.



Tip: For use with bookcases only.



Tip: For use with upper storage cabinets only.

Standard Includes	Required to Specify
<ul style="list-style-type: none"> Shelves: melamine Edges: matching 3 mm plastic on fronts and matching 1mm plastic on sides and back Shelf pins 	<ul style="list-style-type: none"> 1 Style number 2 Laminate color number for shelf ▶ See <i>Surface Materials</i>, page 402.

Specification Information

Dimensions D W	Style Number	Price
------------------------	-----------------	-------

Shelves for Base Cabinets

21 1/4"	12"	HXBS1224	\$ 56
21 1/4"	18"	HXBS1824	\$ 64
21 1/4"	21"	HXBS2124	\$ 67
21 1/4"	24"	HXBS2424	\$ 70
21 1/4"	30"	HXBS3024	\$ 78
21 1/4"	36"	HXBS3624	\$ 84

Shelves for Storage Cabinets

21 1/4"	12"	HXCS1224	\$ 69
21 1/4"	18"	HXCS1824	\$ 79
21 1/4"	21"	HXCS2124	\$ 84
21 1/4"	24"	HXCS2424	\$ 89
21 1/4"	30"	HXCS3024	\$ 99
21 1/4"	36"	HXCS3624	\$108

Shelves for Bookcases

12 1/2"	12"	HXCBS1214	\$ 58
12 1/2"	18"	HXCBS1814	\$ 67
12 1/2"	21"	HXCBS2114	\$ 70
12 1/2"	24"	HXCBS2414	\$ 74
12 1/2"	30"	HXCBS3014	\$ 82
12 1/2"	36"	HXCBS3614	\$ 89

Shelves for Upper Storage Cabinets

11 13/16"	12"	HXUS1214	\$ 58
11 13/16"	18"	HXUS1814	\$ 67
11 13/16"	21"	HXUS2114	\$ 70
11 13/16"	24"	HXUS2414	\$ 75
11 13/16"	30"	HXUS3014	\$ 83
11 13/16"	36"	HXUS3614	\$ 91

SIN 71.315

Fillers

Tip: Fillers close the gap between a cabinet and structural wall. Field cutting of filler may be required to achieve architectural fit.

Tip: Dimensions are for reference only. See shop drawings for actual measurements at village.steelcase.com.



Tip: Filler should be used with flat upper storage cabinets.

Standard Includes	Required to Specify
<ul style="list-style-type: none"> • Filler: melamine 	<ul style="list-style-type: none"> 1 Style number 2 Laminate color number for filler ▶ See <i>Surface Materials</i>, page 402.

Specification Information

• Dimensions		• Style	• Price
D	H	Number	
.....

Fillers for Use with Base or Sink Cabinets

6"	26 ¹⁵ / ₁₆ "	HXFB628	\$111
6"	31 ¹ / ₂ "	HXFB633	\$111
6"	34 ¹ / ₂ "	HXFB636	\$111
.....

Fillers for Use with Storage Cabinets

22 ¹ / ₈ "	83 ¹ / ₂ "	HXFCWB684S	\$220
13 ³ / ₈ "	83 ¹ / ₂ "	HXFCWB684	\$220
.....

Filler for Use with Wardrobe Cabinets

21 ⁷ / ₈ "	91 ⁷ / ₁₆ "	HXFCW692	\$220
.....

Filler for Use with Bookcases

13 ³ / ₈ "	88 ³ / ₈ "	HXFCB689	\$220
.....

Fillers for Use with Upper Storage Cabinets

6"	24"	HXFU624	\$108
6"	30"	HXFU630	\$108
.....

▶ **Specification Information, continued on next page**

► Specification Information, continued from previous page

Specification Information

Dimensions		Style	Price
D	H	Number	

Fillers for Use with Sloped Upper Storage Cabinets

6"	29"	HXFU629	\$108
6"	35"	HXFU635	\$108
5¾"	35"	HXFB636	\$111

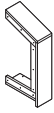

Plastic Drawer Liners

Standard Includes **Required to Specify**

- Package of four plastic drawer liners: white only
- Style number

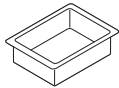

Tip: Dimensions are for reference only. See shop drawings for actual measurements at village.steelcase.com.

Specification Information

Dimensions	Style	Price
W	Number	

12"	HXADL12	\$144
18"	HXADL18	\$147
21"	HXADL21	\$150
24"	HXADL24	\$175
30"	HXADL30	\$179
36"	HXADL36	\$182

Mounting Board

Standard Includes **Required to Specify**

- Mounting board: melamine
- Edges: 1 mm plastic
- Attachment hardware
- 1 Style number
- 2 Laminate color number for mounting board
- 3 Edge band color number for mounting board
- 4 Options, if selected (see below)
- See *Surface Materials*, page 402.

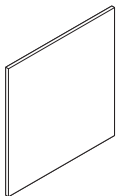

Tip: Dimensions are for reference only. See shop drawings for actual measurements at village.steelcase.com.

Options **Price** **Required to Specify**

Surface Materials	• Laminate • Open Line laminate	No cost +\$23	► See <i>Surface Materials</i> , page 402. ► See <i>Surface Materials</i> , page 402.
--------------------------	------------------------------------	------------------	--

Specification Information

Dimensions		Style	Base
W	H	Number	Price

34"	36"	HXAB3436	\$157
-----	-----	-----------------	-------

Folio

SIN 71.315

Stainless Steel Sinks

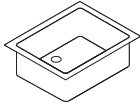

Tip: RFQ templates and answers to all your questions can be obtained by contacting Lab Crafters at Steelcase@labcrafters.com.

Tip: Dimensions are for reference only. See shop drawings for actual measurements at village.steelcase.com.

Standard Includes	Required to Specify
<ul style="list-style-type: none"> • Sink • Crumb cup strainer • Undermount sink, if selected, includes the sink supports 	Style number

Specification Information

• Dimensions			• Style
D	W	H	Number

Drop-in Stainless Steel Topmount Sinks

14"	18"	7½"	S-1721-A-GR-KIT
14"	14"	10½"	SX-1717-A-GR-KIT
14"	16"	10½"	SX-1719-A-GR-KIT

ADA Compliant Stainless Steel Drop-in Sink

14"	18"	5"	S-ADA-1721-A-GR-KIT

Undermount Stainless Steel Sinks

14"	18"	7½"	US-1620-A-KIT
14"	14"	10½"	USX-1616-A-KIT
14"	16"	10½"	USX-1618-A-KIT

ADA Compliant Stainless Steel Undermount Sink

14"	18"	5"	US-ADA-1620-A-KIT

Wall-Mounted Folio

► For more detailed product information, see the Steelcase Health Seating and Caseloads Specification Guides, or consult your Steelcase dealer.



Statement of Line

328



Specifying

Wall-Mounted 24"H Base Cabinets (SIN 71.315)	331
Wall-Mounted Sink Cabinets (SIN 71.315)	332
Wall-Mounted 73"H Wardrobe Cabinets (SIN 71.315)	333
Wall-Mounted 79"H Wardrobe Cabinets with Sloped Top (SIN 71.315)	334
Wall-Mounted 73"H Bookcases (SIN 71.315)	335
Wall-Mounted 79"H Bookcases with Sloped Top (SIN 71.315)	336
Wall-Mounted Laminate Worksurfaces (SIN 71.315)	337
Wall-Mounted 4"H Laminate Sidesplash (SIN 71.315)	338
Wall-Mounted Solid Surface Worksurfaces (SIN 71.315)	339
Wall-Mounted 4"H Solid Surface Sidesplash (SIN 71.315)	340
Wall-Mounted Desk Frames (SIN 71.315)	341
Wall-Mounted Accessories (SIN 71.315)	342

Statement of Line

Wall-Mounted Folio

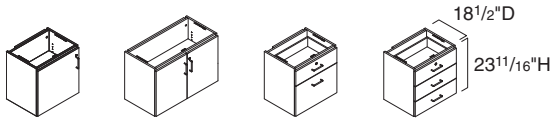

Specifying
▶ Page 331

Wall-Mounted 24"H Base Cabinets

	18"W	24"W	36"W
With single door and one adjustable shelf	●	●	
With double doors and one adjustable shelf			●
With one small drawer and one large drawer	●	●	
With three small drawers	●	●	

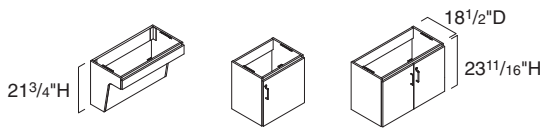

Specifying
▶ Page 332

Wall-Mounted Sink Cabinets

	24"W	36"W
Sink cabinet with angled front		●
24"H with single door	●	
24"H with double doors		●

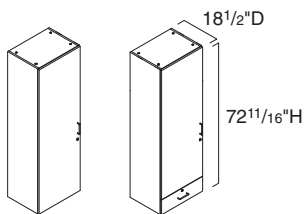

Specifying
▶ Page 333

Wall-Mounted 73"H Wardrobe Cabinets

	24"W
With single door and one fixed shelf	●
With single door, one fixed shelf, and small drawer	●

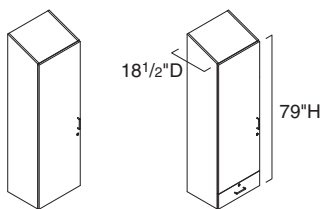

Specifying
▶ Page 334

Wall-Mounted 79"H Wardrobe Cabinets with Sloped Top

	24"W
With sloped top, single door, and one fixed shelf	●
With sloped top, single door, one fixed shelf, and small drawer	●

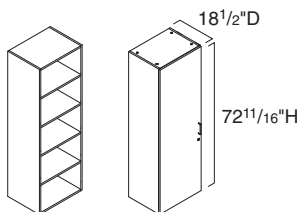

Specifying
▶ Page 335

Wall-Mounted 73"H Bookcases

	24"W
Open with five shelves	●
With single door and five shelves	●

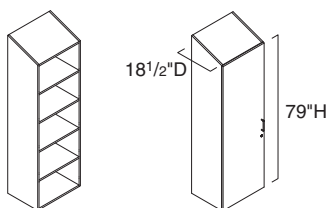

Specifying
▶ Page 336

Wall-Mounted 79"H Bookcases with Sloped Top

	24"W
Open with five shelves	●
With single door and five shelves	●

Statement of Line Wall-Mounted Folio, continued

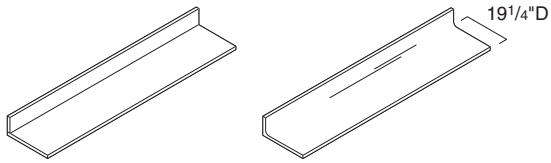

Specifying
▶ Pages 337 and 339

Wall-Mounted Worksurfaces

	18"W	24"W	36"W	42"W	48"W	60"W	72"W
18"D Laminate worksurfaces with 4"H backsplash	●	●	●	●	●	●	●
18"D Solid surface worksurfaces with integrated backsplash	●	●	●	●	●	●	●

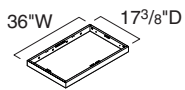

Specifying
▶ Page 341

Wall-Mounted Desk Frames

	18"W	24"W	36"W	42"W	48"W	60"W	72"W
18"D without back panel for use with common top	●	●	●	●	●	●	●

Folio Wall-Mounted 24"H Base Cabinets

Folio
Wall-Mounted 24"H
Base Cabinets

SIN 71.315

Standard Includes	Required to Specify
-------------------	---------------------

- Base cabinet, door and drawer fronts, and shelves: melamine
- D pull, if selected: nickel only
- Euro hinge, if selected: nickel only
- Edges: matching 3 mm plastic on doors and drawers and matching 1 mm plastic on all other edges
- Shelf pins

- 1 Style number
 - 2 Laminate color number for base cabinet
 - 3 Options, if selected (see below)
- ▶ See *Surface Materials*, page 402.

Options	Price	Required to Specify
---------	-------	---------------------

Door and Drawer Pulls

- Contemporary: nickel only
- Opus: champagne only
- Jazz: nickel only

No cost
+\$15 per pull
+\$17 per pull

Specify with *contemporary pull*.
Specify with *Opus pull*.
Specify with *jazz pull*.

Lock and Keying

- **Lock**
- 9201 Polished Chrome only

+\$34

Specify with *lock*.

- **Keying**
- Factory and field-installed keying

▶ Page 440

Related Products

- Shelves for wall-mounted base cabinets
- Fillers for wall-mounted base cabinets
- Plastic drawer liners

▶ Page 342
▶ Page 342
▶ Page 325

Tip: Lock secures top drawer only on units with multiple drawers or a drawer and door combination.

Tip: Additional shelves are available and must be specified separately.

Specification Information

Dimensions			Style	Base
D	W	H	Number	Price

Cabinets with Single Door and One Adjustable Shelf

Hinged Left

18½"	18"	23½"	HXBD1824L8	\$ 882
18½"	24"	23½"	HXBD2424L8	\$ 954

Hinged Right

18½"	18"	23½"	HXBD1824R8	\$ 882
18½"	24"	23½"	HXBD2424R8	\$ 954

Cabinets With Double Doors and One Adjustable Shelf

18½"	36"	23½"	HXBD36248	\$1185
------	-----	------	------------------	--------

Cabinets With One Small Drawer and One Large Drawer

18½"	18"	23½"	HXBC18248	\$1336
18½"	24"	23½"	HXBC24248	\$1432

Cabinets With Three Small Drawers

18½"	18"	23½"	HXBM18248	\$1478
18½"	24"	23½"	HXBM24248	\$1629

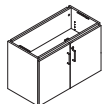

Folio Wall-Mounted Sink Cabinets

SIN 71.315

Tip: ADA sink cabinets meet the guidelines as set forth in the United States Department of Justice 2010 ADA Standards for Accessible Design (www.ada.gov/2010ADAstandards). Floor to underside of cabinet clear dimension is 27"H.

Standard Includes		Required to Specify	
	<ul style="list-style-type: none"> Sink cabinet: melamine D pull, if selected: nickel only Euro hinge, if selected: nickel only Edges: matching 3 mm plastic on doors and drawers and matching 1 mm plastic on all other edges Shelf pins 		<ul style="list-style-type: none"> 1 Style number 2 Laminate color number for sink cabinet 3 Options, if selected (see below) ▶ See <i>Surface Materials</i>, page 402.
Options	Price	Required to Specify	
Door Pulls	<ul style="list-style-type: none"> Contemporary: nickel only No cost Opus: champagne only +\$15 per pull Jazz: nickel only +\$17 per pull 	<ul style="list-style-type: none"> Specify with <i>contemporary pull</i>. Specify with <i>Opus pull</i>. Specify with <i>jazz pull</i>. 	
Lock and Keying	<p>Lock</p> <ul style="list-style-type: none"> 9201 Polished Chrome only +\$34 <p>Keying</p> <ul style="list-style-type: none"> Factory and field-installed keying 	<ul style="list-style-type: none"> Specify with <i>lock</i>. ▶ Page 440 	
Related Products	<ul style="list-style-type: none"> Shelves for wall-mounted sink cabinets Fillers for wall-mounted sink cabinets 	<ul style="list-style-type: none"> ▶ Page 342 ▶ Page 342 	

Specification Information

Dimensions			Style	Base
D	W	H	Number	Price

Sink Cabinets with Angled Front

Sink Cabinet				
18½"	36"	21 ¹¹ / ₁₆ "	HXBK3622A8	\$1117
:	:	:	:	:

Sink Cabinets with Single Door

Hinged Left				
18½"	24"	23 ¹¹ / ₁₆ "	HXBKD2424L8	\$1058
:	:	:	:	:
Hinged Right				
18½"	24"	23 ¹¹ / ₁₆ "	HXBKD2424R8	\$1058
:	:	:	:	:

Sink Cabinets with Double Doors

18½"	36"	23 ¹¹ / ₁₆ "	HXBKD36248	\$1288
:	:	:	:	:

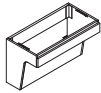

Tip: Height is for sink cabinet without work surface.

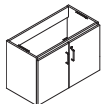

Folio 73"H Wall-Mounted Wardrobe Cabinets

Folio
73"H Wall-Mounted
Wardrobe Cabinets

SIN 71.315

Standard Includes	Required to Specify
<ul style="list-style-type: none"> Wardrobe, door fronts, and fixed shelf: melamine D pull, if selected: nickel only Euro hinge, if selected: nickel only Edges: matching 3 mm plastic on doors and matching 1 mm plastic on all other edges Hanger bar: chrome 	<ul style="list-style-type: none"> 1 Style number 2 Laminate color number for wardrobe cabinet 3 Options, if selected (see below) <ul style="list-style-type: none"> ▶ See <i>Surface Materials</i>, page 402.

Options	Price	Required to Specify
Door Pulls <ul style="list-style-type: none"> Contemporary: nickel only Opus: champagne only Jazz: nickel only 	No cost +\$15 per pull +\$17 per pull	Specify <i>with contemporary pull</i> . Specify <i>with Opus pull</i> . Specify <i>with jazz pull</i> .
Lock and Keying <ul style="list-style-type: none"> Lock <ul style="list-style-type: none"> 9201 Polished Chrome only Keying <ul style="list-style-type: none"> Factory and field-installed keying 	+\$34	Specify <i>with lock</i> . ▶ Page 440
Related Products <ul style="list-style-type: none"> Fillers for wall-mounted wardrobe cabinets 		▶ Page 342

Specification Information

Dimensions			Style	Base
D	W	H	Number	Price

Wardrobe Cabinets with Single Door and One Fixed Shelf

Hinged Left				
18½"	24"	72 ¹¹ / ₁₆ "	HXCW2473L8	\$1828
Hinged Right				
18½"	24"	72 ¹¹ / ₁₆ "	HXCW2473R8	\$1828

Wardrobe Cabinets with Single Door, One Fixed Shelf, and One Small Drawer Hinged Left

Hinged Left				
18½"	24"	72 ¹¹ / ₁₆ "	HXCW2473LD8	\$1889
Hinged Right				
18½"	24"	72 ¹¹ / ₁₆ "	HXCW2473RD8	\$1889

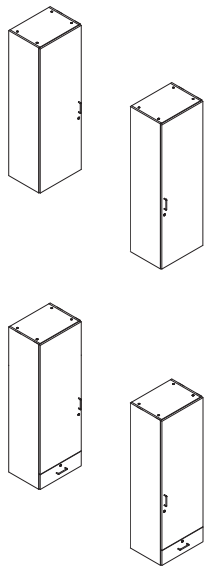

Folio 79"H Wall-Mounted Wardrobe Cabinets with Sloped Top

SIN 71.315

Standard Includes	Required to Specify
<ul style="list-style-type: none"> Wardrobe, sloped top, door fronts, and fixed shelf: melamine D pull, if selected: nickel only Euro hinge, if selected: nickel only Edges: matching 3 mm plastic on doors and matching 1 mm plastic on all other edges Hanger bar: chrome 	<ul style="list-style-type: none"> 1 Style number 2 Laminate color number for wardrobe cabinet 3 Options, if selected (see below) <ul style="list-style-type: none"> ▶ See <i>Surface Materials</i>, page 402.

Options	Price	Required to Specify
Door Pulls <ul style="list-style-type: none"> Contemporary: nickel only Opus: champagne only Jazz: nickel only 	No cost +\$15 per pull +\$17 per pull	Specify with <i>contemporary pull</i> . Specify with <i>Opus pull</i> . Specify with <i>jazz pull</i> .
Lock and Keying <ul style="list-style-type: none"> Lock <ul style="list-style-type: none"> 9201 Polished Chrome only Keying <ul style="list-style-type: none"> Factory and field-installed keying 	+\$34	Specify with <i>lock</i> . ▶ Page 440

Tip: Bottom panel is flush with bottom of end panels.

Tip: Panel thicknesses are 49/64" melamine.

Specification Information				
Dimensions			Style	Base
D	W	H	Number	Price

Wardrobe Cabinets with Single Door and One Fixed Shelf

Hinged Left

18½"	24"	79"	HXCW2479LS8	\$2013
------	-----	-----	--------------------	--------

Hinged Right

18½"	24"	79"	HXCW2479RS8	\$2013
------	-----	-----	--------------------	--------

Wardrobe Cabinets with Single Door, One Fixed Shelf, and One Small Drawer Hinged Left

Hinged Left

18½"	24"	79"	HXCW2479LSD8	\$2075
------	-----	-----	---------------------	--------

Hinged Right

18½"	24"	79"	HXCW2479RSD8	\$2075
------	-----	-----	---------------------	--------

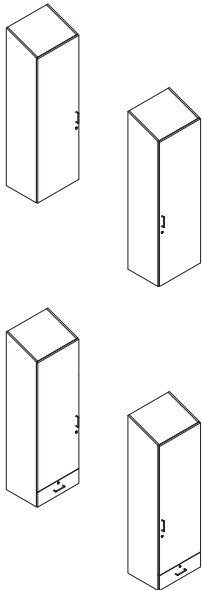

Folio

73"H Wall-Mounted Bookcases

Folio
73"H Wall-Mounted
Bookcases

SIN 71.315

Standard Includes

- Bookcase, door fronts, and shelves: melamine
- D pull, if selected: nickel only
- Euro hinge, if selected: nickel only
- Edges: matching 3 mm plastic on doors and matching 1 mm plastic on all other edges
- Shelf Pins

Required to Specify

- 1 Style number
 - 2 Laminate color number for bookcase
 - 3 Options, if selected (see below)
- ▶ See *Surface Materials*, page 402.

	Options	Price	Required to Specify
Door Pulls	<ul style="list-style-type: none"> • Contemporary: nickel only • Opus: champagne only • Jazz: nickel only 	No cost +\$15 +\$17	Specify with <i>contemporary pull</i> . Specify with <i>Opus pull</i> . Specify with <i>jazz pull</i> .
Lock and Keying	<p>Lock</p> <ul style="list-style-type: none"> • 9201 Polished Chrome only <p>Keying</p> <ul style="list-style-type: none"> • Factory and field-installed keying 	+\$34	Specify with <i>lock</i> . ▶ Page 440
Related Products	<ul style="list-style-type: none"> • Wall-mounted wardrobe cabinets 		▶ Page 333

Tip: Additional shelves are available and must be specified separately.

Specification Information

Dimensions			Style	Base
D	W	H	Number	Price
:	:	:	:	:

Open Bookcase with Five Shelves

18½"	24"	72 ¹¹ / ₁₆ "	HXCBP24738	\$1739
:	:	:	:	:

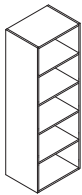

Bookcases with Single Door and Five Shelves

Hinged Left

18½"	24"	72 ¹¹ / ₁₆ "	HXCBD2473L8	\$2148
------	-----	------------------------------------	--------------------	--------

Hinged Right

18½"	24"	72 ¹¹ / ₁₆ "	HXCBD2473R8	\$2148
------	-----	------------------------------------	--------------------	--------

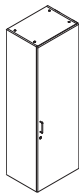
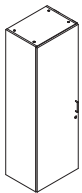

Folio 79"H Wall-Mounted Bookcases with Sloped Top

SIN 71.315

Tip: One shelf is fixed at 36"H. All other shelves are adjustable.

Standard Includes	Required to Specify
<ul style="list-style-type: none"> Bookcase, sloped top, door fronts, and shelves: melamine D pull, if selected: nickel only Euro hinge, if selected: nickel only Edges: matching 3 mm plastic on doors and matching 1 mm plastic on all other edges Shelf pins 	<ul style="list-style-type: none"> 1 Style number 2 Laminate color number for bookcase 3 Options, if selected (see below) ▶ See <i>Surface Materials</i>, page 402.

Options	Price	Required to Specify
Door Pulls <ul style="list-style-type: none"> Contemporary: nickel only Opus: champagne only Jazz: nickel only 	No cost +\$15 +\$17	Specify with <i>contemporary pull</i> . Specify with <i>Opus pull</i> . Specify with <i>jazz pull</i> .
Lock and Keying	Lock <ul style="list-style-type: none"> 9201 Polished Chrome only 	+\$34 Specify with <i>lock</i> .
	Keying <ul style="list-style-type: none"> Factory and field-installed keying 	▶ Page 440
Related Products	<ul style="list-style-type: none"> Wall-mounted wardrobe cabinets 	▶ Page 333

Tip: Additional shelves are available and must be specified separately.

Specification Information

Dimensions			Style	Base
D	W	H	Number	Price

Open Bookcase with Five Shelves

18½"	24"	79"	HXCBP24798	\$1914
------	-----	-----	-------------------	--------

Bookcases with Single Door and Five Shelves

Hinged Left				
18½"	24"	79"	HXCBD2479L8S	\$2364

Hinged Right				
18½"	24"	79"	HXCBD2479R8S	\$2364

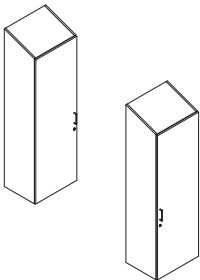
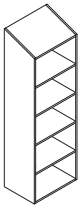

Folio Wall-Mounted Laminate Worksurfaces

SIN 71.315

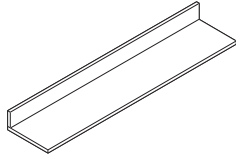

Tip: Worksurfaces must be attached to base cabinets or desk frames.

Standard Includes	Required to Specify
-------------------	---------------------

<ul style="list-style-type: none"> Standard length laminate worksurface with backsplash: laminate Edge band: 3 mm plastic on front and 1 mm plastic on sides, back, and all backsplash edges 	<ol style="list-style-type: none"> Style number Laminate color number for worksurface and backsplash Plastic color number for edge on worksurface Options, if selected (see below) <p>▶ See <i>Surface Materials</i>, page 402.</p>
--	---

Surface Materials	Options	Price	Required to Specify
-------------------	---------	-------	---------------------

	<ul style="list-style-type: none"> Steelcase Health laminate Steelcase laminate Open Line laminate 	No cost No cost +\$69 plus the cost of laminate	<p>▶ See <i>Surface Materials</i>, page 402.</p> <p>▶ See <i>Surface Materials</i>, page 402.</p> <p>▶ See <i>Surface Materials</i>, page 402.</p>
--	---	--	--

Specification Information			
Dimensions		Style	Base
D	W	Number	Price

Laminate Worksurfaces with 4" Backsplash			
D	W	Style Number	Base Price
19 1/4"	18"	HXW1818L	\$333
19 1/4"	24"	HXW2418L	\$374
19 1/4"	36"	HXW3618L	\$455
19 1/4"	42"	HXW4218L	\$496
19 1/4"	48"	HXW4818L	\$535
19 1/4"	60"	HXW6018L	\$596
19 1/4"	72"	HXW7218L	\$663
:	:	:	:

Folio Wall-Mounted 4"H Laminate Sidesplash

SIN 71.315



Standard Includes	Required to Specify
<ul style="list-style-type: none"> Laminate sidesplash: laminate Edge band: 1 mm plastic 	<ol style="list-style-type: none"> Style number Laminate color number for sidesplash Plastic color number for edge on side-splash Options, if selected (see below) <p>▶ See <i>Surface Materials</i>, page 402.</p>

Options	Price	Required to Specify
Surface Materials <ul style="list-style-type: none"> Laminate Steelcase laminate Open Line laminate 	No cost No cost +\$23 plus the cost of laminate	<p>▶ See <i>Surface Materials</i>, page 402.</p> <p>▶ See <i>Surface Materials</i>, page 402.</p> <p>▶ See <i>Surface Materials</i>, page 402.</p>

Specification Information			
Dimensions		Style	Base
D	H	Number	Price
16 ¹ / ₄ "	4"	HXWS416L	\$65
18 ¹ / ₈ "	4"	HXWS418L	\$68

Folio Wall-Mounted Solid Surface Worksurfaces

Folio
Wall-Mounted
Solid Surface
Worksurfaces

SIN 71.315

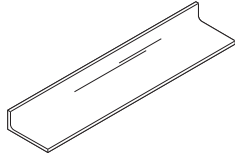

Worksurfaces are designed with a 1" overhang.

Tip: Worksurfaces must be attached to base cabinets or desk frames.

Standard Includes	Required to Specify
<ul style="list-style-type: none"> Solid surface worksurface with integrated backsplash 	<ul style="list-style-type: none"> 1 Style number 2 Solid surface color number for worksurface and backsplash ▶ See <i>Surface Materials</i>, page 402.

Specification Information

Dimensions		Style Number	Prices			
D	W		Price Group A	Price Group B	Price Group C	Price Group D
:	:	:	:	:	:	:

Solid Surface Worksurfaces with Integrated Backsplash

19¼"	18"	HXW1818S	\$ 733	\$ 791	\$ 814	\$ 909
19¼"	24"	HXW2418S	\$ 817	\$ 883	\$ 906	\$1013
19¼"	36"	HXW3618S	\$1183	\$1278	\$1313	\$1467
19¼"	42"	HXW4218S	\$1318	\$1424	\$1464	\$1635
19¼"	48"	HXW4818S	\$1456	\$1572	\$1616	\$1805
19¼"	60"	HXW6018S	\$1739	\$1878	\$1930	\$2156
19¼"	72"	HXW7218S	\$2041	\$2204	\$2265	\$2531
:	:	:	:	:	:	:

Folio Wall-Mounted 4"H Solid Surface Sidesplash

SIN 71.315

Standard Includes	Required to Specify
<ul style="list-style-type: none"> Solid surface sidesplash 	<ul style="list-style-type: none"> 1 Style number 2 Solid surface color number for sidesplash ▶ See <i>Surface Materials</i>, page 402.

Specification Information						
Dimensions		Style Number	Prices			
D	H		Price Group A	Price Group B	Price Group C	Price Group D

Left-Hand Sidesplash

16 ¹⁵ / ₁₆ "	4"	HXWS416LS	\$172	\$185	\$190	\$213
18 ¹¹ / ₁₆ "	4"	HXWS418LS	\$179	\$193	\$198	\$222

Right-Hand Sidesplash

16 ¹⁵ / ₁₆ "	4"	HXWS416RS	\$172	\$185	\$190	\$213
18 ¹¹ / ₁₆ "	4"	HXWS418RS	\$179	\$193	\$198	\$222



Folio

Wall-Mounted Desk Frames

For Use with Common Tops

SIN 71.315

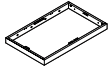

Standard Includes

- Desk frame without back panel, if selected: melamine
- Desk frame, back panel, and side panel, if selected: melamine
- Door, if selected: melamine
- D pull, if door option selected: nickel only
- Euro hinge, if door option selected: nickel only

Required to Specify

- 1 Style number
- 2 Laminate color number for desk frame, and back panel
- ▶ See *Surface Materials*, page 402.

Related Products

- Wall-mounted wardrobe cabinets ▶ Page 333
- Wall-mounted base or sink cabinets ▶ Pages 331 and 332
- Wall-mounted worksurfaces ▶ Pages 337 and 339

Specification Information

Dimensions		Style	Price
D	W	Number	

Desk Frames without Back Panel for Use with Common Top

17 ³ / ₈ "	18"	HXDF1818	\$213
17 ³ / ₈ "	24"	HXDF2418	\$219
17 ³ / ₈ "	36"	HXDF3618	\$232
17 ³ / ₈ "	42"	HXDF4218	\$241
17 ³ / ₈ "	48"	HXDF4818	\$247
17 ³ / ₈ "	60"	HXDF6018	\$260
17 ³ / ₈ "	72"	HXDF7218	\$267

Tip: Desk frames must be attached to worksurface. Specify worksurfaces separately.

Tip: Desk frames must be attached to adjacent 14"D or 18"D structural wall or cabinet.

Folio Wall-Mounted Accessories

SIN 71.315

Storage Shelves



Standard Includes	Required to Specify
<ul style="list-style-type: none"> Shelves: melamine Edges: matching 3 mm plastic on fronts and matching 1 mm plastic on sides and back Shelf pins 	<ul style="list-style-type: none"> 1 Style number 2 Laminate color number for shelf ▶ See <i>Surface Materials</i>, page 402.

Specification Information

Dimensions			Style	Price
D	W	H	Number	

Shelves for Wall-Mounted Base Cabinets

18"	18"	3/4"	HXBS1818	\$65
18"	24"	3/4"	HXBS2418	\$73
18"	36"	3/4"	HXBS3618	\$88

Tip: For use with base cabinets only.

Wall-Mounted Fillers

Tip: Fillers close the gap between a cabinet and structural wall. Field cutting of filler may be required to achieve architectural fit.



Standard Includes	Required to Specify
<ul style="list-style-type: none"> Filler: melamine 	<ul style="list-style-type: none"> 1 Style number 2 Laminate color number for filler ▶ See <i>Surface Materials</i>, page 402.

Specification Information

Dimensions			Style	Price
D	W	H	Number	

Filler for Use with Wall-Mounted Base or Sink Cabinets

5 7/8"	6"	23 11/16"	HXFB624	\$ 99

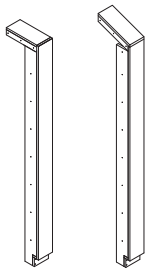

Fillers for Use with Wall-Mounted Wardrobe Cabinets

5 7/8"	6"	72 11/16"	HXFCWB673	\$210
17 3/8"	6"	79"	HXFCW679	\$210



Statement of Line **344**



Specifying

Dressers (SIN 71.315)	345
Bedside Tables (SIN 71.315)	346

Statement of Line

Ainsley

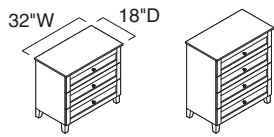

Specifying
▶ Page 345

Dressers

	30\"H	38\"H
With three drawers	●	
With four drawers		●

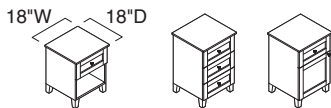

Specifying
▶ Page 346

Bedside Tables

	24\"H	30\"H
Night table with one drawer and open shelf	●	
Bedside table with three drawers		●
Bedside table with one drawer and one door		●

Ainsley Dressers

SIN 71.315

Standard Includes	Required to Specify
<ul style="list-style-type: none"> • Dresser: melamine or wood veneer • Drawer fronts: wood to match case • Base: wood to match case • Top: laminate with wood edge to match case • Round knob pull on drawers: satin chrome only • Adjustable glides 	<ul style="list-style-type: none"> 1 Style number 2 Laminate or wood color number for dresser 3 Options, if selected (see below) ▶ See <i>Surface Materials</i>, page 402.

Options	Price	Required to Specify
Drawer Pulls <ul style="list-style-type: none"> • Flat knob pull: matte stainless steel 	+\$14 per pull	Specify with flat knob pulls.
Lock and Keying <ul style="list-style-type: none"> • Lock with random key • 9201 Polished Chrome only 	+\$34	Specify with lock.
<ul style="list-style-type: none"> • Keying • Factory- and field-installed keying 		▶ Page 440
Related Products <ul style="list-style-type: none"> • Accessories • Headboards and footboards • Mirrors 		<ul style="list-style-type: none"> ▶ Page 387 ▶ Page 384 ▶ Page 386

Specification Information

Dimensions	Style	Base
D W H	Number	Price

Dressers with Melamine Case and Wood Fronts

With Three Drawers				
D	W	H	Style Number	Price
18"	32"	30"	H2D330L	\$1327

With Four Drawers				
D	W	H	Style Number	Price
18"	32"	38"	H2D438L	\$1561



Ainsley Bedside Tables

SIN 71.315

Tip: 18" deep bedside tables have a 15⁵/₈" deep drawer and the slide has 14" of travel. 24" deep bedside tables have a 19⁵/₈" deep drawer and a slide 21" of travel.

Tip: Lock, if selected, will only secure top drawer of cabinet.

Standard Includes	Required to Specify
<ul style="list-style-type: none"> Bedside table case: melamine Door or drawer fronts: wood to match case Base: wood to match case Top: laminate with wood edge to match case Round knob pull on doors and drawers: satin chrome only Adjustable glides: black only 	<ul style="list-style-type: none"> 1 Style number 2 Laminate color number for bedside table 3 Options, if selected (see below) ▶ See <i>Surface Materials</i>, page 402.

Options	Price	Required to Specify
Door and Drawer Pulls <ul style="list-style-type: none"> Flat knob pull: matte stainless steel 	+\$ 14 per pull	Specify with flat knob pulls.
Gallery Rails <ul style="list-style-type: none"> Gallery rails (set of three) 	+\$106	Specify with gallery rails.
Casters <ul style="list-style-type: none"> Casters (set of four) Back roller casters with front glides 	+\$ 28 +\$ 55	Specify with casters. Specify with back roller casters.
Lock and Keying <ul style="list-style-type: none"> Lock with random key <ul style="list-style-type: none"> 9201 Polished Chrome only Keying <ul style="list-style-type: none"> Factory- and field-installed keying 	+\$ 34	Specify with lock. ▶ Page 440
Related Products <ul style="list-style-type: none"> Accessories Headboards and footboards Mirrors 		▶ Page 387 ▶ Page 384 ▶ Page 386

Specification Information

Dimensions			Style	Base
D	W	H	Number	Price

Bedside Tables with Melamine Case and Wood Fronts

Night Table with One Drawer and Open Shelf

18"	18"	24"	H2NE24L	\$ 774
-----	-----	-----	----------------	--------

Bedside Table with Three Drawers

18"	18"	30"	H2BM30L	\$1216
-----	-----	-----	----------------	--------

Melamine Bedside Tables with One Drawer and One Door

Door Hinged on Left

18"	18"	30"	H2BG30LL	\$ 990
-----	-----	-----	-----------------	--------

Door Hinged on Right

18"	18"	30"	H2BG30RL	\$ 990
-----	-----	-----	-----------------	--------



Davenport



Statement of Line **348**

Specifying

Wardrobe Cabinets (SIN 71.315)	349
Dressers (SIN 71.315)	350
Writing Desk (SIN 71.315)	351
Bedside Tables (SIN 71.315)	352

Statement of Line

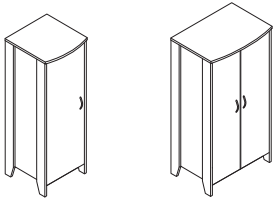
Davenport



Specifying
▶ Page 349

Wardrobe Cabinets

	24"W	36"W
Single-door wardrobe	●	
Double-door wardrobe		●



Specifying
▶ Page 351

Writing Desk

	42"W
Writing desk	●

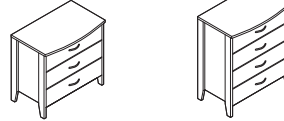

Specifying
▶ Page 350

Dressers

	31"H	38"H
With three drawers	●	
With four drawers		●



Specifying
▶ Page 352

Bedside Tables

	24"H	31"H
Night table with one drawer and open shelf	●	
Bedside table with three drawers		●
Bedside table with one drawer and door cabinet		●

Davenport Wardrobe Cabinets

SIN 71.315

Tip: Laminate color on legs will match the laminate color selected for the top.

Tip: Center vertical divider must be specified when lock option is selected on the 36" unit.

Standard Includes	Required to Specify
<ul style="list-style-type: none"> Wardrobe cabinet, top, and legs: laminate Bow pulls on door: brushed stainless steel Hanger bar: Polished Chrome only Adjustable glides Fixed shelf 	<ol style="list-style-type: none"> Style number Laminate color number for wardrobe cabinet Laminate color number for top Options, if selected (see below) <p>▶ See <i>Surface Materials</i>, page 402.</p>

Options	Price	Required to Specify
Center Vertical Divider <ul style="list-style-type: none"> Available on 36"W cabinets only 	+\$167	Specify with center vertical divider.
Lock and Keying <ul style="list-style-type: none"> Lock with random key <ul style="list-style-type: none"> Single door wardrobe +\$ 34 Double door wardrobe +\$ 68 Keying <ul style="list-style-type: none"> Factory and field-installed keying 		Specify with lock. Specify with lock. ▶ Page 440
Related Products <ul style="list-style-type: none"> Headboards and Footboards Mirrors 		▶ Page 383 ▶ Page 386

Specification Information

Dimensions	Style	Base
D W H	Number	Price
:	:	:
:	:	:

Single-Door Wardrobe

Door Hinged on Left				
24"	24"	68"	70WR2401L	\$1285
:	:	:	:	:
Door Hinged on Right				
24"	24"	68"	70WR2401R	\$1285
:	:	:	:	:

Double-Door Wardrobe

24"	36"	68"	70WR3601	\$1689
:	:	:	:	:

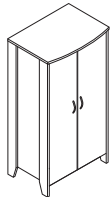
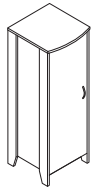

Davenport

Davenport Dressers

SIN 71.315

Tip: Laminate color on legs will match the laminate color selected for the top.

Standard Includes	Required to Specify
<ul style="list-style-type: none"> Dresser, top, and legs: laminate Bow pulls on drawers: brushed stainless steel Adjustable glides 	<ol style="list-style-type: none"> Style number Laminate color number for dresser Laminate color number for top Options, if selected (see below) <p>▶ See <i>Surface Materials</i>, page 402.</p>

Options	Price	Required to Specify
Lock and Keying <ul style="list-style-type: none"> Lock with random key Polished Chrome 	+\$34	Specify <i>with lock</i> .
Keying <ul style="list-style-type: none"> Factory and field-installed keying 		▶ Page 440
Related Products <ul style="list-style-type: none"> Headboards and Footboards Mirrors 		▶ Page 383 ▶ Page 386

Specification Information

• Dimensions	• Style	• Base
D W H	Number	Price

With Three Drawers

19"	32"	31"	70DR3201	\$811

With Four Drawers

19"	32"	38"	70CH4001	\$975



Davenport Writing Desk

SIN 71.315



Tip: Laminate color on legs will match the laminate color selected for the top.

Standard Includes	Required to Specify
<ul style="list-style-type: none"> Writing desk, top, case, and legs: laminate Bow pulls on drawers: brushed stainless steel 	<ul style="list-style-type: none"> 1 Style number 2 Laminate color number for writing desk 3 Laminate color number for top 4 Options, if selected (see below) ▶ See <i>Surface Materials</i>, page 402.

Options	Price	Required to Specify
Lock and Keying <ul style="list-style-type: none"> Lock with random key <ul style="list-style-type: none"> Polished Chrome +\$34 		Specify <i>with lock</i> .
<ul style="list-style-type: none"> Keying <ul style="list-style-type: none"> Factory and field-installed keying 		▶ Page 440
Related Products <ul style="list-style-type: none"> Headboards and Footboards Mirrors 		<ul style="list-style-type: none"> ▶ Page 383 ▶ Page 386

Specification Information				
Dimensions			Style	Base
D	W	H	Number	Price
19"	42"	30"	70WT4201	\$800



Davenport Bedside Tables

SIN 71.315

Tip: Laminate color on legs will match the laminate color selected for the top.

Tip: Drawer insert available in top drawer only.

Tip: Lock, if selected, will only secure top drawer of cabinet.

Standard Includes	Required to Specify
<ul style="list-style-type: none"> • Bedside table unit, top, case, and legs: laminate • Bow pulls on door and drawers: brushed stainless steel • Adjustable glides 	<ol style="list-style-type: none"> 1 Style number 2 Laminate color number for bedside table 3 Laminate color number for top 4 Options, if selected (see below) <p>▶ See <i>Surface Materials</i>, page 402.</p>

Options	Price	Required to Specify
Casters	• Back roller casters with front glides +\$55	Specify with back roller casters.
Drawer insert	• Plastic drawer insert +\$34	Specify with drawer insert.
Lock and Keying	Lock with random key • Polished Chrome +\$34 Keying • Factory and field-installed keying	Specify with lock. ▶ Page 440
Related Products	• Headboards and Footboards • Mirrors	▶ Page 383 ▶ Page 386

Specification Information

• Dimensions			• Style	• Base
D	W	H	Number	Price

Night Table With One Drawer and Open Shelf

19"	20"	24"	70NT2000	\$537
-----	-----	-----	-----------------	-------

Bedside Table with Three Drawers

19"	20"	31"	70BT2001	\$715
-----	-----	-----	-----------------	-------

Bedside Table with One Drawer and Door Cabinet

Door Hinged on Left				
19"	20"	31"	70BT2005L	\$623

Door Hinged on Right				
19"	20"	31"	70BT2005R	\$623



Tip: Illustration shows door hinged on left.

Tip: Upper drawer clearance is 14¹/₄"D x 14¹/₂"W x 6"H.
Lower compartment clearance 16¹/₄"D x 16³/₁₀"W x 15¹/₄"H.

Park



Statement of Line **354**



Specifying

Wardrobe Cabinets (SIN 71.315)	355
Mobile Cabinet (SIN 71.315)	356
Bedside Tables (SIN 71.315)	357

Statement of Line

Park

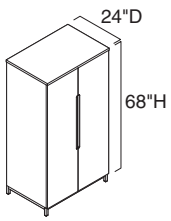

Specifying
▶ Page 355

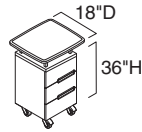

Specifying
▶ Page 356

Wardrobe Cabinets

36"W

Double-door wardrobe ●

Mobile Cabinet

18"W

With three drawers ●

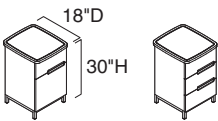

Specifying
▶ Page 357

Bedside Tables

18"W

With one drawer and one door ●

With three drawers ●

Park Wardrobe Cabinets

SIN 71.315

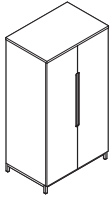

Standard Includes	Required to Specify
-------------------	---------------------

- | | |
|---|---|
| <ul style="list-style-type: none"> • Wardrobe case: melamine • Door fronts: rigid thermoform • Base: 4799 Platinum Metallic only • Top: melamine with 3 mm plastic edge to match case • Integral finger pulls on door • Hanger bar: black • Adjustable glides • Fixed shelf | <ol style="list-style-type: none"> 1 Style number 2 Laminate color number for wardrobe case 3 Rigid thermoform color number for door fronts 4 Options, if selected (see below) <ul style="list-style-type: none"> ▶ See <i>Surface Materials</i>, page 402. |
|---|---|

Options	Price	Required to Specify
---------	-------	---------------------

Center Vertical Divider	• Divider	+\$167	Specify with center vertical divider.
J-bar Coatrod	• J-bar	+\$129	Specify with J-bar.
Lock and Keying	Lock with random key <ul style="list-style-type: none"> • 9201 Polished Chrome only 	+\$ 34	Specify with lock.
	Keying <ul style="list-style-type: none"> • Factory- and field-installed keying 		▶ Page 440
Related Products	<ul style="list-style-type: none"> • Accessories • Headboards and footboards • Mirrors 		▶ Page 387 ▶ Page 384 ▶ Page 386

Specification Information				
Dimensions			Style	Base
D	W	H	Number	Price

24"	36"	68"	H4W236R	\$2010
:	:	:	:	:

Double-Door Wardrobe Cabinet

24"	36"	68"	H4W236R	\$2010
:	:	:	:	:

Tip: Depth and width dimensions are for box unit and do not include overhang of top.

Park Mobile Cabinet

SIN 71.315



Tip: Lock, if selected, will only secure top drawer of cabinet.

Standard Includes	Required to Specify
<ul style="list-style-type: none"> Mobile cabinet case: melamine Drawer fronts: rigid thermoform Base: 4799 Platinum Metallic only Top: rigid thermoform Top stanchions: 4799 Platinum Metallic only Integral pull on drawers Front-locking casters: black only Back casters: black only 	<ol style="list-style-type: none"> Style number Laminate color number for cabinet case Rigid thermoform color number for cabinet front Rigid thermoform color number for top Options, if selected (see below) <p>▶ See <i>Surface Materials</i>, page 402.</p>

Options	Price	Required to Specify
Lock and Keying <ul style="list-style-type: none"> Lock with random key 9201 Polished Chrome only 	+\$34	Specify <i>with lock</i> .
Keying <ul style="list-style-type: none"> Factory- and field-installed keying 		▶ Page 440
Related Products <ul style="list-style-type: none"> Accessories Headboards and footboards Mirrors 		▶ Page 387 ▶ Page 384 ▶ Page 386

Specification Information				
Dimensions			Style	Base
D	W	H	Number	Price

With Three Drawers				
18"	18"	36"	H4BFM136R	\$1116

Park Bedside Tables

SIN 71.315

Standard Includes	Required to Specify
<ul style="list-style-type: none"> • Bedside table case: melamine to match fronts • Door and drawer fronts: rigid thermoform • Base: 4799 Platinum Metallic only • Top: rigid thermoform • Integral finger pull on doors and drawers • Adjustable glides 	<ol style="list-style-type: none"> 1 Style number 2 Laminate color number for bedside table case 3 Rigid thermoform color number for bedside table front 4 Rigid thermoform color number for top 5 Options, if selected (see below) <p>▶ See <i>Surface Materials</i>, page 402.</p>

Options	Price	Required to Specify	
Gallery Rail	• Gallery rail	+\$106	Specify with <i>gallery rail</i> .
Casters	• Casters (set of four)	+\$ 28	Specify with <i>casters</i> .
	• Back roller casters with front glides	+\$ 55	Specify with <i>back roller casters</i> .
Lock and Keying	Lock with random key		
	• 9201 Polished Chrome only	+\$ 34	Specify with <i>lock</i> .
	Keying		
	• Factory- and field-installed keying		▶ Page 440
Related Products	• Accessories		▶ Page 387
	• Headboards and footboards		▶ Page 384
	• Mirrors		▶ Page 386

Tip: Lock, if selected, will only secure top drawer of cabinet.

Tip: Depth and width dimensions are for box unit and do not include overhang of top.

Tip: 18" deep bedside tables have a 15⁵/₈" deep drawer and the slide has 14" of travel. 24" deep bedside tables have a 19⁵/₈" deep drawer and a slide 21" of travel.

Specification Information				
• Dimensions			• Style	• Base
D	W	H	Number	Price

With Three Drawers

18"	18"	30"	H4BM30R	\$1056

With One Drawer and One Door Cabinets

Door Hinged on Left

18"	18"	30"	H4BG30LR	\$ 860
-----	-----	-----	-----------------	--------

Door Hinged on Right

18"	18"	30"	H4BG30RR	\$ 860
-----	-----	-----	-----------------	--------



Park

Senza

	
Statement of Line	360

	
Specifying	
Wardrobe Cabinets (SIN 71.315)	362
Dressers (SIN 71.315)	366
Bedside Tables (SIN 71.315)	368

Statement of Line

Senza

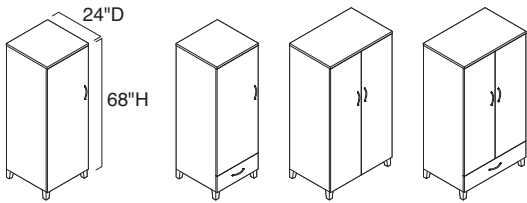

Specifying
▶ Pages 362-364

Wardrobe Cabinets

	24\"/>	
Single-door wardrobe	●	
Single-door wardrobe with one drawer	●	
Double-door wardrobe		●
Double-door wardrobe with one drawer		●

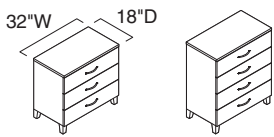

Specifying
▶ Pages 366-367

Dressers

	30\"/>	
With three drawers	●	
With four drawers		●

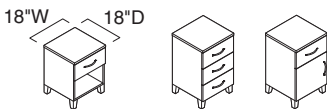

Specifying
▶ Pages 368-370

Bedside Tables

	24\"/>	
Night table with one drawer and open shelf	●	
Bedside table with three drawers		●
Bedside table with one drawer and one door		●

Senza Wardrobe Cabinets

with Melamine Fronts

SIN 71.315

Standard Includes	Required to Specify
<ul style="list-style-type: none"> • Wardrobe case: melamine to match fronts • Door and drawer fronts: melamine • Wood-leg base: wood veneer to match fronts • Top: melamine with 3 mm plastic edge to match fronts • Bow pull on doors and drawers: brushed nickel only • Hanger bar: black only • Adjustable glides • Fixed shelf 	<ol style="list-style-type: none"> 1 Style number 2 Laminate color number for wardrobe cabinet 3 Options, if selected (see below) <ul style="list-style-type: none"> ▶ See <i>Surface Materials</i>, page 402.

Options	Price	Required to Specify
Door and Drawer Pulls <ul style="list-style-type: none"> • Flat knob pull: matte stainless steel only • Opus pull: champagne only • Jazz pull: nickel only • Line pull: 4799 Platinum Metallic only 	<ul style="list-style-type: none"> +\$ 14 per pull +\$ 15 per pull +\$ 17 per pull +\$ 21 per pull 	<ul style="list-style-type: none"> Specify with <i>flat knob pull</i>. Specify with <i>Opus pull</i>. Specify with <i>jazz pull</i>. Specify with <i>line pull</i>.
Base <ul style="list-style-type: none"> • Enclosed base • Metal-leg base 	<ul style="list-style-type: none"> +\$ 62 +\$111 	<ul style="list-style-type: none"> Specify with <i>enclosed base</i>. Specify with <i>metal-leg base</i>.
Center Vertical Divider <ul style="list-style-type: none"> • For 36"W wardrobe cabinets only 	<ul style="list-style-type: none"> +\$167 	<ul style="list-style-type: none"> Specify with <i>center vertical divider</i>.
J-bar Coatrod <ul style="list-style-type: none"> • For 24"W wardrobe cabinets • For 36"W wardrobe cabinets 	<ul style="list-style-type: none"> +\$ 85 +\$129 	<ul style="list-style-type: none"> Specify with <i>J-bar</i>. Specify with <i>J-bar</i>.
Lock and Keying <ul style="list-style-type: none"> • Single-door wardrobe cabinets • Single-door with drawer or double-door wardrobe cabinets 	<ul style="list-style-type: none"> +\$ 34 +\$ 68 	<ul style="list-style-type: none"> Specify with <i>lock</i>. Specify with <i>lock</i>.
Keying <ul style="list-style-type: none"> • Factory- and field-installed keying 		<ul style="list-style-type: none"> ▶ Page 440
Related Products <ul style="list-style-type: none"> • Accessories • Headboards and footboards • Mirrors 		<ul style="list-style-type: none"> ▶ Page 387 ▶ Page 384 ▶ Page 386

Tip: J-bar coatrod not available on 42"W wardrobe cabinets.

Tip: Wardrobe cabinets with a single lock are available with factory- or field-installed locks. Wardrobe cabinets with multiple locks are available field-installed only.

Specification Information

Dimensions	Style	Base
D W H	Number	Price

Single-Door Wardrobe Cabinets

Door Hinged on Left

24"	24"	68"	H3W124LL	\$1282
-----	-----	-----	-----------------	--------

Door Hinged on Right

24"	24"	68"	H3W124RL	\$1282
-----	-----	-----	-----------------	--------

▶ **Specification Information, continued on next page**

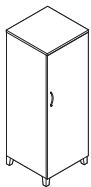
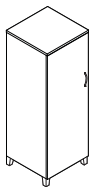

► Specification Information, continued from previous page

SIN 71.315

Specification Information

Dimensions			Style	Base
D	W	H	Number	Price

Single-Door Wardrobe Cabinets with One Drawer

Door Hinged on Left

24"	24"	68"	H3W1C24LL	\$1410
-----	-----	-----	------------------	--------

Door Hinged on Right

24"	24"	68"	H3W1C24RL	\$1410
-----	-----	-----	------------------	--------

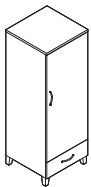
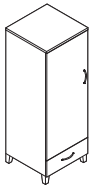

Tip: Single-door wardrobe cabinet with drawer has one lock in door and one lock in drawer. Locks are available field-installed only.

Double-Door Wardrobe Cabinet

24"	36"	68"	H3W236L	\$1642
-----	-----	-----	----------------	--------

Double-Door Wardrobe Cabinet with One Drawer

24"	36"	68"	H3W2C36L	\$1769
-----	-----	-----	-----------------	--------

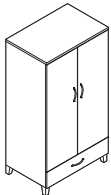
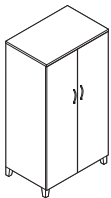

Tip: Double-door wardrobe cabinet with drawer has one lock for doors and one lock in drawer. Locks are available field-installed only.

Senza Wardrobe Cabinets

with Rigid Thermoform Fronts

SIN 71.315

Standard Includes	Required to Specify
<ul style="list-style-type: none"> • Wardrobe case: melamine to match fronts • Door and drawer fronts: rigid thermoform • Wood-leg base: wood veneer to match fronts • Top: melamine with 3 mm plastic edge to match fronts • Bow pull on doors and drawers: brushed nickel only • Hanger bar: black only • Adjustable glides • Fixed shelf 	<ol style="list-style-type: none"> 1 Style number 2 Rigid thermoform color number for wardrobe cabinet 3 Options, if selected (see below) <ul style="list-style-type: none"> ▶ See <i>Surface Materials</i>, page 402.

Options	Price	Required to Specify
Door and Drawer Pulls <ul style="list-style-type: none"> • Flat knob pull: matte stainless steel only • Opus pull: champagne only • Jazz pull: nickel only • Line pull: 4799 Platinum Metallic only 	+\$ 14 per pull +\$ 15 per pull +\$ 17 per pull +\$ 21 per pull	Specify <i>with flat knob pull</i> . Specify <i>with Opus pull</i> . Specify <i>with jazz pull</i> . Specify <i>with line pull</i> .
Base <ul style="list-style-type: none"> • Enclosed base • Metal-leg base 	+\$ 62 +\$111	Specify <i>with enclosed base</i> . Specify <i>with metal-leg base</i> .
Center Vertical Divider <ul style="list-style-type: none"> • For 36"W wardrobe cabinets only 	+\$167	Specify <i>with center vertical divider</i> .
J-bar Coatrod <ul style="list-style-type: none"> • For 24"W wardrobe cabinets • For 36"W wardrobe cabinets 	+\$ 85 +\$129	Specify <i>with J-bar</i> . Specify <i>with J-bar</i> .
Lock and Keying <ul style="list-style-type: none"> • Single-door wardrobe cabinets • Single-door with drawer or double-door wardrobe cabinets 	Lock with random key: 9201 Polished Chrome only +\$ 34 +\$ 68	Specify <i>with lock</i> . Specify <i>with lock</i> .
	Keying <ul style="list-style-type: none"> • Factory- and field-installed keying 	▶ Page 440
Related Products <ul style="list-style-type: none"> • Accessories • Headboards and footboards • Mirrors 		▶ Page 387 ▶ Page 384 ▶ Page 386

Tip: J-bar coatrod not available on 42"W wardrobe cabinets.

Tip: Wardrobe cabinets with a single lock are available with factory- or field-installed locks. Wardrobe cabinets with multiple locks are available field-installed only.

Specification Information

Dimensions			Style	Base
D	W	H	Number	Price

Single-Door Wardrobe Cabinets

Door Hinged on Left

24"	24"	68"	H3W124LR	\$1195
-----	-----	-----	-----------------	--------

Door Hinged on Right

24"	24"	68"	H3W124RR	\$1195
-----	-----	-----	-----------------	--------

▶ **Specification Information, continued on next page**

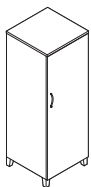
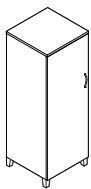

► Specification Information, continued from previous page

SIN 71.315

Specification Information

Dimensions			Style	Base
D	W	H	Number	Price

Single-Door Wardrobe Cabinets with One Drawer

Door Hinged on Left

24"	24"	68"	H3W1C24LR	\$1321
-----	-----	-----	------------------	--------

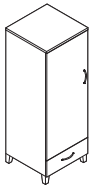

Door Hinged on Right

24"	24"	68"	H3W1C24RR	\$1321
-----	-----	-----	------------------	--------

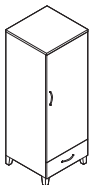

Tip: Single-door wardrobe cabinet with drawer has one lock in door and one lock in drawer. Locks are available field-installed only.

Double-Door Wardrobe Cabinet

24"	36"	68"	H3W236R	\$1525
-----	-----	-----	----------------	--------

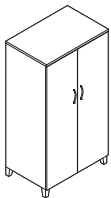

Double-Door Wardrobe Cabinet with One Drawer

24"	36"	68"	H3W2C36R	\$1646
-----	-----	-----	-----------------	--------

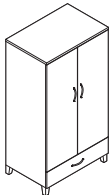

Tip: Double-door wardrobe cabinet with drawer has one lock for doors and one lock in drawer. Locks are available field-installed only.

Senza Dressers

with Melamine Fronts
SIN 71.315

Standard Includes	Required to Specify
<ul style="list-style-type: none"> • Dresser case: melamine to match fronts • Drawer fronts: melamine • Wood-leg base: wood veneer to match fronts • Top: laminate with 3 mm plastic edge to match fronts • Bow pull on drawers: brushed nickel only • Adjustable glides 	<ul style="list-style-type: none"> 1 Style number 2 Laminate color number for dresser 3 Options, if selected (see below) ▶ See <i>Surface Materials</i>, page 402.

Options	Price	Required to Specify
Solid Surface Top	<ul style="list-style-type: none"> • Solid surface price group A +\$786 • Solid surface price group B +\$811 • Solid surface price group C +\$850 • Solid surface price group D +\$936 	<ul style="list-style-type: none"> Specify solid surface color number or finish code. Specify solid surface color number or finish code. Specify solid surface color number or finish code. Specify solid surface color number or finish code.
Drawer Pulls	<ul style="list-style-type: none"> • Flat knob pull: matte stainless steel only +\$ 14 per pull • Opus pull: champagne only +\$ 15 per pull • Jazz pull: nickel only +\$ 17 per pull • Line pull: 4799 Platinum Metallic only +\$ 21 per pull 	<ul style="list-style-type: none"> Specify with <i>flat knob pull</i>. Specify with <i>Opus pull</i>. Specify with <i>jazz pull</i>. Specify with <i>line pull</i>.
Base	<ul style="list-style-type: none"> • Enclosed base +\$ 62 • Metal-leg base +\$111 	<ul style="list-style-type: none"> Specify with <i>enclosed base</i>. Specify with <i>metal-leg base</i>.
Lock and Keying	<ul style="list-style-type: none"> • Lock with random key • 9201 Polished Chrome only +\$ 34 	<ul style="list-style-type: none"> Specify with <i>lock</i>.
	<ul style="list-style-type: none"> • Keying • Factory- and field-installed keying 	<ul style="list-style-type: none"> ▶ Page 440
Related Products	<ul style="list-style-type: none"> • Accessories • Headboards and footboards • Mirrors 	<ul style="list-style-type: none"> ▶ Page 387 ▶ Page 384 ▶ Page 386

Specification Information

Dimensions			Style	Base
D	W	H	Number	Price

With Three Drawers

18"	32"	30"	H3D330L	\$1084
-----	-----	-----	----------------	--------

With Four Drawers

18"	32"	38"	H3D438L	\$1282
-----	-----	-----	----------------	--------



Senza Dressers

with Rigid Thermoform Fronts

SIN 71.315

Standard Includes	Required to Specify
<ul style="list-style-type: none"> • Dresser case: melamine to match fronts • Drawer fronts: rigid thermoform • Wood-leg base: wood veneer to match fronts • Top: rigid thermoform to match fronts • Bow pull on drawers: brushed nickel only • Adjustable glides 	<ul style="list-style-type: none"> 1 Style number 2 Rigid thermoform color number for dresser 3 Options, if selected (see below) ▶ See <i>Surface Materials</i>, page 402.

Options	Price	Required to Specify
Drawer Pulls		
• Flat knob pull: matte stainless steel only	+\$ 14 per pull	Specify with <i>flat knob pull</i> .
• Opus pull: champagne only	+\$ 15 per pull	Specify with <i>Opus pull</i> .
• Jazz pull: nickel only	+\$ 17 per pull	Specify with <i>jazz pull</i> .
• Line pull: 4799 Platinum Metallic only	+\$ 21 per pull	Specify with <i>line pull</i> .
Base		
• Enclosed base	+\$ 62	Specify with <i>enclosed base</i> .
• Metal-leg base	+\$111	Specify with <i>metal-leg base</i> .
Lock and Keying		
Lock with random key		
• 9201 Polished Chrome only	+\$ 34	Specify with <i>lock</i> .
Keying		
• Factory- and field-installed keying		▶ Page 440
Related Products		
• Accessories		▶ Page 387
• Headboards and footboards		▶ Page 384
• Mirrors		▶ Page 386

Specification Information

• Dimensions			• Style	• Base
D	W	H	Number	Price

With Three Drawers

18"	32"	30"	H3D330R	\$1054
-----	-----	-----	----------------	--------

With Four Drawers

18"	32"	38"	H3D438R	\$1242
-----	-----	-----	----------------	--------



Senza Bedside Tables

with Melamine Fronts

SIN 71.315

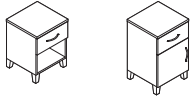

Tip: 18" deep bedside tables have a 15⁵/₈" deep drawer and the slide has 14" of travel. 24" deep bedside tables have a 19⁵/₈" deep drawer and a slide 21" of travel.

Tip: Lock, if selected, will only secure top drawer of cabinet.

Standard Includes		Required to Specify
<ul style="list-style-type: none"> • Bedside table case: melamine to match fronts • Door and drawer fronts: melamine • Wood-leg base: wood veneer to match fronts • Top: laminate with 3 mm plastic edge to match fronts • Bow pull on doors and drawers: brushed nickel only • Glides: black only 		<ul style="list-style-type: none"> 1 Style number 2 Laminate color number for bedside table 3 Options, if selected (see below) ▶ See <i>Surface Materials</i>, page 402.
Options	Price	Required to Specify
Solid Surface Top	<ul style="list-style-type: none"> • Solid surface price group A +\$520 • Solid surface price group B +\$535 • Solid surface price group C +\$561 • Solid surface price group D +\$618 	<ul style="list-style-type: none"> Specify solid surface color number or finish code. Specify solid surface color number or finish code. Specify solid surface color number or finish code. Specify solid surface color number or finish code.
Drawer Pulls	<ul style="list-style-type: none"> • Flat knob pull: matte stainless steel only +\$ 14 per pull • Opus pull: champagne only +\$ 15 per pull • Jazz pull: nickel only +\$ 17 per pull • Line pull: 4799 Platinum Metallic only +\$ 21 per pull 	<ul style="list-style-type: none"> Specify with <i>flat knob pull</i>. Specify with <i>Opus pull</i>. Specify with <i>jazz pull</i>. Specify with <i>line pull</i>.
Base	<ul style="list-style-type: none"> • Enclosed base +\$ 62 • Metal-leg base +\$111 	<ul style="list-style-type: none"> Specify with <i>enclosed base</i>. Specify with <i>metal-leg base</i>.
Casters	<ul style="list-style-type: none"> • Casters (set of four) +\$ 28 • Back roller casters with front glides +\$ 55 	<ul style="list-style-type: none"> Specify with <i>casters</i>. Specify with <i>back roller casters</i>.
Gallery Rails	<ul style="list-style-type: none"> • Gallery rails (set of three) +\$106 	Specify with <i>gallery rails</i> .
Lock and Keying	<p>Lock with random key</p> <ul style="list-style-type: none"> • 9201 Polished Chrome only +\$ 34 <p>Keying</p> <ul style="list-style-type: none"> • Factory- and field-installed keying 	<ul style="list-style-type: none"> Specify with <i>lock</i>. ▶ Page 440
Related Products	<ul style="list-style-type: none"> • Accessories • Headboards and footboards • Mirrors 	<ul style="list-style-type: none"> ▶ Page 387 ▶ Page 384 ▶ Page 386

SIN 71.315

Specification Information

Dimensions			Style	Base
D	W	H	Number	Price



Night Table with One Drawer and Open Shelf

18"	18"	24"	H3NE24L	\$658
:	:	:	:	:



Bedside Table with Three Drawers

18"	18"	30"	H3BM30L	\$970
:	:	:	:	:



Bedside Tables with One Drawer and One Door

Door Hinged on Left

18"	18"	30"	H3BG30LL	\$784
:	:	:	:	:

Door Hinged on Right

18"	18"	30"	H3BG30RL	\$784
:	:	:	:	:

Senza Bedside Tables

with Rigid Thermoform Fronts

SIN 71.315

Tip: 18" deep bedside tables have a 15⁵/₈" deep drawer and the slide has 14" of travel. 24" deep bedside tables have a 19⁵/₈" deep drawer and a slide 21" of travel.

Tip: Lock, if selected, will only secure top drawer of cabinet.

Standard Includes		Required to Specify	
	<ul style="list-style-type: none"> • Bedside table case: melamine to match fronts • Door and drawer fronts: rigid thermoform • Wood-leg base: wood veneer to match fronts • Top: rigid thermoform to match fronts • Bow pull on doors and drawers: brushed nickel only • Glides: black only 		<ol style="list-style-type: none"> 1 Style number 2 Rigid thermoform color number for bedside table 3 Options, if selected (see below) <ul style="list-style-type: none"> ▶ See <i>Surface Materials</i>, page 402.
Options	Price	Required to Specify	
Drawer Pulls	<ul style="list-style-type: none"> • Flat knob pull: matte stainless steel only +\$ 14 per pull • Opus pull: champagne only +\$ 15 per pull • Jazz pull: nickel only +\$ 17 per pull • Line pull: 4799 Platinum Metallic only +\$ 21 per pull 	Specify <i>with flat knob pull</i> . Specify <i>with Opus pull</i> . Specify <i>with jazz pull</i> . Specify <i>with line pull</i> .	
Base	<ul style="list-style-type: none"> • Enclosed base +\$ 62 • Metal-leg base +\$111 	Specify <i>with enclosed base</i> . Specify <i>with metal-leg base</i> .	
Casters	<ul style="list-style-type: none"> • Casters (set of four) +\$ 28 • Back roller casters with front glides +\$ 55 	Specify <i>with casters</i> . Specify <i>with back roller casters</i> .	
Gallery Rails	<ul style="list-style-type: none"> • Gallery rails (set of three) +\$106 	Specify <i>with gallery rails</i> .	
Lock and Keying	<p>Lock with random key</p> <ul style="list-style-type: none"> • 9201 Polished Chrome only +\$ 34 <p>Keying</p> <ul style="list-style-type: none"> • Factory- and field-installed keying 	Specify <i>with lock</i> . ▶ Page 440	
Related Products	<ul style="list-style-type: none"> • Accessories • Headboards and footboards • Mirrors 	▶ Page 387 ▶ Page 384 ▶ Page 386	

Specification Information

• Dimensions			• Style	• Base
D	W	H	Number	Price
:	:	:	:	:
:	:	:	:	:

Night Table with One Drawer and Open Shelf

18"	18"	24"	H3NE24R	\$652
:	:	:	:	:

Bedside Table with Three Drawers

18"	18"	30"	H3BM30R	\$914
:	:	:	:	:

Bedside Tables with One Drawer and One Door

Door Hinged on Left

18"	18"	30"	H3BG30LR	\$746
-----	-----	-----	-----------------	-------

Door Hinged on Right

18"	18"	30"	H3BG30RR	\$746
-----	-----	-----	-----------------	-------

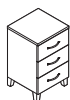

Waldorf



Statement of Line **372**



Specifying

Wardrobe Cabinet (SIN 71.315)	374
Dressers (SIN 71.315)	375
Bedside Tables (SIN 71.315)	376

Statement of Line

Waldorf

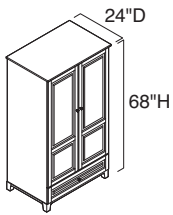

Specifying
▶ Page 374

Wardrobe Cabinet

36\"/>

Double-door wardrobe
with one drawer

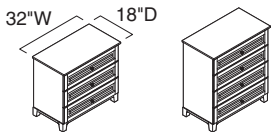

Specifying
▶ Page 375

Dressers

30\"/>

38\"/>

With three drawers



With four drawers

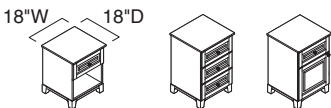

Specifying
▶ Page 376

Bedside Tables

24\"/>

30\"/>

Night table with one
drawer and open shelf



Bedside table with
three drawers



Bedside table with one
drawer and one door



Waldorf Wardrobe Cabinet

Melamine Case with Rigid Thermoform Fronts

SIN 71.315

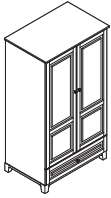

Tip: Double-door wardrobe cabinet with drawer has one lock for doors and one lock in drawer. Locks are available field-installed only.

Tip: Wardrobe cabinets with a single lock are available with factory- or field-installed locks. Wardrobe cabinets with multiple locks are available field-installed only.

Standard Includes	Required to Specify
-------------------	---------------------

- Wardrobe case: melamine
- Door and drawer fronts: rigid thermoform to match case
- Base: wood to match case
- Top: laminate with rigid thermoform to match rigid thermoform fronts
- Round knob pull on doors and drawers: satin chrome only
- Hanger bar: black only
- Adjustable glides
- Fixed shelf

- 1 Style number
 - 2 Rigid thermoform color number for wardrobe cabinet
 - 3 Options, if selected (see below)
- ▶ See *Surface Materials*, page 402.

Options	Price	Required to Specify
---------	-------	---------------------

Center Vertical Divider	• For 36"W wardrobe cabinets only	+\$167	Specify with center vertical divider.
--------------------------------	-----------------------------------	--------	---------------------------------------

J-bar Coatrod	• For 36"W wardrobe cabinets	+\$129	Specify with J-bar.
----------------------	------------------------------	--------	---------------------

Lock and Keying	Lock with random key: 9201 Polished Chrome only		
	• Double-door wardrobe cabinets	+\$ 66	Specify with lock.

Keying	• Factory- and field-installed keying		▶ Page 440
---------------	---------------------------------------	--	------------

Related Products	• Accessories		▶ Page 387
	• Headboards and footboards		▶ Page 384
	• Mirrors		▶ Page 386

Specification Information

• Dimensions			• Style	• Base
D	W	H	Number	Price

Double-Door Wardrobe Cabinet with One Drawer

24"	36"	68"	H6W2C36R	\$2253
-----	-----	-----	-----------------	--------

Waldorf Dressers

SIN 71.315

Standard Includes	Required to Specify
<ul style="list-style-type: none"> Dresser case: melamine Drawer fronts: rigid thermoform to match case Base: wood to match case Top: rigid thermoform to match rigid thermoform fronts Round knob pull on doors and drawers: satin chrome only Adjustable glides 	<ul style="list-style-type: none"> 1 Style number 2 Laminate color number for dresser 3 Options, if selected (see below) ▶ See <i>Surface Materials</i>, page 402.

Options	Price	Required to Specify
Lock and Keying <ul style="list-style-type: none"> Lock with random key 9201 Polished Chrome only 	+\$34	Specify <i>with lock</i> .
<ul style="list-style-type: none"> Keying Factory- and field-installed keying 		▶ Page 440
Related Products <ul style="list-style-type: none"> Accessories Headboards and footboards Mirrors 		<ul style="list-style-type: none"> ▶ Page 387 ▶ Page 384 ▶ Page 386

Specification Information

Dimensions	Style	Base
D W H	Number	Price

Dressers with Melamine Case and Rigid Thermoform Fronts

With Three Drawers				
18"	32"	30"	H6D330R	\$1246
With Four Drawers				
18"	32"	38"	H6D438R	\$1478

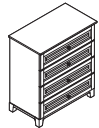
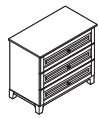

Waldorf Bedside Tables

SIN 71.315

Tip: 18" deep bedside tables have a 15⁵/₈" deep drawer and the slide has 14" of travel. 24" deep bedside tables have a 19⁵/₈" deep drawer and a slide 21" of travel.

Tip: Lock, if selected, will only secure top drawer of cabinet.

Standard Includes	Required to Specify
<ul style="list-style-type: none"> • Bedside table case: melamine • Door or drawer fronts: rigid thermoform to match case • Base: wood to match case • Top: rigid thermoform to match rigid thermoform fronts • Round knob pull on doors and drawers: satin chrome only • Glides: black only 	<ul style="list-style-type: none"> 1 Style number 2 Rigid thermoform color number for bedside table 3 Options, if selected (see below) <p>▶ See <i>Surface Materials</i>, page 402.</p>

Options	Price	Required to Specify
Gallery Rails	• Gallery rails (set of three) +\$106	Specify with gallery rails.
Casters	• Casters (set of four) +\$ 28 • Back roller casters with front glides +\$ 55	Specify with casters. Specify with back roller casters.
Lock and Keying	Lock with random key • 9201 Polished Chrome only +\$ 34	Specify with lock.
	Keying • Factory- and field-installed keying	▶ Page 440
Related Products	• Accessories • Headboards and footboards • Mirrors	▶ Page 387 ▶ Page 384 ▶ Page 386

Specification Information

Dimensions			Style	Base
D	W	H	Number	Price

Bedside Tables with Melamine Case and Rigid Thermoform Fronts

Night Table with One Drawer and Open Shelf

18"	18"	24"	H6NE24R	\$ 706
-----	-----	-----	----------------	--------

Bedside Table with Three Drawers

18"	18"	30"	H6BM30R	\$1098
-----	-----	-----	----------------	--------

Bedside Tables with One Drawer and One Door

Door Hinged on Left

18"	18"	30"	H6BG30LR	\$ 892
-----	-----	-----	-----------------	--------

Door Hinged on Right

18"	18"	30"	H6BG30RR	\$ 892
-----	-----	-----	-----------------	--------



Accessories



Statement of Line **378**



Specifying

Mobile Overbed Tables

Opus Mobile Overbed Table (SIN 71.315)	380
With C-Base (SIN 71.315)	381
With U-Base (SIN 71.315)	382

Headboards and Footboards

For use with Davenport (SIN 71.315)	383
With Plain Panel (SIN 71.315)	384

Mirrors

With Wood Frame (SIN 71.315)	386
------------------------------	------------

Plastic Drawer Liners (SIN 71.315)	387
---	------------

Keys (SIN 71.315)	388
--------------------------	------------

Statement of Line

Accessories

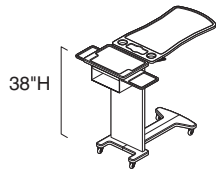

Specifying
▶ Page 380

Opus Mobile Overbed Table

48"W

Mobile Overbed Table ●

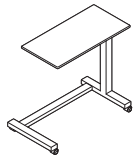

Specifying
▶ Page 381

Mobile Overbed Tables with C-Base

	Rectangular top	Kidney top	Oval top
Laminate	●		
Thermoform	●	●	●

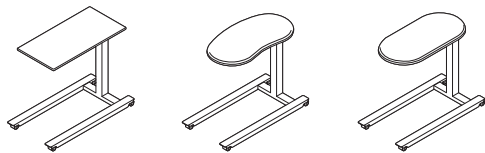

Specifying
▶ Page 382

Mobile Overbed Tables with U-Base

	Rectangular top	Kidney top	Oval top
Laminate	●		
Thermoform	●	●	●

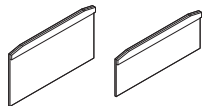

Specifying
▶ Page 383

Headboards and Footboards for use with Davenport

	39"W	54"W	60"W
22"H Headboards	●	●	●
16"H Footboards	●	●	●

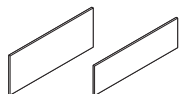

Specifying
▶ Page 384

Headboards and Footboards with Plain Panel

	39"W	54"W	60"W
22"H Headboards	●	●	●
16"H Footboards	●	●	●

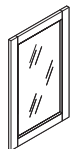

Specifying
▶ Page 386

Mirror with Wood Frame

	32"H
Mirror	●

Opus Mobile Overbed Table

SIN 71.315

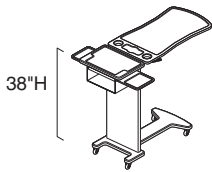

Standard Includes	Required to Specify
<ul style="list-style-type: none"> • Table top: sand thermoform • Adjustable-height H-base: sand plastic only • Column: laminate with 3 mm plastic edge band • Casters: black 	<ol style="list-style-type: none"> 1 Style number 2 Laminate color number for column 3 Edge band color number for column 4 Options, if selected (see below) <p>▶ See <i>Surface Materials</i>, page 402.</p>

	Options	Price	Required to Specify
Surface Materials	• Supplemental surface	+\$132	Specify with supplemental surface.
Drawer	• Vanity drawer with mirror	+\$145	Specify with vanity drawer.

Specification Information

• Dimensions			• Style	• Base
D	W	H	Number	Price

With Adjustable-Height H-Base

16"	30"	27"-42"	HT4818BCHP	\$1640

Mobile Overbed Tables with C-Base

Mobile Overbed Tables
with C-Base

SIN 71.315

Standard Includes	Required to Specify
<ul style="list-style-type: none"> • Table top: High-Pressure Laminate or rigid thermoform with spill collector • Edge band: 3 mm plastic to match the laminate top • Mechanical adjustable-height, heavy duty C-base: chrome • Casters: black 	<ol style="list-style-type: none"> 1 Style number 2 Laminate color number for top, if selected 3 Thermoform color number for top, if selected 4 Options, if selected (see below) <p>▶ See <i>Surface Materials</i>, page 402.</p>

Tip: Optional base paint colors black, grey, brown, and almond have been removed, but are available through Specials.

Options	Price	Required to Specify
Drawer • Vanity drawer with mirror	+\$145	Specify with vanity drawer.

Specification Information

• Dimensions			• Style	• Base
D	W	H	Number	Price

With Rectangular Laminate Top

18"	34"	30"–45 ⁵ / ₈ "	HTC1834RL	\$1101

With Thermoformed Top

18"	34"	30"–45 ⁵ / ₈ "	HTC1834RR	\$1048
-----	-----	--------------------------------------	------------------	--------

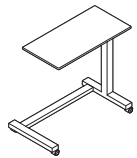

Mobile Overbed Tables with U-Base

SIN 71.315

Tip: Optional base paint colors black, grey, brown, and almond have been removed, but are available through Specials.

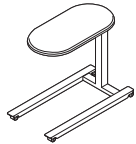
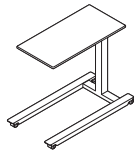
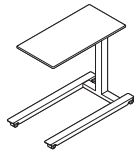

Standard Includes	Required to Specify
<ul style="list-style-type: none"> Table top: High-Pressure Laminate or rigid thermoform with spill collector Edge band: 3 mm plastic to match the laminate top Mechanical adjustable-height U-base: chrome Casters: black 	<ol style="list-style-type: none"> Style number Laminate color number for top, if selected Thermoform color number for top, if selected Options, if selected (see below) <p>▶ See <i>Surface Materials</i>, page 402.</p>

Options	Price	Required to Specify
Drawer • Vanity drawer with mirror	+\$145	Specify with vanity drawer.

Specification Information

• Dimensions	• Style	• Base
D W H	Number	Price

With Rectangular Laminate Top

15" 30" 28 ⁵ / ₁₆ "-44"	HTU1530RL	\$1227

With Thermoformed Top

Rectangular

15" 30" 28 ⁵ / ₁₆ "-44"	HTU1530RR	\$1174
18" 34" 28 ⁵ / ₁₆ "-44"	HTU1834RR	\$1227

Kidney

15" 30" 28 ⁵ / ₁₆ "-44"	HTU1530KR	\$1206
---	------------------	--------

Oval

18" 34" 28 ⁵ / ₁₆ "-44"	HTU1834VR	\$1259

Headboards and Footboards for use with Davenport

Headboards and Footboards
for use with Davenport

SIN 71.315

Standard Includes	Required to Specify
<ul style="list-style-type: none"> • Headboard: laminate • Footboard: laminate 	<ul style="list-style-type: none"> 1 Style number 2 Laminate color number for headboard and/or footboard 3 Options, if selected (see below) ▶ See <i>Surface Materials</i>, page 402.

Tip: Headboard-mounting legs fasten to the bed frame when using box spring and mattress.

Options	Price	Required to Specify
Headboard-Mounting Legs <ul style="list-style-type: none"> • Headboard-mounting legs 	+\$162	Specify with headboard-mounting legs.

Specification Information

• Dimensions	• Style	• Base
W H	Number	Price

Headboards			
39"	22"	70HB3901	\$295
54"	22"	70HB5401	\$357
60"	22"	70HB6001	\$382

Footboards			
39"	16"	70FB3901	\$161
54"	16"	70FB5401	\$243
60"	16"	70FB6001	\$257

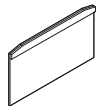

Headboards and Footboards with Plain Panel

SIN 71.315

Standard Includes	Required to Specify
<ul style="list-style-type: none"> • Headboard: melamine, wood veneer, or rigid thermoform • Footboard: melamine • Headboard mounting leg: wood veneer 	<ol style="list-style-type: none"> 1 Style number 2 Laminate, wood, or rigid thermoform color number for headboard 3 Laminate color number for footboard 4 Wood color number for headboard mounting leg 5 Options, if selected (see below) <p>▶ See <i>Surface Materials</i>, page 402.</p>

Tip: Crown molding option available on melamine and wood veneer headboards only.

Options	Price	Required to Specify
Crown Molding	<ul style="list-style-type: none"> • 39"W headboard +\$116 • 54"W headboard +\$151 • 60"W headboard +\$169 	<p>Specify <i>with crown molding</i>.</p> <p>Specify <i>with crown molding</i>.</p> <p>Specify <i>with crown molding</i>.</p>

Specification Information

Dimensions	Style Number	Base Price
W H	Number	Price

Headboards

Melamine

39"	22"	HHB3901L	\$252
54"	22"	HHB5401L	\$341
60"	22"	HHB6001L	\$364

Wood

39"	22"	HHB3901W	\$372
54"	22"	HHB5401W	\$483
60"	22"	HHB6001W	\$517

Rigid Thermoform

39"	22"	HHB3901R	\$420
54"	22"	HHB5401R	\$547
60"	22"	HHB6001R	\$586

Footboards

Melamine

39"	16"	HFB3901L	\$247
54"	16"	HFB5401L	\$321
60"	16"	HFB6001L	\$343

▶ **Specification Information, continued on next page**

SIN 71.315

► Specification Information, continued from previous page

Specification Information

• Dimensions	• Style	• Quantity	• Base
H	Number		Price

Headboard Mounting Leg

29"	HHBL	2	\$163
:	:	:	:



Tip: Headboard-mounting legs fasten to the bed frame when using box spring and mattress.

Mirror with Wood Frame

SIN 71.315

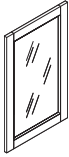

Standard Includes	Required to Specify
<ul style="list-style-type: none"> • Mirror: reflective glass • Frame: wood • Mounting hardware 	<ul style="list-style-type: none"> 1 Style number 2 Wood color number for frame ▶ See <i>Surface Materials</i>, page 402.

Specification Information			
• Dimensions		• Style	• Price
W	H	Number	
20"	32"	HMR3201W	\$395
:	:	:	:

Accessories

For Use with Ainsley, Davenport, Park, Senza, and Waldorf

SIN 71.315

Plastic Drawer Liners

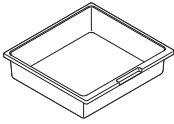

Tip: 18" drawer liners are for use with Ainsley, Park, Senza, and Waldorf bedside tables only.

Tip: 32" drawer liners are for use with Ainsley, Senza, and Waldorf dressers only.

Standard Includes	Required to Specify
• Package of four plastic drawer liners: white only	Style number

Specification Information

• Dimensions	• Style Number	• Price
18"	HADL18	\$149
32"	HADL32	\$345

Keys

SIN 71.315

Standard Includes	Required to Specify
• Key	Style number

Specification Information

• Style Number	• Price
:	:
:	:

Master Key for use with Davenport

MSKEYW	\$32
:	:

Technology Support

► For more detailed product information, see the *Steelcase Health Seating and Casegoods Specification Guides*, or consult your Steelcase dealer.

	
Statement of Line	390

	
Specifying	
Pocket (SIN 71.315)	391
Relay (SIN 71.315)	394

Statement of Line

Technology Support

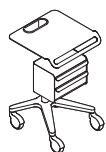

With Two Bin Unit

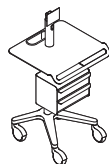

With Monitor Mount
and With Two Bin Unit

Specifying
▶ Page 391

Pocket

36"H Fixed Height

18"W



22"W



25"W

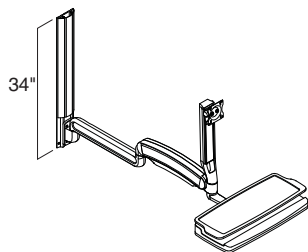

With Extension

Specifying
▶ Page 394

Relay



Standard CPU Holder



Enclosed CPU Holder

Specifying
▶ Page 395

Relay Arm Accessories

Pocket Without Monitor Mount

SIN 71.315

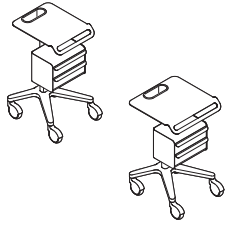

Standard Includes	Required to Specify
<ul style="list-style-type: none"> • Top surface: powder coat painted steel top • Column and base: 7243 Seagull paint only • Two bin unit: plastic to match top • Casters: 4" soft casters, gray only 	<ul style="list-style-type: none"> 1 Style number 2 Paint color number for top surface ▶ See <i>Surface Materials</i>, page 402.

Specification Information				
• Dimensions			• Style	• Price
D	W	H	Number	

Fixed Height

With Two Bin Unit

21½"	18"	36"	HP1822FB	\$1829
22½"	22"	36"	HP2322FB	\$1829

Pocket With Monitor Mount

SIN 71.315



Standard Includes	Required to Specify
<ul style="list-style-type: none"> • Top surface: powder coat painted steel top • Column and base: 7243 Seagull paint only • Two bin unit, if selected: plastic to match top • Casters: 4" soft casters, gray only 	<ul style="list-style-type: none"> 1 Style number 2 Paint color number for top surface ▶ See <i>Surface Materials</i>, page 402.

Specification Information

• Dimensions			• Style	• Price
D	W	H	Number	

Fixed Height

With Two Bin Unit				
D	W	H	Style Number	Price
23½"	24"	36"	HP2225FB	\$2274

Pocket Accessories

SIN 71.315

Scanner Holder



Standard Includes	Required to Specify
<ul style="list-style-type: none"> Scanner holder: molded soft plastic with encapsulated magnet, gray only 	Style number

Specification Information		
Style Number	Price	Quantity
HPSCANNER	\$49	1

Cup Holder



Standard Includes	Required to Specify
<ul style="list-style-type: none"> Cup holder: molded soft plastic with encapsulated magnet, gray only 	Style number

Specification Information		
Style Number	Price	Quantity
HPCUP	\$49	1

Relay Arm

Wall-Mount Column

SIN 71.315

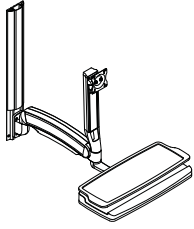

Standard Includes	Required to Specify
-------------------	---------------------

- | | |
|---|---|
| <ul style="list-style-type: none"> ▶ Need help? Product details, see <i>Steelcase Health Volume 2 Specification Guide</i>. | <ul style="list-style-type: none"> • Wall-mount column: white paint • Track: white satin • Keyboard tray: gray high density polyethylene |
|---|---|

Style number

Specification Information		
• Dimensions	• Style	• Price
• Length	• Number	

34"	HTW34	\$1527
:	:	:

Relay Arm Accessories

SIN 71.315

Extension Arm



Tip: Use with 34" wall mount unit.

Standard Includes		Required to Specify
<ul style="list-style-type: none"> ▶ Need help? Product details, see <i>Steelcase Health Volume 2 Specification Guide</i>. 	<ul style="list-style-type: none"> • Extension arm: white paint 	Style number
Specification Information		
Dimension	Style Number	Price
D		
20"	HTAX2	\$308

CPU Holders



Tip: Maximum recommended wattage of CPU is 396 watts.

Standard Includes		Required to Specify
<ul style="list-style-type: none"> ▶ Need help? Product details, see <i>Steelcase Health Volume 2 Specification Guide</i>. 	<ul style="list-style-type: none"> • CPU holder: gray paint 	Style number
Specification Information		
Dimensions	Style Number	Price
D W H		
Standard CPU Holder		
1¼"-4" 10"	7¼"	HTCU2 \$205
Enclosed CPU Holder		
4"	15¾" 12½"	HTCS2 \$410



Steelcase Health Tables

► For more detailed product information, see the *Steelcase Health Seating and Casegoods Specification Guides*, or consult your Steelcase dealer.



Statement of Line

398



Specifying

Exchange Tables (SIN 711.11)

399

Statement of Line

Steelcase Health Tables

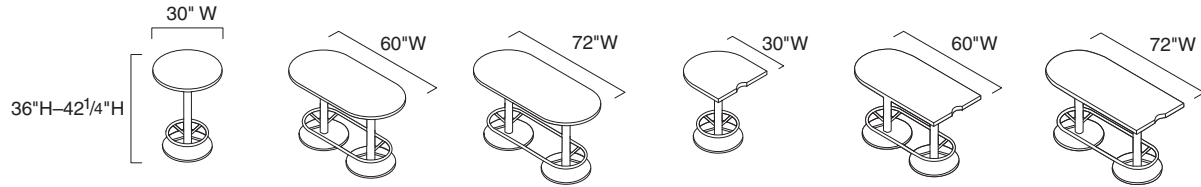

Specifying
▶ Page 399

Exchange Tables

	30\"/>		
Round	●		
Oval		●	●
Bullet	●	●	●

Exchange Tables

SIN 711.11

For laminate price group 2 pricing, please refer to the electronic catalog or SmartTools.

Standard Includes	Required to Specify
<ul style="list-style-type: none"> • Worksurface: High-Pressure Laminate price group 1 • Edge: 3 mm plastic • Bullet back edge, if selected: flat profile • Base: paint price group 1 • Glides: clear plastic only • Attachment hardware 	<ol style="list-style-type: none"> 1 Style number 2 Laminate color number for worksurface 3 Plastic color number for edge 4 Paint color number for base 5 Options, if selected (see below) <p>▶ See <i>Surface Materials</i>, page 402.</p>

Options	Price	Required to Specify
Surface Materials <ul style="list-style-type: none"> • Laminate price group 1 • Laminate price group 2 • Open Line laminate 	No cost See information at left +\$69 plus cost of laminate	<p>▶ See <i>Surface Materials</i>, page 402.</p> <p>▶ Specify laminate color number.</p> <p>▶ See <i>Surface Materials</i>, page 402.</p>
Bases <ul style="list-style-type: none"> • Paint price group 1 • Paint price group 2 	No cost +\$30 per base	Specify paint color number. Specify paint color number.
Scallops <ul style="list-style-type: none"> • Omit scallop 	No cost	Specify <i>omit scallop</i> .
Related Products <ul style="list-style-type: none"> • Verge stool 		▶ Page 157

Specification Information				
Dimensions			Style	Base
D	W	H	Number	Price
:	:	:	:	:
:	:	:	:	:

30" Round Tables

30"	30"	36"	HX30SL	\$ 832
30"	30"	42 1/4"	HX30CL	\$ 844
:	:	:	:	:

60" Oval Tables

30"	60"	36"	HX3060SL	\$1699
30"	60"	42 1/4"	HX3060CL	\$1724
:	:	:	:	:

72" Oval Tables

30"	72"	36"	HX3072SL	\$1760
30"	72"	42 1/4"	HX3072CL	\$1784
:	:	:	:	:

30" Bullet Tables

30"	30"	36"	HX30BSL	\$ 832
30"	30"	42 1/4"	HX30BCL	\$ 844
:	:	:	:	:

60" Bullet Tables

30"	60"	36"	HX3060BSL	\$1699
30"	60"	42 1/4"	HX3060BCL	\$1724
:	:	:	:	:

72" Bullet Tables

30"	72"	36"	HX3072BSL	\$1760
30"	72"	42 1/4"	HX3072BCL	\$1784
:	:	:	:	:

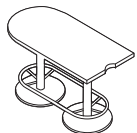
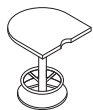
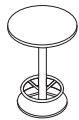

Surface Materials

Steelcase Health Surface Materials	402
Color Availability Matrix for Steelcase Health Casegoods	406
Color Availability Matrix for Steelcase Health Seating and Tables	408
Wood Veneer Matrix for Steelcase Health Seating and Tables	412
Recommended Worksurface Edge Finishes	414
Modular Casegoods Directional Laminate	415
Freestanding Casegoods Directional Laminate	417
Upholstery and Color Numbers	418
Steelcase Health Graded-In Programs	420
Acrylic Panel	420
Solid Surface	420
Upholstery	421
Fabric Application Direction Guidelines	422
Approved Fabrics that Meet DFAR 252.225-7012 Preference for Certain Domestic Commodities Used for Navy BPA	423

Steelcase Health Surface Materials

This listing includes all the surface material choices that are available for the Steelcase Health products in this specification guide.

Resources

For more information about Steelcase Health surface materials or to get surface material samples, contact Steelcase Health at 1.800.342.8562.

Materials and colors are not available on every product. Refer to the Color Availability Matrices before specifying.

Plastisol/Urethane

6059 Sterling Dark
6161 Graphite
6162 Taupe
6205 Black
6249 Platinum Solid
6259 Midnight
6527 Merle

Paint

► See *Paint Color Availability Matrix* on page 406 for color availability by product line.

Steelcase Surfaces

Price Group 1

Smooth Paint
4242 Milk

Textured Paint

7207 Black
7225 Sand
7236 Fog
7237 Slate
7238 Fieldstone
7239 Midnight
7241 Arctic White
7243 Seagull
7278 Dark Bronze
7360 Merle

Price Group 2

Smooth Paint
0835 Black

Smooth Metallic Paint

4140 Arctic White Gloss
4728 Nickel Metallic
4743 Mineral Metallic
4744 Pearl Metallic
4750 Champagne Metallic
4752 Steel Metallic
4788 Gold Dust Metallic
4798 Sterling Metallic
4799 Platinum Metallic
4803 Near Black Metallic

Textured Metallic Paint

7245 Carbon Metallic
7246 Midnight Metallic

Custom Surfaces

Price Group 3

Accent Paint

Accent paints allow you to choose from a pre-matched color palette of trend driven colors. Refer to the *Surface Materials Reference Manual* for more information.

Applies to:
• Embold tables

Lux Coatings

4B20 Obsidian
4B22 Matte Brass
4B23 Burnished Bronze
4B24 Night Bronze
4B25 Matte Copper
4B26 Smoked Mica
4B27 Blue Steel
4B28 Silver Lilac
4B29 Cast Iron
4B30 Bright Gold

Custom Surfaces

Price Group 3

PerfectMatch

PerfectMatch is a service that allows you to create your own paint color. Refer to the *Surface Materials Reference Manual* for more information about this program.

Tip: The PerfectMatch program is only available for Regard and Surround.

Wood

Veneer

3062 Graphite Walnut
3402 Clear Cherry
3412 Natural Cherry
3422 Medium Cherry
3522 Clear Maple
3576 Almond Cherry
3579 Dark Rum Cherry
3580 Shiraz Cherry
3592 Blonde on Maple
3702 Clear Walnut
3712 Natural Walnut

Applies to:

• Tava
3456 Clear on Ash
3457 Almond on Ash
3460 Dark Rum on Ash
3461 Shiraz on Ash

Steelcase Surfaces

For information on products within Select Surfaces, including accent paints and fabrics from Designtex, Gabriel, Kvadrat, and Pollack, please refer to the *Surface Materials Reference Manual* or visit steelcase.com/surface-materials under the Select Surfaces section.

Natural Veneer

Natural veneer is available in the Select Surfaces offering. Natural veneer may have extended leadtimes. Place your order as you normally would for any other finish, calling out the appropriate finish code. Natural veneers are Graded-In as Wood Group 1 pricing.

The following finishes are available through the natural veneer offering:

Flat-cut open-pore finish choices

35A2 FC/OP Blanch Maple
37A2 FC/OP Thunder Walnut

Quarter-cut open-pore finish choices

32A2 QC/OP Blanch Maple
33A2 QC/OP Thunder Walnut

Rift-cut open-pore finish choices

36A2 RC/OP Volcanic Oak

Laminate

Laminate

2406 Clear Cherry
2409 Clear Maple
2410 Graphite Walnut
2422 Medium Cherry
2538 Clear Walnut
2571 Almond Cherry
2574 Dark Rum Cherry
2575 Shiraz Cherry
2592 Blonde on Maple
2714 Natural Walnut

Steelcase Surfaces

High-Pressure Laminate

Price Group 1

Applies to:

• Aspect table tops
• Embold tables
• Exchange tables
• Folio worksurfaces
• Mitra table tops
• Opus tops
• Regard tables
• Regard media and desk cabinets
• Sieste legs
• Sieste tables
• Sonata tops
• Sync
• X-tenz sleeper frame
• Freestanding and interconnecting tables

Tip: all products may not be available in all colors listed below.

Fiber Laminate

2850 Vanadium Fiber
2851 Rhyme Fiber
2852 Tungsten Fiber
2854 Vellum Fiber
2859 Novell Fiber
2860 Granite Fiber
2861 Coconut Fiber
2862 Stucco Fiber

Micro Laminate

2920 Marl Micro
2921 Gypsum Micro
2922 Clay Micro
2923 Shadow Micro

Patina Laminate

2870 Blonde Bronze Patina
2871 Blackened Bronze Patina
2873 Instant Iron Patina

Solid Laminate

2722 Cream
2730 Arctic White
2746 Black
2759 Warm White
2811 Mist
2883 Seagull
2884 Milk
2885 Dune
2HMG Merle

Speckle Laminate

2820 Coffee Speckle
2822 Woodrose Speckle
2823 Driftwood Speckle
2824 Smoke Speckle
2825 Vanadium Speckle

Woodgrain Laminate

2406 Clear Cherry
2409 Clear Maple
2410 Graphite Walnut
2412 Natural Cherry
2422 Medium Cherry
2511 Winter on Maple
2538 Clear Walnut
2592 Blonde on Maple
2714 Natural Walnut
2HAK Clear Oak
2HAN Ash Noce
2HAT Acacia
2HAW Ash Wenge
2HBN Bisque Noce
2HBW Bisque Wenge
2HCN Clay Noce
2HCW Clay Wenge
2HSN Storm Noce
2HSW Storm Wenge

Applies to:

• Exchange tables
• Embold tables
• Folio worksurfaces

Select Surfaces

High-Pressure Laminate

Price Group 1

Textured Woodgrain Laminate

2TH2 Fawn Cypress
2TH3 Weathered Char
2TH4 Saddle Oak
2TH5 Veranda Teak
2TH6 Persian Cherry
2TH7 Walnut Heights

Price Group 2

Textured Industrial Laminate

2UH1 Reclaimed Aggregate
2UH2 Reclaimed Gravel
2UH4 Cement
2UH6 Sheetrock

Steelcase Melamine

Applies to:

- Folio cabinets
- Folio bookcases
- Folio desk frames
- Folio storage shelves, fillers, and mounting board
- Opus wall cabinets
- Opus end panels and fascia
- Opus mounting boards
- Regard desk and media cabinets

- 2409 Clear Maple
- 2410 Graphite Walnut
- 2412 Natural Cherry
- 2511 Winter on Maple
- 2535 Virginia Walnut
- 2536 Blackwood
- 2538 Clear Walnut
- 2571 Almond Cherry
- 2574 Dark Rum Cherry
- 2575 Shiraz Cherry
- 2612 Marbled Maple
- 2614 Chocolate Walnut
- 2615 Marbled Cherry
- 2730 Arctic White
- 2883 Seagull
- 2885 Dune
- 2HAK Clear Oak
- 2HAT Acacia

Applies to:

- Folio cabinets
- Folio bookcases
- Folio desk frames
- Folio storage shelves, fillers, and mounting board
- 2884 Milk
- 2HMG Merle

Applies to:

- Folio cabinets
- Folio bookcases
- Folio desk frames
- Folio storage shelves, fillers, and mounting board
- Regard desk and media cabinets

- 2LAN Ash Noce
- 2LAW Ash Wenge
- 2LBN Bisque Noce
- 2LBW Bisque Wenge
- 2LCN Clay Noce
- 2LCW Clay Wenge
- 2LSN Storm Noce
- 2LSW Storm Wenge

Tip: Melamine finishes may be represented by HPL or LPL finish codes.

turnstone Laminate Collection

A selection of laminates and edge bands in this collection are available on Steelcase brand products. This collection is available with standard leadtimes and supported like standard laminates to help make ordering easy. Please see the turnstone section of village.steelcase.com for swatching information.

- 2535 Virginia Walnut
- 2536 Blackwood
- 2612 Marbled Maple
- 2614 Chocolate Walnut
- 2615 Marbled Cherry

Custom Surfaces

Open Line Laminate (OLL)

Applies to:

- Embold tables
- Exchange tables
- Folio Laminate worksurfaces
- Regard Worksurfaces
- Sync Worksurfaces

Open Line laminates

are available at an additional \$69 per unit, plus the cost of the laminate. Example: 4' x 8' sheet = 32 square feet 32 square feet x \$1.10 = \$35.20 per sheet. High-Pressure Laminate pricing does not include premium or digitally printed patterns from any suppliers. Laminate costs vary by supplier. The cost of the laminate will be added to your invoice as a separate line on the acknowledgement.

This service allows you to order non-standard laminate at an additional fee per unit. See the specification pages for upcharge information.

Steelcase Health

Laminates that are not called out as standard on Steelcase products will be processed as an Open Line laminate and Open Line laminate charges will apply.

When processing orders for Open Line Laminate on Exchange tables, Folio Laminate Worksurfaces, Regard Worksurfaces, and Sync, specify 2900 in the laminate finish field and enter the OLL manufacturer information.

Edge bands must also be specified using the plastic edge band offering.

Thermoform

- 2030 Arctic White
- 2031 Seagull
- 2032 Dune
- 2066 Almond Cherry
- 2069 Dark Rum Cherry
- 2070 Shiraz Cherry
- 6775 Sand

Solid Surface

Applies to:

- Aspekt straight arms
- Embold
- Folio worksurfaces
- Leela table tops
- Regard table tops and desk
- Senza tops
- Sonata tops
- Sync worksurfaces
- Tava table top and benches

Price Group A

- 2801 Glacier White
- 2975 Bisque

Price Group B

- 2973 Linen

Price Group C

- 2972 Antarctica
- 2974 Canvas
- See page 420 for additional graded-in solid surfaces

Plastic Edge Band Steelcase Surfaces

- 6014 Almond Cherry
- 6023 Dark Rum Cherry
- 6024 Shiraz Cherry
- 6036 Medium Cherry
- 6038 Blonde on Maple
- 6041 Natural Walnut
- 6231 Graphite Walnut
- 6234 Clear Cherry
- 6237 Clear Maple
- 6245 Clear Walnut

Applies to:

- Embold tables
- Exchange tables
- Folio Worksurfaces
- Opus
- Regard Tables
- Regard Media and Desk Cabinets
- Sonata
- Sync

Tip: All products may not be available in all colors listed below.

- 6000 Black
- 6001 Coffee
- 6009 Arctic White
- 6034 Natural Cherry
- 6037 Winter on Maple
- 6052 Milk
- 6053 Seagull
- 6213 Acacia
- 6219 Clear Oak
- 6242 Virginia Walnut
- 6243 Blackwood
- 6246 Warm Oak
- 6249 Platinum Solid
- 6527 Merle
- 6615 Grey V5
- 6619 Ice
- 6631 Cream
- 6635 Dawn
- 6636 Mist
- 6654 Sand
- 6655 Warm White
- 6676 Marbled Maple
- 6677 Chocolate Walnut
- 6678 Marbled Cherry
- 6695 Midnight
- 6697 Fog
- 6703 Ash Wenge
- 6704 Bisque Wenge
- 6705 Clay Wenge
- 6706 Storm Wenge
- 6707 Ash Noce
- 6708 Bisque Noce
- 6709 Clay Noce
- 6710 Storm Noce

Select Surfaces

Applies to:

- 3 mm edge on Embold tables
- 1 mm and 3 mm edge on Exchange tables and Folio worksurfaces
- 6T02 Fawn Cypress
- 6T03 Weathered Char
- 6T04 Saddle Oak
- 6T05 Veranda Teak
- 6T06 Persian Cherry
- 6T07 Walnut Heights
- 6T08 Aggregate
- 6T09 Gravel
- 6T10 Cement
- 6T12 Sheetrock

Fusion

Applies to:

- Sonata island modules

Price Group 1

- 6526 Mulberry Tissue

Price Group 3

- 6523 Desert Stalk

Price Group 4

- 6525 Sheer Leaf Medium
- See page 418 for additional graded-in fusion options.

Markerboard

Applies to:

- Opus wardrobe cabinet with sliding door only
- White

Urethane

Applies to:

- Verge seat
- 6688 Non metallic steel

CuraNet

Applies to:

- Cura
- 5081 Ash (Silver Grey)
- 5083 Lily Pad (Moss)
- 5085 Ebony (Black)
- 5086 Camel
- 5087 Cocoa
- 5088 Aquamarine

Promessa

Applies to:

- Cura
- UL81 Ash
- UL83 Lily Pad
- UL85 Ebony
- UL86 Camel
- UL87 Cocoa
- UL88 Aquamarine

Upholstery

► See page 418 for a complete listing of upholstery colors and numbers.

Braided Cord Color Matrix

Applies to:
• Embold tables

Braided cord samples are not available to order. Use matrix below that compares the braided cord finish to the nearest Steelcase finish or Pantone color for color reference purposes.

Finish	Color Reference
9002 Silver	10388 C (Pantone Color)
9003 Fuchsia	4BQ7 Fuchsia
9004 Marlin	4AZ5 Marlin
9006 Chili	6338 Chili
9007 Sterling	6059 Sterling Dark Solid
9008 Honey	4CZ5 Honey
9009 Black	0835 Black
9010 Light Peacock	4CZ8 Light Peacock
9011 Seagull	4858 Seagull
9012 Merle	6527 Merle
9013 Brass	10362 C (Pantone Color)

Color Availability Matrix for Steelcase Health Casegoods

Legend

- = Not available
- = Available
- = Available with exceptions
- ▶ See specification pages for details.

		Veneer						Laminate								Solid Surface					
		3062	3522	3576	3579	3580	3702	2409	2410	2538	2571	2574	2575	2730	2883	2885	2801	2972	2973	2974	2975
		Graphite Walnut	Clear Maple	Almond Cherry	Dark Rum Cherry	Shiraz Cherry	Clear Walnut	Clear Maple	Graphite Walnut	Clear Walnut	Almond Cherry	Dark Rum Cherry	Shiraz Cherry	Arctic White	Seagull	Dune	Glacier White	Antarctica	Linen	Canvas	Bisque
Ainsley		•	•	■	■	■	•	•	•	■	■	■	•	•	•	•	•	•	•	•	•
Davenport		•	•	•	•	•	•	■	■	■	■	■	■	•	•	•	•	•	•	•	•
Exchange Table	Base	•	•	•	•	•	•	•	•	•	•	•	•	•	•	•	•	•	•	•	•
	Table Top*	•	•	•	•	•	•	■	■	■	■	■	■	■	■	■	•	•	•	•	•
Folio	Cabinets	•	•	•	•	•	•	■	■	■	■	■	■	■	■	■	•	•	•	•	•
	Laminate Worksurfaces*	•	•	•	•	•	•	■	■	■	■	■	■	■	■	■	•	•	•	•	•
	Solid Surface Worksurfaces	•	•	•	•	•	•	•	•	•	•	•	•	•	•	•	■	■	■	■	■
Opus	Cabinets	•	•	•	•	•	•	■	■	■	■	■	■	■	■	■	•	•	•	•	•
	Door Pulls, Table Rails, and Coat Hooks	•	•	•	•	•	•	•	•	•	•	•	•	•	•	•	•	•	•	•	•
Park		•	•	•	•	•	•	•	•	•	■	■	■	■	■	■	•	•	•	•	•
Senza		•	•	•	•	•	•	■	■	■	■	■	■	•	•	•	■	■	■	■	■
Sonata*	Cabinets	•	•	•	•	•	•	■	■	■	■	■	■	■	■	■	■	■	■	■	■
	Rails, Drawer/Door Pulls, and Coat Hooks	•	•	•	•	•	•	•	•	•	•	•	•	•	•	•	•	•	•	•	•
Sync*		•	•	•	•	•	•	■	■	■	■	■	■	■	■	■	■	■	■	■	■
Waldorf		•	•	•	•	•	•	•	•	•	•	•	•	•	•	•	•	•	•	•	•
Overbed Tables**		•	•	•	•	•	•	■	■	■	■	■	■	■	■	■	•	•	•	•	•
Headboards/Footboards		•	■	■	■	■	■	■	■	■	■	■	■	•	•	•	•	•	•	•	•

* Exchange table tops, Folio worksurfaces, Sonata tops, and Sync table tops are available in all Steelcase laminates.

** Opus overbed table top is only available in sand thermoform.

Thermoform												
2030	Arctic White	•	•	•	•	•	•	•	•	•	•	•
2031	Seagull	•	•	•	•	•	•	•	•	•	•	•
2032	Dune	•	•	•	•	•	•	•	•	•	•	•
2066	Almond Cherry	•	•	•	•	•	•	•	•	•	•	•
2069	Dark Rum Cherry	•	•	•	•	•	•	•	•	•	•	•
2070	Shiraz Cherry	•	•	•	•	•	•	•	•	•	•	•
Fusion												
6523	Desert Stalk	•	•	•	•	•	•	•	•	•	•	•
6525	Sheer Leaf Medium	•	•	•	•	•	•	•	•	•	•	•
6526	Creamsicle	•	•	•	•	•	•	•	•	•	•	•
Paint												
4750	Champagne Metallic	•	•	•	•	•	•	•	•	•	•	•
4798	Sterling Metallic	•	•	•	•	•	•	•	•	•	•	•
4799	Platinum Metallic	•	•	•	•	•	•	•	•	•	•	•
7207	Black	•	•	•	•	•	•	•	•	•	•	•

Color Availability Matrix for Steelcase Health Seating and Tables

Legend

- = Not available
- = Available
- = Available with exceptions
- ▶ See specification pages for details.

		Paint																						
		0835	4140	4242	4728	4743	4750	4752	4788	4798	4799	4803	7207	7225	7236	7237	7238	7239	7241	7243	7245	7246	7278	7360
		Black	Arctic White Gloss	Milk	Nickel Metallic	Pearl Metallic	Champagne Metallic	Steel Metallic	Gold Dust Metallic	Sterling Metallic	Platinum Metallic	Near Black Metallic	Black	Sand	Fog	Slate	Fieldstone	Midnight	Arctic White	Seagull	Carbon Metallic	Midnight Metallic	Dark Bronze	Merle
Aspekt	Seating Frame	•	•	•	•	•	■	•	•	•	■	•	■	•	•	•	•	•	•	•	•	•	•	■
	Straight Arm Cap	•	•	•	•	•	•	•	•	•	•	•	•	•	•	•	•	•	•	•	•	•	•	•
	Wave Arm Cap	•	•	•	•	•	•	•	•	•	•	•	•	•	•	•	•	•	•	•	•	•	•	•
	Table, Footstool, and Bench Frame and Legs	•	•	•	•	•	■	•	•	•	■	•	■	•	•	•	•	•	•	•	•	•	•	■
	Table Top	•	•	•	•	•	•	•	•	•	•	•	•	•	•	•	•	•	•	•	•	•	•	•
Cura	Arm Caps	•	•	•	•	•	•	•	•	•	•	•	•	•	•	•	•	•	•	•	•	•	•	•
	Frame	•	•	•	•	•	■	•	•	•	■	•	■	■	•	•	•	•	•	•	•	•	•	•
	Tablet Surface	•	•	•	•	•	•	•	•	•	•	•	•	•	•	•	•	•	•	•	•	•	•	•
Embold	Arm Caps	•	•	•	•	•	•	•	•	•	•	•	•	•	•	•	•	•	•	•	•	•	•	•
	High Back Bracket	•	•	•	•	•	•	•	•	■	■	■	•	•	•	•	•	•	•	•	•	•	•	■
	High Back Bracket Cover	■	•	•	•	•	•	•	•	■	■	■	•	•	•	•	•	•	•	•	•	•	•	■
	Seating Frame	•	■	■	•	•	■	•	•	■	■	■	•	•	•	•	•	•	•	•	■	•	•	■
	Table Frame	•	■	•	•	•	•	•	•	■	■	■	•	•	•	•	•	•	•	•	■	•	•	■
	Table Legs	•	■	■	•	•	■	•	•	■	■	■	•	•	•	•	•	•	•	•	■	•	•	■
	Table Top	•	•	•	•	•	•	•	•	•	•	•	•	•	•	•	•	•	•	•	•	•	•	•
	Standard Adjustable Glides	•	•	•	•	•	•	•	•	•	•	•	•	•	•	•	•	•	•	•	•	•	•	•
Wallsaver Glides	•	•	•	•	•	•	•	•	•	•	•	•	•	•	•	•	•	•	•	•	•	•	•	
Empath	Upper Arms	•	•	•	•	•	•	•	•	•	•	•	•	•	•	•	•	•	•	•	•	•	•	•
	Tablet Surface	•	•	•	•	•	•	•	•	•	•	•	•	•	•	•	•	•	•	•	•	•	•	•
Jarrah	Side Trim Panel	•	•	•	•	•	•	•	•	•	•	•	•	•	•	•	•	•	•	•	•	•	•	•
	Seating Legs	•	•	•	•	•	■	•	•	•	■	•	■	•	•	•	•	•	•	•	•	•	•	■
	Arm Caps	•	•	•	•	•	•	•	•	•	•	•	•	•	•	•	•	•	•	•	•	•	•	•
Leela	Arm Caps	•	•	•	•	•	•	•	•	•	•	•	•	•	•	•	•	•	•	•	•	•	•	•
	Legs	•	•	•	•	•	■	•	•	■	■	•	■	•	•	•	•	•	•	•	•	•	•	■
	Table Top	•	•	•	•	•	•	•	•	•	•	■	■	■	■	■	■	■	■	■	•	•	•	•
Mineral	Arm Caps	•	•	•	•	•	•	•	•	•	•	•	•	•	•	•	•	•	•	•	•	•	•	•
	Tablet Surface	•	•	•	•	•	•	•	•	•	•	•	•	•	•	•	•	•	•	•	•	•	•	•
Mitra	Seating Frame	•	•	•	•	•	•	•	•	•	•	•	•	•	•	•	•	•	•	•	•	•	•	•
	Table Legs and Bases	•	•	•	•	•	•	•	•	•	•	•	•	•	•	•	•	•	•	•	•	•	•	•
	Table Top	•	•	•	•	•	•	•	•	•	•	•	•	•	•	•	•	•	•	•	•	•	•	•
	Tablet Surface	•	•	•	•	•	•	•	•	•	•	•	•	•	•	•	•	•	•	•	•	•	•	•
Neighbor	Frames	•	•	•	•	•	•	•	•	•	■	•	•	•	•	•	•	•	•	•	•	•	•	•

Plastisol/Urethane	
6059 Sterling Dark	•
6161 Graphite	•
6162 Taupe	•
6205 Black	•
6249 Platinum Solid	•
6259 Midnight	•
6322 Fieldstone	•
6527 Merle	•
Laminate	
2406 Clear Cherry	•
2409 Clear Maple	•
2410 Graphite Walnut	•
2422 Medium Cherry	•
2538 Clear Walnut	•
2571 Almond Cherry	•
2574 Dark Rum Cherry	•
2575 Shiraz Cherry	•
2592 Blonde on Maple	•
2714 Natural Walnut	•
Thermoform	
2066 Almond Cherry	•
2069 Dark Rum Cherry	•
2031 Seagull	•
6775 Sand	•
Solid Surface	
2801 Glacier White	•
2972 Antarctica	•
2973 Linen	•
2974 Canvas	•
2975 Bisque	•

Color Availability Matrix for Steelcase Health Seating and Tables, continued

Legend

- = Not available
- = Available
- = Available with exceptions
- ▶ See specification pages for details.

		Paint																									
		0835	4140	4242	4728	4743	4744	4750	4752	4788	4798	4799	4803	7207	7225	7236	7237	7238	7239	7241	7243	7245	7246	7275	7276	7277	
		Black	Arctic White Gloss	Milk	Nickel Metallic	Mineral Metallic	Pearl Metallic	Champagne Metallic	Steel Metallic	Gold Dust Metallic	Sterling Metallic	Platinum Metallic	Near Black Metallic	Black	Sand	Fog	Slate	Fieldstone	Midnight	Arctic White	Seagull	Carbon Metallic	Midnight Metallic	Seagull	Arctic White	Sand	
Regard	Frames	■	■	■	■	■	■	■	■	■	■	■	■	■	■	■	■	■	■	■	■	■	■	■	■	■	■
	Arm Caps	•	•	•	•	•	•	•	•	•	•	•	•	•	•	•	•	•	•	•	•	•	•	•	•	•	•
	Tables and Desk Worksurfaces*	■	■	■	■	■	■	■	■	■	■	■	■	■	■	■	■	■	■	■	■	■	■	■	■	■	■
	Media and Desk Cabinets	•	•	•	•	•	•	•	•	•	•	•	•	•	•	•	•	•	•	•	•	•	•	•	■	■	■
	Screen Bracket	•	•	•	•	•	•	•	•	•	•	■	•	•	■	■	•	•	•	•	■	•	•	•	•	•	•
	Vertical Cable Riser	•	•	•	•	•	•	•	■	•	•	■	•	•	•	•	•	■	•	•	•	•	•	•	•	•	•
	Power Strips	•	•	•	•	•	•	•	■	•	•	■	•	•	•	•	•	■	•	•	•	•	•	•	•	•	•
Sequoia	Seating Frame	•	•	•	•	•	•	•	•	•	•	•	•	•	•	•	•	•	•	•	•	•	•	•	•	•	•
	Arm Caps	•	•	•	•	•	•	•	•	•	•	•	•	•	•	•	•	•	•	•	•	•	•	•	•	•	•
Sieste	Arm Caps	•	•	•	•	•	•	•	•	•	•	•	•	•	•	•	•	•	•	•	•	•	•	•	•	•	•
	Legs	•	•	•	•	•	•	•	•	•	•	•	•	•	•	•	•	•	•	•	•	•	•	•	•	•	•
	Table Top*	•	•	•	•	•	•	•	•	•	•	•	•	•	•	•	•	•	•	•	•	•	•	•	•	•	•
Sieste Sleeper		•	•	•	•	•	•	•	•	•	•	•	•	•	•	•	•	•	•	•	•	•	•	•	•	•	
Sorrel	Seating Frame and Arm Caps	•	•	•	•	•	•	•	•	•	•	■	•	■	•	•	•	•	•	•	•	•	•	•	•	•	•
	Seating Backs	•	•	•	•	•	•	•	•	•	•	•	•	•	•	•	•	•	•	•	•	•	•	•	•	•	•
	Table Legs	•	•	•	•	•	•	•	•	•	•	■	•	■	•	•	•	•	•	•	•	•	•	•	•	•	•
	Table Tops—Laminate	•	•	•	•	•	•	•	•	•	•	•	•	•	•	•	•	•	•	•	•	•	•	•	•	•	•
Surround	Frames	■	■	■	■	■	■	■	■	■	■	■	■	■	■	■	■	■	■	■	■	■	■	■	■	■	■
	Mobile Tablet Arm	•	•	•	•	•	•	•	•	•	•	•	•	•	■	•	•	•	•	■	■	■	•	•	•	•	•
	Tablet Surface	•	•	•	•	•	•	•	•	•	•	•	•	•	•	•	•	•	•	•	•	•	•	•	•	•	•
	Storage Tablet	•	•	•	•	•	•	•	•	•	•	•	•	•	■	•	•	•	•	■	■	■	•	•	•	•	•
	Surface Tray with Picture Rail	•	•	•	•	•	•	•	•	•	•	•	•	•	•	•	•	•	•	•	•	•	•	•	•	•	•
	Coat Hanger	•	•	•	•	•	•	•	•	•	•	•	•	•	■	•	•	•	•	■	■	■	•	•	•	•	•
	Power	•	•	•	•	•	•	•	•	•	•	•	•	•	•	•	•	•	•	•	•	•	•	•	•	•	•
Tava	Arm and Legs	•	•	•	•	•	•	•	•	•	•	•	•	•	•	•	•	•	•	•	•	•	•	•	•	•	•
	Bench Body and Table Tops	•	•	•	•	•	•	•	•	•	•	•	•	■	■	•	■	■	■	■	■	■	•	•	•	•	•
X-tenz Sleeper	Arm Caps	•	•	•	•	•	•	•	•	•	•	•	•	•	•	•	•	•	•	•	•	•	•	•	•	•	•
	Front/Back Panels	•	•	•	•	•	•	•	•	•	•	•	•	•	•	•	•	•	•	•	•	•	•	•	•	•	•
Verge		■	■	■	■	■	■	■	■	■	■	■	■	■	■	■	■	■	■	■	■	■	■	■	■	■	■
	Outlook Tables																										
	Table Top	•	•	•	•	•	•	•	•	•	•	•	•	•	•	•	•	•	•	•	•	•	•	•	•	•	•
	Metal Legs	•	•	•	•	•	•	•	■	•	•	■	•	■	•	•	•	•	•	•	•	•	•	•	•	•	•
	Wood Legs	•	•	•	•	•	•	•	•	•	•	•	•	•	•	•	•	•	•	•	•	•	•	•	•	•	•

* Also available in Steelcase laminates.

Wood Veneer Matrix for Steelcase Health Seating and Tables

Legend

- = Not available
- = Available
- = Available with exceptions
- ▶ See specification pages for details.

		Veneer	3062 Graphite Walnut	3402 Clear Cherry	3412 Natural Cherry	3422 Medium Cherry	3522 Clear Maple	3576 Almond Cherry	3579 Dark Rum Cherry	3580 Shiraz Cherry	3592 Blonde on Maple	3702 Clear Walnut	3712 Natural Cherry
Aspekt	Seating Frame		•	•	•	•	•	•	•	•	•	•	•
	Arm Caps		■	■	•	■	■	■	■	■	■	■	■
	Table Legs		•	•	•	•	•	•	•	•	•	•	•
	Table Top		•	•	•	•	•	•	•	•	•	•	•
Cura	Arm Caps		■	■	•	■	■	■	■	■	■	■	■
	Frame		•	•	•	•	•	•	•	•	•	•	•
	Table Top		•	•	•	•	•	•	•	•	•	•	•
Empath	Upper Arms		•	•	•	•	•	•	•	•	•	•	•
	Tablet Surface		•	•	•	•	•	•	•	•	•	•	•
Jarrah	Side Trim Panel		■	■	•	■	■	■	■	■	■	■	■
	Seating Legs		•	•	•	•	•	•	•	•	•	•	•
	Arm Caps		■	■	•	■	■	■	■	■	■	■	■
Leela	Arm Caps		■	■	•	■	■	■	■	■	■	■	■
	Legs		•	•	•	•	•	•	•	•	•	•	•
	Table Top		•	•	•	•	•	•	•	•	•	•	•
Mineral	Arm Caps		■	■	•	■	■	■	■	■	■	■	■
	Tablet Surface		•	•	•	•	•	•	•	•	•	•	•
Mitra	Seating Frame		■	■	•	■	■	■	■	■	■	■	■
	Arm Caps		■	■	•	■	■	■	■	■	■	■	■
	Table Legs and Bases		■	■	•	■	■	■	■	■	■	■	■
	Table Top		•	•	•	•	•	•	•	•	•	•	•
	Tablet Surface		•	•	•	•	•	•	•	•	•	•	•
Neighbor	Frames		•	•	•	•	•	•	•	•	•	•	

		Veneer																			
		3062	3402	3422	3456	3457	3460	3461	3463	3464	3467	3468	3469	3470	3522	3576	3579	3580	3592	3702	3712
		Graphite Walnut	Clear Cherry	Medium Cherry	Clear on Ash	Almond on Ash	Dark Rum on Ash	Shiraz on Ash	Blonde on Ash	Clear Cherry on Ash	Medium Cherry on Ash	Graphite on Ash	Clear Walnut on Ash	Natural Walnut on Ash	Clear Maple	Almond Cherry	Dark Rum Cherry	Shiraz Cherry	Blonde on Maple	Clear Walnut	Natural Walnut
Sequoia	Seating Frame	■	■	■	•	•	•	•	•	•	•	•	•	•	■	■	■	■	■	■	■
	Arm Caps	■	■	■	•	•	•	•	•	•	•	•	•	•	■	■	■	■	■	■	■
	Table Tops	•	•	•	•	•	•	•	•	•	•	•	•	•	•	•	•	•	•	•	•
Sieste	Arm Caps	■	■	■	•	•	•	•	•	•	•	•	•	•	■	■	■	■	■	■	■
	Legs	■	■	■	•	•	•	•	•	•	•	•	•	•	■	■	■	■	■	■	■
	Table Top	■	■	■	•	•	•	•	•	•	•	•	•	•	■	■	■	■	■	■	■
Sieste Sleeper	■	■	■	•	•	•	•	•	•	•	•	•	•	■	■	■	■	■	■	■	
Sorrel	Seating Frame and Arm Caps	•	•	•	•	•	•	•	•	•	•	•	•	•	•	•	•	•	•	•	•
	Seating Backs	■	■	■	•	•	•	•	•	•	•	•	•	•	■	■	■	■	■	■	■
Tava	Arm and Legs	•	•	•	■	■	■	■	■	■	■	■	■	■	•	•	•	•	•	•	•
	Bench Body and Table Tops	•	•	•	•	•	•	•	•	•	•	•	•	•	•	•	•	•	•	•	•
X-tenz Sleeper	Arm Caps	■	■	■	•	•	•	•	•	•	•	•	•	•	■	■	■	■	■	■	■
	Frame	•	•	•	•	•	•	•	•	•	•	•	•	•	•	•	•	•	•	•	•
Verge		•	•	•	•	•	•	•	•	•	•	•	•	•	•	•	•	•	•	•	•
Outlook Tables	Table Top	•	•	•	•	•	•	•	•	•	•	•	•	•	•	•	•	•	•	•	•
	Metal Legs	•	•	•	•	•	•	•	•	•	•	•	•	•	•	•	•	•	•	•	•
	Wood Legs	■	■	■	•	•	•	•	•	•	•	•	•	•	■	■	■	■	■	■	■

Recommended Worksurface Edge Finishes

Recommended Edge Colors

Edges

The recommended edge color will complement the laminate color you specify. Edge color is specified separately.

Steelcase Laminate Color	Recommended 3 mm Edge Color
Fiber	
2571 Almond Cherry	6014 Almond Cherry
2574 Dark Rum Cherry	6023 Dark Rum Cherry
2575 Shiraz Cherry	6024 Shiraz Cherry
2850 Vanadium Fiber	6654 Sand
2851 Rhyme Fiber	6631 Cream
2852 Tungsten Fiber	6636 Mist
2854 Vellum Fiber	6655 Warm White
2859 Novell Fiber	6001 Coffee
2860 Granite Fiber	6000 Black
2861 Coconut Fiber	6654 Sand
2862 Stucco Fiber	6053 Seagull
Micro	
2920 Marl Micro	6053 Seagull
2921 Gypsum Micro	6654 Sand
2922 Clay Micro	6654 Sand
2923 Shadow Micro	6249 Platinum Solid
Patina	
2870 Blonde Bronze Patina	6654 Sand
2871 Blackened Bronze Patina	6615 Grey V5
2873 Instant Iron Patina	6615 Grey V5
Solid	
2722 Cream	6631 Cream
2730 Arctic White	6697 Fog
2746 Black	6000 Black
2759 Warm White	6655 Warm White
2811 Mist	6636 Mist
2883 Seagull	6053 Seagull
2884 Milk	6052 Milk
2885 Dune	6654 Sand
2HMG Merle	6527 Merle
Speckle	
2820 Coffee Speckle	6631 Cream
2822 Woodrose Speckle	6635 Dawn
2823 Driftwood Speckle	6631 Cream
2824 Smoke Speckle	6636 Mist
2825 Vanadium Speckle	6619 Ice

Steelcase Health Laminate Color	Recommended 3 mm Edge Color
Textured Woodgrain—Select Surfaces	
2TH2 Fawn Cypress	6T02 Fawn Cypress
2TH3 Weathered Char	6T03 Weathered Char
2TH4 Saddle Oak	6T04 Saddle Oak
2TH5 Veranda Teak	6T05 Veranda Teak
2TH6 Persian Cherry	6T06 Persian Cherry
2TH7 Walnut Heights	6T07 Walnut Heights
Textured Industrial—Select Surfaces	
2UH1 Reclaimed Aggregate	6T08 Aggregate
2UH2 Reclaimed Gravel	6T09 Gravel
2UH4 Cement	6T10 Cement
2UH6 Sheetrock	6T12 Sheetrock
Woodgrain	
2409 Clear Maple	6237 Clear Maple
2410 Graphite Walnut	6231 Graphite Walnut
2412 Natural Cherry	6034 Natural Cherry
2422 Medium Cherry	6036 Medium Cherry
2511 Winter on Maple	6037 Winter on Maple
2538 Clear Walnut	6245 Clear Walnut
2539 Warm Oak	6246 Warm Oak
2592 Blonde on Maple	6038 Blonde on Maple
2714 Natural Walnut	6041 Natural Walnut
2772 Medium Mahogany on Walnut	6045 Medium Mahogany on Walnut
2HAK Clear Oak	6219 Clear Oak
2HAN Ash Noce	6707 Ash Noce
2HAT Acacia	6213 Acacia
2HAW Ash Wenge	6703 Ash Wenge
2HBN Bisque Noce	6708 Bisque Noce
2HBW Bisque Wenge	6705 Bisque Wenge
2HCN Clay Noce	6709 Clay Noce
2HCW Clay Wenge	6706 Clay Wenge
2HSN Storm Noce	6710 Storm Noce
2HSW Storm Wenge	6704 Storm Wenge

Modular Casegoods Directional Laminate

Modular Casegoods
Directional Laminate

The appearance of laminate may change slightly depending on the angle from which it is viewed. This natural phenomenon is called polarization, and it can be seen on natural veneer, and to a lesser extent on composite veneer. Polarization is often noticed on worksurfaces installed at a 90° angle with each other. Please refer to the following illustrations for an understanding of grain direction on your installation.

Sync

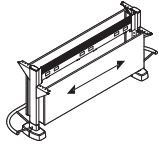

Double-Sided Bases

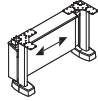

Single-Sided Bases



Single Leg Bases



Upper Transaction, Upper Interaction, Upper Process, Lower Interaction, and Lower Process Worksurfaces for Use with Double-Sided Bases



Interaction and Process Worksurfaces for Use with Single-Sided Bases



90° Full Arc Worksurfaces



135° Full Arc Worksurfaces



135° Scoop Worksurfaces

Surface Materials

Opus

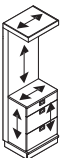

Cabinets with 36" H Storage Units

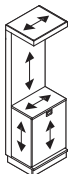

Cabinets with 36" H Hinged-Door Storage for use with Sink

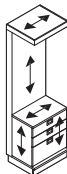

Cabinets with 30" H, 24" H, 18 1/2" H Storage Units

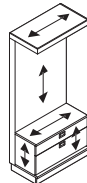

Desk Cabinets

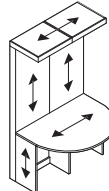

Conference Table Cabinets

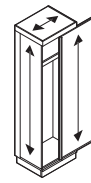

Wardrobe Cabinet with Sliding Door



Bedside Tables



Overhead Shelves



Overhead Shelves with Box Unit



Overhead Storage Cabinets with Doors



Common Tops



End Filler Panel



Inside Corner Filler



End Panel



Mounting Boards

Sonata



Nurse Servers

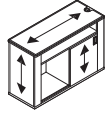

Islands



Benches



Media Units



Wardrobes

Folio



28"H, 33"H ADA, and 36"H Base Cabinets



Sink Cabinets



Storage Cabinets



Wardrobe Cabinets



Bookcases



Upper Storage Cabinets



Shelves

Regard

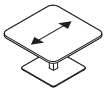

Square Tables

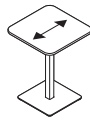

Personal Tables

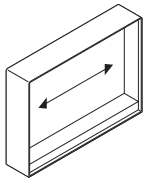

Media Cabinet

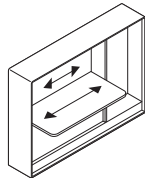

Open Desk Cabinet

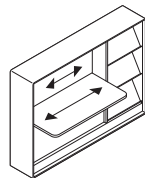

Desk Cabinet with Display Shelves

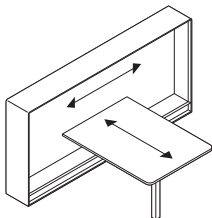

Booth with Table

Freestanding Casegoods Directional Laminate

Freestanding Casegoods
Directional Laminate

The appearance of laminate may change slightly depending on the angle from which it is viewed. This natural phenomenon is called polarization, and it can be seen on natural veneer, and to a lesser extent on composite veneer. Polarization is often noticed on worksurfaces installed at a 90° angle with each other. Please refer to the following illustrations for an understanding of grain direction on your installation.

Ainsley



Dressers



Bedside Tables

Davenport

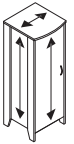

Wardrobe Cabinets



Dressers

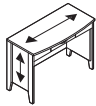

Writing Desks



Bedside Tables

Park



Wardrobe Cabinets



Mobile Cabinets



Bedside Tables

Senza

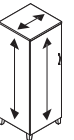

Wardrobe Cabinets



Dressers



Bedside Tables

Waldorf

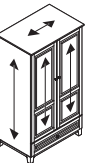

Wardrobe Cabinets



Dressers



Bedside Tables

Upholstery and Color Numbers

Upholstery

Not all fabrics are available on all products. See the COM database for specific product and fabric availability.

Price Group 1

Buzz2

5F03 Tomato
5F04 Red
5F05 Burgundy
5F06 Sky
5F07 Blue
5F08 Navy
5F10 Grape
5F11 Eggplant
5F15 Stone
5F16 Grey
5F17 Black
5G50 Dunegrass
5G51 Sable
5G52 Barley
5G53 Sunrise
5G54 Carrot
5G55 Pumpkin
5G56 Timber
5G57 Rouge
5G58 Chocolate
5G59 Meadow
5G60 Ivy
5G61 Cyan
5G62 Atlantic
5G63 Crocus
5G64 Alpine
5G65 Tornado

Era

5ER0 Cobalt
5ER1 Harbor
5ER2 Blue Nickel
5ER3 Pistachio
5ER4 Canary
5ER5 Comet
5ER6 Truffle
5ER7 Saffron
5ER8 Pink Lemonade
5ER9 Onyx
5ES0 Scarlet
5ES1 Lentil
5ES2 Oatmeal
5ES3 Persimmon
5ES4 Sprout
5ES5 Blue Mint
5ES6 Royal Blue
5ES7 Night Owl

Jacks

5B61 Taupe
5B63 Camel
5B64 Pewter
5B70 Midnight

Link

5A20 Burgundy
5A23 Green
5A24 Blue
5A25 Navy
5A26 Purple
5A27 Black
5A28 Ocean
5A30 Chamois

New Black

5J10 New Black: Bruce
5J11 New Black: Henry
Tip: New Black upholstery has color numbers in both price group 1 and price group 2.

Playground

5F28 Claret
5F31 Nut
5F33 Stone
5F34 Sky
5F35 Navy
5F36 Huckleberry
5F37 Charcoal

Price Group 2

Chainmail

5550 Cotton
5551 Space
5552 Silver Dollar
5553 Volcano
5554 Orange Crush
5555 Tricycle
5556 Geranium
5557 Banana
5558 Margarita
5559 Lagoon

Cogent: Connect

5S15 Coconut
5S16 Turmeric/Honey
5S17 Tangerine
5S18 Scarlet
5S19 Concord
5S20 Maya Blue
5S21 Blue Jay
5S23 Wasabi
5S24 Nickel
5S25 Graphite
5S26 Licorice
5S27 Malt
5S28 Root Beer
5S93 Blueprint
5S94 Lizard/Jungle
5S95 Sailor
5S96 Quicksilver
5S98 Canary
5S99 Lipstick/Merlot
5SD0 Royal Blue
5SD1 Aubergine
5SD2 Peacock
5SD3 Lagoon
5SD4 Saffron

Cogent: Trails

5S29 Bronzite
5S85 Agate
5S86 Lapis
5S87 Malachite
5S88 Quartz
5S90 Tiger Eye
5S91 Travertine
5S92 Topaz

New Black

5J08 New Black: Jack
5J09 New Black: James
5J12 New Black: Harley
Tip: New Black upholstery has color numbers in both price group 1 and price group 2.

Nitelights

5F58 Hazelnut
5F61 Earth
5F62 Shore
5F63 Moss
5F65 Regal Blue
5F66 Stone
5F67 Moon

Seating Vinyl

5801 Topaz
5805 Foggy Night
5809 Black
5810 Forest
5812 Navy
5813 Currant
5814 Leaf
5815 Seaside
5817 Pebble
5818 Spice
5819 Thistle
5820 Coffee
5822 Iris

Spyder

5B01 Foggy Night
5B04 Peri

Stand In

5621 Sleet
5622 Lunar
5623 Cyclone
5624 Eclipse
5625 Powder
5626 Chardonnay
5627 Graham
5628 Sediment
5629 Allspice
5630 Apple
5631 Lava
5632 Cayenne
5633 Plantain
5634 Parsley
5635 Scallion
5636 Atlantis
5691 Orca
5740 Burlap
5741 Porter
5742 Tusk
5743 Putty
5744 Blueberry
5745 Chartreuse
5746 Mango
5747 Sedona
5748 Juniper
5749 Peanut

Price Group 3

Billiard Multi-Use by Designtex

5H10 Bone
5H11 Poppy
5H12 Tangelo
5H13 Citron
5H14 Avocado
5H15 Hunter
5H16 Indigo
5H17 Mallard
5H18 Teak
5H19 Cumulus
5H20 Pewter
5H21 Gunmetal
5H22 Ink

Gaja – Cradle to Cradle Certified™ Silver

5W40 Black
5W41 Pepper
5W42 Pearl Grey
5W43 Crimson
5W44 Ink
5W45 Night Blue
5W46 Petrol
5W48 Sepia
5W49 Umber
5W51 Camellia Red
5W52 Emerald
5W53 Snow Pea
5W54 Olive
5W56 Maroon
5W57 Black Raspberry
5W58 Spruce
5W59 Apple Green
5W60 Deep Blue
5W61 Chili Pepper

Imperma

TM01 Toffee
TM02 Pigeon
TM03 Fossil
TM04 Poppyseed
TM05 Auburn
TM06 Cumin
TM07 Marble
TM08 Cliff
TM09 Tarragon
TM10 Pesto
TM11 Wave
TM12 Niagara
TM13 Tuscan
TM14 Peppercorn

Redeem

TM50 Brick
TM51 Yolk
TM52 Cinnamon
TM53 Daisy
TM54 Pine
TM55 Water
TM56 Dill
TM57 Lavender
TM58 Mallard
TM59 Caramel
TM60 Greyhound
TM61 Mocha
TM62 Iceberg
TM63 Chestnut
TM64 Granite
TM65 Cashmere
TM66 Barnwood

Retrieve

TM30 Kelly
TM31 Lake
TM32 Gala
TM33 Papaya
TM34 Dandelion
TM35 Curry
TM36 Lilac
TM37 Submarine
TM38 Driftwood
TM40 Quarry
TM42 Shadow
TM43 Seal
TM44 Chalk

Texel

TM20 Angora
TM21 Grist
TM22 Galaxy
TM23 Terracotta
TM24 Nude
TM25 Field
TM26 Haze

Price Group 5

Bo Peep

- 5G66 Pita
- 5G67 Bone
- 5G68 Safari
- 5G69 Brown Sugar
- 5G70 Chocolate Chip
- 5G71 Candlelight
- 5G72 Honey Mustard
- 5G73 Marmalade
- 5G74 Picnic
- 5G75 Pinot
- 5G76 Bloom
- 5G77 Grapevine
- 5G78 Firefly
- 5G79 Artichoke
- 5G80 Serpent
- 5G81 Carolina
- 5G82 Blue Bonnet
- 5G83 Nautical
- 5G84 Gravel
- 5G85 Sharkskin
- 5G86 Kohl

Remix

- RE01 Rust
- RE02 Pumpkin
- RE03 Pebble
- RE04 Dark Chocolate
- RE05 Beige
- RE06 Linen Beige
- RE07 Hazelnut
- RE08 Concrete Grey
- RE09 Sky Blue
- RE10 Blue Jean
- RE11 Ivy Green
- RE12 Primavera Yellow
- RE13 Night Blue

Silk

- 5L30 Butterscotch
- 5L31 Dijon
- 5L32 Seaweed
- 5L33 Boysenberry
- 5L34 Vermillion
- 5L35 Marina
- 5L36 Heather Blue
- 5L37 Blue Raspberry
- 5L38 Cauldron
- 5L39 Flaxen

Price Group 6

Brisa

- BR01 Black Onyx
- BR04 Truffle
- BR06 Ash
- BR07 Sage
- BR08 Celery
- BR09 Sterling Blue
- BR10 Night Navy
- BR11 Cambridge Blue
- BR12 Abyss
- BR13 Canyon
- BR14 Pompeian Red
- BR15 Salsa
- BR16 Cinnabar
- BR17 Aztec
- BR18 New Sand
- BR19 Cream
- BR20 White
- BR21 Moccasin
- BR22 Buckskin
- BR23 Prairie
- BR24 Mineral
- BR25 Skyway
- BR26 Iron
- BR27 Stormy
- BR28 Esmeralda
- BR29 Seaweed
- BR30 Bone
- BR31 Caramel
- BR32 Bridle
- BR33 Moon

Price Group 7

Steelcut Trio

- TR01 Mist Grey
- TR02 Stone Grey
- TR03 Cassonade Beige
- TR04 Nutmeg Beige
- TR06 Licorice Black
- TR07 Mustard Yellow
- TR08 Red Currant
- TR11 Ice Blue
- TR14 Blue Jay Mix
- TR15 Brown Frost

Leather Price Group

- L107 Black
- L207 Mahogany
- L220 Soapstone
- L221 Rocky
- L500 Camel
- L503 Navy

Select Surfaces

For information on products within Select Surfaces, including accent paints and fabrics from Designtex, Gabriel, Kvadrat, and Pollack, please refer to the *Surface Materials Reference Manual* or visit www.steelcase.com/surface-materials under the Select Surfaces section.

Custom Surfaces

Price Group COM (Customer's Own Material)

Fabric Approval and Yardage

To confirm whether a particular COM material has already been tested for use on a specific Steelcase or Steelcase Health product or to determine actual yardage requirements:

- Visit www.steelcase.com

For additional information regarding Customer's Own Material, call

1.888.STEELCASE (1.888.783.3522) or send an e-mail to lineone@steelcase.com.

For Steelcase Health products, call 1.800.342.8562.

Steelcase Health Graded-In Programs

Steelcase Health Graded-In Program: Acrylic Panel

A collection of acrylic panels are available as part of a Graded-In Program. The collection is from the Designtex Fusion offering.

These acrylic panels are Graded-In for the Sonata product only. The collection on these pages is not Graded-In for other Steelcase brands or product lines.

To order these acrylic panels, enter the finish code which corresponds with the acrylic panel price group.

Price Group	Finish Code
1	65DA
2	65DB
3	65DC
4	65DD

Then enter the acrylic panel information in the Special Acrylic Panel Information pop up window. If prompted, enter the finish code DSGNTX0002 based on the acrylic panel supplier.

Designtex

Fusion Offering

Price Group 1

Blueberry
Bluestone
Bubblegum
Canary
Candy Apple
Etch
Grape
Key Lime
Lemon
Periwinkle
Plum
Red
Sea
Searchlight
Slate
Tangerine
White
White Dot
White Rain
White Ribbon

Price Group 2

Berry Grid
Bone Linen
Cloud Grid
Espresso Sketch
Flame Sketch
Flannel Linen
Granny Smith Grid
Grapefruit Grid
Halo
Honey Sketch
Ice Sketch
Noir Linen
Orange Grid
Pistachio Sketch
Reef Linen
Scarlet Sketch
Sky Grid
Tiki Stalk
Windowbox

Price Group 3

Kenya Rush
Ogee
Prairie Stalk
Savannah Rush
Straws

Price Group 4

Coil
Convection
Desert Stalk 50% More
Drink Tray
Fingerprints
Grassland
Green Sheer Leaf
Illumination
Large Sheer Leaf
Maroon Sheer Leaf
Plain
Rock Candy
Sapphire Rock Candy
Small Sheer Leaf
Toffee Sheer Leaf
Underwood

Steelcase Health Graded-In Program: Solid Surface

A collection of solid surfaces are available as part of a Graded-In Program. The collection is from the Corian solid surface offering. Samples can be ordered through www.corian.com

These solid surfaces are Graded-In for the Folio, Regard, Sonata, Sync, Senza, Tava, and Leela products only. The collection on these pages is not Graded-In for other Steelcase brands or product lines.

Aspekt straight arm and Mitra guest seating arm caps are available in all standard Steelcase Health Corian finishes and Graded-In for the Corian colors indicated with an asterisk.

To order these solid surfaces, enter the finish code which corresponds with the solid surface price group.

Price Group	Finish Code
A	29DA
B	29DB
C	29DC
D	29DD

Then enter the solid surface information in the Special Solid Surface Information pop up window. If prompted, enter the finish code CORIAN0001 based on the solid surface supplier.

Corian

Solid Surface Offering

Price Group A

Cameo White*
Vanilla*

Price Group B

Abalone
Aurora
Canyon
Maui
Modern White
Platinum
Sahara*
Sandstone
Savannah*
Silt*

Price Group C

Arctic Ice
Blue Pebble
Cocoa Brown
Concrete*
Cottage Lane
Deep Night Sky*
Deep Nocturne*
Designer White
Doeskin
Dove
Fossil
Glacier Ice
Granola
Matterhorn
Pine
Raffia*
Rice Paper*
Seafoam
Serene Sage
Silver Birch
Silverite
Suede
Venaro White
Whisper
White Jasmine
Willow
*Available on Aspekt straight arm and Mitra guest seating arm caps.

Price Group D

Arrowroot
Burl'd Beach
Clam Shell
Earth
Ecrú
Elderberry
Graylite
Juniper
Lava Rock
Milky Way
Natural Gray
Rain Cloud
Rosemary
Sagebrush
Sand Storm
Sandalwood
Sonora
Sorrel
Thyme
Tumbleweed
Witch Hazel
*Available on Aspekt straight arm and Mitra guest seating arm caps.

Standard Steelcase Health Corian finishes:

Price Group A

2801 Glacier White
2975 Bisque

Price Group B

2973 Linen

Price Group C

2972 Antarctica
2974 Canvas

▶ See page 406

**Steelcase Health
Graded-In Program:
Upholstery**

**Steelcase Health
Graded-In Program**

Partners:

- Architex
- Arc-Com
- CF Stinson
- DesignTex
- Mayer
- Momentum
- Ultrafabrics

A collection of textiles

are available as part of a Graded-In Program. The collection from the leading suppliers in the market consists of high-performance textiles that meet the demands of healthcare environments. Note that not all fabrics can be applied to all seating products. Refer to the Steelcase COM database for the most current application information.

To order these fabrics, enter the finish code which corresponds with the fabric price group.

Price Group	Finish Code
2	59DB
3	59DC
4	59DD
5	59DE
6	59DF
7	59DG
8	59DH
9	59DJ
10	59DK

Then enter the fabric information in the Special Fabric Information pop up window. Enter the appropriate deal code from the list below, based on the fabric supplier.

Supplier Deal Code

Architex	ARCHTX0001
ArcCom	ARCCOM0001
CF Stinson	CFSTIN0001
DesignTex	DSGNTX0001
Momentum	MOMENT0001
Ultrafabrics	ULTRAF0001

Fabric application direction must be specified.

▶ See page 422 for *Fabric Application Direction Guidelines* to ensure fabric is specified in the correct direction.

For a comprehensive list of patterns and price grades in Steelcase Health offering, visit www.steelcase.com/surface-materials under the Healthcare Surfaces section.

Fabric Application Direction Guidelines

What is the issue?

Some textiles are simple and look the same regardless of how you apply them to a product. Other fabrics are patterned, textured, or have luster that will have a distinctly different appearance applied in a different direction on a chair. Because of these differences, and the fact that there are limits to how some fabrics can be applied to Steelcase Health products, it is important to understand fabric application direction when ordering a product to avoid being disappointed.

Talking about direction

Fabrics come on rolls. The long yarns that run down the length of the roll are called the "warp" yarns. These yarns are used to define the direction you are viewing the fabric as it is applied to a chair. Fabric directionality is determined by how the fabric comes off the roll.



It is NOT determined by the way the pattern looks on the product. For example, the image below shows the fabric applied warped horizontal although the stripes appear vertical.

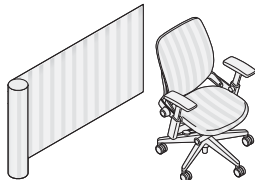

Terminology

Steelcase uses the terms warped horizontal and warped vertical. There are other terms within the industry that are used that have the same meaning:

- Warped horizontal is also referred to as: railroaded or across roll
- Warped vertical is also referred to as: woven way, down roll, or top out

Why is it important?

Dealers must specify fabric application direction when ordering COMs and Steelcase Health Graded-In fabrics. We require the dealer to specify the direction because we do not know which way customers want to see a pattern on the furniture. Therefore, it is critical to know how the pattern is run on the roll to ensure that Steelcase Health builds and ships each order to the customer's expectation each and every time.



Incorrect?



Correct?



Incorrect?



Correct?



Incorrect?



Correct?



Incorrect?



Correct?

How do I know which way the fabric comes off the roll?

Most textile companies will swatch their fabrics in a warp vertical (woven way, down roll) direction. Some exceptions might be made to address patterns especially with stripes. Typically, when a fabric is swatched in a warp horizontal (railroad or across roll) direction, the direction is noted on the swatch card or fabric sample. If in doubt of a fabric direction, we encourage you to contact the textile vendor for clarification.

Vinyl

Vinyl generally only passes on Steelcase Health product in a horizontal or across roll direction. This is due to physical properties of the material. If a vinyl is applied in the opposite direction, too much stretch in the material can compromise the overall aesthetics of the final upholstery. If a patterned vinyl is being specified and the vinyl must be run in a vertical direction, pre-approval must be arranged through Steelcase Health. Steelcase Health will consider the request and a decision will be made based on the specific vinyl and product combination. Contact Steelcase Health's Customer Care line.

Required Action Steps before Specifying

1. Verify by using Steelcase's COM website that the fabric is approved on the product.
2. Verify the direction that the fabric can be applied. Occasionally a fabric is only approved in one direction.
3. Confirm with the customer how they want the fabric to look on the furniture.
4. Confirm using the swatch card or vendor's website the direction the sample is shown.
5. Now you're ready to place the order.

Approved Fabrics that Meet DFAR 252.225-7012 Preference for Certain Domestic Commodities Used for Navy BPA

Approved Fabrics that Meet DFAR 252.225-7012 Preference for Certain Domestic Commodities Used for Navy BPA

Legend

- = Not available
- = Available
- ▶ See specification pages for details.

Price Group		Steelcase Seating																											
		Amia 482 Series Standard Upholstered Seat and Back	Amia 482 Series - Sewn	Brody 488	Cachet 487 Series - Standard	cobi 434 Series - Connect 3D - Standard	cobi 434 Series - Connect 3D - Sewn	Criterion 453 Series - Standard, Molded	Criterion 453 Series - Standard, Plus	Criterion 453 Series - Sewn	Criterion 453 Series - Sewn Back, Sewn Seat	c:scape Cushion Tops	Gesture 442 Series - Non Sewn	i2i 416 Series - 3D Knit - Sewn	Jersey Series - Jersey Mesh - Standard	Jersey Series - Sewn	Kart	Leap 462 Series - 3D Knit Standard	Leap 462 Series Standard	Leap Plus 462 Series - 3D Knit Standard	Leap Plus 462 Series - Standard	Leap 462 Series - 3D Knit - Sewn	Leap 462 Series - Sewn	Leap Plus 462 Series - 3D Knit - Sewn	Leap Plus 462 Series - Sewn	mediascape Lounge	Move 490 Series - Standard		
Steelcase Standard Fabrics																													
Brisa	6	•	■	■	•	•	•	•	■	•	■	■	■	•	■	■	■	■	■	■	•	■	■	■	■	■	■	■	■
Buzz2	1	■	■	■	■	•	■	■	■	•	•	•	•	■	■	•	•	■	■	■	■	■	•	•	•	•	■	■	
Cogent: Connect	2	■	•	■	■	■	•	■	■	•	•	•	■	■	■	•	•	■	■	■	■	■	•	•	•	•	■	■	
Cogent: Trails	2	■	•	■	■	•	■	■	■	•	•	•	•	■	■	•	•	■	■	■	■	■	•	•	•	•	■	■	
Imperma	3	■	•	■	•	•	■	■	■	•	•	•	•	■	■	•	•	■	■	■	■	■	•	•	•	•	■	■	
Jacks	1	■	■	■	■	•	■	■	■	•	•	•	•	■	■	•	•	■	■	■	■	■	•	•	•	•	■	■	
Jersey Mesh	Specific to Jersey	•	•	•	•	•	•	■	•	•	•	•	•	•	•	■	•	•	•	•	•	•	•	•	•	•	•	•	
Steelcase Leather	Leather Price Group	•	■	■	■	•	■	•	■	■	■	•	•	■	•	■	•	•	•	•	•	•	■	■	■	■	■	■	
Link	1	■	■	■	■	•	■	■	■	■	•	•	•	■	■	•	•	■	■	■	■	■	•	•	•	•	■	■	
Nitelights	2	■	•	■	■	•	■	■	■	•	•	•	•	■	■	•	•	■	■	■	■	■	•	•	•	•	■	■	
Steelcase Vinyl	2	•	■	■	■	•	■	•	■	■	■	•	•	■	•	■	•	•	•	•	•	•	■	■	■	■	■	■	
Spyder	2	■	•	•	■	•	•	■	•	•	•	•	•	■	■	•	•	■	■	■	■	■	•	•	•	•	■	■	
Texel	3	■	•	■	•	•	■	■	■	•	•	•	•	■	■	•	•	■	■	■	■	■	•	•	•	•	■	■	

Surface Materials

For information regarding Designtex fabrics, please see www.steelcase.com/surface-materials under the Custom Surfaces section.

Tip: 3D knit model numbers 4821418 and 4827418 not available.

Approved Fabrics that Meet DFAR 252.225-7012 Preference for Certain Domestic Commodities
Used for Navy BPA, continued

Legend

- = Not available
- = Available
- ▶ See specification pages for details.

	Price Group	Steelcase Seating, continued										Steelcase Wood Seating			turnstone Seating				
		Player 475 Series - Standard	Protégé 433 Series - Standard	Protégé 433 Series - Sewn	Reply 466 Series - Guest Sewn	Reply 466 Series - Guest Standard	Reply 466 Series - Sewn (task)	Reply 466 Series - Standard (task)	Siento	Think 465 Series - 3D Knit Back, Sewn Seat	Think 465 Series - Upholstered Back, Sewn Seat	Collaboration	Mingle	Snodgrass	Crew Task	Crew Guest	Jack	Uno	Scoop
Steelcase Standard Fabrics																			
Brisa	6	■	•	■	■	•	■	•	•	■	■	•	•	■	•	■	■	■	■
Buzz2	1	■	■	•	•	•	•	•	■	■	■	■	■	■	■	■	■	■	•
Cogent: Connect	2	■	■	•	•	•	•	•	■	■	■	■	■	■	■	■	■	■	•
Cogent: Trails	2	■	•	•	•	•	•	•	■	■	■	■	■	■	■	■	■	■	•
Imperma	3	■	■	•	•	•	•	•	■	■	■	■	■	■	■	■	■	■	•
Jacks	1	■	■	•	•	•	•	•	■	■	■	■	■	■	■	■	■	■	•
Jersey Mesh	Specific to Jersey	•	•	•	•	•	•	•	•	•	•	•	•	•	•	•	•	•	•
Steelcase Leather	Leather Price Group	•	•	■	■	■	■	■	■	■	■	■	■	■	■	■	■	■	•
Link	1	■	■	•	•	•	•	•	■	■	■	■	■	■	■	■	■	■	•
Nitelights	2	■	■	•	•	•	•	•	■	■	■	■	■	■	■	■	■	■	•
Steelcase Vinyl	2	•	•	■	■	■	■	■	•	■	•	•	■	■	■	•	■	■	•
Spyder	2	■	■	•	•	•	•	•	■	■	■	■	■	■	■	■	■	■	•
Texel	3	■	■	•	•	•	•	•	■	■	■	■	■	■	■	■	■	■	•

*For Think 465 Series with 3D knit back, sewn seat is only available in 3D Knit Black fabric. Must be ordered as a Select Solutions chair using general quote number CH016176 for 3D knit back in Black.

For information regarding Designtex fabrics, please see www.steelcase.com/surface-materials under the Custom Surfaces section.

Legend

- = Not available
- = Available
- ▶ See specification pages for details.

	Price Group	Steelcase Health	Aspekt	Cura	Leela	Mitra	Jarrah	Regard	Sieste	Sorrel	Tava Guest	Tava Lounge	Empath Recliner	Mineral Recliner	Mitra Recliner	Sieste Sleeper	X-tenz Sleeper
			Aspekt	Cura	Leela	Mitra	Jarrah	Regard	Sieste	Sorrel	Tava Guest	Tava Lounge	Empath Recliner	Mineral Recliner	Mitra Recliner	Sieste Sleeper	X-tenz Sleeper
Steelcase Standard Fabrics																	
Brisa	6		•	•	•	•	•	■	•	•	■	■	•	•	•	•	•
Buzz2	1		■	■	■	■	■	■	■	■	■	■	■	■	■	■	■
Cogent: Connect	2		■	■	■	■	■	■	■	■	■	■	■	■	■	■	■
Cogent: Trails	2		■	■	■	■	■	■	■	■	■	■	■	■	■	■	■
Imperma	3		■	■	■	■	■	■	■	■	■	■	■	■	■	■	■
Jacks	1		■	■	■	■	■	■	■	■	■	■	■	■	■	■	■
Jersey Mesh	Specific to Jersey		•	•	•	•	•	•	•	•	•	•	•	•	•	•	•
Steelcase Leather	Leather Price Group		•	•	•	•	•	•	•	•	•	•	•	•	•	•	•
Link	1		■	■	■	■	■	■	■	■	■	■	■	■	■	■	■
Nitelights	2		■	■	■	■	■	■	■	■	■	■	■	■	■	■	■
Steelcase Vinyl	2		■	■	■	■	■	■	■	■	■	■	■	■	■	■	■
Spyder	2		■	■	■	■	■	■	■	■	■	■	■	■	■	■	■
Texel	3		■	■	■	■	■	■	■	■	■	■	■	■	■	■	■

For information regarding Designtex fabrics, please see www.steelcase.com/surface-materials under the Custom Surfaces section.

Approved Fabrics that Meet DFAR 252.225-7012 Preference for Certain Domestic Commodities
Used for Navy BPA, continued

Legend

- = Not available
- = Available
- ▶ See specification pages for details.

Steelcase Seating	Amia 482 Series Standard Upholstered Seat and Back	Amia 482 Series - Sewn	Brody 488	Cachet 487 Series - Standard	cobi 434 Series - Connect 3D - Standard	cobi 434 Series - Connect 3D - Sewn	Criterion 453 Series - Standard, Molded	Criterion 453 Series - Standard, Plus	Criterion 453 Series - Sewn	Criterion 453 Series - Sewn Back, Sewn Seat	c:scape Cushion Tops	Gesture 442 Series - Non Sewn	i2i 416 Series - 3D Knit - Sewn	Jersey Series - Jersey Mesh - Standard	Jersey Series - Sewn	Kart	Leap 462 Series - 3D Knit Standard	Leap 462 Series Standard	Leap Plus 462 Series - 3D Knit Standard	Leap Plus 462 Series - Standard	Leap 462 Series - 3D Knit - Sewn	Leap 462 Series - Sewn	Leap Plus 462 Series - 3D Knit - Sewn	Leap Plus 462 Series - Sewn	media:scape Lounge	Move 490 Series - Standard
Desintex Fabrics																										
Acacia	•	•	•	■	•	■	•	•	■	•	■	•	■	■	•	■	■	•	•	■	■	■	■	•	•	■
Aksel	■	■	•	■	•	■	•	■	•	■	■	■	■	■	•	■	■	■	■	■	■	■	■	•	■	■
Alchemy	•	■	■	■	•	■	•	■	•	■	■	■	■	•	■	■	•	•	•	•	•	■	■	■	•	■
Alistair	■	■	•	■	■	■	•	■	•	■	■	■	■	■	•	■	•	•	•	■	■	■	■	•	■	■
Alpine	■	■	■	■	•	■	■	■	■	■	■	■	■	■	•	■	■	■	■	■	■	■	■	•	■	■
Appleseed	■	■	■	■	•	■	■	■	•	■	■	■	■	■	•	■	■	■	■	■	■	■	■	•	■	■
Astrid	■	•	■	■	•	■	■	■	■	•	■	■	■	■	•	■	■	■	■	■	■	■	■	•	■	■
Banda	■	•	•	•	•	•	■	•	•	•	■	•	•	■	•	•	■	■	•	•	•	•	•	•	•	■
Birch Bark Plaid	■	■	•	•	•	■	■	■	•	■	■	■	■	■	•	■	■	■	■	■	■	■	■	•	■	■
Bunta	■	•	•	•	•	•	■	•	•	•	■	•	•	■	•	•	■	■	•	•	•	•	•	•	•	■
Cassava	•	■	•	•	•	■	•	■	•	■	■	■	■	■	•	■	•	•	■	■	■	■	■	•	■	■
Catalyst	•	■	•	•	•	■	•	■	•	■	■	■	■	■	•	■	•	•	■	■	■	■	■	•	■	■
Circa	■	■	■	■	•	■	■	■	•	■	■	■	■	■	•	■	■	■	■	■	■	■	■	•	■	■
Circumference	■	•	•	•	•	•	•	•	•	•	■	•	•	■	•	•	■	■	•	•	•	•	•	•	•	■
Coco	•	•	•	•	•	•	•	•	•	•	•	•	•	•	•	•	•	•	•	•	•	•	•	•	•	•
Coco Plaid	■	■	■	■	•	■	■	■	•	■	■	■	■	■	•	■	■	■	■	■	■	■	■	•	■	■
Coco Stripe	■	•	•	■	•	•	■	•	■	■	■	■	■	■	•	■	■	■	■	■	■	■	■	•	■	■
Concept	■	■	•	•	•	■	■	■	•	■	■	■	■	■	•	■	■	■	■	■	■	■	■	•	■	■
Course	■	■	•	■	•	■	■	■	•	■	■	■	■	■	•	■	■	■	■	■	■	■	■	•	■	■
Cross Court	■	■	•	•	•	■	■	■	•	■	■	■	■	■	•	■	■	■	■	■	■	■	■	•	■	■
Crossweave	■	■	■	■	•	■	•	■	•	■	■	■	■	■	•	■	■	■	■	■	■	■	■	•	■	■
Cut & Paste	■	■	•	•	•	■	■	■	•	■	■	■	■	■	•	■	■	■	■	■	■	■	■	•	■	■

Tip: 3D knit model numbers 4821418 and 4827418 not available.

For information regarding Desintex fabrics, please see www.steelcase.com/surface-materials under the Custom Surfaces section.

Legend

- = Not available
- = Available
- ▶ See specification pages for details.

	Steelcase Seating, continued										Steelcase Wood Seating			turnstone Seating				
	Player 475 Series - Standard	Protégé 433 Series - Standard	Protégé 433 Series - Sewn	Reply 466 Series - Guest Sewn	Reply 466 Series - Guest Standard	Reply 466 Series - Sewn (task)	Reply 466 Series - Standard (task)	Siento	Think 465 Series - 3D Knit Back, Sewn Seat	Think 465 Series - Upholstered Back, Sewn Seat	Collaboration	Mingle	Snodgrass	Crew Task	Crew Guest	Jack	Uno	Scoop
DesignTex Fabrics																		
Acacia	•	•	•	•	■	•	•	•	•	■	■	■	•	•	■	■	■	■
Aksel	■	•	•	•	■	•	■	•	•	■	■	■	■	■	■	■	■	■
Alchemy	■	■	•	•	•	■	•	•	■	■	•	•	■	•	■	•	■	■
Alistair	■	•	•	•	■	•	■	•	■	■	■	■	■	■	■	■	■	■
Alpine	■	•	•	•	■	•	■	■	■	■	■	■	■	■	■	■	■	■
Appleseed	■	■	•	■	■	•	•	■	■	■	■	■	■	■	■	■	■	■
Astrid	■	■	•	•	■	•	■	■	■	■	■	■	■	•	•	•	■	■
Banda	■	•	•	•	■	•	•	•	•	■	■	•	■	•	■	•	•	•
Birch Bark Plaid	■	•	•	•	■	•	■	•	■	■	■	■	■	■	■	■	■	■
Bunta	■	•	•	•	■	•	•	•	•	■	■	•	■	•	■	•	•	•
Cassava	■	•	•	•	■	•	■	•	■	■	■	■	■	•	■	•	■	■
Catalyst	■	•	■	■	•	■	•	•	•	■	•	•	■	•	•	■	■	■
Circa	■	•	•	•	■	•	■	■	■	■	■	■	■	■	■	■	■	■
Circumference	■	•	•	•	■	■	■	•	•	■	■	•	■	•	■	•	•	•
Coco	•	•	•	•	•	•	•	•	•	■	•	•	•	•	•	•	•	•
Coco Plaid	■	•	•	•	■	•	■	■	•	■	■	■	■	■	■	■	■	■
Coco Stripe	■	•	•	•	■	•	•	•	•	■	•	■	•	■	•	•	•	•
Concept	■	■	•	•	■	•	■	•	■	■	■	■	■	■	■	•	■	■
Course	■	•	•	•	■	•	■	•	•	■	■	■	•	■	■	■	■	■
Cross Court	■	•	•	•	■	•	■	•	■	■	■	■	■	■	■	•	■	■
Crossweave	■	•	•	•	■	•	■	■	■	■	■	■	■	■	■	■	■	■
Cut & Paste	■	•	•	•	■	•	■	•	■	■	■	■	■	■	■	•	■	■

*For Think 465 Series with 3D knit back, sewn seat is only available in 3D Knit Black fabric. Must be ordered as a Select Solutions chair using general quote number CH016176 for 3D knit back in Black.

For information regarding DesignTex fabrics, please see www.steelcase.com/surface-materials under the Custom Surfaces section.

Approved Fabrics that Meet DFAR 252.225-7012 Preference for Certain Domestic Commodities
Used for Navy BPA, continued

Legend

- = Not available
- = Available
- ▶ See specification pages for details.

	Steelcase Health														
	Aspekt	Cura	Leela	Mitra	Jarra	Regard	Sieste	Sorrel	Tava Guest	Tava Lounge	Empath Recliner	Mineral Recliner	Mitra Recliner	Sieste Sleeper	X-tenz Sleeper
Designtex Fabrics															
Acacia	■	■	■	■	■	■	■	■	■	■	■	■	■	■	■
Aksel	■	■	■	■	■	■	■	■	■	■	■	■	■	■	■
Alchemy	■	■	■	■	■	■	■	■	■	■	■	■	■	■	■
Alistair	■	■	■	■	■	■	■	■	■	■	■	■	■	■	■
Alpine	■	■	■	■	■	■	■	■	■	■	■	■	■	■	■
Appleseed	■	■	■	■	■	■	■	■	■	■	■	■	■	■	■
Astrid	■	■	■	■	■	■	■	■	■	■	■	■	■	■	■
Banda	■	•	•	•	•	•	•	■	•	•	•	•	•	•	•
Birch Bark Plaid	■	■	■	■	■	■	■	■	■	■	■	■	■	■	■
Bunta	■	•	•	•	•	•	•	■	•	•	•	•	•	•	•
Cassava	■	■	■	■	■	■	■	■	■	■	■	■	■	■	■
Catalyst	■	■	■	■	■	■	■	■	■	■	■	■	■	■	■
Circa	■	■	■	■	■	■	■	■	■	■	■	■	■	■	■
Circumference	■	•	•	•	•	•	•	■	•	•	•	•	•	•	•
Coco	•	•	•	•	•	•	•	•	•	•	•	•	•	•	•
Coco Plaid	■	■	■	■	■	■	■	■	■	■	■	■	■	■	■
Coco Stripe	■	•	•	•	•	•	•	■	•	•	•	•	•	•	•
Concept	■	■	■	■	■	■	■	■	■	■	■	■	■	■	■
Course	■	■	■	■	■	■	•	■	■	■	■	■	■	■	■
Cross Court	■	■	■	■	■	■	■	■	■	■	■	■	■	■	■
Crossweave	■	■	■	■	■	■	■	■	■	■	■	■	■	■	■
Cut & Paste	■	■	■	■	■	■	■	■	■	■	■	■	■	■	■

For information regarding Designtex fabrics, please see www.steelcase.com/surface-materials under the Custom Surfaces section.

Legend

- = Not available
- = Available
- ▶ See specification pages for details.

Steelcase Seating		Amia 482 Series Standard Upholstered Seat and Back	Amia 482 Series - Sewn	Brody 488	Cachet 487 Series - Standard	cobi 434 Series - Connect 3D - Standard	cobi 434 Series - Connect 3D - Sewn	Criterion 453 Series - Standard, Molded	Criterion 453 Series - Standard, Plus	Criterion 453 Series - Sewn	Criterion 453 Series - Sewn Back, Sewn Seat	c:scape Cushion Tops	Gesture 442 Series - Non Sewn	i2i 416 Series - 3D Knit - Sewn	Jersey Series - Jersey Mesh - Standard	Jersey Series - Sewn	Kart	Leap 462 Series - 3D Knit Standard	Leap 462 Series Standard	Leap Plus 462 Series - 3D Knit Standard	Leap Plus 462 Series - Standard	Leap 462 Series - 3D Knit - Sewn	Leap 462 Series - Sewn	Leap Plus 462 Series - 3D Knit - Sewn	Leap Plus 462 Series - Sewn	media:scape Lounge	Move 490 Series - Standard		
Designtex Fabrics																													
Dart	■	■	•	•	•	•	■	■	■	•	■	■	■	■	■	■	■	■	■	■	■	■	■	■	■	■	■	■	
Divide	■	•	•	•	•	•	■	■	■	■	■	■	■	■	■	■	■	■	■	■	■	■	■	■	■	■	■	■	
Draft	■	■	•	•	•	■	■	■	■	■	■	■	■	■	■	■	■	■	■	■	■	■	■	■	■	■	■	■	
Eon	•	■	■	•	•	■	■	■	■	■	■	■	■	■	■	■	■	■	■	■	■	■	■	■	■	■	■	■	
Flux	■	■	•	•	•	■	■	■	■	■	■	■	■	■	■	■	■	■	■	■	■	■	■	■	■	■	■	■	
Gamut	•	•	■	•	•	•	•	•	•	•	•	•	•	•	•	•	•	•	•	•	•	•	•	•	•	•	•	•	
Glaze	•	•	•	•	•	•	•	•	•	•	•	■	•	•	•	•	•	•	•	•	•	•	•	•	•	•	•	•	
Gleam	■	•	•	•	•	•	•	•	•	•	•	■	•	•	•	•	•	■	■	■	■	■	■	■	■	■	■	■	
Gradate	■	•	•	•	•	•	•	•	•	•	•	■	•	•	•	•	•	■	■	■	■	■	■	■	■	■	■	■	
Hatchmark	•	•	•	•	•	•	•	•	•	•	•	■	•	•	•	•	•	•	•	•	•	•	•	•	•	•	•	•	
Hexstripe	■	■	•	•	•	■	■	■	■	■	■	■	■	■	■	■	■	■	■	■	■	■	■	■	■	■	■	■	
Honor Plus	■	■	■	■	•	■	■	■	■	■	■	■	■	■	■	■	■	■	■	■	■	■	■	■	■	■	■	■	
Inertia	■	■	•	•	•	■	■	■	■	■	■	■	■	■	■	■	■	■	■	■	■	■	■	■	■	■	■	■	
Inertia Loomstate	•	•	•	•	•	•	•	•	•	•	•	•	•	•	•	•	•	•	•	•	•	•	•	•	•	•	•	•	
Inkling	■	■	•	•	•	■	■	■	■	■	■	■	■	■	■	■	■	■	■	■	■	■	■	■	■	■	■	■	
Jaunt	•	■	•	•	•	■	■	■	■	■	■	■	■	■	■	■	■	■	■	■	■	■	■	■	■	■	■	■	
Journey	•	•	■	■	•	■	■	■	■	■	■	■	■	■	■	■	■	■	■	■	■	■	■	■	■	■	■	■	
Klange	■	•	■	■	•	■	■	■	■	■	■	■	■	■	■	■	■	■	■	■	■	■	■	■	■	■	■	■	
Latitude	■	•	•	•	•	■	■	■	■	■	■	■	■	■	■	■	■	■	■	■	■	■	■	■	■	■	■	■	
Lattice	•	■	•	•	•	■	■	■	■	■	■	■	■	■	■	■	■	■	■	■	■	■	■	■	■	■	■	■	
Leaf Dot	■	•	•	•	•	■	■	■	■	■	■	■	■	■	■	■	■	■	■	■	■	■	■	■	■	■	■	■	
Leland	■	•	•	•	•	■	■	■	■	■	■	■	■	■	■	■	■	■	■	■	■	■	■	■	■	■	■	■	
Little Plaid	■	•	•	•	•	■	■	■	■	■	■	■	■	■	■	■	■	■	■	■	■	■	■	■	■	■	■	■	
Lofty	■	■	■	■	•	■	■	■	■	■	■	■	■	■	■	■	■	■	■	■	■	■	■	■	■	■	■	■	

Tip: 3D knit model numbers 4821418 and 4827418 not available.

For information regarding Designtex fabrics, please see www.steelcase.com/surface-materials under the Custom Surfaces section.

Approved Fabrics that Meet DFAR 252.225-7012 Preference for Certain Domestic Commodities
Used for Navy BPA, continued

Legend

- = Not available
- = Available
- ▶ See specification pages for details.

Designtex Fabrics	Steelcase Seating, continued										Steelcase Wood Seating			turnstone Seating				
	Player 475 Series - Standard	Protégé 433 Series - Standard	Protégé 433 Series - Sewn	Reply 466 Series - Guest Sewn	Reply 466 Series - Guest Standard	Reply 466 Series - Sewn (task)	Reply 466 Series - Standard (task)	Siento	Think 465 Series - 3D Knit Back, Sewn Seat	Think 465 Series - Upholstered Back, Sewn Seat	Collaboration	Mingle	Snodgrass	Crew Task	Crew Guest	Jack	Uno	Scoop
Dart	■	•	•	•	■	•	■	•	■	■	■	■	■	■	■	■	•	■
Divide	■	•	•	•	■	•	•	•	•	■	■	■	•	■	•	•	•	•
Draft	■	•	•	•	■	•	■	•	•	■	■	■	■	■	■	•	■	■
Eon	■	•	■	■	•	■	•	•	■	■	■	■	•	■	•	•	■	■
Flux	■	•	•	•	■	•	■	•	■	■	■	■	■	■	■	•	■	■
Gamut	•	•	•	•	•	•	•	■	•	•	■	■	•	■	■	■	■	■
Glaze	•	•	•	•	•	•	•	•	•	•	■	■	•	•	•	•	•	•
Gleam	■	•	•	•	■	•	•	•	•	■	■	■	•	■	•	•	•	•
Gradate	■	•	•	•	■	•	•	•	•	■	■	■	•	■	•	•	•	•
Hatchmark	•	•	•	•	•	•	•	•	•	•	•	•	•	•	•	•	•	•
Hexstripe	■	•	•	•	■	•	■	•	■	■	■	■	■	■	■	•	■	■
Honor Plus	■	•	•	•	■	•	■	■	■	■	■	■	•	■	•	■	■	■
Inertia	■	•	•	•	■	•	■	■	■	■	■	■	■	■	■	•	■	■
Inertia Loomstate	•	•	•	•	•	•	•	•	•	•	•	•	•	•	•	•	•	•
Inkling	■	•	•	•	■	•	■	•	■	■	■	■	■	■	■	•	■	■
Jaunt	■	•	•	•	■	•	■	•	■	■	■	■	■	■	■	•	■	■
Journey	■	•	■	■	•	■	•	•	■	■	■	■	•	■	•	■	■	■
Klange	■	■	•	•	■	•	■	■	■	■	■	■	■	■	■	•	■	■
Latitude	■	•	•	■	•	•	•	•	•	■	■	■	•	■	•	•	•	•
Lattice	■	•	•	•	■	•	■	•	■	■	■	■	■	■	■	•	■	■
Leaf Dot	■	•	•	•	■	•	•	•	•	■	■	■	•	■	•	•	•	•
Leland	■	■	•	•	■	•	■	•	■	■	■	■	■	■	■	■	■	■
Little Plaid	■	•	•	•	■	•	•	•	•	■	■	■	•	■	•	•	•	•
Lofty	■	•	•	•	■	•	■	■	■	■	■	■	■	■	■	■	■	■

*For Think 465 Series with 3D knit back, swen seat is only available in 3D Knit Black fabric. Must be ordered as a Select Solutions chair using general quote number CH016176 for 3D knit back in Black.

For information regarding Designtex fabrics, please see www.steelcase.com/surface-materials under the Custom Surfaces section.

Legend

- = Not available
- = Available
- ▶ See specification pages for details.

	Steelcase Health														
	Aspekt	Cura	Leela	Mitra	Jarrah	Regard	Sieste	Sorrel	Tava Guest	Tava Lounge	Empath Recliner	Mineral Recliner	Mitra Recliner	Sieste Sleeper	X-tenz Sleeper
Designtex Fabrics															
Dart	■	■	■	■	■	■	■	■	■	■	■	■	■	■	■
Divide	■	•	•	•	•	•	•	■	•	•	•	•	•	•	•
Draft	■	■	■	■	■	■	■	■	■	■	■	■	■	■	■
Eon	■	■	■	■	■	■	■	■	■	■	■	■	■	■	■
Flux	■	■	■	■	■	■	■	■	■	■	■	■	■	■	■
Gamut	■	■	■	■	■	■	■	■	■	■	■	■	■	■	■
Glaze	•	•	•	•	•	•	•	•	•	•	•	•	■	•	•
Gleam	■	•	•	•	•	•	•	■	•	•	•	•	•	•	•
Gradate	■	•	•	•	•	•	•	■	•	•	•	•	•	•	•
Hatchmark	•	•	•	•	■	•	■	•	•	•	■	•	•	■	•
Hexstripe	■	■	■	■	■	■	■	■	■	■	■	■	■	■	■
Honor Plus	■	■	■	■	■	■	■	■	■	■	■	■	■	■	■
Inertia	■	■	■	■	■	■	■	■	■	■	■	■	■	■	■
Inertia Loomstate	•	•	•	•	•	•	•	•	•	•	•	•	•	•	•
Inkling	■	■	■	■	■	■	■	■	■	■	■	■	■	■	■
Jaunt	■	■	■	■	■	■	■	■	■	■	■	■	■	■	■
Journey	■	■	■	■	■	■	■	■	■	■	■	■	■	■	■
Klange	■	■	■	■	■	■	■	■	■	■	■	■	■	■	■
Latitude	•	•	•	•	•	•	•	•	•	•	•	•	•	•	•
Lattice	■	■	■	■	■	■	■	■	■	■	■	■	■	■	■
Leaf Dot	■	•	•	•	•	•	•	■	•	•	•	•	•	•	•
Leland	■	■	■	■	■	■	■	■	■	■	■	■	■	■	■
Little Plaid	■	•	•	•	•	•	•	■	■	•	•	•	•	•	•
Lofty	■	■	■	■	■	■	■	■	■	■	■	■	■	■	■

For information regarding Designtex fabrics, please see www.steelcase.com/surface-materials under the Custom Surfaces section.

Approved Fabrics that Meet DFAR 252.225-7012 Preference for Certain Domestic Commodities
Used for Navy BPA, continued

Legend

- = Not available
- = Available
- ▶ See specification pages for details.

Steelcase Seating	Amia 482 Series Standard Upholstered Seat and Back	Amia 482 Series - Sewn	Brody 488	Cachet 487 Series - Standard	cobi 434 Series - Connect 3D - Standard	cobi 434 Series - Connect 3D - Sewn	Criterion 453 Series - Standard, Molded	Criterion 453 Series - Standard, Plus	Criterion 453 Series - Sewn	Criterion 453 Series - Sewn Back, Sewn Seat	c:scape Cushion Tops	Gesture 442 Series - Non Sewn	i2i 416 Series - 3D Knit - Sewn	Jersey Series - Jersey Mesh - Standard	Jersey Series - Sewn	Kart	Leap 462 Series - 3D Knit Standard	Leap 462 Series Standard	Leap Plus 462 Series - 3D Knit Standard	Leap Plus 462 Series - Standard	Leap 462 Series - 3D Knit - Sewn	Leap 462 Series - Sewn	Leap Plus 462 Series - 3D Knit - Sewn	Leap Plus 462 Series - Sewn	media:scape Lounge	Move 490 Series - Standard	
Designtex Fabrics																											
Mandala	■	■	•	■	•	■	■	■	•	■	■	■	■	■	•	■	■	■	■	■	■	■	■	•	•	•	■
Majolica with backing	■	■	■	•	•	■	■	■	•	■	■	■	■	■	•	■	■	■	■	■	■	■	■	•	•	•	■
Metamorphosis	•	•	•	•	•	•	•	•	•	•	■	•	•	•	•	•	•	•	•	•	•	•	■	■	•	•	•
Metamorphosis with backing	•	■	■	■	•	■	•	■	•	■	■	■	■	•	■	■	■	■	■	■	■	■	■	■	■	■	■
Migration	•	•	•	•	•	•	•	•	•	•	■	•	•	•	•	•	•	•	•	•	•	•	■	■	•	•	•
Migration with backing	•	■	■	■	•	■	•	■	•	■	■	■	■	•	■	■	■	■	■	■	■	■	■	■	■	■	■
Mod	■	■	•	•	•	■	•	■	•	■	■	■	■	■	•	■	■	■	■	■	■	■	■	•	•	•	■
Motif	■	■	•	•	•	■	■	■	•	■	■	■	■	■	•	■	■	■	■	■	■	■	■	•	•	•	■
Nexus	■	■	■	•	•	■	■	■	•	■	■	■	■	■	•	■	■	■	■	■	■	■	■	•	•	•	■
Nonchalant	■	•	•	■	•	•	■	•	•	•	■	•	•	■	•	•	■	■	■	■	■	■	•	•	•	■	■
Notion	■	■	■	■	•	■	■	■	•	■	■	■	■	■	•	■	■	■	■	■	■	■	■	■	■	■	■
Omar	■	■	■	■	•	■	•	•	•	•	■	•	•	■	•	■	■	■	■	■	■	■	•	•	•	■	•
Oscillate	■	■	■	•	•	■	•	•	•	•	■	•	•	■	•	■	■	■	■	■	■	■	■	•	•	•	■
Oscillate Loomstate	•	•	•	•	•	•	•	•	•	•	•	•	•	•	•	•	•	•	•	•	•	•	•	•	•	•	•
Phase	•	■	•	■	•	■	•	■	•	■	■	■	■	•	■	■	■	■	■	■	■	■	■	■	■	■	■
Pinball	■	■	•	•	•	■	•	■	•	■	■	■	■	■	•	■	■	■	■	■	■	■	■	•	•	•	■
Pinpoint	■	■	•	•	•	■	■	■	•	■	■	■	■	■	•	■	■	■	■	■	■	■	■	•	•	•	■
Pleat	•	■	■	•	•	■	•	■	•	■	■	■	■	■	•	■	■	■	■	■	■	■	■	■	■	■	■
Pop Art	■	■	•	•	•	■	■	■	•	■	■	■	■	■	•	■	■	■	■	■	■	■	■	•	•	•	■
Posey	•	■	•	•	•	■	•	■	•	■	■	■	■	■	•	■	■	■	■	■	■	■	■	•	•	•	■
Prompt	■	•	•	•	•	■	•	•	•	•	■	•	•	■	•	•	■	■	■	■	■	■	■	■	■	■	■
Quintessence	•	■	■	•	•	■	•	■	•	■	■	■	■	■	•	■	■	■	■	■	■	■	■	■	■	■	■
Rail	■	•	•	•	•	•	•	•	•	•	■	•	•	■	•	•	■	■	■	■	■	■	■	■	■	■	■
Rice	•	■	■	•	•	■	•	■	•	■	■	■	■	■	•	■	■	■	■	■	■	■	■	■	■	■	■

Tip: 3D knit model numbers 4821418 and 4827418 not available.

For information regarding Designtex fabrics, please see www.steelcase.com/surface-materials under the Custom Surfaces section.

Legend

- = Not available
- = Available
- ▶ See specification pages for details.

	Steelcase Seating, continued										Steelcase Wood Seating			turnstone Seating				
	Player 475 Series - Standard	Protégé 433 Series - Standard	Protégé 433 Series - Sewn	Reply 466 Series - Guest Sewn	Reply 466 Series - Guest Standard	Reply 466 Series - Sewn (task)	Reply 466 Series - Standard (task)	Siento	Think 465 Series - 3D Knit Back, Sewn Seat	Think 465 Series - Upholstered Back, Sewn Seat	Collaboration	Mingle	Snodgrass	Crew Task	Crew Guest	Jack	Uno	Scoop
Designtex Fabrics																		
Mandala	■	•	•	•	■	•	■	•	■	■	■	■	■	■	■	■	■	■
Majolica with backing	■	•	•	•	•	•	•	•	■	■	■	■	■	■	■	•	■	■
Metamorphosis	•	•	•	•	•	•	•	•	•	•	•	•	•	•	•	•	•	•
Metamorphosis with backing	■	•	■	■	•	■	•	•	■	■	■	■	■	■	■	■	■	■
Migration	•	•	•	•	•	•	•	•	•	•	•	•	•	•	•	•	•	•
Migration with backing	■	•	■	■	•	■	•	•	■	■	■	■	■	■	■	■	■	■
Mod	■	•	•	•	■	•	■	•	■	■	■	■	■	■	■	•	■	■
Motif	■	•	•	•	■	•	■	•	■	■	■	■	■	■	■	•	■	■
Nexus	■	•	•	•	■	•	■	•	■	■	■	■	■	■	■	•	■	■
Nonchalant	■	■	•	•	■	•	•	•	•	■	•	■	■	•	■	•	•	•
Notion	■	•	•	•	■	•	■	■	■	■	■	■	■	■	■	■	■	■
Omar	•	•	•	•	■	•	■	•	■	■	■	■	■	■	■	■	■	■
Oscillate	■	•	•	•	■	•	■	■	■	■	■	■	■	■	■	•	■	■
Oscillate Loomstate	•	•	•	•	•	•	•	•	•	•	•	•	•	•	•	•	•	•
Phase	■	•	■	■	•	■	•	•	■	■	■	■	■	■	■	■	■	■
Pinball	■	•	•	•	■	•	■	•	■	■	■	■	■	■	■	•	■	■
Pinpoint	■	•	•	•	■	•	■	•	■	■	■	■	■	■	■	•	■	■
Pleat	■	•	•	•	■	•	■	■	■	■	■	■	■	■	■	■	■	■
Pop Art	■	•	•	•	■	•	■	•	■	■	■	■	■	■	■	•	■	■
Posey	■	•	•	•	■	•	■	•	■	■	■	■	■	•	■	•	■	■
Prompt	■	•	•	•	■	•	■	•	■	■	■	■	■	•	■	•	•	•
Quintessence	■	•	•	•	■	•	■	■	■	■	■	■	■	•	■	■	■	■
Rail	■	•	•	•	■	•	■	•	■	■	■	■	■	•	■	•	■	■
Rice	■	•	•	•	■	•	■	■	■	■	■	■	■	•	■	■	■	■

*For Think 465 Series with 3D knit back, swen seat is only available in 3D Knit Black fabric. Must be ordered as a Select Solutions chair using general quote number CH016176 for 3D knit back in Black.

For information regarding Designtex fabrics, please see www.steelcase.com/surface-materials under the Custom Surfaces section.

Approved Fabrics that Meet DFAR 252.225-7012 Preference for Certain Domestic Commodities
Used for Navy BPA, continued

Legend

- = Not available
- = Available
- ▶ See specification pages for details.

	Steelcase Health														
	Aspekt	Cura	Leela	Mitra	Jarrah	Regard	Sieste	Sorrel	Tava Guest	Tava Lounge	Empath Recliner	Mineral Recliner	Mitra Recliner	Sieste Sleeper	X-tenz Sleeper
Designtex Fabrics															
Mandala	■	■	■	■	■	■	■	■	■	■	■	■	■	■	■
Majolica with backing	■	■	■	■	■	■	■	■	■	■	■	■	■	■	■
Metamorphosis	•	•	•	•	•	•	•	•	•	•	•	•	•	•	•
Metamorphosis with backing	■	■	■	■	■	■	■	■	■	■	■	■	■	■	■
Migration	•	•	•	•	•	•	•	•	•	•	•	•	•	•	•
Migration with backing	■	■	■	■	■	■	■	■	■	■	■	■	■	■	■
Mod	■	■	■	■	■	■	■	■	■	■	■	■	■	■	■
Motif	■	■	■	■	■	■	■	■	■	■	■	■	■	■	■
Nexus	■	■	■	■	■	■	■	■	■	■	■	■	■	■	■
Nonchalant	■	•	•	•	•	•	•	■	•	•	•	•	•	•	•
Notion	■	■	■	■	■	■	■	■	■	■	■	■	■	■	■
Omar	■	■	■	■	■	■	■	■	■	■	■	■	■	■	■
Oscillate	■	■	■	■	■	■	■	■	■	■	■	■	■	■	■
Oscillate Loomstate	•	•	•	•	•	•	•	•	•	•	•	•	•	•	•
Phase	■	■	■	■	■	■	■	■	■	■	■	■	■	■	■
Pinball	■	■	■	■	■	•	■	•	■	■	■	■	■	■	■
Pinpoint	■	■	■	■	■	•	■	■	■	■	■	■	■	■	■
Pleat	■	■	■	■	■	■	■	■	■	■	■	■	■	■	■
Pop Art	■	■	■	■	■	■	■	■	■	■	■	■	■	■	■
Posey	■	■	■	■	■	■	■	■	■	■	■	■	■	■	■
Prompt	■	•	•	•	•	•	•	■	•	•	•	•	•	•	•
Quintessence	■	■	■	■	■	■	■	■	■	■	■	■	■	■	■
Rail	■	•	•	•	•	•	•	■	•	•	•	•	•	•	•
Rice	■	■	■	■	■	■	■	■	■	■	■	■	•	■	■

For information regarding Designtex fabrics, please see www.steelcase.com/surface-materials under the Custom Surfaces section.

Legend

- = Not available
- = Available
- ▶ See specification pages for details.

	Steelcase Seating																										
	Amia 482 Series Standard Upholstered Seat and Back	Amia 482 Series - Sewn	Brody 488	Cachet 487 Series - Standard	cobi 434 Series - Connect 3D - Standard	cobi 434 Series - Connect 3D - Sewn	Criterion 453 Series - Standard, Molded	Criterion 453 Series - Standard, Plus	Criterion 453 Series - Sewn	Criterion 453 Series - Sewn Back, Sewn Seat	c:scape Cushion Tops	Gesture 442 Series - Non Sewn	i2i 416 Series - 3D Knit - Sewn	Jersey Series - Jersey Mesh - Standard	Jersey Series - Sewn	Kart	Leap 462 Series - 3D Knit Standard	Leap 462 Series Standard	Leap Plus 462 Series - 3D Knit Standard	Leap Plus 462 Series - Standard	Leap 462 Series - 3D Knit - Sewn	Leap 462 Series - Sewn	Leap Plus 462 Series - 3D Knit - Sewn	Leap Plus 462 Series - Sewn	media:scape Lounge	Move 490 Series - Standard	
Designtex Fabrics																											
Rocket	■	•	■	■	•	■	■	•	•	■	■	■	■	■	•	■	■	■	■	■	■	•	•	•	•	■	■
Rotary	■	■	•	•	•	■	■	•	•	■	■	■	■	■	•	■	■	■	■	■	■	•	•	•	•	■	■
Rothesay	■	•	•	■	•	•	■	■	•	•	■	■	■	■	•	■	■	■	■	■	■	•	•	•	•	■	■
Rothesay with backing	■	■	■	■	•	■	■	■	•	■	■	■	■	■	•	■	■	■	■	■	■	•	•	•	•	■	■
Round Leaves	■	■	■	•	•	■	■	■	•	■	■	■	■	■	•	■	■	■	■	■	■	•	•	•	•	■	■
See Saw	•	■	•	•	•	■	•	■	•	■	■	■	■	■	•	■	■	■	■	■	■	•	•	•	•	■	■
Seed	•	■	•	•	•	■	•	■	•	■	■	■	■	■	•	■	■	■	■	■	■	•	•	•	•	■	■
Shibori Stripe	■	■	■	■	•	■	■	■	•	■	■	■	■	■	•	■	■	■	■	■	■	•	•	•	•	■	■
Shimmering Tide with knit backing	■	■	■	•	■	■	■	■	•	■	■	■	■	■	•	■	■	■	■	■	■	•	•	•	•	■	■
Signal	•	■	•	■	•	■	■	■	•	■	■	■	■	■	•	■	■	■	■	■	■	•	•	•	•	■	■
Strand	•	■	•	■	•	■	■	■	•	■	■	■	■	■	•	■	■	■	■	■	■	•	•	•	•	■	■
Striae	•	■	■	•	•	■	■	■	•	■	■	■	■	■	•	■	■	■	■	■	■	•	•	•	•	■	■
Sugar Shoots	•	•	•	•	•	■	■	■	•	■	■	■	■	■	•	■	■	■	■	■	■	•	•	•	•	■	■
Swing	■	•	•	•	•	■	■	■	•	■	■	■	■	■	•	■	■	■	■	■	■	•	•	•	•	■	■
Tangle	•	•	•	•	•	■	■	■	•	■	■	■	■	■	•	■	■	■	■	■	■	•	•	•	•	■	■
Tetris	■	■	•	•	•	■	■	■	■	■	■	■	■	■	•	■	■	■	■	■	■	•	•	•	•	■	■
The Last Aphid	■	■	•	•	•	■	■	■	■	■	■	■	■	■	•	■	■	■	■	■	■	•	•	•	•	■	■
Tramway	■	•	•	•	•	■	■	■	■	■	■	■	■	■	•	■	■	■	■	■	■	•	•	•	•	■	■
Transport	■	■	•	•	•	■	■	■	■	■	■	■	■	■	•	■	■	■	■	■	■	•	•	•	•	■	■
Tumble Stones	•	■	■	■	•	■	■	■	•	■	■	■	■	■	•	■	■	■	■	■	■	•	•	•	•	■	■
Tumble Stones with backing	•	■	■	■	•	■	■	■	•	■	■	■	■	■	•	■	■	■	■	■	■	•	•	•	•	■	■
Tumbleweed	•	■	■	•	•	■	■	■	•	■	■	■	■	■	•	■	■	■	■	■	■	•	•	•	•	■	■
Turn	•	■	•	•	•	■	■	■	•	■	■	■	■	■	•	■	■	■	■	■	■	•	•	•	•	■	■
Vivid	■	■	■	■	•	■	■	■	■	■	■	■	■	■	•	■	■	■	■	■	■	•	•	•	•	■	■
Whim	■	■	■	■	•	■	■	■	■	■	■	■	■	■	•	■	■	■	■	■	■	•	•	•	•	■	■
Windowpane	•	•	•	•	•	■	■	■	•	■	■	■	■	■	•	■	■	■	■	■	■	•	•	•	•	■	■
Woodcut	■	■	■	•	•	■	■	■	■	■	■	■	■	■	•	■	■	■	■	■	■	•	•	•	•	■	■
Yucca	■	•	•	•	•	■	■	■	■	■	■	■	■	■	•	■	■	■	■	■	■	•	•	•	•	■	■

Tip: 3D knit model numbers 4821418 and 4827418 not available.

For information regarding Designtex fabrics, please see www.steelcase.com/surface-materials under the Custom Surfaces section.

Approved Fabrics that Meet DFAR 252.225-7012 Preference for Certain Domestic Commodities
Used for Navy BPA, continued

Legend

- = Not available
- = Available
- ▶ See specification pages for details.

	Steelcase Seating								Steelcase Wood Seating			turnstone Seating						
	Player 475 Series - Standard	Protégé 433 Series - Standard	Protégé 433 Series - Sewn	Reply 466 Series - Guest Sewn	Reply 466 Series - Guest Standard	Reply 466 Series - Sewn (task)	Reply 466 Series - Standard (task)	Siento	Think 465 Series - 3D Knit Back, Sewn Seat	Think 465 Series - Upholstered Back, Sewn Seat	Collaboration	Mingle	Snodgrass	Crew Task	Crew Guest	Jack	Uno	Scoop
Designtex Fabrics																		
Rocket	■	•	•	•	■	•	■	■	■	■	■	■	■	■	■	■	■	■
Rotary	■	•	•	•	■	•	■	■	■	■	■	■	■	■	•	■	•	■
Rothesay	■	■	•	•	■	•	•	•	•	•	■	■	■	■	■	■	■	■
Rothesay with backing	■	■	•	•	■	•	■	■	■	■	■	■	■	■	■	■	■	■
Round Leaves	■	•	•	•	■	•	■	■	■	■	■	■	■	■	■	■	•	■
See Saw	■	•	•	•	■	•	■	■	■	■	■	■	■	■	•	■	■	■
Seed	■	•	•	•	■	•	•	•	■	■	■	■	■	■	•	■	■	■
Shibori Stripe	■	•	•	•	■	•	■	■	■	■	■	■	■	■	■	■	■	■
Shimmering Tide with knit backing	■	•	•	•	■	•	■	■	■	■	■	■	■	■	•	■	•	■
Signal	■	•	•	•	■	•	■	■	■	■	■	■	■	■	■	■	■	■
Strand	■	•	■	■	•	■	•	•	■	■	■	■	■	■	•	■	•	■
Striae	■	•	•	•	■	•	■	■	■	■	■	■	■	■	■	■	■	■
Sugar Shoots	■	•	•	•	■	•	•	•	•	•	■	■	■	■	•	■	•	•
Swing	•	•	•	•	■	•	•	•	•	•	■	■	■	■	•	■	•	•
Tangle	•	•	•	•	•	•	•	•	•	•	■	■	■	■	•	■	•	•
Tetris	■	•	•	•	■	•	■	■	■	■	■	■	■	■	■	■	•	■
The Last Aphid	■	•	•	•	■	•	■	■	■	■	■	■	■	■	■	■	•	■
Tramway	■	•	•	•	■	•	■	■	■	■	■	■	■	■	•	■	•	•
Transport	■	•	•	•	■	•	■	■	■	■	■	■	■	■	■	■	■	■
Tumble Stones	■	•	■	■	•	■	•	•	■	■	■	■	■	■	•	■	•	■
Tumble Stones with backing	■	•	■	■	•	■	•	•	■	■	■	■	■	■	•	■	•	■
Tumbleweed	■	•	•	•	■	•	•	■	■	■	■	■	■	■	•	■	■	•
Turn	■	•	•	•	■	•	■	■	■	■	■	■	■	■	■	■	•	■
Vivid	■	•	•	•	■	•	■	■	■	■	■	■	■	■	■	■	■	■
Whim	■	■	•	•	■	•	■	■	■	■	■	■	■	■	■	■	■	■
Windowpane	■	•	•	•	■	•	•	•	•	•	■	■	■	■	•	■	•	•
Woodcut	■	•	•	•	■	•	■	■	■	■	■	■	■	■	■	■	■	■
Yucca	■	•	•	•	■	•	•	•	•	•	■	■	■	■	•	■	•	•

*For Think 465 Series with 3D knit back, swen seat is only available in 3D Knit Black fabric. Must be ordered as a Select Solutions chair using general quote number CH016176 for 3D knit back in Black.

For information regarding Designtex fabrics, please see www.steelcase.com/surface-materials under the Custom Surfaces section.

Legend

- = Not available
- = Available
- ▶ See specification pages for details.

	Steelcase Health														
	Aspekt	Cura	Leela	Mitra	Jarrah	Regard	Sieste	Sorrel	Tava Guest	Tava Lounge	Empath Recliner	Mineral Recliner	Mitra Recliner	Sieste Sleeper	X-tenz Sleeper
Designtex Fabrics															
Rocket	■	■	■	■	■	■	■	■	■	■	■	■	■	■	■
Rotary	■	■	■	■	■	■	■	■	■	■	■	■	■	■	■
Rothesay	■	•	•	•	•	•	•	•	•	•	•	•	•	•	•
Rothesay with backing	■	■	■	■	■	■	■	■	■	■	■	■	■	■	■
Round Leaves	■	■	■	■	■	■	■	■	■	■	■	■	■	■	■
See Saw	■	■	■	■	■	■	■	■	■	■	■	■	■	■	■
Seed	■	■	■	■	■	■	■	■	■	■	■	■	■	■	■
Shibori Stripe	■	■	■	■	■	■	■	■	■	■	■	■	■	■	■
Shimmering Tide with knit backing	•	■	■	■	■	■	■	■	■	■	■	■	■	■	■
Signal	■	■	■	■	■	■	■	■	■	■	■	■	■	■	■
Strand	■	■	■	■	■	•	■	■	■	■	■	■	■	■	■
Striae	■	■	■	■	■	■	■	■	■	■	■	■	■	■	■
Sugar Shoots	■	•	•	•	•	•	•	■	•	•	•	•	•	•	•
Swing	■	•	•	•	•	•	•	■	•	•	•	•	•	•	•
Tangle	•	•	•	•	•	•	•	•	•	•	•	•	•	•	•
Tetris	■	■	■	■	■	■	■	■	■	■	■	■	■	■	■
The Last Aphid	■	■	■	■	■	■	■	■	■	■	■	■	■	■	■
Tramway	■	•	•	•	•	•	•	■	•	•	•	•	•	•	•
Transport	■	■	■	■	■	■	■	■	■	■	■	■	■	■	■
Tumble Stones	■	■	■	■	■	■	■	■	■	■	■	■	■	■	■
Tumble Stones with backing	■	■	■	■	■	■	■	■	■	■	■	■	■	■	■
Tumbleweed	■	■	■	■	■	■	■	■	■	■	■	■	■	■	■
Turn	■	■	■	■	■	■	■	■	■	■	■	■	■	■	■
Vivid	■	■	■	■	■	■	■	■	■	■	■	■	■	■	■
Whim	■	■	■	■	■	■	■	■	■	■	■	■	■	■	■
Windowpane	■	•	•	•	•	•	•	■	•	•	•	•	•	•	•
Woodcut	■	■	■	■	■	■	■	■	■	■	■	■	■	■	■
Yucca	■	•	•	•	•	•	•	■	•	•	•	•	•	•	•

For information regarding Designtex fabrics, please see www.steelcase.com/surface-materials under the Custom Surfaces section.

Resources

Lock and Keying	440
Style Number Index	442

Lock and Keying

For Use with Folio, Ainsley, Park, Senza, and Waldorf

Locks are optional and factory or field-installed to secure the doors or top drawers of a cabinet. Factory-installed locks are available keyed random with consecutive, specific, or random keying options. Master-key locks are also available. Field-installed lock cylinders must be specified separately.

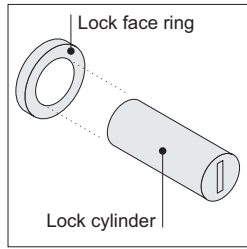

Locks consist of a factory- or field-installed lock cylinder and a factory-installed lock face ring.

Two types of locks are available — the standard keying system (FR series) and the master keying system (XF series). All the locks in the XF series can be opened with a single master key.

Factory-Installed Keying

Optional factory-installed locks are always key random or master key random. Key random means that the locks will be assigned arbitrarily at the factory with key numbers ranging from FR305 to FR454 (Master keying numbers: XF1001 to XF1150).

Tip: Random keying can mean that different furniture units will have the same key number. If you must have all locks keyed differently, you should specify field-installed, key specific or key consecutive lock cylinders.

▶ See below.

Key Random

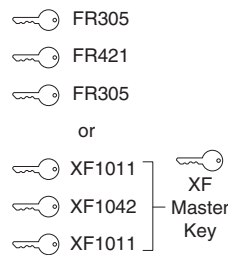

Required to Specify

Master key random	+\$24	Specify with master key random.
--------------------------	-------	---------------------------------

Field-Installed Keying

Field-installed locks are only available on products that include factory-installed lock mechanisms.

Specify “plug” when specifying furniture, and the product will ship with a plastic plug in place of the lock cylinder.

Front-removable lock cylinders must be specified separately. You must also order a special lock tool to install or remove lock cylinders in the field.

Tip: Lock tools are reusable. You do not need to order additional lock tools with every furniture order.

Lock cylinders will be shipped separately so that you can install the locks when you are ready.

Three keying choices are available for field installation—random (standard), specific, and consecutive. All three are also available with master keying, which means that all locks can be opened with a single master key.

Key random means that the locks will be assigned arbitrarily at the factory with key numbers ranging from FR305 to FR454 (Master keying numbers: XF1001 to XF1150).

Tip: Random keying can mean that different furniture units will have the same key number. If you must have all locks keyed differently, you should specify key specific or key consecutive lock cylinders.

Key Random

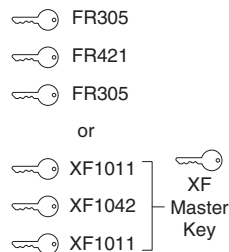

Key specific means that you can specify any key number from FR305 to FR454 (Master keying numbers: XF1001 to XF1150). This option can be used to key all the furniture units in a workstation or department the same.

Tip: Designate the quantity per key number in your specification.

▶ See example at right.

Key Specific

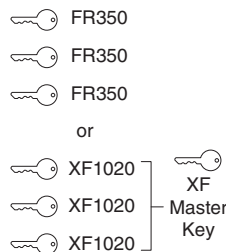

Key consecutive means that you can specify lock numbers in a consecutive order to ensure that no two locks have the same key number until the key sequence repeats. You must select a beginning key number from FR305 to FR454 (Master keying numbers: XF1001 to XF1150).

Key Consecutive

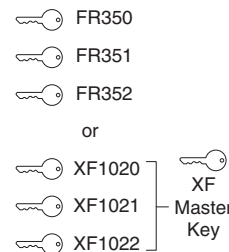

Example of a typical lock cylinder specification is shown below:

10	LOCK9201FR	FR320
5	LOCK9201FR	FR350
15	LOCK9201XF	XF1100
30	Total	
1	877102003SR	standard lock tool
1	877102002SR	master lock tool

Field-Installed Lock Cylinders

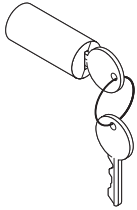

Tip: Lock price is included in price of furniture with locks.

Tip: For replacement lock cylinders, refer to Service Parts.

Standard Includes	Required to Specify
-------------------	---------------------

- | | |
|---|--|
| <ul style="list-style-type: none"> • Lock cylinder: 9201 Polished Chrome • Two keys | <ul style="list-style-type: none"> 1 Style number 2 Options, if selected (see below) |
|---|--|

Options	Price	Required to Specify
---------	-------	---------------------

Key specific	No cost	Select key number from FR305–FR454.
Key consecutive	No cost	Specify <i>key consecutive</i> and select beginning key number from FR305–FR454.
Master key random	+\$24 each	Specify <i>master key random</i> .
Master key specific	+\$24 each	Specify key number from XF1001–XF1150.
Master key consecutive	+\$24 each	Specify <i>master key consecutive</i> and select beginning key number from XF1001–XF1150.

Specification Information		
---------------------------	--	--

Color	Style Number	Base Price
:	:	:

FR Series (Standard Keying System) – Lock Cylinder

Polished Chrome	LOCK9201FR	No cost
:	:	:

Standard Lock Tool

	877102003SR	\$24
:	:	:

XF Series (Master Keying System) – Lock Cylinder

Polished Chrome	LOCK9201XF	No additional cost. Price included in price of furniture with master-keyed locks.
:	:	:

Master Lock Tool

	877102002SR	\$24
:	:	:

Tip: You can change lock cylinders in the field by using the appropriate lock tool.

Style Number Index

Style Number	Page	Description
70BT2001	352	Davenport Bedside Table
70BT2005L	352	Davenport Bedside Table
70BT2005R	352	Davenport Bedside Table
70CH4001	350	Davenport Dresser
70DR3201	350	Davenport Dresser
70FB3901	383	Davenport Footboard
70FB5401	383	Footboard
70FB6001	383	Footboard
70HB3901	383	Headboard
70HB5401	383	Headboard
70HB6001	383	Headboard
70NT2000	352	Davenport Bedside Table
70WR2401L	349	Davenport Wardrobe Cabinet
70WR2401R	349	Davenport Wardrobe Cabinet
70WR3601	349	Davenport Wardrobe Cabinet
70WT4201	351	Davenport Writing Desk
877102002SR	441	Master Lock Tool
877102003SR	441	Standard Lock Tool
98769	137	Anchor Brkt
FPAHANDLE	285	FYI Sync Handle
FPASINGLECC	284	FYI C-clamp Mounting Brkt
FPASYNCL	284	FYI Sync Lower Monitor Arm
FPASYNCLD	285	LED w/bracket, Sync
FPASYNCLM	285	FYI Sync Hardware Pack
FPASYNCSWR	284	FYI Sync Lower Monitor Arm, Sltwl/Sitrl
FPASYNCSU	284	FYI Sync Upper Monitor Arm
H2BG30LL	346	Ainsley Bedside Table
H2BG30RL	346	Ainsley Bedside Table
H2BM30L	346	Ainsley Bedside Table
H2D330L	345	Ainsley Dresser
H2D438L	345	Ainsley Dresser
H2NE24L	346	Ainsley Bedside Table
H3BG30LL	369	Senza Bedside Table
H3BG30LR	370	Senza Bedside Table
H3BG30RL	369	Senza Bedside Table
H3BG30RR	370	Senza Bedside Table
H3BM30L	369	Senza Bedside Table
H3BM30R	370	Senza Bedside Table
H3D330L	366	Senza Dresser
H3D330R	367	Senza Dresser
H3D438L	366	Senza Dresser
H3D438R	367	Senza Dresser
H3NE24L	369	Senza Bedside Table
H3NE24R	370	Senza Bedside Table
H3W124LL	362	Senza Wardrobe Cabinet
H3W124LR	364	Senza Wardrobe Cabinet
H3W124RL	362	Senza Wardrobe Cabinet
H3W124RR	364	Senza Wardrobe Cabinet
H3W1C24LL	363	Senza Wardrobe Cabinet
H3W1C24LR	365	Senza Wardrobe Cabinet
H3W1C24RL	363	Senza Wardrobe Cabinet
H3W1C24RR	365	Senza Wardrobe Cabinet
H3W236L	363	Senza Wardrobe Cabinet
H3W236R	365	Senza Wardrobe Cabinet
H3W2C36L	363	Senza Wardrobe Cabinet

Style Number	Page	Description
H3W2C36R	365	Senza Wardrobe Cabinet
H4BFM136R	356	Park Mobile Cabinet
H4BG30LR	357	Park Bedside Table
H4BG30RR	357	Park Bedside Table
H4BM30R	357	Park Bedside Table
H4W236R	355	Park Wardrobe Cabinet
H6BG30LR	376	Waldorf Bedside Table
H6BG30RR	376	Waldorf Bedside Table
H6BM30R	376	Waldorf Bedside Table
H6D330R	375	Waldorf Dresser
H6D438R	375	Waldorf Dresser
H6NE24R	376	Waldorf Bedside Table
H6W2C36R	374	Waldorf Wardrobe Cabinet
HAB2232	248	Opus Mounting Board
HAB3432	248	Opus Mounting Board
HAC24	249	Opus 24"W Cushion
HAC36	249	Opus 36"W Cushion
HADL18	387	Plastic Drawer Liner
HADL32	387	Plastic Drawer Liner
HAF4	250	Opus Floor-Anchor Brackets
HAFW	251	Opus OSHPD Brackets
HAH	249, 272	Opus Coat Hooks
HAMA1	272	Sonata Flat Screen Monitor Arm
HAW4	250	Opus Wall-Anchor Brackets
HB12	271	Sonata Base
HB24	271	Sonata Base
HB36	271	Sonata Base
HB42	271	Sonata Base
HB48	271	Sonata Base
HB60	271	Sonata Base
HB66	271	Sonata Base
HB72	271	Sonata Base
HB84	271	Sonata Base
HB84XAL	246	Opus Adjustable Corner Filler
HB84XL	246	Opus Inside Corner Filler
HBA10828	280	Sync Single-Sided Base
HBA10836	280	Sync Single-Sided Base
HBA10842	280	Sync Single-Sided Base
HBA7228	280	Sync Single-Sided Base
HBA7236	280	Sync Single-Sided Base
HBA7242	280	Sync Single-Sided Base
HBA8428	280	Sync Single-Sided Base
HBA8436	280	Sync Single-Sided Base
HBA8442	280	Sync Single-Sided Base
HBA9628	280	Sync Single-Sided Base
HBA9636	280	Sync Single-Sided Base
HBA9642	280	Sync Single-Sided Base
HBB1083628	276	Sync Double-Sided Base
HBB1084228	276	Sync Double-Sided Base
HBB1084236	276	Sync Double-Sided Base
HBB723628	276	Sync Double-Sided Base
HBB724228	276	Sync Double-Sided Base
HBB724236	276	Sync Double-Sided Base
HBB843628	276	Sync Double-Sided Base
HBB844228	276	Sync Double-Sided Base

Style Number	Page	Description	Style Number	Page	Description
HBB844236	276	Sync Double-Sided Base	HHB6001W	384	Headboard
HBB963628	276	Sync Double-Sided Base	HHBL	385	Headboard
HBB964228	276	Sync Double-Sided Base	HLS105	216	Surround Lounge, 104½" Frame Width
HBB964236	276	Sync Double-Sided Base	HLS44	177	Surround Lounge, 44" Frame Width
HBC2428L	282	Sync Single Leg Base	HLS55	180	Surround Lounge, 55" Frame Width
HBC2428R	282	Sync Single Leg Base	HLS61	184-185	Surround Lounge, 60½" Frame Width
HBC2436L	282	Sync Single Leg Base	HLS66	188-189	Surround Lounge, 66" Frame Width
HBC2436R	282	Sync Single Leg Base	HLS72	192-193	Surround Lounge, 71½" Frame Width
HBC2442L	282	Sync Single Leg Base	HLS77	196-197	Surround Lounge, 77" Frame Width
HBC2442R	282	Sync Single Leg Base	HLS83	200-201	Surround Lounge, 82½" Frame Width
HBC244L	282	Sync Single Leg Base	HLS88	204-205	Surround Lounge, 88" Frame Width
HBC24AR	282	Sync Single Leg Base	HLS94	208	Surround Lounge, 93½" Frame Width
HBRKTS	286	Solid Top Bridge Bracket	HLS99	212	Surround Lounge, 99" Frame Width
HBT2120	246	Opus Wall Trim Package	HLSET	217	Surround Storage, One-Tier End Table
HBT284	246	Opus Wall Trim Package	HLSMT	219	Surround, Mobile Tablet
HC2484AL	232	Opus Cabinet with 36"H Storage Unit	HLSTTT	218	Surround Storage, Two-Tier End Table
HC2484BL	232	Opus Cabinet with 36"H Storage Unit	HM1BB3619	268	Sonata Bench
HC2484CL	232	Opus Cabinet with 36"H Storage Unit	HM1BC3619	268	Sonata Bench
HC2484DL	234	Opus Cabinet with 30"H Storage Unit	HM1LA4836LL	262	Sonata Islands Laminate
HC2484EL	234	Opus Cabinet with 30"H Storage Unit	HM1LA4836LR	264	Sonata Island
HC2484FL	234	Opus Cabinet with 30"H Storage Unit	HM1LA4836LS	266	Sonata Island
HC2484GL	235	Opus Cabinet with 24"H Storage Unit	HM1LA4836RL	262	Sonata Island Laminate
HC2484JL	236	Opus Cabinet with 18½"H Strg Unit	HM1LA4836RR	264	Sonata Island
HC2484KL	236	Opus Cabinet with 18½"H Strg Unit	HM1LA4836RS	266	Sonata Island
HC2484LL	233	Opus Cab with 36"H Hngd Dr Strg Unit	HM1LB3636LL	263	Sonata Island with Open Storage
HC2484NL	237	Opus Desk Cabinet	HM1LB3636LR	265	Sonata Island with Open Storage
HC2484WHLL	240	Opus Wardrobe Cabinet	HM1LB3636LS	267	Sonata Island with Open Storage
HC2484WHRL	240	Opus Wardrobe Cabinet	HM1LB3636RL	263	Sonata Island with Open Storage
HC2484WSL	239	Opus Wardrobe Cabinet	HM1LB3636RR	265	Sonata Island with Open Storage
HC3684AL	232	Opus Cabinet with 36"H Storage Unit	HM1LB3636RS	267	Sonata Island with Open Storage
HC3684BL	232	Opus Cabinet with 36"H Storage Unit	HM1MA2436L	269	Sonata Media Unit
HC3684CL	232	Opus Cabinet with 36"H Storage Unit	HM1MA2436R	269	Sonata Media Unit
HC3684DL	234	Opus Cabinet with 30"H Storage Unit	HM1MA2436S	269	Sonata Media Unit
HC3684EL	234	Opus Cabinet with 30"H Storage Unit	HM1NA2439LL	256	Sonata Nurse Server
HC3684FL	234	Opus Cabinet with 30"H Storage Unit	HM1NA2439LR	258	Sonata Nurse Server
HC3684GL	235	Opus Cabinet with 24"H Storage Unit	HM1NA2439LS	260	Sonata Nurse Server
HC3684JL	236	Opus Cabinet with 18½"H Strg Unit	HM1NA2439RL	256	Sonata Nurse Server
HC3684KL	236	Opus Cabinet with 18½"H Strg Unit	HM1NA2439RR	258	Sonata Nurse Server
HC3684LL	233	Opus Cab with 36"H Hngd Dr Strg Unit	HM1NA2439RS	260	Sonata Nurse Server
HC3684ML	237	Opus Desk Cabinet	HM1NC2439LL	257	Sonata Nurse Server w/Waste Bin Stor
HC3684NL	237	Opus Desk Cabinet	HM1NC2439LR	259	Sonata Nurse Server w/Waste Bin Stor
HC3684PL	238	Opus Conference Table Cabinet	HM1NC2439LS	261	Sonata Nurse Server w/Waste Bin Stor
HC4884PL	238	Opus Conf Table Cabinet	HM1NC2439RL	257	Sonata Nurse Server w/Waste Bin Stor
HC7284PL	238	Opus Conf Table Cabinet	HM1NC2439RR	259	Sonata Nurse Server w/Waste Bin Stor
HFB3901L	384	Footboard	HM1NC2439RS	261	Sonata Nurse Server w/Waste Bin Stor
HFB5401L	384	Footboard	HM1WA1260	270	Sonata Wardrobe
HFB6001L	384	Footboard	HM2BB3619	268	Sonata Bench
HHB3901L	384	Headboard	HM2BC3619	268	Sonata Bench
HHB3901R	384	Headboard	HM2LA4836L	262	Sonata Islands Laminate
HHB3901W	384	Headboard	HM2LA4836R	264	Sonata Island
HHB5401L	384	Headboard	HM2LA4836S	266	Sonata Island
HHB5401R	384	Headboard	HM2LB3636L	263	Sonata Island with Open Storage
HHB5401W	384	Headboard	HM2LB3636R	265	Sonata Island with Open Storage
HHB6001L	384	Headboard	HM2LB3636S	267	Sonata Island with Open Storage
HHB6001R	384	Headboard	HM2MA2436L	269	Sonata Media Unit

Style Number Index, continued

Style Number	Page	Description
HM2MA2436R	269	Sonata Media Unit
HM2MA2436S	269	Sonata Media Unit
HM2NA2439L	256	Sonata Nurse Server
HM2NA2439R	258	Sonata Nurse Server
HM2NA2439S	260	Sonata Nurse Server
HM2NC2439L	257	Sonata Nurse Server w/Waste Bin Stor
HM2NC2439R	259	Sonata Nurse Server w/Waste Bin Stor
HM2NC2439S	261	Sonata Nurse Server w/Waste Bin Stor
HM2WA1260	270	Sonata Wardrobe
HMND2439L	257	Sonata Nurse Server w/Waste Bin Stor
HMND2439R	259	Sonata Nurse Server w/Waste Bin Stor
HMND2439S	261	Sonata Nurse Server w/Waste Bin Stor
HMR3201W	386	Mirror with Wood Frame
HN2300EMM	61	Cura Chair
HN2300MM	61	Cura Chair
HN2301EMM	61	Cura Chair
HN2301MM	61	Cura Chair
HN2305EMM	60	Cura Chair
HN2305HL	61	Cura Ottoman
HN2305HS	61	Cura Ottoman
HN2305MM	60	Cura Chair
HN2306EMM	60	Cura Chair
HN2306MM	60	Cura Chair
HN2310EML	61	Cura Chair
HN2310EMU	61	Cura Chair
HN2310ML	61	Cura Chair
HN2310MU	61	Cura Chair
HN2311EML	61	Cura Chair
HN2311EMU	61	Cura Chair
HN2311ML	61	Cura Chair
HN2311MU	61	Cura Chair
HN2315EML	60	Cura Chair
HN2315EMU	60	Cura Chair
HN2315ML	60	Cura Chair
HN2315MU	60	Cura Chair
HN2316EML	60	Cura Chair
HN2316ML	60	Cura Chair
HN2316MU	60	Cura Chair
HN240	115	Sieste Lounge
HN2402	115	Sieste Loveseat
HN2403	115	Sieste Sofa
HN240B30	116	Sieste Bariatric
HN24T1H	117	Sieste Table
HN24T1L	117	Sieste Table
HN26276SA	175	Sieste Sleeper
HN26276SP	175	Sieste Sleeper
HN26280SA	175	Sieste Sleeper
HN26280SP	175	Sieste Sleeper
HN26284SA	175	Sieste Sleeper
HN26284SP	175	Sieste Sleeper
HN262A	175	Sieste Bolster
HN5801CT	97	Neighbor Table
HN5801CU	97	Neighbor Table
HN5801H	96	Neighbor Ottoman
HN5810HCL	90	Neighbor Seating

Style Number	Page	Description
HN5810HCR	90	Neighbor Seating
HN5810HS	92	Neighbor Seating
HN5810LS	92	Neighbor Seating
HN5811LS	94	Neighbor Seating
HN5820BB	95	Neighbor Seating
HN5820HSS	92	Neighbor Seating
HN5820LSS	92	Neighbor Seating
HN5821LSS	94	Neighbor Seating
HN5825HSAS	93	Neighbor Seating
HN5825LSAS	93	Neighbor Seating
HN5830BBB	95	Neighbor Seating
HN5830HSSS	93	Neighbor Seating
HN5830LSSS	93	Neighbor Seating
HN5840DBBD	95	Neighbor Bench
HP1822FB	391	Pocket without Monitor Mount
HP2225FB	392	Pocket With Monitor Mount
HP2322FB	391	Pocket Without Monitor Mount
HPCTLS20	247	Opus Ceiling Track
HPCTS	247	Opus Ceiling Track
HR223	169	Empath Recliner
HR223D	169	Empath Recliner
HR223L	169	Empath Recliner
HR223R	169	Empath Recliner
HR223T	170	Empath Recliner
HR223TD	170	Empath Recliner
HR223TL	170	Empath Recliner
HR223TR	170	Empath Recliner
HS1B21C	124	Tava Bench
HS1B21S	127	Tava Bench
HS1B42C	124	Tava Bench
HS1B42S	127	Tava Bench
HS1B56C	124	Tava Bench
HS1B56S	127	Tava Bench
HS1B56T1C	124	Tava Bench
HS1B56T1S	128	Tava Bench
HS1B70C	124	Tava Bench
HS1B70S	127	Tava Bench
HS1B70T1C	124	Tava Bench
HS1B70T1S	128	Tava Bench
HS1B70T2C	124	Tava Bench
HS1B70T2S	128	Tava Bench
HS1C1	118	Tava Single-Seat Guest Chair
HS1C130	120	Tava Guest Bariatric Chair
HS1C140	120	Tava Guest Bariatric Chair
HS1C2	118	Tava Two-Seat Guest Chair
HS1CA2	119	Tava Two-Seat Guest Chair
HS1CA3	119	Tava Three-Seat Guest Chair
HS1CAU2	119	Tava Two-Seat Guest Chair
HS1CAU3	119	Tava Three-Seat Guest Chair
HS1CU1	118	Tava Single-Seat Guest Chair
HS1CU130	120	Tava Guest Bariatric Chair
HS1CU140	120	Tava Guest Bariatric Chair
HS1CU2	118	Tava Two-Seat Guest Chair
HS1L1	122	Tava Chair Lounge
HS1L130	123	Tava Bariatric Lounge

Style Number	Page	Description	Style Number	Page	Description
HS1L140	123	Tava Bariatric Lounge	HS4BD39	141	Regard Back
HS1L2	122	Tava Loveseat	HS4BD44	141	Regard Back
HS1L3	122	Tava Sofa	HS4BD50	141	Regard Back
HS1P1	121	Tava High-back Chair	HS4BD55	141	Regard Back
HS1P130	121	Tava High-back Chair	HS4BD61	141	Regard Back
HS1PU1	121	Tava Highback Chair	HS4BD66	142	Regard Back
HS1PU130	121	Tava Highback Chair	HS4BD72	142	Regard Back
HS1T1418C	129	Tava Freestanding Table	HS4BD77	142	Regard Back
HS1T1418S	130	Tava Freestanding Table	HS4BD83	142	Regard Back
HS1T2115C	129	Tava Freestanding Table	HS4BD88	142	Regard Back
HS1T2115S	130	Tava Freestanding Table	HS4BS33	140	Regard Back
HS1T2118C	129	Tava Freestanding Table	HS4BS44	140	Regard Back
HS1T2118S	130	Tava Freestanding Table	HS4BS55	140	Regard Back
HS1T4215C	129	Tava Freestanding Table	HS4BS61	140	Regard Back
HS1T4215S	130	Tava Freestanding Table	HS4BS66	140	Regard Back
HS21C	157	Verge Stool with Casters	HS4BS72	141	Regard Back
HS21G	157	Verge Stool with Glides	HS4BS77	141	Regard Back
HS2423SBL	243	Opus Overhead Shelf with Box Unit	HS4BS83	141	Regard Back
HS2424BL	244	Opus Overhead Storage Cabinet	HS4BS88	141	Regard Back
HS2435SBL	243	Opus Overhead Shelf with Box Unit	HS4CM	151	Regard Media Cabinet
HS24FL	242	Opus Overhead Shelf	HS4D1828L	151	Regard Desk Cabinet
HS24SL	242	Opus Overhead Shelf	HS4D1828S	151	Regard Desk Cabinet
HS27G	157	Verge Stool with Glides	HS4D1830L	151	Regard Desk Cabinet
HS2L121	80	Leela Lounge Chair	HS4D1830S	151	Regard Desk Cabinet
HS2L124	80	Leela Single-Seat Chair	HS4D1836L	151	Regard Desk Cabinet
HS2L130	81	Leela Bariatric Lounge	HS4D1836S	151	Regard Desk Cabinet
HS2L140	81	Leela Bariatric Lounge	HS4DR1828L	151	Regard Desk Cabinet
HS2L2	80	Leela Loveseat Chair	HS4DR1828S	151	Regard Desk Cabinet
HS2L3	80	Leela Sofa Chair	HS4DR1830L	151	Regard Desk Cabinet
HS2T212121C	82	Leela Freestanding Table	HS4DR1830S	151	Regard Desk Cabinet
HS2T212121S	82	Leela Freestanding Table	HS4DR1836L	151	Regard Desk Cabinet
HS2T422116C	82	Leela Freestanding Table	HS4DR1836S	151	Regard Desk Cabinet
HS2T422116S	82	Leela Freestanding Table	HS4FB44	135	Regard Bench Frame
HS31G	157	Verge Stool with Glides	HS4FB66	135	Regard Bench Frame
HS3623FBL	243	Opus Overhead Shelf with Box Unit	HS4FC4481	135	Regard Booth Frame
HS3623SBL	243	Opus Overhead Shelf with Box Unit	HS4FC5581	135	Regard Booth Frame
HS3624BL	244	Opus Overhead Storage Cabinet	HS4FD2255	135	Regard Desk Cabinet
HS3635FBL	243	Opus Overhead Shelf with Box Unit	HS4FD44	134	Regard Frame
HS3635SBL	243	Opus Overhead Shelf with Box Unit	HS4FD55	134	Regard Frame
HS36FL	242	Opus Overhead Shelf	HS4FD61	134	Regard Frame
HS36SL	242	Opus Overhead Shelf	HS4FD66	134	Regard Frame
HS42L1122	149	Regard Planter Liners	HS4FD72	134	Regard Frame
HS42L1133	149	Regard Planter Liners	HS4FD77	134	Regard Frame
HS42L1144	149	Regard Planter Liners	HS4FD83	134	Regard Frame
HS42L2222	149	Regard Planter Liners	HS4FD88	134	Regard Frame
HS4AD11	143	Regard Arm	HS4FE1144	136	Planter Frame Extension
HS4AD11C	143	Regard Arm	HS4FE1155	136	Regard Frame Extension
HS4AD6	143	Regard Arm	HS4FE1161	136	Planter Frame Extension
HS4AD6C	143	Regard Arm	HS4FE1166	136	Planter Frame Extension
HS4AS11	143	Regard Arm	HS4FE1172	136	Planter Frame Extension
HS4AS11C	143	Regard Arm	HS4FE1177	136	Planter Frame Extension
HS4AS6	143	Regard Arm	HS4FE1183	136	Planter Frame Extension
HS4AS6C	143	Regard Arm	HS4FE1188	136	Planter Frame Extension
HS4AU11	144	Regard Contour Arm	HS4FE2855	136	Regard Frame Extension
HS4BD33	141	Regard Back	HS4FG	137	Regard Frame Bracket

Style Number Index, continued

Style Number	Page	Description
HS4FS44	134	Regard Frame
HS4FS55	134	Regard Frame
HS4FS61	134	Regard Frame
HS4FS66	134	Regard Frame
HS4FS72	134	Regard Frame
HS4FS77	134	Regard Frame
HS4FS83	134	Regard Frame
HS4FS88	134	Regard Frame
HS4FSP44	135	Planter Frame
HS4FSP55	135	Planter Frame
HS4FSP61	135	Planter Frame
HS4FSP66	135	Planter Frame
HS4FSP72	135	Planter Frame
HS4FSP77	135	Planter Frame
HS4FSP83	135	Planter Frame
HS4FSP88	135	Planter Frame
HS4FW1155	135	Regard Wall-Mounted Frame
HS4H22	138	Regard Cushion
HS4H33	138	Regard Cushion
HS4HB	138	Regard Cushion
HS4LSP44	148	Regard Planter Shelf
HS4LSP55	148	Regard Planter Shelf
HS4LSP61	148	Regard Planter Shelf
HS4LSP66	148	Regard Planter Shelf
HS4LSP72	148	Regard Planter Shelf
HS4LSP77	148	Regard Planter Shelf
HS4LSP83	148	Regard Planter Shelf
HS4LSP88	148	Regard Planter Shelf
HS4P1122	147	Regard Planter
HS4P1133	147	Regard Planter
HS4P1144	147	Regard Planter
HS4P2222	147	Regard Planter
HS4S33G	145	Regard Privacy Screen
HS4S39G	145	Regard Privacy Screen
HS4S44G	145	Regard Privacy Screen
HS4S50G	145	Regard Privacy Screen
HS4S55G	145	Regard Privacy Screen
HS4S61G	145	Regard Privacy Screen
HS4S66G	145	Regard Privacy Screen
HS4S72G	145	Regard Privacy Screen
HS4S77G	145	Regard Privacy Screen
HS4S83G	145	Regard Privacy Screen
HS4S88G	145	Regard Privacy Screen
HS4SA2	145	Regard Screen Brackets and Stanchions
HS4SA4	145	Regard Screen Brackets and Stanchions
HS4T2218L	146	Regard Table
HS4T2218S	146	Regard Table
HS4T2228L	146	Regard Table
HS4T2228S	146	Regard Table
HS4T2618L	146	Regard Table
HS4T2618S	146	Regard Table
HS4TC4481L	152	Regard Booth with Table
HS4TC4481S	152	Regard Booth with Table
HS4TC5581L	152	Regard Booth with Table
HS4TC5581S	152	Regard Booth with Table

Style Number	Page	Description
HS4TL11	144	Regard In-Line Table Arm
HS4VBPH	153	Regard Hardwire Power Infeed
HS4VCC	156	Regard Cable Clamp
HS4VCR	156	Regard Vertical Cable Riser
HS4VH12	155	Regard Modular Harness
HS4VH15	155	Regard Modular Harness
HS4VH18	155	Regard Modular Harness
HS4VH21	155	Regard Modular Harness
HS4VH24	155	Regard Modular Harness
HS4VH27	155	Regard Modular Harness
HS4VH30	155	Regard Modular Harness
HS4VH33	155	Regard Modular Harness
HS4VH36	155	Regard Modular Harness
HS4VH39	155	Regard Modular Harness
HS4VH42	155	Regard Modular Harness
HS4VK1	155	Regard Receptacle Kit
HS4VK2	155	Regard Receptacle Kit
HS4VKD44	153	Regard Power Kit
HS4VKD55	153	Regard Power Kit
HS4VKD61	153	Regard Power Kit
HS4VKD66	153	Regard Power Kit
HS4VKD72	153	Regard Power Kit
HS4VKD77	153	Regard Power Kit
HS4VKD83	153	Regard Power Kit
HS4VKD88	153	Regard Power Kit
HS4VKS	153	Regard Power Kit
HS4VNB	156	Regard Connector
HS4VNL	156	Regard Connector
HS4VPSDC	154	Regard Power Strip
HS4VPSDH	154	Regard Power Strip
HS4VPSFC	154	Regard Power Strip
HS4VPSFH	154	Regard Power Strip
HSBARM	78	Embold Midarm
HSBB32	64	Embold Single Bariatric Seat 32"W
HSBE21	74	Embold Easy Access Seat 21"W
HSBE32	74	Embold Easy Access Seat 32"W
HSBL43	67	Embold Loveseat
HSBLEG	79	Embold Midleg
HSBLEGP	79	Embold Midleg and Support Plate
HSBM66	70	Embold Multiple Seat 66"W
HSBM88	70	Embold Multiple Seat 88"W
HSBM88C	71	Embold Multiple Seat Bariatric 88"W
HSBS21	63	Embold Single Seat 21"W
HSBS24	64	Embold Single Seat 24"W
HSBT20	77	Embold Circular Table
HSBT3219	77	Embold Rounded Rectangle Table
HSBT4220	77	Embold Racetrack Table
HT108LNL	279	Sync Worksurface
HT108LNS	279	Sync Worksurface
HT108LPL	279	Sync Worksurface
HT108LPS	279	Sync Worksurface
HT108NL	281	Sync Worksurface
HT108NS	281	Sync Worksurface
HT108PL	281	Sync Worksurface
HT108PS	281	Sync Worksurface

Style Number	Page	Description	Style Number	Page	Description
HT108UNL	278	Sync Worksurface	HT96UPL	279	Sync Worksurface
HT108UNS	278	Sync Worksurface	HT96UPS	279	Sync Worksurface
HT108UPL	279	Sync Worksurface	HT96UTL	278	Sync Worksurface
HT108UPS	279	Sync Worksurface	HT96UTS	278	Sync Worksurface
HT108UTL	278	Sync Worksurface	HTAX2	395	Extansion Arm
HT108UTS	278	Sync Worksurface	HTC1834RL	381	Mobile Overbed Table with C-Base
HT135FL	283	Sync Full Arc Worksurface	HTC1834RR	381	Mobile Overbed Table with C-Base
HT135FS	283	Sync Full Arc Worksurface	HTCS2	395	Enclosed CPU Holder
HT135SLHL	283	Sync 135° Scoop Worksurface	HTCU2	395	Standard CPU Holder
HT135SLHS	283	Sync 135° Scoop Worksurface	HTM242021P	132	Outlook Freestanding Table
HT135SRHL	283	Sync 135° Scoop Worksurface	HTM242021W	114, 131	Outlook Freestanding Table
HT135SRHS	283	Sync 135° Scoop Worksurface	HTM262616P	132	Outlook Freestanding Table
HT18MAL	241	Opus Bedside Table	HTM262616W	114, 131	Outlook Freestanding Table
HT18MBL	241	Opus Bedside Table	HTM262621P	132	Outlook Freestanding Table
HT4818BCHP	380	Opus Mobile Over-Bed Table	HTM262621W	114, 131	Outlook Freestanding Table
HT72LNL	279	Sync Worksurface	HTRANSU	251	Opus Transformer
HT72LNS	279	Sync Worksurface	HTT181821W	114, 131	Outlook Freestanding Table
HT72LPL	279	Sync Worksurface	HTT242021P	132	Outlook Freestanding Table
HT72LPS	279	Sync Worksurface	HTT242021W	114, 131	Outlook Freestanding Table
HT72NL	281	Sync Worksurface	HTT24R21W	114, 131	Outlook Freestanding Table
HT72NS	281	Sync Worksurface	HTT262621P	132	Outlook Freestanding Table
HT72PL	281	Sync Worksurface	HTT262621W	114, 131	Outlook Freestanding Table
HT72PS	281	Sync Worksurface	HTU1530KR	382	Mobile Overbed Table with U-Base
HT72UNL	278	Sync Worksurface	HTU1530RL	382	Mobile Overbed Table with U-Base
HT72UNS	278	Sync Worksurface	HTU1530RR	382	Mobile Overbed Table with U-Base
HT72UPL	279	Sync Worksurface	HTU1834RR	382	Mobile Overbed Table with U-Base
HT72UPS	279	Sync Worksurface	HTU1834VR	382	Mobile Overbed Table with U-Base
HT72UTL	278	Sync Worksurface	HTW34	394	Relay Arm
HT72UTS	278	Sync Worksurface	HW1548L	245	Opus Common Top
HT84LNL	279	Sync Worksurface	HW1560L	245	Opus Common Top
HT84LNS	279	Sync Worksurface	HW1572L	245	Opus Common Top
HT84LPL	279	Sync Worksurface	HW1584L	245	Opus Common Top
HT84LPS	279	Sync Worksurface	HX3060BCL	399	Exchange 60" Bullet Table
HT84NL	281	Sync Worksurface	HX3060BSL	399	Exchange 60" Bullet Table
HT84NS	281	Sync Worksurface	HX3060CL	399	Exchange 60" Oval Table
HT84PL	281	Sync Worksurface	HX3060SL	399	Exchange 60" Oval Table
HT84PS	281	Sync Worksurface	HX3072BCL	399	Exchange 72" Bullet Table
HT84UNL	278	Sync Worksurface	HX3072BSL	399	Exchange 72" Bullet Table
HT84UNS	278	Sync Worksurface	HX3072CL	399	Exchange 72" Oval Table
HT84UPL	279	Sync Worksurface	HX3072SL	399	Exchange 72" Oval Table
HT84UPS	279	Sync Worksurface	HX30BCL	399	Exchange 30" Bullet Table
HT84UTL	278	Sync Worksurface	HX30BSL	399	Exchange 30" Bullet Table
HT84UTS	278	Sync Worksurface	HX30CL	399	Exchange 30" Round Table
HT90FL	283	Sync Full Arc Worksurface	HX30SL	399	Exchange 30" Round Table
HT90FS	283	Sync Full Arc Worksurface	HXAB3436	325	Folio Mounting Board
HT96LNL	279	Sync Worksurface	HXADL12	325	Folio Plastic Drawer Liner
HT96LNS	279	Sync Worksurface	HXADL18	325	Folio Plastic Drawer Liner
HT96LPL	279	Sync Worksurface	HXADL21	325	Folio Plastic Drawer Liner
HT96LPS	279	Sync Worksurface	HXADL24	325	Folio Plastic Drawer Liner
HT96NL	281	Sync Worksurface	HXADL30	325	Folio Plastic Drawer Liner
HT96NS	281	Sync Worksurface	HXADL36	325	Folio Plastic Drawer Liner
HT96PL	281	Sync Worksurface	HXBC1228	295	Folio 28"H Base Cabinet
HT96PS	281	Sync Worksurface	HXBC1233A	297	Folio 33"H Base Cabinet
HT96UNL	278	Sync Worksurface	HXBC1236	301	Folio 36"H Base Cabinet
HT96UNS	278	Sync Worksurface	HXBC18248	331	Folio Wall-Mounted 24" Base Cabinet

Style Number Index, continued

Style Number	Page	Description
HXBC1828	295	Folio 28"H Base Cabinet
HXBC1833A	297	Folio 33"H Base Cabinet
HXBC1836	301	Folio 36"H Base Cabinet
HXBC2128	295	Folio 28"H Base Cabinet
HXBC2133A	297	Folio 33"H Base Cabinet
HXBC2136	301	Folio 36"H Base Cabinet
HXBC24248	331	Folio Wall-Mounted 24" Base Cabinet
HXBC2428	295	Folio 28"H Base Cabinet
HXBC2433A	297	Folio 33"H Base Cabinet
HXBC2436	301	Folio 36"H Base Cabinet
HXBC3028	295	Folio 28"H Base Cabinet
HXBC3033A	297	Folio 33"H Base Cabinet
HXBC3036	301	Folio 36"H Base Cabinet
HXBC3628	295	Folio 28"H Base Cabinet
HXBC3633A	297	Folio 33"H Base Cabinet
HXBC3636	301	Folio 36"H Base Cabinet
HXBD1228L	294	Folio 28"H Base Cabinet
HXBD1228R	294	Folio 28"H Base Cabinet
HXBD1233AL	296	Folio 33"H Base Cabinet
HXBD1233AR	296	Folio 33"H Base Cabinet
HXBD1236L	300	Folio 36"H Base Cabinet
HXBD1236R	300	Folio 36"H Base Cabinet
HXBD1824L8	331	Folio Wall-Mounted 24"H Base Cabinet
HXBD1824R8	331	Folio Wall-Mounted 24"H Base Cabinet
HXBD1828L	294	Folio 28"H Base Cabinet
HXBD1828R	294	Folio 28"H Base Cabinet
HXBD1833AL	296	Folio 33"H Base Cabinet
HXBD1833AR	296	Folio 33"H Base Cabinet
HXBD1836L	300	Folio 36"H Base Cabinet
HXBD1836R	300	Folio 36"H Base Cabinet
HXBD2128L	294	Folio 28"H Base Cabinet
HXBD2128R	294	Folio 28"H Base Cabinet
HXBD2133AL	296	Folio 33"H Base Cabinet
HXBD2133AR	296	Folio 33"H Base Cabinet
HXBD2136L	300	Folio 36"H Base Cabinet
HXBD2136R	300	Folio 36"H Base Cabinet
HXBD2424L8	331	Folio Wall-Mounted 24"H Base Cabinet
HXBD2424R8	331	Folio Wall-Mounted 24"H Base Cabinet
HXBD2428L	294	Folio 28"H Base Cabinet
HXBD2428R	294	Folio 28"H Base Cabinet
HXBD2433AL	296	Folio 33"H Base Cabinet
HXBD2433AR	296	Folio 33"H Base Cabinet
HXBD2436L	300	Folio 36"H Base Cabinet
HXBD2436R	300	Folio 36"H Base Cabinet
HXBD3028	295	Folio 28"H Base Cabinet
HXBD3033A	297	Folio 33"H Base Cabinet
HXBD3036	301	Folio 36"H Base Cabinet
HXBD36248	331	Folio Wall-Mounted 24"H Base Cabinet
HXBD3628	295	Folio 28"H Base Cabinet
HXBD3633A	297	Folio 33"H Base Cabinet
HXBD3636	301	Folio 36"H Base Cabinet
HXBE28	295	Folio 28"H Support End Panel
HXBE33A	298	Folio 33"H Support End Panel
HXBE36	302	Folio 36"H Support End Panel
HXBF1236	301	Folio 36"H Base Cabinet

Style Number	Page	Description
HXBF1836	301	Folio 36"H Base Cabinet
HXBF2136	301	Folio 36"H Base Cabinet
HXBF2436	301	Folio 36"H Base Cabinet
HXBF3036	301	Folio 36"H Base Cabinet
HXBF3636	301	Folio 36"H Base Cabinet
HXBG1236L	301	Folio 36"H Base Cabinet
HXBG1236R	301	Folio 36"H Base Cabinet
HXBG1836L	301	Folio 36"H Base Cabinet
HXBG1836R	301	Folio 36"H Base Cabinet
HXBG2136L	301	Folio 36"H Base Cabinet
HXBG2136R	301	Folio 36"H Base Cabinet
HXBG2436L	301	Folio 36"H Base Cabinet
HXBG2436R	301	Folio 36"H Base Cabinet
HXBG3036	301	Folio 36"H Base Cabinet
HXBG3636	301	Folio 36"H Base Cabinet
HXBK3622A8	332	Folio Wall-Mounted Sink Cabinet
HXBK3633A	303	Folio Sink Cabinet
HXBK3636	303	Folio Sink Cabinet
HXBKD2424L8	332	Folio Wall-Mounted Sink Cabinet
HXBKD2424R8	332	Folio Wall-Mounted Sink Cabinet
HXBKD2436L	303	Folio Sink Cabinet
HXBKD2436R	303	Folio Sink Cabinet
HXBKD3036	303	Folio Sink Cabinet
HXBKD36248	332	Folio Wall-Mounted Sink Cabinet
HXBKD3636	303	Folio Sink Cabinet
HXBL1233A	298	Folio 33"H Base Cabinet
HXBL1236	302	Folio 36"H Base Cabinet
HXBL1833A	298	Folio 33"H Base Cabinet
HXBL1836	302	Folio 36"H Base Cabinet
HXBL2133A	298	Folio 33"H Base Cabinet
HXBL2136	302	Folio 36"H Base Cabinet
HXBL2433A	298	Folio 33"H Base Cabinet
HXBL2436	302	Folio 36"H Base Cabinet
HXBL3033A	298	Folio 33"H Base Cabinet
HXBL3036	302	Folio 36"H Base Cabinet
HXBL3633A	298	Folio 33"H Base Cabinet
HXBL3636	302	Folio 36"H Base Cabinet
HXBM1228	295	Folio 28"H Base Cabinet
HXBM1233A	297	Folio 33"H Base Cabinet
HXBM18248	331	Folio Wall-Mounted 24"H Base Cabinet
HXBM1828	295	Folio 28"H Base Cabinet
HXBM1833A	297	Folio 33"H Base Cabinet
HXBM2128	295	Folio 28"H Base Cabinet
HXBM2133A	297	Folio 33"H Base Cabinet
HXBM24248	331	Folio Wall-Mounted 24"H Base Cabinet
HXBM2428	295	Folio 28"H Base Cabinet
HXBM2433A	297	Folio 33"H Base Cabinet
HXBM3028	295	Folio 28"H Base Cabinet
HXBM3033A	297	Folio 33"H Base Cabinet
HXBM3628	295	Folio 28"H Base Cabinet
HXBM3633A	297	Folio 33"H Base Cabinet
HXBN1236	302	Folio 36"H Base Cabinet
HXBN1836	302	Folio 36"H Base Cabinet
HXBN2136	302	Folio 36"H Base Cabinet
HXBN2436	302	Folio 36"H Base Cabinet

Style Number	Page	Description	Style Number	Page	Description
HXBN3036	302	Folio 36"H Base Cabinet	HXCBD3084	311	Folio 84"H Bookcase
HXBN3636	302	Folio 36"H Base Cabinet	HXCBD3089S	313	Folio 89"H Bookcase
HXBP1228	294	Folio 28"H Base Cabinet	HXCBD3684	311	Folio 84"H Bookcase
HXBP1233A	296	Folio 33"H Base Cabinet	HXCBD3689S	313	Folio 89"H Bookcase
HXBP1236	300	Folio 36"H Base Cabinet	HXCBP1284	310	Folio 84"H Bookcase
HXBP1828	294	Folio 28"H Base Cabinet	HXCBP1289S	312	Folio 89"H Bookcase
HXBP1833A	296	Folio 33"H Base Cabinet	HXCBP1884	310	Folio 84"H Bookcase
HXBP1836	300	Folio 36"H Base Cabinet	HXCBP1889S	312	Folio 89"H Bookcase
HXBP2128	294	Folio 28"H Base Cabinet	HXCBP2184	310	Folio 84"H Bookcase
HXBP2133A	296	Folio 33"H Base Cabinet	HXCBP2189S	312	Folio 89"H Bookcase
HXBP2136	300	Folio 36"H Base Cabinet	HXCBP24738	335	Folio 73"H Wall-Mounted Bookcases
HXBP2428	294	Folio 28"H Base Cabinet	HXCBP24798	336	Folio 79"H Wall-Mounted Bookcase
HXBP2433A	296	Folio 33"H Base Cabinet	HXCBP2484	310	Folio 84"H Bookcase
HXBP2436	300	Folio 36"H Base Cabinet	HXCBP2489S	312	Folio 89"H Bookcase
HXBP3028	294	Folio 28"H Base Cabinet	HXCBP3084	310	Folio 84"H Bookcase
HXBP3033A	296	Folio 33"H Base Cabinet	HXCBP3089S	312	Folio 89"H Bookcase
HXBP3036	300	Folio 36"H Base Cabinet	HXCBP3684	310	Folio 84"H Bookcase
HXBP3628	294	Folio 28"H Base Cabinet	HXCBP3689S	312	Folio 89"H Bookcase
HXBP3633A	296	Folio 33"H Base Cabinet	HXCBS1214	323	Folio Storage Shelf
HXBP3636	300	Folio 36"H Base Cabinet	HXCBS1814	323	Folio Storage Shelf
HXBR1236	302	Folio 36"H Base Cabinet	HXCBS2114	323	Folio Storage Shelf
HXBR1836	302	Folio 36"H Base Cabinet	HXCBS2414	323	Folio Storage Shelf
HXBR2136	302	Folio 36"H Base Cabinet	HXCBS3014	323	Folio Storage Shelf
HXBR2436	302	Folio 36"H Base Cabinet	HXCBS3614	323	Folio Storage Shelf
HXBR3036	302	Folio 36"H Base Cabinet	HXCD1284L	305	Folio 84"H Storage Cabinet
HXBR3636	302	Folio 36"H Base Cabinet	HXCD1284R	305	Folio 84"H Storage Cabinet
HXBS1224	323	Folio Storage Shelf	HXCD1292LS	307	Folio 92"H Storage Cabinet
HXBS1818	342	Folio Wall-Mounted Storage Shelf	HXCD1292RS	307	Folio 92"H Storage Cabinet
HXBS1824	323	Folio Storage Shelf	HXCD1884L	305	Folio 84"H Storage Cabinet
HXBS2124	323	Folio Storage Shelf	HXCD1884R	305	Folio 84"H Storage Cabinet
HXBS2418	342	Folio Wall-Mounted Storage Shelf	HXCD1892LS	307	Folio 92"H Storage Cabinet
HXBS2424	323	Folio Storage Shelf	HXCD1892RS	307	Folio 92"H Storage Cabinet
HXBS3024	323	Folio Storage Shelf	HXCD2184L	305	Folio 84"H Storage Cabinet
HXBS3618	342	Folio Wall-Mounted Storage Shelf	HXCD2184R	305	Folio 84"H Storage Cabinet
HXBS3624	323	Folio Storage Shelf	HXCD2192LS	307	Folio 92"H Storage Cabinet
HXCBD1284L	311	Folio 84"H Bookcase	HXCD2192RS	307	Folio 92"H Storage Cabinet
HXCBD1284R	311	Folio 84"H Bookcase	HXCD2484L	305	Folio 84"H Storage Cabinet
HXCBD1289LS	313	Folio 89"H Bookcase	HXCD2484R	305	Folio 84"H Storage Cabinet
HXCBD1289RS	313	Folio 89"H Bookcase	HXCD2492LS	307	Folio 92"H Storage Cabinet
HXCBD1884L	311	Folio 84"H Bookcase	HXCD2492RS	307	Folio 92"H Storage Cabinet
HXCBD1884R	311	Folio 84"H Bookcase	HXCD3084	305	Folio 84"H Storage Cabinet
HXCBD1889LS	313	Folio 89"H Bookcase	HXCD3092S	307	Folio 92"H Storage Cabinet
HXCBD1889RS	313	Folio 89"H Bookcase	HXCD3684	305	Folio 84"H Storage Cabinet
HXCBD2184L	311	Folio 84"H Bookcase	HXCD3692S	307	Folio 92"H Storage Cabinet
HXCBD2184R	311	Folio 84"H Bookcase	HXCN1233A	297	Folio 33"H Base Cabinet
HXCBD2189LS	313	Folio 89"H Bookcase	HXCN1833A	297	Folio 33"H Base Cabinet
HXCBD2189RS	313	Folio 89"H Bookcase	HXCN2133A	297	Folio 33"H Base Cabinet
HXCBD2473L8	335	Folio 73"H Wall-Mounted Bookcase	HXCN2433A	297	Folio 33"H Base Cabinet
HXCBD2473R8	335	Folio 73"H Wall-Mounted Bookcase	HXCN3033A	297	Folio 33"H Base Cabinet
HXCBD2479L8S	336	Folio 79"H Wall-Mounted Bookcase	HXCN3633A	297	Folio 33"H Base Cabinet
HXCBD2479R8S	336	Folio 79"H Wall-Mounted Bookcase	HXCP1284	304	Folio 84"H Storage Cabinet
HXCBD2484L	311	Folio 84"H Bookcase	HXCP1292S	306	Folio 92"H Storage Cabinet
HXCBD2484R	311	Folio 84"H Bookcase	HXCP1884	304	Folio 84"H Storage Cabinet
HXCBD2489LS	313	Folio 89"H Bookcase	HXCP1892S	306	Folio 92"H Storage Cabinet
HXCBD2489RS	313	Folio 89"H Bookcase	HXCP2184	304	Folio 84"H Storage Cabinet

Style Number Index, continued

Style Number	Page	Description
HXCP2192S	306	Folio 92"H Storage Cabinet
HXCP2484	304	Folio 84"H Storage Cabinet
HXCP2492S	306	Folio 92"H Storage Cabinet
HXCP3084	304	Folio 84"H Storage Cabinet
HXCP3092S	306	Folio 92"H Storage Cabinet
HXCP3684	304	Folio 84"H Storage Cabinet
HXCP3692S	306	Folio 92"H Storage Cabinet
HXCS1224	323	Folio Storage Shelf
HXCS1824	323	Folio Storage Shelf
HXCS2124	323	Folio Storage Shelf
HXCS2424	323	Folio Storage Shelf
HXCS3024	323	Folio Storage Shelf
HXCS3624	323	Folio Storage Shelf
HXCW1284L	308	Folio 84"H Wardrobe Cabinet
HXCW1284R	308	Folio 84"H Wardrobe Cabinet
HXCW1292LS	309	Folio 92"H Wardrobe Cabinet
HXCW1292RS	309	Folio 92"H Wardrobe Cabinet
HXCW1884L	308	Folio 84"H Wardrobe Cabinet
HXCW1884R	308	Folio 84"H Wardrobe Cabinet
HXCW1892LS	309	Folio 92"H Wardrobe Cabinet
HXCW1892RS	309	Folio 92"H Wardrobe Cabinet
HXCW2184L	308	Folio 84"H Wardrobe Cabinet
HXCW2184R	308	Folio 84"H Wardrobe Cabinet
HXCW2192LS	309	Folio 92"H Wardrobe Cabinet
HXCW2192RS	309	Folio 92"H Wardrobe Cabinet
HXCW2473L8	333	Folio 73"H Wall-Mtn Wardrobe Cab
HXCW2473LD8	333	Folio 73"H Wall-Mtn Wardrobe Cab
HXCW2473R8	333	Folio 73"H Wall-Mtn Wardrobe Cab
HXCW2473RD8	333	Folio 73"H Wall-Mtn Wardrobe Cab
HXCW2479LS8	334	Folio 79"H Wall-Mtn Wardrobe Cab
HXCW2479LSD8	334	Folio 79"H Wall-Mtn Wardrobe Cab
HXCW2479RS8	334	Folio 79"H Wall-Mtn Wardrobe Cab
HXCW2479RSD8	334	Folio 79"H Wall-Mtn Wardrobe Cab
HXCW2484L	308	Folio 84"H Wardrobe Cabinet
HXCW2484R	308	Folio 84"H Wardrobe Cabinet
HXCW2492LS	309	Folio 92"H Wardrobe Cabinet
HXCW2492RS	309	Folio 92"H Wardrobe Cabinet
HXCW3084	308	Folio 84"H Wardrobe Cabinet
HXCW3092S	309	Folio 92"H Wardrobe Cabinet
HXCW3684	308	Folio 84"H Wardrobe Cabinet
HXCW3692S	309	Folio 92"H Wardrobe Cabinet
HXDF1224	322	Folio Desk Frame
HXDF1818	341	Folio Wall-Mounted Desk Frame
HXDF1824	322	Folio Desk Frame
HXDF2418	341	Folio Wall-Mounted Desk Frame
HXDF2424	322	Folio Desk Frame
HXDF3024	322	Folio Desk Frame
HXDF3618	341	Folio Wall-Mounted Desk Frame
HXDF3624	322	Folio Desk Frame
HXDF4218	341	Folio Wall-Mounted Desk Frame
HXDF4224	322	Folio Desk Frame
HXDF4818	341	Folio Wall-Mounted Desk Frame
HXDF4824	322	Folio Desk Frame
HXDF5424	322	Folio Desk Frame
HXDF6018	341	Folio Wall-Mounted Desk Frame

Style Number	Page	Description
HXDF6024	322	Folio Desk Frame
HXDF7218	341	Folio Wall-Mounted Desk Frame
HXDF7224	322	Folio Desk Frame
HXDFB2424	322	Folio Desk Frame
HXDFB3024	322	Folio Desk Frame
HXDFB3624	322	Folio Desk Frame
HXFB624	342	Folio Wall-Mounted Filler
HXFB628	324	Folio Filler
HXFB633	324	Folio Filler
HXFB636	324-325	Folio Filler
HXFCB689	324	Folio Filler
HXFCW679	342	Folio Wall-Mounted Filler
HXFCW692	324	Folio Filler
HXFCWB673	342	Folio Wall-Mounted Filler
HXFCWB684	324	Folio Filler
HXFCWB684S	324	Folio Filler
HXFU624	324	Folio Filler
HXFU629	325	Folio Filler
HXFU630	324	Folio Filler
HXFU635	325	Folio Filler
HXUD1224L	315	Folio Upper Storage Cabinet
HXUD1224R	315	Folio Upper Storage Cabinet
HXUD1229LS	317	Folio Upper Storage Cabinet
HXUD1229RS	317	Folio Upper Storage Cabinet
HXUD1230L	315	Folio Upper Storage Cabinet
HXUD1230R	315	Folio Upper Storage Cabinet
HXUD1235LS	317	Folio Upper Storage Cabinet
HXUD1235RS	317	Folio Upper Storage Cabinet
HXUD1824L	315	Folio Upper Storage Cabinet
HXUD1824R	315	Folio Upper Storage Cabinet
HXUD1829LS	317	Folio Upper Storage Cabinet
HXUD1829RS	317	Folio Upper Storage Cabinet
HXUD1830L	315	Folio Upper Storage Cabinet
HXUD1830R	315	Folio Upper Storage Cabinet
HXUD1835LS	317	Folio Upper Storage Cabinet
HXUD1835RS	317	Folio Upper Storage Cabinet
HXUD2124L	315	Folio Upper Storage Cabinet
HXUD2124R	315	Folio Upper Storage Cabinet
HXUD2129LS	317	Folio Upper Storage Cabinet
HXUD2129RS	317	Folio Upper Storage Cabinet
HXUD2130L	315	Folio Upper Storage Cabinet
HXUD2130R	315	Folio Upper Storage Cabinet
HXUD2135LS	317	Folio Upper Storage Cabinet
HXUD2135RS	317	Folio Upper Storage Cabinet
HXUD2424	315	Folio Upper Storage Cabinet
HXUD2429S	317	Folio Upper Storage Cabinet
HXUD2430	315	Folio Upper Storage Cabinet
HXUD2435S	317	Folio Upper Storage Cabinet
HXUD3024	315	Folio Upper Storage Cabinet
HXUD3029S	317	Folio Upper Storage Cabinet
HXUD3030	315	Folio Upper Storage Cabinet
HXUD3035S	317	Folio Upper Storage Cabinet
HXUD3624	315	Folio Upper Storage Cabinet
HXUD3629S	317	Folio Upper Storage Cabinet
HXUD3630	315	Folio Upper Storage Cabinet

Style Number	Page	Description	Style Number	Page	Description
HXUD3635S	317	Folio Upper Storage Cabinet	HXW12024L	318	Folio Worksurface
HXUDP1230L	315	Folio Upper Storage Cabinet	HXW12024S	320	Folio Worksurface
HXUDP1230R	315	Folio Upper Storage Cabinet	HXW1224L	318	Folio Worksurface
HXUDP1235LS	317	Folio Upper Storage Cabinet	HXW1224S	320	Folio Worksurface
HXUDP1235RS	317	Folio Upper Storage Cabinet	HXW1818L	337	Folio Laminate Wall-Mounted Wrfs
HXUDP1830L	315	Folio Upper Storage Cabinet	HXW1818S	339	Folio Wall-Mounted Solid Surface Wrfs
HXUDP1830R	315	Folio Upper Storage Cabinet	HXW1824L	318	Folio Worksurface
HXUDP1835LS	317	Folio Upper Storage Cabinet	HXW1824S	320	Folio Worksurface
HXUDP1835RS	317	Folio Upper Storage Cabinet	HXW2124L	318	Folio Worksurface
HXUDP2130L	315	Folio Upper Storage Cabinet	HXW2124S	320	Folio Worksurface
HXUDP2130R	315	Folio Upper Storage Cabinet	HXW2418L	337	Folio Laminate Wall-Mounted Wrfs
HXUDP2135LS	317	Folio Upper Storage Cabinet	HXW2418S	339	Folio Wall-Mounted Solid Surface Wrfs
HXUDP2135RS	317	Folio Upper Storage Cabinet	HXW2424L	318	Folio Worksurface
HXUDP2430	315	Folio Upper Storage Cabinet	HXW2424S	320	Folio Worksurface
HXUDP2435S	317	Folio Upper Storage Cabinet	HXW2724L	318	Folio Worksurface
HXUDP3030	315	Folio Upper Storage Cabinet	HXW2724S	320	Folio Worksurface
HXUDP3035S	317	Folio Upper Storage Cabinet	HXW3024L	318	Folio Worksurface
HXUDP3630	315	Folio Upper Storage Cabinet	HXW3024S	320	Folio Worksurface
HXUDP3635S	317	Folio Upper Storage Cabinet	HXW3324L	318	Folio Worksurface
HXUP1224	314	Folio Upper Storage Cabinet	HXW3324S	320	Folio Worksurface
HXUP1229S	316	Folio Upper Storage Cabinet	HXW3618L	337	Folio Laminate Wall-Mounted Wrfs
HXUP1230	314	Folio Upper Storage Cabinet	HXW3618S	339	Folio Wall-Mounted Solid Surface Wrfs
HXUP1235S	316	Folio Upper Storage Cabinet	HXW3624L	318	Folio Worksurface
HXUP1824	314	Folio Upper Storage Cabinet	HXW3624S	320	Folio Worksurface
HXUP1829S	316	Folio Upper Storage Cabinet	HXW3924L	318	Folio Worksurface
HXUP1830	314	Folio Upper Storage Cabinet	HXW3924S	320	Folio Worksurface
HXUP1835S	316	Folio Upper Storage Cabinet	HXW4218L	337	Folio Laminate Wall-Mounted Wrfs
HXUP2124	314	Folio Upper Storage Cabinet	HXW4218S	339	Folio Wall-Mounted Solid Surface Wrfs
HXUP2129S	316	Folio Upper Storage Cabinet	HXW4224L	318	Folio Worksurface
HXUP2130	314	Folio Upper Storage Cabinet	HXW4224S	320	Folio Worksurface
HXUP2135S	316	Folio Upper Storage Cabinet	HXW4524L	318	Folio Worksurface
HXUP2424	314	Folio Upper Storage Cabinet	HXW4524S	320	Folio Worksurface
HXUP2429S	316	Folio Upper Storage Cabinet	HXW4818L	337	Folio Laminate Wall-Mounted Wrfs
HXUP2430	314	Folio Upper Storage Cabinet	HXW4818S	339	Folio Wall-Mounted Solid Surface Wrfs
HXUP2435S	316	Folio Upper Storage Cabinet	HXW4824L	318	Folio Worksurface
HXUP3024	314	Folio Upper Storage Cabinet	HXW4824S	320	Folio Worksurface
HXUP3029S	316	Folio Upper Storage Cabinet	HXW5124L	318	Folio Worksurface
HXUP3030	314	Folio Upper Storage Cabinet	HXW5124S	320	Folio Worksurface
HXUP3035S	316	Folio Upper Storage Cabinet	HXW5424L	318	Folio Worksurface
HXUP3624	314	Folio Upper Storage Cabinet	HXW5424S	320	Folio Worksurface
HXUP3629S	316	Folio Upper Storage Cabinet	HXW6018L	337	Folio Laminate Wall-Mounted Wrfs
HXUP3630	314	Folio Upper Storage Cabinet	HXW6018S	339	Folio Wall-Mounted Solid Surface Wrfs
HXUP3635S	316	Folio Upper Storage Cabinet	HXW6024L	318	Folio Worksurface
HXUS1214	323	Folio Storage Shelf	HXW6024S	320	Folio Worksurface
HXUS1814	323	Folio Storage Shelf	HXW6624L	318	Folio Worksurface
HXUS2114	323	Folio Storage Shelf	HXW6624S	320	Folio Worksurface
HXUS2414	323	Folio Storage Shelf	HXW7218L	337	Folio Laminate Wall-Mounted Wrfs
HXUS3014	323	Folio Storage Shelf	HXW7218S	339	Folio Wall-Mounted Solid Surface Wrfs
HXUS3614	323	Folio Storage Shelf	HXW7224L	318	Folio Worksurface
HXW10224L	318	Folio Worksurface	HXW7224S	320	Folio Worksurface
HXW10224S	320	Folio Worksurface	HXW7824L	318	Folio Worksurface
HXW10824L	318	Folio Worksurface	HXW7824S	320	Folio Worksurface
HXW10824S	320	Folio Worksurface	HXW8424L	318	Folio Worksurface
HXW11424L	318	Folio Worksurface	HXW8424S	320	Folio Worksurface
HXW11424S	320	Folio Worksurface	HXW9024L	318	Folio Worksurface

Style Number Index, continued

Style Number	Page	Description	Style Number	Page	Description
HXW9024S	320	Folio Worksurface	SC2565	110	Outlook Bariatric Seating
HXW9624L	318	Folio Worksurface	SC2583	111	Outlook High-Back Patient Chair
HXW9624S	320	Folio Worksurface	SC2585	111	Outlook High-Back Patient Chair
HXWS416L	338	Folio 4"H Lam. Wall-Mounted Sidesplash	SC2586	111	Outlook High-Back Patient Chair
HXWS416LS	340	Folio 4"H Solid Surface Sidesplash	SC2595	112	Outlook Bariatric High-Bck Patient Chr
HXWS416RS	340	Folio 4"H Solid Surface Sidesplash	SC27DT18D	133	Freestanding and Interconnecting Tbl
HXWS418L	338	Folio 4"H Lam. Wall-Mounted Sidesplash	SC27DT24D	133	Freestanding and Interconnecting Tbl
HXWS418LS	340	Folio 4"H Solid Surface Sidesplash	SC4007	55	Aspekt Easy Access Arm Chair
HXWS418RS	340	Folio 4"H Solid Surface Sidesplash	SC4009	38-41, 48-51	Aspekt Set Ganging Brackets
HXWS421L	319	Folio Worksurface	SC4010	48	Aspekt Single-Seat Chair
HXWS421LS	321	Folio Sidesplash	SC4020	49	Aspekt Two-Seat Chair
HXWS421RS	321	Folio Sidesplash	SC4030	50	Aspekt Three-Seat Chair
HXWS424L	319	Folio Worksurface	SC4043	46, 56	Aspekt Bench
HXWS424LS	321	Folio Sideplash	SC4045	47, 57	Aspekt Footstool
HXWS424RS	321	Folio Sideplash	SC4050	58	Aspekt Ganging Table
LOCK9201FR	441	Lock Cylinder	SC4051L	58	Aspekt Ganging Table
LOCK9201XF	441	Lock Cylinder	SC4051R	58	Aspekt Ganging Table
MSKEYW	388	Davenport Accessory	SC4053	58	Aspekt Ganging Table
S-1721-A-GR-KIT	326	Stainless Steel Sink	SC4054	58	Aspekt Ganging Table
S-ADA-1721-A-GR-KIT	326	Stainless Steel Sink	SC4055	59	Aspekt FS Table
SC1060D	165	Stackable Sorrel Dolly Cart	SC4057	59	Aspekt FS Table
SC1060SA	159	Sorrel 18"W Stacking Chair	SC4058	59	Aspekt FS Table
SC1060SN	158	Sorrel 18"W Stacking Chair	SC4060	51	Aspekt Bariatric Arm Chair
SC10621818	166	Sorrel Table	SC4062	52	Aspekt Bariatric Wave Arm Chair
SC1062SA	161	Sorrel 22"W Stacking Chair	SC4063	53	Aspekt Bariatric Wave Arm Chair
SC1062SN	161	Sorrel 22"W Stacking Chair	SC4085	54	Aspekt High-Back Chair
SC1065D	165	Stackable Sorrel Dolly Cart	SC4207	45	Aspekt Easy Access Arm Chair
SC1065SA	162	Sorrel Bariatric Stacking Chair	SC4210	38	Aspekt Single-Seat Chair
SC1067EA	163	Sorrel 18"W Easy Access Chair	SC4220	39	Aspekt Two-Seat Chair
SC1069EA	164	Sorrel 22"W Easy Access Chairs	SC4230	40	Aspekt Three-Seat Chair
SC1080	159, 161-164	Pair Ganging Brackets	SC4260	41	Aspekt Bariatric Arm Chair
SC2091	171	Mineral Recliner	SC4262	42	Aspekt Bariatric Straight Arm Chair
SC2091L	171	Mineral Recliner	SC4263	43	Aspekt Bariatric Straight Arm Chair
SC2091R	171	Mineral Recliner	SC4285	44	Aspekt High-Back Chair
SC2207	105	Outlook Easy Access Chair	SC6010A	83	Mitra Guest Seating
SC2210	98	Outlook Single-Seat Chair	SC6026A	83	Mitra Guest Seating
SC2210W	99	Outlook Single-Seat Chair	SC6036A	83	Mitra Guest Seating
SC2220	100	Outlook Two-Seat Chair	SC6046A	84	Mitra Bariatric Seating
SC2223	100	Outlook Two-Seat Chair	SC6055	88	Mitra FS Table
SC2230	101	Outlook Three-Seat Chair	SC6056	88	Mitra FS Table
SC2233	101	Outlook Three-Seat Chair	SC6057	88	Mitra FS Table
SC2260	102	Outlook Bariatric Seating	SC6058	88	Mitra FS Table
SC2265	102	Outlook Bariatric Seating	SC6060A	84	Mitra Bariatric Seating
SC2283	103	Outlook High-Back Patient Chair	SC6067EA	86	Mitra Easy Access Chair
SC2285	103	Outlook High-Back Patient Chair	SC6085A	85	Mitra High-Back Chair
SC2286	103	Outlook High-Back Patient Chair	SC6091	172	Mitra Recliner
SC2295	104	Outlook Bariatric High-Bck Patient Chr	SC6091T	172	Mitra Recliner with Trendelenburg
SC2507	113	Outlook Easy Access Chair	SC6110L	87	Mitra Lounge Chair
SC2510	106	Outlook Single-Seat Chair	SC6120L	87	Mitra Lounge Chair
SC2510W	107	Outlook Single-Seat Chair	SC6130L	87	Mitra Lounge Chair
SC2520	108	Outlook Two-Seat Chair	SC6140S	173	Mitra Sleeper Chair
SC2523	108	Outlook Two-Seat Chair	SC6155	89	Mitra Freestanding Table
SC2530	109	Outlook Three-Seat Chair	SC6156	89	Mitra Freestanding Table
SC2533	109	Outlook Three-Seat Chair	SC6157	89	Mitra Freestanding Table
SC2560	110	Outlook Bariatric Seating	SC6158	89	Mitra Freestanding Table

Style Number	Page	Description
SC8141L	220	X-tenz Sleeper Chair
SC8141LC	220	X-tenz Sleeper Chair
SC8141R	220	X-tenz Sleeper Chair
SC8141RC	220	X-tenz Sleeper Chair
SC8241	221	X-tenz Sleeper Chair
SX-1717-A-GR-KIT	326	Stainless Steel Sink
SX-1719-A-GR-KIT	326	Stainless Steel Sink
US-1620-A-KIT	326	Stainless Steel Sink
US-ADA-1620-A-KIT	326	Stainless Steel Sink
USX-1616-A-KIT	326	Stainless Steel Sink
USX-1618-A-KIT	326	Stainless Steel Sink

Trademark List

- ® The following are registered trademarks for products of Steelcase Inc. or one of its related corporate entities: 4 o'clock, 900 Series, à la carte, Airtouch, Ally, Amia, Answer, Archipelago, Avenir, Ballet, Bix, Brayton International, Cachet, Canopy, Canto, Chancellor, Coalesse, Confidante, Context, Convene, CopyCam, Criterion, Crushed Can, Currency, dash, Designtex, Details, Detour, Drive, Elective Elements, Ellipse, Ember Chrome, Emerge, E-Table 2, FYI, Garland, Gentry, Ginkgo Biloba, Groupwork, Ideo, Jacket, Jenny, Jersey, Kart, Kick, LaCosta, Leap, Let's B, LiveBack, Max-Stacker, media:scape, Metro, Migrations, Mitra, Montage, Nurture, Oriana, Parade, Pathways, PCT, Permiso, Player, Portal, Power Pincher, Progeny, Protégé, R2, Rally, Relevant, Reply, Rizzi Arc, Sensor, Series 9000, Siento, Sieste, Sine, Softcare, Springboard, Steelcase, Steelcase Design Partnership, Stella, Stow Davis, Swathmore, Sylvi, TeamWork, Technique, Texpress, Think, Thunder, Topo, Train, turnstone, Underline, Unison, Vecta, Viridian, Walden, Werndl, and X-Stack.
- ® The following registered trademarks are under license from AWI Licensing Company, Dover, DE: SoundScapes, DuraBrite, BioBlock, and Armstrong.
- ® The following registered trademarks are under license from Byrne Electrical, Rockford, MI: Interport, Mini-Port, Axil Z, and Ellora.
- ® The following is a registered trademark of DuPont, Wilmington, DE: Corian.
- ® The following is a registered trademark of Genlyte Thomas Company, Louisville, KY: Lightolier.
- ® The following is a registered trademark of Hilti Corporation, FL-9494 Schaan, Principality of Liechtenstein: Hilti.
- ® The following is a registered trademark of Leviton Manufacturing Company, Little Neck, NY: Decora.
- ® The following is a registered trademark of Mechanical Plastics Corp, Elmsford, NY: Toggler.
- ® The following is a registered trademark of Microsoft Corporation, Redmond, WA: Microsoft.
- ® The following is a registered trademark of Panduit Corporation, Lockport, IL: Panduit.
- ® The following is a registered trademark of Trav (Press), Cuneo, Italy: Assisa.
- ® The following is a registered trademark of Virtual Ink, Boston, MA: mimioActive.
- ® The following registered trademarks are under license from Wilkhahn Furniture Products: Avera, Senzo, Versal, and Wilkhahn FS.

- ® The following is a registered trademark of Wilsonart International, Temple, TX: Chemsurf.
- ® The following is a registered trademark of Wiremold, West Hartford, CT: Wiremold.
- ® The following is a registered trademark of EMU Group S.P.A., Perugia, Italy: Emu.
- ® The following is a registered trademark of Security People, Inc.: Digilock.
- ™ The following are trademarks for products of Steelcase Inc. or one of its related corporate entities: Access, Active/Passive Shelf, Ainsley, Akira, Alcove, Alerion, Alight, Amaris, American Elect, American Tradition, ap40, Arbor, Arriva, Asana, Ascot, Aspekt, Astor, Await, Bassline, B-Free, Bira, Bivi, Bixby, Bottomline, Brody, Brook, Buoy, Burton, c:scape, Calla, Calm, Camber, Campfire, Capa, Cappuccino, Cesar, Chester, Chord, Circa, Clarendon, Classic Rectangular, Clipper, cobì, Collaboration, Community, Company, Convey, Cortex, Coupe, Crea, Crew, Cura, Cypress, Davenport, Dearborn, Deck, Déjà, Denizen, Denska, Derby, Divisio, Donovan, Dune, Duo, Echo, Edge, Elsna, Empath, Empress, Enea, ēno, EnSync, Enviro, Escapade, Exchange, Exponents, Field, Flat Top, FlexFrame, Flip Top, Flute, Folio, FrameOne, FreeFlow, Frontier, Galliei, Gesture, Ginger, Ginkgo, Go Wall, Grip, Groove, Hatchback, Hawthorne, Hitch, Host Collection, Hosu, Huddleboard, i2i, Impact, Indy, InfoLink, IOS, I-Solve, Jack, Jarrah, Jetty, Juice, Kami, Kast, Kathryn, Lagunitas, Lark, L'Attitude, LearnLab, Leela, LessThanFive, Lincoln, Linden, LiveSeat, Loria, Lyric, Malibu, Malibu Too, Mansfield, Marathon, Martini, Mason, Masque, Migration, Millbrae, Mineral, Mingle, Mystic, Mystic Metal, Mystic Wood, Montara650, Montreal, Move, Nadia, Neighbor, nesso, Nickel, Nikko, Nod, Node, Norfolk, Ology, Ontrak, Oom, Opus, Orchid, Outlook Collection, Ovation, Paloma, Paperflo, Parliament, Pasio, Passerelle, Patriarch, Payback, Peek, Pile File, Pisa, Pool, Potrero415, PUCK, QiVi, Quba, Rave, Reed, Regard, Relay, Reunion, Ripple, Riser, Roam, Rocco, Rocky, RoomWizard, Runner, Satellite, Sawyer, ScapeSeries, Senti, Sentinel, Senza, Sequoia, Session, ShareLink, Shield, Shortcut, Sidewalk, SILQ, Skylar, Slumber, Smoke, Snug, Soft Leaf, Sonata, Sorrel, SOTO, Southside, Stationkits, Steelcase Series, Stiletto, Surprise!, Surround, Switch, Symphony, Sync, TagWizard, Tava, TeamStudio, TeamTheater, Tenaro, Terrazzo, Theorem, Thread, Topaz, Touchdown, Tour, Tower Too, Trees, Trillium, Trolley, tX2, U-Free, Umami, Underscore, Uno, V.I.A., Verb, Verge, Verlay, Victor2, Visalia, Waldorf, Woodruff, Workspring, and X-tenz.
- ™ The following is a trademark of Microsoft Corporation, Redmond, WA: Windows.
- ™ The following is a trademark of Rodman Industries, Inc., Oconomowoc, WI: ResinCore1.
- ™ The following is a trademark of Ultrafabrics, LLC, Elmsford, NY: Ultraleather.

- ™ The following trademarks are under license from Wilkhahn Furniture products: Cana, Linus, Logon, Picto, Range, Stitz, Thema, Timetable, and Tubis.
- ™ The following trademark is used under license from Cradle to Cradle Products Innovation Institute, Oakland, CA: Cradle to Cradle Certified.
- ™ The following trademarks are under license from Walter Knoll: Andoo, Bob, Lazlo, Lox, Ribbon, and Together.
- ™ The following trademarks are under license from PP Möbler: Bar and Flag Halyard.
- ™ The following trademarks are under license from Viccarbe: Davos, Holy Day, Last Minute, RS, Sistema, and Wrapp.
- ™ The following trademarks are under license from Carl Hansen: Elbow, Paddle, Shell, Wing, and Wishbone.
- ™ The following trademarks are under license from Cambridge Sound Management, LLC, Cambridge, MA: QtPro Soundmasking, Qt Quiet Technology, and Sonet Qt.
- ™ The following is a trademark of Electri-Cable Assemblies, Shelton, CT: Interact.
- ™ The following is a trademark of Clestra Hauserman: IRYS.
- ™ The following is a trademark of Wiesner-Hager Möbel GmbH: Nooi.
- ™ The following are trademarks of PolyVision: a³, e³, Flow, Motif, PolyVision, Sans, and Serif.
- ™ The following is a trademark of Bostock Company, Inc: SnapCab.
- ™ The following is a trademark of Williams-Sonoma, Inc: West Elm.
- ™ The following is a trademark of Elena Marquina Testor: nanimarquina.
- ™ The following is a trademark of Forbo International SA: Forbo.

Trademarks used here in are the property of Steelcase, Inc. or of their respective owners.