Coalesse Training/ Multipurpose Tables, Conferencing, and Storage

Volume 5b

Terms and Conditions	2
Sample Order Form	10
Participating Steelcase Dealers	12
Steelcase Showrooms and Manufacturing Locations	17

Coalesse	
Power and Data Access	19
Training/Multipurpose/Café Tables	31
Conference Tables	111
Storage/Ancillary	321

Surface Materials	349
Resources	389

► For a list of all trademarks, refer to the last page of this specification guide.

Terms and Conditions

Customer Information

For more information, please contact your participating Steelcase GSA dealer.

For more information, please contact your participating Steelcase GSA dealer.

For more information, please contact your participating Steelcase GSA dealer.

For more information, please contact your participating Steelcase GSA dealer.

For more information, please contact your participating Steelcase GSA dealer.

For more information, please contact your participating Steelcase GSA dealer.

For more information, please contact your participating Steelcase GSA dealer.

For more information, please contact your participating Steelcase GSA dealer.

Sample Order Form

Sample Order Form

ORDER FOR SUPPLIES OR SERVICES				PAGE	OF	PAGES
IMPORTANT: Mark all packages and papers with contract and/or order numbers.						
DATE OF ORDER 1 6-1-04	CONTRACT NO. (If any) 2 GS-27F-0014V	ORDER NO. 3 10 - 000	REQUISITION/REFERENCE NO.			
ISSUING OFFICE (Address correspondence to) 4 GSA 1 Town Street City, State, Zip Name and Telephone Number			SHIP TO: (Consignee and address, ZIP Code) 5 GSA 2 Town Street City, State, Zip Name and Telephone Number			
TO: CONTRACTOR (Name, address and ZIP Code) 6 Steelcase Inc. c/o Participating Dealer 901 44th Street, SE Grand Rapids, MI 49508 Attn: Solutions Fullfillment Team CH-2W-SS (GSA)			Cage Code: 39880		TYPE OF ORDER <input type="checkbox"/> A. PURCHASE — Reference your _____ Please furnish the following on the terms and conditions specified on both sides of this order and on the attached sheets, if any, including delivery as indicated. This purchase is negotiated under authority of: <input type="checkbox"/> B. DELIVERY — Except for billing instructions on the reverse, this delivery order is subject to instructions contained on this side only of this form and is issued subject to the terms and conditions of the above-numbered contract.	
ACCOUNTING AND APPROPRIATION DATA			REQUISITIONING OFFICE			
			BUSINESS CLASSIFICATION (Check appropriate box(es)) 20 <input type="checkbox"/> SMALL <input checked="" type="checkbox"/> OTHER THAN SMALL <input type="checkbox"/> DIS-ADVAN-TAGED <input type="checkbox"/> WOMEN-OWNED			
FCA DESTINATION 7		GOVERNMENT NO.	DELIVER TO FCA DESTINATION ON OR BEFORE (Date) 8 ARO date		DISCOUNT TERMS 9 Net 30 days	
PLACE OF INSPECTION AND ACCEPTANCE						

(See reverse for Rejections)

ITEM NO. (A)	SUPPLIES OR SERVICES (B)	QUANTITY ORDERED (C)	UNIT (D)	UNIT PRICE (E)	AMOUNT (F)	QUANTITY ACCEPTED (G)	
1	10 One lot of Steelcase Office Furniture: See attached specifications	13 1		14 \$000	15 \$000		
2	11 Design: \$55.41/hour	2 hrs		\$000	\$000		
3	12 Installation	1		\$000	\$000		
SEE BILLING INSTRUCTIONS ON REVERSE		SHIPPING POINT		GROSS SHIPPING WEIGHT		INVOICE NO.	
		MAIL INVOICE TO: (Include ZIP Code) 17 GSA, 3 Town Street, City, State, Zip				16 \$000	(H) TOT. (Cont. pages) ◀ (I) GRAND TOTAL ◀
UNITED STATES OF AMERICA BY (Signature) 18 Contracting Officer signature and telephone no.				NAME (Typed) 19 John Doe, Department Manager TITLE: CONTRACTING/ORDERING OFFICER			

NSN 7540_01_152_8083

50347-101

OPTIONAL FORM 347 (10-83)
Prescribed by GSA
FAR (48 CFR) 53.213 (e)

- 1 Order date
- 2 Contract number
- 3 Order number
- 4 Issuing office: Requester name and telephone number
- 5 Shipping address: Contact name and telephone number
- 6 Contractor:
Steelcase Inc.
c/o Participating Dealer
901 - 44th Street, S.E.
Grand Rapids, MI 49508
Attn: Solutions Fulfillment Team
- 7 FCA destination
- 8 ARO date (After Receipt of Order)
- 9 Terms: Net 30 days
- 10 Complete product description, including SIN number, style number, all applicable surface materials.
- 11 Separate line for design
- 12 Separate line for installation
- 13 Quantity ordered
- 14 Individual unit price
- 15 Amount (quantity x unit price)
- 16 Total cost
- 17 Invoice address
- 18 Authorized contracting officer signature and telephone number
- 19 Authorized contracting officer name and title (typed)
- 20 Steelcase is the seller of record and is not registered as "small," "disadvantaged," or "woman-owned." If one of these boxes is checked in error, a modification will be required.

Please note on order that all invoice payments must be sent to:

Steelcase Inc.
62087 Collection Center Dr.
Chicago, IL 60693-0620

Storage and Delays

(Open Market) In the event that the site is not accessible, or safe and adequate storage space is not available during installation, the furnishings will be stored until delivery or installation can be accomplished. Pricing for storage will be negotiated on a project-by-project basis. Invoices will be sent to the local government purchasing facility upon delivery of the furniture to a designated storage facility. Steelcase shall provide notice to the Government purchasing facility that the furnishings are available for inspection by the Government at the Storage facility. Upon this notice, the Government, or representative for the Government, must inspect and accept the furniture prior to payment of any invoice. The inspection and acceptance must be completed within reasonable time frame agreed upon by both parties. Payment will be made by the Government 30 days after acceptance of the furniture.

Participating Steelcase Dealers

Alabama

Dekalb Office of Alabama
2901 Second Ave South
Birmingham, AL 35233
Phone: (205) 933-9100

Kyser OfficeWorks Inc.
2400 Spruce Street
Montgomery, AL 36107-3150
Phone: (334) 834-9400
Fax: (334) 262-0701

OEC Business Interiors
104 East I-65 Service Road North
Mobile, AL 36607-2501
Phone: (251) 471-3368
Fax: (251) 471-0019

Office Interiors by OSCO
1300 Meridian Street
Suite 203
Huntsville, AL 35801
Phone: (256) 604-5696
Fax: (256) 604-5699

OSCO Inc.
229 Grant Street SE
Decatur, AL 35601-2511
Phone: (256) 340-5100
Fax: (256) 340-5108

Alaska

Capital Office Systems
1120 East 35th Avenue
Anchorage, AK 99508-4257
Phone: (907) 777-1500
Fax: (907) 777-1515

Capital Office Systems
3201 Industrial Avenue
Fairbanks, AK 99701-7370
Phone: (907) 456-3946
Fax: (907) 452-6257

Capital Office Systems
3143 Channel Drive
Juneau, AK 99801-7214
Phone: (907) 780-3636
Fax: (907) 780-2290

Arizona

Atmosphere Commercial Interiors
815 North Central Avenue
Phoenix, AZ 85004
Phone: (602) 252-6971

Atmosphere Commercial Interiors
Suite 100
88 East Broadway Boulevard
Tucson, Arizona 85701-1720
Phone: (520) 792-4200

Atmosphere Commercial Interiors
Suite 100
88 East Broadway Boulevard
Tucson, Arizona 85701-1720
Phone: (520) 792-4200
Fax: (540) 791-9568

Arkansas

ImageWorks
Suite B
1424 North Shackelford
Little Rock, AR 72211
Phone: (501) 944-7501

Today's Office Inc.
717 West 7th Street
Little Rock, AR 72201-4044
Phone: (501) 375-5050
Fax: (501) 375-1350

Today's Office Inc.
3157 West Sunset Avenue
Springdale, AR 72762-4945
Phone: (479) 751-5861
Fax: (479) 756-2233

California

BKM Office Environments
816 Via Alondra
Camarillo, CA 93012
Phone: (877) 256-1256
Fax: (805) 339-9032

BKM San Diego
Suite 100
9201 Spectrum Center Blvd.
San Diego, CA 92123-1407
Phone: (858) 569-4700
Fax: (858) 277-8931

One Workplace L. Ferrari
2500 De La Cruz Blvd.
Santa Clara, CA 95050
Phone: (669) 800-2500
Fax: (669) 800-2501

One Workplace L. Ferrari
7220 Edgewater Drive
Oakland, CA 94621
Phone: (510) 729-7800
Fax: (510) 729-7801

One Workplace L. Ferrari
475 Brannan Street
San Francisco, CA 94107-1731
Phone: (415) 357-2200
Fax: (415) 357-2201

Peninsula Business Interiors
325 Main Street
Salinas, CA 93901-2705
Phone: (831) 757-4107
Fax: (831) 757-1339

Tangram Interiors
Suite 102
4057 W Shaw Ave
Fresno, CA 93722-6212
Phone: (559) 275-7070
Fax: (559) 275-7080

Tangram Interiors
Suite 100
2850 South Red Hill Avenue
Santa Ana, CA 92705-5532
Phone: (949) 955-6700
Fax: (949) 955-6799

Tangram Interiors
9200 Sorensen Avenue
Santa Fe Springs, CA 90670-2645
Phone: (562) 365-5000
Fax: (562) 365-5399

United Corporate Furnishings
1780 North Market Blvd.
Sacramento, CA 95834-1997
Phone: (916) 553-5900
Fax: (916) 553-5800

Colorado

Office Outfitters & Planners Inc.
749 Main Street
Grand Junction, CO 81501-3535
Phone: (970) 245-6300
Fax: (970) 245-6301

OfficeScapes
2506 Zeppelin Rd
Colorado Springs, CO 80916
Phone: (719) 574-1113
Fax: (719) 574-1133

OfficeScapes
9900 East 51st Avenue
Denver, CO 80238-2430
Phone: (303) 574-1115
Fax: (303) 574-1116

OfficeScapes
Suite 180
4812 McMurry Avenue
Fort Collins, CO 80525-6222
Phone: (970) 223-5959
Fax: (970) 223-5858

Connecticut

Red Thread
300 East River Drive
East Hartford, CT 06108-4205
Phone: (860) 528-9981
Fax: (860) 528-1843

Red Thread
488 Wheelers Farm Rd.
Milford, CT 06461
Phone: (203) 874-7754
Fax: (203) 876-7915

Red Thread
700 Canal St 3rd Fl
Stamford, CT 06902
Phone: (860) 528-9981

Red Thread
40 Main Street
Torrington, CT 06790
Phone: (860) 482-2679
Fax: (860) 482-3590

Delaware

Corporate Interiors Inc.
223 Lisa Drive
New Castle, DE 19720-4193
Phone: (302) 323-9100
Fax: (302) 323-9251

Florida

American Business Interiors
215 Waverly Place
Melbourne, FL 32901-5444
Phone: (321) 723-5003
Fax: (321) 984-4221

Empire Office
Suite 140
2 Oakwood Boulevard
Hollywood, FL 33020
Phone: (954) 707-6200

Empire Office
South Florida
3201 Commerce Parkway
Miramar, FL 33025-3908
Phone: (954) 435-7300
Fax: (954) 435-7212

Empire Office
Suite 17
2315 Lynx Lane
Orlando, FL 32804
Phone: (407) 628-2400

Empire Office
5112 West Linebaugh Avenue
Tampa, FL 33624
Phone: (813) 418-3300

Empire Office
Suite 2
7830 Byron Drive
West Palm Beach, FL 33404-3332
Phone: (561) 840-8600
Fax: (561) 840-1873

Leitz & Reed Office Products
1119 Florida Avenue
Lynn Haven, FL 32444-4622
Phone: (850) 271-2600
Fax: (850) 271-0076

OEC Business Interiors
1601 NW 80th Boulevard
Gainesville, FL 32606-9140
Phone: (352) 332-1192
Fax: (352) 333-8002

· OEC Business Interiors
· 2393 SW College Road
· Ocala, FL 34474-1661
· Phone: (352) 620-2888
· Fax: (352) 620-2891

· OEC Business Interiors
· 6254 North W Street
· Pensacola, FL 32503-2746
· Phone: (850) 438-1100
· Fax: (850) 432-0003

· Office Furniture & Design Concepts
· 11866 Metro Parkway
· Ft. Myers, FL 33966-1307
· Phone: (239) 337-1212
· Fax: (239) 337-4910

· Perdue Office Interiors
· Suite 100
· 5 W Forsyth
· Jacksonville, FL 32256-7440
· Phone: (904) 737-5858
· Fax: (904) 737-6088

· Perdue Office Interiors
· Suite C7
· 1516 Capital Circle SE
· Tallahassee, FL 32301
· Phone: (850) 383-4225

Georgia

· Advent Business Interiors
· 1318 U.S. HWY 82 West
· Leesburg, GA 31721
· Phone: (229) 439-7418
· Fax: (229) 435-1279

· Advent Business Interiors
· 110 West Macon Park Dr.
· Macon, GA 31210
· Phone: (478) 471-0600

· DeKalb Office Environments
· 1320 Ridgeland Parkway
· Alpharetta, GA 30004-8442
· Phone: (770) 360-0200
· Fax: (770) 360-0305

· McWaters Inc.
· 3708 Benchmark Drive
· Augusta, GA 30907
· Phone: (706) 396-5400
· Fax: (706) 396-5401

· McWaters Inc.
· 117 Prosperity Drive
· Savannah, GA 31408-9551
· Phone: (912) 352-9000
· Fax: (912) 352-2034

Hawaii

· Interior Showplace Ltd.
· 956 Queen Street
· Honolulu, HI 96814-4118
· Phone: (808) 593-8420
· Fax: (808) 591-8324

Idaho

· Porter's Office Products
· 435 West Center Street
· Pocatello, ID 83204-3241
· Phone: (208) 232-1233
· Fax: (208) 232-8759

· Porter's Office Products
· 1050 North 2nd East
· Rexburg, ID 83440-5127
· Phone: (208) 356-4616
· Fax: (208) 356-8901

· Office Environment Company
· 623 South Americana Blvd.
· Boise, ID 83702-5120
· Phone: (208) 385-0507
· Fax: (208) 385-9392

Illinois

· A. Pomerantz
· Suite 940
· 222 Merchandise Mart Plaza
· Chicago, IL 60654-1223
· Phone: (312) 929-3335
· Fax: (312) 929-3311

· Atmosphere Commercial Interiors
· 801 North Perryville Road
· Rockford, IL 61107
· Phone: (815) 398-3300

· Egyptian Business Furniture
· 129 West Main Street
· Belleville, IL 62220-1501
· Phone: (618) 234-2323
· Fax: (618) 236-3295

· Interiors for Business Inc.
· 409 N River Street
· Batavia, IL 60510-2359
· Phone: (630) 761-1070
· Fax: (630) 761-1065

· Lincoln Office
· 205 Eastgate Drive
· Washington, IL 61571-9238
· Phone: (309) 427-2500
· Fax: (309) 427-2625

· Forward Space
· Suite 614
· 222 Merchandise Mart Plaza
· Chicago, IL 60654-1223
· Phone: (312) 563-5206

· Forward Space
· 1142 N North Branch Street
· Chicago, IL 60642
· Phone: (312) 942-1100
· Fax: (312) 942-9840

· Forward Space
· 13820 West Business Center Drive
· Lake Forest, IL 60045-1181
· Phone: (847) 573-8890
· Fax: (847) 573-8891

· Forward Space
· Suite 150
· 1111 West 22nd Street
· Oak Brook, IL 60523
· Phone: (312) 563-5206

Indiana

· Business Furnishings LLC
· 4102 Meghan Beeler Court
· South Bend, IN 46628
· Phone: (574) 243-3255
· Fax: (574) 243-3266

· Business Furniture LLC
· 6102 Victory Way
· Indianapolis, IN 46278-2934
· Phone: (317) 216-1600
· Fax: (317) 216-1601

· Corporate Design Inc.
· Suite 400
· 1419 West Lloyd Expressway
· Evansville, IN 47710-1002
· Phone: (812) 422-3000
· Fax: (812) 422-3413

· Lincoln Office
· 1200 Arrowhead Court
· Crown Point, IN 46307-8222
· Phone: (219) 662-2777
· Fax: (219) 662-7770

Iowa

· Lincoln Office
· 1026 Mound St
· Davenport, IA 52803
· Phone: (563) 322-5660

· Tallgrass Business Resources
· Highway 6 West
· 218 Second Street
· Coralville, IA 52241-2608
· Phone: (319) 338-3135
· Fax: (319) 338-7484

· Workspace Inc.
· 309 Locust Street
· Des Moines, IA 50309-1788
· Phone: (515) 288-7090
· Fax: (515) 288-0250

Kansas

· Design Central Inc.
· 152 South 5th Street
· Salina, KS 67401
· Phone: (785) 825-4131
· Fax: (785) 825-4778

· Scott Rice Office Interiors
· 224 East Douglas
· Wichita, KS 67211-1640
· Phone: (316) 269-2700
· Fax: (316) 269-3527

· Scott Rice Office Works
· 14720 West 105th Street
· Lenexa, KS 66215-4414
· Phone: (913) 888-7600
· Fax: (913) 227-7793

Kentucky

· Office Resources Inc.
· 530 Corvette Drive
· Bowling Green, KY 42101-7132
· Phone: (270) 781-5858
· Fax: (270) 781-5884

· Office Resources Inc.
· 101 Bradley Drive
· Nicholasville, KY 40356-9121
· Phone: (859) 885-6161
· Fax: (859) 885-9610

· Office Resources Inc.
· 816 East Broadway
· Louisville, KY 40204-1053
· Phone: (502) 589-8400
· Fax: (502) 589-8408

Louisiana

· Frost-Barber Inc.
· 9322 Interline Avenue
· Baton Rouge, LA 70809-1966
· Phone: (225) 926-5000
· Fax: (225) 926-5011

· Workplace Solutions
· 401 St. Joseph Street.
· New Orleans, LA 70130
· Phone: (504) 522-9558
· Fax: (504) 522-7070

Maine

· Red Thread
· One City Center
· Portland, ME 04101
· Phone: (207) 774-4900
· Fax: (207) 774-8155

Maryland

· Arbee Associates
· 6311 Ammendale Road
· Beltsville, MD 20705-1249
· Phone: (410) 385-5180
· Fax: (410) 385-5199

· Arbee Associates
· 9300 Gaither Road
· Gaithersburg, MD 20877
· Phone: (301) 963-3900
· Fax: (301) 977-1734

· Dancker, Sellow & Douglas Inc.
· Suite 309
· 509 Exeter Street
· Baltimore, MD 21202
· Phone: (301) 671-2541
· Fax: (301) 797-1504

Participating Steelcase Dealers, continued

Dancker, Sellaw & Douglas Inc.
9200 Alaking Court
Suite 100
Capitol Heights, MD 20743
Phone: (301) 350-8700
Fax: (301) 350-9393

Massachusetts

Red Thread
Suite 600
101 Seaport Blvd.
Boston, MA 02210-1838
Phone: (617) 439-4900
Fax: (617) 439-4131

Red Thread
Suite 150
293 Boston Post Road West
Marlborough, MA 01752-4615
Phone: (508) 449-6550
Fax: (508) 449-6570

Red Thread
Suite 1108
1350 Main Street
Springfield, MA 01103
Phone: (413) 736-1802

Red Thread
100 Fordham Road
Wilmington, MA 01887
Phone: (978) 658-3900
Fax: (978) 694-4107

Michigan

Custer Office Environments Inc.
2435 Plaza Drive
Benton Harbor, MI 49022-2229
Phone: (616) 926-8719
Fax: (616) 926-9482

Custer Office Environments Inc.
217 Grandville Ave SW
Grand Rapids, MI 49503-4013
Phone: (616) 458-6322
Fax: (616) 458-1117

Custer Office Environments Inc.
5737 East Cork Street
Kalamazoo, MI 49048-9668
Phone: (269) 342-3919
Fax: (269) 342-3923

Custer Office Environments
442 East Michigan
Marquette, MI 49885
Phone: (906) 226-1161
Fax: (906) 226-1164

Custer Office Environments
120 East Front Street
Traverse City, MI 49684
Phone: (616) 402-8489

NBS
701 Salzburg Avenue
Bay City, MI 48706-5390
Phone: (989) 895-8574
Fax: (989) 895-8545

NBS
5133 West Grand River Avenue
Lansing, MI 48906-9117
Phone: (517) 886-0072
Fax: (517) 886-0014

NBS
2595 Bellingham Drive
Troy, MI 48083-2036
Phone: (248) 823-5400
Fax: (248) 823-5401

Minnesota

Atmosphere Commercial Interiors
Suite 350
81 South 9th Street
Minneapolis, MN 55402-3226
Phone: (612) 343-0868
Fax: (612) 332-5733

Burgher Office Equipment Company
101 East Chestnut Street
Virginia, MN 55792-2512
Phone: (218) 749-2661
Fax: (218) 749-2662

Duluth Typewriter & Business Furniture
30 N 3rd. Ave W
Duluth, MN 55802-1607
Phone: (218) 722-5811
Fax: (218) 722-4876

General Office Products Company
4521 Highway 7
Minneapolis, MN 55416-4098
Phone: (952) 925-7500
Fax: (952) 925-7531

Mississippi

Workplace Solutions
251 West South Street
Jackson, MS 39203-3636
Phone: (601) 354-4960
Fax: (601) 353-6231

Workplace Solutions
2207 5th Street
Meridian, MS 38652
Phone: (601) 484-7279

Workplace Solutions
520 Main Street
Natchez, MS 39120
Phone: (601) 442-1494
Fax: (601) 442-0457

Workplace Solutions
718 West Bankhead St.
New Albany, MS 38652
Phone: (662) 534-0882
Fax: (662) 534-5753

OEC Business Interiors
12199 Highway 49 N.
Suite 300
Gulfport, MS 39503-3167
Phone: (228) 539-9575
Fax: (228) 539-9566

Missouri

Color-Art Integrated Interiors
1325 North Warson Road
Saint Louis, MO 63132-1807
Phone: (314) 432-3000
Fax: (314) 993-2752

Marathon Office Interiors
1715 Paris Road
Columbia, MO 65201-5571
Phone: (573) 875-7115
Fax: (573) 875-7116

Montana

KR Office Interiors
119 North 7th Avenue
Bozeman, MT 59715
Phone: (406) 587-3775
Fax: (406) 587-4636

KR Office Interiors
1710 North Montana Avenue
Helena, MT 59601
Phone: (406) 513-1004
Fax: (406) 513-1006

Missoula's Office City
115 West Broadway Street
Missoula, MT 59802-4217
Phone: (406) 543-7171
Fax: (406) 543-4254

Peterson's Quality Office Equipment
502 North 32nd Street
Billings, MT 59101-6003
Phone: (406) 245-5151
Fax: (406) 245-7516

Western Office Equipment
317 2nd Street South
Great Falls, MT 59405-1802
Phone: (406) 761-7473
Fax: (406) 761-0245

Nebraska

Eakes Office Plus
2911 13th Street
Columbus, NE 68601-4829
Phone: (402) 564-2679
Fax: (402) 564-0295

Eakes Office Plus
Suite 201
2630 North Yager Road
Fremont, NE 68025-7800
Phone: (402) 941-5001
Fax: (402) 941-5002

Eakes Office Plus
617 West Third Street
Grand Island, NE 68801-5946
Phone: (308) 382-8026
Fax: (308) 382-7401

Eakes Office Plus
839 West Second Street
Hastings, NE 68901-5099
Phone: (402) 463-2537
Fax: (402) 463-6802

Eakes Office Plus
2401 Avenue A
Kearney, NE 68847-5498
Phone: (308) 234-2538
Fax: (308) 234-2540

Eakes Office Plus
110 N 35th Street
Lincoln, NE 68503
Phone: (402) 438-6700
Fax: (402) 438-6701

Eakes Office Plus
1803 North 6th Street
Beatrice, NE 68310
Phone: (402) 228-7202
Fax: (402) 228-0262

Eakes Office Plus
120 Norris Avenue
McCook, NE 69001
Phone: (308) 345-5447
Fax: (308) 345-5237

Eakes Office Plus
510 W. 13th Street
Souix City, NE 68776
Phone: (402) 412-2334

Eakes Office Plus
201 South 1st Street
Norfolk, NE 68701-5303
Phone: (402) 371-4181
Fax: (402) 371-5139

Eakes Office Plus
520 North Vine Street
North Platte, NE 69101-3954
Phone: (308) 534-7800
Fax: (308) 534-3936

Eakes Office Plus
710 North Lincoln Ave.
York, NE 68467
Phone: (402) 362-5442
Fax: (402) 362-7530

Sheppard's Business Interiors Inc.
725 South 72nd Street
Omaha, NE 68114-4665
Phone: (402) 393-8888
Fax: (402) 393-0113

Nevada

Machabee Office Environments
6435 Sunset Corporate Drive
Las Vegas, NV 89120-2798
Phone: (702) 263-8800
Fax: (702) 263-8801

Machabee Office Environments
1335 Greg Parkway #101
Sparks, NV 89431
Phone: (775) 329-3145
Fax: (775) 786-5710

New Hampshire

Red Thread
Suite 103
650 Elm Street
Manchester, NH 03101-1160
Phone: (603) 668-5511
Fax: (603) 668-6851

New Jersey

Arbee Associates
1531 South Washington Avenue
Piscataway, NJ 08854-3815
Phone: (732) 424-3900
Fax: (732) 752-6034

Concepts Office Furnishings
280 North Midland Avenue
Building J
Saddle Brook, NJ 07663-5708
Phone: (201) 727-9110
Fax: (201) 727-9112

Dancker, Sellow, and Douglas
291 Evans Way
Somerville, NJ 08876-3766
Phone: (908) 231-1600
Fax: (908) 231-6469

W.S. Goff Company Inc.
5104 Oakland Blvd.
Mays Landing, NJ 08330-2016
Phone: (609) 625-5600
Fax: (609) 625-5633

New Mexico

Business Environments
5351 Wilshire Avenue, N.E.
Albuquerque, NM 87113-1834
Phone: (505) 888-4400
Fax: (505) 889-9146

New York

AFD Contract Furniture Inc
810 7th Avenue
New York, NY 10019
Phone: (212) 721-7100
Fax: (212) 721-7175

Merkel-Donohue
1 Interstate Avenue
Albany, NY 12205
Phone: (518) 273-9359
Fax: (518) 272-1552

Empire Office Inc.
105 Madison Avenue
New York, NY 10016-8810
Phone: (212) 607-5500
Fax: (212) 607-5654

Merkel-Donohue
1349 University Avenue Suite 2
Rochester, NY 14607
Phone: (585) 325-7696
Fax: (585) 325-3065

Prentice Office Environments
472 Franklin Street
Buffalo, NY 14202-1302
Phone: (716) 884-8452
Fax: (716) 884-0894

Stevens Office Interiors
6804 Manlius Center Road
East Syracuse, NY 13057-3902
Phone: (315) 479-5595
Fax: (315) 428-1688

Waldner's Business Environments
125 Route 110
Farmingdale, NY 11735-4864
Phone: (631) 844-9300
Fax: (631) 694-3503

Waldner's Business Environments
215 Lexington Avenue, 9th Floor
New York, NY 10016-6023
Phone: (212) 696-7500
Fax: (212) 696-7699

Waldner's Business Environments
411 Theodore Fremd Avenue
3rd Floor, South Building
Rye, NY 10580-1410
Phone: (914) 921-8500
Fax: (914) 921-0991

North Carolina

Office Environments Inc.
11407 Granite Street
Charlotte, NC 28273-6429
Phone: (704) 714-7200
Fax: (704) 714-7400

Young Office Environments
of Asheville Inc.
71 Thompson St
Asheville, NC 28803-2328
Phone: (888) 202-0508
Fax: (828) 505-1974

Storr Office Environments Inc.
496 Gallimore Dairy Road
Greensboro, NC 27409-9202
Phone: (336) 217-4500
Fax: (336) 217-4501

Storr Office Environments Inc.
10800 World Trade Blvd.
Raleigh, NC 27617-4200
Phone: (919) 313-3700
Fax: (919) 313-3701

Williams Office Environments Inc.
407 Ray Avenue
Fayetteville, NC 28301-4915
Phone: (910) 483-0354
Fax: (910) 486-4077

North Dakota

Fireside Office Products Inc.
1713 East Bismarck Expressway
Bismarck, ND 58504-6706
Phone: (701) 258-8586
Fax: (701) 223-9598

Hannaher's
1809 13th Avenue North
Grand Forks, ND 58203-2323
Phone: (701) 746-6466
Fax: (701) 746-0737

Hannaher's Inc.
4324 20th Avenue SW
Fargo, ND 58103-4434
Phone: (701) 277-7222
Fax: (701) 277-7097

Ohio

Business Furniture
8 North Main Street
Dayton, OH 45439
Phone: (937) 293-1010
Fax: (937) 293-7501

Loth Inc.
3574 East Kemper Road
Cincinnati, OH 45241-2009
Phone: (513) 554-4900
Fax: (513) 554-8737

Loth Company
855 Grandview Avenue
Columbus, OH 43215-1123
Phone: (614) 487-4000
Fax: (614) 487-4306

NBS
4 North St. Clair Street
Toledo, OH 43604
Phone: (419) 662-2040
Fax: (419) 662-2041

Ohio Desk
34 Swartz Road
Akron, OH 44319
Phone: (330) 499-1030

Ohio Desk
1122 Prospect Avenue
Cleveland, OH 44115-1292
Phone: (216) 623-0600
Fax: (216) 623-0611

Ohio Desk
5100 Market Street
Youngstown, OH 44512
Phone: (330) 782-3331

Oklahoma

Scott Rice
2900 North Hemlock Circle
Broken Arrow, OK 74012-1185
Phone: (918) 362-4300
Fax: (918) 362-4303

Scott Rice
7501 Broadway Ext
Oklahoma City, OK 73116-9015
Phone: (405) 848-2224
Fax: (405) 848-3999

Oregon

Hypfn
Suite 103/104
150 SW Scalehouse Loop
Bend, OR 97702
Phone: (541) 317-8777
Fax: (541) 317-2833

Hypfn
620 NE 19th Avenue
Portland, OR 97232-2832
Phone: (503) 226-4151
Fax: (503) 226-9233

Pennsylvania

A. Pomerantz & Company
Suite 7000
701 Market Street
Philadelphia, PA 19106-1597
Phone: (215) 408-2100
Fax: (215) 408-2110

Corporate Interiors
Suite 200
161 Washington Street
Conshohocken, PA 19428-2083
Phone: (610) 631-5400
Fax: (610) 631-2720

Interior Workplace Solutions LLC.
145 Stewart Road
Wilkes-Barre, PA 18706
Phone: (570) 288-7211
Fax: (570) 970-5817

Franklin Interiors
Suite 600
2740 Smallman Street
Pittsburgh, PA 15222-4720
Phone: (412) 261-2525
Fax: (412) 255-4089

Participating Steelcase Dealers, continued

Pennsylvania

Interior Workplace Solutions LLC.
6765 Ambassador Drive
Allentown, PA 18106-9510
Phone: (610) 391-0733
Fax: (610) 391-1155

Interior Workplace Solutions LLC.
Suite B-25
2209 Quarry Drive
Reading, PA 19609-1155
Phone: (610) 670-1800
Fax: (610) 670-8181

McCartney's Inc.
819 Howard Avenue
Altoona, PA 16601-4727
Phone: (814) 505-1111
Fax: (814) 949-6197

Phillips Workplace Interiors
6345 Flank Drive
Harrisburg, PA 17112
Phone: (844) 228-2600

South Carolina

Aiken Office Supply Inc.
2560 Whiskey Road
Aiken, SC 29803-9664
Phone: (803) 648-8339
Fax: (803) 649-4470

McWaters Inc.
1104 Shop Road
Columbia, SC 29201-4743
Phone: (803) 256-8303
Fax: (803) 252-5567

McWaters Inc.
3841 Commercial Center Drive
Ladson, SC 29456-4146
Phone: (843) 486-1823

Wulbern-Koval Company Inc.
1111 Morrison Drive
Charleston, SC 29403-3119
Phone: (843) 577-7666
Fax: (843) 577-7299

Young Office Environments
1280 Ridge Road
Greenville, SC 29607-4626
Phone: (864) 281-9500
Fax: (864) 281-9555

South Dakota

Interstate Office Products Inc.
228 South Main Avenue
Sioux Falls, SD 57104-6310
Phone: (605) 339-0300
Fax: (605) 339-1989

Western Stationers
714 Saint Joseph Street
Rapid City, SD 57701-2721
Phone: (605) 342-3310
Fax: (605) 342-4746

Tennessee

Bentco Office Solutions
1501 Stuart Street
Chattanooga, TN 37406
Phone: (423) 756-4437
Fax: (423) 756-6198

Memphis Business Interiors
4539 West Distriplex Drive
Memphis, TN 38118-7280
Phone: (901) 360-8899
Fax: (901) 360-8370

Office Resources Inc.
4020 Armory Oaks Drive
Nashville, TN 37204
Phone: (615) 376-1200
Fax: (615) 376-1245

Workspace Interiors
Suite 300
200 E. Main Street
Kingsport, TN 37660-4354
Phone: (423) 392-2600
Fax: (423) 392-2601

Workspace Interiors
2820 Middlebrook Pike
Knoxville, TN 39721
Phone: (865) 223-5404
Fax: (865) 223-5405

Texas

Abilene Printing & Stationery
218 Cedar Street
Abilene, TX 79601-5720
Phone: (915) 677-2673
Fax: (915) 675-6963

BKM Total Office of Texas
9755 Clifford Drive
Dallas, TX 75220
Phone: (214) 902-7200
Fax: (214) 902-7201

Business Interiors
1111 Valley View Lane
Irving, TX 75061-6008
Phone: (817) 858-2000
Fax: (817) 858-2020

McCoys Inc.
6869 Old Katy Road
Houston, TX 77024-2105
Phone: (713) 862-4600
Fax: (713) 862-7676

Rockford Business Interiors
211 East Riverside Drive
Austin, TX 78704-1203
Phone: (512) 442-0703
Fax: (512) 442-6555

Texas Wilson Office Furniture &
Services
5801 George McVay Drive
McAllen, Texas 78503
Phone: (210) 647-8800
Fax: (210) 647-3110

Texas Wilson Office Furniture &
Services

6812 Fairgrounds Pkwy
San Antonio, TX 78238-4536
Phone: (210) 647-8800
Fax: (210) 647-3110

West Supply Company
1601 Scurry
Big Spring, TX 79720
Phone: (432) 264-1788
Fax: (432) 264-1789

West Supply Company
2 South Chadbourne Street
San Angelo, TX 76903-5875
Phone: (325) 655-8181
Fax: (325) 655-5480

Utah

MidWest Office Furniture
987 South West Temple
Salt Lake City, UT 84101-2988
Phone: (801) 359-7681
Fax: (801) 355-2713

Vermont

Red Thread
180 Battery St Ste 210
Burlington, VT 05401-5212
Phone: (802) 862-0434
Fax: (802) 862-0729

Virginia

Barrows
1302 Rockland Avenue
Roanoke, VA 24012-3838
Phone: (540) 362-5700
Fax: (540) 362-4826

Creative Office Environments
11798 North Lakeridge Boulevard
Ashland, VA 23005-8152
Phone: (804) 329-0400
Fax: (804) 321-3134

Creative Office Environments LLC
650 Peter Jefferson Parkway #140
Charlottesville, VA 22911
Phone: (434) 327-1898
Fax: (434) 327-1896

Creative Office Environments LLC
Suite C
500 Woodlake Circle
Chesapeake, VA 23320-2807
Phone: (757) 549-4801
Fax: (757) 549-2795

reDistrict
Suite 30
66 Canal Center Plaza
Arlington, VA 22314
Phone: (703) 276-8901
Fax: (703) 276-8908

Washington

OpenSquare
6th Floor
5601 Sixth Avenue South
Seattle, WA 98108-2522
Phone: (206) 768-8000
Fax: (206) 768-0236

OpenSquare
126 South Sheridan Street
Spokane, WA 99202-1527
Phone: (509) 483-1000
Fax: (509) 483-1011

Wisconsin

Atmosphere Commercial Interiors
999 Fourier Drive Suite 200
Madison, WI 53717
Phone: (608) 257-0521
Fax: (608) 257-1859

Puerto Rico

AFD Contract Furnishings
Suite 250
350 Chardon Avenue
Torre Chardon
San Juan, Puerto Rico 00918-2123
Phone: (787) 754-2938
Fax: (787) 754-8076

Showrooms

Atlanta

Steelcase Inc.
Suite AL-175
303 Peachtree Center
Atlanta, GA 30303
Phone: (404) 523-2201

Chicago

Steelcase Worklife Chicago
Suite 300
222 Merchandise Mart
Chicago, IL 60654-1174
Phone: (312) 321-3720

Chicago

Coalesse
Suite 1032
222 Merchandise Mart
Chicago, IL 60654
Phone: (312) 467-1783

Dallas

Steelcase Inc.
1616 Hi Line Drive
Dallas, TX 75207
Phone: (214) 871-3044

Grand Rapids

Steelcase Inc.
901 44th Street, SE
Grand Rapids, MI 49508-7594
Phone: (616) 247-2710

New York

Steelcase Worklife New York
4 Columbus Circle
New York, NY 10019-1100
Phone: (212) 445-8800

Philadelphia

Steelcase Inc.
One Liberty Place
1650 Market Street, 3rd Floor
Philadelphia, PA 19103-7307
Phone: (215) 561-5331

San Francisco

Steelcase Inc.
Suite 110
475 Brannan Street
San Francisco, CA 94107
Phone: (415) 344-6700

Santa Monica

Steelcase Inc.
1217 2nd Street
Santa Monica, CA 90401-1180
Phone: (310) 633-2200

Washington D.C.

Steelcase Inc.
1121 14th Street NW
4th Floor
Washington, DC 20005

Manufacturing Sites

Amex de Mexico

Calle 5 Sur No.160
Ciudad Industrial
Tijuana, Mexico B.C. 22500
Phone: 52-662-342-6234

Athens

214 Durham Drive
Athens, AL 35611
Phone: (256) 232-8112

Grand Rapids Wood Furniture

4100 68th Street SE
Caledonia, MI 49316
Phone: (616) 698-5735

Kentwood Distribution Center

4384 52nd Street SE
Kentwood, MI 49512-9673

Kentwood West

4360 52nd Street SE
Kentwood, MI 49512

Details

901 44th Street SE
Grand Rapids, MI 49508
Phone: (616) 247-2710

Reynosa Plant

Ave. Prologis S/N Ed. 8 Suite
801 Prologis Park Pharr Bridge
Reynosa,
Tamaulipas, Mx CP. 88780
Phone: 52-899-263-9000



Power and Data Access

Grommets (SIN 711.2)	20
Spheres (SIN 711.2)	21
Interact (SIN 711.11)	23
Axil Z (SIN 711.11)	24
Ellora (SIN 711.11)	26
Base Power Infeeds (SIN 711.11)	28
Power Strip (SIN 711.11)	29
Wire Managers (SIN 711.11)	30

Power and Data Access Grommets

SIN 711.2

Grommets for Standard Locations



Tip: The grommet will be shipped with the table so it can be installed on site in the factory-cut opening.

Tip: Custom locations are possible. Custom locations require an engineering review to confirm practicality. Please send a drawing to your customer service representative to show the locations you want, confirm practicality, and obtain a quotation.

Tip: Please send a drawing of your arrangement along with your order to ensure that grommets are properly installed.

Tip: Additional tables may be able to accommodate grommets. Ask your Customer Service representative at 1.800.627.6770 to help you determine practicality.

Standard Includes	Required to Specify
<ul style="list-style-type: none"> • 2" diameter opening with snap out covers allow power cords and voice/data cables to pass through the worksurface: black plastic • Factory-installed in standard locations on Ballet K-Base, Reunion Seminar, Train, and Exponents credenzas 	Style number

Specification Information	
Style Number	Price
793215	\$70

Power and Data Access Spheres

SIN 711.2

Power and Communication Spheres for Standard Locations

Tip: The sphere will be shipped with the table so it can be installed on site in the factory-cut opening.

Tip: Field-installed sphere is practical on many table tops. Order unit separately and cut the required hole in the table top on site. Installation instructions will be shipped with the sphere.

Tip: Custom locations are possible. Custom locations require an engineering review to confirm practicality. Please send a drawing to your customer service representative to show the locations you want, confirm practicality, and obtain a quotation.

Tip: Please send a drawing of your arrangement along with your order to ensure that spheres are properly installed.

Tip: Additional tables may be able to accommodate spheres. Ask your Customer Service representative at 1.800.627.6770 to help you determine practicality.

Tip: If couplers are needed on PCS or CSP they must be ordered separately.



Standard Includes	Required to Specify
<ul style="list-style-type: none"> • 3³/₈" diameter and 1⁵/₈"H above table surface: black plastic • 6' power cord • Factory-installed in standard locations on Ballet K-Base and Reunion Seminar • Sphere selection: <ul style="list-style-type: none"> - Power sphere (PSP) with four simplex power outlets - Power and communication sphere (PCS) with two simplex power outlets and two spaces to connect RJ11 or RJ45 couplers on site - Communication sphere (CSP) with four spaces to connect RJ11 or RJ45 couplers on site 	Style number

Specification Information

Style Number	Price
Four Data Jack Locations	
CSP	\$172
Two Simplex Power Outlets and Two Data Jack Locations	
PCS	\$262
Four Simplex Power Outlets	
PSP	\$380

Power and Data Access Spheres *continued*

SIN 711.2

Data Jack Couplers

Standard Includes	Required to Specify
<ul style="list-style-type: none">• Data coupler	Style number

Specification Information

Style Number	Price
RJ11	\$12
RJ45	\$16

Power and Data Access Interact, 9" x 5³/₈"

SIN 711.11

Interact

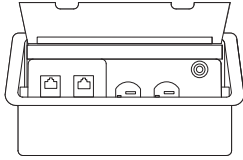

Tip: Can accommodate one, customer-supplied modular furniture faceplate for voice/data jacks.

Tip: For tables that require an Interact desktop module, a special engineering quote is mandatory. If you require a factory installed cutout in a location other than standard, send us a drawing with measurements indicating the exact location(s) required in the table top.

Tip: The hardwire Interact desktop module does not work with modular table power kits.

Tip: If a hardwire Interact desktop module is desired, then it should only be specified on tables with glides.

Standard Includes	Required to Specify
<ul style="list-style-type: none"> • Box, lid, and attachment bracket: steel, black textured powder coat surface • Requires 8³/₈" x 4³/₄" cutout • Contains two 15-amp power outlets with built-in circuit breaker • One additional 15-amp power outlet is included on the bottom of the box 	Style number

Specification Information

Dimensions			Style Number	Price
D	W	H		
Interact, 6' Cord				
5 ³ / ₈ "	9"	2 ³ / ₄ "	INTSC	\$401
Interact, 6' Hardwire				
5 ³ / ₈ "	9"	2 ³ / ₄ "	INTHW	\$401

Power and Data Access Axil Z, 8" x 3"

SIN 711.11

Axil Z, Cord

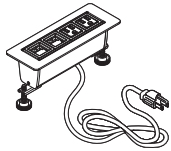

Tip: The Axil Z desktop module will ship with instructions and a hole cutout template for field installation, if needed.

Tip: For a factory installed cutout in the table top, specify Axil Z as an option for Train. If you do not specify Axil Z as an option, where applicable, the table top will require a field installed cutout.

► See *Coalesse Tables, Storage, and Accessories Specification Guide* for cutout locations.

Tip: For any other tables, other than Train, that require an Axil Z desktop module, a special engineering quote is mandatory. If you require a factory installed cutout in a location other than standard, send us a drawing with measurements indicating the exact location(s) required in the table top.

Tip: USB for charging is configured in the spot of one data port and is always configured on the end(s).

Tip: For each USB port specified, there are two USBs per port.

Standard Includes	Required to Specify
<ul style="list-style-type: none"> • Desktop module, mounts flat just above worksurface: <ul style="list-style-type: none"> - 4140 Arctic White - 4144 Black Gloss • 6' power cord with 15-amp plug • Requires 6¾" x 2" cutout • Utilizes water-proof simplexes (outlets) • UL listed • Voice/data adaptor kit to accept couplers and jacks when needed (refer to telecommunications reference chart) 	<ol style="list-style-type: none"> 1 Style number 2 Desktop module configuration (see Required Selections below) 3 Paint color number for desktop module

Options	List Price	Required to Specify
Power/Data/USB Configuration		
• Two power/two data	No cost	Specify <i>with two power/two data</i> and select color number.
• Two power/one data/one USB	+\$100	Specify <i>with two power/two data/one USB</i> and select color number.
• Two power/two USB	+\$201	Specify <i>with two power/two USB</i> and select color number.
• Three power/one data	+\$ 5	Specify <i>with three power/one data</i> and select color number.
• Three power/one USB	+\$106	Specify <i>with three power/one USB</i> and select color number.
• Four power	+\$ 69	Specify <i>with four power</i> and select color number.

Specification Information				
Dimensions			Style Number	Base Price
D	W	H		
3"	8"	2¾"	CODPA4	\$201

Power and Data Access Axil Z, 8" x 3"

SIN 711.11

Axil Z, Hardwire

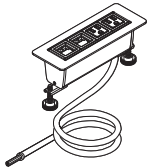

Tip: The Axil Z desktop module will ship with instructions and a hole cutout template for field installation, if needed.

Tip: For a factory installed cutout in the table top, specify Axil Z as an option for Train. If you do not specify Axil Z as an option, where applicable, the table top will require a field installed cutout.

► See *Coalesse Tables, Storage, and Accessories Specification Guide* for cutout locations.

Tip: For any other tables, other than Train, that require an Axil Z desktop module, a special engineering quote is mandatory. If you require a factory installed cutout in a location other than standard, send us a drawing with measurements indicating the exact location(s) required in the table top.

Tip: USB for charging is configured in the spot of one data port and is always configured on the end(s).

Tip: For each USB port specified, there are two USBs per port.

Tip: The hardwire Axil Z desktop module does not work with modular table power kits.

Tip: If a hardwire Axil Z desktop module is desired, then it should only be specified on tables with glides.

Standard Includes	Required to Specify
<ul style="list-style-type: none"> Desktop module, mounts flat just above worksurface: <ul style="list-style-type: none"> - 4140 Arctic White - 4144 Black Gloss 6' flexible steel hardwire conduit Requires 6¾" x 2" cutout Utilizes water-proof simplex (outlets) UL listed Voice/data adaptor kit to accept couplers and jacks when needed (refer to telecommunications reference chart) 	<ol style="list-style-type: none"> Style number Desktop module configuration (see Required Selections below) Paint color number for desktop module

Options	List Price	Required to Specify
Power/Data/USB Configuration		
• Two power/two data	No cost	Specify <i>with two power/two data</i> and select color number.
• Two power/one data/one USB	+\$100	Specify <i>with two power/one data/one USB</i> and select color number.
• Two power/two USB	+\$201	Specify <i>with two power/two USB</i> and select color number.
• Three power/one data	+\$ 5	Specify <i>with three power/one data</i> and select color number.
• Three power/one USB	+\$106	Specify <i>with three power/one USB</i> and select color number.
• Four power	+\$ 69	Specify <i>with four power</i> and select color number.

Specification Information				
Dimensions			Style Number	Base Price
D	W	H		
3"	8"	2¾"	CODHA4	\$201

Power and Data Access Ellora, 8¼" x 5¼"

SIN 711.11

Ellora, Cord

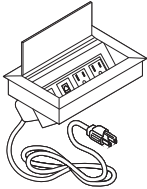

Tip: The Ellora desktop module will ship with instructions and a hole cutout template for field installation, if needed.

Tip: For a factory installed cutout in the table top, specify Ellora as an option for Train. If you do not specify Ellora as an option, where applicable, the table top will require a field installed cutout.

► See *Coalesse Tables, Storage, and Accessories Specification Guide* for cutout locations.

Tip: For any other tables, other than Train, that require an Ellora desktop module, a special engineering quote is mandatory. If you require a factory installed cutout in a location other than standard, send us a drawing with measurements indicating the exact location(s) required in the table top.

Tip: USB for charging is configured in the spot of one data port and is always configured on the end(s).

Tip: For each USB port specified, there are two USBs per port.

Standard Includes	Required to Specify
-------------------	---------------------

- | | |
|--|--|
| <ul style="list-style-type: none"> • Desktop module with lid, mounts flat just above worksurface: anodized aluminum with black faceplate • 6' power cord with 15-amp plug • Requires 8" x 5" cutout • Utilizes water-proof simplex (outlets) • UL listed • Voice/data adaptor kit to accept couplers and jacks when needed (refer to telecommunications reference chart) | <ol style="list-style-type: none"> 1 Style number 2 Desktop module configuration (see Required Selections below) |
|--|--|

Options	List Price	Required to Specify
---------	------------	---------------------

Options	List Price	Required to Specify
Power/Data/USB Configuration	<ul style="list-style-type: none"> • Two power/two data No cost • Two power/one data/one USB +\$100 • Two power/two USB +\$201 • Three power/one data +\$ 5 • Three power/one USB +\$106 • Four power +\$ 69 	<p>Specify with two power/two data.</p> <p>Specify with two power/one data/one USB.</p> <p>Specify with two power/two USB.</p> <p>Specify with three power/one data.</p> <p>Specify with three power/one USB.</p> <p>Specify with four power.</p>

Specification Information				
---------------------------	--	--	--	--

Dimensions			Style Number	Base Price
D	W	H		
5¼"	8¼"	3½"	CODPE4	\$317

Power and Data Access Ellora, 8¼" x 5¼"

SIN 711.11

Ellora, Hardware

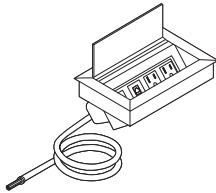

Tip: The Ellora desktop module will ship with instructions and a hole cutout template for field installation, if needed.

Tip: For a factory installed cutout in the table top, specify Ellora as an option for Train. If you do not specify Ellora as an option, where applicable, the table top will require a field installed cutout.

► See *Coalesse Tables, Storage, and Accessories Specification Guide* for cutout locations.

Tip: For any other tables, other than Train, that require an Ellora desktop module, a special engineering quote is mandatory. If you require a factory installed cutout in a location other than standard, send us a drawing with measurements indicating the exact location(s) required in the table top.

Tip: USB for charging is configured in the spot of one data port and is always configured on the end(s).

Tip: For each USB port specified, there are two USBs per port.

Tip: The hardware Ellora desktop module does not work with modular table power kits.

Tip: If a hardware Ellora desktop module is desired, then it should only be specified on tables with glides.

Standard Includes	Required to Specify
-------------------	---------------------

- | | |
|--|--|
| <ul style="list-style-type: none"> • Desktop module with lid, mounts flat just above worksurface: anodized aluminum with black faceplate • 6' flexible steel hardware conduit • Requires 8" x 5" cutout • Utilizes water-proof simplex (outlets) • UL listed • Voice/data adaptor kit to accept couplers and jacks when needed (refer to telecommunications reference chart) | <ol style="list-style-type: none"> 1 Style number 2 Desktop module configuration (see Required Selections below) |
|--|--|

Options	List Price	Required to Specify
---------	------------	---------------------

Power/Data/USB Configuration	<ul style="list-style-type: none"> • Two power/two data • Two power/one data/one USB • Two power/two USB • Three power/one data • Three power/one USB • Four power 	<p>No cost</p> <p>+\$100</p> <p>+\$201</p> <p>+\$ 5</p> <p>+\$106</p> <p>+\$ 69</p>	<p>Specify with two power/two data.</p> <p>Specify with two power/one data/one USB.</p> <p>Specify with two power/two USB.</p> <p>Specify with three power/one data.</p> <p>Specify with three power/one USB.</p> <p>Specify with four power.</p>
-------------------------------------	--	---	---

Specification Information				
Dimensions			Style Number	Base Price
D	W	H		

5¼"	8¼"	3½"	CODHE4	\$317
-----	-----	-----	--------	-------

Power and Data Access Base Power Infeeds

SIN 711.11

Single-Circuit 20-Amp Plug Base Power Infeed



Tip: The hardwire desktop modules do not work with modular table power kits, therefore, do not require any type of infeeds.

Tip: The plug infeed can only be used with circuit 1 modular table power kits.

Tip: Plug infeed can be used on tables with glides or casters.

Standard Includes	Required to Specify
<ul style="list-style-type: none"> • Single circuit (circuit 1) power infeed with 20-amp plug on one end and male modular connection on the other end: 24" of thick rubber on plug end with coupler attaching 48" of conduit with modular connection • UL recognized 	Style number

Specification Information		
Dimensions Length	Style Number	Price
72"	COBPIFMP20	\$227

Two-Circuit Hardwire Base Power Infeed



Tip: The hardwire desktop modules do not work with modular table power kits, therefore, do not require any type of infeeds.

Tip: The hardwire infeed must be used on tables with glides only.

Standard Includes	Required to Specify
<ul style="list-style-type: none"> • 2 circuit power infeed with 4-wire pigtail for hardwire connection on one end and male modular connection on the other end: flexible steel conduit • UL listed 	Style number

Specification Information		
Dimensions Length	Style Number	Price
72"	COBPIFMH	\$243

Power and Data Access Power Strip

SIN 711.11

Power Strip

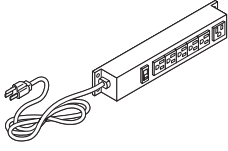

10 1/2"L x 1 3/4"W x 1 1/2"D

Standard Includes

- Power strip with 15' cord and three-prong plug; black
- Six 15-amp power outlets
- On-off switch
- Surge suppressor

Required to Specify

Style number

Specification Information

Style Number	Price
793330	\$256

Power and Data Access Wire Managers

SIN 711.11

Field-Installed Horizontal Wire Manager Channel

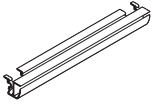

Tip: The wire manager is 1 1/8"W x 2 5/16"H.

Standard Includes	Required to Specify
<ul style="list-style-type: none"> Horizontal wire manager: black plastic Attachment hardware Installation instructions 	Style number

Specification Information		
Dimension Length	Style Number	Price
42"	793442	\$ 89
48"	793448	\$103
60"	793460	\$116
72"	793472	\$132

Vertical Wire Manager

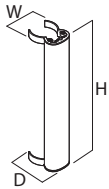

Standard Includes	Required to Specify
<ul style="list-style-type: none"> Vertical wire manager clips onto table leg: extruded aluminum with powder coat color to match leg Clips have three snap-fit features for one power cord and two CAT-5 cables: black plastic 	1 Style number 2 Powder coat color number 3 Options, if selected (see below)

	Options	List Price	Required to Specify
Surface Materials	• 8046 Polished Aluminum	+\$66	Specify with 8046 Polished Aluminum.

Specification Information				
Dimensions			Style Number	Base Price
D	W	H		

For Au Lait

37/8"	27/8"	181/4"	793893	\$131
-------	-------	--------	--------	-------

Training/Multipurpose/ Café Tables

Overview	32
Statement of Line	33

Au Lait (SIN 711.11)	41
Ballet (SIN 711.11)	49
Bob (SIN 711.11)	70
Diekman (SIN 711.11)	73
Enea (SIN 711.11)	75
Lagunitas (SIN 711.11)	80
Millbrae (SIN 711.11)	83
Passerelle (SIN 711.11)	84
Switch (SIN 711.11)	85
Montara650 (SIN 711.11)	87
Train (SIN 711.11)	93

Overview

Café Tables

- Au Lait, page 41
- Ballet, page 49
- Enea, page 75

Cafeteria/Dining/Commons

- Au Lait, page 41
- Ballet, page 49
- Enea, page 75

Training/Multi-Purpose/Classroom

- Ballet, page 49
- Train, page 93

Folding Tables

- Ballet, page 49

Flip-Top Tables

- Au Lait, page 41
- Train, page 93

Statement of Line

Au Lait Tables



Specifying
▶ Page 42

Au Lait 28½"H Round Solid Core Top Café Tables on Standard Height Table

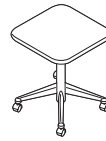
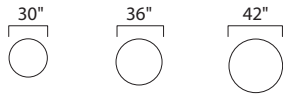

Specifying
▶ Page 44

Au Lait 28½"H Square Solid Core Top Café Tables on Standard Height Table

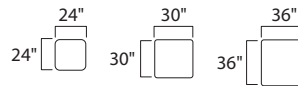

Specifying
▶ Page 46

Au Lait 28½"H Rectangular Solid Core Top Café Tables on Standard Height Table

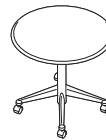
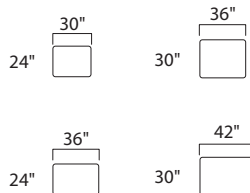

Specifying
▶ Page 42

Au Lait 33"H Round Solid Core Top Café Tables on Wheelchair Height Tables

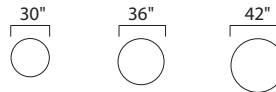

Statement of Line *continued*

Au Lait Tables



Specifying
▶ Page 44

Au Lait 33"H Square Solid Core Top Café Tables on Wheelchair Height Tables

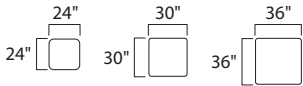

Specifying
▶ Page 46

Au Lait 33"H Rectangular Solid Core Top Café Tables on Wheelchair Height Tables

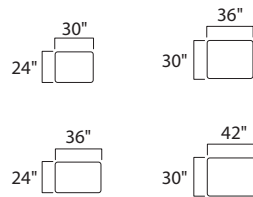

Specifying
▶ Page 42

Au Lait 42"H Round Solid Core Top Café Tables on Café Height Tables

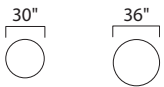

Specifying
▶ Page 44

Au Lait 42"H Square Solid Core Top Café Tables on Café Height Tables

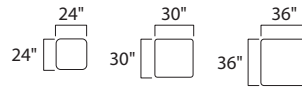

Statement of Line

Ballet Tables

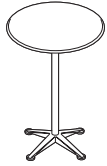

Specifying
▶ Page 50



Folding



Non-Folding

Specifying
▶ Page 51

Ballet Café Tables

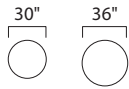

30"

36"

Ballet Arc Tables

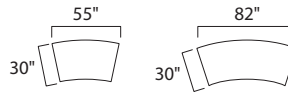

55"

82"

30"

30"

Ballet Non-Folding Side Tables



Round



Racetrack

Specifying
▶ Page 52



Specifying
▶ Page 53

Ballet Round Pedestal Tables (Fixed and Flip Top)

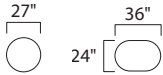

27"

36"

24"

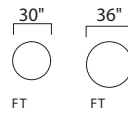

FT

FT

FT = Flip Top



Specifying
▶ Page 54

Ballet Square Pedestal Base Tables (Fixed and Flip Top)

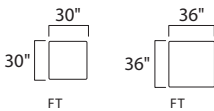

30"

FT

36"

FT

FT = Flip Top

Statement of Line *continued*

Ballet Tables



X- Folding



X- Non-Folding

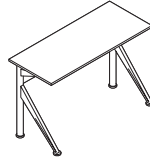

K- Folding

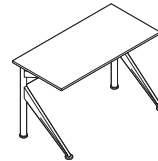

K- Non-Folding

Specifying
▶ Pages 56-64

Ballet Rectangular X- and K-Base Tables

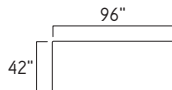
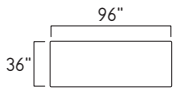
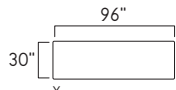
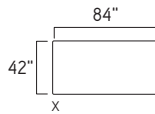
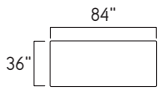
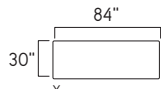
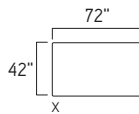
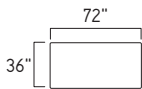
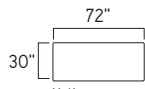
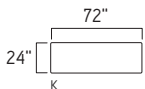
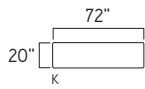
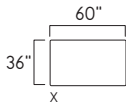
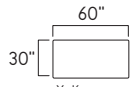
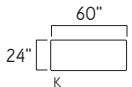
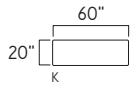
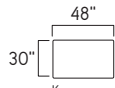
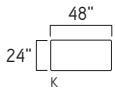
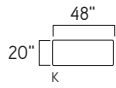

X = X-base
K = K-base



Specifying
▶ Page 67

Ballet Connecting Tops

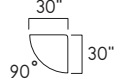
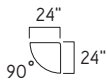
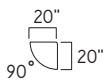

Statement of Line

Bob Tables

24"

30"

36"

42"

Specifying
▶ Page 70



Round Occasional



24"

30"

36"

42"



Round Conference



Training/Multipurpose/
Café Tables

Diekman Tables

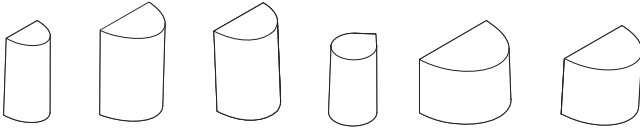

Wood

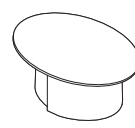

Wood Base with
Elliptical Top

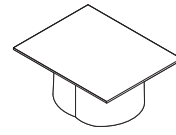

Wood Base with
Rectangle Top

Specifying
▶ Page 73

Statement of Line *continued*

Enea Tables

Enea Single Base Tables

Specifying
▶ Page 76

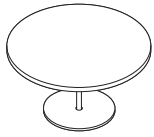

Occasional

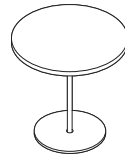
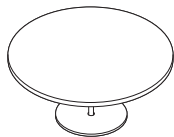

Conference

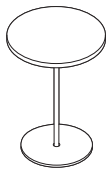
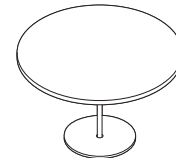
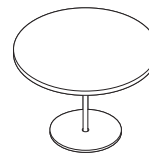

Café/Counter Height

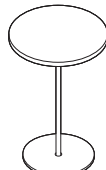
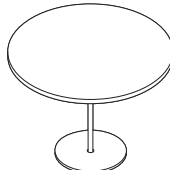
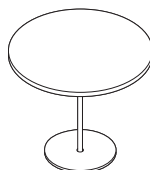
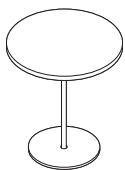

Café/Bar Height

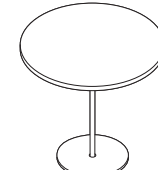
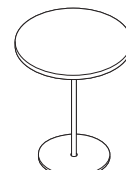

Enea Twin Base Tables

Specifying
▶ Page 78

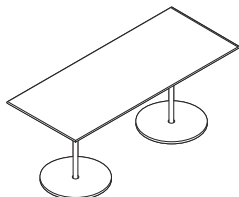

Rectangular

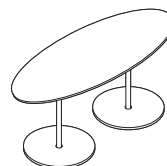
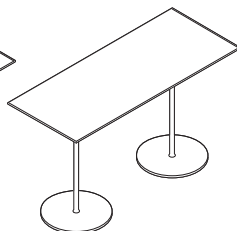
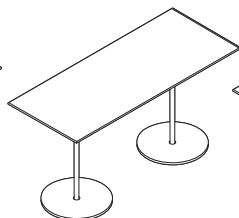

Oval

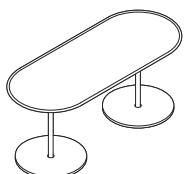
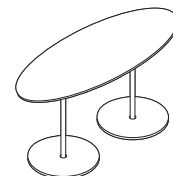
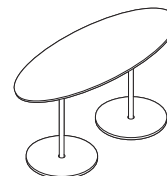

Conference
Racetrack

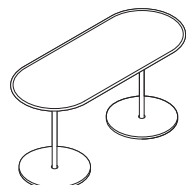

Counter Racetrack

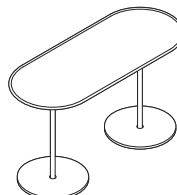

Café Racetrack

Statement of Line

Lagunitas Tables

Specifying
► Pages 80–82

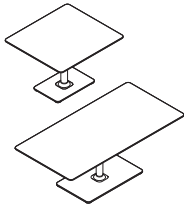

Work Tables

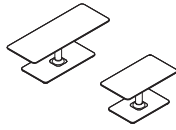

Occasional Tables



Personal Table

Millbrae Occasional Tables

Specifying
► Page 83

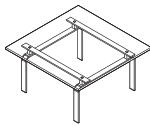

Square Tables

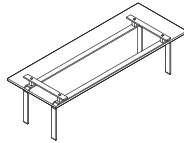

Rectangular Tables

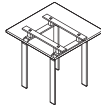

Side Table

Passerelle Occasional Tables

Specifying
► Page 84

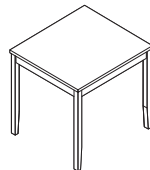
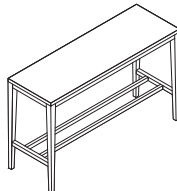
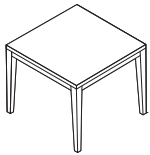

Switch Occasional Tables

Specifying
► Page 85

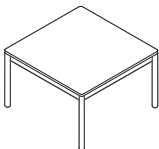

Square

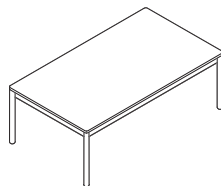

Rectangle

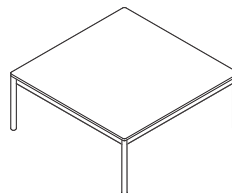

Square Table

Statement of Line *continued*

Specifying
▶ Pages 88-92

Montara650 Tables

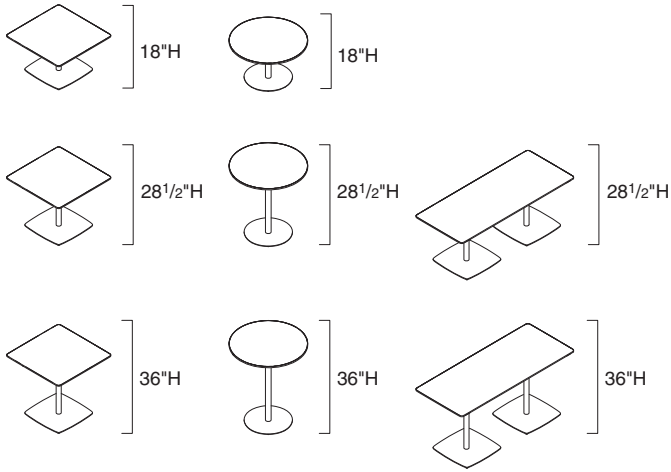

Train Tables

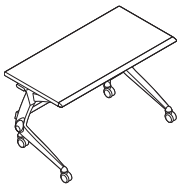

Specifying
▶ Page 94



Specifying
▶ Page 100

Train Rectangular Tables

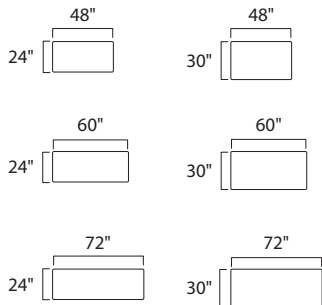

Train Corner Tops

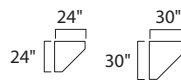

Au Lait

Round Tables with Solid Core Tops (SIN 711.11)	42
Square Tables with Solid Core Tops (SIN 711.11)	44
Rectangular Tables with Solid Core Tops (SIN 711.11)	46
Accessories (SIN 711.11)	48

Au Lait Round Tables with Solid Core Tops

SIN 711.11



Tip: Shipped knocked down.

Standard Includes	Required to Specify
<ul style="list-style-type: none"> ▶ Need help? Product details, see <i>Coalesse Tables, Storage, and Accessories Specification Guide</i>. • Top: 1/4" particle board core with High-Pressure Laminate • Edge: convex vinyl or self-skinning cast urethane • Base: 2 1/2" diameter steel column and glass-filled nylon feet with single textured powder coat • Fixed top with black steel spider • 2 3/8" diameter, locking, dual-wheel casters: black plastic 	<ol style="list-style-type: none"> 1 Style number 2 Textured powder coat color selection for base 3 Laminate color number for top 4 Edge selection: <ul style="list-style-type: none"> - Convex vinyl or cast urethane color number: <ul style="list-style-type: none"> 6000 Black 6607 Woodrose 6609 Smoke 6655 Warm White 5 Options, if selected (see below) <p>▶ See <i>Surface Materials</i>, page 350.</p>

Tip: Glides are the same height as casters. Glides adjust 1/2".

Options	Price	Required to Specify
Surface Materials <ul style="list-style-type: none"> • Top • Grade 2 laminate 	Prices below and at right	Specify with <i>Grade 2 laminate</i> and select
Glides <ul style="list-style-type: none"> • Glides 	No cost	Delete suffix C from the style number.
Related Products <ul style="list-style-type: none"> • Casters • Glides 		<ul style="list-style-type: none"> ▶ Page 48 ▶ Page 48

Specification Information

Dimensions	Style Number	Finish	Prices
Dia H			
			 
			Convex Vinyl Edge: Cast Urethane Edge:



Fixed Top with 28"W Base

30"	28 1/2"	AL3000SC	Grade 1 Laminate	\$735	N.A.
			Grade 2 Laminate	\$766	N.A.
30"	28 1/2"	AL3000USC	Grade 1 Laminate	N.A.	\$1120
			Grade 2 Laminate	N.A.	\$1151
30"	33"	ALW3000SC	Grade 1 Laminate	\$762	N.A.
			Grade 2 Laminate	\$793	N.A.
30"	33"	ALW3000USC	Grade 1 Laminate	N.A.	\$1142
			Grade 2 Laminate	N.A.	\$1173

▶ Specification Information, continued on next page

SIN 711.11

► Specification Information, continued from previous page

Specification Information

Dimensions
Dia H

Style
Number

Finish

Prices



Convex
Vinyl Edge:



Cast Urethane
Edge:



Fixed Top with 28"W Base, continued

Dimensions	Style Number	Finish	Grade 1 Laminate	Grade 2 Laminate	Prices
30" 42"	ALB3000SC	Grade 1 Laminate	\$791	N.A.	
			\$822	N.A.	
30" 42"	ALB3000USC	Grade 1 Laminate	N.A.	\$1173	
			N.A.	\$1204	
36" 28½"	AL3600SC	Grade 1 Laminate	\$786	N.A.	
			\$828	N.A.	
36" 28½"	AL3600USC	Grade 1 Laminate	N.A.	\$1217	
			N.A.	\$1259	
36" 33"	ALW3600SC	Grade 1 Laminate	\$810	N.A.	
			\$852	N.A.	
36" 33"	ALW3600USC	Grade 1 Laminate	N.A.	\$1237	
			N.A.	\$1279	



Fixed Top with 37"W Base

Dimensions	Style Number	Finish	Grade 1 Laminate	Grade 2 Laminate	Prices
42" 28½"	AL4200MC	Grade 1 Laminate	\$832	N.A.	
			\$888	N.A.	
42" 28½"	AL4200UMC	Grade 1 Laminate	N.A.	\$1376	
			N.A.	\$1432	
42" 33"	ALW4200MC	Grade 1 Laminate	\$853	N.A.	
			\$909	N.A.	
42" 33"	ALW4200UMC	Grade 1 Laminate	N.A.	\$1396	
			N.A.	\$1452	
36" 42"	ALB3600MC	Grade 1 Laminate	\$841	N.A.	
			\$883	N.A.	
36" 42"	ALB3600UMC	Grade 1 Laminate	N.A.	\$1267	
			N.A.	\$1309	

Au Lait Square Tables with Solid Core Tops



SIN 711.11

Tip: Shipped knocked down.

Standard Includes	Required to Specify
<ul style="list-style-type: none"> ▶ Need help? Product details, see <i>Coalesse Tables, Storage, and Accessories Specification Guide</i>. • Top: 1/4" particle board core with High-Pressure Laminate • Edge: convex vinyl or self-skinning cast urethane • Base: 2 1/2" diameter steel column and glass-filled nylon feet with single textured powder coat • Fixed top with black steel spider • 2 3/8" diameter, locking, dual-wheel casters: black plastic 	<ol style="list-style-type: none"> 1 Style number 2 Textured powder coat color selection for base 3 Laminate color number for top 4 Edge selection: <ul style="list-style-type: none"> - Convex vinyl or cast urethane color number: <ul style="list-style-type: none"> 6000 Black 6607 Woodrose 6609 Smoke 6655 Warm White 5 Options, if selected (see below) <p>▶ See <i>Surface Materials</i>, page 350.</p>

Tip: Glides are the same height as casters. Glides adjust 1/2".

Options	Price	Required to Specify
Surface Materials <ul style="list-style-type: none"> • Top • Grade 2 laminate 	Prices below and at right	Specify with <i>Grade 2 laminate</i> and select color number.
Glides <ul style="list-style-type: none"> • Glides 	No cost	Delete suffix C from the style number.
Related Products <ul style="list-style-type: none"> • Casters • Glides 		<ul style="list-style-type: none"> ▶ Page 48 ▶ Page 48

Specification Information						
Dimensions			Style	Finish	Prices	
L	W	H	Number			
					 Convex Vinyl Edge:	 Cast Urethane Edge:



Fixed Top with 28"W Base

Dimensions	Style Number	Grade 1 Laminate	Grade 2 Laminate
24" 24" 28 1/2"	AL2424SC	\$710	N.A.
		\$728	N.A.
24" 24" 28 1/2"	AL2424USC	N.A.	\$ 983
		N.A.	\$1001
24" 24" 33"	ALW2424SC	\$733	N.A.
		\$751	N.A.
24" 24" 33"	ALW2424USC	N.A.	\$1008
		N.A.	\$1026
24" 24" 42"	ALB2424SC	\$764	N.A.
		\$782	N.A.
24" 24" 42"	ALB2424USC	N.A.	\$1033
		N.A.	\$1051
30" 30" 28 1/2"	AL3030SC	\$732	N.A.
		\$763	N.A.
30" 30" 28 1/2"	AL3030USC	N.A.	\$1142
		N.A.	\$1173



▶ Specification Information, continued on next page

Au Lait Square Tables with Solid Core Tops

SIN 711.11

► Specification Information, continued from previous page

Specification Information

Dimensions			Style Number	Finish	Prices	
L	W	H			 Convex Vinyl Edge:	 Cast Urethane Edge:



Fixed Top with 28"W Base, continued

30"	30"	33"	ALW3030SC	Grade 1 Laminate	\$757	N.A.
				Grade 2 Laminate	\$788	N.A.
30"	30"	33"	ALW3030USC	Grade 1 Laminate	N.A.	\$1163
				Grade 2 Laminate	N.A.	\$1194



Fixed Top with 37"W Base

36"	36"	28½"	AL3636MC	Grade 1 Laminate	\$803	N.A.
				Grade 2 Laminate	\$845	N.A.
36"	36"	28½"	AL3636UMC	Grade 1 Laminate	N.A.	\$1230
				Grade 2 Laminate	N.A.	\$1272
36"	36"	33"	ALW3636MC	Grade 1 Laminate	\$826	N.A.
				Grade 2 Laminate	\$868	N.A.
36"	36"	33"	ALW3636UMC	Grade 1 Laminate	N.A.	\$1253
				Grade 2 Laminate	N.A.	\$1295
36"	36"	42"	ALB3636MC	Grade 1 Laminate	\$850	N.A.
				Grade 2 Laminate	\$892	N.A.
36"	36"	42"	ALB3636UMC	Grade 1 Laminate	N.A.	\$1281
				Grade 2 Laminate	N.A.	\$1323
30"	30"	42"	ALB3030MC	Grade 1 Laminate	\$782	N.A.
				Grade 2 Laminate	\$813	N.A.
30"	30"	42"	ALB3030UMC	Grade 1 Laminate	N.A.	\$1194
				Grade 2 Laminate	N.A.	\$1225

Au Lait



Au Lait Rectangular Tables with Solid Core Tops

SIN 711.11

Standard Includes		Required to Specify
<ul style="list-style-type: none"> ► Need help? Product details, see <i>Coalesse Tables, Storage, and Accessories Specification Guide</i>. 	<ul style="list-style-type: none"> • Top: 1/4" particle board core with High-Pressure Laminate • Edge: convex vinyl or self-skinning cast urethane • Base: 2 1/2" diameter steel column and glass-filled nylon feet with single textured powder coat • Fixed top with black steel spider • 2 3/8" diameter, locking, dual-wheel casters: black plastic 	<ol style="list-style-type: none"> 1 Style number 2 Textured powder coat color selection for base 3 Laminate color number for top 4 Edge selection: <ul style="list-style-type: none"> - Convex vinyl or cast urethane color number: <ul style="list-style-type: none"> 6000 Black 6607 Woodrose 6609 Smoke 6655 Warm White 5 Options, if selected (see below) <p>► See <i>Surface Materials</i>, page 350.</p>

Options	Price	Required to Specify
Surface Materials <ul style="list-style-type: none"> • Top • Grade 2 laminate 	Prices below and at right	Specify with <i>Grade 2 laminate</i> and select color number.
Glides <ul style="list-style-type: none"> • Glides 	No cost	Delete suffix C from the style number.
Related Products <ul style="list-style-type: none"> • Casters • Glides 		<p>► Page 48</p> <p>► Page 48</p>

Tip: Glides are the same height as casters. Glides adjust 1/2".

Specification Information						
Dimensions			Style Number	Finish	Prices	
L	W	H			Convex Vinyl Edge:	Cast Urethane Edge:
						



Tip: Shipped knocked down.

Fixed Top with 28"W Base

24"	30"	28 1/2"	AL2430SC	Grade 1 Laminate	\$734	N.A.
				Grade 2 Laminate	\$759	N.A.
24"	30"	28 1/2"	AL2430USC	Grade 1 Laminate	N.A.	\$1027
				Grade 2 Laminate	N.A.	\$1052
24"	30"	33"	ALW2430SC	Grade 1 Laminate	\$759	N.A.
				Grade 2 Laminate	\$784	N.A.
24"	30"	33"	ALW2430USC	Grade 1 Laminate	N.A.	\$1051
				Grade 2 Laminate	N.A.	\$1076
24"	36"	28 1/2"	AL2436SC	Grade 1 Laminate	\$754	N.A.
				Grade 2 Laminate	\$784	N.A.
24"	36"	28 1/2"	AL2436USC	Grade 1 Laminate	N.A.	\$1051
				Grade 2 Laminate	N.A.	\$1081
24"	36"	33"	ALW2436SC	Grade 1 Laminate	\$771	N.A.
				Grade 2 Laminate	\$801	N.A.
24"	36"	33"	ALW2436USC	Grade 1 Laminate	N.A.	\$1073
				Grade 2 Laminate	N.A.	\$1103
30"	36"	28 1/2"	AL3036SC	Grade 1 Laminate	\$778	N.A.
				Grade 2 Laminate	\$814	N.A.

► Specification Information, continued on next page

Au Lait Rectangular Tables with Solid Core Tops

SIN 711.11

► Specification Information, continued from previous page

Specification Information

Dimensions			Style Number	Finish	Prices	
L	W	H			Convex Vinyl Edge:	Cast Urethane Edge:



Convex Vinyl Edge:

Cast Urethane Edge:



Fixed Top with 28"W Base, continued

30"	36"	28½"	AL3036USC	Grade 1 Laminate	N.A.	\$1142
				Grade 2 Laminate	N.A.	\$1178
30"	36"	33"	ALW3036SC	Grade 1 Laminate	\$801	N.A.
				Grade 2 Laminate	\$837	N.A.
30"	36"	33"	ALW3036USC	Grade 1 Laminate	N.A.	\$1163
				Grade 2 Laminate	N.A.	\$1199



Fixed Top with 37"W Base

30"	42"	28½"	AL3042MC	Grade 1 Laminate	\$801	N.A.
				Grade 2 Laminate	\$842	N.A.
30"	42"	28½"	AL3042UMC	Grade 1 Laminate	N.A.	\$1181
				Grade 2 Laminate	N.A.	\$1222
30"	42"	33"	ALW3042MC	Grade 1 Laminate	\$823	N.A.
				Grade 2 Laminate	\$864	N.A.
30"	42"	33"	ALW3042UMC	Grade 1 Laminate	N.A.	\$1203
				Grade 2 Laminate	N.A.	\$1244

SIN 711.11

Casters



Standard Includes	Required to Specify
<ul style="list-style-type: none"> Set of four locking casters for field retrofit: black 	Style number

Specification Information

Style Number	Price
ALCASTER	\$151

Glides



Standard Includes	Required to Specify
<ul style="list-style-type: none"> Set of four glides for field retrofit: black 	Style number

Specification Information

Style Number	Price
ALGLIDE	\$151

Vertical Wire Manager

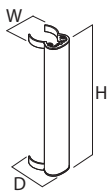

Standard Includes	Required to Specify
<ul style="list-style-type: none"> Vertical wire manager clips onto table leg: extruded aluminum with powder coat color to match leg Clips have three snap-fit features for one power cord and two CAT-5 cables: black plastic 	1 Style number 2 Powder coat color number 3 Options, if selected (see below)

Options	Price	Required to Specify
Surface Materials <ul style="list-style-type: none"> Polished Aluminum 	+\$66	Specify with <i>polished aluminum finish</i> .

Specification Information

Dimensions			Style Number	Base Price
D	W	H		
37/8"	27/8"	181/4"	793893	\$131

Ballet

Round Café Tables (SIN 711.11)	50
Arc Tables (SIN 711.11)	51
Non-Folding Side Tables (SIN 711.11)	52
Round Pedestal Base Tables (SIN 711.11)	53
Square Pedestal Base Tables (SIN 711.11)	54
Rectangular Folding X-Base Tables (SIN 711.11)	56
Rectangular Non-Folding X-Base Tables (SIN 711.11)	58
Rectangular Folding K-Base Tables (SIN 711.11)	60
Rectangular Non-Folding K-Base Tables (SIN 711.11)	64
Connecting Tops (SIN 711.11)	67
Accessories (SIN 711.11)	68

Ballet Round Café Tables

SIN 711.11

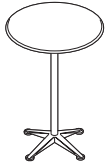

Tip: Shipped knocked down.

Tip: For installation of a grommet or sphere, submit a drawing indicating the desired location for a factory installed cutout. Field installation is also available. Both require the grommet or sphere to be ordered as a separate item.

Standard Includes	Required to Specify
-------------------	---------------------

- | | | |
|--|---|--|
| <ul style="list-style-type: none"> ▶ Need help? Product details, see <i>Coalesse Tables, Storage, and Accessories Specification Guide</i> | <ul style="list-style-type: none"> • Top: 3/4" particle board core with High-Pressure Laminate • Edge: black ribbed vinyl • Base: 2" diameter steel column and 4-prong cast aluminum feet with single powder coat • 19" cast aluminum technology spider • Adjustable leveling glides: non-marring, black plastic | <ul style="list-style-type: none"> 1 Style number 2 Powder coat color number for base 3 Laminate color number for top 4 Options, if selected (see below) ▶ See <i>Surface Materials</i>, page 350 |
|--|---|--|

Options	Price	Required to Specify
---------	-------	---------------------

Surface Materials <ul style="list-style-type: none"> • Grade 2 laminate 	Prices below	Specify with <i>Grade 2 laminate</i> and select color number.
--	--------------	---

Specification Information			
Dimensions	Style Number	Finish	Prices

Dimensions	Style Number	Finish	Prices
Dia H			
			Ballet Ribbed Vinyl Edge:
30" 41½"	933421T		Grade 1 Laminate \$ 928
			Grade 2 Laminate \$ 962
36" 41½"	934422T		Grade 1 Laminate \$1056
			Grade 2 Laminate \$1102

Ballet Arc Tables

SIN 711.11

Tip: Shipped knocked down.

Tip: For installation of a grommet or sphere, submit a drawing indicating the desired location for a factory installed cutout. Field installation is also available. Both require the grommet or sphere to be ordered as a separate item.

Standard Includes	Required to Specify
<ul style="list-style-type: none"> ▶ Need help? Product details, see <i>Coalesse Tables, Storage, and Accessories Specification Guide</i> • Top: 1" particle board core with High-Pressure Laminate • Edge: black ribbed vinyl with matching plastic corner inserts • X-base: cast aluminum legs and 1" x 3" extruded aluminum stretcher bar between legs with single powder coat color • Threaded inserts in underside of top for end-to-end ganging • Leveling glides: non-marring, black plastic 	<ul style="list-style-type: none"> 1 Style number 2 Powder coat color number for base 3 Laminate color number for top 4 Options, if selected (see below) ▶ See <i>Surface Materials</i>, page 350

Options	Price	Required to Specify
Surface Materials <ul style="list-style-type: none"> • Grade 2 laminate 	Prices below	Specify with <i>Grade 2 laminate</i> and select color number.
Related Products <ul style="list-style-type: none"> • Bar ganger package • Powerstrip 		<ul style="list-style-type: none"> ▶ Page 68 ▶ Page 68

Specification Information

Dimensions			Style	Finish	Price
L	W	H	Number		
					 <p>Ballet Ribbed Vinyl Edge:</p>



Folding Arc Tables

55"	30"	28½"	915415	Grade 1 Laminate	\$2182
				Grade 2 Laminate	\$2234
82"	30"	28½"	916416	Grade 1 Laminate	\$2368
				Grade 2 Laminate	\$2448

Non-Folding Arc Tables

55"	30"	28½"	915405	Grade 1 Laminate	\$1859
				Grade 2 Laminate	\$1911
82"	30"	28½"	916406	Grade 1 Laminate	\$1968
				Grade 2 Laminate	\$2048

Ballet Non-Folding Side Tables

SIN 711.11

Tip: Shipped knocked down.

Standard Includes		Required to Specify
<ul style="list-style-type: none"> ▶ Need help? Product details, see <i>Coalesse Tables, Storage, and Accessories Specification Guide</i> 	<ul style="list-style-type: none"> • Top: 3/4" particle board core with High-Pressure Laminate • Edge: black ribbed vinyl • Pedestal base: aluminum with powder coat • 19" cast aluminum technology spider • 2" diameter, locking, dual-wheel casters: black plastic 	<ol style="list-style-type: none"> 1 Style number 2 Powder coat color number for base 3 Laminate color number for top 4 Options, if selected (see below) <ul style="list-style-type: none"> ▶ See <i>Surface Materials</i>, page 350

Tip: When specifying glides height of table does not change.

Tip: For installation of a grommet or sphere, submit a drawing indicating the desired location for a factory installed cutout. Field installation is also available. Both require the grommet or sphere to be ordered as a separate item.

Options	Price	Required to Specify
Surface Materials <ul style="list-style-type: none"> • Top • Grade 2 laminate 	Prices below	Specify with <i>Grade 2 laminate</i> and select color number.
Glides <ul style="list-style-type: none"> • Leveling glides in place of casters: non-marring, black plastic 	-\$161	Delete suffix C from the style number.

Specification Information			
Dimensions	Style Number	Finish	Base Price
Dia H			 <p>Ballet Ribbed Vinyl Edge:</p>



Round Table

Dimensions	Style Number	Finish	Base Price
27" 25 1/2"	919423C	Grade 1 Laminate	\$851
		Grade 2 Laminate	\$882



Racetrack Table

Dimensions	Style Number	Finish	Base Price
36" 25 1/2"	920424C	Grade 1 Laminate	\$957
		Grade 2 Laminate	\$988

Ballet Round Pedestal Base Tables

SIN 711.11



Tip: Special table height available, call customer service for quote.

Tip: Shipped knocked down.

Tip: When specifying casters height of table does not change.

Tip: For installation of a grommet or sphere, submit a drawing indicating the desired location for a factory installed cutout. Field installation is also available. Both require the grommet or sphere to be ordered as a separate item.

Standard Includes		Required to Specify
<ul style="list-style-type: none"> ▶ Need help? Product details, see <i>Coalesse Tables, Storage, and Accessories Specification Guide</i> 	<ul style="list-style-type: none"> • Top: 3/4" particle board core with High-Pressure Laminate • Edge: black ribbed vinyl • Base: 2" diameter steel column and 4-prong cast aluminum feet with single powder coat • 19" cast aluminum technology spider • Adjustable leveling glides: non-marring, black plastic 	<ul style="list-style-type: none"> 1 Style number 2 Powder coat color number for base 3 Laminate or wood color number for top 4 Options, if selected (see below) ▶ See <i>Surface Materials</i>, page 350

Options	Price	Required to Specify
Surface Materials <ul style="list-style-type: none"> • Top • Grade 2 laminate 	Prices below	Specify with <i>Grade 2 laminate</i> and select color number.
Flip top <ul style="list-style-type: none"> • Flip top on tables 	+\$168	Add suffix F to the style number.
Casters <ul style="list-style-type: none"> • 2" diameter, locking, dual-wheel casters in place of leveling glides: black plastic 	+\$161	Add suffix C to the style number.

Specification Information			
Dimensions	Style Number	Finish	Base Price
Dia H	933421	Grade 1 Laminate	\$ 861
		Grade 2 Laminate	\$ 892
36" 28½"	934421	Grade 1 Laminate	\$ 959
		Grade 2 Laminate	\$1001



Ballet Ribbed Vinyl Edge:

Ballet

Ballet Square Pedestal Base Tables

SIN 711.11



Tip: Special table height available, call customer service for quote.

Tip: Shipped knocked down.

Tip: When specifying casters height of table does not change.

Tip: For installation of a grommet or sphere, submit a drawing indicating the desired location for a factory installed cutout. Field installation is also available. Both require the grommet or sphere to be ordered as a separate item.

Standard Includes		Required to Specify
<ul style="list-style-type: none"> ▶ Need help? Product details, see <i>Coalesse Tables, Storage, and Accessories Specification Guide</i> 	<ul style="list-style-type: none"> • Top: 1" particle board core with High-Pressure Laminate • Edge: black ribbed vinyl with matching plastic corner inserts • Base: 2" diameter steel column and 4-prong cast aluminum feet with single powder coat • 19" cast aluminum technology spider • Adjustable leveling glides: non-marring, black plastic 	<ul style="list-style-type: none"> 1 Style number 2 Powder coat color number for base 3 Laminate color number for top 4 Options, if selected (see below) ▶ See <i>Surface Materials</i>, page 350

Options	Price	Required to Specify
Surface Materials <ul style="list-style-type: none"> • Top • Grade 2 laminate 	Prices below	Specify with <i>Grade 2 laminate</i> and select color number.
Flip top <ul style="list-style-type: none"> • Flip top on tables 	+\$168	Add suffix F to the style number.
Casters <ul style="list-style-type: none"> • 2" diameter, locking, dual-wheel casters in place of leveling glides: black plastic 	+\$161	Add suffix C to the style number.

Specification Information					
Dimensions			Style Number	Finish	Base Prices
L	W	H			
30"	30"	28½"	926421	Grade 1 Laminate	\$ 925
					Grade 2 Laminate
36"	36"	28½"	927422	Grade 1 Laminate	\$1012
					Grade 2 Laminate



Ballet Ribbed Vinyl Edge:

Coalesse

Ballet Square Pedestal Base Tables

SIN 711.11

Ballet

Ballet Rectangular Folding X-Base Tables

SIN 711.11

Tip: Shipped assembled.

Tip: For installation of grommets or spheres, Mini-Port, Interport, and/or Interact, submit a drawing indicating the desired location for a factory installed cutout(s). Field installation is also available. All require the grommet(s) or sphere(s) to be ordered as a separate item.

Standard Includes		Required to Specify
<ul style="list-style-type: none"> ▶ Need help? Product details, see <i>Coalesse Tables, Storage, and Accessories Specification Guide</i> 	<ul style="list-style-type: none"> • Top: 1" multi-ply wood core with High-Pressure Laminate • Edge: black ribbed vinyl with matching plastic corner inserts • X-base: cast aluminum legs and 1" x 3" extruded aluminum stretcher bar between legs with single powder coat color • Modesty panel with horizontal wire management trough, if selected: extruded aluminum with powder coat color • Threaded inserts in underside of top for end-to-end ganging • Adjustable leveling glides: non-marring, black plastic 	<ol style="list-style-type: none"> 1 Style number 2 Powder coat color number for base 3 Laminate color number for top 4 Powder coat color number for modesty panel, if selected 5 Options, if selected (see below) <p>▶ See <i>Surface Materials</i>, page 350</p>

Options	Price	Required to Specify
Surface Materials <ul style="list-style-type: none"> • Top • Grade 2 laminate 	Prices below and at right	Specify with <i>Grade 2 laminate</i> and select laminate color number.
Related Products <ul style="list-style-type: none"> • Bar ganger package • Power strips 		<ul style="list-style-type: none"> ▶ Page 68 ▶ Page 68

Specification Information					
Dimensions			Style	Finish	Price
L	W	H	Number		
					 <p>Ballet Ribbed Vinyl Edge:</p>

30"W Rectangular Folding X-Base Tables



Without Modesty Panel					
60"	30"	28½"	853411	Grade 1 Laminate	\$1709
				Grade 2 Laminate	\$1765
72"	30"	28½"	854412	Grade 1 Laminate	\$1756
				Grade 2 Laminate	\$1824
84"	30"	28½"	855413	Grade 1 Laminate	\$1986
				Grade 2 Laminate	\$2067
96"	30"	28½"	856414	Grade 1 Laminate	\$2085
				Grade 2 Laminate	\$2175



With Modesty Panel					
60"	30"	28½"	853461	Grade 1 Laminate	\$2138
				Grade 2 Laminate	\$2194
72"	30"	28½"	854462	Grade 1 Laminate	\$2197
				Grade 2 Laminate	\$2265
84"	30"	28½"	855463	Grade 1 Laminate	\$2434
				Grade 2 Laminate	\$2515
96"	30"	28½"	856464	Grade 1 Laminate	\$2539
				Grade 2 Laminate	\$2629

▶ Specification Information, continued on next page

Ballet Rectangular Folding X-Base Tables

SIN 711.11

► Specification Information, continued from previous page

Specification Information

Dimensions			Style Number	Finish	Price
L	W	H			
					 <p>Ballet Ribbed Vinyl Edge:</p>

36"W Rectangular Folding X-Base Tables



Without Modesty Panel

60"	36"	28½"	823411	Grade 1 Laminate	\$1795
				Grade 2 Laminate	\$1863
72"	36"	28½"	824412	Grade 1 Laminate	\$1829
				Grade 2 Laminate	\$1911
84"	36"	28½"	825413	Grade 1 Laminate	\$2030
				Grade 2 Laminate	\$2124
96"	36"	28½"	826414	Grade 1 Laminate	\$2197
				Grade 2 Laminate	\$2305



With Modesty Panel

60"	36"	28½"	823461	Grade 1 Laminate	\$2222
				Grade 2 Laminate	\$2290
72"	36"	28½"	824462	Grade 1 Laminate	\$2270
				Grade 2 Laminate	\$2352
84"	36"	28½"	825463	Grade 1 Laminate	\$2475
				Grade 2 Laminate	\$2569
96"	36"	28½"	826464	Grade 1 Laminate	\$2657
				Grade 2 Laminate	\$2765

42"W Rectangular Folding X-Base Tables



Without Modesty Panel

72"	42"	28½"	814412	Grade 1 Laminate	\$2367
				Grade 2 Laminate	\$2461
84"	42"	28½"	815413	Grade 1 Laminate	\$2406
				Grade 2 Laminate	\$2518
96"	42"	28½"	816414	Grade 1 Laminate	\$2485
				Grade 2 Laminate	\$2610



With Modesty Panel

72"	42"	28½"	814462	Grade 1 Laminate	\$2789
				Grade 2 Laminate	\$2883
84"	42"	28½"	815463	Grade 1 Laminate	\$2851
				Grade 2 Laminate	\$2963
96"	42"	28½"	816464	Grade 1 Laminate	\$2944
				Grade 2 Laminate	\$3069

Ballet Rectangular Non-Folding X-Base Tables

SIN 711.11

Tip: Shipped knocked down.

Tip: For installation of grommets, spheres, Mini-Port, Interport, and/or Interact, Axil Z, or Ellora, submit a drawing indicating the desired location for a factory installed cutout(s). Field installation is also available. All require the grommet(s), sphere(s), Mini-Port, Interport, and/or Interact, Axil Z, or Ellora to be ordered as a separate item.

Standard Includes

- ▶ Need help? Product details, see *Coalesse Tables, Storage, and Accessories Specification Guide*
- Top: 1" MDF core with High-Pressure Laminate
- Edge: black ribbed vinyl with matching plastic corner inserts
- X-base: cast aluminum legs and 1" x 3" extruded aluminum stretcher bar between legs with single powder coat color
- Modesty panel with horizontal wire management trough, if selected: extruded aluminum with powder coat
- Threaded inserts in underside of top for end-to-end ganging
- Adjustable leveling glides: non-marring, black plastic

Required to Specify

- 1 Style number
 - 2 Powder coat color number for base
 - 3 Laminate color number for top
 - 4 Powder coat color number for modesty panel, if selected
 - 5 Options, if selected (see below)
- ▶ See *Surface Materials*, page 350

Options

Options	Price
Surface Materials	
• Top	
• Grade 2 laminate	Prices below and at right

Required to Specify

Specify with *Grade 2 laminate* and select color number.

Related Products • Bar ganger package ▶ Page 68

Specification Information

Dimensions			Style	Finish	Prices
L	W	H	Number		
					
					Ballet Ribbed Vinyl Edge:

30"W Rectangular Non-Folding X-Base Tables

Without Modesty Panel

60"	30"	28½"	873401	Grade 1 Laminate	\$1603
				Grade 2 Laminate	\$1659
72"	30"	28½"	874402	Grade 1 Laminate	\$1654
				Grade 2 Laminate	\$1722
84"	30"	28½"	875403	Grade 1 Laminate	\$1880
				Grade 2 Laminate	\$1961
96"	30"	28½"	876404	Grade 1 Laminate	\$1981
				Grade 2 Laminate	\$2071

With Modesty Panel

60"	30"	28½"	873451	Grade 1 Laminate	\$2033
				Grade 2 Laminate	\$2089
72"	30"	28½"	874452	Grade 1 Laminate	\$2090
				Grade 2 Laminate	\$2158
84"	30"	28½"	875453	Grade 1 Laminate	\$2331
				Grade 2 Laminate	\$2412
96"	30"	28½"	876454	Grade 1 Laminate	\$2436
				Grade 2 Laminate	\$2526

▶ Specification Information, continued on next page



Ballet Rectangular Non-Folding X-Base Tables

SIN 711.11

► Specification Information, continued from previous page

Specification Information

Dimensions			Style Number	Finish	Prices
L	W	H			
					
					Ballet Ribbed Vinyl Edge:

36"W Rectangular Non-Folding X-Base Tables

Without Modesty Panel

60"	36"	28½"	883401	Grade 1 Laminate	\$1688
				Grade 2 Laminate	\$1756
72"	36"	28½"	884402	Grade 1 Laminate	\$1724
				Grade 2 Laminate	\$1806
84"	36"	28½"	885403	Grade 1 Laminate	\$1924
				Grade 2 Laminate	\$2018
96"	36"	28½"	886404	Grade 1 Laminate	\$2090
				Grade 2 Laminate	\$2198

With Modesty Panel

60"	36"	28½"	883451	Grade 1 Laminate	\$2117
				Grade 2 Laminate	\$2185
72"	36"	28½"	884452	Grade 1 Laminate	\$2161
				Grade 2 Laminate	\$2243
84"	36"	28½"	885453	Grade 1 Laminate	\$2374
				Grade 2 Laminate	\$2468
96"	36"	28½"	886454	Grade 1 Laminate	\$2551
				Grade 2 Laminate	\$2659

42"W Rectangular Non-Folding X-Base Tables

Without Modesty Panel

72"	42"	28½"	834402	Grade 1 Laminate	\$2245
				Grade 2 Laminate	\$2339
84"	42"	28½"	835403	Grade 1 Laminate	\$2299
				Grade 2 Laminate	\$2411
96"	42"	28½"	836404	Grade 1 Laminate	\$2380
				Grade 2 Laminate	\$2505

With Modesty Panel

72"	42"	28½"	834452	Grade 1 Laminate	\$2682
				Grade 2 Laminate	\$2776
84"	42"	28½"	835453	Grade 1 Laminate	\$2751
				Grade 2 Laminate	\$2863
96"	42"	28½"	836454	Grade 1 Laminate	\$2841
				Grade 2 Laminate	\$2966



Ballet Rectangular Folding K-Base Tables

SIN 711.11



Tip: Shipped assembled.

	Standard Includes	Required to Specify
<p>► Need help? Product details, see <i>Coalesse Tables, Storage, and Accessories Specification Guide</i></p>	<ul style="list-style-type: none"> • Top: 1" multi-ply wood core with High-Pressure Laminate • Edge: black vinyl with matching plastic corner inserts • K-base: cast aluminum legs and 1" x 3" extruded aluminum stretcher bar between legs with single powder coat • Modesty panel with horizontal wire management trough, if selected: extruded aluminum with powder coat • Threaded inserts in underside of top for end-to-end ganging • Adjustable leveling glides: non-marring, black plastic 	<ol style="list-style-type: none"> 1 Style number 2 Powder coat color number for base 3 Laminate color number for top 4 Powder coat color number for modesty panel, if selected 5 Options, if selected (see below) <p>► See <i>Surface Materials</i>, page 350</p>

	Options	Price	Required to Specify
Surface Materials	<p>Top</p> <ul style="list-style-type: none"> • Grade 2 laminate 	Prices at right	Specify with <i>Grade 2 laminate</i> and select laminate color number.
Grommets	<ul style="list-style-type: none"> • One grommet: black plastic • Two grommets: black plastic • Three grommets: black plastic 	<p>+\$ 70</p> <p>+\$140</p> <p>+\$210</p>	<p>Specify with <i>grommet</i> and select location of left, right, or center.</p> <p>Specify with <i>two grommets</i> and select location of left/center, right/center, or right/left.</p> <p>Specify with <i>three grommets</i>.</p>
Spheres	<p>Factory-installed opening and sphere to be installed on site: black plastic only</p> <ul style="list-style-type: none"> • CSP = Four data jack locations • PCS = Two simplex power outlets and two data jack locations • PSP = Four simplex power 	<p>+\$176 each</p> <p>+\$269 each</p> <p>+\$390 each</p>	<p>Specify with <i>CSP sphere</i> and select location of left, right, or center.</p> <p>Specify with <i>PCS sphere</i> and select location of left, right, or center.</p> <p>Specify with <i>PSP sphere</i> and select location of left, right, or center.</p>
Casters	<ul style="list-style-type: none"> • 2" diameter, locking, dual-wheel casters in place of leveling glides on back legs of tables: black plastic only 	+\$ 70	Add suffix C to the style number.
Related Products	<ul style="list-style-type: none"> • Bar ganger package • Power strips • Spheres 		<p>► Page 68</p> <p>► Page 68</p> <p>► Page 21</p>

Tip: When three grommets are specified, grommets will be located left, right, and center.

Tip: For sphere location availability, see *Coalesse Tables, Storage, and Accessories Specification Guide*.

Tip: If *RJ11* or *RJ45* data jack couplers are needed on *PCS* or *CSP* they must be ordered separately.

Tip: When specifying casters, height of table does not change.

Ballet Rectangular Folding K-Base Tables

SIN 711.11

Specification Information

Dimensions			Style	Finish	Base Price
L	W	H	Number		
					
					Ballet Ribbed Vinyl Edge:

20"W Rectangular Folding K-Base Tables

Without Modesty Panel

48"	20"	28½"	842511	Grade 1 Laminate	\$1590
				Grade 2 Laminate	\$1621
60"	20"	28½"	843512	Grade 1 Laminate	\$1684
				Grade 2 Laminate	\$1722
72"	20"	28½"	844513	Grade 1 Laminate	\$1729
				Grade 2 Laminate	\$1773

With Modesty Panel

48"	20"	28½"	842561	Grade 1 Laminate	\$2030
				Grade 2 Laminate	\$2061
60"	20"	28½"	843562	Grade 1 Laminate	\$2132
				Grade 2 Laminate	\$2170
72"	20"	28½"	844563	Grade 1 Laminate	\$2188
				Grade 2 Laminate	\$2232

24"W Rectangular Folding K-Base Tables

Without Modesty Panel

48"	24"	28½"	802511	Grade 1 Laminate	\$1634
				Grade 2 Laminate	\$1670
60"	24"	28½"	803512	Grade 1 Laminate	\$1724
				Grade 2 Laminate	\$1768
72"	24"	28½"	804513	Grade 1 Laminate	\$1773
				Grade 2 Laminate	\$1828

With Modesty Panel

48"	24"	28½"	802561	Grade 1 Laminate	\$2071
				Grade 2 Laminate	\$2107
60"	24"	28½"	803562	Grade 1 Laminate	\$2172
				Grade 2 Laminate	\$2216
72"	24"	28½"	804563	Grade 1 Laminate	\$2232
				Grade 2 Laminate	\$2285

► Specification Information, continued on next page

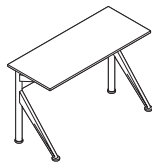

Ballet Rectangular Folding K-Base Tables *continued*

SIN 711.11

► Specification Information, continued from previous page

Specification Information

Dimensions			Style	Finish	Base Price
L	W	H	Number		
					
					Ballet Ribbed Vinyl Edge:

30"W Rectangular Folding K-Base Tables

Without Modesty Panel

48"	30"	28½"	902511	Grade 1 Laminate	\$2038
				Grade 2 Laminate	\$2082
60"	30"	28½"	903512	Grade 1 Laminate	\$2155
				Grade 2 Laminate	\$2211
72"	30"	28½"	904513	Grade 1 Laminate	\$2411
				Grade 2 Laminate	\$2479

With Modesty Panel

48"	30"	28½"	902561	Grade 1 Laminate	\$2477
				Grade 2 Laminate	\$2521
60"	30"	28½"	903562	Grade 1 Laminate	\$2601
				Grade 2 Laminate	\$2657
72"	30"	28½"	904563	Grade 1 Laminate	\$2871
				Grade 2 Laminate	\$2939

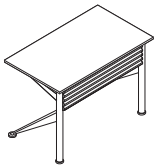

Coalesse

Ballet Rectangular Folding K-Base Tables

SIN 711.11

Ballet

Ballet Rectangular Non-Folding K-Base Tables

SIN 711.11



Tip: Shipped knocked down.

	Standard Includes	Required to Specify
► Need help? Product details, see <i>Coalesse Tables, Storage, and Accessories Specification Guide</i>	<ul style="list-style-type: none"> • Top: 1" MDF core with High-Pressure Laminate • Edge: black ribbed vinyl with matching plastic corner inserts • K-base: cast aluminum legs and 1" x 3" extruded aluminum stretcher bar between legs with single powder coat • Threaded inserts in underside of top for end-to-end ganging • Adjustable leveling glides: non-marring, black plastic 	<ol style="list-style-type: none"> 1 Style number 2 Powder coat color number for base 3 Laminate color number for top 4 Options, if selected (see below) <p>► See <i>Surface Materials</i>, page 350</p>

Tip: When three grommets are specified, grommets will be located left, right, and center.

Tip: For sphere location availability, see *Coalesse Tables, Storage, and Accessories Specification Guide*.

Tip: If RJ11 or RJ45 data jack couplers are needed on PCS or CSP they must be ordered separately.

Tip: When specifying casters, height of table does not change.

Tip: For installation of Mini-Port, Interport or Interact, Axil Z, or Ellora, submit a drawing indicating the desired location for a factory installed cutout(s). Mini-Port, Interport and/or Interact, Axil Z, or Ellora to be ordered as a separate item.

	Options	Price	Required to Specify
Surface Materials	Top <ul style="list-style-type: none"> • Grade 2 laminate 	Prices at right	Specify with <i>Grade 2 laminate</i> and select color number.
Grommets	<ul style="list-style-type: none"> • One grommet: black plastic • Two grommets: black plastic • Three grommets: black plastic 	+\$ 70 +\$140 +\$210	Specify with <i>grommet</i> and select location of left, right, or center. Specify with <i>two grommets</i> and select location of left/center, right/center, or right/left. Specify with three grommets.
Spheres	Factory-installed opening and sphere to be installed on site: black plastic only <ul style="list-style-type: none"> • CSP = Four data jack locations • PCS = Two simplex power outlets and two data jack locations • PSP = Four simplex power 	+\$176 each +\$269 each +\$390 each	Specify with <i>CSP sphere</i> and select location of left, right, or center. Specify with <i>PCS sphere</i> and select location of left, right, or center. Specify with <i>PSP sphere</i> and select location of left, right, or center.
Casters	<ul style="list-style-type: none"> • 2" diameter, locking, dual-wheel casters in place of leveling glides on back legs of tables: black plastic only 	+\$ 70	Add suffix C to the style number.
Related Products	<ul style="list-style-type: none"> • Bar ganger package • Power strips • Spheres 		► Page 68 ► Page 68 ► Page 21

Ballet Rectangular Non-Folding K-Base Tables

SIN 711.11

Specification Information

Dimensions			Style Number	Finish	Base Prices
L	W	H			
					
					Ballet Ribbed Vinyl Edge:

20"W Rectangular Non-Folding K-Base Tables

Without Modesty Panel

48"	20"	28½"	892501	Grade 1 Laminate	\$1538
				Grade 2 Laminate	\$1570
60"	20"	28½"	893502	Grade 1 Laminate	\$1634
				Grade 2 Laminate	\$1673
72"	20"	28½"	894503	Grade 1 Laminate	\$1676
				Grade 2 Laminate	\$1720

With Modesty Panel

48"	20"	28½"	892551	Grade 1 Laminate	\$1980
				Grade 2 Laminate	\$2012
60"	20"	28½"	893552	Grade 1 Laminate	\$2081
				Grade 2 Laminate	\$2120
72"	20"	28½"	894553	Grade 1 Laminate	\$2139
				Grade 2 Laminate	\$2183

24"W Rectangular Non-Folding K-Base Tables

Without Modesty Panel

48"	24"	28½"	862501	Grade 1 Laminate	\$1581
				Grade 2 Laminate	\$1619
60"	24"	28½"	863502	Grade 1 Laminate	\$1671
				Grade 2 Laminate	\$1715
72"	24"	28½"	864503	Grade 1 Laminate	\$1720
				Grade 2 Laminate	\$1773

With Modesty Panel

48"	24"	28½"	862551	Grade 1 Laminate	\$2019
				Grade 2 Laminate	\$2057
60"	24"	28½"	863552	Grade 1 Laminate	\$2123
				Grade 2 Laminate	\$2167
72"	24"	28½"	864553	Grade 1 Laminate	\$2182
				Grade 2 Laminate	\$2235

► Specification Information, continued on next page



Ballet Rectangular Non-Folding K-Base Tables *continued*

SIN 711.11

► Specification Information, continued from previous page

Specification Information

Dimensions			Style Number	Finish	Base Prices
L	W	H			



Ballet Ribbed Vinyl Edge:

30"W Rectangular Non-Folding K-Base Tables

Without Modesty Panel

48"	30"	28½"	912501	Grade 1 Laminate	\$ 1986
				Grade 2 Laminate	\$2030
60"	30"	28½"	913502	Grade 1 Laminate	\$2100
				Grade 2 Laminate	\$ 2156
72"	30"	28½"	914503	Grade 1 Laminate	\$2360
				Grade 2 Laminate	\$2428

With Modesty Panel

48"	30"	28½"	912551	Grade 1 Laminate	\$2427
				Grade 2 Laminate	\$ 2471
60"	30"	28½"	913552	Grade 1 Laminate	\$2551
				Grade 2 Laminate	\$2607
72"	30"	28½"	914553	Grade 1 Laminate	\$ 2819
				Grade 2 Laminate	\$2887



Ballet Connecting Tops

SIN 711.11



Standard Includes		Required to Specify
<ul style="list-style-type: none"> ▶ Need help? Product details, see <i>Coalesse Tables, Storage, and Accessories Specification Guide</i> 	<ul style="list-style-type: none"> • Top: 1" MDF core with High-Pressure Laminate • Edge: black ribbed vinyl with matching plastic corner inserts • Connecting hardware to attach to adjacent tables 	<ul style="list-style-type: none"> 1 Style number 2 Laminate color number for top 3 Options, if selected (see below) ▶ See <i>Surface Materials</i>, page 350

Options	Price	Required to Specify
Surface Materials <ul style="list-style-type: none"> • Top Grade 2 laminate 	Prices below	Specify with <i>Grade 2 laminate</i> and select laminate color number.

Specification Information			
Dimension	Style Number	Finish	Price
Width			 Ballet Ribbed Vinyl Edge:

90° Connecting Tops

Dimension	Style Number	Finish	Price
20"	849000	Grade 1 Laminate	\$544
		Grade 2 Laminate	\$582
24"	809000	Grade 1 Laminate	\$587
		Grade 2 Laminate	\$625
30"	909000	Grade 1 Laminate	\$662
		Grade 2 Laminate	\$700

Ballet Accessories

SIN 711.11

Power Strip

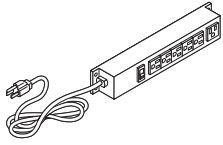

Standard Includes	Required to Specify
<ul style="list-style-type: none"> • Power strip with 15' cord and three-prong plug; black • Six power outlets • On-off switch • Surge suppressor 	Style number

Specification Information					
Dimensions			Style	Price	
L	D	W	Number		
16"	3/4"	2 1/4"	793330	\$256	

Vertical Wire Manager



Standard Includes	Required to Specify
<ul style="list-style-type: none"> • Vertical wire manager to attach to Ballet K-legs; black plastic only 	Style number

Specification Information					
Dimensions			Style	Price	
L	D	W	Number		
3/4"	1"	17"	793332	\$32	

Bar Ganger Package

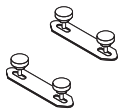

Standard Includes	Required to Specify
<ul style="list-style-type: none"> • Two field-installed steel bars and four threaded hand knobs; black steel only 	Style number

Specification Information	
Style	Price
Number	
793335	\$56

Ballet Accessories

SIN 711.11

Mobile Storage Cart

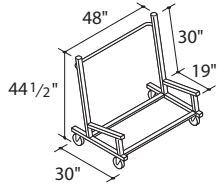

Tip: Shipped knocked down.

Tip: Mobile storage cart accommodates folding Ballet tables of lengths from 48"-72" and widths up to 42". Folded height is 35/8".

Standard Includes	Required to Specify
<ul style="list-style-type: none"> • Cart to accommodate up to five folding Ballet tables: black only • Bumpers: black 	Style number

Specification Information

Style Number	Price
45"L to Accommodate 48"L, 60"L, or 72"L Tables	
793333	\$2197

Ballet

Bob Tables

DESIGN PEARSON LLOYD

SIN 711.11

Tip: Glass tops are 1/2" thick, except for the absolute clear frosted glass, which is 1/16" thick. 1/32" chamfers are applied to top and bottom edges.

Standard Includes		Required to Specify
<p>► Need help? Product details, see <i>Coalesse Tables, Storage, and Accessories Specification Guide</i></p> <ul style="list-style-type: none"> • Base: 8040 Aluminum Matte Polished or grade 1 paint • Top: clear green glass • Glides 	<ul style="list-style-type: none"> 1 Style number 2 Paint or metal color number for base 3 Color number for top 4 Options, if selected (see below) <p>► See <i>Surface Materials</i>, page 350</p>	

Options	Price	Required to Specify
<p>Surface Materials</p> <p>Base</p> <ul style="list-style-type: none"> • Aluminum matte polished • Grade 1 paint • Grade 3 paint 	<p>No cost</p> <p>No cost</p> <p>+\$105</p>	<p>Specify aluminum matte polished.</p> <p>Specify paint color number.</p> <p>Specify paint color number.</p>
<p>Glides</p> <ul style="list-style-type: none"> • Felted glides 	<p>+\$ 16</p>	<p>Specify <i>with felted glides</i>.</p>
<p>Related Products</p> <ul style="list-style-type: none"> • Bob seating 		<p>► See <i>GSA Volume 5a Specification Guide</i>.</p>

Specification Information

Dimensions Height	Style Number	Top Surface	Base Prices	Dimensions Height	Style Number	Top Surface	Base Prices
24" Diameter Round Occasional Table				30" Diameter Round Occasional Table			
15 ³ / ₄ "	100-T1	Clear Green Glass	\$1604	15 ³ / ₄ "	100-T2	Clear Green Glass	\$1839
15 ³ / ₄ "		Clear Green Laminated/ Frosted Appearance Glass	\$1755	15 ³ / ₄ "		Clear Green Laminate/ Frosted Appearance Glass	\$1989
15 ³ / ₄ "		Absolute Clear Frosted Glass	\$1884	15 ³ / ₄ "		Absolute Clear Frosted Glass	\$2218
15 ³ / ₄ "		Acid Etched 6511	\$1884	15 ³ / ₄ "		Acid Etched 6511	\$2218
15 ³ / ₄ "		Absolute Clear Glass	\$1893	15 ³ / ₄ "		Absolute Clear Glass	\$2304
15 ³ / ₄ "		Colored Glass	\$2225	15 ³ / ₄ "		Colored Glass	\$2865
15 ³ / ₄ "		Grade 1 Laminate	\$1053	15 ³ / ₄ "		Grade 1 Laminate	\$1092
15 ³ / ₄ "		Grade 2 Laminate	\$1075	15 ³ / ₄ "		Grade 2 Laminate	\$1115
15 ³ / ₄ "		Grade 1 Wood Veneer	\$1481	15 ³ / ₄ "		Grade 1 Wood Veneer	\$1696
15 ³ / ₄ "		Grade 2 Wood Veneer	\$1557	15 ³ / ₄ "		Grade 2 Wood Veneer	\$1784
15 ³ / ₄ "		Grade 1 Wedge Lay-up Veneer	N.A.	15 ³ / ₄ "		Grade 1 Wedge Lay-up Veneer	N.A.
15 ³ / ₄ "		Grade 2 Wedge Lay-up Veneer	N.A.	15 ³ / ₄ "		Grade 2 Wedge Lay-up Veneer	N.A.
15 ³ / ₄ "		Corian	\$1872	15 ³ / ₄ "		Corian	\$2141

► Specification Information, continued on next page



► Specification Information, continued from previous page

Specification Information



Dimensions Height	Style Number	Top Surface	Base Prices
36" Diameter Round Occasional Table			
15 ³ / ₄ "	100-T3	Clear Green Glass	\$2238
15 ³ / ₄ "		Clear Green Laminated/ Frosted Appearance Glass	\$2417
15 ³ / ₄ "		Absolute Clear Frosted Glass	\$2759
15 ³ / ₄ "		Acid Etched 6511	\$2759
15 ³ / ₄ "		Absolute Clear Glass	\$2897
15 ³ / ₄ "		Colored Glass	\$3878
15 ³ / ₄ "		Grade 1 Laminate	\$1181
15 ³ / ₄ "		Grade 2 Laminate	\$1212
15 ³ / ₄ "		Grade 1 Wood Veneer	\$2082
15 ³ / ₄ "		Grade 2 Wood Veneer	\$2233
15 ³ / ₄ "		Grade 1 Wedge Lay-up Veneer	\$3375
15 ³ / ₄ "		Grade 2 Wedge Lay-up Veneer	\$3547
15 ³ / ₄ "		Corian	\$2800

Dimensions Height	Style Number	Top Surface	Base Prices
42" Diameter Round Occasional Table			
15 ³ / ₄ "	100-T4	Clear Green Glass	\$2477
15 ³ / ₄ "		Clear Green Laminated/ Frosted Appearance Glass	\$2732
15 ³ / ₄ "		Absolute Clear Frosted Glass	\$3185
15 ³ / ₄ "		Acid Etched 6511	\$3185
15 ³ / ₄ "		Absolute Clear Glass	\$3369
15 ³ / ₄ "		Colored Glass	\$4415
15 ³ / ₄ "		Grade 1 Laminate	\$1257
15 ³ / ₄ "		Grade 2 Laminate	\$1297
15 ³ / ₄ "		Grade 1 Wood Veneer	\$2311
15 ³ / ₄ "		Grade 2 Wood Veneer	\$2526
15 ³ / ₄ "		Grade 1 Wedge Lay-up Veneer	\$3984
15 ³ / ₄ "		Grade 2 Wedge Lay-up Veneer	\$4228
15 ³ / ₄ "		Corian	\$2959



Dimensions Height	Style Number	Top Surface	Base Prices
24" Diameter Round Conference Dining Table			
29"	105-T1	Clear Green Glass	\$1709
29"		Clear Green Laminated/ Frosted Appearance Glass	\$1850
29"		Absolute Clear Frosted Glass	\$1983
29"		Acid Etched 6511	\$1983
29"		Absolute Clear Glass	\$1991
29"		Colored Glass	\$2343
29"		Grade 1 Laminate	\$1275
29"		Grade 2 Laminate	\$1297
29"		Grade 1 Wood Veneer	\$1703
29"		Grade 2 Wood Veneer	\$1779
29"		Grade 1 Wedge Lay-up Veneer	N.A.
29"		Grade 2 Wedge Lay-up Veneer	N.A.
29"		Corian	\$2094

Dimensions Height	Style Number	Top Surface	Base Prices
30" Diameter Round Conference Dining Table			
29"	105-T2	Clear Green Glass	\$1942
29"		Clear Green Laminated/ Frosted Appearance Glass	\$2087
29"		Absolute Clear Frosted Glass	\$2314
29"		Acid Etched 6511	\$2314
29"		Absolute Clear Glass	\$2401
29"		Colored Glass	\$2957
29"		Grade 1 Laminate	\$1314
29"		Grade 2 Laminate	\$1337
29"		Grade 1 Wood Veneer	\$1918
29"		Grade 2 Wood Veneer	\$2006
29"		Grade 1 Wedge Lay-up Veneer	N.A.
29"		Grade 2 Wedge Lay-up Veneer	N.A.
29"		Corian	\$2363

► Specification Information, continued on next page

► Specification Information, continued from previous page

Specification Information

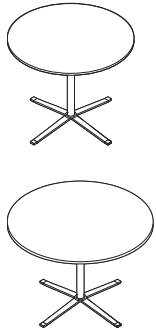

Dimensions Height	Style Number	Top Surface	Base Prices
36" Diameter Round Conference Dining Table			
29"	105-T3	Clear Green Glass	\$2310
29"		Clear Green Laminated/ Frosted Appearance Glass	\$2489
29"		Absolute Clear Frosted Glass	\$2831
29"		Acid Etched 6511	\$2831
29"		Absolute Clear Glass	\$2969
29"		Colored Glass	\$3910
29"		Grade 1 Laminate	\$1404
29"		Grade 2 Laminate	\$1435
29"		Grade 1 Wood Veneer	\$2305
29"		Grade 2 Wood Veneer	\$2456
29"		Grade 1 Wedge Lay-up Veneer	\$3598
29"		Grade 2 Wedge Lay-up Veneer	\$3770
29"		Corian	\$3023

Dimensions Height	Style Number	Top Surface	Base Prices
42" Diameter Round Conference Dining Table			
29"	105-T4	Clear Green Glass	\$2550
29"		Clear Green Laminated/ Frosted Appearance Glass	\$2797
29"		Absolute Clear Frosted Glass	\$3252
29"		Acid Etched 6511	\$3252
29"		Absolute Clear Glass	\$3436
29"		Colored Glass	\$4448
29"		Grade 1 Laminate	\$1480
29"		Grade 2 Laminate	\$1520
29"		Grade 1 Wood Veneer	\$2534
29"		Grade 2 Wood Veneer	\$2749
29"		Grade 1 Wedge Lay-up Veneer	\$4207
29"		Grade 2 Wedge Lay-up Veneer	\$4451
29"		Corian	\$3182

Standard Includes	Required to Specify
<p>► Need help? Product details, see <i>Coalesse Tables, Storage, and Accessories Specification Guide</i></p> <ul style="list-style-type: none"> • Frame/top: hard maple veneer • Glass top models: <ul style="list-style-type: none"> - 47-T17ELG and 47-T17RG1 models consist of two Diekman wood bases (47-T2617D and 47T2217E) with elliptical or rectangular glass tops - 1/2" thick clear glass top with radiused corners • Glides: polyethylene, non-adjustable 	<p>1 Style number 2 Top color number 3 Frame finish ► See <i>Surface Materials</i>, page 350</p>

Specification Information

Dimensions			Style Number	Prices	
D	W	H		Top Surface:	
				Glass	Wood

Wood

9 1/4"	13"	26"	47-T1326C	N.A.	\$1511
10"	16"	23"	47-T1623A	N.A.	\$1438
10"	16"	23"	47-T1623B	N.A.	\$1438
13 1/2"	15 3/4"	23"	47-T23EL	N.A.	\$1465
16"	25 3/4"	17"	47-T2617D	N.A.	\$1623
14 1/2"	22 1/4"	17"	47-T2217E	N.A.	\$1595

Wood Base, Elliptical Top

32"	40"	17 3/4"	47-T17ELG	\$3665	N.A.
-----	-----	---------	-----------	--------	------

Wood Base, Rectangle Top

32"	40"	17 3/4"	47-T17RG1	\$3683	N.A.
-----	-----	---------	-----------	--------	------

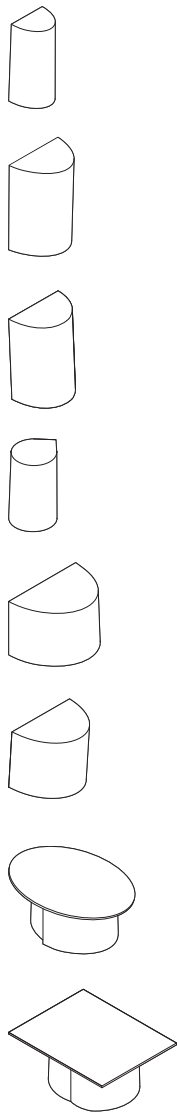

Bob Tables

Enea



Tables with Single Base (SIN 711.11)

76

Tables with Twin Base (SIN 711.11)

78

Enea Tables with Single Base

DESIGN JOSEF LLUSCA

SIN 711.11

Tip: Shipped knocked down.

Standard Includes	Required to Specify
<ul style="list-style-type: none"> Need help? Product details, see <i>Coalesse Tables, Storage, and Accessories Specification Guide</i> Laminate top: 3/4" thick with T-mold edge band Wood top: 3/4" thick with maple edge and maple veneer Base/frame: steel tubing and base Glides: non-skid 	<ol style="list-style-type: none"> Style number Laminate or wood top color number. Plastic color for edge band of laminate top, if selected: 6D10 Silver Metallic 6D11 Black 6D12 White Base/frame finish: 4016 White Gloss 4017 Black Gloss 4218 Platinum Silver <p>► See <i>Surface Materials</i>, page 350</p>

Specification Information				
Dimensions		Style	Prices	
Diameter	H	Number	Top Surface:	
			Laminate	Wood

Occasional Tables

36"	18"	H35-T3618L	\$ 966	N.A.
36"	18"	H35-T3618W	N.A.	\$1337
42"	18"	H35-T4218L	\$1163	N.A.
42"	18"	H35-T4218W	N.A.	\$1911

Café/Conference Height Tables

30"	30"	H35-T3030L	\$1137	N.A.
30"	30"	H35-T3030W	N.A.	\$1771
36"	30"	H35-T3630L	\$1197	N.A.
36"	30"	H35-T3630W	N.A.	\$1971
42"	30"	H35-T4230L	\$1377	N.A.
42"	30"	H35-T4230W	N.A.	\$2129

► Specification Information, continued on next page

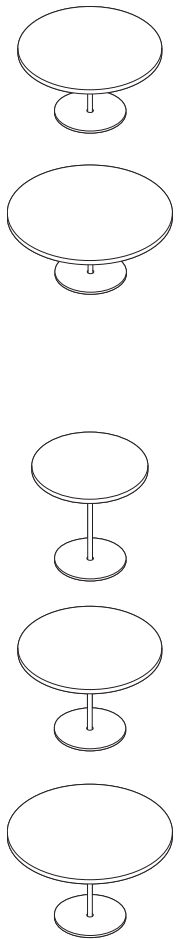

Enea Tables with Single Base
DESIGN JOSEP LLUSCA

SIN 711.11

► Specification Information, continued from previous page

Specification Information

Dimensions		Style	Prices	
Diameter	H	Number	Top Surface:	
			Laminate	Wood

Café/Counter Height Tables

24"	36"	H35-T2436L	\$1098	N.A.
24"	36"	H35-T2436W	N.A.	\$1786
30"	36"	H35-T3036L	\$1200	N.A.
30"	36"	H35-T3036W	N.A.	\$1998
36"	36"	H35-T3636L	\$1243	N.A.
36"	36"	H35-T3636W	N.A.	\$2176
42"	36"	H35-T4236L	\$1435	N.A.
42"	36"	H35-T4236W	N.A.	\$2903

Café/Bar Height Tables

24"	42"	H35-T2442L	\$1131	N.A.
24"	42"	H35-T2442W	N.A.	\$1833
30"	42"	H35-T3042L	\$1212	N.A.
30"	42"	H35-T3042W	N.A.	\$2051
36"	42"	H35-T3642L	\$1251	N.A.
36"	42"	H35-T3642W	N.A.	\$2229

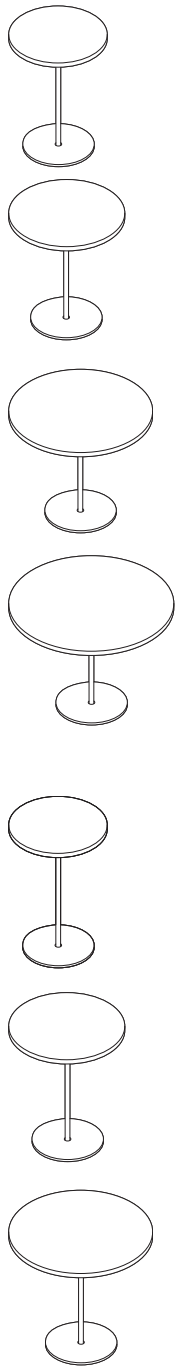

Enea Tables with Twin Base

DESIGN JOSEF LLUSCA

SIN 711.11

Tip: Shipped knocked down.

Tip: Due to weight of steel bases, please lift or move tables by bases only (do not lift by tops) with at least two people.

Tip: White laminate tops may exhibit slightly visible black specks inherent to the top manufacturing process.

Standard Includes

- ▶ Need help? Product details, see *Coalesse Tables, Storage, and Accessories Specification Guide*
- Base/frame: steel tubing and base
- Glides: non-skid
- Disc bases are 24" diameter
- Laminate top: 3/4" thick with T-mold edge band
- Wood top: 3/4" thick with maple edge and maple veneer

Required to Specify

- 1 Style number
- 2 Laminate or wood top color number
- 3 Plastic color for edge band of laminate top, if selected:
 - 6D10 Silver Metallic
 - 6D11 Black
 - 6D12 White
- 4 Base/frame finish:
 - 4016 White Gloss
 - 4017 Black Gloss
 - 4218 Platinum Silver
- ▶ See *Hardwood and Veneer Matrix*, pages 364-365
- 5 Options, if selected (see below)
 - ▶ See *Surface Materials*, page 350

Options

Options	Price
Interport Power/Data Module	• Interport power/data module (available in 8047 Silver Anodized Aluminum)

Required to Specify

Specify with *Interport power/data module*.

Specification Information

Dimensions			Style Number	Base Prices	
D	W	H		Top Surface: Laminate	Wood

Rectangular Tables

30"	72"	30"	H35-T307230GL	\$2823	N.A.
30"	72"	30"	H35-T307230GW	N.A.	\$3987

30"	72"	36"	H35-T307236GL	\$2962	N.A.
30"	72"	36"	H35-T307236GW	N.A.	\$4121

30"	72"	42"	H35-T307242GL	\$3272	N.A.
30"	72"	42"	H35-T307242GW	N.A.	\$4266

▶ Specification Information, continued on next page

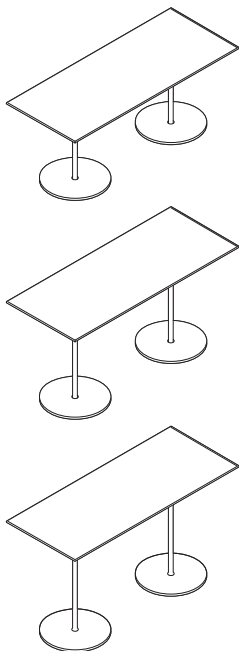

Enea Tables with Twin Base
DESIGN JOSEP LLUSCA

SIN 711.11

► Specification Information, continued from previous page

Specification Information

Dimensions			Style	Base Prices	
D	W	H	Number	Top Surface:	
				Laminate	Wood

Oval Tables

30"	72"	30"	H35-T307230VL	\$2817	N.A.
30"	72"	30"	H35-T307230VW	N.A.	\$4106

30"	72"	36"	H35-T307236VL	\$2839	N.A.
30"	72"	36"	H35-T307236VW	N.A.	\$4232

36"	72"	42"	H35-T307242VL	\$3101	N.A.
36"	72"	42"	H35-T307242VW	N.A.	\$4345

Conference/Racetrack Tables

30"	72"	30"	H35-T307230KL	\$2844	N.A.
30"	72"	30"	H35-T307230KW	N.A.	\$4152

Counter/Racetrack Tables

30"	72"	36"	H35-T307236KL	\$2968	N.A.
30"	72"	36"	H35-T307236KW	N.A.	\$4258

Café/Racetrack Tables

30"	72"	42"	H35-T307242KL	\$3142	N.A.
30"	72"	42"	H35-T307242KW	N.A.	\$4403

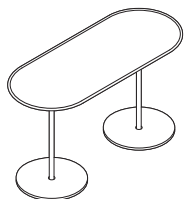
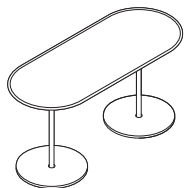
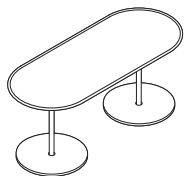
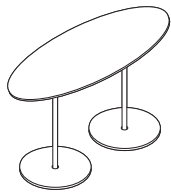
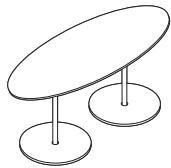

Lagunitas Work Tables

DESIGN TOAN NGUYEN

SIN 711.11

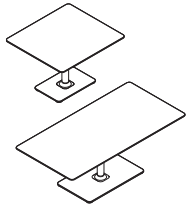

Tip: Column routes cables and wires when optional power or grommet are selected and exits through the base.

Tip: Devices and grommets are center location only to allow for routing of cords through the column and exits through the base.

Tip: Round power module is available in 4013 Silver/Black, 4180 Graphite Matte, 4242 Milk Smooth, or 4710 Low Gloss Black.

Tip: Power module configuration upcharges are in addition to the power module upcharge.

Tip: For each USB port specified, there are two USBs per port.

Tip: 26"H work tables are compatible with all Lagunitas seating.

Tip: 28½"H work tables are incompatible with Lagunitas seating, but are compatible with standard height seating.

Standard Includes		Required to Specify
<ul style="list-style-type: none"> ▶ Need help? Product details, see <i>Coalesse Tables, Storage, and Accessories Specification Guide</i> 	<ul style="list-style-type: none"> Table top: <ul style="list-style-type: none"> – Grade 1 laminate with 3 mm flat plastic edge – Grade 1 wood with matching flat wood edge Base with column: grade 1 paint Six non-adjustable glides Ships ready to assemble 	<ol style="list-style-type: none"> Style number Table top width Laminate or wood color number for table top Plastic edge color number for laminate table top, if selected Paint color number for base with column Options, if selected (see below) <p>▶ See <i>Surface Materials</i>, page 350</p>

Options	Price	Required to Specify
Surface Materials <ul style="list-style-type: none"> Work table top <ul style="list-style-type: none"> Grade 2 laminate Grade 2 wood veneer Stain-to-Match 	<ul style="list-style-type: none"> Prices below Prices below No cost 	<ul style="list-style-type: none"> Specify with <i>Grade 2 laminate</i> and select color number. Specify with <i>Grade 2 wood veneer</i> and select color number. Specify with <i>Stain-to-Match</i>. <p>▶ Page 385</p>
Work table base <ul style="list-style-type: none"> Grade 3 paint 	<ul style="list-style-type: none"> +\$105 	<ul style="list-style-type: none"> Specify paint color number.
Power/USB Configuration and Grommets <ul style="list-style-type: none"> Power module <ul style="list-style-type: none"> – Two TR simplex receptacles and 2 USB A charging ports – One TR simplex receptacle, one USB A charging port, and one USB C charging port 3" metal grommet <ul style="list-style-type: none"> – One metal grommet in anodized silver finish (center only) PowerPod grommet <ul style="list-style-type: none"> – One PowerPod grommet in 6052 Milk or 6000 Black plastic finish (center only) 	<ul style="list-style-type: none"> +\$261 No cost +\$103 +\$103 +\$ 79 +\$ 52 	<ul style="list-style-type: none"> Specify with <i>power module</i>. Specify with <i>two power</i>. Specify with <i>one power, two USB A</i>. Specify with <i>one power, one USB A, one USB C</i>. Specify with <i>3" metal grommet</i>. Specify with <i>PowerPod grommet</i> and select color number.

Related Products • Lagunitas lounge system ▶ See *GSA Volume 5a Specification Guide*.

Specification Information							
Style Number	Dimensions			Base Prices			
	D	W	H	Flat Vinyl Edge on Laminate Top		Flat Wood Edge on Wood Top	
				Grade 1	Grade 2	Grade 1	Grade 2

26"H Work Tables

COLAGTRECT	24"	30"	26"	\$1563	\$1635	\$2908	\$3091
	24"	36"	26"	\$1668	\$1745	\$3034	\$3233
	36"	40"	26"	\$1772	\$1857	\$3559	\$3792
	36"	48"	26"	\$2190	\$2294	\$3871	\$4148
	36"	57"	26"	\$2295	\$2405	\$4028	\$4320
	36"	72"	26"	\$2661	\$2788	\$4500	\$4815

28½"H Work Tables

COLAGTW	24"	30"	28½"	\$1584	\$1656	\$2929	\$3112
	24"	36"	28½"	\$1689	\$1766	\$3055	\$3254
	36"	40"	28½"	\$1793	\$1878	\$3580	\$3813
	36"	48"	28½"	\$2211	\$2315	\$3892	\$4169
	36"	57"	28½"	\$2316	\$2426	\$4049	\$4341
	36"	72"	28½"	\$2682	\$2809	\$4521	\$4836

Lagunitas Occasional Tables

SIN 711.11

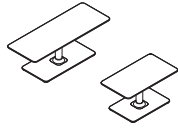

► Need help?
Product details, see *Coalesse Tables, Storage, and Accessories Specification Guide*

Standard Includes	Required to Specify
<ul style="list-style-type: none"> Table top: <ul style="list-style-type: none"> Grade 1 laminate with 3 mm flat plastic edge Grade 1 wood with matching flat wood edge Base with column: grade 1 paint Six non-adjustable glides Ships ready to assemble 	<ol style="list-style-type: none"> Style number Table top width Laminate or wood color number for table top Plastic edge color number for laminate table top, if selected Paint color number for base with column Options, if selected (see below) <p>► See <i>Surface Materials</i>, page 350</p>

Options	Price	Required to Specify
Surface Materials		
Table top		
• Grade 2 laminate	Prices below	Specify with <i>Grade 2 laminate</i> and select color number.
• Grade 2 wood veneer	Prices below	Specify with <i>Grade 2 wood veneer</i> and select color number.
• Stain-to-Match	No cost	Specify with <i>Stain-to-Match</i> . ► Page 385
Base		
• Grade 3 paint	+\$105	Specify paint color number.
Power/USB Configuration and Grommets		
• Power module	+\$261	Specify with <i>power module</i> .
- Two TR simplex receptacles	No cost	Specify with <i>two power</i> .
- One TR simplex receptacle and 2 USB A charging ports	+\$103	Specify with <i>one power, two USB A</i> .
- One TR simplex receptacle, one USB A charging port, and one USB C charging port	+\$103	Specify with <i>one power, one USB A, one USB C</i> .
3" metal grommet		
• One metal grommet in anodized silver finish (center only)	+\$ 79	Specify with <i>3" metal grommet</i> .
PowerPod grommet		
• One PowerPod grommet in 6052 Milk or 6000 Black plastic finish (center only)	+\$ 52	Specify with <i>PowerPod grommet</i> and select color number.

Tip: Column routes cables and wires when optional power or grommet are selected and exits through the base.

Tip: Devices and grommets are center location only to allow for routing of cords through the column and exits through the base.

Tip: Round power module is available in 4013 Silver/Black, 4180 Graphite Matte, 4242 Milk Smooth, or 4710 Low Gloss Black.

Tip: Power module configuration upcharges are in addition to the power module upcharge.

Tip: For each USB port specified, there are two USBs per port.

Style Number	Dimensions			Base Prices			
	D	W	H	Flat Vinyl Edge on Laminate Top		Flat Wood Edge on Wood Top	
				Grade 1	Grade 2	Grade 1	Grade 2
COLAGTO	18"	32"	16"	\$1511	\$1575	\$2856	\$3029
	18"	48"	16"	\$1778	\$1872	\$3565	\$3800

Lagunitas Personal Table

SIN 711.11



Standard Includes		Required to Specify
<ul style="list-style-type: none"> ► Need help? Product details, see <i>Coalesse Tables, Storage, and Accessories Specification Guide</i> 	<ul style="list-style-type: none"> • Table top: grade 1 laminate with 3 mm flat plastic edge • Table base with column: grade 1 paint • Four non-adjustable glides • Ships ready to assemble 	<ol style="list-style-type: none"> 1 Style number 2 Laminate color number for table top 3 Plastic edge color number for laminate table top, if selected 4 Paint color number base with column 5 Options, if selected (see below) <ul style="list-style-type: none"> ► See <i>Surface Materials</i>, page 350

Options	Price	Required to Specify
Surface Materials Personal table top <ul style="list-style-type: none"> • Grade 2 laminate • Fusion fabric wrapped 	<p>Prices below</p> <p>Prices below</p>	<p>Specify with <i>Grade 2 laminate</i> and select color number.</p> <p>Specify with <i>Fusion fabric</i> and select color number.</p> <ul style="list-style-type: none"> ► See <i>Coalesse Surface Materials Reference Guide</i>.
Personal table base <ul style="list-style-type: none"> • Grade 3 paint 	<p>+\$105</p>	<p>Specify paint color number.</p>

Specification Information						
Style Number	Dimensions			Base Prices		
	D	W	H	Laminate: Grade 1	Grade 2	Fusion: Fabric
COLAGTP	13"	24"	25"	\$626	\$658	\$888

Standard Includes	Required to Specify
<ul style="list-style-type: none"> ▶ Need help? Product details, see <i>Coalesse Tables, Storage, and Accessories Specification Guide</i> • Base: painted steel with 1/2" x 1 3/4" legs • Glass top: 3/4" thick glass • Glides 	<ol style="list-style-type: none"> 1 Style number 2 Glass color number for top 3 Paint color number for base 4 Options, if selected (see below) <p>▶ See <i>Surface Materials</i>, page 350</p>

Options	Price	Required to Specify
Surface Materials <ul style="list-style-type: none"> • Base • Grade 1 paint • Grade 3 paint • Plated metal for side table, 30" x 30" and 36" x 36" square tables, and 20" x 54" and 30" x 60" rectangular tables • Plated metal for 48" x 48" square table and rectangular tables 	<p>No cost</p> <p>+\$ 75</p> <p>+\$587</p> <p>+\$677</p>	<p>Specify paint color number.</p> <p>Specify paint color number.</p> <p>Specify with 9238 Brushed Nickel.</p> <p>Specify with 9238 Brushed Nickel.</p>

Related Products • Millbrae seating ▶ See *GSA Volume 5a Specification Guide*.

Tip: Absolute clear frosted glass on Millbrae tables utilizes a sandblast process to achieve a lightly frosted, translucent aesthetic.

Specification Information									
Dimensions			Style Number	Base Prices					
D	W	H		Top Surface:					
				Clear	Clear Green	Absolute Clear/	Acid	Absolute	Colored
				Green	Laminated/	Clear Frosted	Etched	Clear	Glass
					Clear Green		6511		
					Frosted				
					Appearance				

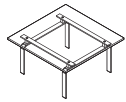

Square Tables

D	W	H	Style Number	Base Price	Top Surface Price	Clear Frosted Price	Acid Etched Price	Absolute Clear Price	Colored Glass Price
30"	30"	15"	COMOTL3030	\$2032	\$2073	\$2152	\$2199	\$2199	\$2296
36"	36"	15"	COMOTL3636	\$2413	\$2464	\$2580	\$2649	\$2649	\$2792
48"	48"	15"	COMOTL4848	\$3301	\$3388	\$3578	\$3719	\$3719	\$3967

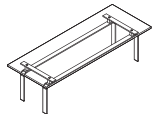

Rectangular Tables

D	W	H	Style Number	Base Price	Top Surface Price	Clear Frosted Price	Acid Etched Price	Absolute Clear Price	Colored Glass Price
20"	54"	15"	COMOTL2054	\$2666	\$2735	\$2811	\$2868	\$2868	\$2983
30"	60"	15"	COMOTL3060	\$2919	\$2988	\$3142	\$3252	\$3252	\$3441



Side Table

D	W	H	Style Number	Base Price	Top Surface Price	Clear Frosted Price	Acid Etched Price	Absolute Clear Price	Colored Glass Price
20"	20"	20"	COMOTL2020	\$1650	\$1680	\$1714	\$1724	\$1724	\$1770

Passerelle

DESIGN STUDIO B

SIN 711.11

Tip: Bases are not sold separately.

Tip: Interport is not available on 44-T164830.

Tip: Interport is for center location only.

Standard Includes		Required to Specify
<ul style="list-style-type: none"> ► Need help? Product details, see <i>Coalesse Tables, Storage, and Accessories Specification Guide</i> 	<ul style="list-style-type: none"> • Frame: Solid maple with mortise and tenon joinery for structural integrity • Glides: Polyethylene • Wood top: 1" thick, selected maple veneer • Ships ready-to-assemble 	<ul style="list-style-type: none"> 1 Style number 2 Top and frame finish 3 Options, if selected (see below) ► See <i>Surface Materials</i>, page 350

Options	Price	Required to Specify
Surface Materials <ul style="list-style-type: none"> • Top • Contrasting wood top 	+\$191	Specify with <i>contrasting wood top</i> .
Interport Power/Data Module <ul style="list-style-type: none"> • Interport Power/Data Module 	+\$329	Specify with <i>Interport</i> and select finish color number.
Related Products <ul style="list-style-type: none"> • Passerelle seating 		► See <i>GSA Volume 5a Specification Guide</i> .

Specification Information

Dimensions			Style Number	Base Price
D	W	H		Top Surface: Wood
24"	24"	17"	44-T242417	\$ 955
24"	24"	21"	44-T242421	\$1039
16"	48"	30"	44-T164830	\$1430

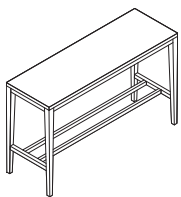
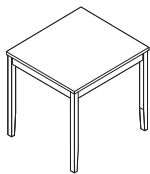
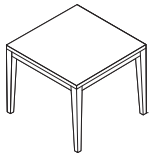

Switch

DESIGN E00S

SIN 711.11

Standard Includes **Required to Specify**

- Base: satin silver plated tubing
- Matte chrome finish
- Glass top: 5/8" thick, green tinted, tempered glass tops have radiused corners
- Adjustable glides

Style number

Related Products

- Switch seating

▶ See *GSA Volume 5a Specification Guide*.

Specification Information

Dimensions			Style	Price
D	W	H	Number	Top Surface: Glass

Square Table

24 ³ / ₈ "	24 ³ / ₈ "	15"	39-2424	\$1889
----------------------------------	----------------------------------	-----	---------	--------

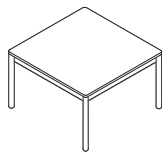

Rectangle Table

24 ³ / ₈ "	43 ¹ / ₄ "	15"	39-2442	\$2326
----------------------------------	----------------------------------	-----	---------	--------

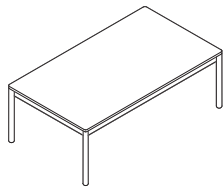

Square Table

36"	36"	15"	39-3636	\$2505
-----	-----	-----	---------	--------

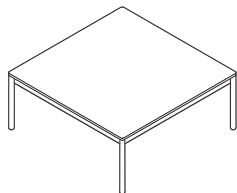

Montara650



Café Tables (SIN 711.11)

Work Height (SIN 711.11) 88

Café Height (SIN 711.11) 90

Occasional Tables (SIN 711.11) 92

Montara650 Work-Height Tables

DESIGN COALESSE DESIGN GROUP

SIN 711.11

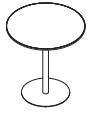

Standard Includes		Required to Specify
<ul style="list-style-type: none"> ▶ Need help? Product details, see <i>Coalesse Tables, Storage, and Accessories Specification Guide</i> 	<ul style="list-style-type: none"> • Table top: <ul style="list-style-type: none"> - Grade 1 laminate with 3 mm flat plastic edge - Wood veneer with matching flat edge • Base: grade 1 paint • Glides • Ships ready to assemble 	<ol style="list-style-type: none"> 1 Style number 2 Table top diameter for round table 3 Table top width for square or rectangular table 4 Table top depth for square or rectangular table 5 Laminate or wood veneer color number for table top 6 Plastic edge color number for laminate table top, if selected 7 Paint color number for base 8 Options, if selected (see below) <p>▶ See <i>Surface Materials</i>, page 350</p>

	Options	Price	Required to Specify
Surface Materials	Table Top		
	<ul style="list-style-type: none"> • Grade 2 laminate 	Prices at right	Specify with <i>Grade 2 laminate</i> and select color number.
	<ul style="list-style-type: none"> • Grade 2 wood veneer 	Prices at right	Specify with <i>Grade 2 wood veneer</i> and select color number.
	<ul style="list-style-type: none"> • Stain-to-Match 	No cost	Specify with <i>Stain-to-Match</i> . ▶ Page 385
	Base		
	<ul style="list-style-type: none"> • Grade 3 paint on tables with single base 	+\$105	Specify paint color number.
	<ul style="list-style-type: none"> • Grade 3 paint on tables with double base (30"D x 72"W) 	+\$210	Specify paint color number.
	Grommet		
	<ul style="list-style-type: none"> • PowerPod grommet for 36"-60" diameter round and 36"W-42"W square tables (center only) 	+\$ 52	Specify with <i>PowerPod grommet</i> and select finish.
	<ul style="list-style-type: none"> • PowerPod grommet for 30"D x 72"W rectangular tables 	+\$ 52 each grommet	Specify with <i>one or two PowerPod grommets</i> and select finish.
Related Products	<ul style="list-style-type: none"> • Montara650 seating 		▶ See <i>GSA Volume 5a Specification Guide</i> .

Tip: Grade 3 paints are not available on 54" or 60" round tables.

Tip: PowerPod grommet is available in 6000 Black or 6052 Milk.

Montara650 Work-Height Tables

DESIGN COALESSE DESIGN GROUP

SIN 711.11

Specification Information

Style Number	Dimensions			Base Prices			
	D	W	H	Laminate Grade 1	Grade 2	Wood Veneer Grade 1	Grade 2

28½"H Round Café Tables

Style Number	Dimensions	H	Laminate Grade 1	Grade 2	Wood Veneer Grade 1	Grade 2
COSFZWTRD	24" diameter	28½"	\$1102	\$1153	\$1820	\$2025
	30" diameter	28½"	\$1179	\$1256	\$1897	\$2102
	36" diameter	28½"	\$1256	\$1359	\$1974	\$2179
	42" diameter	28½"	\$1435	\$1563	\$2255	\$2460
	54" diameter	28½"	\$2204	\$2383	\$3229	\$3434
	60" diameter	28½"	\$2306	\$2511	\$3536	\$3741

28½"H Square Café Tables

Style Number	D	W	H	Laminate Grade 1	Grade 2	Wood Veneer Grade 1	Grade 2
COSFZWTSQ	24"	24"	28½"	\$1102	\$1153	\$1820	\$2025
	30"	30"	28½"	\$1179	\$1256	\$1897	\$2102
	36"	36"	28½"	\$1256	\$1359	\$1974	\$2179
	42"	42"	28½"	\$1435	\$1563	\$2255	\$2460

28½"H Rectangular Café Tables

Style Number	D	W	H	Laminate Grade 1	Grade 2	Wood Veneer Grade 1	Grade 2
COSFZWTSQ	24"	30"	28½"	\$1153	\$1230	\$1871	\$2076
	30"	72"	28½"	\$2768	\$2999	\$4101	\$4306

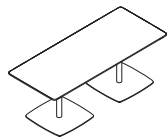
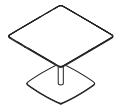

Tip: A 30"D x 72"W table has a double base.

Tip: One or two PowerPod grommets can be specified in 30"D x 72"W rectangular table.

Montara650

Montara650 Café-Height Tables

DESIGN COALESSE DESIGN GROUP

SIN 711.11



	Standard Includes	Required to Specify
<p>► Need help? Product details, see <i>Coalesse Tables, Storage, and Accessories Specification Guide</i></p>	<ul style="list-style-type: none"> Table top: <ul style="list-style-type: none"> Grade 1 laminate with 3 mm flat plastic edge Wood veneer with matching flat edge Base: grade 1 paint Glides Ships ready to assemble 	<ol style="list-style-type: none"> Style number Application (see below under Required Selections) Table top diameter for round table Table top width for square or rectangular table Table top depth for square or rectangular table Laminate or wood veneer color number for table top Plastic edge color number for laminate top, if selected Paint color number for base Options, if selected (see below) <p>► See <i>Surface Materials</i>, page 350</p>

	Required Selections	Price	Required to Specify
Application	<ul style="list-style-type: none"> 36"H counter height table 42"H bar height table 	<p>No cost</p> <p>+\$ 26</p>	<p>Specify <i>with counter height</i>.</p> <p>Specify <i>with bar height</i>.</p>

	Options	Price	Required to Specify
Surface Materials	Table top		
	<ul style="list-style-type: none"> Grade 2 laminate 	Prices at right	Specify <i>with Grade 2 laminate</i> and select color number.
	<ul style="list-style-type: none"> Grade 2 wood veneer 	Prices at right	Specify <i>with Grade 2 wood veneer</i> and select color number.
	<ul style="list-style-type: none"> Stain-to-Match 	No cost	Specify <i>with Stain-to-Match</i> . ► Page 385
	Base		
	<ul style="list-style-type: none"> Grade 3 paint on tables with single base 	+\$105	Specify paint color number.
	<ul style="list-style-type: none"> Grade 3 paint on tables with double base (30"D x 72"W) 	+\$210	Specify paint color number.
Grommet	<ul style="list-style-type: none"> PowerPod grommet for 36"-42" diameter round and 36"W-42"W square tables (center only) 	+\$ 52	Specify <i>with PowerPod grommet</i> and select finish.
	<ul style="list-style-type: none"> PowerPod grommet for 30"D x 72"W rectangular tables 	+\$ 52 each grommet	Specify <i>with one or two PowerPod grommets</i> and select finish.
Related Products	<ul style="list-style-type: none"> Montara650 seating 		► See <i>GSA Volume 5a Specification Guide</i> .

Tip: PowerPod grommet is available in 6000 Black or 6052 Milk.

Montara650 Café-Height Tables

DESIGN COALESSE DESIGN GROUP

SIN 711.11

Specification Information

Style Number	Dimensions			Base Prices			
	D	W	H	Laminate Grade 1	Grade 2	Wood Veneer Grade 1	Grade 2

36"H Round Café Tables

COSFZCTR	24" diameter		36"	\$1179	\$1230	\$1897	\$2102
	30" diameter		36"	\$1256	\$1333	\$1974	\$2179
	36" diameter		36"	\$1333	\$1436	\$2051	\$2256
	42" diameter		36"	\$1487	\$1615	\$2307	\$2512

36"H Square Café Tables

COSFZCTSQ	24"	24"	36"	\$1179	\$1230	\$1897	\$2102
	30"	30"	36"	\$1256	\$1333	\$1974	\$2179
	36"	36"	36"	\$1333	\$1436	\$2051	\$2256
	42"	42"	36"	\$1487	\$1615	\$2307	\$2512

36"H Rectangular Café Tables

COSFZCTSQ	24"	30"	36"	\$1230	\$1307	\$1948	\$2153
	30"	72"	36"	\$2845	\$3076	\$4178	\$4383

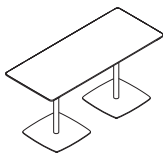
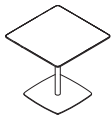

Tip: A 30"D x 72"W table has a double base.

Tip: One or two PowerPod grommets can be specified in 30"D x 72"W rectangular café table.

Montara650 Occasional-Height Tables

DESIGN COALESSE DESIGN GROUP

SIN 711.11

Standard Includes		Required to Specify
<ul style="list-style-type: none"> ► Need help? Product details, see <i>Coalesse Tables, Storage, and Accessories Specification Guide</i> 	<ul style="list-style-type: none"> • Table top: <ul style="list-style-type: none"> - Grade 1 laminate with 3 mm flat plastic edge - Wood veneer with matching flat edge • Base: grade 1 paint • Glides • Ships ready to assemble 	<ol style="list-style-type: none"> 1 Style number 2 Table top diameter for round table 3 Table top depth and width for square table 4 Laminate or wood veneer color number for table top 5 Plastic edge color number for laminate table top, if selected 6 Paint color number for base 7 Options, if selected (see below) <p>► See <i>Surface Materials</i>, page 350</p>

Options	Price	Required to Specify
Surface Materials <ul style="list-style-type: none"> • Table top • Grade 2 laminate • Grade 2 wood veneer • Stain-to-Match 	<p>Prices below</p> <p>Prices below</p> <p>No cost</p>	<p>Specify with <i>Grade 2 laminate</i> and select color number.</p> <p>Specify with <i>Grade 2 wood veneer</i> and select color number.</p> <p>Specify with <i>Stain-to-Match</i>.</p> <p>► Page 385</p>
Base <ul style="list-style-type: none"> • Grade 3 paint 	<p>+\$105</p>	<p>Specify paint color number.</p>
Grommet <ul style="list-style-type: none"> • PowerPod grommet (center only) 	<p>+\$ 52</p>	<p>Specify with <i>PowerPod grommet</i> and select finish.</p>
Related Products <ul style="list-style-type: none"> • Montara650 seating 		<p>► See <i>GSA Volume 5a Specification Guide</i>.</p>

Tip: PowerPod grommet is available in 6000 Black or 6052 Milk.

Specification Information							
Style Number	Dimensions			Base Prices			
	D	W	H	Laminate		Wood Veneer	
				Grade 1	Grade 2	Grade 1	Grade 2

Round Tables

COSFZOTRD	30" diameter		18"	\$1025	\$1102	\$1743	\$1948
	36" diameter		18"	\$1102	\$1205	\$1820	\$2025
	42" diameter		18"	\$1230	\$1358	\$2050	\$2255

Square Tables

COSFZOTSQ	30"	30"	18"	\$1025	\$1102	\$1743	\$1948
	36"	36"	18"	\$1102	\$1205	\$1820	\$2025
	42"	42"	18"	\$1230	\$1358	\$2050	\$2255

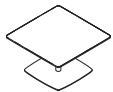

Train

Rectangular Tables (SIN 711.11)	94
90° Corner Tops (SIN 711.11)	100
Accessories (SIN 711.11)	101

Train Rectangular Tables

DESIGN VECTA DESIGN TEAM AND IDEO

SIN 711.11

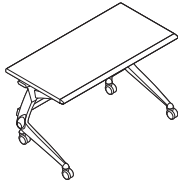

Tip: Shipped knocked down.

Tip: All electrical system components (raceways, receptacles, base power infeeds, etc.) must be the same wiring schematic.

Tip: Raceway has access doors on both aisle and kneewell sides.

Tip: Modular connector occupies one receptacle location in raceway.

Standard Includes	Required to Specify
<ul style="list-style-type: none"> ▶ Need help? Product details, see <i>Coalesse Tables, Storage, and Accessories Specification Guide</i> • Top: 1" particle board core with High-Pressure Laminate • Edge: black soft rolled front edge with black vinyl with black 3 mm sides and back • Base: cast aluminum legs and steel stretcher bar with single powder coat color • Coupling device to allow adjacent tables to be connected end-to-end • 3" diameter, locking, dual-wheel casters: black plastic 	<ol style="list-style-type: none"> 1 Style number 2 Powder coat color number for base 3 Laminate color number for top 4 Options, if selected (see below) <ul style="list-style-type: none"> ▶ See <i>Surface Materials</i>, page 350.

Options	Price	Required to Specify
Surface Materials <ul style="list-style-type: none"> • Grade 2 laminate 	Prices at right	Specify with <i>Grade 2 laminate</i> and select color number.
Modesty panel Flip-down modesty panel <ul style="list-style-type: none"> • 48"W • 60"W • 72"W 	<ul style="list-style-type: none"> +\$ 583 +\$ 611 +\$ 640 	<ul style="list-style-type: none"> Specify with <i>48"W modesty panel</i>. Specify with <i>60"W modesty panel</i>. Specify with <i>72"W modesty panel</i>.
Raceways with 4-circuit electrical <ul style="list-style-type: none"> • 48"L Table • 60"L Table • 72"L Table 	<ul style="list-style-type: none"> +\$1227 +\$1322 +\$1382 	<ul style="list-style-type: none"> Specify with <i>48"L electrical raceway</i>, and the type of electrical system: 3+1 electrical, system, 2+2 electrical system, or three-circuit, separate neutrals electrical system. Specify with <i>60"L electrical raceway</i>, and the type of electrical system: 3+1 electrical, system, 2+2 electrical system, or three-circuit, separate neutrals electrical system. Specify with <i>72"L electrical raceway</i>, and the type of electrical system: 3+1 electrical, system, 2+2 electrical system, or three-circuit, separate neutrals electrical system.
Raceways without 4-circuit electrical system <ul style="list-style-type: none"> • 48"L Table • 60"L Table • 72"L Table 	<ul style="list-style-type: none"> +\$ 867 +\$ 934 +\$ 979 	<ul style="list-style-type: none"> Specify with <i>48"L raceway</i>, and no electrical system. Specify with <i>60"L raceway</i>, and no electrical system. Specify with <i>72"L raceway</i>, and no electrical system.
POD Power and communication module with hinged cover: black plastic with black painted steel septum <ul style="list-style-type: none"> • POD with 9' cord with 15-amp plug • POD with 6' conduit with hardwire in-feed • POD with 3+1 modular connector for attachment to power module in 3+1 raceway 	<ul style="list-style-type: none"> +\$ 361 +\$ 361 +\$ 361 	<ul style="list-style-type: none"> Specify with <i>POD, plug</i>. Specify with <i>POD, hardwire</i>. Specify with <i>POD, modular</i> and select circuit number 1, 2, 3, or 4.

▶ Options, continued on next page

Train Rectangular Tables

DESIGN VECTA DESIGN TEAM AND IDEO

SIN 711.11

►Options, continued from previous page

Tip: For Axil Z and Ellora, the USB for charging is configured in the spot of one data port and is always configured on the end(s).

Tip: For each USB port specified, there are two USBs per port.

Tip: The hardwire or modular POD, hardwire Axil Z, or hardwire Ellora desktop module does not work with modular table power kits.

Tip: If a hardwire or modular POD, hardwire Axil Z, or hardwire Ellora desktop module is desired, then it can only be specified on tables with glides.

Tip: If one Axil Z desktop unit is specified other than center location, it can only be used on tables specified without raceway. If raceway is specified, then center location is only available location.

Tip: When a four power Axil Z or Ellora corded device is specified, the 15-amp plug end requires a circuit breaker, therefore the plug end is different.

Tip: If one Axil Z desktop unit is specified other than center location, it can only be used on tables specified without raceway. If raceway is specified, then center location is only available location.

	Options	Price	Required to Specify
Axil Z	One 6' cord (48"L and center only)		
	• Two power/two data	+\$227	Specify with one center Axil Z cord with two power/two data and select color number.
	• Two power/one data/one USB	+\$327	Specify with one center Axil Z cord with two power/one data/one USB and select color number.
	• Two power/two USB	+\$427	Specify with one center Axil Z cord with two power/two USB and select color number.
	• Three power/one data	+\$233	Specify with one center Axil Z cord with three power/one data and select color number.
	• Three power/one USB	+\$332	Specify with one center Axil Z cord with three power/one USB and select color number.
	• Four power	+\$295	Specify with one center Axil Z cord with four power and select color number.
	One 6' hardwire (48"L and center only)		
	• Two power/two data	+\$227	Specify with one center Axil Z hardwire with two power/two data and select color number.
	• Two power/one data/one USB	+\$327	Specify with one center Axil Z hardwire with two power/one data/one USB and select color number.
	• Two power/two USB	+\$427	Specify with one center Axil Z hardwire with two power/two USB and select color number.
	• Three power/one data	+\$233	Specify with one center Axil Z hardwire with three power/one data and select color number.
• Three power/one USB	+\$332	Specify with one center Axil Z hardwire with three power/one USB and select color number.	
• Four power	+\$295	Specify with one center Axil Z hardwire with four power and select color number.	
Axil Z	One 6' cord (60"L and 72"L only)		
	• Two power/two data	+\$227	Specify with one Axil Z cord with two power/two data, select left, right, or center location and select color number.
	• Two power/one data/one USB	+\$327	Specify with one Axil Z cord with two power/one data/one USB, select left, right, or center location and select color number.
	• Two power/two USB	+\$427	Specify with one Axil Z cord with two power/two USB, select left, right, or center location and select color number.
	• Three power/one data	+\$233	Specify with one Axil Z cord with three power/one data, select left, right, or center location and select color number.
	• Three power/one USB	+\$332	Specify with one Axil Z cord with three power/one USB, select left, right, or center location and select color number.
	• Four power	+\$295	Specify with one Axil Z cord with four power, select left, right, or center location and select color number.
	One 6' hardwire (60"L and 72"L only)		
	• Two power/two data	+\$227	Specify with one Axil Z hardwire with two power/two data, select left, right, or center location and select color number.
	• Two power/one data/one USB	+\$327	Specify with one Axil Z hardwire with two power/one data/one USB, select left, right, or center location and select color number.
	• Two power/two USB	+\$427	Specify with one Axil Z hardwire with two power/two USB, select left, right, or center location and select color number.
	• Three power/one data	+\$233	Specify with one Axil Z hardwire with three power/one data, select left, right, or center location and select color number.
• Three power/one USB	+\$332	Specify with one Axil Z hardwire with three power/one USB, select left, right, or center location and select color number.	
• Four power	+\$295	Specify with one Axil Z hardwire with four power, select left, right, or center location and select color number.	

►Options, continued on next page

Train Rectangular Tables *continued*
 DESIGN VECTA DESIGN TEAM AND IDEO

SIN 711.11

►Options, continued from previous page

	Options	Price	Required to Specify
Axil Z, continued	Two 6' cords (60"L and 72"L only)		
	• Two power/two data	+\$454	Specify with two (left and right) Axil Z cords with two power/two data and select color number.
	• Two power/one data/one USB	+\$654	Specify with two (left and right) Axil Z cords with two power/one data/one USB and select color number.
	• Two power/two USB	+\$854	Specify with two (left and right) Axil Z cords with two power/two USB and select color number.
	• Three power/one data	+\$466	Specify with two (left and right) Axil Z cords with three power/one data and select color number.
	• Three power/one USB	+\$664	Specify with two (left and right) Axil Z cords with three power/one USB and select color number.
	• Four power	+\$590	Specify with two (left and right) Axil Z cords with four power and select color number.
	Two 6' hardwires (60"L and 72"L only)		
	• Two power/two data	+\$454	Specify with two (left and right) Axil Z hardwires with two power/two data and select color number.
	• Two power/one data/one USB	+\$654	Specify with two (left and right) Axil Z hardwires with two power/one data/one USB and select color number.
	• Two power/two USB	+\$854	Specify with two (left and right) Axil Z hardwires with two power/two USB and select color number.
	• Three power/one data	+\$466	Specify with two (left and right) Axil Z hardwires with three power/one data and select color number.
	• Three power/one USB	+\$664	Specify with two (left and right) Axil Z hardwires with three power/one USB and select color number.
	• Four power	+\$590	Specify with two (left and right) Axil Z hardwires with four power and select color number.
Ellora	One 6' cord (center only)		
	• Two power/two data	+\$343	Specify with one center Ellora cord with two power/two data.
	• Two power/one data/one USB	+\$444	Specify with one center Ellora cord with two power/one data/one USB.
	• Two power/two USB	+\$543	Specify with one center Ellora cord with two power/two USB.
	• Three power/one data	+\$349	Specify with one center Ellora cord with three power/one data.
	• Three power/one USB	+\$449	Specify with one center Ellora cord with three power/one USB.
	• Four power	+\$412	Specify with one center Ellora cord with four power.
	One 6' hardwire (center only)		
	• Two power/two data	+\$343	Specify with one center Ellora cord with two power/two data.
	• Two power/one data/one USB	+\$444	Specify with one center Ellora cord with two power/one data/one USB.
	• Two power/two USB	+\$543	Specify with one center Ellora cord with two power/two USB.
	• Three power/one data	+\$349	Specify with one center Ellora cord with three power/one data.
	• Three power/one USB	+\$449	Specify with one center Ellora cord with three power/one USB.
	• Four power	+\$412	Specify with one center Ellora cord with four power.

Tip: If two Ellora desktop units are specified, they can only be used on tables specified without raceway. If raceway is specified, then center location is only available location.

Tip: For a factory installed cutout in the tabletop, specify POD, Axil Z, or Ellora as an option. If a POD, Axil Z, or Ellora is not specified as an option, the table top will require a field installed cutout.

Tip: For POD, Axil Z, Ellora, and grommet locations, see Standard Locations Grommets, Spheres, Interport, Mini-Port, Interact, Axil Z, and Ellora Charts. ►See Coalesse Tables, Storage, and Accessories Specification Guide.

►Options, continued on next page

►Options, continued from previous page

	Options	Price	Required to Specify	
Ellora, continued	Two 6' cords (30"W x 60"L and 30"W x 72"L only)			
	• Two power/two data	+\$ 686	Specify with one center Ellora cords with two power/two data.	
	• Two power/one data/one USB	+\$ 888	Specify with one center Ellora cords with two power/one data/one USB.	
	• Two power/two USB	+\$1086	Specify with one center Ellora cords with two power/two USB.	
	• Three power/one data	+\$ 698	Specify with one center Ellora cords with three power/one data.	
	• Three power/one USB	+\$ 898	Specify with one center Ellora cords with three power/one USB.	
	• Four power	+\$ 824	Specify with one center Ellora cords with four power.	
	<hr/>			
		Two 6' hardwires (30"W x 60"L and 30"W x 72"L only)		
	• Two power/two data	+\$ 686	Specify with one center Ellora cords with two power/two data.	
	• Two power/one data/one USB	+\$ 888	Specify with one center Ellora cords with two power/one data/one USB.	
	• Two power/two USB	+\$1086	Specify with one center Ellora cords with two power/two USB.	
	• Three power/one data	+\$ 698	Specify with one center Ellora cords with three power/one data.	
• Three power/one USB	+\$ 898	Specify with one center Ellora cords with three power/one USB.		
• Four power	+\$ 824	Specify with one center Ellora cords with four power.		

►Options, continued on next page

Train Rectangular Tables *continued*
 DESIGN VECTA DESIGN TEAM AND IDEO

SIN 711.11

►Options, continued from previous page

Tip: Modular table power kits require either a 20-amp plug infeed or hardwire infeed to power the tables. A 20-amp plug infeed can only be used with Circuit 1 receptacles, and the hardwire infeed can be used with either or both, Circuit 1 and Circuit 2 receptacles.

Tip: Flex ganger or bar ganger package must be used when using modular power table kits in a table-to-table application.

Tip: The modular table power kit does not work with the raceways, with electrical or without electrical system, it can be used with or without a modesty panel.

Tip: The modular table power kit is a 2-circuit system and is not compatible with the 4-circuit electrical in the raceway. The connectors are also not compatible.

Tip: When three grommets are specified, grommets will be located left, right, and center.

	Options	Price	Required to Specify
2-Circuit Modular Table Power Kits	One circuit 1 duplex receptacle		
	• For 48"L tables - modular power kit with one center duplex receptacle, circuit 1	+\$221	Specify with 48"L modular power kit with circuit 1 duplex receptacle.
	• For 60"L tables - modular power kit with one center duplex receptacle, circuit 1	+\$237	Specify with 60"L modular power kit with circuit 1 duplex receptacle.
	• For 72"L tables - modular power kit with one center duplex receptacle, circuit 1	+\$251	Specify with 72"L modular power kit with circuit 1 duplex receptacle.
	One circuit 2 duplex receptacle (To be used with hardwire infeed only)		
	• For 48"L tables - modular power kit with one center duplex receptacle, circuit 2	+\$221	Specify with 48"L modular power kit with circuit 2 duplex receptacle.
	• For 60"L tables - modular power kit with one center duplex receptacle, circuit 2	+\$237	Specify with 60"L modular power kit with circuit 2 duplex receptacle.
	• For 72"L tables - modular power kit with one center duplex receptacle, circuit 2	+\$251	Specify with 72"L modular power kit with circuit 2 duplex receptacle.
	Two circuit 1 duplex receptacles (60"L and 72"L tables only)		
	• For 60"L tables - modular power kit with two center duplex receptacles, circuit 1	+\$306	Specify with 60"L modular power kit with circuit 1 duplex receptacles.
• For 72"L tables - modular power kit with two center duplex receptacles, circuit 1	+\$322	Specify with 72"L modular power kit with circuit 1 duplex receptacles.	
One circuit 1 and one circuit 2 duplex receptacles (60"L and 72"L tables only) (To be used with hardwire infeed only)			
• For 60"L tables - modular power kit with two center duplex receptacles, one circuit 1 and one circuit 2	+\$306	Specify with 60"L modular power kit with one circuit 1 and one circuit 2 duplex receptacles.	
• For 72"L tables - modular power kit with two center duplex receptacles, one circuit 1 and one circuit 2	+\$322	Specify with 72"L modular power kit with one circuit 1 and one circuit 2 duplex receptacles.	
Grommets	• One grommet: black plastic	+\$ 70	Specify with grommet and select left, right, or center location.
	• Two grommets: black plastic	+\$140	Specify with two grommets and select location of left/center, right/center, or right/left.
	• Three grommets: black plastic	+\$210	Specify with three grommets.
Glides	• Glides: aluminum with black textured powder coat	+\$157	Delete suffix C from the style number.

Train Rectangular Tables

DESIGN VECTA DESIGN TEAM AND IDEO

SIN 711.11

Specification Information

Dimensions			Style Number	Finish	Base Price
L	W	H			
					 <p>Train Vinyl Edge:</p>

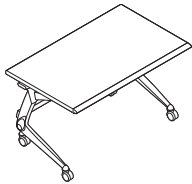
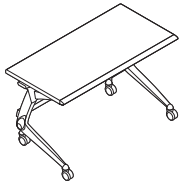

24"W Rectangular Tables

48"	24"	28½"	TN4824C	Grade 1 Laminate	\$1771
				Grade 2 Laminate	\$1818
60"	24"	28½"	TN6024C	Grade 1 Laminate	\$1920
				Grade 2 Laminate	\$1975
72"	24"	28½"	TN7224C	Grade 1 Laminate	\$1966
				Grade 2 Laminate	\$2032

30"W Rectangular Tables

48"	30"	28½"	TN4830C	Grade 1 Laminate	\$1857
				Grade 2 Laminate	\$1913
60"	30"	28½"	TN6030C	Grade 1 Laminate	\$1952
				Grade 2 Laminate	\$2024
72"	30"	28½"	TN7230C	Grade 1 Laminate	\$2025
				Grade 2 Laminate	\$2112

Train 90° Corner Tops

DESIGN VECTA DESIGN TEAM AND IDEO

SIN 711.11



Tip: Shipped knocked down.

Standard Includes	Required to Specify
<ul style="list-style-type: none"> ▶ Need help? Product details, see <i>Coalesse Tables, Storage, and Accessories Specification Guide</i> • Top: 1" particle board core with High-Pressure Laminate • Edge: black soft rolled front edge with black vinyl • Connecting hardware 	<ul style="list-style-type: none"> 1 Style number 2 Laminate color number for top 3 Options, if selected (see below) ▶ See <i>Coalesse Surface Materials Reference Guide</i>.

Options	Price	Required to Specify
Surface Materials <ul style="list-style-type: none"> • Grade 2 laminate 	Prices below	Specify with <i>Grade 2 laminate</i> and select color number.
Corner raceways (for 4-circuit electrical system connection only) <ul style="list-style-type: none"> • Corner raceway with four-circuit, 3+1 electrical system • Corner raceway with four-circuit, 2+2 electrical system • Corner raceway with three-circuit, separate neutrals electrical system • Corner raceway with no electrical system harness or power blocks 	<ul style="list-style-type: none"> +\$423 +\$423 +\$423 +\$423 	<ul style="list-style-type: none"> Specify with <i>3+1 corner raceway</i>. Specify with <i>2+2 corner raceway</i>. Specify with <i>separate neutrals corner raceway</i>. Specify corner raceway with no electrical.
Jumper (for 2-circuit modular table power kit connection only) <ul style="list-style-type: none"> • Jumper kit with one male and one female modular connector 	+\$ 64	Specify with <i>jumper kit</i> .

Tip: All electrical system components (raceways, receptacles, base power infeeds, etc.) must be the same wiring schematic: 3+1, 2+2, or three-circuit, separate neutrals.

Tip: When using modular table power kits and connecting tops, a jumper kit must be specified for the corner, in order to maintain the power connection from table to table.

Tip: The modular table power jumper kit is a 2-circuit system and is not compatible with the 4-circuit electrical in the raceway. The connectors are also not compatible.

Specification Information			
Dimension W	Style Number	Finish	Base Price
			<p>Train Vinyl Edge:</p>

90° Corner Tops

24"	TN90D24	Grade 1 Laminate	\$570
		Grade 2 Laminate	\$595
30"	TN90D30	Grade 1 Laminate	\$623
		Grade 2 Laminate	\$664

Glides



Standard Includes		Required to Specify
<ul style="list-style-type: none"> Set of four glides for field retrofit: textured black powder coat 		Style number
Specification Information		
Style Number	Price	
TNGL	\$162	

Four-Circuit Receptacles



Tip: For alternative wiring configurations, see Options.

Tip: All electrical system components (raceways, receptacles, base power infeeds, etc.) must be the same wiring schematic: 3+1, 2+2, or three-circuit, separate neutrals.

Tip: Four-circuit receptacles are only compatible with raceway with electrical.

Standard Includes		Required to Specify
<ul style="list-style-type: none"> Duplex receptacle: black plastic only Four circuit, 3+1 wiring configuration 		1 Style number 2 Options, if selected (see below)
Options	Price	Required to Specify
Four-circuit, 2+2 wiring configuration	<ul style="list-style-type: none"> Four-circuit, 2+2 wiring configuration No cost	Add suffix Y to the style number.
Three-circuit, separate neutrals wiring configuration	<ul style="list-style-type: none"> Three-circuit, separate neutrals wiring configuration No cost	Add suffix Z to the style number.
Specification Information		
Style Number	Price	
Circuit 1		
321891	\$24	
Circuit 2		
321892	\$24	
Circuit 3		
321893	\$24	
Circuit 4, Isolated		
321894	\$24	

PODs

Tip: PODs in Train tables are specified by selecting the POD option when specifying a Train table. These PODs are field-installed and are not intended for use with tables other than Train.

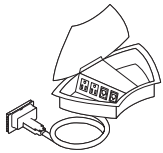
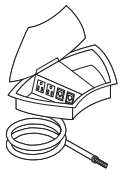

Tip: The modular POD connects to the power block in the raceway in place of a duplex receptacle.

Tip: Modular POD is only compatible with raceway with electrical.

Standard Includes	Required to Specify
<ul style="list-style-type: none"> Power and communication module with hinged cover: black plastic with black painted steel septum to separate power and data Two-port furniture faceplates, amp 	Style number

Specification Information

Style Number	Price
--------------	-------

9' Cord with Plug

PODPL	\$345
-------	-------

6' Conduit for Hardwire

PODHW	\$345
-------	-------

3' Conduit with Modular Connector

Circuit 1	
PODMD1	\$361
Circuit 2	
PODMD2	\$361
Circuit 3	
PODMD3	\$361
Circuit 4	
PODMD4	\$361

Axil Z, Cord

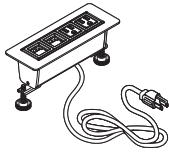

Tip: The Axil Z desktop module will ship with instructions and a hole cutout template for field installation, if needed.

Tip: For a factory installed cutout in the table top, specify Axil Z as an option for Train. If you do not specify Axil Z as an option, where applicable, the table top will require a field installed cutout.

► See Coalesse Tables, Storage, and Accessories Specification Guide for cutout locations.

Tip: For any other tables, other than Train, that require an Axil Z desktop module, a special engineering quote is mandatory. If you require a factory installed cutout in a location other than standard, send us a drawing with measurements indicating the exact location(s) required in the table top.

Tip: USB for charging is configured in the spot of one data port and is always configured on the end(s).

Tip: For each USB port specified, there are two USBs per port.

Tip: When a four power Axil Z or Ellora corded device is specified, the 15-amp plug end requires a circuit breaker, therefore the plug end is different.

Standard Includes **Required to Specify**

- Desktop module, mounts flat just above worksurface:
 - 4140 Arctic White
 - 4144 Black Gloss
- 6' power cord with 15-amp plug
- Requires 6¾" x 2" cutout
- Utilizes water-proof simplexes (outlets)
- UL listed
- Voice|Data adaptor kit to accept couplers and jacks when needed (refer to telecommunications reference chart)

- 1 Style number
- 2 Desktop module configuration (see Required Selections below)
- 3 Paint color number for desktop module

Options **Price** **Required to Specify**

Options	Price	Required to Specify
Power/Data/USB Configuration		
• Two power/two data	No cost	Specify with two power/two data and select color number.
• Two power/one data/one USB	+\$100	Specify with two power/two data/one USB and select color number.
• Two power/two USB	+\$201	Specify with two power/two USB and select color number.
• Three power/one data	+\$ 5	Specify with three power/one data and select color number.
• Three power/one USB	+\$106	Specify with three power/one USB and select color number.
• Four power	+\$ 69	Specify with four power and select color number.

Specification Information

Dimensions			Style Number	Base Price
D	W	H		
3"	8"	2¾"	CODPA4	\$201

Train

Axil Z, Hardwire

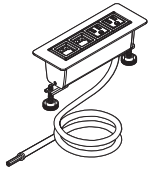

Tip: The Axil Z desktop module will ship with instructions and a hole cutout template for field installation, if needed.

Tip: For a factory installed cutout in the table top, specify Axil Z as an option for Train. If you do not specify Axil Z as an option, where applicable, the table top will require a field installed cutout.

► See Coalesse Tables, Storage, and Accessories Specification Guide for cutout locations.

Tip: For any other tables, other than Train, that require an Axil Z desktop module, a special engineering quote is mandatory. If you require a factory installed cutout in a location other than standard, send us a drawing with measurements indicating the exact location(s) required in the table top.

Tip: USB for charging is configured in the spot of one data port and is always configured on the end(s).

Tip: For each USB port specified, there are two USBs per port.

Tip: The hardwire Axil Z desktop module does not work with modular table power kits.

Tip: If a hardwire Axil Z desktop module is desired, then it should only be specified on tables with glides.

Standard Includes	Required to Specify
<ul style="list-style-type: none"> • Desktop module, mounts flat just above worksurface: <ul style="list-style-type: none"> - 4140 Arctic White - 4144 Black Gloss • 6' flexible steel hardwire conduit • Requires 6³/₄" x 2" cutout • Utilizes water-proof simplex (outlets) • UL listed • Voice/data adaptor kit to accept couplers and jacks when needed (refer to telecommunications reference chart) 	<ol style="list-style-type: none"> 1 Style number 2 Desktop module configuration (see Required Selections below) 3 Paint color number for desktop module

Options	Price	Required to Specify
Power/Data/USB Configuration		
• Two power/two data	No cost	Specify with two power/two data and select color number.
• Two power/one data/one USB	+\$100	Specify with two power/one data/one USB and select color number.
• Two power/two USB	+\$201	Specify with two power/two USB and select color number.
• Three power/one data	+\$ 5	Specify with three power/one data and select color number.
• Three power/one USB	+\$106	Specify with three power/one USB and select color number.
• Four power	+\$ 69	Specify with four power and select color number.

Specification Information				
Dimensions			Style Number	Base Price
D	W	H		
3"	8"	2 ³ / ₈ "	CODHA4	\$201

Ellora, cord

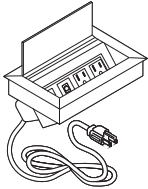

Tip: The Ellora desktop module will ship with instructions and a hole cutout template for field installation, if needed.

Tip: For a factory installed cutout in the table top, specify Ellora as an option for Train. If you do not specify Ellora as an option, where applicable, the table top will require a field installed cutout.

► See Coalesse Tables, Storage, and Accessories Specification Guide for cutout locations.

Tip: For any other tables, other than Train, that require an Ellora desktop module, a special engineering quote is mandatory. If you require a factory installed cutout in a location other than standard, send us a drawing with measurements indicating the exact location(s) required in the table top.

Tip: USB for charging is configured in the spot of one data port and is always configured on the end(s).

Tip: For each USB port specified, there are two USBs per port.

Tip: When a four power Axil Z or Ellora corded device is specified, the 15-amp plug end requires a circuit breaker, therefore the plug end is different.

Standard Includes **Required to Specify**

- Desktop module with lid, mounts flat just above worksurface: anodized aluminum with black faceplate
 - 6' power cord with 15-amp plug
 - Requires 8" x 5" cutout
 - Utilizes water-proof simplex (outlets)
 - UL listed
 - Voice/data adaptor kit to accept couplers and jacks when needed (refer to telecommunications reference chart)
- 1 Style number
2 Desktop module configuration (see Required Selections below)

Options **Price** **Required to Specify**

Power/Data/USB Configuration	Options	Price	Required to Specify
	• Two power/two data	No cost	Specify with two power/two data.
	• Two power/one data/one USB	+\$100	Specify with two power/one data/one USB.
	• Two power/two USB	+\$201	Specify with two power/two USB.
	• Three power/one data	+\$ 5	Specify with three power/one data.
	• Three power/one USB	+\$106	Specify with three power/one USB.
	• Four power	+\$ 69	Specify with four power.

Specification Information

Dimensions			Style Number	Base Price
D	W	H		
5¼"	8¼"	3½"	CODPE4	\$317



Ellora, Hardware

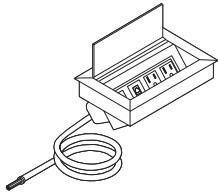

Tip: The Ellora desktop module will ship with instructions and a hole cutout template for field installation, if needed.

Tip: For a factory installed cutout in the table top, specify Ellora as an option for Train. If you do not specify Ellora as an option, where applicable, the table top will require a field installed cutout.

► See *Coalesse Tables, Storage, and Accessories Specification Guide* for cutout locations.

Tip: For any other tables, other than Train, that require an Ellora desktop module, a special engineering quote is mandatory. If you require a factory installed cutout in a location other than standard, send us a drawing with measurements indicating the exact location(s) required in the table top.

Tip: USB for charging is configured in the spot of one data port and is always configured on the end(s).

Tip: For each USB port specified, there are two USBs per port.

Tip: The hardware Ellora desktop module does not work with modular table power kits.

Tip: If a hardware Ellora desktop module is desired, then it should only be specified on tables with glides.

Standard Includes **Required to Specify**

- Desktop module with lid, mounts flat just above worksurface: anodized aluminum with black faceplate
 - 6' flexible steel hardware conduit
 - Requires 8" x 5" cutout
 - Utilizes water-proof simplex (outlets)
 - UL listed
 - Voice/data adaptor kit to accept couplers and jacks when needed (refer to telecommunications reference chart)
- 1 Style number
 2 Desktop module configuration (see Required Selections below)

Options **Price** **Required to Specify**

Power/Data/USB Configuration	Options	Price	Required to Specify
	• Two power/two data	No cost	Specify with two power/two data.
	• Two power/one data/one USB	+\$100	Specify with two power/one data/one USB.
	• Two power/two USB	+\$201	Specify with two power/two USB.
	• Three power/one data	+\$ 5	Specify with three power/one data.
	• Three power/one USB	+\$106	Specify with three power/one USB.
	• Four power	+\$ 69	Specify with four power.

Specification Information

Dimensions			Style Number	Base Price
D	W	H		
5¼"	8¼"	3½"	CODHE4	\$317

Four-Circuit, Hardwire Base Power Infeed

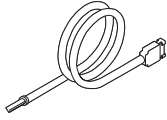

Tip: For alternative wiring configurations, see Options.

Tip: All electrical system components (raceways, receptacles, base power infeeds, etc.) must be the same wiring schematic: 3+1, 2+2, or three-circuit, separate neutrals.

Tip: Four-circuit hardwire base power infeed is only compatible with raceway with electrical.

Standard Includes		Required to Specify
<ul style="list-style-type: none"> Four-circuit power infeed with eight-wire pig tail for hardwire connection on one end and modular connector on the other end, 6'L: black 		1 Style number 2 Options, if selected (see below)

Options	Price	Required to Specify
Four-circuit, 2+2 wiring configuration <ul style="list-style-type: none"> Four-circuit, 2+2 wiring configuration 	No cost	Add suffix Y to the style number.
Three-circuit, separate neutrals wiring configuration <ul style="list-style-type: none"> Three-circuit, separate neutrals wiring configuration 	No cost	Add suffix Z to the style number.

Specification Information	
Style Number	Price
TNBPIHW	\$304
Approved for Use in New York City	
TNBPINY	\$304

Train

Four-Circuit Modular Base Power Infeeds

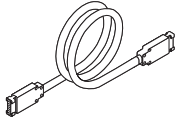

Tip: Modular base power infeed requires four-circuit wall jack, 321899.

► See below

Tip: For alternative wiring configurations, see Options.

Tip: All electrical system components (raceways, receptacles, base power infeeds, etc.) must be the same wiring schematic: 3+1, 2+2, or three-circuit, separate neutrals.

Tip: Four-circuit modular base power infeed is only compatible with raceway with electrical.

Standard Includes		Required to Specify
<ul style="list-style-type: none"> Four-circuit power infeed with modular connectors on both ends, 6'L: black 		1 Style number 2 Options, if selected (see below)

Options	Price	Required to Specify
Four-circuit, 2+2 wiring configuration <ul style="list-style-type: none"> Four-circuit, 2+2 wiring configuration 	No cost	Add suffix Y to the style number.
Three-circuit, separate neutrals wiring configuration <ul style="list-style-type: none"> Three-circuit, separate neutrals wiring configuration 	No cost	Add suffix Z to the style number.

Specification Information	
Style Number	Price
TNBPIMD	\$304

Four-Circuit Wall Jack/Faceplate

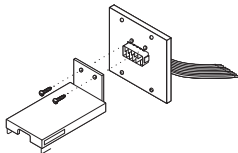

Tip: Wall jack requires 4 1/16" square wall junction box, not included.

Tip: Wall jack requires modular base power infeed.

► See above

Tip: Four-circuit wall jack is only compatible with raceway with electrical.

Standard Includes		Required to Specify
<ul style="list-style-type: none"> Wall jack with four-circuit modular connector: black Strain relief bracket 		1 Style number 2 Options, if selected (see below)

Options	Price	Required to Specify
Four-circuit, 2+2 wiring configuration <ul style="list-style-type: none"> Four-circuit, 2+2 wiring configuration 	No cost	Add suffix Y to the style number.
Three-circuit, separate neutrals wiring configuration <ul style="list-style-type: none"> Three-circuit, separate neutrals wiring configuration 	No cost	Add suffix Z to the style number.

Specification Information	
Style Number	Price
321899	\$65

Single-Circuit 20-Amp Plug Base Power Infeed

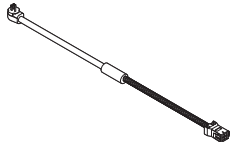

Tip: The hardwire desktop modules do not work with modular table power kits, therefore, do not require any type of infeeds.

Tip: The plug infeed can only be used with circuit 1 modular table power kits.

Tip: Plug infeed can be used on tables with glides or casters.

Standard Includes	Required to Specify
<ul style="list-style-type: none"> Single circuit (circuit 1) power infeed with 20-amp plug on one end and male modular connection on the other end: 24" of thick rubber on plug end with coupler attaching 48" of conduit with modular connection UL recognized 	Style number

Specification Information		
Dimensions Length	Style Number	Price
72"	COBPIFMP20	\$227

Two-Circuit Hardwire Base Power Infeed



Tip: The hardwire desktop modules do not work with modular table power kits, therefore, do not require any type of infeeds.

Tip: The hardwire infeed must be used on tables with glides only.

Standard Includes	Required to Specify
<ul style="list-style-type: none"> 2 circuit power infeed with 4-wire pigtail for hardwire connection on one end and male modular connection on the other end: flexible steel conduit UL listed 	Style number

Specification Information		
Dimensions Length	Style Number	Price
72"	COBPIFMH	\$243

Train

Train Accessories *continued*

DESIGN VECTA DESIGN TEAM AND IDEO

SIN 711.11

Power Strip

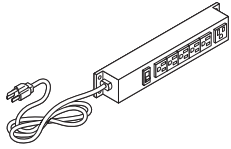

10½"L x 1¾"W x 1½"D

Standard Includes	Required to Specify
<ul style="list-style-type: none">• Power strip with 15' cord and three-prong plug; black• Six 15-amp power outlets• On-off switch• Surge suppressor	Style number

Specification Information

Style Number	Price
793330	\$256

Conference Tables

Overview	112
Statement of Line	113

E-Table 2 (SIN 711.11)	127
Host Collection (SIN 711.11)	163
Reunion Collection (SIN 711.11)	285
SW_1 (SIN 711.11)	305

Overview

Cafeteria/Dining/Commons

- Reunion Collection, page 285

Conference/Boardroom/Private Office

- E-Tables 2, page 127
- Host, page 163

Training/Multi-Purpose/Classroom

- Reunion Collection, page 285

Statement of Line

E-Table 2

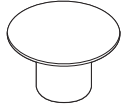

Specifying
▶ Page 128

E-Table 2 Round Tables

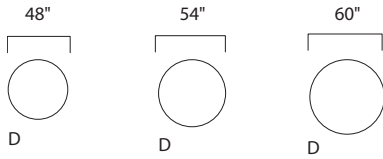

D = Drum base

Veneer and woodgrain
laminate direction



Statement of Line *continued*

E-Table 2, continued

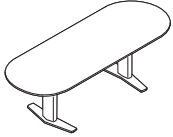

Specifying
▶ Pages 130-150

E-Table 2 Racetrack Tables

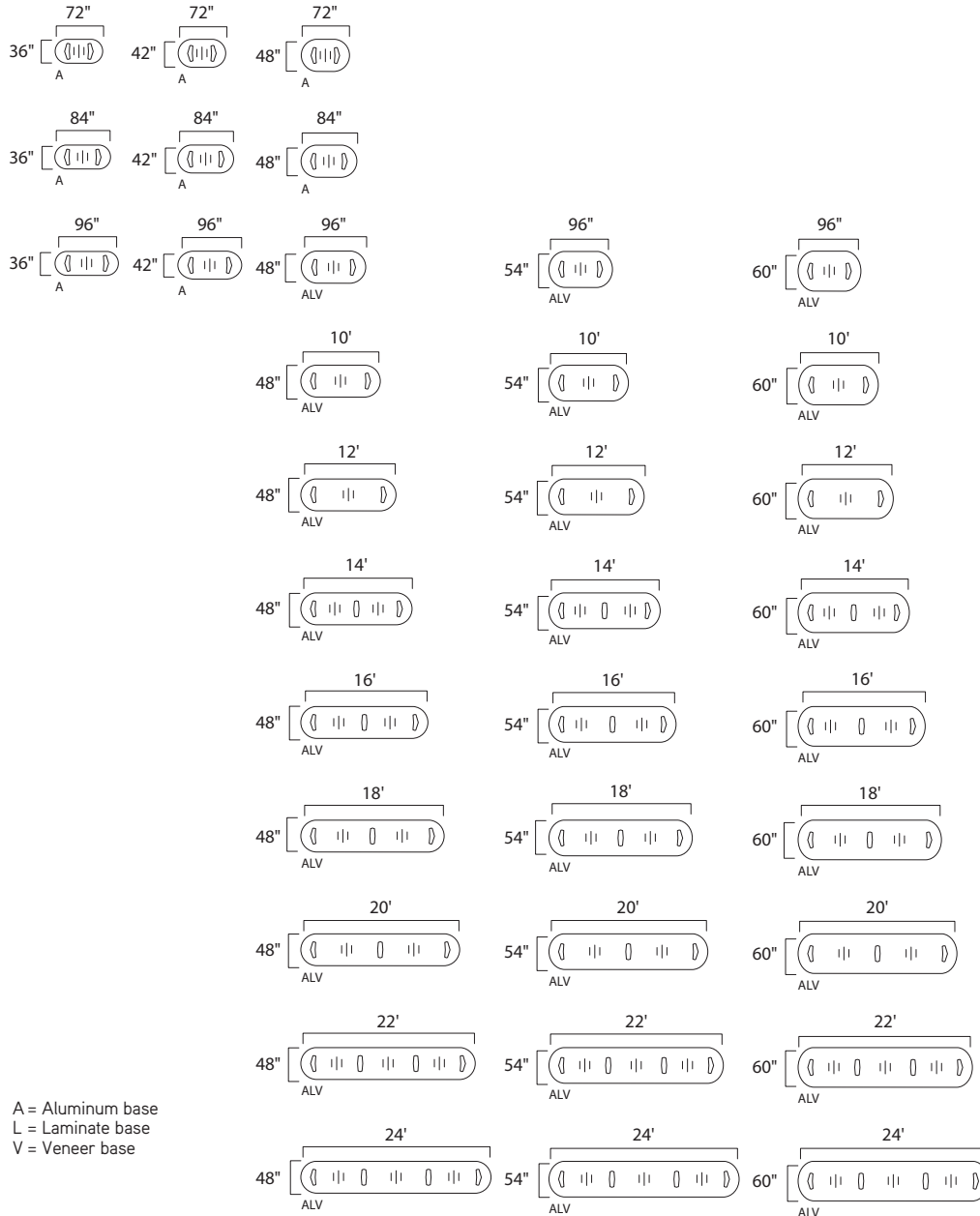

A = Aluminum base
L = Laminate base
V = Veneer base

Veneer and woodgrain
laminate direction

Statement of Line

E-Table 2, continued

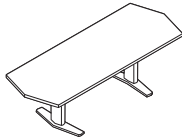

Specifying
▶ Pages 130-150

E-Table 2 Faceted Tables

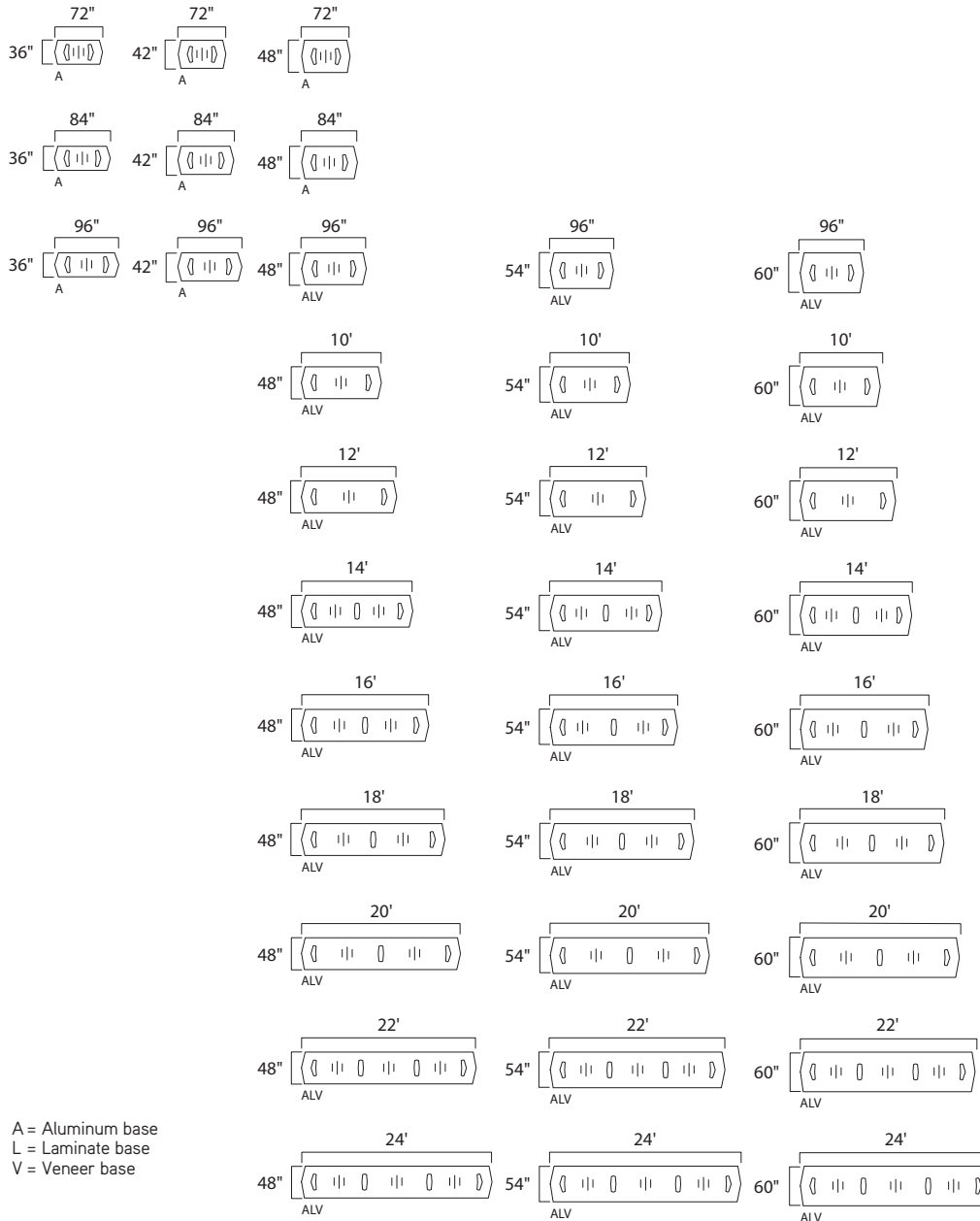

A = Aluminum base
L = Laminate base
V = Veneer base

Veneer and woodgrain
laminates direction

Conference Tables

Statement of Line *continued*

E-Table 2, continued

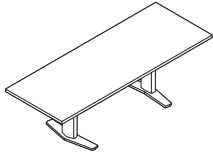

Specifying
▶ Pages 130-150

E-Table 2 Rectangular Tables

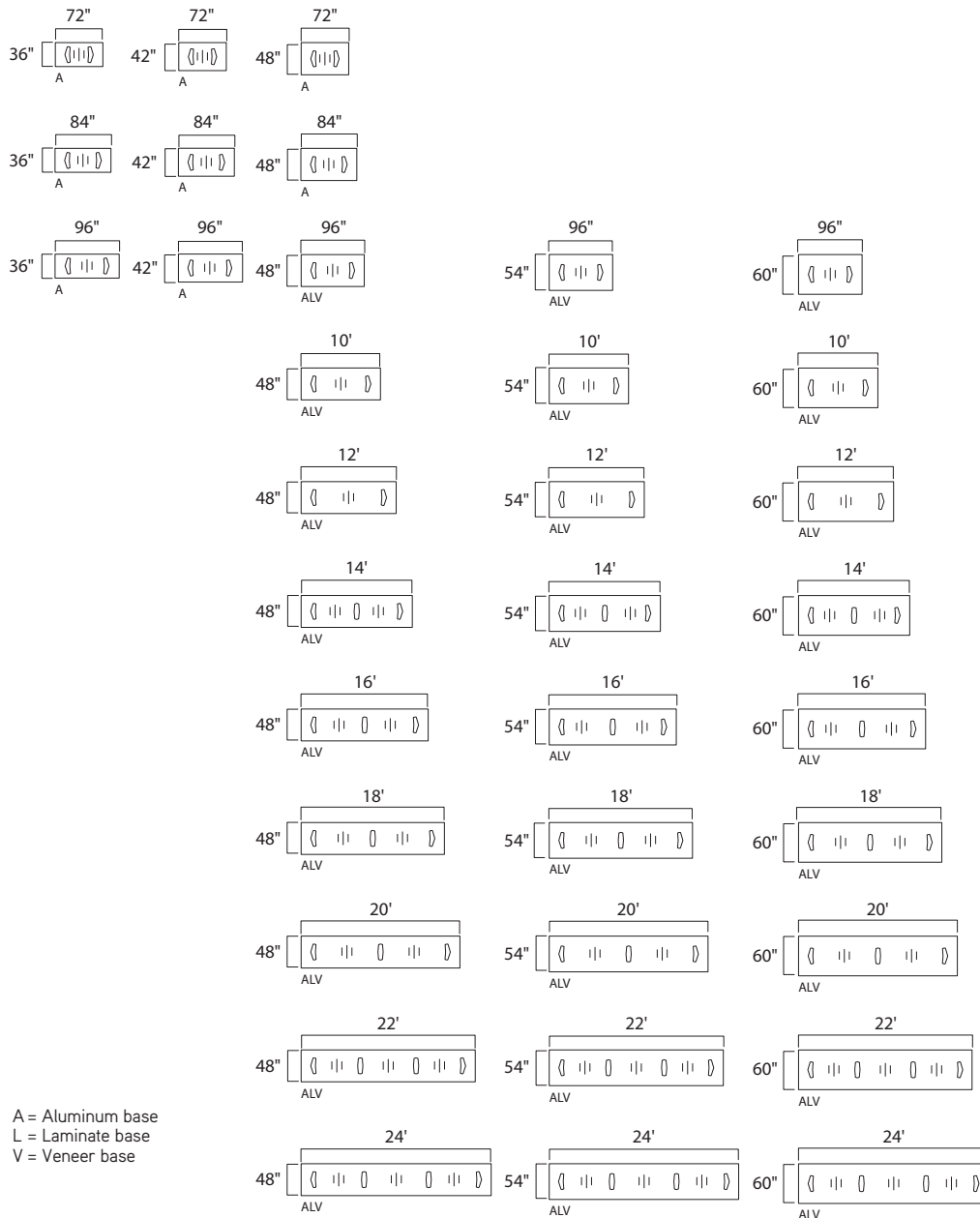

A = Aluminum base
L = Laminate base
V = Veneer base

Veneer and woodgrain
laminate direction



Statement of Line

E-Table 2, continued

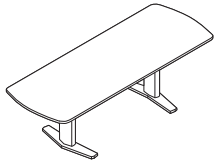

Specifying
▶ Pages 130–150

E-Table 2 Soft Radiused End Tables

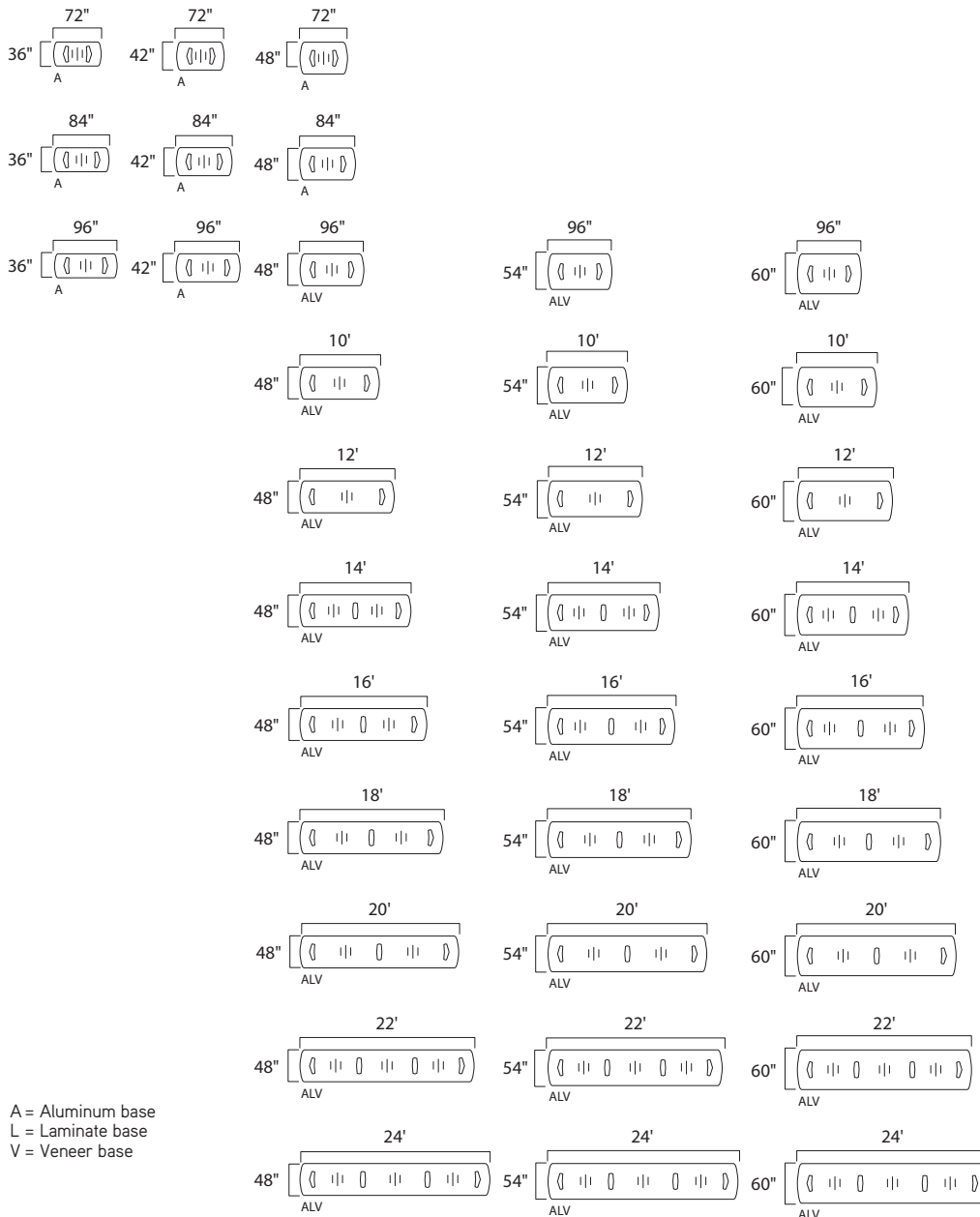

A = Aluminum base
L = Laminate base
V = Veneer base

Veneer and woodgrain
laminate direction

Conference Tables

Statement of Line *continued*

E-Table 2, continued

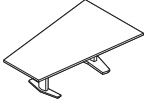

Specifying
▶ Pages 156-158

E-Table 2 Trapezoids Tables

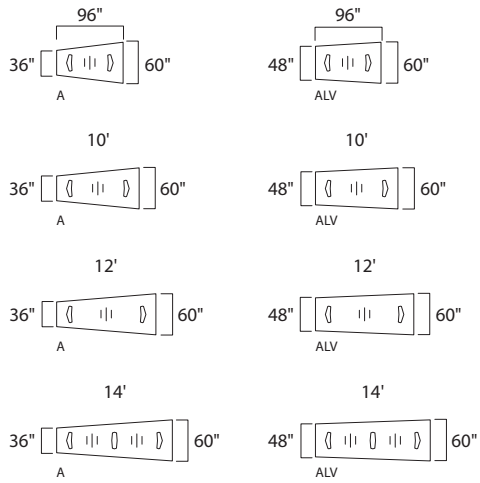

A = Aluminum base
L = Laminate base
V = Veneer base

Veneer and woodgrain
laminate direction

Statement of Line

Host Collection



Specifying
▶ Page 164

Host Round Tables



Veneer and woodgrain
laminate direction



Wedge direction

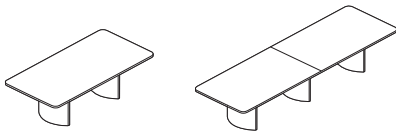

Specifying
▶ Pages 166-174

Host Rectangular Tables

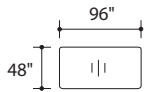

Veneer direction

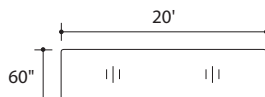
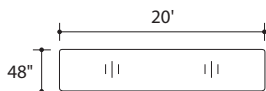
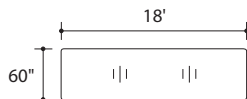
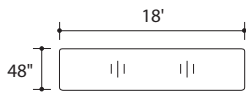
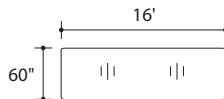
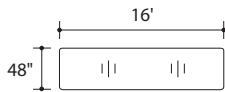
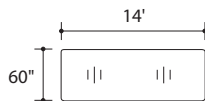
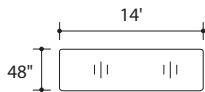
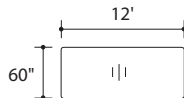
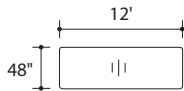
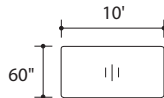
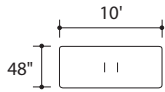

Statement of Line *continued*

Host Collection, continued

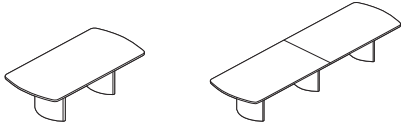

Specifying
▶ Pages 194–204

Host Soft Radiused Tables

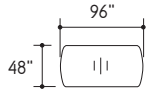

Veneer direction

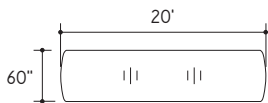
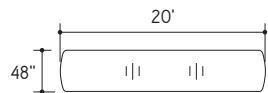
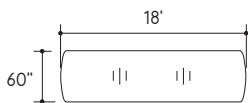
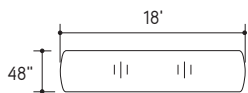
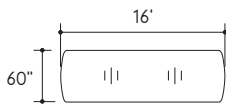
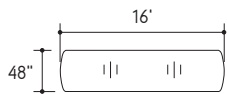
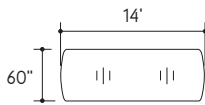
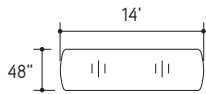
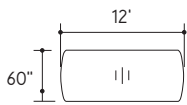
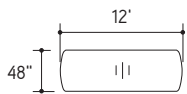
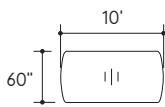
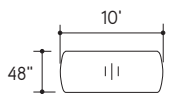

Statement of Line

Host Collection, continued

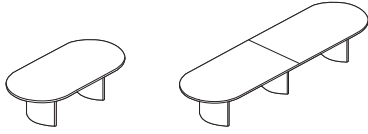

Specifying
► Pages 224–236

Host Racetrack Tables

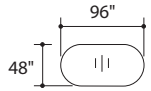

Veneer direction |||

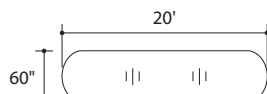
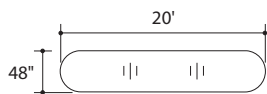
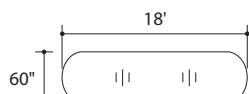
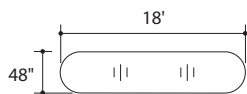
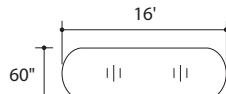
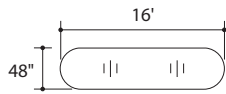
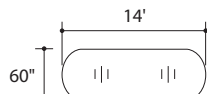
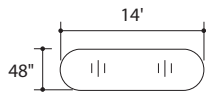
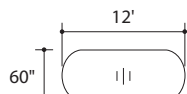
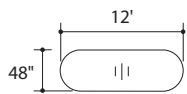
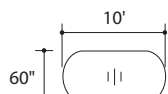
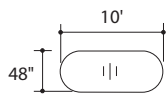

Statement of Line *continued*

Host Collection, continued

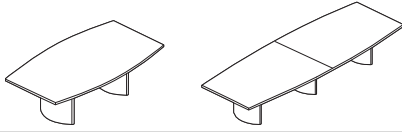

Specifying
▶ Pages 256-264

Host Boat Shaped Tables

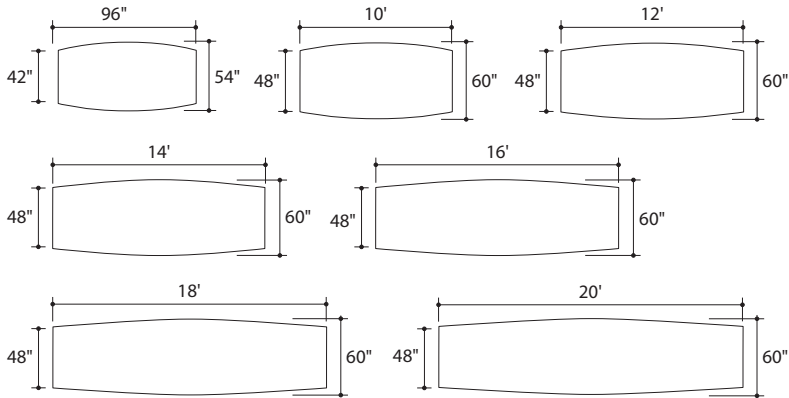

Veneer direction

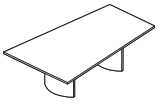

Specifying
▶ Page 276

Host Trapezoid Tables with Two Bases

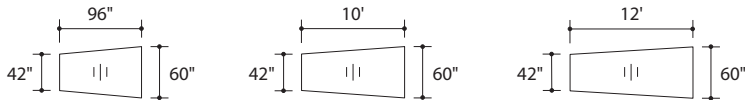

Veneer direction

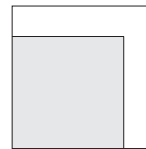

Flat, bullnose, and
beveled wood edges
with square corners

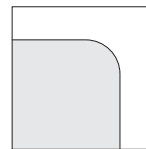

Tapered and horizon
wood edges with
4" radius corners

Statement of Line

Reunion

Seminar Tables

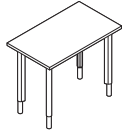

Specifying
▶ Pages 286–290

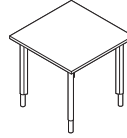

Specifying
▶ Pages 294–296

Reunion Rectangular, Snap Legs

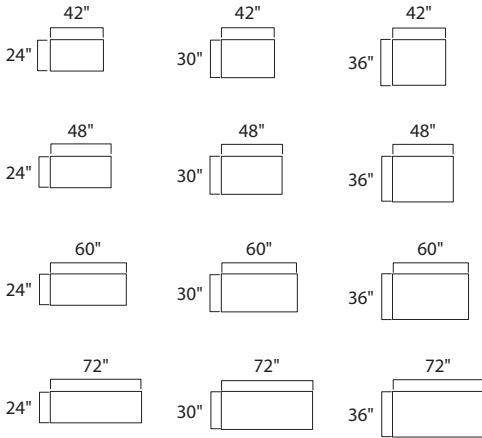

Veneer direction

Reunion Square, Snap Legs

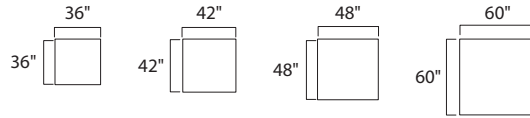

Veneer direction



Specifying
▶ Pages 298–299



Specifying
▶ Pages 300–301

Reunion Trapezoid, Snap Legs

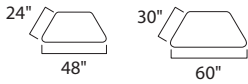

Veneer direction

Reunion Half Round, Snap Legs

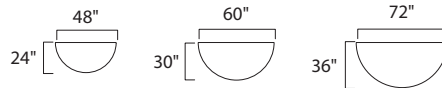

Veneer direction



Specifying
▶ Page 302

Reunion Connecting Tops

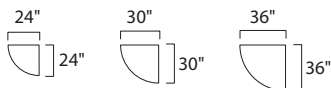

Veneer direction

Statement of Line *continued*

SW_1



Large Round
One-Piece Top

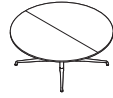

Large Round
Two-Piece Top



Square



Large Square
One-Piece Top



Rectangular
One-Piece Top

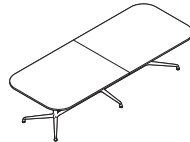

Rectangular
Two-Piece Top



Super Elliptical
One-Piece Top

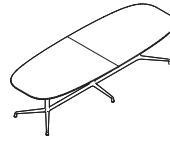

Super Elliptical
Two-Piece Top

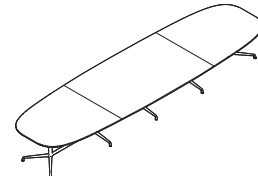

Super Elliptical
Three-Piece Top

Specifying
▶ Pages 306-310

SW_1 Conference Tables

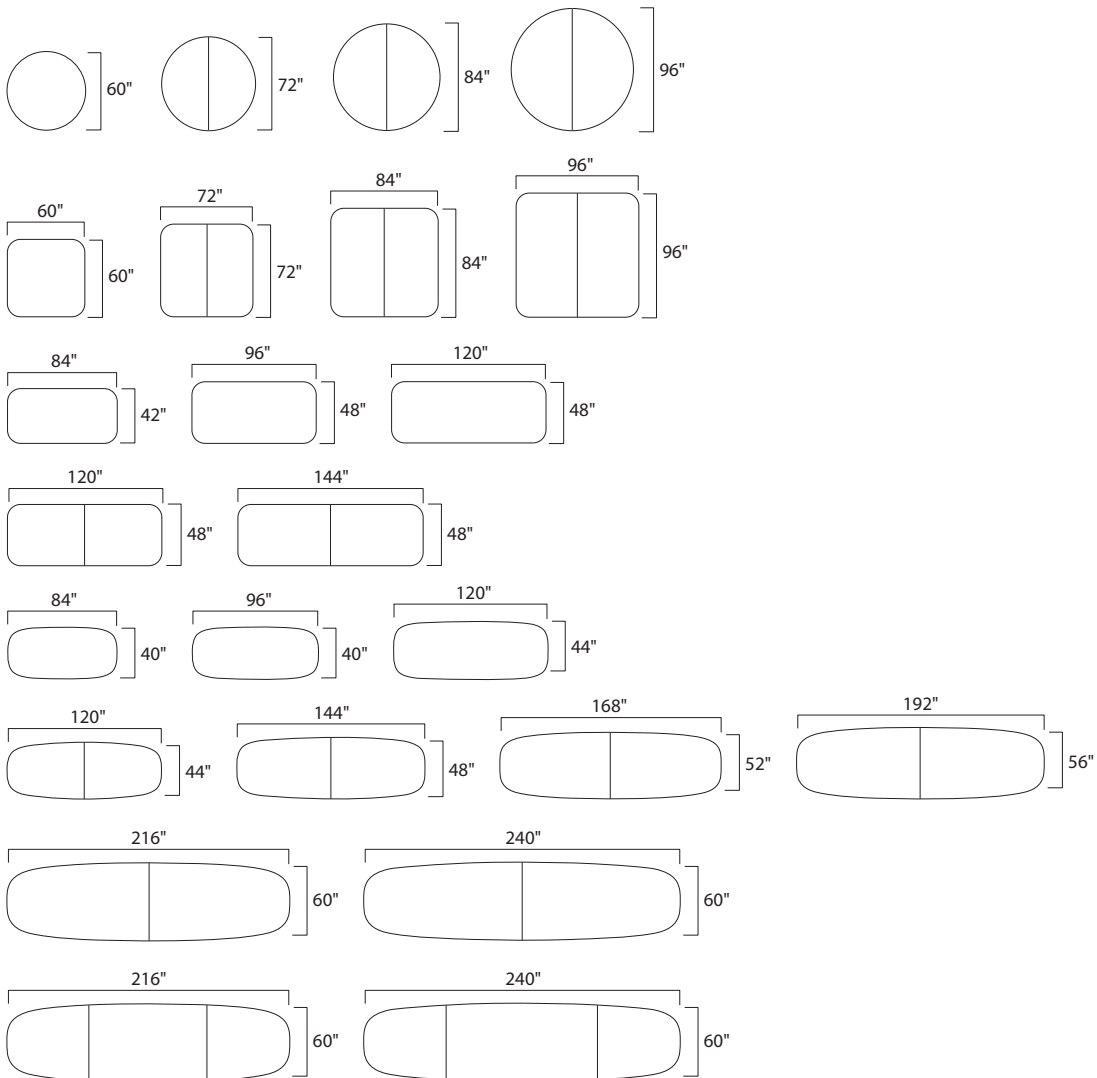

Statement of Line

SW_1, continued



Round



Square



Super Square

Specifying
▶ Page 314

SW_1 Round, Square, and Super-Square Tables

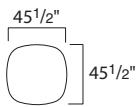
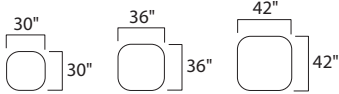
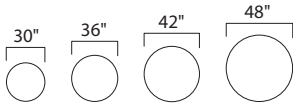

Round



Large Round



Square

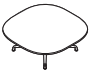

Super Square



Large Square

Specifying
▶ Page 316



Rectangular



Super Elliptical

Specifying
▶ Page 318

SW_1 Occasional Tables

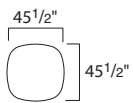
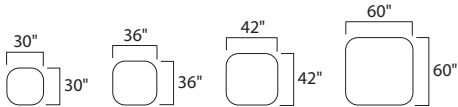
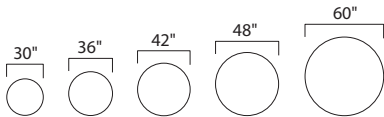

SW_1 Work Tables

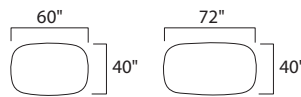
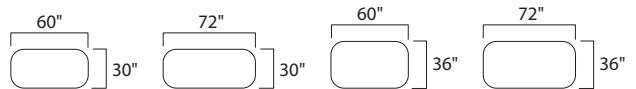

Conference Tables

E-Table 2

48", 54", and 60" Diameter Round Tables (SIN 711.11)	128
72"L, 84"L, and 96"L Racetrack, Faceted, Rectangular, and Soft Radiused End Tables (SIN 711.11)	130
96"L, 10'L, and 12'L Racetrack, Faceted, Rectangular, and Soft Radiused End Tables (SIN 711.11)	136
14'L, 16'L, 18'L, and 20'L Racetrack, Faceted, Rectangular, and Soft Radiused End Tables (SIN 711.11)	142
22'L and 24'L Racetrack, Faceted, Rectangular, and Soft Radiused End Tables (SIN 711.11)	150
36"W Trapezoid Tables with Aluminum Base Only (SIN 711.11)	156
48"W Trapezoid Tables (SIN 711.11)	158
Accessories (SIN 711.11)	161

E-Table 2

DESIGN JEFF CRONK

48", 54", and 60" Diameter Round Tables

SIN 711.11

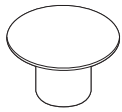

Tip: Shipped knocked down.

Tip: Top ships in one piece.

Tip: 1 mm self-edge is only available on a laminate top surface.

Tip: When a flat, plastic edge is specified on a veneer top, 6000 Black is the only edge finish available.

Tip: When a 3 mm wood edge is specified on a wood veneer top, the edge finish will match the top finish.

Tip: Flat edge is only available on wood veneer tops and is offered in 6000 Black only.

Tip: Each utility bay comes with two universal faceplate openings that accept customer-supplied faceplates in any of the following sizes: single-gang, double-gang, or triple-gang. ▶ See Coalesse Tables, Storage, and Accessories Specification Guide

Tip: Transformer kit must be the same wiring schematic as the table.

Tip: If you require your table top to be made into two pieces, this can be done as a special. Please contact Customer Service at 1.800.627.6770 to obtain a quote.

Tip: Tables available with zero or one utility bay.

Base veneer and woodgrain laminate direction



Standard Includes		Required to Specify	
▶ Need help? Product details, see <i>Coalesse Tables, Storage, and Accessories Specification Guide</i>	<ul style="list-style-type: none"> • Top: 1¼" particle board core with grade 1 laminate • Edge: 1 mm self-edge (laminate top only), 3 mm plastic edge, 3 mm wood edge, or convex vinyl edge • Base: black laminate on MDF core • Concealed leveling glides: non-marring, black plastic 	<ol style="list-style-type: none"> 1 Style number 2 Laminate color number for top 3 Edge selection: <ul style="list-style-type: none"> - 1 mm self-edge (laminate top only) to match laminate top, if selected - 3 mm flat plastic edge color number, if selected - Convex vinyl edge, if selected: <ul style="list-style-type: none"> 6000 Black 6607 Woodrose 6609 Smoke 6655 Warm White 4 Options, if selected (see below) 	▶ See <i>Surface Materials</i> , page 350.
Surface Materials	Options	Price	Required to Specify
	Top		
	• Grade 2 laminate	Prices at right	Specify with <i>Grade 2 laminate</i> and select color number.
	• Grade 1 wood veneer	Prices at right	Specify with <i>Grade 1 wood veneer</i> and select color number.
	• Grade 2 wood veneer	Prices at right	Specify with <i>Grade 2 wood veneer</i> and select color number.
	• Grade 1 wedge lay-up veneer	Prices at right	Specify with <i>Grade 1 wedge lay-up veneer</i> and select color number.
	• Grade 2 wedge lay-up veneer	Prices at right	Specify with <i>Grade 2 wedge lay-up veneer</i> and select color number.
	• Stain-to-Match	No cost	Specify with <i>Stain-to-Match</i> . ▶ Page 385
	Base		
	• Curated laminate base	+\$512	Specify with <i>curated laminate</i> and select color number.
	• Wood base	+\$665	Replace L suffix in the style number with V suffix and select wood color number.
	Edges		
	Wood veneer tops		
	• 3 mm plastic edge	Prices at right	Specify with <i>3 mm plastic edge</i> and select color number.
	• 3 mm wood edge	Prices at right	Specify with <i>3 mm wood edge</i> and select color number.
	• Convex vinyl edge	Prices at right	Specify with <i>convex vinyl edge</i> and select color number.
	• Flat edge (6000 Black)	Prices at right	Specify with <i>flat edge</i> .
	Wood veneer and laminate tops		
	• Bullnose wood edge	Prices at right	Specify with <i>bullnose wood edge</i> .
	• Beveled wood edge	Prices at right	Specify with <i>beveled wood edge</i> .
	• Knife wood edge	Prices at right	Specify with <i>knife wood edge</i> .
	Bay Option		
	• No bays	No cost	Specify with <i>no bays</i> .
	• One bay	+\$515	Specify with <i>one bay</i> and select color number.
	Duplex Wiring Schematic		
	Tables with bay door(s)		
	• 3+0 wireway	No cost	Specify with <i>3+0 wireway, duplex</i> .
	• 1+1 hardwire, 2 circuits	No cost	Specify with <i>1+1 hardwire, 2 circuits, duplex</i> .
	• Chicago powerway	No cost	Specify with <i>Chicago powerway</i> .
	USB Wiring Schematic		
	Tables with bay door(s)		
	• 3+0 wireway	+\$140 per bay	Specify with <i>3+0 wireway, USB</i> .
	• 1+1 hardwire, 2 circuits	+\$140 per bay	Specify with <i>1+1 hardwire, 2 circuits, USB</i> .
	Infeed		
	Tables with bay door(s)		
	• Plug (20 amp single circuit)	No cost	Specify with <i>plug</i> .
	• Hardwire	No cost	Specify with <i>hardwire</i> .
	• NYC hardwire infeed	No cost	Specify with <i>NYC hardwire infeed</i> .
	Related Products		
	• Transformer kit		▶ Page 161

▶ Options, continued on next page

E-Table 2

DESIGN JEFF CRONK

48", 54", and 60" Diameter Round Tables

SIN 711.11





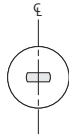

►Options, continued from previous page

Options	Price	Required to Specify
---------	-------	---------------------

Utility Bay Location



Specification Information

Style Number	Finish	Base Prices			
		  			
		1 mm Self-Edge, 3 mm Plastic/ 3 mm Wood Edge, Flat Edge, or Convex Vinyl Edge:	Bullnose Wood Edge:	Beveled Wood Edge:	Knife Wood Edge:

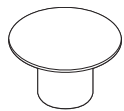

48" Diameter Round Table

E2RND48L	Grade 1 Laminate	\$1658	\$2483	\$2764	\$2997
	Grade 2 Laminate	\$1734	\$2559	\$2840	\$3073
	Grade 1 Wood Veneer	\$2407	\$3232	\$3513	\$3746
	Grade 2 Wood Veneer	\$2659	\$3484	\$3765	\$3998
	Grade 1 Wedge Lay-Up	\$4500	\$5325	\$5606	\$5839
	Grade 2 Wedge Lay-Up	\$4751	\$5576	\$5857	\$6090

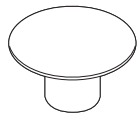

54" Diameter Round Table

E2RND54L	Grade 1 Laminate	\$1878	\$2802	\$3227	\$3547
	Grade 2 Laminate	\$1975	\$2899	\$3324	\$3644
	Grade 1 Wood Veneer	\$3043	\$3967	\$4392	\$4712
	Grade 2 Wood Veneer	\$3364	\$4288	\$4713	\$5033
	Grade 1 Wedge Lay-Up	\$4620	\$5544	\$5969	\$6289
	Grade 2 Wedge Lay-Up	\$4942	\$5866	\$6291	\$6611

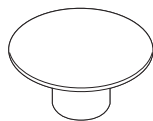

60" Diameter Round Table

E2RND60L	Grade 1 Laminate	\$1881	\$2871	\$3308	\$3715
	Grade 2 Laminate	\$2001	\$2991	\$3428	\$3835
	Grade 1 Wood Veneer	\$3179	\$4169	\$4606	\$5013
	Grade 2 Wood Veneer	\$3570	\$4560	\$4997	\$5404
	Grade 1 Wedge Lay-Up	\$4755	\$5745	\$6182	\$6589
	Grade 2 Wedge Lay-Up	\$5148	\$6138	\$6575	\$6982

E-Table 2

E-Table 2 72"L, 84"L, and 96"L Racetrack, Faceted, Rectangular, and Soft Radiused End Tables with Aluminum Base Only

DESIGN JEFF CRONK

SIN 711.11



Tip: Shipped knocked down.

Tip: Top ships in one piece.

Tip: 1 mm self-edge is only available on a laminate top surface.

Tip: Flat edge is only available on wood veneer tops and is offered in 6000 Black only.

Tip: When a 3 mm wood edge is specified on a wood veneer top, the edge finish will match the top finish.

Tip: If you specify a wood edge on a top with woodgrain laminate, the edge and the top may not match.

Tip: Each utility bay comes with two universal faceplate openings that accept customer-supplied faceplates in any of the following sizes: single-gang, double-gang, or triple-gang.

► See *Coalesse Tables, Storage, and Accessories Specification Guide*

Tip: Transformer kit must be the same wiring schematic as the table.

Tip: For 72"L and 84"L tables, if you require your table top to be made into two pieces, this can be done as a special. Please contact Customer Service at 1.800.627.6770 to obtain a quote.

Tip: Tables available with zero, one, or two utility bays.

Base veneer and woodgrain laminate direction



Standard Includes		Required to Specify	
► Need help? Product details, see <i>Coalesse Tables, Storage, and Accessories Specification Guide</i>	<ul style="list-style-type: none"> • Top: 1¼" particle board core with grade 1 laminate • Edge: 1 mm self-edge (laminate top only), 3 mm plastic edge, 3 mm wood edge, or convex vinyl edge • Two bases: cast and extruded aluminum with powder coat • Wireway: black steel C-channels and side panels and black plastic access door • Concealed leveling glides: non-marring, black plastic 	<ol style="list-style-type: none"> 1 Style number 2 Powder coat color number for base 3 Laminate color number for top 4 Edge selection: <ul style="list-style-type: none"> - 1 mm self-edge (laminate top only) to match laminate top, if selected - 3 mm flat plastic edge color number, if selected - Convex vinyl edge, if selected: <ul style="list-style-type: none"> 6000 Black 6607 Woodrose 6609 Smoke 6655 Warm White 5 Options, if selected (see below) 	<p>► See <i>Surface Materials</i>, page 350.</p>
Surface Materials	Options	Price	Required to Specify
	Top		
	• Grade 2 laminate	Prices at right	Specify with <i>Grade 2 laminate</i> and select color number.
	• Grade 1 wood veneer	Prices at right	Specify with <i>Grade 1 wood veneer</i> and select color number.
	• Grade 2 wood veneer	Prices at right	Specify with <i>Grade 2 wood veneer</i> and select color number.
	• Stain-to-Match	No cost	Specify with <i>Stain-to-Match</i> . ► Page 385
Edges	Wood veneer tops		
	• 3 mm plastic edge	Prices at right	Specify with <i>3 mm plastic edge</i> and select color number.
	• 3 mm wood edge	Prices at right	Specify with <i>3 mm wood edge</i> and select color number.
	• Convex vinyl edge	Prices at right	Specify with <i>convex vinyl edge</i> and select color number.
	• Flat edge (6000 Black)	Prices at right	Specify with <i>flat edge</i> .
	Wood veneer and laminate tops		
	• Bullnose wood edge	Prices at right	Specify with <i>bullnose wood edge</i> .
	• Beveled wood edge	Prices at right	Specify with <i>beveled wood edge</i> .
	• Knife wood edge	Prices at right	Specify with <i>knife wood edge</i> .
	• Waterfall wood edge	Prices at right	Specify with <i>waterfall wood edge</i> .
	• Faceted wood edge	Prices at right	Specify with <i>faceted wood edge</i> .
Sectioned top (96"L only)	• Sectioned top	+\$ 372	Specify with <i>sectioned top</i> .
Bay Option	• No bays	No cost	Specify with <i>no bays</i> .
	• One bay	+\$ 515	Specify with <i>one bay</i> and select color number.
	• Two bays	+\$1030	Specify with <i>two bays</i> and select color number.
Duplex Wiring Schematic	Tables with bay door(s)		
	• 3+0 wireway	No cost	Specify with <i>3+0 wireway, duplex</i> .
	• 1+1 hardwire, 2 circuits	No cost	Specify with <i>1+1 hardwire, 2 circuits, duplex</i> .
	• Chicago powerway	No cost	Specify with <i>Chicago powerway</i> .
USB Wiring Schematic	Tables with bay door(s)		
	• 3+0 wireway	+\$ 140 per bay	Specify with <i>3+0 wireway, USB</i> .
	• 1+1 hardwire, 2 circuits	+\$ 140 per bay	Specify with <i>1+1 hardwire, 2 circuits, USB</i> .
Infeed	Tables with bay door(s)		
	• Plug (20 amp single circuit)	No cost	Specify with <i>plug</i> .
	• Hardwire	No cost	Specify with <i>hardwire</i> .
	• NYC hardwire infeed	No cost	Specify with <i>NYC hardwire infeed</i> .
Related Products	• Transformer kit		► Page 161

► Options, continued on next page

E-Table 2

72"L, 84"L, and 96"L Racetrack, Faceted, Rectangular, and Soft Radiused End Tables with Aluminum Base Only

DESIGN JEFF CRONK

SIN 711.11

►Options, continued from previous page

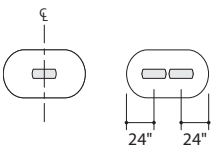
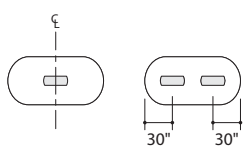
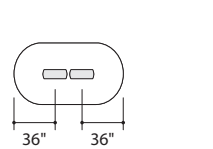
Options		Price	Required to Specify
72"L Utility Bay Location	84"L Utility Bay Location	96"L Utility Bay Location	
			

Specification Information

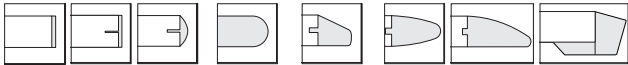
Dimensions L W H	Style Number	Finish	Base Prices
			
			1 mm Self-Edge, 3 mm Plastic/ 3 mm Wood Edge, Flat Edge, or Convex Vinyl Edge:
			Bullnose Wood Edge:
			Beveled Wood Edge:
			Knife Wood Edge, Waterfall Wood Edge, or Faceted Wood Edge:



Tip: Racetrack tables are not available with waterfall or faceted wood edge.

Racetrack Tables with Two Bases

72" 36" 29"	E2C7236A	Grade 1 Laminate	\$3029	\$3639	\$3708	\$3817
		Grade 2 Laminate	\$3118	\$3728	\$3797	\$3906
		Grade 1 Wood Veneer	\$4086	\$4696	\$4765	\$4874
		Grade 2 Wood Veneer	\$4422	\$5032	\$5101	\$5210
72" 42" 29"	E2C7242A	Grade 1 Laminate	\$3271	\$4052	\$4077	\$4224
		Grade 2 Laminate	\$3371	\$4152	\$4177	\$4324
		Grade 1 Wood Veneer	\$4588	\$5369	\$5394	\$5541
		Grade 2 Wood Veneer	\$4950	\$5731	\$5756	\$5903
72" 48" 29"	E2C7248A	Grade 1 Laminate	\$3345	\$4116	\$4143	\$4302
		Grade 2 Laminate	\$3464	\$4235	\$4262	\$4421
		Grade 1 Wood Veneer	\$4597	\$5368	\$5395	\$5554
		Grade 2 Wood Veneer	\$4984	\$5755	\$5782	\$5941
84" 36" 29"	E2C8436A	Grade 1 Laminate	\$3189	\$4086	\$4180	\$4340
		Grade 2 Laminate	\$3289	\$4186	\$4280	\$4440
		Grade 1 Wood Veneer	\$4714	\$5611	\$5705	\$5865
		Grade 2 Wood Veneer	\$5126	\$6023	\$6117	\$6277
84" 42" 29"	E2C8442A	Grade 1 Laminate	\$3312	\$4176	\$4248	\$4400
		Grade 2 Laminate	\$3431	\$4295	\$4367	\$4519
		Grade 1 Wood Veneer	\$4777	\$5641	\$5713	\$5865
		Grade 2 Wood Veneer	\$5225	\$6089	\$6161	\$6313
84" 48" 29"	E2C8448A	Grade 1 Laminate	\$3387	\$4242	\$4318	\$4482
		Grade 2 Laminate	\$3522	\$4377	\$4453	\$4617
		Grade 1 Wood Veneer	\$4783	\$5638	\$5714	\$5878
		Grade 2 Wood Veneer	\$5262	\$6117	\$6193	\$6357

►Specification Information, continued on next page









E-Table 2

E-Table 2 72"L, 84"L, and 96"L Racetrack, Faceted, Rectangular, and Soft Radiused End Tables with Aluminum Base Only *continued*

DESIGN JEFF CRONK

SIN 711.11

► Specification Information, continued from previous page

Specification Information				Base Prices								
Dimensions		Style	Finish									
L	W	H	Number									
												
				1 mm Self-Edge,	3 mm Plastic/ 3 mm Wood Edge,		Flat Edge, or Convex Vinyl Edge:	Bullnose Wood Edge:	Beveled Wood Edge:	Knife Wood Edge, Waterfall Wood Edge, or Faceted Wood Edge:		

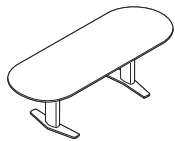

Tip: Racetrack tables are not available with waterfall or faceted wood edge.

Racetrack Tables with Two Bases, continued

Dimensions	Style	Finish	Grade 1	Grade 2	Waterfall	Faceted	
96" 36" 29"	E2C9636A	Grade 1 Laminate	\$3375	\$4220	\$4321	\$4484	
			Grade 2 Laminate	\$3491	\$4336	\$4437	\$4600
			Grade 1 Wood Veneer	\$4799	\$5644	\$5745	\$5908
			Grade 2 Wood Veneer	\$5275	\$6120	\$6221	\$6384
96" 42" 29"	E2C9642A	Grade 1 Laminate	\$3678	\$4543	\$4616	\$4782	
			Grade 2 Laminate	\$3812	\$4677	\$4750	\$4916
			Grade 1 Wood Veneer	\$5137	\$6002	\$6075	\$6241
			Grade 2 Wood Veneer	\$5673	\$6538	\$6611	\$6777

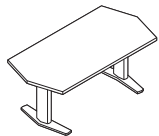

Tip: Faceted tables are not available with waterfall wood edge.

Faceted Tables with Two Bases

Dimensions	Style	Finish	Grade 1	Grade 2	Waterfall	Faceted	
72" 36" 29"	E2F7236A	Grade 1 Laminate	\$3189	\$3799	\$3868	\$3977	
			Grade 2 Laminate	\$3278	\$3888	\$3957	\$4066
			Grade 1 Wood Veneer	\$4246	\$4856	\$4925	\$5034
			Grade 2 Wood Veneer	\$4582	\$5192	\$5261	\$5370
72" 42" 29"	E2F7242A	Grade 1 Laminate	\$3428	\$4209	\$4234	\$4381	
			Grade 2 Laminate	\$3528	\$4309	\$4334	\$4481
			Grade 1 Wood Veneer	\$4745	\$5526	\$5551	\$5698
			Grade 2 Wood Veneer	\$5095	\$5876	\$5901	\$6048
72" 48" 29"	E2F7248A	Grade 1 Laminate	\$3506	\$4277	\$4304	\$4463	
			Grade 2 Laminate	\$3625	\$4396	\$4423	\$4582
			Grade 1 Wood Veneer	\$4758	\$5529	\$5556	\$5715
			Grade 2 Wood Veneer	\$5145	\$5916	\$5943	\$6102
84" 36" 29"	E2F8436A	Grade 1 Laminate	\$3345	\$4242	\$4336	\$4496	
			Grade 2 Laminate	\$3445	\$4342	\$4436	\$4596
			Grade 1 Wood Veneer	\$4704	\$5601	\$5695	\$5855
			Grade 2 Wood Veneer	\$5114	\$6011	\$6105	\$6265
84" 42" 29"	E2F8442A	Grade 1 Laminate	\$3469	\$4333	\$4405	\$4557	
			Grade 2 Laminate	\$3588	\$4452	\$4524	\$4676
			Grade 1 Wood Veneer	\$4934	\$5798	\$5870	\$6022
			Grade 2 Wood Veneer	\$5382	\$6246	\$6318	\$6470
84" 48" 29"	E2F8448A	Grade 1 Laminate	\$3545	\$4400	\$4476	\$4640	
			Grade 2 Laminate	\$3680	\$4535	\$4611	\$4775
			Grade 1 Wood Veneer	\$4941	\$5796	\$5872	\$6036
			Grade 2 Wood Veneer	\$5420	\$6275	\$6351	\$6515

► Specification Information, continued on next page









E-Table 2

72"L, 84"L, and 96"L Racetrack, Faceted, Rectangular, and Soft Radiused End Tables with Aluminum Base Only

DESIGN JEFF CRONK

SIN 711.11

► Specification Information, continued from previous page

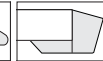
Specification Information				Base Prices								
Dimensions		Style	Finish									
L	W	H	Number									
												
				1 mm Self-Edge, 3 mm Plastic/ 3 mm Wood Edge, Flat Edge, or Convex Vinyl Edge:	Bullnose Wood Edge:	Beveled Wood Edge:	Knife Wood Edge, Waterfall Wood Edge, or Faceted Wood Edge:					

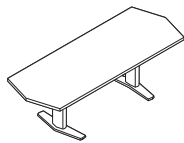

Tip: Faceted tables are not available with waterfall wood edge.

Tip: Vinyl edge profiles on faceted tables require a 4" radius on all corners.

Faceted Tables with Two Bases, continued

Dimensions	Style	Finish	Grade 1	Grade 2	Grade 1	Grade 2	Grade 1	Grade 2
96" 36" 29"	E2F9636A	Grade 1 Laminate	\$3535	\$4380	\$4481	\$4644		
		Grade 2 Laminate	\$3651	\$4496	\$4597	\$4760		
		Grade 1 Wood Veneer	\$4959	\$5804	\$5905	\$6068		
		Grade 2 Wood Veneer	\$5435	\$6280	\$6381	\$6544		
96" 42" 29"	E2F9642A	Grade 1 Laminate	\$3839	\$4704	\$4777	\$4943		
		Grade 2 Laminate	\$3973	\$4838	\$4911	\$5077		
		Grade 1 Wood Veneer	\$5298	\$6163	\$6236	\$6402		
		Grade 2 Wood Veneer	\$5834	\$6699	\$6772	\$6938		

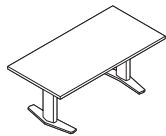

Tip: Vinyl edge profiles on rectangular tables require a 4" radius on all corners.

Rectangular Tables with Two Bases

Dimensions	Style	Grade 1	Grade 2	Grade 1	Grade 2	Grade 1	Grade 2
72" 36" 29"	E2R7236A	Grade 1 Laminate	\$2871	\$3481	\$3550	\$3659	
		Grade 2 Laminate	\$2960	\$3570	\$3639	\$3748	
		Grade 1 Wood Veneer	\$3928	\$4538	\$4607	\$4716	
		Grade 2 Wood Veneer	\$4264	\$4874	\$4943	\$5052	
72" 42" 29"	E2R7242A	Grade 1 Laminate	\$3111	\$3892	\$3917	\$4064	
		Grade 2 Laminate	\$3211	\$3992	\$4017	\$4164	
		Grade 1 Wood Veneer	\$4428	\$5209	\$5234	\$5381	
		Grade 2 Wood Veneer	\$4778	\$5559	\$5584	\$5731	
72" 48" 29"	E2R7248A	Grade 1 Laminate	\$3189	\$3960	\$3987	\$4146	
		Grade 2 Laminate	\$3308	\$4079	\$4106	\$4265	
		Grade 1 Wood Veneer	\$4441	\$5212	\$5239	\$5398	
		Grade 2 Wood Veneer	\$4828	\$5599	\$5626	\$5785	
84" 36" 29"	E2R8436A	Grade 1 Laminate	\$3029	\$3926	\$4020	\$4180	
		Grade 2 Laminate	\$3129	\$4026	\$4120	\$4280	
		Grade 1 Wood Veneer	\$4554	\$5451	\$5545	\$5705	
		Grade 2 Wood Veneer	\$4966	\$5863	\$5957	\$6117	
84" 42" 29"	E2R8442A	Grade 1 Laminate	\$3153	\$4017	\$4089	\$4241	
		Grade 2 Laminate	\$3272	\$4136	\$4208	\$4360	
		Grade 1 Wood Veneer	\$4618	\$5482	\$5554	\$5706	
		Grade 2 Wood Veneer	\$5066	\$5930	\$6002	\$6154	
84" 48" 29"	E2R8448A	Grade 1 Laminate	\$3227	\$4082	\$4158	\$4322	
		Grade 2 Laminate	\$3362	\$4217	\$4293	\$4457	
		Grade 1 Wood Veneer	\$4623	\$5478	\$5554	\$5718	
		Grade 2 Wood Veneer	\$5102	\$5957	\$6033	\$6197	









► Specification Information, continued on next page

E-Table 2 72"L, 84"L, and 96"L Racetrack, Faceted, Rectangular, and Soft Radiused End Tables with Aluminum Base Only *continued*

DESIGN JEFF CRONK

SIN 711.11

► Specification Information, continued from previous page

Specification Information				Base Prices							
Dimensions		Style	Finish								
L	W	H	Number								
											
				1 mm Self-Edge, 3 mm Plastic/ 3 mm Wood Edge, Flat Edge, or Convex Vinyl Edge:	Bullnose Wood Edge:	Beveled Wood Edge:	Knife Wood Edge, Waterfall Wood Edge, or Faceted Wood Edge:				

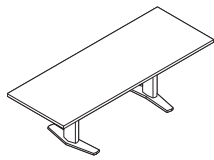

Tip: Vinyl edge profiles on rectangular tables require a 4" radius on all corners.

Rectangular Tables with Two Bases, continued

Dimensions	Style	Finish	1 mm Self-Edge, 3 mm Plastic/ 3 mm Wood Edge, Flat Edge, or Convex Vinyl Edge:	Bullnose Wood Edge:	Beveled Wood Edge:	Knife Wood Edge, Waterfall Wood Edge, or Faceted Wood Edge:
96" 36" 29"	E2R9636A	Grade 1 Laminate	\$3219	\$4064	\$4165	\$4328
		Grade 2 Laminate	\$3335	\$4180	\$4281	\$4444
		Grade 1 Wood Veneer	\$4643	\$5488	\$5589	\$5752
		Grade 2 Wood Veneer	\$5119	\$5964	\$6065	\$6228
96" 42" 29"	E2R9642A	Grade 1 Laminate	\$3522	\$4387	\$4460	\$4626
		Grade 2 Laminate	\$3656	\$4521	\$4594	\$4760
		Grade 1 Wood Veneer	\$4981	\$5846	\$5919	\$6085
		Grade 2 Wood Veneer	\$5517	\$6382	\$6455	\$6621

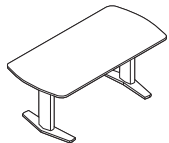

Tip: Vinyl edge profiles on soft radiused tables require a 4" radius on all corners.

Soft Radiused End Tables with Two Bases

Dimensions	Style	Finish	1 mm Self-Edge, 3 mm Plastic/ 3 mm Wood Edge, Flat Edge, or Convex Vinyl Edge:	Bullnose Wood Edge:	Beveled Wood Edge:	Knife Wood Edge, Waterfall Wood Edge, or Faceted Wood Edge:
72" 36" 29"	E2S7236A	Grade 1 Laminate	\$3029	\$3639	N.A.	N.A.
		Grade 2 Laminate	\$3118	\$3728	N.A.	N.A.
		Grade 1 Wood Veneer	\$4086	\$4696	N.A.	N.A.
		Grade 2 Wood Veneer	\$4422	\$5032	N.A.	N.A.
72" 42" 29"	E2S7242A	Grade 1 Laminate	\$3271	\$4052	N.A.	N.A.
		Grade 2 Laminate	\$3371	\$4152	N.A.	N.A.
		Grade 1 Wood Veneer	\$4588	\$5369	N.A.	N.A.
		Grade 2 Wood Veneer	\$4938	\$5719	N.A.	N.A.
72" 48" 29"	E2S7248A	Grade 1 Laminate	\$3345	\$4116	N.A.	N.A.
		Grade 2 Laminate	\$3464	\$4235	N.A.	N.A.
		Grade 1 Wood Veneer	\$4597	\$5368	N.A.	N.A.
		Grade 2 Wood Veneer	\$4984	\$5755	N.A.	N.A.
84" 36" 29"	E2S8436A	Grade 1 Laminate	\$3189	\$4086	N.A.	N.A.
		Grade 2 Laminate	\$3289	\$4186	N.A.	N.A.
		Grade 1 Wood Veneer	\$4714	\$5611	N.A.	N.A.
		Grade 2 Wood Veneer	\$5126	\$6023	N.A.	N.A.
84" 42" 29"	E2S8442A	Grade 1 Laminate	\$3312	\$4176	N.A.	N.A.
		Grade 2 Laminate	\$3431	\$4295	N.A.	N.A.
		Grade 1 Wood Veneer	\$4777	\$5641	N.A.	N.A.
		Grade 2 Wood Veneer	\$5225	\$6089	N.A.	N.A.
84" 48" 29"	E2S8448A	Grade 1 Laminate	\$3387	\$4242	N.A.	N.A.
		Grade 2 Laminate	\$3522	\$4377	N.A.	N.A.
		Grade 1 Wood Veneer	\$4783	\$5638	N.A.	N.A.
		Grade 2 Wood Veneer	\$5262	\$6117	N.A.	N.A.

► Specification Information, continued on next page







E-Table 2

72"L, 84"L, and 96"L Racetrack, Faceted, Rectangular, and Soft Radiused End Tables with Aluminum Base Only

DESIGN JEFF CRONK

SIN 711.11

► Specification Information, continued from previous page

Specification Information				Base Prices						
Dimensions		Style	Finish							
L	W	H	Number							
										
				1 mm Self-Edge, 3 mm Plastic/ 3 mm Wood Edge, Flat Edge, or Convex Vinyl Edge:	Bullnose Wood Edge:	Beveled Wood Edge:	Knife Wood Edge, Waterfall Wood Edge, or Faceted Wood Edge:			

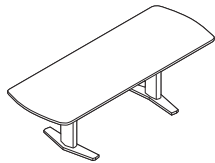

Tip: Vinyl edge profiles on soft radiused tables require a 4" radius on all corners.

Soft Radiused End Tables with Two Bases, continued

96"	36"	29"	E2S9636A	Grade 1 Laminate	\$3375	\$4220	N.A.	N.A.
				Grade 2 Laminate	\$3491	\$4336	N.A.	N.A.
				Grade 1 Wood Veneer	\$4799	\$5644	N.A.	N.A.
				Grade 2 Wood Veneer	\$5275	\$6120	N.A.	N.A.
96"	42"	29"	E2S9642A	Grade 1 Laminate	\$3678	\$4543	N.A.	N.A.
				Grade 2 Laminate	\$3812	\$4677	N.A.	N.A.
				Grade 1 Wood Veneer	\$5137	\$6002	N.A.	N.A.
				Grade 2 Wood Veneer	\$5673	\$6538	N.A.	N.A.

E-Table 2

96"L, 10'L, and 12'L Racetrack, Faceted, Rectangular, and Soft Radiused End Tables

DESIGN JEFF CRONK

SIN 711.11

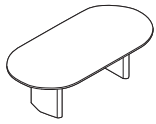

Tip: Shipped knocked down.

Tip: Top ships in one piece.

Tip: 1 mm self-edge is only available on a laminate top surface.

Tip: Flat edge is only available on wood veneer tops and is offered in 6000 Black only.

Tip: When a 3 mm wood edge is specified on a wood veneer top, the edge finish will match the top finish.

Tip: If you specify a wood edge on a top with woodgrain laminate, the edge and the top may not match.

Tip: Each utility bay comes with two universal faceplate openings that accept customer-supplied faceplates in any of the following sizes: single-gang, double-gang, or triple-gang.

► See Coalesse Tables, Storage, and Accessories Specification Guide

Tip: 96"L tables are available with zero or two utility bays. 10'L tables are available with zero, two or three utility bays. 12'L tables are available with zero, two, three or four utility bays.

Tip: Sectioned top option is a 2-piece top.

Tip: Transformer kit must be the same wiring schematic as the table.

Base veneer and woodgrain laminate direction



Standard Includes		Required to Specify	
► Need help? Product details, see <i>Coalesse Tables, Storage, and Accessories Specification Guide</i>	<ul style="list-style-type: none"> • Top: 1/4" particle board core with grade 1 laminate • Edge: 1 mm self-edge (laminate top only), 3 mm plastic edge, 3 mm wood edge, or convex vinyl edge • Two bases: black laminate on MDF core • Wireway: black steel C-channels and side panels and black plastic access door • Concealed leveling glides: non-marring, black plastic 	<ol style="list-style-type: none"> 1 Style number 2 Laminate color number for top 3 Edge selection: <ul style="list-style-type: none"> - 1 mm self-edge (laminate top only) to match laminate top, if selected - 3 mm flat plastic edge color number, if selected - Convex vinyl edge, if selected: <ul style="list-style-type: none"> 6000 Black 6607 Woodrose 6609 Smoke 6655 Warm White 4 Options, if selected (see below) 	► See <i>Surface Materials</i> , page 350.
Surface Materials	Options	Price	Required to Specify
	Top		
	• Grade 2 laminate	Prices at right	Specify with <i>Grade 2 laminate</i> and select color number.
	• Grade 1 wood veneer	Prices at right	Specify with <i>Grade 1 wood veneer</i> and select color number.
	• Grade 2 wood veneer	Prices at right	Specify with <i>Grade 2 wood veneer</i> and select color number.
	• Stain-to-Match	No cost	Specify with <i>Stain-to-Match</i> . ► Page 385
	Base		
	• Aluminum base	+\$ 138	Replace L suffix in the style number with A suffix and select powder coat color number.
	• Curated laminate base	+\$ 571	Specify with <i>curated laminate</i> and select color number.
	• Wood veneer base	+\$2222	Replace L suffix in the style number with V suffix and select wood color number.
	Edges		
	Wood veneer tops		
	• 3 mm plastic edge	Prices at right	Specify with <i>3 mm plastic edge</i> and select color number.
	• 3 mm wood edge	Prices at right	Specify with <i>3 mm wood edge</i> and select color number.
	• Convex vinyl edge	Prices at right	Specify with <i>convex vinyl edge</i> and select color number.
	• Flat edge (6000 Black)	Prices at right	Specify with <i>flat edge</i> .
	Wood veneer and laminate tops		
	• Bullnose wood edge	Prices at right	Specify with <i>bullnose wood edge</i> .
	• Beveled wood edge	Prices at right	Specify with <i>beveled wood edge</i> .
	• Knife wood edge	Prices at right	Specify with <i>knife wood edge</i> .
	• Waterfall wood edge	Prices at right	Specify with <i>waterfall wood edge</i> .
	• Faceted wood edge	Prices at right	Specify with <i>faceted wood edge</i> .
	Sectioned top	• Sectioned top	+\$ 372 Specify with <i>sectioned top</i> .
	Bay Option	<ul style="list-style-type: none"> • No bays • Two bays • Three bays • Four bays 	<ul style="list-style-type: none"> No cost +\$1030 +\$1545 +\$2060 Specify with <i>no bays</i> . Specify with <i>two bays</i> and select color number. Specify with <i>three bays</i> and select color number. Specify with <i>four bays</i> and select color number.
	Duplex Wiring Schematic	Tables with bay door(s)	
		• 3+0 wireway	No cost
		• 1+1 hardwire, 2 circuits	No cost
		• Chicago powerway	No cost
	USB Wiring Schematic	Tables with bay door(s)	
		• 3+0 wireway	+\$ 140 per bay
		• 1+1 hardwire, 2 circuits	+\$ 140 per bay
	Infeed	Tables with bay door(s)	
		• Plug (20 amp single circuit)	No cost
		• Hardwire	No cost
		• NYC hardwire infeed	No cost

► Options, continued on next page

E-Table 2

DESIGN JEFF CRONK

96"L, 10'L, and 12'L Racetrack, Faceted, Rectangular, and Soft Radiused End Tables

SIN 711.11

►Options, continued from previous page

Options	Price	Required to Specify
Related Products	• Transformer kit	► Page 161

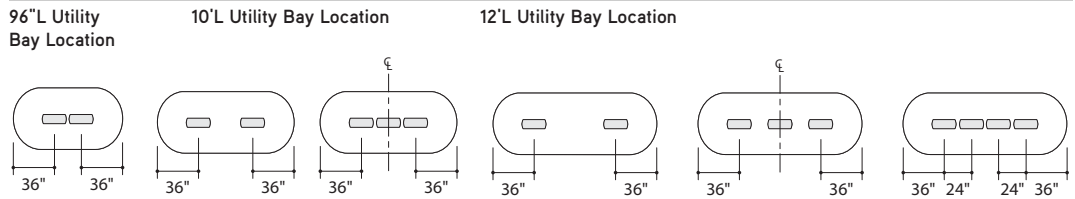

Specification Information

Dimensions L W H	Style Number	Finish	Base Prices

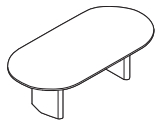

Tip: Racetrack tables are not available with waterfall or faceted wood edge.

Racetrack Tables with Two Bases

Dimensions	Style Number	Grade 1 Laminate	Grade 2 Laminate	Grade 1 Wood Veneer	Grade 2 Wood Veneer
96" 48" 29"	E2C9648L	Grade 1 Laminate	\$3844	\$4723	\$4804 \$ 4972
		Grade 2 Laminate	\$4000	\$4879	\$4960 \$ 5128
		Grade 1 Wood Veneer	\$5339	\$6218	\$6299 \$ 6467
		Grade 2 Wood Veneer	\$5948	\$6827	\$6908 \$ 7076
96" 54" 29"	E2C9654L	Grade 1 Laminate	\$3961	\$4953	\$5041 \$ 5231
		Grade 2 Laminate	\$4135	\$5127	\$5215 \$ 5405
		Grade 1 Wood Veneer	\$5642	\$6634	\$6722 \$ 6912
		Grade 2 Wood Veneer	\$6269	\$7261	\$7349 \$ 7539
96" 60" 29"	E2C9660L	Grade 1 Laminate	\$4075	\$5176	\$5273 \$ 5485
		Grade 2 Laminate	\$4267	\$5368	\$5465 \$ 5677
		Grade 1 Wood Veneer	\$5944	\$7045	\$7142 \$ 7354
		Grade 2 Wood Veneer	\$6598	\$7699	\$7796 \$ 8008
10' 48" 29"	E2C1048L	Grade 1 Laminate	\$4093	\$5709	\$5870 \$ 6162
		Grade 2 Laminate	\$4284	\$5900	\$6061 \$ 6353
		Grade 1 Wood Veneer	\$5637	\$7253	\$7414 \$ 7706
		Grade 2 Wood Veneer	\$6400	\$8016	\$8177 \$ 8469
10' 54" 29"	E2C1054L	Grade 1 Laminate	\$4281	\$6099	\$6280 \$ 6606
		Grade 2 Laminate	\$4497	\$6315	\$6496 \$ 6822
		Grade 1 Wood Veneer	\$6154	\$7972	\$8153 \$ 8479
		Grade 2 Wood Veneer	\$7017	\$8835	\$9016 \$ 9342
10' 60" 29"	E2C1060L	Grade 1 Laminate	\$4467	\$6490	\$6688 \$ 7048
		Grade 2 Laminate	\$4706	\$6729	\$6927 \$ 7287
		Grade 1 Wood Veneer	\$6669	\$8692	\$8890 \$ 9250
		Grade 2 Wood Veneer	\$7629	\$9652	\$9850 \$10,210









►Specification Information, continued on next page

E-Table 2
DESIGN JEFF CRONK

96"L, 10'L, and 12'L Racetrack, Faceted, Rectangular, and Soft Radiused End Tables *continued*

SIN 711.11

► Specification Information, continued from previous page

Specification Information				Base Prices							
Dimensions		Style	Finish								
L	W	H	Number								
											
				1 mm Self-Edge, 3 mm Plastic/ 3 mm Wood Edge, Flat Edge, or Convex Vinyl Edge:	Bullnose Wood Edge:	Beveled Wood Edge:	Knife Wood Edge, Waterfall Wood Edge, or Faceted Wood Edge:				

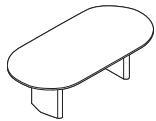

Tip: Racetrack tables are not available with waterfall or faceted wood edge.

Racetrack Tables with Two Bases, continued

Dimensions	Style	Finish	Grade 1	Grade 2	Waterfall	Faceted
12' 48" 29"	E2C1248L	Grade 1 Laminate	\$4130	\$6495	\$6693	\$7088
		Grade 2 Laminate	\$4359	\$6724	\$6922	\$7317
		Grade 1 Wood Veneer	\$6381	\$8746	\$8944	\$9339
		Grade 2 Wood Veneer	\$7298	\$9663	\$9861	\$10,256
12' 54" 29"	E2C1254L	Grade 1 Laminate	\$4343	\$7004	\$7220	\$7672
		Grade 2 Laminate	\$4604	\$7265	\$7481	\$7933
		Grade 1 Wood Veneer	\$7076	\$9737	\$9953	\$10,405
		Grade 2 Wood Veneer	\$8111	\$10,772	\$10,988	\$11,440
12' 60" 29"	E2C1260L	Grade 1 Laminate	\$4554	\$7510	\$7751	\$8259
		Grade 2 Laminate	\$4843	\$7799	\$8040	\$8548
		Grade 1 Wood Veneer	\$7764	\$10,720	\$10,961	\$11,469
		Grade 2 Wood Veneer	\$8918	\$11,874	\$12,115	\$12,623

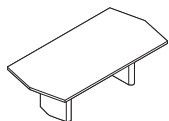

Tip: Faceted tables are not available with waterfall wood edge.

Faceted Tables with Two Bases

Dimensions	Style	Finish	Grade 1	Grade 2	Waterfall	Faceted
96" 48" 29"	E2F9648L	Grade 1 Laminate	\$4003	\$4882	\$4963	\$5131
		Grade 2 Laminate	\$4159	\$5038	\$5119	\$5287
		Grade 1 Wood Veneer	\$5498	\$6377	\$6458	\$6626
		Grade 2 Wood Veneer	\$6101	\$6980	\$7061	\$7229
96" 54" 29"	E2F9654L	Grade 1 Laminate	\$4118	\$5110	\$5198	\$5388
		Grade 2 Laminate	\$4292	\$5284	\$5372	\$5562
		Grade 1 Wood Veneer	\$5799	\$6791	\$6879	\$7069
		Grade 2 Wood Veneer	\$6426	\$7418	\$7506	\$7696
96" 60" 29"	E2F9660L	Grade 1 Laminate	\$4233	\$5334	\$5431	\$5641
		Grade 2 Laminate	\$4425	\$5526	\$5623	\$5833
		Grade 1 Wood Veneer	\$6102	\$7203	\$7300	\$7510
		Grade 2 Wood Veneer	\$6756	\$7857	\$7954	\$8164

► Specification Information, continued on next page

E-Table 2

DESIGN JEFF CRONK

96"L, 10'L, and 12'L Racetrack, Faceted, Rectangular, and Soft Radiused End Tables

SIN 711.11

► Specification Information, continued from previous page

Specification Information				Base Prices							
Dimensions			Style	Finish	Edge Profiles						
L	W	H	Number		1 mm Self-Edge, 3 mm Plastic/ 3 mm Wood Edge, Flat Edge, or Convex Vinyl Edge:	Bullnose Wood Edge:	Beveled Wood Edge:	Knife Wood Edge, Waterfall Wood Edge, or Faceted Wood Edge:			

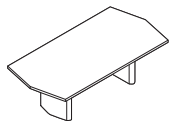

Tip: Faceted tables are not available with waterfall wood edge.

Tip: Vinyl edge profiles on faceted tables require a 4" radius on all corners.

Faceted Tables with Two Bases, continued

Dimensions	Style	Finish	Grade 1	Grade 2	Grade 1	Grade 2	Grade 1	Grade 2	
10' 48" 29"	E2F1048L	Grade 1 Laminate	\$4254	\$5870	\$6031	\$6323			
			Grade 2 Laminate	\$4445	\$6061	\$6222	\$6514		
			Grade 1 Wood Veneer	\$5798	\$7414	\$7575	\$7867		
			Grade 2 Wood Veneer	\$6552	\$8168	\$8329	\$8621		
10' 54" 29"	E2F1054L	Grade 1 Laminate	\$4439	\$6257	\$6438	\$6764			
			Grade 2 Laminate	\$4655	\$6473	\$6654	\$6980		
			Grade 1 Wood Veneer	\$6312	\$8130	\$8311	\$8637		
			Grade 2 Wood Veneer	\$7166	\$8984	\$9165	\$9491		
10' 60" 29"	E2F1060L	Grade 1 Laminate	\$4626	\$6649	\$6847	\$7211			
			Grade 2 Laminate	\$4865	\$6888	\$7086	\$7450		
			Grade 1 Wood Veneer	\$6828	\$8851	\$9049	\$9413		
			Grade 2 Wood Veneer	\$7782	\$9805	\$10,003	\$10,367		
12' 48" 29"	E2F1248L	Grade 1 Laminate	\$4294	\$6659	\$6857	\$7252			
			Grade 2 Laminate	\$4523	\$6888	\$7086	\$7481		
			Grade 1 Wood Veneer	\$6545	\$8910	\$9108	\$9503		
			Grade 2 Wood Veneer	\$7454	\$9819	\$10,017	\$10,412		
12' 54" 29"	E2F1254L	Grade 1 Laminate	\$4500	\$7161	\$7377	\$7829			
			Grade 2 Laminate	\$4761	\$7422	\$7638	\$8090		
			Grade 1 Wood Veneer	\$7233	\$9894	\$10,110	\$10,562		
			Grade 2 Wood Veneer	\$8257	\$10,918	\$11,134	\$11,586		
12' 60" 29"	E2F1260L	Grade 1 Laminate	\$4711	\$7667	\$7908	\$8410			
			Grade 2 Laminate	\$5000	\$7956	\$8197	\$8699		
			Grade 1 Wood Veneer	\$7921	\$10,877	\$11,118	\$11,620		
			Grade 2 Wood Veneer	\$9066	\$12,022	\$12,263	\$12,765		

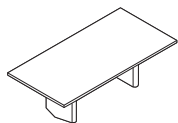

Tip: Vinyl edge profiles on rectangular tables require a 4" radius on all corners.

Rectangular Tables with Two Bases

Dimensions	Style	Grade 1	Grade 2	Grade 1	Grade 2	Grade 1	Grade 2
96" 48" 29"	E2R9648L	Grade 1 Laminate	\$3688	\$4567	\$4648	\$4816	
		Grade 2 Laminate	\$3844	\$4723	\$4804	\$4972	
		Grade 1 Wood Veneer	\$5183	\$6062	\$6143	\$6311	
		Grade 2 Wood Veneer	\$5786	\$6665	\$6746	\$6914	









► Specification Information, continued on next page

E-Table 2
DESIGN JEFF CRONK

96"L, 10'L, and 12'L Racetrack, Faceted, Rectangular, and Soft Radiused End Tables *continued*

SIN 711.11

► Specification Information, continued from previous page

Specification Information				Base Prices							
Dimensions		Style	Finish								
L	W	H	Number								
											
				1 mm Self-Edge, 3 mm Plastic/ 3 mm Wood Edge, Flat Edge, or Convex Vinyl Edge:	Bullnose Wood Edge:	Beveled Wood Edge:	Knife Wood Edge, Waterfall Wood Edge, or Faceted Wood Edge:				

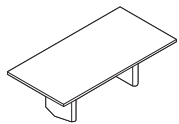

Tip: Vinyl edge profiles on rectangular tables require a 4" radius on all corners.

Rectangular Tables with Two Bases, continued

Dimensions	Style	Finish	Grade 1	Grade 2	Grade 1	Grade 2	Grade 1	Grade 2
L	W	H	Laminate	Laminate	Wood Veneer	Wood Veneer	Laminate	Laminate
96"	54"	29"	E2R9654L	Grade 1 Laminate	\$3801	\$ 4793	\$ 4881	\$ 5071
				Grade 2 Laminate	\$3975	\$ 4967	\$ 5055	\$ 5245
				Grade 1 Wood Veneer	\$5482	\$ 6474	\$ 6562	\$ 6752
				Grade 2 Wood Veneer	\$6109	\$ 7101	\$ 7189	\$ 7379
96"	60"	29"	E2R9660L	Grade 1 Laminate	\$3916	\$ 5017	\$ 5114	\$ 5324
				Grade 2 Laminate	\$4108	\$ 5209	\$ 5306	\$ 5516
				Grade 1 Wood Veneer	\$5785	\$ 6886	\$ 6983	\$ 7193
				Grade 2 Wood Veneer	\$6439	\$ 7540	\$ 7637	\$ 7847
10'	48"	29"	E2R1048L	Grade 1 Laminate	\$3937	\$ 5553	\$ 5714	\$ 6006
				Grade 2 Laminate	\$4128	\$ 5744	\$ 5905	\$ 6197
				Grade 1 Wood Veneer	\$5481	\$ 7097	\$ 7258	\$ 7550
				Grade 2 Wood Veneer	\$6235	\$ 7851	\$ 8012	\$ 8304
10'	54"	29"	E2R1054L	Grade 1 Laminate	\$4122	\$ 5940	\$ 6121	\$ 6447
				Grade 2 Laminate	\$4338	\$ 6156	\$ 6337	\$ 6663
				Grade 1 Wood Veneer	\$5995	\$ 7813	\$ 7994	\$ 8320
				Grade 2 Wood Veneer	\$6849	\$ 8667	\$ 8848	\$ 9174
10'	60"	29"	E2R1060L	Grade 1 Laminate	\$4307	\$ 6330	\$ 6528	\$ 6892
				Grade 2 Laminate	\$4546	\$ 6569	\$ 6767	\$ 7131
				Grade 1 Wood Veneer	\$6509	\$ 8532	\$ 8730	\$ 9094
				Grade 2 Wood Veneer	\$7463	\$ 9486	\$ 9684	\$10,048
12'	48"	29"	E2R1248L	Grade 1 Laminate	\$3974	\$ 6339	\$ 6537	\$ 6932
				Grade 2 Laminate	\$4203	\$ 6568	\$ 6766	\$ 7161
				Grade 1 Wood Veneer	\$6225	\$ 8590	\$ 8788	\$ 9183
				Grade 2 Wood Veneer	\$7134	\$ 9499	\$ 9697	\$10,092
12'	54"	29"	E2R1254L	Grade 1 Laminate	\$4184	\$ 6845	\$ 7061	\$ 7513
				Grade 2 Laminate	\$4445	\$ 7106	\$ 7322	\$ 7774
				Grade 1 Wood Veneer	\$6917	\$ 9578	\$ 9794	\$10,246
				Grade 2 Wood Veneer	\$7941	\$10,602	\$10,818	\$11,270
12'	60"	29"	E2R1260L	Grade 1 Laminate	\$4395	\$ 7351	\$ 7592	\$ 8094
				Grade 2 Laminate	\$4684	\$ 7640	\$ 7881	\$ 8383
				Grade 1 Wood Veneer	\$7605	\$10,561	\$10,802	\$11,304
				Grade 2 Wood Veneer	\$8750	\$11,706	\$11,947	\$12,449

► Specification Information, continued on next page

E-Table 2

DESIGN JEFF CRONK

96"L, 10'L, and 12'L Racetrack, Faceted, Rectangular, and Soft Radiused End Tables

SIN 711.11

► Specification Information, continued from previous page

Specification Information				Base Prices						
Dimensions			Style	Finish	Edge Profiles					
L	W	H	Number		1 mm Self-Edge, 3 mm Plastic/ 3 mm Wood Edge, Flat Edge, or Convex Vinyl Edge:	Bullnose Wood Edge:	Beveled Wood Edge:	Knife Wood Edge, Waterfall Wood Edge, or Faceted Wood Edge:		

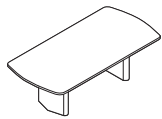

Tip: Vinyl edge profiles on soft radiused tables require a 4" radius on all corners.

Soft Radiused End Tables with Two Bases

Dimensions	Style Number	Finish	Grade 1 Price	Grade 2 Price	Grade 1 Veneer Price	Grade 2 Veneer Price
96" 48" 29"	E2S9648L	Grade 1 Laminate	\$3844	\$ 4723	N.A.	N.A.
		Grade 2 Laminate	\$4000	\$ 4879	N.A.	N.A.
		Grade 1 Wood Veneer	\$5339	\$ 6218	N.A.	N.A.
		Grade 2 Wood Veneer	\$5942	\$ 6821	N.A.	N.A.
96" 54" 29"	E2S9654L	Grade 1 Laminate	\$3961	\$ 4953	N.A.	N.A.
		Grade 2 Laminate	\$4135	\$ 5127	N.A.	N.A.
		Grade 1 Wood Veneer	\$5642	\$ 6634	N.A.	N.A.
		Grade 2 Wood Veneer	\$6269	\$ 7261	N.A.	N.A.
96" 60" 29"	E2S9660L	Grade 1 Laminate	\$4075	\$ 5176	N.A.	N.A.
		Grade 2 Laminate	\$4267	\$ 5368	N.A.	N.A.
		Grade 1 Wood Veneer	\$5944	\$ 7045	N.A.	N.A.
		Grade 2 Wood Veneer	\$6598	\$ 7699	N.A.	N.A.
10' 48" 29"	E2S1048L	Grade 1 Laminate	\$4093	\$ 5709	N.A.	N.A.
		Grade 2 Laminate	\$4284	\$ 5900	N.A.	N.A.
		Grade 1 Wood Veneer	\$5637	\$ 7253	N.A.	N.A.
		Grade 2 Wood Veneer	\$6391	\$ 8007	N.A.	N.A.
10' 54" 29"	E2S1054L	Grade 1 Laminate	\$4281	\$ 6099	N.A.	N.A.
		Grade 2 Laminate	\$4497	\$ 6315	N.A.	N.A.
		Grade 1 Wood Veneer	\$6154	\$ 7972	N.A.	N.A.
		Grade 2 Wood Veneer	\$7008	\$ 8826	N.A.	N.A.
10' 60" 29"	E2S1060L	Grade 1 Laminate	\$4467	\$ 6490	N.A.	N.A.
		Grade 2 Laminate	\$4706	\$ 6729	N.A.	N.A.
		Grade 1 Wood Veneer	\$6669	\$ 8692	N.A.	N.A.
		Grade 2 Wood Veneer	\$7623	\$ 9646	N.A.	N.A.
12' 48" 29"	E2S1248L	Grade 1 Laminate	\$4130	\$ 6495	N.A.	N.A.
		Grade 2 Laminate	\$4359	\$ 6724	N.A.	N.A.
		Grade 1 Wood Veneer	\$6381	\$ 8746	N.A.	N.A.
		Grade 2 Wood Veneer	\$7290	\$ 9655	N.A.	N.A.
12' 54" 29"	E2S1254L	Grade 1 Laminate	\$4343	\$ 7004	N.A.	N.A.
		Grade 2 Laminate	\$4604	\$ 7265	N.A.	N.A.
		Grade 1 Wood Veneer	\$7076	\$ 9737	N.A.	N.A.
		Grade 2 Wood Veneer	\$8100	\$10,761	N.A.	N.A.
12' 60" 29"	E2S1260L	Grade 1 Laminate	\$4554	\$ 7510	N.A.	N.A.
		Grade 2 Laminate	\$4843	\$ 7799	N.A.	N.A.
		Grade 1 Wood Veneer	\$7764	\$10,720	N.A.	N.A.
		Grade 2 Wood Veneer	\$8909	\$11,865	N.A.	N.A.

E-Table 2

DESIGN JEFF CRONK

14'L, 16'L, 18'L, and 20'L Racetrack, Faceted, Rectangular, and Soft Radiused End Tables

SIN 711.11

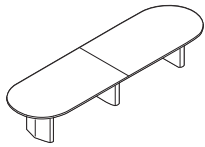

Tip: Top ships in two pieces. Hardware is included for field assembly.

Tip: Shipped knocked down.

Tip: Edge type is specified before top surface when specifying electronically.

Tip: Flat edge is only available on wood veneer tops and is offered in 6000 Black only.

Tip: When a 3 mm wood edge is specified on a wood veneer top, the edge finish will match the top finish.

Tip: If you specify a wood edge on a top with woodgrain laminate, the edge and the top may not match.

Tip: For tables with three or more bases, you must specify the entry point of the base power infeed, either an end base or a mid base location, in order to receive the correct length of base power infeed.

Tip: Each utility bay comes with two universal faceplate openings that accept customer-supplied faceplates in any of the following sizes: single-gang, double-gang, or triple-gang.
 ▶ See *Coalesse Tables, Storage, and Accessories Specification Guide*

Tip: 14'L and 16'L tables are available with zero, two, or four utility bays. 18'L and 20'L tables are available with zero, two, four or six utility bays.

Tip: If you require your table top to be made into four pieces, this can be done as a special. Please contact Customer Service at 1.800.627.6770 to obtain a quote.

Base veneer and woodgrain laminate direction



Standard Includes	Required to Specify
<ul style="list-style-type: none"> ▶ Need help? Product details, see <i>Coalesse Tables, Storage, and Accessories Specification Guide</i> • Top: 1¼" particle board core with grade 1 laminate • Edge: 1 mm self edge (laminate top only), 3 mm plastic edge, 3 mm wood edge, or convex vinyl edge • Three bases: black laminate on MDF core • Wireway: black steel C-channels and side panels and black plastic access door • Concealed leveling glides: non-marring, black plastic 	<ol style="list-style-type: none"> 1 Style number 2 Laminate color number for top 3 Edge selection: <ul style="list-style-type: none"> - 1 mm self-edge (laminate top only) to match laminate top, if selected - 3 mm flat plastic edge color number, if selected - Convex vinyl edge, if selected <p>6000 Black 6607 Woodrose 6609 Smoke 6655 Warm White</p> <ol style="list-style-type: none"> 4 Options, if selected (see below) ▶ See <i>Surface Materials</i> , page 350.

Options	Price	Required to Specify
Surface Materials <ul style="list-style-type: none"> • Grade 2 laminate • Grade 1 wood veneer • Grade 2 wood veneer • Stain-to-Match 	Prices at right Prices at right Prices at right No cost	Specify with <i>Grade 2 laminate</i> and select color number. Specify with <i>Grade 1 wood veneer</i> and select color number. Specify with <i>Grade 2 wood veneer</i> and select color number. Specify with <i>Stain-to-Match</i> . ▶ Page 385
Base <ul style="list-style-type: none"> • Aluminum base • Curated laminate base • Wood veneer base 	+\$ 371 +\$ 893 +\$3412	Replace L suffix in the style number with A suffix and select powder coat color number. Specify with <i>curated laminate</i> and select color number. Replace L suffix in the style number with V suffix and select wood color number.
Edges <ul style="list-style-type: none"> • Wood veneer tops • 3 mm plastic edge • 3 mm wood edge • Convex vinyl edge • Flat edge (6000 Black) • Wood veneer and laminate tops <ul style="list-style-type: none"> • Bullnose wood edge • Beveled wood edge • Knife wood edge • Waterfall wood edge • Faceted wood edge 	Prices at right Prices at right Prices at right Prices at right Prices at right Prices at right Prices at right Prices at right Prices at right	Specify with <i>3 mm plastic edge</i> and select color number. Specify with <i>3 mm wood edge</i> and select color number. Specify with <i>convex vinyl edge</i> and select color number. Specify with <i>flat edge</i> . Specify with <i>bullnose wood edge</i> . Specify with <i>beveled wood edge</i> . Specify with <i>knife wood edge</i> . Specify with <i>waterfall wood edge</i> . Specify with <i>faceted wood edge</i> .
Bay Option <ul style="list-style-type: none"> • No bays • Two bays • Four bays • Six bays 	No cost +\$1030 +\$2060 +\$3090	Specify with <i>no bays</i> . Specify with <i>two bays</i> and select color number. Specify with <i>four bays</i> and select color number. Specify with <i>six bays</i> and select color number.
Duplex Wiring Schematic <ul style="list-style-type: none"> • Tables with bay door(s) • 3+0 wireway • 1+1 hardwire, 2 circuits • Chicago powerway 	No cost No cost No cost	Specify with <i>3+0 wireway, duplex</i> . Specify with <i>1+1 hardwire, 2 circuits, duplex</i> . Specify with <i>Chicago powerway</i> .
USB Wiring Schematic <ul style="list-style-type: none"> • Tables with bay door(s) • 3+0 wireway • 1+1 hardwire, 2 circuits 	+\$ 140 per bay +\$ 140 per bay	Specify with <i>3+0 wireway, USB</i> . Specify with <i>1+1 hardwire, 2 circuits, USB</i> .
Infeed <ul style="list-style-type: none"> • Tables with bay door(s) • Plug (20 amp single circuit) • Hardwire • NYC hardwire infeed 	No cost No cost No cost	Specify with <i>plug</i> . Specify with <i>hardwire</i> . Specify with <i>NYC hardwire infeed</i> .

▶ Options, continued on next page

E-Table 2

DESIGN JEFF CRONK

14'L, 16'L, 18'L, and 20'L Racetrack, Faceted, Rectangular, and Soft Radiused End Tables

SIN 711.11

► Options, continued from previous page

Options	Price	Required to Specify
Infeed Location	Tables with bay doors	
	• End base power infeed	No cost
	• Mid base power infeed	No cost
		Specify with end base entry location for location base power infeed. Specify with mid base entry location for location base power infeed.

Related Products

- Transformer kit

► Page 161

Tip: Transformer kit must be the same wiring schematic as the table.

14'L Utility Bay Location

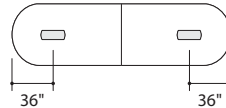
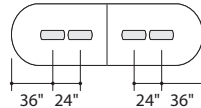
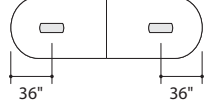

16'L Utility Bay Location

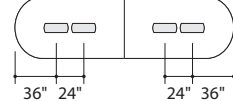



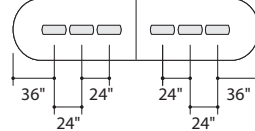
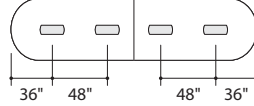



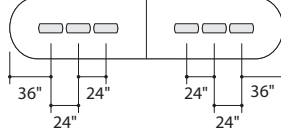
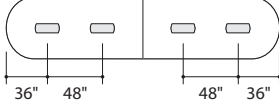

18'L Utility Bay Location



20'L Utility Bay Location



Specification Information

Dimensions	Style	Finish	Base Prices
L W H	Number		
			       
			1 mm Self-Edge, 3 mm Plastic/ 3 mm Wood Edge, Flat Edge, or Convex Vinyl Edge:
			Bullnose Wood Edge:
			Beveled Wood Edge:
			Knife Wood Edge, Waterfall Wood Edge, or Faceted Wood Edge:

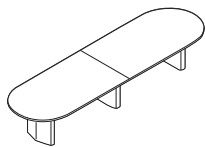

Tip: Racetrack tables are not available with waterfall or faceted wood edge

Racetrack Tables with Three Bases

Dimensions	Style	Finish	Grade 1	Grade 2
L W H	Number		Price	Price
14' 48" 29"	E2C1448L	Grade 1 Laminate	\$ 5912	\$ 9511
		Grade 2 Laminate	\$ 6167	\$ 9766
		Grade 1 Wood Veneer	\$10,614	\$14,213
		Grade 2 Wood Veneer	\$11,689	\$15,288
14' 54" 29"	E2C1454L	Grade 1 Laminate	\$ 6246	\$10,293
		Grade 2 Laminate	\$ 6533	\$10,580
		Grade 1 Wood Veneer	\$11,724	\$15,771
		Grade 2 Wood Veneer	\$12,943	\$16,990
14' 60" 29"	E2C1460L	Grade 1 Laminate	\$ 6579	\$11,077
		Grade 2 Laminate	\$ 6896	\$11,394
		Grade 1 Wood Veneer	\$12,835	\$17,333
		Grade 2 Wood Veneer	\$14,195	\$18,693









► Specification Information, continued on next page

E-Table 2
DESIGN JEFF CRONK

SIN 711.11

14'L, 16'L, 18'L, and 20'L Racetrack, Faceted, Rectangular, and Soft Radiused End Tables *continued*

► Specification information, continued from previous page

Specification Information				Base Prices							
Dimensions		Style	Finish								
L	W	H	Number								
											
				1 mm Self-Edge, 3 mm Plastic/ 3 mm Wood Edge, Flat Edge, or Convex Vinyl Edge:	Bullnose Wood Edge:	Beveled Wood Edge:	Knife Wood Edge, Waterfall Wood Edge, or Faceted Wood Edge:				

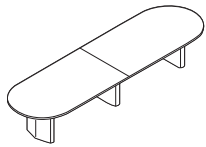

Tip: Racetrack tables are not available with waterfall or faceted wood edge

Racetrack Tables with Three Bases

Dimensions	Style	Finish	Grade 1	Grade 2	Grade 1	Grade 2	Grade 1	Grade 2
L	W	H	Laminate	Laminate	Wood Veneer	Wood Veneer	Laminate	Laminate
16'	48"	29"	E2C1648L	Grade 1 Laminate	\$ 5981	\$ 9733	\$ 9921	\$10,572
				Grade 2 Laminate	\$ 6272	\$10,024	\$10,212	\$10,863
				Grade 1 Wood Veneer	\$10,768	\$14,520	\$14,708	\$15,359
				Grade 2 Wood Veneer	\$11,992	\$15,744	\$15,932	\$16,583
16'	54"	29"	E2C1654L	Grade 1 Laminate	\$ 6344	\$10,563	\$10,773	\$11,506
				Grade 2 Laminate	\$ 6670	\$10,889	\$11,099	\$11,832
				Grade 1 Wood Veneer	\$11,925	\$16,144	\$16,354	\$17,087
				Grade 2 Wood Veneer	\$13,149	\$17,368	\$17,578	\$18,311
16'	60"	29"	E2C1660L	Grade 1 Laminate	\$ 6702	\$11,391	\$11,625	\$12,440
				Grade 2 Laminate	\$ 7064	\$11,753	\$11,987	\$12,802
				Grade 1 Wood Veneer	\$13,075	\$17,764	\$17,998	\$18,813
				Grade 2 Wood Veneer	\$14,624	\$19,313	\$19,547	\$20,362
18'	48"	29"	E2C1848L	Grade 1 Laminate	\$ 6202	\$10,183	\$10,406	\$11,168
				Grade 2 Laminate	\$ 6528	\$10,509	\$10,732	\$11,494
				Grade 1 Wood Veneer	\$12,629	\$16,610	\$16,833	\$17,595
				Grade 2 Wood Veneer	\$14,014	\$17,995	\$18,218	\$18,980
18'	54"	29"	E2C1854L	Grade 1 Laminate	\$ 6608	\$11,093	\$11,334	\$12,193
				Grade 2 Laminate	\$ 6975	\$11,460	\$11,701	\$12,560
				Grade 1 Wood Veneer	\$14,029	\$18,514	\$18,755	\$19,614
				Grade 2 Wood Veneer	\$15,599	\$20,084	\$20,325	\$21,184
18'	60"	29"	E2C1860L	Grade 1 Laminate	\$ 7014	\$12,005	\$12,267	\$13,222
				Grade 2 Laminate	\$ 7423	\$12,414	\$12,676	\$13,631
				Grade 1 Wood Veneer	\$15,429	\$20,420	\$20,682	\$21,637
				Grade 2 Wood Veneer	\$17,184	\$22,175	\$22,437	\$23,392









► Specification Information, continued on next page

E-Table 2
DESIGN JEFF CRONK

14'L, 16'L, 18'L, and 20'L Racetrack, Faceted, Rectangular, and Soft Radiused End Tables

SIN 711.11

► Specification Information, continued from previous page

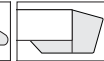
Specification Information				Base Prices								
Dimensions		Style	Finish									
L	W	H	Number									
												
				1 mm Self-Edge, 3 mm Plastic/ 3 mm Wood Edge, Flat Edge, or Convex Vinyl Edge:	Bullnose Wood Edge:	Beveled Wood Edge:	Knife Wood Edge, Waterfall Wood Edge, or Faceted Wood Edge:					

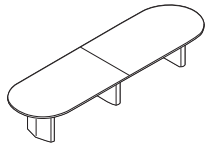

Tip: Racetrack tables are not available with waterfall or faceted wood edge

Racetrack Tables with Three Bases, continued

Dimensions	Style Number	Finish	Grade 1	Grade 2	Wood Veneer	Waterfall	Faceted
20' 48" 29"	E2C2048L	Grade 1 Laminate	\$ 6237	\$10,620	\$10,874	\$11,677	
		Grade 2 Laminate	\$ 6598	\$10,981	\$11,235	\$12,038	
		Grade 1 Wood Veneer	\$13,581	\$17,964	\$18,218	\$19,021	
		Grade 2 Wood Veneer	\$15,111	\$19,494	\$19,748	\$20,551	
20' 54" 29"	E2C2054L	Grade 1 Laminate	\$ 6669	\$11,604	\$11,888	\$12,790	
		Grade 2 Laminate	\$ 7076	\$12,011	\$12,295	\$13,197	
		Grade 1 Wood Veneer	\$15,119	\$20,054	\$20,338	\$21,240	
		Grade 2 Wood Veneer	\$16,855	\$21,790	\$22,074	\$22,976	
20' 60" 29"	E2C2060L	Grade 1 Laminate	\$ 7098	\$12,589	\$12,896	\$13,898	
		Grade 2 Laminate	\$ 7551	\$13,042	\$13,349	\$14,351	
		Grade 1 Wood Veneer	\$16,660	\$22,151	\$22,458	\$23,460	
		Grade 2 Wood Veneer	\$18,599	\$24,090	\$24,397	\$25,399	

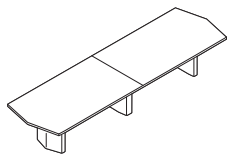

Tip: Faceted tables are not available with waterfall wood edge.

Tip: Vinyl edge profiles on faceted tables require a 4" radius on all corners.

Faceted Tables with Three Bases

Dimensions	Style Number	Finish	Grade 1	Grade 2	Wood Veneer	Waterfall	Faceted
14' 48" 29"	E2F1448L	Grade 1 Laminate	\$ 6063	\$ 9662	\$ 9845	\$10,475	
		Grade 2 Laminate	\$ 6318	\$ 9917	\$10,100	\$10,730	
		Grade 1 Wood Veneer	\$10,765	\$14,364	\$14,547	\$15,177	
		Grade 2 Wood Veneer	\$11,828	\$15,427	\$15,610	\$16,240	
14' 54" 29"	E2F1454L	Grade 1 Laminate	\$ 6397	\$10,444	\$10,654	\$11,361	
		Grade 2 Laminate	\$ 6684	\$10,731	\$10,941	\$11,648	
		Grade 1 Wood Veneer	\$11,875	\$15,922	\$16,132	\$16,839	
		Grade 2 Wood Veneer	\$13,086	\$17,133	\$17,343	\$18,050	
14' 60" 29"	E2F1460L	Grade 1 Laminate	\$ 6732	\$11,230	\$11,460	\$12,247	
		Grade 2 Laminate	\$ 7049	\$11,547	\$11,777	\$12,564	
		Grade 1 Wood Veneer	\$12,988	\$17,486	\$17,716	\$18,503	
		Grade 2 Wood Veneer	\$14,342	\$18,840	\$19,070	\$19,857	
16' 48" 29"	E2F1648L	Grade 1 Laminate	\$ 6131	\$ 9883	\$10,071	\$10,722	
		Grade 2 Laminate	\$ 6422	\$10,174	\$10,362	\$11,013	
		Grade 1 Wood Veneer	\$10,918	\$14,670	\$14,858	\$15,509	
		Grade 2 Wood Veneer	\$12,134	\$15,886	\$16,074	\$16,725	

► Specification Information, continued on next page









E-Table 2

DESIGN JEFF CRONK

14'L, 16'L, 18'L, and 20'L Racetrack, Faceted, Rectangular, and Soft Radiused End Tables *continued*

SIN 711.11

► Specification Information, continued from previous page

Specification Information				Base Prices							
Dimensions		Style	Finish								
L	W	H	Number								
											
				1 mm Self-Edge, 3 mm Plastic/ 3 mm Wood Edge, Flat Edge, or Convex Vinyl Edge:	Bullnose Wood Edge:	Beveled Wood Edge:	Knife Wood Edge, Waterfall Wood Edge, or Faceted Wood Edge:				

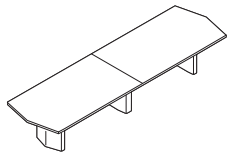

Tip: Faceted tables are not available with waterfall wood edge.

Tip: Vinyl edge profiles on faceted tables require a 4" radius on all corners.

Faceted Tables with Three Bases, continued

Dimensions	Style	Finish	Grade 1	Grade 2	Grade 1	Grade 2	Grade 1	Grade 2
L	W	H	Laminate	Laminate	Wood Veneer	Wood Veneer	Laminate	Laminate
16'	54"	29"	E2F1654L	Grade 1 Laminate	\$ 6491	\$10,710	\$10,920	\$11,653
				Grade 2 Laminate	\$ 6817	\$11,036	\$11,246	\$11,979
				Grade 1 Wood Veneer	\$12,072	\$16,291	\$16,501	\$17,234
				Grade 2 Wood Veneer	\$13,450	\$17,669	\$17,879	\$18,612
16'	60"	29"	E2F1660L	Grade 1 Laminate	\$ 6851	\$11,540	\$11,774	\$12,586
				Grade 2 Laminate	\$ 7213	\$11,902	\$12,136	\$12,948
				Grade 1 Wood Veneer	\$13,224	\$17,913	\$18,147	\$18,959
				Grade 2 Wood Veneer	\$14,763	\$19,452	\$19,686	\$20,498
18'	48"	29"	E2F1848L	Grade 1 Laminate	\$ 6351	\$10,332	\$10,555	\$11,317
				Grade 2 Laminate	\$ 6677	\$10,658	\$10,881	\$11,643
				Grade 1 Wood Veneer	\$12,778	\$16,759	\$16,982	\$17,744
				Grade 2 Wood Veneer	\$14,149	\$18,130	\$18,353	\$19,115
18'	54"	29"	E2F1854L	Grade 1 Laminate	\$ 6757	\$11,242	\$11,483	\$12,342
				Grade 2 Laminate	\$ 7124	\$11,609	\$11,850	\$12,709
				Grade 1 Wood Veneer	\$14,178	\$18,663	\$18,904	\$19,763
				Grade 2 Wood Veneer	\$15,736	\$20,221	\$20,462	\$21,321
18'	60"	29"	E2F1860L	Grade 1 Laminate	\$ 7165	\$12,156	\$12,418	\$13,373
				Grade 2 Laminate	\$ 7574	\$12,565	\$12,827	\$13,782
				Grade 1 Wood Veneer	\$15,580	\$20,571	\$20,833	\$21,788
				Grade 2 Wood Veneer	\$17,324	\$22,315	\$22,577	\$23,532
20'	48"	29"	E2F2048L	Grade 1 Laminate	\$ 6388	\$10,771	\$11,025	\$11,828
				Grade 2 Laminate	\$ 6749	\$11,132	\$11,386	\$12,189
				Grade 1 Wood Veneer	\$13,732	\$18,115	\$18,369	\$19,172
				Grade 2 Wood Veneer	\$15,250	\$19,633	\$19,887	\$20,690
20'	54"	29"	E2F2054L	Grade 1 Laminate	\$ 6817	\$11,752	\$12,036	\$12,938
				Grade 2 Laminate	\$ 7224	\$12,159	\$12,443	\$13,345
				Grade 1 Wood Veneer	\$15,267	\$20,202	\$20,486	\$21,388
				Grade 2 Wood Veneer	\$16,991	\$21,926	\$22,210	\$23,112
20'	60"	29"	E2F2060L	Grade 1 Laminate	\$ 7249	\$12,740	\$13,047	\$14,050
				Grade 2 Laminate	\$ 7702	\$13,193	\$13,500	\$14,503
				Grade 1 Wood Veneer	\$16,811	\$22,302	\$22,609	\$23,612
				Grade 2 Wood Veneer	\$18,738	\$24,229	\$24,536	\$25,539

► Specification Information, continued on next page

E-Table 2

DESIGN JEFF CRONK

14'L, 16'L, 18'L, and 20'L Racetrack, Faceted, Rectangular, and Soft Radiused End Tables

SIN 711.11

► Specification Information, continued from previous page

Specification Information				Base Prices							
Dimensions			Style	Finish	Edge Profiles						
L	W	H	Number		1 mm Self-Edge, 3 mm Plastic/ 3 mm Wood Edge, Flat Edge, or Convex Vinyl Edge:	Bullnose Wood Edge:	Beveled Wood Edge:	Knife Wood Edge, Waterfall Wood Edge, or Faceted Wood Edge:			

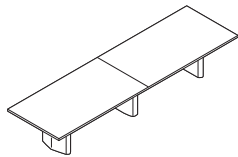

Tip: Vinyl edge profiles on rectangular tables require a 4" radius on all corners.

Rectangular Tables with Three Bases

Dimensions	Style	Finish	Grade 1	Grade 2	Grade 1 Wood Veneer	Grade 2 Wood Veneer	
14' 48" 29"	E2R1448L	Grade 1 Laminate	\$ 5763	\$ 9362	\$ 9545	\$10,175	
			Grade 2 Laminate	\$ 6018	\$ 9617	\$ 9800	\$10,430
			Grade 1 Wood Veneer	\$10,465	\$14,064	\$14,247	\$14,877
			Grade 2 Wood Veneer	\$11,528	\$15,127	\$15,310	\$15,940
14' 54" 29"	E2R1454L	Grade 1 Laminate	\$ 6097	\$10,144	\$10,354	\$11,061	
			Grade 2 Laminate	\$ 6384	\$10,431	\$10,641	\$11,348
			Grade 1 Wood Veneer	\$11,575	\$15,622	\$15,832	\$16,539
			Grade 2 Wood Veneer	\$12,786	\$16,833	\$17,043	\$17,750
14' 60" 29"	E2R1460L	Grade 1 Laminate	\$ 6430	\$10,928	\$11,158	\$11,945	
			Grade 2 Laminate	\$ 6747	\$11,245	\$11,475	\$12,262
			Grade 1 Wood Veneer	\$12,686	\$17,184	\$17,414	\$18,201
			Grade 2 Wood Veneer	\$14,040	\$18,538	\$18,768	\$19,555
16' 48" 29"	E2R1648L	Grade 1 Laminate	\$ 5831	\$ 9583	\$ 9771	\$10,422	
			Grade 2 Laminate	\$ 6122	\$ 9874	\$10,062	\$10,713
			Grade 1 Wood Veneer	\$10,618	\$14,370	\$14,558	\$15,209
			Grade 2 Wood Veneer	\$11,834	\$15,586	\$15,774	\$16,425
16' 54" 29"	E2R1654L	Grade 1 Laminate	\$ 6194	\$10,413	\$10,623	\$11,356	
			Grade 2 Laminate	\$ 6520	\$10,739	\$10,949	\$11,682
			Grade 1 Wood Veneer	\$11,775	\$15,994	\$16,204	\$16,937
			Grade 2 Wood Veneer	\$13,153	\$17,372	\$17,582	\$18,315
16' 60" 29"	E2R1660L	Grade 1 Laminate	\$ 6553	\$11,242	\$11,476	\$12,288	
			Grade 2 Laminate	\$ 6915	\$11,604	\$11,838	\$12,650
			Grade 1 Wood Veneer	\$12,926	\$17,615	\$17,849	\$18,661
			Grade 2 Wood Veneer	\$14,465	\$19,154	\$19,388	\$20,200
18' 48" 29"	E2R1848L	Grade 1 Laminate	\$ 6050	\$10,031	\$10,254	\$11,016	
			Grade 2 Laminate	\$ 6376	\$10,357	\$10,580	\$11,342
			Grade 1 Wood Veneer	\$12,477	\$16,458	\$16,681	\$17,443
			Grade 2 Wood Veneer	\$13,848	\$17,829	\$18,052	\$18,814
18' 54" 29"	E2R1854L	Grade 1 Laminate	\$ 6460	\$10,945	\$11,186	\$12,045	
			Grade 2 Laminate	\$ 6827	\$11,312	\$11,553	\$12,412
			Grade 1 Wood Veneer	\$13,881	\$18,366	\$18,607	\$19,466
			Grade 2 Wood Veneer	\$15,439	\$19,924	\$20,165	\$21,024

► Specification Information, continued on next page









E-Table 2

DESIGN JEFF CRONK

14'L, 16'L, 18'L, and 20'L Racetrack, Faceted, Rectangular, and Soft Radiused End Tables *continued*

SIN 711.11

► Specification Information, continued from previous page

Specification Information				Base Prices								
Dimensions		Style	Finish									
L	W	H	Number									
												
				1 mm Self-Edge, 3 mm Plastic/ 3 mm Wood Edge, Flat Edge, or Convex Vinyl Edge:	Bullnose Wood Edge:	Beveled Wood Edge:	Knife Wood Edge, Waterfall Wood Edge, or Faceted Wood Edge:					

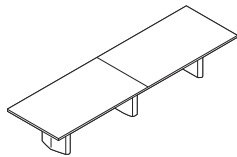

Tip: Vinyl edge profiles on rectangular tables require a 4" radius on all corners.

Rectangular Tables with Three Bases, continued

Dimensions	Style	Finish	Grade 1	Grade 2	Grade 1	Grade 2	Grade 1	Grade 2
L	W	H	Laminate	Laminate	Wood Veneer	Wood Veneer	Wood Veneer	Wood Veneer
18' 60" 29"	E2R1860L	Grade 1 Laminate	\$ 6868	\$11,859	\$12,121	\$13,076		
		Grade 2 Laminate	\$ 7277	\$12,268	\$12,530	\$13,485		
		Grade 1 Wood Veneer	\$15,283	\$20,274	\$20,536	\$21,491		
		Grade 2 Wood Veneer	\$17,027	\$22,018	\$22,280	\$23,235		
20' 48" 29"	E2R2048L	Grade 1 Laminate	\$ 6087	\$10,470	\$10,724	\$11,527		
		Grade 2 Laminate	\$ 6448	\$10,831	\$11,085	\$11,888		
		Grade 1 Wood Veneer	\$13,431	\$17,814	\$18,068	\$18,871		
		Grade 2 Wood Veneer	\$14,949	\$19,332	\$19,586	\$20,389		
20' 54" 29"	E2R2054L	Grade 1 Laminate	\$ 6518	\$11,453	\$11,737	\$12,639		
		Grade 2 Laminate	\$ 6925	\$11,860	\$12,144	\$13,046		
		Grade 1 Wood Veneer	\$14,968	\$19,903	\$20,187	\$21,089		
		Grade 2 Wood Veneer	\$16,692	\$21,627	\$21,911	\$22,813		
20' 60" 29"	E2R2060L	Grade 1 Laminate	\$ 6951	\$12,442	\$12,749	\$13,752		
		Grade 2 Laminate	\$ 7404	\$12,895	\$13,202	\$14,205		
		Grade 1 Wood Veneer	\$16,513	\$22,004	\$22,311	\$23,314		
		Grade 2 Wood Veneer	\$18,440	\$23,931	\$24,238	\$25,241		

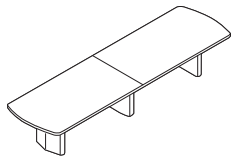

Tip: Vinyl edge profiles on soft radiused tables require a 4" radius on all corners.

Soft Radiused End Tables with Three Bases

Dimensions	Style	Finish	Grade 1	Grade 2	Grade 1	Grade 2	Grade 1	Grade 2
L	W	H	Laminate	Laminate	Wood Veneer	Wood Veneer	Wood Veneer	Wood Veneer
14' 48" 29"	E2S1448L	Grade 1 Laminate	\$ 5912	\$ 9511	N.A.	N.A.		
		Grade 2 Laminate	\$ 6167	\$ 9766	N.A.	N.A.		
		Grade 1 Wood Veneer	\$10,614	\$14,213	N.A.	N.A.		
		Grade 2 Wood Veneer	\$11,677	\$15,276	N.A.	N.A.		
14' 54" 29"	E2S1454L	Grade 1 Laminate	\$ 6246	\$10,293	N.A.	N.A.		
		Grade 2 Laminate	\$ 6533	\$10,580	N.A.	N.A.		
		Grade 1 Wood Veneer	\$11,724	\$15,771	N.A.	N.A.		
		Grade 2 Wood Veneer	\$12,935	\$16,982	N.A.	N.A.		
14' 60" 29"	E2S1460L	Grade 1 Laminate	\$ 6579	\$11,077	N.A.	N.A.		
		Grade 2 Laminate	\$ 6896	\$11,394	N.A.	N.A.		
		Grade 1 Wood Veneer	\$12,835	\$17,333	N.A.	N.A.		
		Grade 2 Wood Veneer	\$14,189	\$18,687	N.A.	N.A.		
16' 48" 29"	E2S1648L	Grade 1 Laminate	\$ 5981	\$ 9733	N.A.	N.A.		
		Grade 2 Laminate	\$ 6272	\$10,024	N.A.	N.A.		
		Grade 1 Wood Veneer	\$10,768	\$14,520	N.A.	N.A.		
		Grade 2 Wood Veneer	\$11,984	\$15,736	N.A.	N.A.		

► Specification Information, continued on next page

E-Table 2

DESIGN JEFF CRONK

14'L, 16'L, 18'L, and 20'L Racetrack, Faceted, Rectangular, and Soft Radiused End Tables

SIN 711.11

► Specification Information, continued from previous page

Specification Information				Base Prices						
Dimensions			Style	Finish	1 mm Self-Edge, 3 mm Plastic/ 3 mm Wood Edge, Flat Edge, or Convex Vinyl Edge:	Bullnose Wood Edge:	Beveled Wood Edge:	Knife Wood Edge, Waterfall Wood Edge:	Waterfall Wood Edge:	Faceted Wood Edge:
L	W	H	Number							

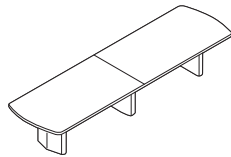

Tip: Vinyl edge profiles on soft radiused tables require a 4" radius on all corners.

Soft Radiused End Tables with Three Bases, continued

Dimensions	Style	Finish	Grade	Material	Price	Material	Price	Material	Price
16' 54" 29"	E2S1654L	Grade 1 Laminate	Grade 1 Laminate	\$ 6344	\$10,563	N.A.	N.A.		
			Grade 2 Laminate	\$ 6670	\$10,889	N.A.	N.A.		
			Grade 1 Wood Veneer	\$11,925	\$16,144	N.A.	N.A.		
			Grade 2 Wood Veneer	\$13,303	\$17,522	N.A.	N.A.		
16' 60" 29"	E2S1660L	Grade 1 Laminate	Grade 1 Laminate	\$ 6702	\$11,391	N.A.	N.A.		
			Grade 2 Laminate	\$ 7064	\$11,753	N.A.	N.A.		
			Grade 1 Wood Veneer	\$13,075	\$17,764	N.A.	N.A.		
			Grade 2 Wood Veneer	\$14,614	\$19,303	N.A.	N.A.		
18' 48" 29"	E2S1848L	Grade 1 Laminate	Grade 1 Laminate	\$ 6202	\$10,183	N.A.	N.A.		
			Grade 2 Laminate	\$ 6528	\$10,509	N.A.	N.A.		
			Grade 1 Wood Veneer	\$12,629	\$16,610	N.A.	N.A.		
			Grade 2 Wood Veneer	\$14,000	\$17,981	N.A.	N.A.		
18' 54" 29"	E2S1854L	Grade 1 Laminate	Grade 1 Laminate	\$ 6608	\$11,093	N.A.	N.A.		
			Grade 2 Laminate	\$ 6975	\$11,460	N.A.	N.A.		
			Grade 1 Wood Veneer	\$14,029	\$18,514	N.A.	N.A.		
			Grade 2 Wood Veneer	\$15,587	\$20,072	N.A.	N.A.		
18' 60" 29"	E2S1860L	Grade 1 Laminate	Grade 1 Laminate	\$ 7014	\$12,005	N.A.	N.A.		
			Grade 2 Laminate	\$ 7423	\$12,414	N.A.	N.A.		
			Grade 1 Wood Veneer	\$15,429	\$20,420	N.A.	N.A.		
			Grade 2 Wood Veneer	\$17,173	\$22,164	N.A.	N.A.		
20' 48" 29"	E2S2048L	Grade 1 Laminate	Grade 1 Laminate	\$ 6237	\$10,620	N.A.	N.A.		
			Grade 2 Laminate	\$ 6598	\$10,981	N.A.	N.A.		
			Grade 1 Wood Veneer	\$13,581	\$17,964	N.A.	N.A.		
			Grade 2 Wood Veneer	\$15,099	\$19,482	N.A.	N.A.		
20' 54" 29"	E2S2054L	Grade 1 Laminate	Grade 1 Laminate	\$ 6669	\$11,604	N.A.	N.A.		
			Grade 2 Laminate	\$ 7076	\$12,011	N.A.	N.A.		
			Grade 1 Wood Veneer	\$15,119	\$20,054	N.A.	N.A.		
			Grade 2 Wood Veneer	\$16,843	\$21,778	N.A.	N.A.		
20' 60" 29"	E2S2060L	Grade 1 Laminate	Grade 1 Laminate	\$ 7098	\$12,589	N.A.	N.A.		
			Grade 2 Laminate	\$ 7551	\$13,042	N.A.	N.A.		
			Grade 1 Wood Veneer	\$16,660	\$22,151	N.A.	N.A.		
			Grade 2 Wood Veneer	\$18,587	\$24,078	N.A.	N.A.		

E-Table 2

E-Table 2

22'L and 24'L Racetrack, Faceted, Rectangular, and Soft Radiused End Tables
DESIGN JEFF CRONK

SIN 711.11

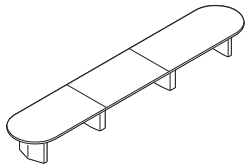

Tip: Top ships in three pieces. Hardware is included for field assembly.

Tip: Shipped knocked down.

Tip: 1 mm self-edge is only available on a laminate top surface.

Tip: Flat edge is only available on wood veneer tops and is offered in 6000 Black only.

Tip: When a 3 mm wood edge is specified on a wood veneer top, the edge finish will match the top finish.

Tip: If you specify a wood edge on a top with woodgrain laminate, the edge and the top may not match.

Tip: For table with three or more bases, you must specify the entry point of the base power infeed, either an end base or mid base location, in order to receive the correct length of base power infeed.

Tip: Each utility bay comes with two universal faceplate openings that accept customer-supplied faceplates in any of the following sizes: single-gang, double-gang, or triple-gang. See Coalesse Tables, Storage, and Accessories Specification Guide

Tip: If you require your table top to be made into four pieces, this can be done as a special. Please contact Customer Service at 1.800.627.6770 to obtain a quote.

Tip: Tables available with zero, two, four or seven utility bays.

Standard Includes	Required to Specify
<ul style="list-style-type: none"> • Top: 1¼" particle board core with grade 1 laminate • Edge: 1 mm self edge (laminate top only), 3 mm plastic edge, 3 mm wood edge, or convex vinyl edge • Four bases: black laminate on MDF core • Wireway: black steel C-channels and side panels and black plastic access door • Concealed leveling glides: non-marring, black plastic 	<ol style="list-style-type: none"> 1 Style number 2 Laminate color number for top 3 Edge selection: <ul style="list-style-type: none"> - 1 mm self-edge (laminate top only) to match laminate top, if selected - 3 mm flat plastic edge color number, if selected - Convex vinyl edge, if selected: <ul style="list-style-type: none"> 6000 Black 6607 Woodrose 6609 Smoke 6655 Warm White 4 Options, if selected (see below) <p>► See <i>Surface Materials</i>, page 350.</p>

Options	Price	Required to Specify
Surface Materials <ul style="list-style-type: none"> • Grade 2 laminate • Grade 1 wood veneer • Grade 2 wood veneer • Stain-to-Match 	<ul style="list-style-type: none"> Prices at right Prices at right Prices at right No cost 	<ul style="list-style-type: none"> Specify with <i>Grade 2 laminate</i> and select color number. Specify with <i>Grade 1 wood veneer</i> and select color number. Specify with <i>Grade 2 wood veneer</i> and select color number. Specify with <i>Stain-to-Match</i>. <p>► Page 385</p>
Base <ul style="list-style-type: none"> • Aluminum base • Curated laminate base • Wood veneer base 	<ul style="list-style-type: none"> +\$ 598 +\$ 1216 +\$4603 	<ul style="list-style-type: none"> Replace L suffix in the style number with A suffix and select powder coat color number. Specify with <i>curated laminate</i> and select color number. Replace L suffix in the style number with V suffix and select wood color number.
Edges <ul style="list-style-type: none"> • Wood veneer tops • 3 mm plastic edge • 3 mm wood edge • Convex vinyl edge • Flat edge (6000 Black) • Wood veneer and laminate tops <ul style="list-style-type: none"> • Bullnose wood edge • Beveled wood edge • Knife wood edge • Waterfall wood edge • Faceted wood edge 	<ul style="list-style-type: none"> Prices at right Prices at right Prices at right Prices at right Prices at right Prices at right Prices at right Prices at right Prices at right Prices at right Prices at right Prices at right Prices at right Prices at right 	<ul style="list-style-type: none"> Specify with <i>3 mm plastic edge</i> and select color number. Specify with <i>3 mm wood edge</i> and select color number. Specify with <i>convex vinyl edge</i> and select color number. Specify with <i>flat edge</i>. Specify with <i>bullnose wood edge</i>. Specify with <i>beveled wood edge</i>. Specify with <i>knife wood edge</i>. Specify with <i>waterfall wood edge</i>. Specify with <i>faceted wood edge</i>.
Bay Option <ul style="list-style-type: none"> • No bays • Two bays • Four bays • Seven bays 	<ul style="list-style-type: none"> No cost +\$1030 +\$2060 +\$3605 	<ul style="list-style-type: none"> Specify with <i>no bays</i>. Specify with <i>two bays</i> and select color number. Specify with <i>four bays</i> and select color number. Specify with <i>seven bays</i> and select color number.
Duplex Wiring Schematic <ul style="list-style-type: none"> • 3+0 wireway • 1+1 hardwire, 2 circuits • Chicago powerway 	<ul style="list-style-type: none"> No cost No cost No cost 	<ul style="list-style-type: none"> Specify with <i>3+0 wireway, duplex</i>. Specify with <i>1+1 hardwire, 2 circuits, duplex</i>. Specify with <i>Chicago powerway</i>.
USB Wiring Schematic <ul style="list-style-type: none"> • 3+0 wireway • 1+1 hardwire, 2 circuits 	<ul style="list-style-type: none"> +\$ 140 per bay +\$ 140 per bay 	<ul style="list-style-type: none"> Specify with <i>3+0 wireway, USB</i>. Specify with <i>1+1 hardwire, 2 circuits, USB</i>.
Infeed <ul style="list-style-type: none"> • Tables with bay door(s) <ul style="list-style-type: none"> • Plug (20 amp single circuit) • Hardwire • NYC hardwire infeed 	<ul style="list-style-type: none"> No cost No cost No cost 	<ul style="list-style-type: none"> Specify with <i>plug</i>. Specify with <i>hardwire</i>. Specify with <i>NYC hardwire infeed</i>.

► Options, continued on next page

E-Table 2

DESIGN JEFF CRONK

22'L and 24'L Racetrack, Faceted, Rectangular, and Soft Radiused End Tables

SIN 711.11

►Options, continued from previous page

Options	Price	Required to Specify
Infeed Location	Tables with bay doors	
	• End base power infeed	No cost
	• Mid base power infeed	No cost
Related Products	• Transformer kit	► Page 161

Tip: Transformer kit must be the same wiring schematic as the table.

22'L Utility Bay Location

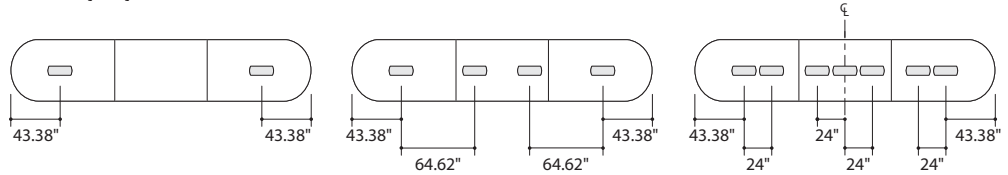

24'L Utility Bay Location

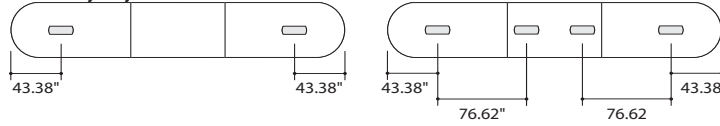

Base veneer and woodgrain laminate direction



Specification Information

Dimensions L W H	Style Number	Finish	Base Prices
			1 mm Self-Edge, 3 mm Plastic/3 mm Wood Edge, Flat Edge, or Convex Vinyl Edge:
			Bullnose Wood Edge:
			Beveled Wood Edge:
			Knife Wood Edge, Waterfall Wood Edge, or Faceted Wood Edge:

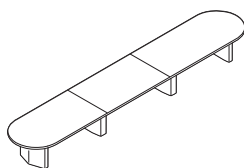

Tip: Racetrack tables are not available with waterfall or faceted wood edge.

Racetrack Tables with Four Bases

22' 48" 29"	E2C2248L	Grade 1 Laminate	\$ 8257	\$14,022	\$14,295	\$15,324
		Grade 2 Laminate	\$ 8651	\$14,416	\$14,689	\$15,718
		Grade 1 Wood Veneer	\$18,211	\$23,976	\$24,249	\$25,278
		Grade 2 Wood Veneer	\$19,896	\$25,661	\$25,934	\$26,963
22' 54" 29"	E2C2254L	Grade 1 Laminate	\$ 8829	\$15,296	\$15,608	\$16,785
		Grade 2 Laminate	\$ 9271	\$15,738	\$16,050	\$17,227
		Grade 1 Wood Veneer	\$20,208	\$26,675	\$26,987	\$28,164
		Grade 2 Wood Veneer	\$22,116	\$28,583	\$28,895	\$30,072
22' 60" 29"	E2C2260L	Grade 1 Laminate	\$ 9390	\$16,612	\$16,919	\$18,243
		Grade 2 Laminate	\$ 9881	\$17,103	\$17,410	\$18,734
		Grade 1 Wood Veneer	\$22,206	\$29,428	\$29,735	\$31,059
		Grade 2 Wood Veneer	\$24,342	\$31,564	\$31,871	\$33,195

►Specification Information, continued on next page

E-Table 2

DESIGN JEFF CRONK

22'L and 24'L Racetrack, Faceted, Rectangular, and Soft Radiused End Tables *continued*

SIN 711.11

► Specification information, continued from previous page

Specification Information				Base Prices							
Dimensions		Style	Finish								
L	W	H	Number								
				1 mm Self-Edge, 3 mm Plastic/ 3 mm Wood Edge, Flat Edge, or Convex Vinyl Edge:	Bullnose Wood Edge:	Beveled Wood Edge:	Knife Wood Edge, Waterfall Wood Edge, or Faceted Wood Edge:				

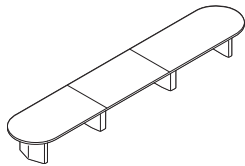

Tip: Racetrack tables are not available with waterfall or faceted wood edge.

Racetrack Tables with Four Bases

Dimensions	Style	Finish	Grade 1 Laminates	Grade 2 Laminates	Grade 1 Wood Veneer	Grade 2 Wood Veneer
24' 48" 29"	E2C2448L	Grade 1 Laminates	\$ 8334	\$14,337	\$14,640	\$15,582
		Grade 2 Laminates	\$ 8761	\$14,764	\$15,067	\$16,009
		Grade 1 Wood Veneer	\$18,419	\$24,422	\$24,725	\$25,667
		Grade 2 Wood Veneer	\$20,271	\$26,274	\$26,577	\$27,519
24' 54" 29"	E2C2454L	Grade 1 Laminates	\$ 8943	\$15,641	\$15,923	\$17,107
		Grade 2 Laminates	\$ 9425	\$16,123	\$16,405	\$17,589
		Grade 1 Wood Veneer	\$20,427	\$27,125	\$27,407	\$28,591
		Grade 2 Wood Veneer	\$22,526	\$29,224	\$29,506	\$30,690
24' 60" 29"	E2C2460L	Grade 1 Laminates	\$ 9488	\$16,988	\$17,219	\$18,644
		Grade 2 Laminates	\$10,023	\$17,523	\$17,754	\$19,179
		Grade 1 Wood Veneer	\$22,450	\$29,950	\$30,181	\$31,606
		Grade 2 Wood Veneer	\$24,798	\$32,298	\$32,529	\$33,954

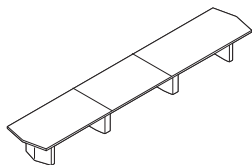

Tip: Faceted tables are not available with waterfall wood edge.

Tip: Vinyl edge profiles on faceted tables require a 4" radius on all corners.

Faceted Tables with Four Bases

Dimensions	Style	Finish	Grade 1 Laminates	Grade 2 Laminates	Grade 1 Wood Veneer	Grade 2 Wood Veneer
22' 48" 29"	E2F2248L	Grade 1 Laminates	\$ 8408	\$14,173	\$14,446	\$15,475
		Grade 2 Laminates	\$ 8802	\$14,567	\$14,840	\$15,869
		Grade 1 Wood Veneer	\$18,362	\$24,127	\$24,400	\$25,429
		Grade 2 Wood Veneer	\$20,035	\$25,800	\$26,073	\$27,102
22' 54" 29"	E2F2254L	Grade 1 Laminates	\$ 8979	\$15,446	\$15,758	\$16,935
		Grade 2 Laminates	\$ 9421	\$15,888	\$16,200	\$17,377
		Grade 1 Wood Veneer	\$20,358	\$26,825	\$27,137	\$28,314
		Grade 2 Wood Veneer	\$22,256	\$28,723	\$29,035	\$30,212
22' 60" 29"	E2F2260L	Grade 1 Laminates	\$ 9540	\$16,762	\$17,069	\$18,370
		Grade 2 Laminates	\$10,031	\$17,253	\$17,560	\$18,861
		Grade 1 Wood Veneer	\$22,356	\$29,578	\$29,885	\$31,186
		Grade 2 Wood Veneer	\$24,481	\$31,703	\$32,010	\$33,311

► Specification Information, continued on next page









E-Table 2

DESIGN JEFF CRONK

22'L and 24'L Racetrack, Faceted, Rectangular, and Soft Radiused End Tables

SIN 711.11

► Specification Information, continued from previous page

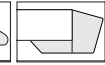
Specification Information				Base Prices								
Dimensions		Style	Finish									
L	W	H	Number									
												
				1 mm Self-Edge, 3 mm Plastic/ 3 mm Wood Edge, Flat Edge, or Convex Vinyl Edge:	Bullnose Wood Edge:	Beveled Wood Edge:	Knife Wood Edge, Waterfall Wood Edge, or Faceted Wood Edge:					

Faceted Tables with Four Bases, continued

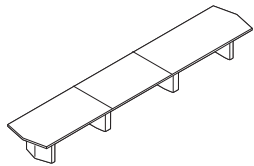

Tip: Faceted tables are not available with waterfall wood edge.

Tip: Vinyl edge profiles on faceted tables require a 4" radius on all corners.

Dimensions	Style	Finish	Grade 1 Laminate	Grade 2 Laminate	Grade 1 Wood Veneer	Grade 2 Wood Veneer
24' 48" 29"	E2F2448L	Grade 1 Laminate	\$ 8485	\$14,488	\$14,791	\$15,733
		Grade 2 Laminate	\$ 8912	\$14,915	\$15,218	\$16,160
		Grade 1 Wood Veneer	\$18,570	\$24,573	\$24,876	\$25,818
		Grade 2 Wood Veneer	\$20,403	\$26,406	\$26,709	\$27,651
24' 54" 29"	E2F2454L	Grade 1 Laminate	\$ 9093	\$15,791	\$16,073	\$17,257
		Grade 2 Laminate	\$ 9575	\$16,273	\$16,555	\$17,739
		Grade 1 Wood Veneer	\$20,577	\$27,275	\$27,557	\$28,741
		Grade 2 Wood Veneer	\$22,660	\$29,358	\$29,640	\$30,824
24' 60" 29"	E2F2460L	Grade 1 Laminate	\$ 9637	\$17,137	\$17,368	\$18,692
		Grade 2 Laminate	\$10,172	\$17,672	\$17,903	\$19,227
		Grade 1 Wood Veneer	\$22,599	\$30,099	\$30,330	\$31,654
		Grade 2 Wood Veneer	\$24,934	\$32,434	\$32,665	\$33,989

Rectangular Tables with Four Bases

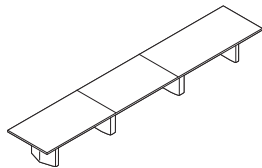

Tip: Vinyl edge profiles on rectangular tables require a 4" radius on all corners.

Dimensions	Style	Finish	Grade 1 Laminate	Grade 2 Laminate	Grade 1 Wood Veneer	Grade 2 Wood Veneer
22' 48" 29"	E2R2248L	Grade 1 Laminate	\$ 8107	\$13,872	\$14,145	\$15,174
		Grade 2 Laminate	\$ 8501	\$14,266	\$14,539	\$15,568
		Grade 1 Wood Veneer	\$18,061	\$23,826	\$24,099	\$25,128
		Grade 2 Wood Veneer	\$19,734	\$25,499	\$25,772	\$26,801
22' 54" 29"	E2R2254L	Grade 1 Laminate	\$ 8680	\$15,147	\$15,459	\$16,636
		Grade 2 Laminate	\$ 9122	\$15,589	\$15,901	\$17,078
		Grade 1 Wood Veneer	\$20,059	\$26,526	\$26,838	\$28,015
		Grade 2 Wood Veneer	\$21,957	\$28,424	\$28,736	\$29,913
22' 60" 29"	E2R2260L	Grade 1 Laminate	\$ 9240	\$16,462	\$16,769	\$18,070
		Grade 2 Laminate	\$ 9731	\$16,953	\$17,260	\$18,561
		Grade 1 Wood Veneer	\$22,056	\$29,278	\$29,585	\$30,886
		Grade 2 Wood Veneer	\$24,181	\$31,403	\$31,710	\$33,011
24' 48" 29"	E2R2448L	Grade 1 Laminate	\$ 8186	\$14,189	\$14,492	\$15,434
		Grade 2 Laminate	\$ 8613	\$14,616	\$14,919	\$15,861
		Grade 1 Wood Veneer	\$18,271	\$24,274	\$24,577	\$25,519
		Grade 2 Wood Veneer	\$20,104	\$26,107	\$26,410	\$27,352

► Specification Information, continued on next page









E-Table 2

DESIGN JEFF CRONK

22'L and 24'L Racetrack, Faceted, Rectangular, and Soft Radiused End Tables *continued*

SIN 711.11

► Specification Information, continued from previous page

Specification Information				Base Prices								
Dimensions		Style	Finish									
L	W	H	Number									
												
				1 mm Self-Edge, 3 mm Plastic/ 3 mm Wood Edge, Flat Edge, or Convex Vinyl Edge:	Bullnose Wood Edge:	Beveled Wood Edge:	Knife Wood Edge, Waterfall Wood Edge, or Faceted Wood Edge:					

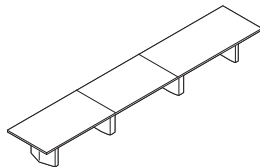

Tip: Vinyl edge profiles on rectangular tables require a 4" radius on all corners.

Rectangular Tables with Four Bases, continued

Dimensions	Style	Finish	Grade 1	Grade 2	Grade 1	Grade 2	Grade 1	Grade 2
L	W	H	Laminate	Laminate	Wood Veneer	Wood Veneer	Laminate	Laminate
24'	54"	29"	E2R2454L	Grade 1 Laminate	\$ 8793	\$15,491	\$15,773	\$16,957
				Grade 2 Laminate	\$ 9275	\$15,973	\$16,255	\$17,439
				Grade 1 Wood Veneer	\$20,277	\$26,975	\$27,257	\$28,441
				Grade 2 Wood Veneer	\$22,360	\$29,058	\$29,340	\$30,524
24'	60"	29"	E2R2460L	Grade 1 Laminate	\$ 9340	\$16,840	\$17,071	\$18,395
				Grade 2 Laminate	\$ 9875	\$17,375	\$17,606	\$18,930
				Grade 1 Wood Veneer	\$22,302	\$29,802	\$30,033	\$31,357
				Grade 2 Wood Veneer	\$24,637	\$32,137	\$32,368	\$33,692

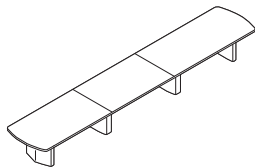

Tip: Vinyl edge profiles on soft radiused tables require a 4" radius on all corners.

Soft Radiused End Tables with Four Bases

Dimensions	Style	Finish	Grade 1	Grade 2	Grade 1	Grade 2	Grade 1	Grade 2
L	W	H	Laminate	Laminate	Wood Veneer	Wood Veneer	Laminate	Laminate
22'	48"	29"	E2S2248L	Grade 1 Laminate	\$ 8257	\$14,022	N.A.	N.A.
				Grade 2 Laminate	\$ 8651	\$14,416	N.A.	N.A.
				Grade 1 Wood Veneer	\$18,211	\$23,976	N.A.	N.A.
				Grade 2 Wood Veneer	\$19,884	\$25,649	N.A.	N.A.
22'	54"	29"	E2S2254L	Grade 1 Laminate	\$ 8829	\$15,296	N.A.	N.A.
				Grade 2 Laminate	\$ 9271	\$15,738	N.A.	N.A.
				Grade 1 Wood Veneer	\$20,208	\$26,675	N.A.	N.A.
				Grade 2 Wood Veneer	\$22,106	\$28,573	N.A.	N.A.
22'	60"	29"	E2S2260L	Grade 1 Laminate	\$ 9390	\$16,612	N.A.	N.A.
				Grade 2 Laminate	\$ 9881	\$17,103	N.A.	N.A.
				Grade 1 Wood Veneer	\$22,206	\$29,428	N.A.	N.A.
				Grade 2 Wood Veneer	\$24,331	\$31,553	N.A.	N.A.
24'	48"	29"	E2S2448L	Grade 1 Laminate	\$ 8334	\$14,337	N.A.	N.A.
				Grade 2 Laminate	\$ 8761	\$14,764	N.A.	N.A.
				Grade 1 Wood Veneer	\$18,419	\$24,422	N.A.	N.A.
				Grade 2 Wood Veneer	\$20,252	\$26,255	N.A.	N.A.
24'	54"	29"	E2S2454L	Grade 1 Laminate	\$ 8943	\$15,641	N.A.	N.A.
				Grade 2 Laminate	\$ 9425	\$16,123	N.A.	N.A.
				Grade 1 Wood Veneer	\$20,427	\$27,125	N.A.	N.A.
				Grade 2 Wood Veneer	\$22,510	\$29,208	N.A.	N.A.
24'	60"	29"	E2S2460L	Grade 1 Laminate	\$ 9488	\$16,988	N.A.	N.A.
				Grade 2 Laminate	\$10,023	\$17,523	N.A.	N.A.
				Grade 1 Wood Veneer	\$22,450	\$29,950	N.A.	N.A.
				Grade 2 Wood Veneer	\$24,785	\$32,285	N.A.	N.A.

Coalesse

E-Table 2

DESIGN JEFF CRONK

22'L and 24'L Racetrack, Faceted, Rectangular, and Soft Radiused End Tables

SIN 711.11

E-Table 2

E-Table 2

DESIGN JEFF CRONK

36"W Trapezoid Tables with Aluminum Base Only

SIN 711.11

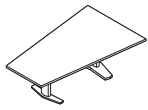

Tip: Shipped knocked down.

Tip: Top ships in one piece.

Tip: 1 mm self-edge is only available on a laminate top surface.

Tip: Flat edge is only available on wood veneer tops and is offered in 6000 Black only.

Tip: When a 3 mm wood edge is specified on a wood veneer top, the edge finish will match the top finish.

Tip: If you specify a wood edge on a top with woodgrain laminate, the edge and the top may not match.

Tip: For table with three or more bases, you must specify the entry point of the base power infeed, either an end base or a mid base location, in order to receive the correct length of base power infeed.

Tip: Each utility bay comes with two universal faceplate openings that accept customer-supplied faceplates in any of the following sizes: single-gang, double-gang, or triple-gang.
► See Coalesse Tables, Storage, and Accessories Specification Guide

Tip: 96"L tables available with zero or two utility bays. 10'L tables available with zero, two, or three utility bays. 12'L tables available with zero, two, three, or four utility bays. 14'L tables available with zero, two, or four utility bays.

Tip: For 14'L tables, your table top may be cut into three pieces, this can be done as a special. Please contact Customer Service at 1.800.627.6770 to obtain a quote.

Standard Includes		Required to Specify	
► Need help? Product details, see <i>Coalesse Tables, Storage, and Accessories Specification Guide</i>	<ul style="list-style-type: none"> • Top: 1¼" particle board core with grade 1 laminate • Edge: 1 mm self edge (laminate top only), 3 mm plastic edge, 3 mm wood edge, or convex vinyl edge • Bases: cast and extruded aluminum with powder coat • Wireway: black steel C-channels and side panels and black plastic access door • Concealed leveling glides: non-marring, black plastic 	<ol style="list-style-type: none"> 1 Style number 2 Powder coat color number for base 3 Laminate color number for top 4 Edge selection: <ul style="list-style-type: none"> - 1 mm self-edge (laminate top only) to match laminate top, if selected - 3 mm flat plastic edge color number, if selected - Convex vinyl edge, if selected: <ul style="list-style-type: none"> 6000 Black 6607 Woodrose 6609 Smoke 6655 Warm White 5 Options, if selected (see below) 	► See <i>Surface Materials</i> , page 350.
Options		Price	Required to Specify
Surface Materials	Top <ul style="list-style-type: none"> • Grade 2 laminate • Grade 1 wood veneer • Grade 2 wood veneer • Stain-to-Match 	<ul style="list-style-type: none"> Prices at right Prices at right Prices at right No cost 	<ul style="list-style-type: none"> Specify with <i>Grade 2 laminate</i> and select color number. Specify with <i>Grade 1 wood veneer</i> and select color number. Specify with <i>Grade 2 wood veneer</i> and select color number. Specify with <i>Stain-to-Match</i>.
Edges	Wood veneer tops <ul style="list-style-type: none"> • 3 mm plastic edge • 3 mm wood edge • Convex vinyl edge • Flat edge (6000 Black) Wood veneer and laminate tops <ul style="list-style-type: none"> • Bullnose wood edge • Beveled wood edge • Knife wood edge • Waterfall wood edge • Faceted wood edge 	<ul style="list-style-type: none"> Prices at right Prices at right Prices at right Prices at right Prices at right Prices at right Prices at right Prices at right Prices at right 	<ul style="list-style-type: none"> Specify with <i>3 mm plastic edge</i> and select color number. Specify with <i>3 mm wood edge</i> and select color number. Specify with <i>convex vinyl edge</i> and select color number. Specify with <i>flat edge</i>. Specify with <i>bullnose wood edge</i>. Specify with <i>beveled wood edge</i>. Specify with <i>knife wood edge</i>. Specify with <i>waterfall wood edge</i>. Specify with <i>faceted wood edge</i>.
Sectioned top (96"L, 10'L, and 12'L only)	<ul style="list-style-type: none"> • Sectioned top 	+\$ 372	Specify with <i>sectioned top</i> .
Bay Option	<ul style="list-style-type: none"> • No bays • Two bays • Three bays • Four bays 	<ul style="list-style-type: none"> No cost +\$1030 +\$1545 +\$2060 	<ul style="list-style-type: none"> Specify with <i>no bays</i>. Specify with <i>two bays</i> and select color number. Specify with <i>three bays</i> and select color number. Specify with <i>four bays</i> and select color number.
Duplex Wiring Schematic	Tables with bay door(s) <ul style="list-style-type: none"> • 3+0 wireway • 1+1 hardwire, 2 circuits • Chicago powerway 	<ul style="list-style-type: none"> No cost No cost No cost 	<ul style="list-style-type: none"> Specify with <i>3+0 wireway, duplex</i>. Specify with <i>1+1 hardwire, 2 circuits, duplex</i>. Specify with <i>Chicago powerway</i>.
USB Wiring Schematic	Tables with bay door(s) <ul style="list-style-type: none"> • 3+0 wireway • 1+1 hardwire, 2 circuits 	<ul style="list-style-type: none"> +\$ 140 per bay +\$ 140 per bay 	<ul style="list-style-type: none"> Specify with <i>3+0 wireway, USB</i>. Specify with <i>1+1 hardwire, 2 circuits, USB</i>.
Infeed	Tables with bay door(s) <ul style="list-style-type: none"> • Plug (20 amp single circuit) • Hardwire • NYC hardware infeed 	<ul style="list-style-type: none"> No cost No cost No cost 	<ul style="list-style-type: none"> Specify with <i>plug</i>. Specify with <i>hardwire</i>. Specify with <i>NYC hardware infeed</i>.

► Options, continued on next page

E-Table 2

DESIGN JEFF CRONK

36"W Trapezoid Tables with Aluminum Base Only

SIN 711.11

► Options, continued from previous page

Options	Price	Required to Specify
Infeed Location (14'L table only)	<ul style="list-style-type: none"> Tables with bay doors • End base power infeed • Mid base power infeed 	<p>No cost</p> <p>No cost</p> <p>Specify with end base entry location for location base power infeed. Specify with mid base entry location for location base power infeed.</p>

Tip: Transformer kit must be the same wiring schematic as the table.

Related Products	• Transformer kit	► Page 161
-------------------------	-------------------	------------

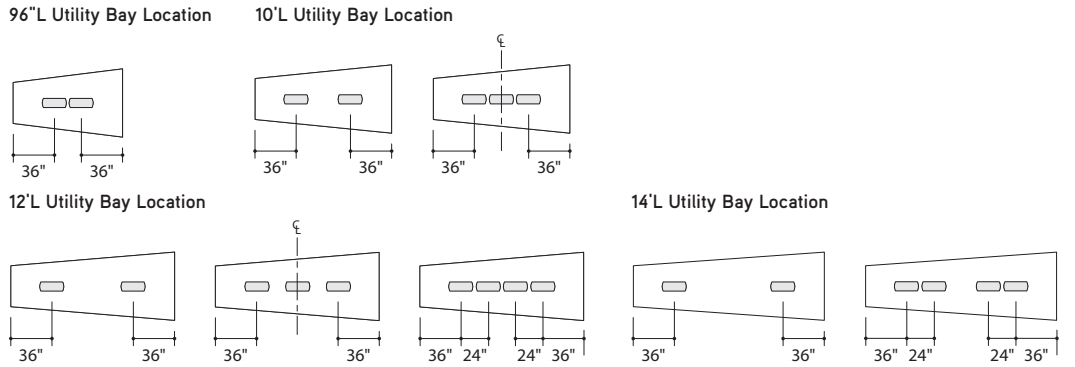

Base veneer and woodgrain laminate direction



Specification Information

Dimensions L W H	Style Number	Finish	Base Prices							
			1 mm Self-Edge, 3 mm Plastic/ 3 mm Wood Edge, Flat Edge, or Convex Vinyl Edge:	Bullnose Wood Edge:	Beveled Wood Edge:	Knife Wood Edge, Waterfall Wood Edge, or Faceted Wood Edge:				

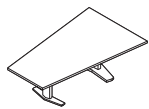

Tip: Vinyl edge profiles on trapezoid tables require a 4" radius on all corners.

96" 36" 29"	E2T9636A	Grade 1 Laminate	\$ 4387	\$ 5488	\$ 5585	\$ 5795
		Grade 2 Laminate	\$ 4579	\$ 5680	\$ 5777	\$ 5987
		Grade 1 Wood Veneer	\$ 6256	\$ 7357	\$ 7454	\$ 7664
		Grade 2 Wood Veneer	\$ 7014	\$ 8115	\$ 8212	\$ 8422
10' 36" 29"	E2T1036A	Grade 1 Laminate	\$ 4778	\$ 6801	\$ 6999	\$ 7363
		Grade 2 Laminate	\$ 5017	\$ 7040	\$ 7238	\$ 7602
		Grade 1 Wood Veneer	\$ 6980	\$ 9003	\$ 9201	\$ 9565
		Grade 2 Wood Veneer	\$ 7928	\$ 9951	\$10,149	\$10,513
12' 36" 29"	E2T1236A	Grade 1 Laminate	\$ 4868	\$ 7824	\$ 8065	\$ 8567
		Grade 2 Laminate	\$ 5157	\$ 8113	\$ 8354	\$ 8856
		Grade 1 Wood Veneer	\$ 8078	\$11,034	\$11,275	\$11,777
		Grade 2 Wood Veneer	\$ 9223	\$12,179	\$12,420	\$12,922
14' 36" 29"	E2T1436A	Grade 1 Laminate	\$ 7099	\$11,597	\$11,827	\$12,614
		Grade 2 Laminate	\$ 7416	\$11,914	\$12,144	\$12,931
		Grade 1 Wood Veneer	\$13,355	\$17,853	\$18,083	\$18,870
		Grade 2 Wood Veneer	\$14,730	\$19,228	\$19,458	\$20,245

Tip: 14' L tables are standard with three bases.

Tip: 14' L tops are manufactured and shipped in two pieces.

E-Table 2

DESIGN JEFF CRONK

48"W Trapezoid Tables

SIN 711.11

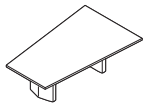

Tip: Shipped knocked down.

Tip: Top ships in one piece.

Tip: 1 mm self-edge is only available on a laminate top surface.

Tip: Flat edge is only available on wood veneer tops and is offered in 6000 Black only.

Tip: When a 3 mm wood edge is specified on a wood veneer top, the edge finish will match the top finish.

Tip: 96"L, 10'L, and 12'L tables have two bases. 14'L tables have three bases.

Tip: For table with three or more bases, you must specify the entry point of the base power infeed, either an end base or mid base location, in order to receive the correct length of base power infeed.

Tip: If you specify a wood edge on a top with woodgrain laminate, the edge and the top may not match.

Tip: For 14' tables, your table top may be cut into three pieces, this can be done as a special. Please contact Customer Service at 1.800.627.6770 to obtain a quote.

Tip: Each utility bay comes with two universal faceplate openings that accept customer-supplied faceplates in any of the following sizes: single-gang, double-gang, or triple-gang. ▶ See Coalesse Tables, Storage, and Accessories Specification Guide

Base veneer and woodgrain laminate direction



Standard Includes	Required to Specify
<ul style="list-style-type: none"> ▶ Need help? Product details, see <i>Coalesse Tables, Storage, and Accessories Specification Guide</i> • Top: 1/4" particle board core with laminate • Edge: 1 mm self-edge (laminate top only), 3 mm plastic edge, 3 mm wood edge, or convex vinyl edge • Bases: black laminate on MDF core • Wireway: black steel C-channels and side panels and black plastic access door • Concealed leveling glides: non-marring, black plastic 	<ol style="list-style-type: none"> Style number Laminate color number for top Edge selection: <ul style="list-style-type: none"> - 1 mm self-edge (laminate top only) to match laminate top, if selected - 3 mm flat plastic edge color number, if selected - Convex vinyl edge, if selected: <ul style="list-style-type: none"> 6000 Black 6607 Woodrose 6609 Smoke 6655 Warm White Options, if selected (see below) <p>▶ See <i>Surface Materials</i>, page 350.</p>

Options	Price	Required to Specify
Surface Materials <ul style="list-style-type: none"> • Grade 2 laminate • Grade 1 wood veneer • Grade 2 wood veneer • Stain-to-Match 	<ul style="list-style-type: none"> Prices at right Prices at right Prices at right No cost 	<ul style="list-style-type: none"> Specify with <i>Grade 2 laminate</i> and select color number. Specify with <i>Grade 1 wood veneer</i> and select color number. Specify with <i>Grade 2 wood veneer</i> and select color number. Specify with <i>Stain-to-Match</i>. <p>▶ Page 385</p>
Base <ul style="list-style-type: none"> • Two aluminum bases • Three aluminum bases • Two curated laminate bases • Three curated laminate bases • Two wood veneer bases • Three wood veneer bases 	<ul style="list-style-type: none"> +\$ 139 +\$ 371 +\$ 571 +\$ 893 +\$2222 +\$3412 	<ul style="list-style-type: none"> Replace L suffix in the style number with A suffix and select powder coat color number. Replace L suffix in the style number with A suffix and select powder coat color number. Specify with <i>curated laminate</i> and select color number. Specify with <i>curated laminate</i> and select color number. Replace L suffix in the style number with V suffix and select wood color number. Replace L suffix in the style number with V suffix and select wood color number.
Edges <ul style="list-style-type: none"> • Wood veneer tops <ul style="list-style-type: none"> • 3 mm plastic edge • 3 mm wood edge • Convex vinyl edge • Flat edge (6000 Black) • Wood veneer and laminate tops <ul style="list-style-type: none"> • Bullnose wood edge • Beveled wood edge • Knife wood edge • Waterfall wood edge • Faceted wood edge 	<ul style="list-style-type: none"> Prices at right Prices at right Prices at right Prices at right Prices at right Prices at right Prices at right Prices at right Prices at right Prices at right 	<ul style="list-style-type: none"> Specify with <i>3 mm plastic edge</i> and select color number. Specify with <i>3 mm wood edge</i> and select color number. Specify with <i>convex vinyl edge</i> and select color number. Specify with <i>flat edge</i>. Specify with <i>bullnose wood edge</i>. Specify with <i>beveled wood edge</i>. Specify with <i>knife wood edge</i>. Specify with <i>waterfall wood edge</i>. Specify with <i>faceted wood edge</i>.
Sectioned top (96"L, 10'L, and 12'L only) <ul style="list-style-type: none"> • Sectioned top 	<ul style="list-style-type: none"> +\$ 372 	<ul style="list-style-type: none"> Specify with <i>sectioned top</i>.
Bay Option <ul style="list-style-type: none"> • No bays • Two bays • Three bays • Four bays 	<ul style="list-style-type: none"> No cost +\$1030 +\$1545 +\$2060 	<ul style="list-style-type: none"> Specify with <i>no bays</i>. Specify with <i>two bays</i> and select color number. Specify with <i>three bays</i> and select color number. Specify with <i>four bays</i> and select color number.
Duplex Wiring Schematic <ul style="list-style-type: none"> • Tables with bay door(s) <ul style="list-style-type: none"> • 3+0 wireway • 1+1 hardwire, 2 circuits • Chicago powerway 	<ul style="list-style-type: none"> No cost No cost No cost 	<ul style="list-style-type: none"> Specify with <i>3+0 wireway, duplex</i>. Specify with <i>1+1 hardwire, 2 circuits, duplex</i>. Specify with <i>Chicago powerway</i>.

▶ Options, continued on next page

E-Table 2

DESIGN JEFF CRONK

48"W Trapezoid Tables

SIN 711.11

►Options, continued from previous page

	Options	Price	Required to Specify
USB Wiring Schematic	Tables with bay door(s) <ul style="list-style-type: none"> • 3+0 wireway • 1+1 hardwire, 2 circuits 	+\$140 per bay +\$140 per bay	Specify with 3+0 wireway, USB. Specify with 1+1 hardwire, 2 circuits, USB.
Infeed	Tables with bay door(s) <ul style="list-style-type: none"> • Plug (20 amp single circuit) • Hardwire • NYC hardwire infeed 	No cost No cost No cost	Specify with plug. Specify with hardwire. Specify with NYC hardwire infeed
Infeed Location (14'L table only)	Tables with bay doors <ul style="list-style-type: none"> • End base power infeed • Mid base power infeed 	No cost No cost	Specify with end base entry location for location base power infeed. Specify with mid base entry location for location base power infeed.
Related Products	<ul style="list-style-type: none"> • Transformer kit 		► Page 161

Tip: 96"L tables available with zero or two utility bays. 10'L tables available with zero, two, or three utility bays. 12'L tables available with zero, two, three, or four utility bays. 14'L tables available with zero, two, or four utility bays.

Tip: Transformer kit must be the same wiring schematic as the table.

96"L Utility Bay Location

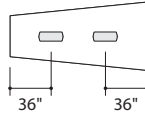
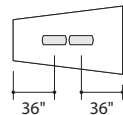

10'L Utility Bay Location

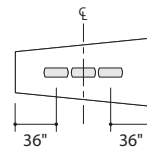

12'L Utility Bay Location

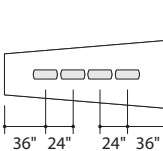
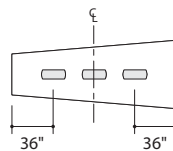
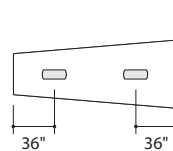

14'L Utility Bay Location

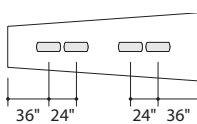
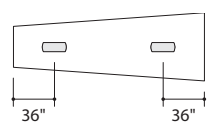

►Specification Information, on next page

E-Table 2

DESIGN JEFF CRONK

48"W Trapezoid Tables *continued*

SIN 711.11

► Options, on previous page

Specification Information

Dimensions			Style Number	Finish	Base Prices						
L	W	H			1 mm Self-Edge, 3 mm Plastic/ 3 mm Wood Edge, Flat Edge, or Convex Vinyl Edge:	Bullnose Wood Edge:	Beveled Wood Edge:	Knife Wood Edge, Waterfall Wood Edge, or Faceted Wood Edge:			

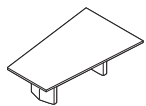

Tip: Vinyl edge profiles on trapezoid tables require a 4" radius on all corners.

96"	48"	29"	E2T9648L	Grade 1 Laminate	\$ 4233	\$ 5334	\$ 5431	\$ 5641
				Grade 2 Laminate	\$ 4425	\$ 5526	\$ 5623	\$ 5833
				Grade 1 Wood Veneer	\$ 6102	\$ 7203	\$ 7300	\$ 7510
				Grade 2 Wood Veneer	\$ 6860	\$ 7961	\$ 8058	\$ 8268
10'	48"	29"	E2T1048L	Grade 1 Laminate	\$ 4626	\$ 6649	\$ 6847	\$ 7211
				Grade 2 Laminate	\$ 4865	\$ 6888	\$ 7086	\$ 7450
				Grade 1 Wood Veneer	\$ 6828	\$ 8851	\$ 9049	\$ 9413
				Grade 2 Wood Veneer	\$ 7776	\$ 9799	\$ 9997	\$10,361
12'	48"	29"	E2T1248L	Grade 1 Laminate	\$ 4711	\$ 7667	\$ 7908	\$ 8410
				Grade 2 Laminate	\$ 5000	\$ 7956	\$ 8197	\$ 8699
				Grade 1 Wood Veneer	\$ 7921	\$10,877	\$11,118	\$11,620
				Grade 2 Wood Veneer	\$ 9066	\$12,022	\$12,263	\$12,765
14'	48"	29"	E2T1448L	Grade 1 Laminate	\$ 6732	\$11,230	\$11,460	\$12,247
				Grade 2 Laminate	\$ 7049	\$11,547	\$11,777	\$12,564
				Grade 1 Wood Veneer	\$12,988	\$17,486	\$17,716	\$18,503
				Grade 2 Wood Veneer	\$14,363	\$18,861	\$19,091	\$19,878

Tip: 14'L tables are standard with three bases.

Tip: 14'L tops are manufactured and shipped in two pieces.

E-Table 2 Accessories

SIN 711.11

Floor Monument Kit

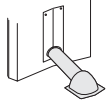

Tip: Wire manager can be cut on site to desired length.

Standard Includes	Required to Specify
<ul style="list-style-type: none"> • Shell: black plastic only • 72"L wire manager: black plastic only 	Style number

Specification Information

Style Number	Price
793369	\$108

Transformer Kit

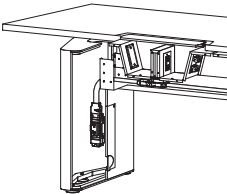

Tip: Transformer kit must be same wiring schematic as table.

Tip: Order the transformer kit to allow oversized transformers or other electronic devices to be accommodated inside the table base rather than inside the table's utility bay.

Tip: Transformer kit can only be attached on the opposite end of the table from where the base power infeed is attached.

Standard Includes	Required to Specify
<ul style="list-style-type: none"> • Jumper, power block, and two duplex receptacles for circuit 1: black • Three-circuit, 3+0 wiring schematic 	1 Style number 2 Options, if selected (see below)

Options	Price	Required to Specify
Two-circuit, separate neutrals <ul style="list-style-type: none"> • 1+1-circuit, separate neutrals wiring schematic 	No cost	Add suffix Z to the style number.

Specification Information

Style Number	Price
E2TK	\$176

Host Collection

Round Tables (SIN 711.11)	164
Rectangular Tables (SIN 711.11)	166
Soft Radiused Tables (SIN 711.11)	194
Racetrack Tables (SIN 711.11)	224
Boat Shaped Tables (SIN 711.11)	256
Trapezoid Tables (SIN 711.11)	276
Accessories (SIN 711.11)	283

Host Collection Round Tables

DESIGN F/P DESIGN AND VECTA DESIGN TEAM

SIN 711.11



Tip: Shipped knocked down and top ships in one piece.

Tip: The wood edge on a table top with woodgrain laminate may not match the top.

Standard Includes	Required to Specify
<ul style="list-style-type: none"> ▶ Need help? Product details, see <i>Coalesse Tables, Storage, and Accessories Specification Guide</i> • Top: 1¼" particle board core with laminate • Flat wood edge • TAP, if selected: 10"W x 12"L opening(s) trimmed with a flat solid wood profile and with brushed anodized aluminum doors • Base: <ul style="list-style-type: none"> - Wood veneer - Concealed leveling glides: non-marring, black plastic 	<ol style="list-style-type: none"> 1 Top Style number 2 Wood color number for base 3 Laminate color number for table top, if selected 4 Wood color number for wood edge ▶ See <i>Hardwood and Veneer Matrix</i>, page 364 5 Door color number for storage tray or TAP doors, if selected <ul style="list-style-type: none"> - 8044 Black - 8047 Silver 6 Options, if selected (see below) ▶ See <i>Surface Materials</i>, page 350.

Veneer direction



Tip: You must send a sample of reasonable size for *Stain-to-Match*.

Options	Price	Required to Specify
Surface Materials <ul style="list-style-type: none"> • Top • Grade 2 laminate • Grade 1 wood veneer • Grade 2 wood veneer • Grade 1 wedge lay-up veneer • Grade 2 wedge lay-up veneer • Stain-to-Match 	<ul style="list-style-type: none"> Prices at right Prices at right Prices at right Prices at right Prices at right No cost 	<ul style="list-style-type: none"> Specify with <i>Grade 2 laminate</i> and select color number. Specify with <i>Grade 1 wood veneer</i> and select color number. Specify with <i>Grade 2 wood veneer</i> and select color number. Specify with <i>Grade 1 wedge lay-up veneer</i> and select color number. Specify with <i>Grade 2 wedge lay-up veneer</i> and select color number. Specify with <i>Stain-to-Match</i>. ▶ Page 385

Edges <ul style="list-style-type: none"> • Bullnose wood edge • Beveled wood edge • Horizon wood edge 	<ul style="list-style-type: none"> Prices at right Prices at right Prices at right 	<ul style="list-style-type: none"> Specify with <i>bullnose wood edge</i>. Specify with <i>beveled wood edge</i>. Specify with <i>Horizon wood edge</i>.
---	---	---

TAP Location

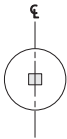

Tip: Tables available with zero or one TAP.

Tip: In addition to the data and audio/video AAPs available from Coalesse, other styles of AAPs are available through Extron Electronics. For an Extron dealer, call 1.800.633.9876.

Tip: See TAP options for electrical systems and faceplate list.

TAP Electrical System with Faceplate Options <ul style="list-style-type: none"> • Field-wired tray (no electrical) <ul style="list-style-type: none"> - PAFW field-wired tray (no electrical) with blank AAPs - PDFW field-wired tray (no electrical) with two data AAPs - PVFW field-wired tray (no electrical) with two of each video/audio and data AAPs • Cord and plug tray (10' cord) <ul style="list-style-type: none"> - PACP cord and plug tray with outlets and blank AAPs - PDCP cord and plug tray with outlets and two data AAPs - PAVC cord and plug tray with outlets and two of each video/audio and data AAPs • Hard-wired tray (6' conduit) <ul style="list-style-type: none"> - PAHW hard-wired tray with outlets and blank AAPs - PDHW hard-wired tray with outlets and two data AAPs - PAVH hard-wired tray with outlets and two of each video/audio and data AAPs 	<ul style="list-style-type: none"> No cost No cost No cost 	<ul style="list-style-type: none"> Specify with <i>power data</i>, and select TAP type and TAP door color number. Specify with <i>power data</i>, and select TAP type and TAP door color number. Specify with <i>power data</i>, and select TAP type and TAP door color number.
---	---	--

Storage Tray <ul style="list-style-type: none"> • Storage tray 	<ul style="list-style-type: none"> -\$593 	<ul style="list-style-type: none"> Specify with <i>storage tray</i> and select door color number.
--	--	--

Doors <ul style="list-style-type: none"> • Storage tray wood veneer doors • TAP wood veneer doors 	<ul style="list-style-type: none"> +\$298 per door +\$298 per door 	<ul style="list-style-type: none"> Specify with <i>wood doors</i>. Specify with <i>wood doors</i>.
--	--	--

▶ Options, continued on next page

Tip: Wood veneer doors for storage tray or TAP will always be cross grain.

Tip: Veneer doors not recommended for wedge lay-up veneer tables.

Host Collection Round Tables

DESIGN F/P DESIGN AND VECTA DESIGN TEAM

SIN 711.11

Tip: Connectrac must be the same wiring schematic as the table.

Tip: Last digit of style number indicates number of TAP(s).





►Options, continued from previous page

Related Products

- Floor kit: Connectrac

► Page 283

Specification Information

Style Number	Finish	Base Prices			
					
		Flat Wood Edge:	Bullnose Wood Edge:	Beveled Wood Edge:	Horizon Wood Edge:

48"W Diameter One Piece Top

0 TAP

HS4800D10	Grade 1 Laminate	\$4353	\$4405	\$4478	\$4935
	Grade 2 Laminate	\$4402	\$4454	\$4527	\$4984
	Grade 1 Veneer	\$4762	\$4814	\$4887	\$5344
	Grade 2 Veneer	\$5014	\$5066	\$5139	\$5596
	Grade 1 Wedge Veneer	\$5203	\$5255	\$5328	\$5785
	Grade 2 Wedge Veneer	\$5910	\$5962	\$6035	\$6492

1 TAP

HS4800D11	Grade 1 Laminate	\$5940	\$5992	\$6065	\$6522
	Grade 2 Laminate	\$5989	\$6041	\$6114	\$6571
	Grade 1 Veneer	\$6349	\$6401	\$6474	\$6931
	Grade 2 Veneer	\$6601	\$6653	\$6726	\$7183
	Grade 1 Wedge Veneer	\$6790	\$6842	\$6915	\$7372
	Grade 2 Wedge Veneer	\$7497	\$7549	\$7622	\$8079

60" Diameter One Piece Top

0 TAP

HS6000D10	Grade 1 Laminate	\$4692	\$4757	\$4846	\$5319
	Grade 2 Laminate	\$4765	\$4830	\$4919	\$5392
	Grade 1 Veneer	\$5460	\$5525	\$5614	\$6087
	Grade 2 Veneer	\$5852	\$5917	\$6006	\$6479
	Grade 1 Wedge Veneer	\$6204	\$6269	\$6358	\$6831
	Grade 2 Wedge Veneer	\$7442	\$7507	\$7596	\$8069

1 TAP

HS6000D11	Grade 1 Laminate	\$6278	\$6343	\$6432	\$6905
	Grade 2 Laminate	\$6351	\$6416	\$6505	\$6978
	Grade 1 Veneer	\$7046	\$7111	\$7200	\$7673
	Grade 2 Veneer	\$7438	\$7503	\$7592	\$8065
	Grade 1 Wedge Veneer	\$7790	\$7855	\$7944	\$8417
	Grade 2 Wedge Veneer	\$9028	\$9093	\$9182	\$9655



Host Collection

Rectangular Tables with Two Bases
DESIGN F/P DESIGN AND VECTA DESIGN TEAM

SIN 711.11

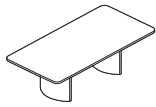

Tip: Shipped knocked down and top ships in one piece.

Tip: Grain direction for wood-grain laminate runs the length of the table.

Tip: Clips are provided with table: One clip per foot of table length.

Tip: The wood edge on a table top with woodgrain laminate may not match the top.

Tip: You must send a sample of reasonable size for Stain-to-Match.

Tip: 96" L tables available with zero, one, or two TAP(s). 10' L and 12' L tables available with zero, one, two, or three TAP(s).

Tip: In addition to the data and audio/video AAPs available from Coalesse, other styles of AAPs are available through Extron Electronics. For an Extron dealer, call 1.800.633.9876.

Tip: See TAP options for electrical systems and faceplate list.

Veneer direction



Standard Includes		Required to Specify	
<ul style="list-style-type: none"> ▶ Need help? Product details, see <i>Coalesse Tables, Storage, and Accessories Specification Guide</i> 	<ul style="list-style-type: none"> • Top: 1¼" particle board core with laminate • TAP(s) or storage tray, if selected: 10"W x 12"L opening(s) trimmed with a flat solid wood profile and with brushed anodized aluminum doors • Tech corridor: two aluminum beams for top support provide tracks for hinged aluminum doors that clip shut: satin anodized finish • Universal clip: black plastic • Two 27"W bases: wood veneer on MDF with aluminum universal bracket • Concealed leveling glides: non-marring, black plastic 	<ol style="list-style-type: none"> 1 Style number 2 Base selection (see below) and wood color number for base 3 Laminate color number for table top, if selected 4 Wood color number for wood edge ▶ See <i>Hardwood and Veneer Matrix</i>, page 364 5 Door color number for storage tray or TAP doors, if selected: <ul style="list-style-type: none"> - 8044 Black - 8047 Silver 6 Options, if selected (see below) ▶ See <i>Surface Materials</i>, page 350. 	
Options		Price	Required to Specify
Surface Materials	Top		
	<ul style="list-style-type: none"> • Grade 2 laminate • Grade 1 wood veneer • Grade 2 wood veneer • Stain-to-Match 	<p>Prices at right</p> <p>Prices at right</p> <p>Prices at right</p> <p>No cost</p>	<p>Specify with <i>Grade 2 laminate</i> and select color number.</p> <p>Specify with <i>Grade 1 wood veneer</i> and select color number.</p> <p>Specify with <i>Grade 2 wood veneer</i> and select color number.</p> <p>Specify with <i>Stain-to-Match</i>.</p> <p>▶ Page 385</p>
Edges	Wood		
	<ul style="list-style-type: none"> • Bullnose wood edge • Beveled wood edge • Tapered wood edge • Horizon wood edge 	<p>Prices at right</p> <p>Prices at right</p> <p>Prices at right</p> <p>Prices at right</p>	<p>Specify with <i>bullnose wood edge</i>.</p> <p>Specify with <i>beveled wood edge</i>.</p> <p>Specify with <i>tapered wood edge</i>.</p> <p>Specify with <i>Horizon wood edge</i>.</p>
Bases			
<p>Slim Flared</p>	<ul style="list-style-type: none"> • Two slim bases • One slim and one flared base • Two flared bases 	<p>No cost</p> <p>+\$ 827</p> <p>+\$1656</p>	<p>Specify with <i>two slim bases</i>.</p> <p>Specify with <i>one slim base</i> and one flared base.</p> <p>Specify with <i>two flared bases</i>.</p>
TAP Electrical System with Faceplate Options			
	<ul style="list-style-type: none"> • Field-wired tray (no electrical) <ul style="list-style-type: none"> - PAFW field-wired tray (no electrical) with blank AAPs - PDFW field-wired tray (no electrical) with two data AAPs - PVFW field-wired tray (no electrical) with two of each video/audio and data AAPs • Cord and plug tray (10' cord) <ul style="list-style-type: none"> - PACP cord and plug tray with outlets and blank AAPs - PDCP cord and plug tray with outlets and two data AAPs - PAVC cord and plug tray with outlets and two of each video/audio and data AAPs • Hard-wired tray (6' conduit) <ul style="list-style-type: none"> - PAHW hard-wired tray with outlets and blank AAPs - PDHW hard-wired tray with outlets and two data AAPs - PAVH hard-wired tray with outlets and two of each video/audio and data AAPs 	<p>No cost</p> <p>No cost</p> <p>No cost</p>	<p>Specify with <i>power data</i>, and select TAP type and TAP door color number.</p> <p>Specify with <i>power data</i>, and select TAP type and TAP door color number.</p> <p>Specify with <i>power data</i>, and select TAP type and TAP door color number.</p>
<p>Field Wired</p>			
<p>Cord and Plug</p>			
<p>Hardwired</p>			
▶ Options, continued on next page			

Host Collection

Rectangular Tables with Two Bases
DESIGN F/P DESIGN AND VECTA DESIGN TEAM

SIN 711.11

Tip: For single TAP style numbers, the modular system tray is not available. Specify the hardwired tray option.

Tip: If the specified table has multiple TAPs, any one TAP can be replaced with a storage tray.

Tip: Wood veneer doors for storage tray and TAP will always be cross grain.

Tip: Connectrac must be the same wiring schematic as the table.

►Options, continued from previous page

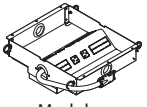
Options	Price	Required to Specify
TAP Electrical System with Faceplate Options  Modular	<ul style="list-style-type: none"> Modular system tray (hardwire base power infeed) PAMH modular system tray with outlets and blank AAPs PDMH modular system tray with outlets and two data AAPs PVMH modular system tray with outlets and two of each video/audio and data AAPs 	+\$141 each tray Specify with <i>modular power data</i> , and select TAP type and TAP door color number.
Storage Tray	<ul style="list-style-type: none"> Storage tray 	-\$593 Specify with <i>storage tray</i> and select door color number.
Doors	<ul style="list-style-type: none"> Storage tray wood veneer doors TAP wood veneer doors 	+\$298 per door +\$298 per door Specify with <i>wood doors</i> . Specify with <i>wood doors</i> .
Related Products	<ul style="list-style-type: none"> Floor kit: Connectrac Corridor shelf 	► Page 283 ► Page 283

96"L x 48"W TAP Locations—One piece top

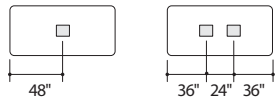

10"L x 48"W TAP Locations—One piece top

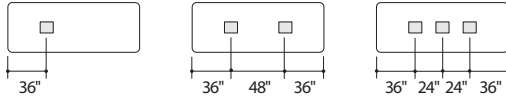

10"L x 48"W TAP Locations—Two piece top

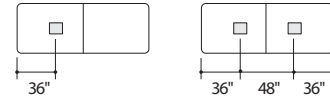

10"L x 60"W TAP Locations—One piece top

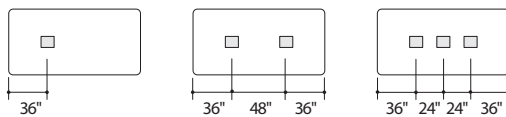

10"L x 60"W TAP Locations—Two piece top

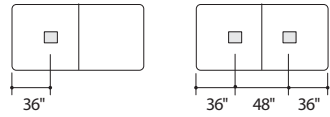

12"L x 48"W TAP Locations—One piece top

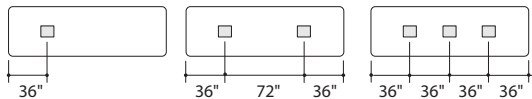

12"L x 48"W TAP Locations—Two piece top

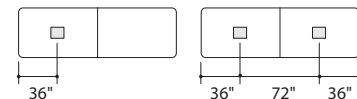

12"L x 60"W TAP Locations—One piece top

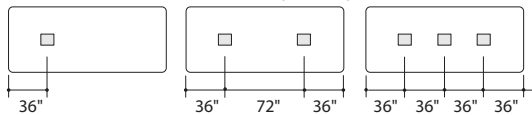

12"L x 60"W TAP Locations—Two piece top

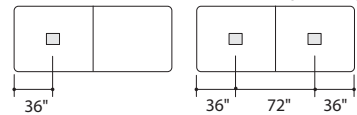

►Specification Information, on next page

Host Collection Rectangular Tables with Two Bases *continued*

DESIGN F/P DESIGN AND VECTA DESIGN TEAM





SIN 711.11

Tip: Prices shown include top, TAP(s), and slim bases.
 ▶ See base options for flared bases, page 166

Tip: Last digit of style number indicates number of TAP(s).

▶ Options, on previous page

Specification Information

Style Number	Finish	Base Prices			
					
		Flat Wood Edge:	Bullnose Wood Edge:	Beveled Wood Edge, Tapered Wood Edge:	Horizon Wood Edge:

96"L x 48"W One Piece Top

0 TAP

HS9648R10	Grade 1 Laminate	\$ 6753	\$ 6853	\$ 6991	\$ 8301
	Grade 2 Laminate	\$ 6871	\$ 6971	\$ 7109	\$ 8419
	Grade 1 Veneer	\$ 7261	\$ 7361	\$ 7499	\$ 8809
	Grade 2 Veneer	\$ 7864	\$ 7964	\$ 8102	\$ 9412

1 TAP

HS9648R11	Grade 1 Laminate	\$ 8338	\$ 8438	\$ 8576	\$ 9886
	Grade 2 Laminate	\$ 8456	\$ 8556	\$ 8694	\$10,004
	Grade 1 Veneer	\$ 8846	\$ 8946	\$ 9084	\$10,394
	Grade 2 Veneer	\$ 9449	\$ 9549	\$ 9687	\$10,997

2 TAPS

HS9648R12	Grade 1 Laminate	\$ 9925	\$10,025	\$10,163	\$11,473
	Grade 2 Laminate	\$10,043	\$10,143	\$10,281	\$11,591
	Grade 1 Veneer	\$10,433	\$10,533	\$10,671	\$11,981
	Grade 2 Veneer	\$11,036	\$11,136	\$11,274	\$12,584

10'L x 48"W One Piece Top

0 TAP

HS1048R10	Grade 1 Laminate	\$ 7285	\$ 7401	\$ 7562	\$ 8897
	Grade 2 Laminate	\$ 7435	\$ 7551	\$ 7712	\$ 9047
	Grade 1 Veneer	\$ 7904	\$ 8020	\$ 8181	\$ 9516
	Grade 2 Veneer	\$ 8657	\$ 8773	\$ 8934	\$10,269

1 TAP

HS1048R11	Grade 1 Laminate	\$ 8871	\$ 8987	\$ 9148	\$10,483
	Grade 2 Laminate	\$ 9021	\$ 9137	\$ 9298	\$10,633
	Grade 1 Veneer	\$ 9490	\$ 9606	\$ 9767	\$11,102
	Grade 2 Veneer	\$10,243	\$10,359	\$10,520	\$11,855

2 TAPS

HS1048R12	Grade 1 Laminate	\$10,458	\$10,574	\$10,735	\$12,070
	Grade 2 Laminate	\$10,608	\$10,724	\$10,885	\$12,220
	Grade 1 Veneer	\$11,077	\$11,193	\$11,354	\$12,689
	Grade 2 Veneer	\$11,830	\$11,946	\$12,107	\$13,442

▶ Specification Information, continued on next page

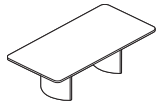

Tip: For tech corridor, 96"L tables have two long doors and four short doors.

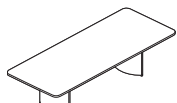
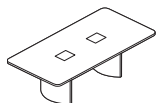
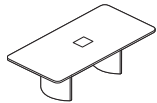

Tip: For tech corridor, 10'L tables have four long doors and four short doors.

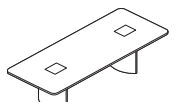
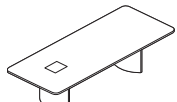

Host Collection

Rectangular Tables with Two Bases
DESIGN F/P DESIGN AND VECTA DESIGN TEAM





SIN 711.11

Tip: Prices shown include top, TAP(s), and slim bases.
▶ See base options for flared bases, page 166

Tip: Last digit of style number indicates number of TAP(s).

▶ Specification Information, continued from previous page

Specification Information

Style Number	Finish	Base Prices			
					
		Flat Wood Edge:	Bullnose Wood Edge:	Beveled Wood Edge, Tapered Wood Edge:	Horizon Wood Edge:

10'L x 48"W One Piece Top

3 TAPS

HS1048R13	Grade 1 Laminate	\$12,046	\$12,162	\$12,323	\$13,658
	Grade 2 Laminate	\$12,196	\$12,312	\$12,473	\$13,808
	Grade 1 Veneer	\$12,665	\$12,781	\$12,942	\$14,277
	Grade 2 Veneer	\$13,418	\$13,534	\$13,695	\$15,030

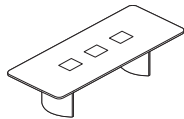

10'L x 48"W Two Piece Top

0 TAP

HS1048R20	Grade 1 Laminate	\$ 7665	\$ 7781	\$ 7942	\$ 9277
	Grade 2 Laminate	\$ 7815	\$ 7931	\$ 8092	\$ 9427
	Grade 1 Veneer	\$ 8284	\$ 8400	\$ 8561	\$ 9896
	Grade 2 Veneer	\$ 9037	\$ 9153	\$ 9314	\$10,649

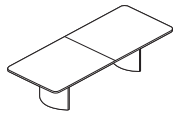

1 TAP

HS1048R21	Grade 1 Laminate	\$ 9251	\$ 9367	\$ 9528	\$10,863
	Grade 2 Laminate	\$ 9401	\$ 9517	\$ 9678	\$11,013
	Grade 1 Veneer	\$ 9870	\$ 9986	\$ 10,147	\$11,482
	Grade 2 Veneer	\$10,623	\$10,739	\$10,900	\$12,235

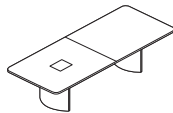

2 TAPS

HS1048R22	Grade 1 Laminate	\$10,838	\$10,954	\$11,115	\$12,450
	Grade 2 Laminate	\$10,988	\$11,104	\$11,265	\$12,600
	Grade 1 Veneer	\$11,457	\$11,573	\$11,734	\$13,069
	Grade 2 Veneer	\$12,210	\$12,326	\$12,487	\$13,822

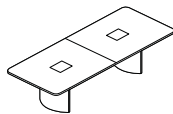

10'L x 60"W One Piece Top

0 TAP

HS1060R10	Grade 1 Laminate	\$ 7481	\$ 7605	\$ 7776	\$ 9126
	Grade 2 Laminate	\$ 7664	\$ 7788	\$ 7959	\$ 9309
	Grade 1 Veneer	\$ 8571	\$ 8695	\$ 8866	\$10,216
	Grade 2 Veneer	\$ 9525	\$ 9649	\$ 9820	\$11,170

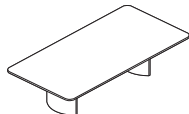

1 TAP

HS1060R11	Grade 1 Laminate	\$ 9069	\$ 9193	\$ 9364	\$10,714
	Grade 2 Laminate	\$ 9252	\$ 9376	\$ 9547	\$10,897
	Grade 1 Veneer	\$10,159	\$10,283	\$10,454	\$11,804
	Grade 2 Veneer	\$11,113	\$11,237	\$11,408	\$12,758

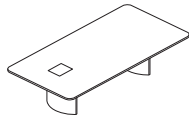

▶ Specification Information, continued on next page

Host Collection

Rectangular Tables with Two Bases *continued*
 DESIGN F/P DESIGN AND VECTA DESIGN TEAM





SIN 711.11

Tip: Prices shown include top, TAP(s), and slim bases.
 ▶ See base options for flared bases, page 166

Tip: Last digit of style number indicates number of TAP(s).

▶ Specification Information, continued from previous page

Specification Information

Style Number	Finish	Base Prices			
					
		Flat Wood Edge:	Bullnose Wood Edge:	Beveled Wood Edge, Tapered Wood Edge:	Horizon Wood Edge:

10'L x 60"W One Piece Top, continued

2 TAPS

HS1060R12	Grade 1 Laminate	\$10,656	\$10,780	\$10,951	\$12,301
	Grade 2 Laminate	\$10,839	\$10,963	\$11,134	\$12,484
	Grade 1 Veneer	\$11,746	\$11,870	\$12,041	\$13,391
	Grade 2 Veneer	\$12,700	\$12,824	\$12,995	\$14,345

3 TAPS

HS1060R13	Grade 1 Laminate	\$12,244	\$12,368	\$12,539	\$13,889
	Grade 2 Laminate	\$12,427	\$12,551	\$12,722	\$14,072
	Grade 1 Veneer	\$13,334	\$13,458	\$13,629	\$14,979
	Grade 2 Veneer	\$14,288	\$14,412	\$14,583	\$15,933

10'L x 60"W Two Piece Top

0 TAP

HS1060R20	Grade 1 Laminate	\$ 7862	\$ 7986	\$ 8157	\$ 9507
	Grade 2 Laminate	\$ 8045	\$ 8169	\$ 8340	\$ 9690
	Grade 1 Veneer	\$ 8952	\$ 9076	\$ 9247	\$10,597
	Grade 2 Veneer	\$ 9906	\$10,030	\$10,201	\$11,551

1 TAP

HS1060R21	Grade 1 Laminate	\$ 9449	\$ 9573	\$ 9744	\$11,094
	Grade 2 Laminate	\$ 9632	\$ 9756	\$ 9927	\$11,277
	Grade 1 Veneer	\$10,539	\$10,663	\$10,834	\$12,184
	Grade 2 Veneer	\$11,493	\$11,617	\$11,788	\$13,138

2 TAPS

HS1060R22	Grade 1 Laminate	\$11,037	\$11,161	\$11,332	\$12,682
	Grade 2 Laminate	\$11,220	\$11,344	\$11,515	\$12,865
	Grade 1 Veneer	\$12,127	\$12,251	\$12,422	\$13,772
	Grade 2 Veneer	\$13,081	\$13,205	\$13,376	\$14,726

▶ Specification Information, continued on next page

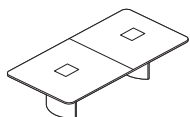
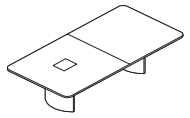
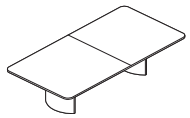
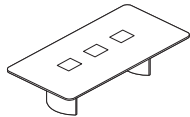
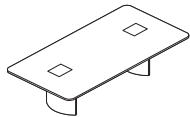

Host Collection

Rectangular Tables with Two Bases
DESIGN F/P DESIGN AND VECTA DESIGN TEAM





SIN 711.11

Tip: Prices shown include top, TAP(s), and slim bases.
► See base options for flared bases, page 166

Tip: Last digit of style number indicates number of TAP(s).

► Specification Information, continued from previous page

Specification Information

Style Number	Finish	Base Prices			
					
		Flat Wood Edge:	Bullnose Wood Edge:	Beveled Wood Edge, Tapered Wood Edge:	Horizon Wood Edge:

12'L x 48"W One Piece Top

0 TAP

HS1248R10	Grade 1 Laminate	\$ 7759	\$ 7890	\$ 8073	\$ 9435
	Grade 2 Laminate	\$ 7936	\$ 8067	\$ 8250	\$ 9612
	Grade 1 Veneer	\$ 8576	\$ 8707	\$ 8890	\$10,252
	Grade 2 Veneer	\$ 9486	\$ 9617	\$ 9800	\$11,162

1 TAP

HS1248R11	Grade 1 Laminate	\$ 9346	\$ 9477	\$ 9660	\$11,022
	Grade 2 Laminate	\$ 9523	\$ 9654	\$ 9837	\$11,199
	Grade 1 Veneer	\$10,163	\$10,294	\$10,477	\$11,839
	Grade 2 Veneer	\$11,073	\$11,204	\$11,387	\$12,749

2 TAPS

HS1248R12	Grade 1 Laminate	\$10,932	\$11,063	\$11,246	\$12,608
	Grade 2 Laminate	\$11,109	\$11,240	\$11,423	\$12,785
	Grade 1 Veneer	\$11,749	\$11,880	\$12,063	\$13,425
	Grade 2 Veneer	\$12,659	\$12,790	\$12,973	\$14,335

3 TAPS

HS1248R13	Grade 1 Laminate	\$12,521	\$12,652	\$12,835	\$14,197
	Grade 2 Laminate	\$12,698	\$12,829	\$13,012	\$14,374
	Grade 1 Veneer	\$13,338	\$13,469	\$13,652	\$15,014
	Grade 2 Veneer	\$14,248	\$14,379	\$14,562	\$15,924

► Specification Information, continued on next page

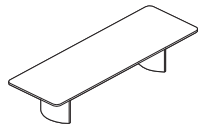

Tip: For tech corridor, 12'L tables have four long doors and four short doors.

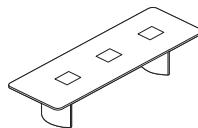
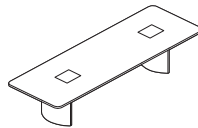
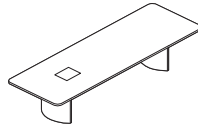

Host Collection

Rectangular Tables with Two Bases *continued*
 DESIGN F/P DESIGN AND VECTA DESIGN TEAM





SIN 711.11

Tip: Prices shown include top, TAP(s), and slim bases.
 ▶ See base options for flared bases, page 166

Tip: Last digit of style number indicates number of TAP(s).

▶ Specification Information, continued from previous page

Specification Information

Style Number	Finish	Base Prices			
					
		Flat Wood Edge:	Bullnose Wood Edge:	Beveled Wood Edge, Tapered Wood Edge:	Horizon Wood Edge:

12'L x 48"W Two Piece Top

0 TAP

HS1248R20	Grade 1 Laminate	\$ 8137	\$ 8268	\$ 8451	\$ 9813
	Grade 2 Laminate	\$ 8314	\$ 8445	\$ 8628	\$ 9990
	Grade 1 Veneer	\$ 8954	\$ 9085	\$ 9268	\$10,630
	Grade 2 Veneer	\$ 9864	\$ 9995	\$10,178	\$11,540

1 TAP

HS1248R21	Grade 1 Laminate	\$ 9727	\$ 9858	\$10,041	\$ 11,403
	Grade 2 Laminate	\$ 9904	\$10,035	\$10,218	\$11,580
	Grade 1 Veneer	\$10,544	\$10,675	\$10,858	\$12,220
	Grade 2 Veneer	\$11,454	\$11,585	\$11,768	\$13,130

2 TAPS

HS1248R22	Grade 1 Laminate	\$11,313	\$11,444	\$11,627	\$12,989
	Grade 2 Laminate	\$11,490	\$11,621	\$11,804	\$13,166
	Grade 1 Veneer	\$12,130	\$12,261	\$12,444	\$13,806
	Grade 2 Veneer	\$13,040	\$13,171	\$13,354	\$14,716

12'L x 60"W One Piece Top

0 TAP

HS1260R10	Grade 1 Laminate	\$ 7965	\$ 8103	\$ 8299	\$ 9673
	Grade 2 Laminate	\$ 8186	\$ 8324	\$ 8520	\$ 9894
	Grade 1 Veneer	\$ 9305	\$ 9443	\$ 9639	\$11,013
	Grade 2 Veneer	\$10,450	\$10,588	\$10,784	\$12,158

1 TAP

HS1260R11	Grade 1 Laminate	\$ 9554	\$ 9692	\$ 9888	\$11,262
	Grade 2 Laminate	\$ 9775	\$ 9913	\$10,109	\$11,483
	Grade 1 Veneer	\$10,894	\$11,032	\$11,228	\$12,602
	Grade 2 Veneer	\$12,039	\$12,177	\$12,373	\$13,747

2 TAPS

HS1260R12	Grade 1 Laminate	\$11,140	\$11,278	\$11,474	\$12,848
	Grade 2 Laminate	\$11,361	\$11,499	\$11,695	\$13,069
	Grade 1 Veneer	\$12,480	\$12,618	\$12,814	\$14,188
	Grade 2 Veneer	\$13,625	\$13,763	\$13,959	\$15,333

▶ Specification Information, continued on next page

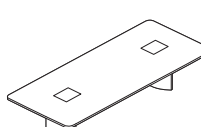
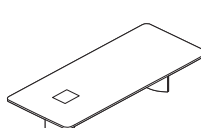
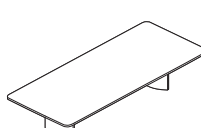
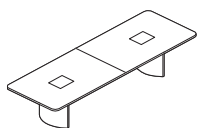
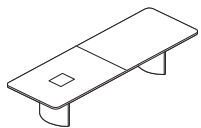
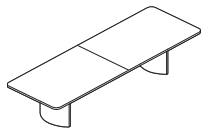

Host Collection

Rectangular Tables with Two Bases
DESIGN F/P DESIGN AND VECTA DESIGN TEAM





SIN 711.11

Tip: Prices shown include top, TAP(s), and slim bases.
▶ See base options for flared bases, page 166

Tip: Last digit of style number indicates number of TAP(s).

▶ Specification Information, continued from previous page

Specification Information

Style Number	Finish	Base Prices			
					
		Flat Wood Edge:	Bullnose Wood Edge:	Beveled Wood Edge, Tapered Wood Edge:	Horizon Wood Edge:

12'L x 60"W One Piece Top, continued

3 TAPS

HS1260R13	Grade 1 Laminate	\$12,727	\$12,865	\$13,061	\$14,435
	Grade 2 Laminate	\$12,948	\$13,086	\$13,282	\$14,656
	Grade 1 Veneer	\$14,067	\$14,205	\$14,401	\$15,775
	Grade 2 Veneer	\$15,212	\$15,350	\$15,546	\$16,920

12'L x 60"W Two Piece Top

0 TAP

HS1260R20	Grade 1 Laminate	\$ 8344	\$ 8482	\$ 8678	\$10,052
	Grade 2 Laminate	\$ 8565	\$ 8703	\$ 8899	\$10,273
	Grade 1 Veneer	\$ 9684	\$ 9822	\$10,018	\$11,392
	Grade 2 Veneer	\$10,829	\$10,967	\$11,163	\$12,537

1 TAP

HS1260R21	Grade 1 Laminate	\$ 9932	\$10,070	\$10,266	\$11,640
	Grade 2 Laminate	\$10,153	\$10,291	\$10,487	\$11,861
	Grade 1 Veneer	\$11,272	\$11,410	\$11,606	\$12,980
	Grade 2 Veneer	\$12,417	\$12,555	\$12,751	\$14,125

2 TAPS

HS1260R22	Grade 1 Laminate	\$11,520	\$11,658	\$11,854	\$13,228
	Grade 2 Laminate	\$11,741	\$11,879	\$12,075	\$13,449
	Grade 1 Veneer	\$12,860	\$12,998	\$13,194	\$14,568
	Grade 2 Veneer	\$14,005	\$14,143	\$14,339	\$15,713

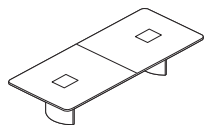
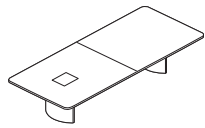
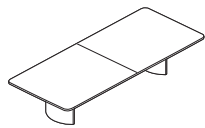
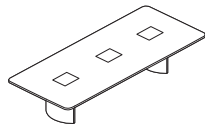

Host Collection Rectangular Tables with Three Bases

DESIGN F/P DESIGN AND VECTA DESIGN TEAM

SIN 711.11

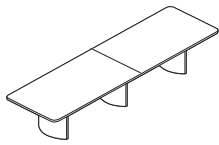

Tip: Shipped knocked down and top ships in one piece.

Tip: Grain direction for wood-grain laminate runs the length of the table.

Tip: Clips are provided with table: One clip per foot of table length.

Tip: The wood edge on a table top with woodgrain laminate may not match the top.

Tip: You must send a sample of reasonable size for Stain-to-Match.

Tip: 14'L and 16'L tables available with zero, one, two, or four TAP(s). 18'L and 20'L tables available with zero, one, two, four, or six TAP(s).

Tip: In addition to the data and audio/video AAPs available from Coalesse, other styles of AAPs are available through Extron Electronics. For an Extron dealer, call 1.800.633.9876.

Tip: See TAP options for electrical systems and faceplate list.

Veneer direction



Standard Includes	Required to Specify
<ul style="list-style-type: none"> ▶ Need help? Product details, see <i>Coalesse Tables, Storage, and Accessories Specification Guide</i> • Top: 1¼" particle board core with laminate • Flat wood edge • TAP(s), if selected: 10"W x 12"L opening(s) trimmed with a flat solid wood profile and with brushed anodized aluminum TAP doors • Tech corridor: four aluminum beams for top support provide tracks for hinged aluminum doors that clip shut: satin anodized finish • Universal clip: black plastic • Three 27"W bases: wood veneer on MDF with aluminum universal bracket • Concealed leveling glides: non-marring, black plastic 	<ol style="list-style-type: none"> 1 Style number 2 Base selection (see below) and wood color number for base 3 Laminate color number for table top, if selected 4 Wood color number for wood edge ▶ See <i>Hardwood and Veneer Matrix</i>, page 364 5 Door color number for storage tray or TAP door, if selected: <ul style="list-style-type: none"> - 8044 Black - 8047 Silver 6 Options, if selected (see below) ▶ See <i>Surface Materials</i>, page 350.

Options	Price	Required to Specify
Surface Materials <ul style="list-style-type: none"> • Top • Grade 2 laminate • Grade 1 wood veneer • Grade 2 wood veneer • Stain-to-Match 	<ul style="list-style-type: none"> Prices at right Prices at right Prices at right No cost 	<ul style="list-style-type: none"> Specify with <i>Grade 2 laminate</i> and select color number. Specify with <i>Grade 1 wood veneer</i> and select color number. Specify with <i>Grade 2 wood veneer</i> and select color number. Specify with <i>Stain-to-Match</i>. ▶ Page 385
Edges <ul style="list-style-type: none"> • Wood • Bullnose wood edge • Beveled wood edge • Tapered wood edge • Horizon wood edge 	<ul style="list-style-type: none"> Prices at right Prices at right Prices at right Prices at right 	<ul style="list-style-type: none"> Specify with <i>bullnose wood edge</i>. Specify with <i>beveled wood edge</i>. Specify with <i>tapered wood edge</i>. Specify with <i>Horizon wood edge</i>.
Bases <ul style="list-style-type: none"> • Three slim bases • Two slim and one flared bases • One slim and two flared bases • Three flared bases 	<ul style="list-style-type: none"> No cost +\$ 827 +\$1656 +\$2481 	<ul style="list-style-type: none"> Specify with <i>three slim bases</i>. Specify with <i>two slim and one flared bases</i>. Specify with <i>one slim and two flared bases</i>. Specify with <i>three flared bases</i>.

TAP Electrical System with Faceplate Options <ul style="list-style-type: none"> • Field-wired tray (no electrical) - PAFW field-wired tray (no electrical) with blank AAPs - PDFW field-wired tray (no electrical) with two data AAPs - PVFW field-wired tray (no electrical) with two of each video/audio and data AAPs • Cord and plug tray (10' cord) - PACP cord and plug tray with outlets and blank AAPs - PDCP cord and plug tray with outlets and two data AAPs - PAVC cord and plug tray with outlets and two of each video/audio and data AAPs • Hard-wired tray (6' conduit) - PAHW hard-wired tray with outlets and blank AAPs - PDHW hard-wired tray with outlets and two data AAPs - PAVH hard-wired tray with outlets and two of each video/audio and data AAPs 	<ul style="list-style-type: none"> No cost No cost No cost No cost 	<ul style="list-style-type: none"> Specify with <i>power data</i>, and select TAP type and TAP door color number. Specify with <i>power data</i>, and select TAP type and TAP door color number. Specify with <i>power data</i>, and select TAP type and TAP door color number.
--	--	--

▶ Options, continued on next page

Host Collection Rectangular Tables with Three Bases

DESIGN F/P DESIGN AND VECTA DESIGN TEAM

SIN 711.11

Tip: For single TAP style numbers, the modular system tray is not available. Specify the hard-wired tray option.

Tip: If the specified table has multiple TAP(s), any one TAP can be replaced with a storage tray.

Tip: Wood veneer doors for storage tray and TAP will always be cross grain.

Tip: Connectrac must be the same wiring schematic as the table.

►Options, continued from previous page

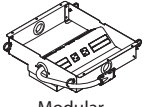
Options	Price	Required to Specify
TAP Electrical System with Faceplate Options  Modular	<ul style="list-style-type: none"> Modular system tray (hardwire base power infeed) - PAMH modular system tray with outlets and blank AAPs - PDMH modular system tray with outlets and two data AAPs - PVMH modular system tray with outlets and two of each video/audio and data AAPs 	+\$141 each tray Specify with <i>modular power data</i> , and select TAP type and TAP door color number.
Storage Tray	<ul style="list-style-type: none"> Storage tray 	-\$593 Specify with <i>storage tray</i> and select door color number.
Doors	<ul style="list-style-type: none"> Storage tray wood veneer doors TAP wood veneer doors 	+\$298 per door +\$298 per door Specify with <i>wood doors</i> . Specify with <i>wood doors</i> .
Related Products	<ul style="list-style-type: none"> Floor kit: Connectrac Corridor shelf 	► Page 283 ► Page 283

TAP Locations

14'L x 48"W TAP Locations—Two piece top

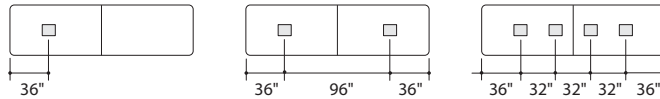

14'L x 48"W TAP Locations—Three piece top

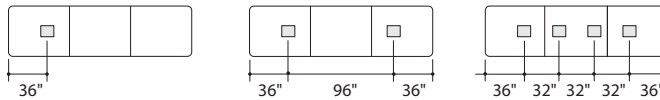

14'L x 60"W TAP Locations—Two piece top

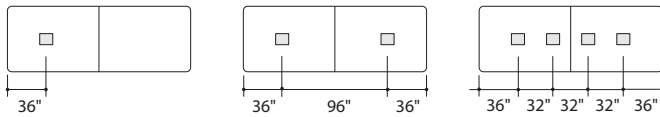

14'L x 60"W TAP Locations—Three piece top

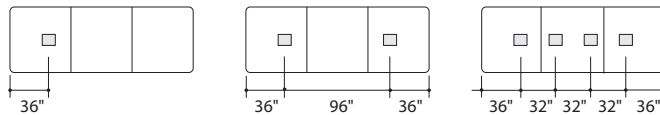

►Options, continued on next page

Host Collection Rectangular Tables with Three Bases *continued*

DESIGN F/P DESIGN AND VECTA DESIGN TEAM

SIN 711.11

►Options, continued from previous page

TAP Locations

16'L x 48"W TAP Locations—Two piece top

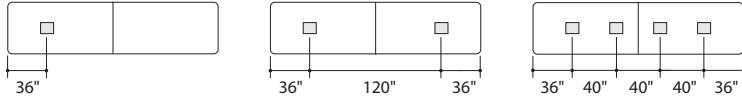

16'L x 48"W TAP Locations—Three piece top

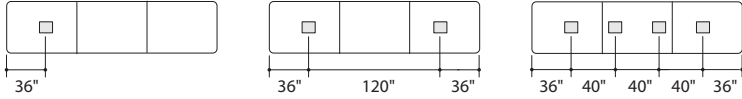

16'L x 60"W TAP Locations—Two piece top

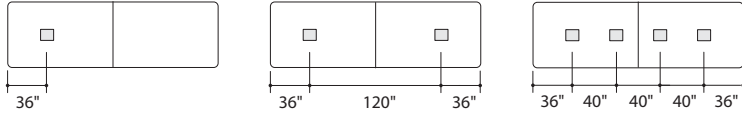

16'L x 60"W TAP Locations—Three piece top

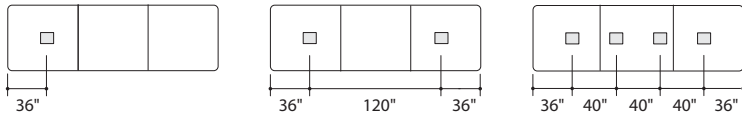

18'L x 48"W TAP Locations—Two piece top

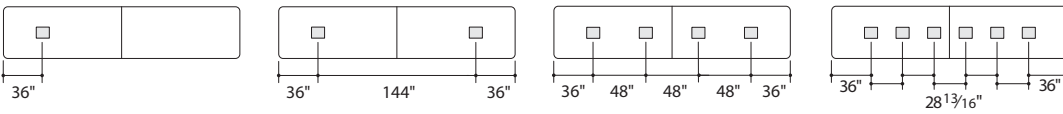

18'L x 48"W TAP Locations—Three piece top

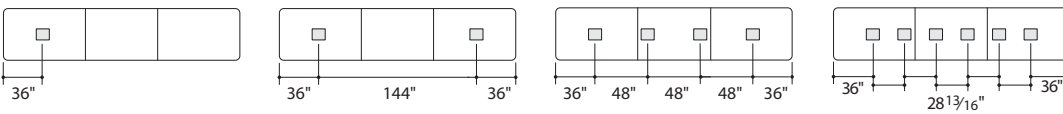

18'L x 60"W TAP Locations—Two piece top

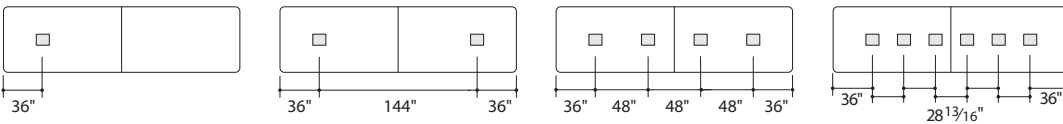

18'L x 60"W TAP Locations—Three piece top

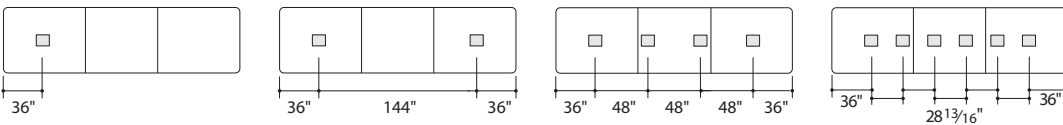

►Options, continued on next page

Host Collection

Rectangular Tables with Three Bases
DESIGN F/P DESIGN AND VECTA DESIGN TEAM

SIN 711.11

►Options, continued from previous page

TAP Locations

20'L x 48"W TAP Locations—Two piece top

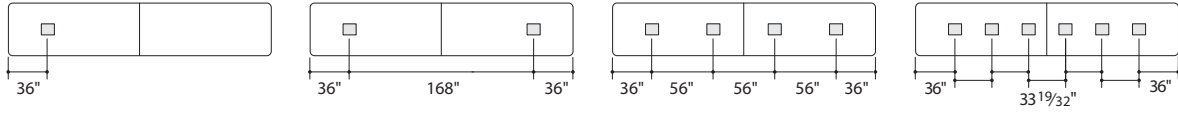

20'L x 48"W TAP Locations—Three piece top

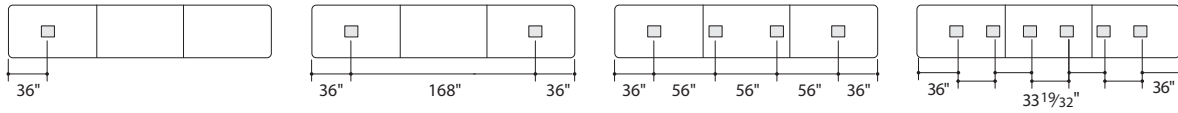

20'L x 60"W TAP Locations—Two piece top

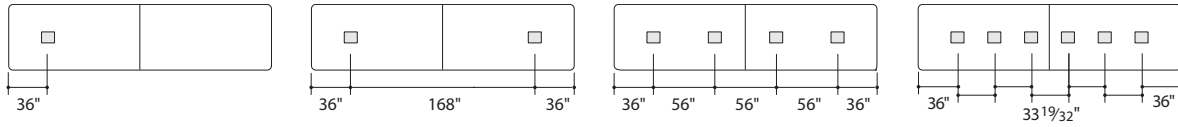

20'L x 60"W TAP Locations—Three piece top

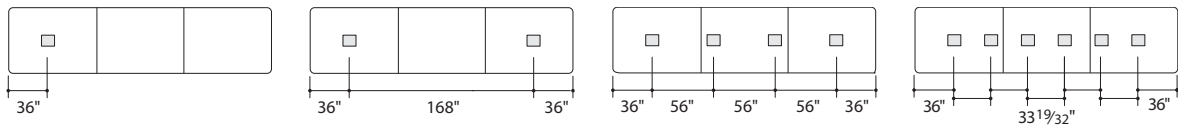

►Specification Information, on next page

Host Collection

Rectangular Tables with Three Bases *continued*
 DESIGN F/P DESIGN AND VECTA DESIGN TEAM

SIN 711.11

Tip: Prices shown include top, TAP(s), and slim bases.
 ▶ See base options for flared bases, page 174



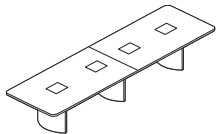
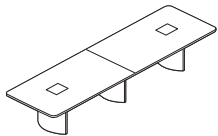
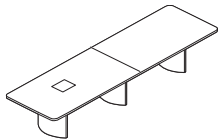
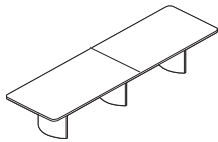

Tip: Last digit of style number indicates number of TAP(s).

Tip: For tech corridor, 14'L tables have four long doors and four short doors.



▶ Options, on previous page

Specification Information

Style Number	Finish	Base Prices			
					
		Flat Wood Edge:	Bullnose Wood Edge:	Beveled Wood Edge, Tapered Wood Edge:	Horizon Wood Edge:

14'L x 48"W Two Piece Top

0 TAP

Style Number	Finish	Flat Wood Edge	Bullnose Wood Edge	Beveled Wood Edge, Tapered Wood Edge	Horizon Wood Edge
HS1448R20	Grade 1 Laminate	\$10,539	\$10,689	\$10,891	\$12,278
	Grade 2 Laminate	\$10,747	\$10,897	\$11,099	\$12,486
	Grade 1 Veneer	\$11,688	\$11,838	\$12,040	\$13,427
	Grade 2 Veneer	\$12,754	\$12,904	\$13,106	\$14,493

1 TAP

Style Number	Finish	Flat Wood Edge	Bullnose Wood Edge	Beveled Wood Edge, Tapered Wood Edge	Horizon Wood Edge
HS1448R21	Grade 1 Laminate	\$12,126	\$12,276	\$12,478	\$13,865
	Grade 2 Laminate	\$12,334	\$12,484	\$12,686	\$14,073
	Grade 1 Veneer	\$13,275	\$13,425	\$13,627	\$15,014
	Grade 2 Veneer	\$14,341	\$14,491	\$14,693	\$16,080

2 TAPS

Style Number	Finish	Flat Wood Edge	Bullnose Wood Edge	Beveled Wood Edge, Tapered Wood Edge	Horizon Wood Edge
HS1448R22	Grade 1 Laminate	\$13,714	\$13,864	\$14,066	\$15,453
	Grade 2 Laminate	\$13,922	\$14,072	\$14,274	\$15,661
	Grade 1 Veneer	\$14,863	\$15,013	\$15,215	\$16,602
	Grade 2 Veneer	\$15,929	\$16,079	\$16,281	\$17,668

4 TAPS

Style Number	Finish	Flat Wood Edge	Bullnose Wood Edge	Beveled Wood Edge, Tapered Wood Edge	Horizon Wood Edge
HS1448R24	Grade 1 Laminate	\$16,887	\$17,037	\$17,239	\$18,626
	Grade 2 Laminate	\$17,095	\$17,245	\$17,447	\$18,834
	Grade 1 Veneer	\$18,036	\$18,186	\$18,388	\$19,775
	Grade 2 Veneer	\$19,102	\$19,252	\$19,454	\$20,841

▶ Specification Information, continued on next page

Host Collection

Rectangular Tables with Three Bases
DESIGN F/P DESIGN AND VECTA DESIGN TEAM

SIN 711.11

Tip: Prices shown include top, TAP(s), and slim bases.
▶ See base options for flared bases, page 174



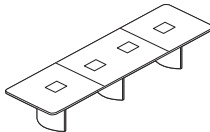
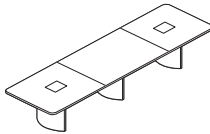
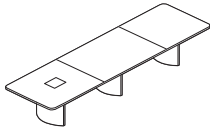
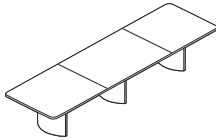

Tip: Last digit of style number indicates number of TAP(s).

Tip: For tech corridor, 14'L tables have four long doors and four short doors.



▶ Specification Information, continued from previous page

Specification Information

Style Number	Finish	Base Prices			
					
		Flat Wood Edge:	Bullnose Wood Edge:	Beveled Wood Edge, Tapered Wood Edge:	Horizon Wood Edge:

14'L x 48''W Three Piece Top

0 TAP

Style Number	Finish	Flat Wood Edge	Bullnose Wood Edge	Beveled Wood Edge, Tapered Wood Edge	Horizon Wood Edge
HS1448R30	Grade 1 Laminate	\$10,919	\$11,069	\$11,271	\$12,658
	Grade 2 Laminate	\$11,127	\$11,277	\$11,479	\$12,866
	Grade 1 Veneer	\$12,068	\$12,218	\$12,420	\$13,807
	Grade 2 Veneer	\$13,134	\$13,284	\$13,486	\$14,873

1 TAP

Style Number	Finish	Flat Wood Edge	Bullnose Wood Edge	Beveled Wood Edge, Tapered Wood Edge	Horizon Wood Edge
HS1448R31	Grade 1 Laminate	\$12,507	\$12,657	\$12,859	\$14,246
	Grade 2 Laminate	\$12,715	\$12,865	\$13,067	\$14,454
	Grade 1 Veneer	\$13,656	\$13,806	\$14,008	\$15,395
	Grade 2 Veneer	\$14,722	\$14,872	\$15,074	\$16,461

2 TAPS

Style Number	Finish	Flat Wood Edge	Bullnose Wood Edge	Beveled Wood Edge, Tapered Wood Edge	Horizon Wood Edge
HS1448R32	Grade 1 Laminate	\$14,095	\$14,245	\$14,447	\$15,834
	Grade 2 Laminate	\$14,303	\$14,453	\$14,655	\$16,042
	Grade 1 Veneer	\$15,244	\$15,394	\$15,596	\$16,983
	Grade 2 Veneer	\$16,310	\$16,460	\$16,662	\$18,049

4 TAPS

Style Number	Finish	Flat Wood Edge	Bullnose Wood Edge	Beveled Wood Edge, Tapered Wood Edge	Horizon Wood Edge
HS1448R34	Grade 1 Laminate	\$17,269	\$17,419	\$17,621	\$19,008
	Grade 2 Laminate	\$17,477	\$17,627	\$17,829	\$19,216
	Grade 1 Veneer	\$18,418	\$18,568	\$18,770	\$20,157
	Grade 2 Veneer	\$19,484	\$19,634	\$19,836	\$21,223

▶ Specification Information, continued on next page

Host Collection

Rectangular Tables with Three Bases *continued*
 DESIGN F/P DESIGN AND VECTA DESIGN TEAM

SIN 711.11

Tip: Prices shown include top, TAP(s), and slim bases.
 ▶ See base options for flared bases, page 174

Tip: Last digit of style number indicates number of TAP(s).

Tip: For tech corridor, 14'L tables have four long doors and four short doors.

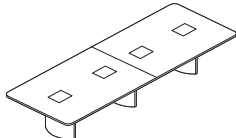
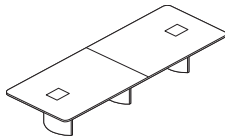
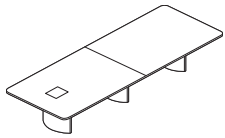
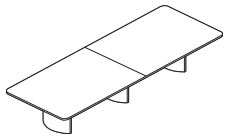

▶ Specification Information, continued from previous page

Specification Information

Style Number	Finish	Base Prices			
		Flat Wood Edge:	Bullnose Wood Edge:	Beveled Wood Edge, Tapered Wood Edge:	Horizon Wood Edge:

14'L x 60"W Two Piece Top

0 TAP

Style Number	Finish	Flat Wood Edge	Bullnose Wood Edge	Beveled Wood Edge, Tapered Wood Edge	Horizon Wood Edge
HS1460R20	Grade 1 Laminate	\$11,008	\$11,164	\$11,380	\$12,780
	Grade 2 Laminate	\$11,268	\$11,424	\$11,640	\$13,040
	Grade 1 Veneer	\$13,121	\$13,277	\$13,493	\$14,893
	Grade 2 Veneer	\$14,474	\$14,630	\$14,846	\$16,246

1 TAP

Style Number	Finish	Flat Wood Edge	Bullnose Wood Edge	Beveled Wood Edge, Tapered Wood Edge	Horizon Wood Edge
HS1460R21	Grade 1 Laminate	\$12,596	\$12,752	\$12,968	\$14,368
	Grade 2 Laminate	\$12,856	\$13,012	\$13,228	\$14,628
	Grade 1 Veneer	\$14,709	\$14,865	\$15,081	\$16,481
	Grade 2 Veneer	\$16,062	\$16,218	\$16,434	\$17,834

2 TAPS

Style Number	Finish	Flat Wood Edge	Bullnose Wood Edge	Beveled Wood Edge, Tapered Wood Edge	Horizon Wood Edge
HS1460R22	Grade 1 Laminate	\$14,182	\$14,338	\$14,554	\$15,954
	Grade 2 Laminate	\$14,442	\$14,598	\$14,814	\$16,214
	Grade 1 Veneer	\$16,295	\$16,451	\$16,667	\$18,067
	Grade 2 Veneer	\$17,648	\$17,804	\$18,020	\$19,420

4 TAPS

Style Number	Finish	Flat Wood Edge	Bullnose Wood Edge	Beveled Wood Edge, Tapered Wood Edge	Horizon Wood Edge
HS1460R24	Grade 1 Laminate	\$17,358	\$17,514	\$17,730	\$19,130
	Grade 2 Laminate	\$17,618	\$17,774	\$17,990	\$19,390
	Grade 1 Veneer	\$19,471	\$19,627	\$19,843	\$21,243
	Grade 2 Veneer	\$20,824	\$20,980	\$21,196	\$22,596

▶ Specification Information, continued on next page

Host Collection

Rectangular Tables with Three Bases
DESIGN F/P DESIGN AND VECTA DESIGN TEAM

SIN 711.11

Tip: Prices shown include top, TAP(s), and slim bases.
► See base options for flared bases, page 174



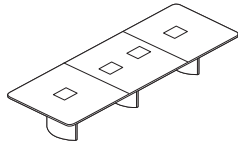
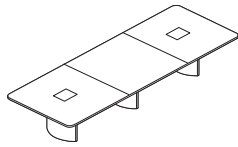
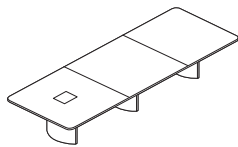
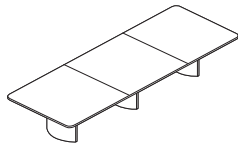

Tip: Last digit of style number indicates number of TAP(s).

Tip: For tech corridor, tables have four long doors and four short doors.



► Specification Information, continued from previous page

Specification Information

Style Number	Finish	Base Prices			
					
		Flat Wood Edge:	Bullnose Wood Edge:	Beveled Wood Edge, Tapered Wood Edge:	Horizon Wood Edge:

14'L x 60"W Three Piece Top

0 TAP

Style Number	Finish	Flat Wood Edge	Bullnose Wood Edge	Beveled Wood Edge, Tapered Wood Edge	Horizon Wood Edge
HS1460R30	Grade 1 Laminate	\$11,388	\$11,544	\$11,760	\$13,160
	Grade 2 Laminate	\$11,648	\$11,804	\$12,020	\$13,420
	Grade 1 Veneer	\$13,501	\$13,657	\$13,873	\$15,273
	Grade 2 Veneer	\$14,854	\$15,010	\$15,226	\$16,626

1 TAP

Style Number	Finish	Flat Wood Edge	Bullnose Wood Edge	Beveled Wood Edge, Tapered Wood Edge	Horizon Wood Edge
HS1460R31	Grade 1 Laminate	\$12,976	\$13,132	\$13,348	\$14,748
	Grade 2 Laminate	\$13,236	\$13,392	\$13,608	\$15,008
	Grade 1 Veneer	\$15,089	\$15,245	\$15,461	\$16,861
	Grade 2 Veneer	\$16,442	\$16,598	\$16,814	\$18,214

2 TAPS

Style Number	Finish	Flat Wood Edge	Bullnose Wood Edge	Beveled Wood Edge, Tapered Wood Edge	Horizon Wood Edge
HS1460R32	Grade 1 Laminate	\$14,563	\$14,719	\$14,935	\$16,335
	Grade 2 Laminate	\$14,823	\$14,979	\$15,195	\$16,595
	Grade 1 Veneer	\$16,676	\$16,832	\$17,048	\$18,448
	Grade 2 Veneer	\$18,029	\$18,185	\$18,401	\$19,801

4 TAPS

Style Number	Finish	Flat Wood Edge	Bullnose Wood Edge	Beveled Wood Edge, Tapered Wood Edge	Horizon Wood Edge
HS1460R34	Grade 1 Laminate	\$17,741	\$17,897	\$18,113	\$19,513
	Grade 2 Laminate	\$18,001	\$18,157	\$18,373	\$19,773
	Grade 1 Veneer	\$19,854	\$20,010	\$20,226	\$21,626
	Grade 2 Veneer	\$21,207	\$21,363	\$21,579	\$22,979

► Specification Information, continued on next page

Host Collection

Rectangular Tables with Three Bases *continued*
 DESIGN F/P DESIGN AND VECTA DESIGN TEAM

SIN 711.11

Tip: Prices shown include top, TAP(s), and slim bases.
 ▶ See base options for flared bases, page 174



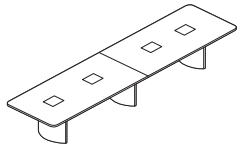
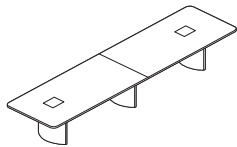
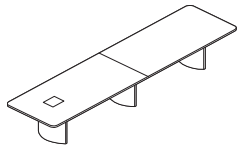
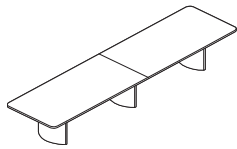

Tip: Last digit of style number indicates number of TAP(s).

Tip: For tech corridor, 16'L tables have eight long doors and four short doors.

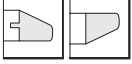

► Specification Information, continued from previous page

Specification Information

Style Number	Finish	Base Prices			
					
		Flat Wood Edge:	Bullnose Wood Edge:	Beveled Wood Edge, Tapered Wood Edge:	Horizon Wood Edge:

16'L x 48''W Two Piece Top

0 TAP

Style Number	Finish	Flat Wood Edge	Bullnose Wood Edge	Beveled Wood Edge, Tapered Wood Edge	Horizon Wood Edge
HS1648R20	Grade 1 Laminate	\$10,970	\$11,133	\$11,361	\$12,774
	Grade 2 Laminate	\$11,207	\$11,370	\$11,598	\$13,011
	Grade 1 Veneer	\$12,114	\$12,277	\$12,505	\$13,918
	Grade 2 Veneer	\$13,330	\$13,493	\$13,721	\$15,134

1 TAP

Style Number	Finish	Flat Wood Edge	Bullnose Wood Edge	Beveled Wood Edge, Tapered Wood Edge	Horizon Wood Edge
HS1648R21	Grade 1 Laminate	\$12,556	\$12,719	\$12,947	\$14,360
	Grade 2 Laminate	\$12,793	\$12,956	\$13,184	\$14,597
	Grade 1 Veneer	\$13,700	\$13,863	\$14,091	\$15,504
	Grade 2 Veneer	\$14,916	\$15,079	\$15,307	\$16,720

2 TAPS

Style Number	Finish	Flat Wood Edge	Bullnose Wood Edge	Beveled Wood Edge, Tapered Wood Edge	Horizon Wood Edge
HS1648R22	Grade 1 Laminate	\$14,144	\$14,307	\$14,535	\$15,948
	Grade 2 Laminate	\$14,381	\$14,544	\$14,772	\$16,185
	Grade 1 Veneer	\$15,288	\$15,451	\$15,679	\$17,092
	Grade 2 Veneer	\$16,504	\$16,667	\$16,895	\$18,308

4 TAPS

Style Number	Finish	Flat Wood Edge	Bullnose Wood Edge	Beveled Wood Edge, Tapered Wood Edge	Horizon Wood Edge
HS1648R24	Grade 1 Laminate	\$17,318	\$17,481	\$17,709	\$19,122
	Grade 2 Laminate	\$17,555	\$17,718	\$17,946	\$19,359
	Grade 1 Veneer	\$18,462	\$18,625	\$18,853	\$20,266
	Grade 2 Veneer	\$19,678	\$19,841	\$20,069	\$21,482

► Specification Information, continued on next page

Host Collection

Rectangular Tables with Three Bases
DESIGN F/P DESIGN AND VECTA DESIGN TEAM

SIN 711.11

Tip: Prices shown include top, TAP(s), and slim bases.
► See base options for flared bases, page 174



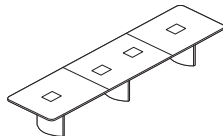
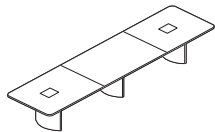
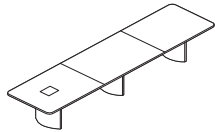
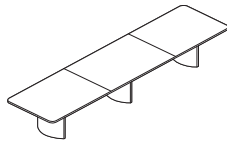

Tip: Last digit of style number indicates number of TAP(s).

Tip: For tech corridor, 16'L tables have eight long doors and four short doors.



► Specification Information, continued from previous page

Specification Information

Style Number	Finish	Base Prices			
					
		Flat Wood Edge:	Bullnose Wood Edge:	Beveled Wood Edge, Tapered Wood Edge:	Horizon Wood Edge:

16'L x 48''W Three Piece Top

0 TAP

Style Number	Finish	Flat Wood Edge	Bullnose Wood Edge	Beveled Wood Edge, Tapered Wood Edge	Horizon Wood Edge
HS1648R30	Grade 1 Laminate	\$11,351	\$11,514	\$11,742	\$13,155
	Grade 2 Laminate	\$11,588	\$11,751	\$11,979	\$13,392
	Grade 1 Veneer	\$12,495	\$12,658	\$12,886	\$14,299
	Grade 2 Veneer	\$13,711	\$13,874	\$14,102	\$15,515

1 TAP

Style Number	Finish	Flat Wood Edge	Bullnose Wood Edge	Beveled Wood Edge, Tapered Wood Edge	Horizon Wood Edge
HS1648R31	Grade 1 Laminate	\$12,938	\$13,101	\$13,329	\$14,742
	Grade 2 Laminate	\$13,175	\$13,338	\$13,566	\$14,979
	Grade 1 Veneer	\$14,082	\$14,245	\$14,473	\$15,886
	Grade 2 Veneer	\$15,298	\$15,461	\$15,689	\$17,102

2 TAPS

Style Number	Finish	Flat Wood Edge	Bullnose Wood Edge	Beveled Wood Edge, Tapered Wood Edge	Horizon Wood Edge
HS1648R32	Grade 1 Laminate	\$14,522	\$14,685	\$14,913	\$16,326
	Grade 2 Laminate	\$14,759	\$14,922	\$15,150	\$16,563
	Grade 1 Veneer	\$15,666	\$15,829	\$16,057	\$17,470
	Grade 2 Veneer	\$16,882	\$17,045	\$17,273	\$18,686

4 TAPS

Style Number	Finish	Flat Wood Edge	Bullnose Wood Edge	Beveled Wood Edge, Tapered Wood Edge	Horizon Wood Edge
HS1648R34	Grade 1 Laminate	\$17,698	\$17,861	\$18,089	\$19,502
	Grade 2 Laminate	\$17,935	\$18,098	\$18,326	\$19,739
	Grade 1 Veneer	\$18,842	\$19,005	\$19,233	\$20,646
	Grade 2 Veneer	\$20,058	\$20,221	\$20,449	\$21,862

► Specification Information, continued on next page

Host Collection

Rectangular Tables with Three Bases *continued*
 DESIGN F/P DESIGN AND VECTA DESIGN TEAM

SIN 711.11

Tip: Prices shown include top, TAP(s), and slim bases.
 ▶ See base options for flared bases, page 174

Tip: Last digit of style number indicates number of TAP(s).

Tip: For tech corridor, 16'L tables have eight long doors and four short doors.

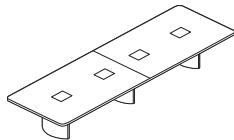
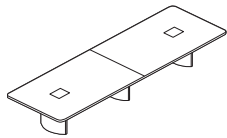
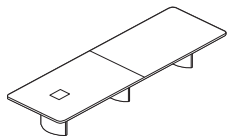
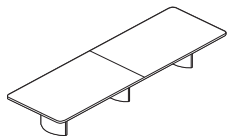

▶ Specification Information, continued from previous page

Specification Information

Style Number	Finish	Base Prices			
		Flat Wood Edge:	Bullnose Wood Edge:	Beveled Wood Edge, Tapered Wood Edge:	Horizon Wood Edge:

16'L x 60"W Two Piece Top

0 TAP

Style Number	Finish	Flat Wood Edge	Bullnose Wood Edge	Beveled Wood Edge, Tapered Wood Edge	Horizon Wood Edge
HS1660R20	Grade 1 Laminate	\$11,438	\$11,610	\$11,848	\$13,275
	Grade 2 Laminate	\$11,733	\$11,905	\$12,143	\$13,570
	Grade 1 Veneer	\$13,546	\$13,718	\$13,956	\$15,383
	Grade 2 Veneer	\$15,085	\$15,257	\$15,495	\$16,922

1 TAP

Style Number	Finish	Flat Wood Edge	Bullnose Wood Edge	Beveled Wood Edge, Tapered Wood Edge	Horizon Wood Edge
HS1660R21	Grade 1 Laminate	\$13,025	\$13,197	\$13,435	\$14,862
	Grade 2 Laminate	\$13,320	\$13,492	\$13,730	\$15,157
	Grade 1 Veneer	\$15,133	\$15,305	\$15,543	\$16,970
	Grade 2 Veneer	\$16,672	\$16,844	\$17,082	\$18,509

2 TAPS

Style Number	Finish	Flat Wood Edge	Bullnose Wood Edge	Beveled Wood Edge, Tapered Wood Edge	Horizon Wood Edge
HS1660R22	Grade 1 Laminate	\$14,613	\$14,785	\$15,023	\$16,450
	Grade 2 Laminate	\$14,908	\$15,080	\$15,318	\$16,745
	Grade 1 Veneer	\$16,721	\$16,893	\$17,131	\$18,558
	Grade 2 Veneer	\$18,260	\$18,432	\$18,670	\$20,097

4 TAPS

Style Number	Finish	Flat Wood Edge	Bullnose Wood Edge	Beveled Wood Edge, Tapered Wood Edge	Horizon Wood Edge
HS1660R24	Grade 1 Laminate	\$17,786	\$17,958	\$18,196	\$19,623
	Grade 2 Laminate	\$18,081	\$18,253	\$18,491	\$19,918
	Grade 1 Veneer	\$19,894	\$20,066	\$20,304	\$21,731
	Grade 2 Veneer	\$21,433	\$21,605	\$21,843	\$23,270

▶ Specification Information, continued on next page

Host Collection

Rectangular Tables with Three Bases
DESIGN F/P DESIGN AND VECTA DESIGN TEAM

SIN 711.11

Tip: Prices shown include top, TAP(s), and slim bases.
▶ See base options for flared bases, page 174



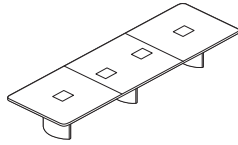
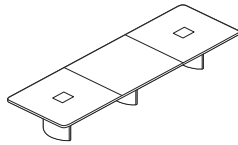
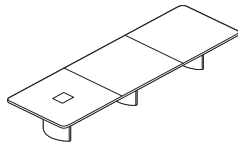
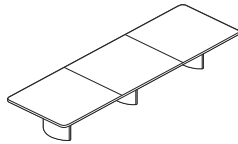

Tip: Last digit of style number indicates number of TAP(s).

Tip: For tech corridor, 16'L tables have eight long doors and four short doors.



▶ Specification Information, continued from previous page

Specification Information

Style Number	Finish	Base Prices			
					
		Flat Wood Edge:	Bullnose Wood Edge:	Beveled Wood Edge, Tapered Wood Edge:	Horizon Wood Edge:

16'L x 60"W Three Piece Top

0 TAP

Style Number	Finish	Flat Wood Edge	Bullnose Wood Edge	Beveled Wood Edge, Tapered Wood Edge	Horizon Wood Edge
HS1660R30	Grade 1 Laminate	\$11,818	\$11,990	\$12,228	\$13,655
	Grade 2 Laminate	\$12,113	\$12,285	\$12,523	\$13,950
	Grade 1 Veneer	\$13,926	\$14,098	\$14,336	\$15,763
	Grade 2 Veneer	\$15,465	\$15,637	\$15,875	\$17,302

1 TAP

Style Number	Finish	Flat Wood Edge	Bullnose Wood Edge	Beveled Wood Edge, Tapered Wood Edge	Horizon Wood Edge
HS1660R31	Grade 1 Laminate	\$13,406	\$13,578	\$13,816	\$15,243
	Grade 2 Laminate	\$13,701	\$13,873	\$14,111	\$15,538
	Grade 1 Veneer	\$15,514	\$15,686	\$15,924	\$17,351
	Grade 2 Veneer	\$17,053	\$17,225	\$17,463	\$18,890

2 TAPS

Style Number	Finish	Flat Wood Edge	Bullnose Wood Edge	Beveled Wood Edge, Tapered Wood Edge	Horizon Wood Edge
HS1660R32	Grade 1 Laminate	\$14,993	\$15,165	\$15,403	\$16,830
	Grade 2 Laminate	\$15,288	\$15,460	\$15,698	\$17,125
	Grade 1 Veneer	\$17,101	\$17,273	\$17,511	\$18,938
	Grade 2 Veneer	\$18,640	\$18,812	\$19,050	\$20,477

4 TAPS

Style Number	Finish	Flat Wood Edge	Bullnose Wood Edge	Beveled Wood Edge, Tapered Wood Edge	Horizon Wood Edge
HS1660R34	Grade 1 Laminate	\$18,166	\$18,338	\$18,576	\$20,003
	Grade 2 Laminate	\$18,461	\$18,633	\$18,871	\$20,298
	Grade 1 Veneer	\$20,274	\$20,446	\$20,684	\$22,111
	Grade 2 Veneer	\$21,813	\$21,985	\$22,223	\$23,650

▶ Specification Information, continued on next page

Host Collection

Rectangular Tables with Three Bases *continued*
 DESIGN F/P DESIGN AND VECTA DESIGN TEAM

SIN 711.11





Tip: Prices shown include top, TAP(s), and slim bases.
 ▶ See base options for flared bases, page 174

Tip: Last digit of style number indicates number of TAP(s).

Tip: For tech corridor, 18'L tables have eight long doors and four short doors.

▶ Specification Information, continued from previous page

Specification Information

Style Number	Finish	Base Prices			
					
		Flat Wood Edge:	Bullnose Wood Edge:	Beveled Wood Edge, Tapered Wood Edge:	Horizon Wood Edge:

18'L x 48"W Two Piece Top

0 TAP

Style Number	Finish	Flat Wood Edge	Bullnose Wood Edge	Beveled Wood Edge, Tapered Wood Edge	Horizon Wood Edge
HS1848R20	Grade 1 Laminate	\$11,651	\$11,830	\$12,078	\$13,520
	Grade 2 Laminate	\$11,918	\$12,097	\$12,345	\$13,787
	Grade 1 Veneer	\$13,112	\$13,291	\$13,539	\$14,981
	Grade 2 Veneer	\$14,481	\$14,660	\$14,908	\$16,350

1 TAP

Style Number	Finish	Flat Wood Edge	Bullnose Wood Edge	Beveled Wood Edge, Tapered Wood Edge	Horizon Wood Edge
HS1848R21	Grade 1 Laminate	\$13,238	\$13,417	\$13,665	\$15,107
	Grade 2 Laminate	\$13,505	\$13,684	\$13,932	\$15,374
	Grade 1 Veneer	\$14,699	\$14,878	\$15,126	\$16,568
	Grade 2 Veneer	\$16,068	\$16,247	\$16,495	\$17,937

2 TAPS

Style Number	Finish	Flat Wood Edge	Bullnose Wood Edge	Beveled Wood Edge, Tapered Wood Edge	Horizon Wood Edge
HS1848R22	Grade 1 Laminate	\$14,826	\$15,005	\$15,253	\$16,695
	Grade 2 Laminate	\$15,093	\$15,272	\$15,520	\$16,962
	Grade 1 Veneer	\$16,287	\$16,466	\$16,714	\$18,156
	Grade 2 Veneer	\$17,656	\$17,835	\$18,083	\$19,525

4 TAPS

Style Number	Finish	Flat Wood Edge	Bullnose Wood Edge	Beveled Wood Edge, Tapered Wood Edge	Horizon Wood Edge
HS1848R24	Grade 1 Laminate	\$17,999	\$18,178	\$18,426	\$19,868
	Grade 2 Laminate	\$18,266	\$18,445	\$18,693	\$20,135
	Grade 1 Veneer	\$19,460	\$19,639	\$19,887	\$21,329
	Grade 2 Veneer	\$20,829	\$21,008	\$21,256	\$22,698

6 TAPS

Style Number	Finish	Flat Wood Edge	Bullnose Wood Edge	Beveled Wood Edge, Tapered Wood Edge	Horizon Wood Edge
HS1848R26	Grade 1 Laminate	\$21,175	\$21,354	\$21,602	\$23,044
	Grade 2 Laminate	\$21,442	\$21,621	\$21,869	\$23,311
	Grade 1 Veneer	\$22,636	\$22,815	\$23,063	\$24,505
	Grade 2 Veneer	\$24,005	\$24,184	\$24,432	\$25,874

▶ Specification Information, continued on next page

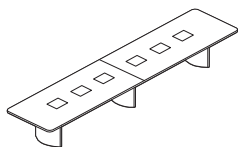
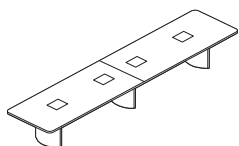
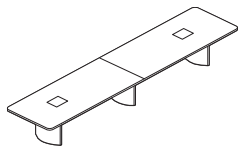
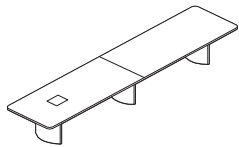
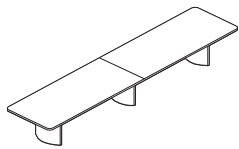

Host Collection

Rectangular Tables with Three Bases
DESIGN F/P DESIGN AND VECTA DESIGN TEAM

SIN 711.11

Tip: Prices shown include top, TAP(s), and slim bases.
► See base options for flared bases, page 174

Tip: Last digit of style number indicates number of TAP(s).

Tip: For tech corridor, 18'L tables have eight long doors and four short doors.

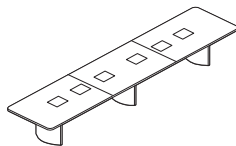
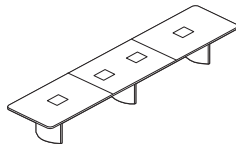
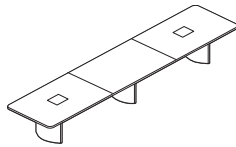
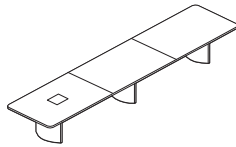
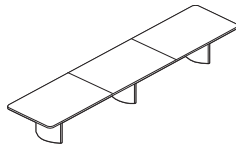

► Specification Information, continued from previous page

Specification Information

Style Number	Finish	Base Prices			
		Flat Wood Edge:	Bullnose Wood Edge:	Beveled Wood Edge, Tapered Wood Edge:	Horizon Wood Edge:

18'L x 48"W Three Piece Top

0 TAP

Style Number	Finish	Flat Wood Edge	Bullnose Wood Edge	Beveled Wood Edge, Tapered Wood Edge	Horizon Wood Edge
HS1848R30	Grade 1 Laminate	\$12,033	\$12,212	\$12,460	\$13,902
	Grade 2 Laminate	\$12,300	\$12,479	\$12,727	\$14,169
	Grade 1 Veneer	\$13,494	\$13,673	\$13,921	\$15,363
	Grade 2 Veneer	\$14,863	\$15,042	\$15,290	\$16,732

1 TAP

Style Number	Finish	Flat Wood Edge	Bullnose Wood Edge	Beveled Wood Edge, Tapered Wood Edge	Horizon Wood Edge
HS1848R31	Grade 1 Laminate	\$13,617	\$13,796	\$14,044	\$15,486
	Grade 2 Laminate	\$13,884	\$14,063	\$14,311	\$15,753
	Grade 1 Veneer	\$15,078	\$15,257	\$15,505	\$16,947
	Grade 2 Veneer	\$16,447	\$16,626	\$16,874	\$18,316

2 TAPS

Style Number	Finish	Flat Wood Edge	Bullnose Wood Edge	Beveled Wood Edge, Tapered Wood Edge	Horizon Wood Edge
HS1848R32	Grade 1 Laminate	\$15,204	\$15,383	\$15,631	\$17,073
	Grade 2 Laminate	\$15,471	\$15,650	\$15,898	\$17,340
	Grade 1 Veneer	\$16,665	\$16,844	\$17,092	\$18,534
	Grade 2 Veneer	\$18,034	\$18,213	\$18,461	\$19,903

4 TAPS

Style Number	Finish	Flat Wood Edge	Bullnose Wood Edge	Beveled Wood Edge, Tapered Wood Edge	Horizon Wood Edge
HS1848R34	Grade 1 Laminate	\$18,379	\$18,558	\$18,806	\$20,248
	Grade 2 Laminate	\$18,646	\$18,825	\$19,073	\$20,515
	Grade 1 Veneer	\$19,840	\$20,019	\$20,267	\$21,709
	Grade 2 Veneer	\$21,209	\$21,388	\$21,636	\$23,078

6 TAPS

Style Number	Finish	Flat Wood Edge	Bullnose Wood Edge	Beveled Wood Edge, Tapered Wood Edge	Horizon Wood Edge
HS1848R36	Grade 1 Laminate	\$21,554	\$21,733	\$21,981	\$23,423
	Grade 2 Laminate	\$21,821	\$22,000	\$22,248	\$23,690
	Grade 1 Veneer	\$23,015	\$23,194	\$23,442	\$24,884
	Grade 2 Veneer	\$24,384	\$24,563	\$24,811	\$26,253

► Specification Information, continued on next page

Host Collection

Rectangular Tables with Three Bases *continued*
 DESIGN F/P DESIGN AND VECTA DESIGN TEAM

SIN 711.11

Tip: Prices shown include top, TAP(s), and slim bases.
 ▶ See base options for flared bases, page 174

Tip: Last digit of style number indicates number of TAP(s).

Tip: For tech corridor, 18'L tables have eight long doors and four short doors.

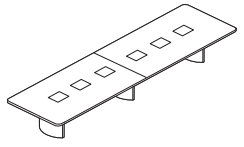
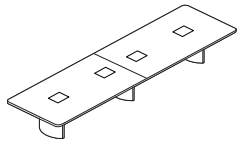
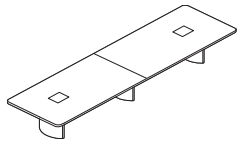
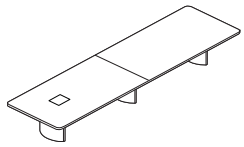
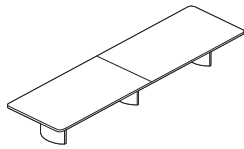

▶ Specification Information, continued from previous page

Specification Information

Style Number	Finish	Base Prices			
		Flat Wood Edge:	Bullnose Wood Edge:	Beveled Wood Edge, Tapered Wood Edge:	Horizon Wood Edge:

18'L x 60"W Two Piece Top

0 TAP

Style Number	Finish	Flat Wood Edge	Bullnose Wood Edge	Beveled Wood Edge, Tapered Wood Edge	Horizon Wood Edge
HS1860R20	Grade 1 Laminate	\$11,901	\$12,087	\$12,349	\$13,801
	Grade 2 Laminate	\$12,234	\$12,420	\$12,682	\$14,134
	Grade 1 Veneer	\$14,720	\$14,906	\$15,168	\$16,620
	Grade 2 Veneer	\$16,465	\$16,651	\$16,913	\$18,365

1 TAP

Style Number	Finish	Flat Wood Edge	Bullnose Wood Edge	Beveled Wood Edge, Tapered Wood Edge	Horizon Wood Edge
HS1860R21	Grade 1 Laminate	\$13,490	\$13,676	\$13,938	\$15,390
	Grade 2 Laminate	\$13,823	\$14,009	\$14,271	\$15,723
	Grade 1 Veneer	\$16,309	\$16,495	\$16,757	\$18,209
	Grade 2 Veneer	\$18,054	\$18,240	\$18,502	\$19,954

2 TAPS

Style Number	Finish	Flat Wood Edge	Bullnose Wood Edge	Beveled Wood Edge, Tapered Wood Edge	Horizon Wood Edge
HS1860R22	Grade 1 Laminate	\$15,078	\$15,264	\$15,526	\$16,978
	Grade 2 Laminate	\$15,411	\$15,597	\$15,859	\$17,311
	Grade 1 Veneer	\$17,897	\$18,083	\$18,345	\$19,797
	Grade 2 Veneer	\$19,642	\$19,828	\$20,090	\$21,542

4 TAPS

Style Number	Finish	Flat Wood Edge	Bullnose Wood Edge	Beveled Wood Edge, Tapered Wood Edge	Horizon Wood Edge
HS1860R24	Grade 1 Laminate	\$18,252	\$18,438	\$18,700	\$20,152
	Grade 2 Laminate	\$18,585	\$18,771	\$19,033	\$20,485
	Grade 1 Veneer	\$21,071	\$21,257	\$21,519	\$22,971
	Grade 2 Veneer	\$22,816	\$23,002	\$23,264	\$24,716

6 TAPS

Style Number	Finish	Flat Wood Edge	Bullnose Wood Edge	Beveled Wood Edge, Tapered Wood Edge	Horizon Wood Edge
HS1860R26	Grade 1 Laminate	\$21,426	\$21,612	\$21,874	\$23,326
	Grade 2 Laminate	\$21,759	\$21,945	\$22,207	\$23,659
	Grade 1 Veneer	\$24,245	\$24,431	\$24,693	\$26,145
	Grade 2 Veneer	\$25,990	\$26,176	\$26,438	\$27,890

▶ Specification Information, continued on next page

Host Collection

Rectangular Tables with Three Bases
DESIGN F/P DESIGN AND VECTA DESIGN TEAM

SIN 711.11

Tip: Prices shown include top, TAP(s), and slim bases.
▶ See base options for flared bases, page 174

Tip: Last digit of style number indicates number of TAP(s).

Tip: For tech corridor, 18'L tables have eight long doors and four short doors.

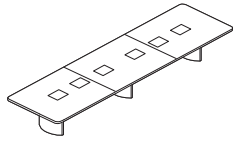
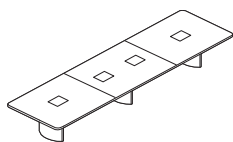
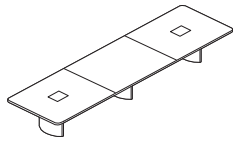
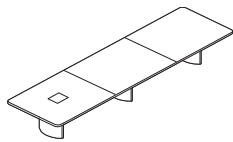
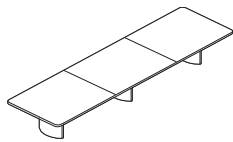

▶ Specification Information, continued from previous page

Specification Information

Style Number	Finish	Base Prices			
		Flat Wood Edge:	Bullnose Wood Edge:	Beveled Wood Edge, Tapered Wood Edge:	Horizon Wood Edge:

18'L x 60"W Three Piece Top

0 TAP

Style Number	Finish	Flat Wood Edge	Bullnose Wood Edge	Beveled Wood Edge, Tapered Wood Edge	Horizon Wood Edge
HS1860R30	Grade 1 Laminate	\$12,283	\$12,469	\$12,731	\$14,183
	Grade 2 Laminate	\$12,616	\$12,802	\$13,064	\$14,516
	Grade 1 Veneer	\$15,102	\$15,288	\$15,550	\$17,002
	Grade 2 Veneer	\$16,847	\$17,033	\$17,295	\$18,747

1 TAP

Style Number	Finish	Flat Wood Edge	Bullnose Wood Edge	Beveled Wood Edge, Tapered Wood Edge	Horizon Wood Edge
HS1860R31	Grade 1 Laminate	\$13,871	\$14,057	\$14,319	\$15,771
	Grade 2 Laminate	\$14,204	\$14,390	\$14,652	\$16,104
	Grade 1 Veneer	\$16,690	\$16,876	\$17,138	\$18,590
	Grade 2 Veneer	\$18,435	\$18,621	\$18,883	\$20,335

2 TAPS

Style Number	Finish	Flat Wood Edge	Bullnose Wood Edge	Beveled Wood Edge, Tapered Wood Edge	Horizon Wood Edge
HS1860R32	Grade 1 Laminate	\$15,457	\$15,643	\$15,905	\$17,357
	Grade 2 Laminate	\$15,790	\$15,976	\$16,238	\$17,690
	Grade 1 Veneer	\$18,276	\$18,462	\$18,724	\$20,176
	Grade 2 Veneer	\$20,021	\$20,207	\$20,469	\$21,921

4 TAPS

Style Number	Finish	Flat Wood Edge	Bullnose Wood Edge	Beveled Wood Edge, Tapered Wood Edge	Horizon Wood Edge
HS1860R34	Grade 1 Laminate	\$18,633	\$18,819	\$19,081	\$20,533
	Grade 2 Laminate	\$18,966	\$19,152	\$19,414	\$20,866
	Grade 1 Veneer	\$21,452	\$21,638	\$21,900	\$23,352
	Grade 2 Veneer	\$23,197	\$23,383	\$23,645	\$25,097

6 TAPS

Style Number	Finish	Flat Wood Edge	Bullnose Wood Edge	Beveled Wood Edge, Tapered Wood Edge	Horizon Wood Edge
HS1860R36	Grade 1 Laminate	\$21,807	\$21,993	\$22,255	\$23,707
	Grade 2 Laminate	\$22,140	\$22,326	\$22,588	\$24,040
	Grade 1 Veneer	\$24,626	\$24,812	\$25,074	\$26,526
	Grade 2 Veneer	\$26,371	\$26,557	\$26,819	\$28,271

▶ Specification Information, continued on next page

Host Collection

Rectangular Tables with Three Bases *continued*
 DESIGN F/P DESIGN AND VECTA DESIGN TEAM

SIN 711.11





Tip: Prices shown include top, TAP(s), and slim bases.
 ▶ See base options for flared bases, page 174

Tip: Last digit of style number indicates number of TAP(s).

Tip: For tech corridor, 20'L tables have eight long doors and four short doors.

▶ Specification Information, continued from previous page

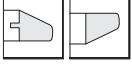
Specification Information

Style Number	Finish	Base Prices			
					
		Flat Wood Edge:	Bullnose Wood Edge:	Beveled Wood Edge, Tapered Wood Edge:	Horizon Wood Edge:

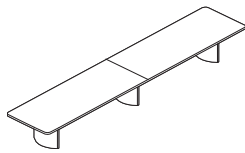

20'L x 48''W Two Piece Top

0 TAP

Style Number	Finish	Flat Wood Edge	Bullnose Wood Edge	Beveled Wood Edge, Tapered Wood Edge	Horizon Wood Edge
HS2048R20	Grade 1 Laminate	\$12,081	\$12,277	\$12,547	\$14,015
	Grade 2 Laminate	\$12,376	\$12,572	\$12,842	\$14,310
	Grade 1 Veneer	\$13,539	\$13,735	\$14,005	\$15,473
	Grade 2 Veneer	\$15,058	\$15,254	\$15,524	\$16,992

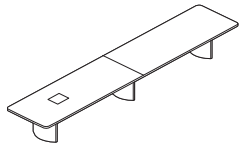

1 TAP

Style Number	Finish	Flat Wood Edge	Bullnose Wood Edge	Beveled Wood Edge, Tapered Wood Edge	Horizon Wood Edge
HS2048R21	Grade 1 Laminate	\$13,669	\$13,865	\$14,135	\$15,603
	Grade 2 Laminate	\$13,964	\$14,160	\$14,430	\$15,898
	Grade 1 Veneer	\$15,127	\$15,323	\$15,593	\$17,061
	Grade 2 Veneer	\$16,646	\$16,842	\$17,112	\$18,580

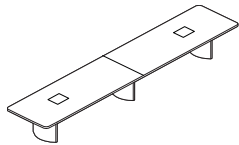

2 TAPS

Style Number	Finish	Flat Wood Edge	Bullnose Wood Edge	Beveled Wood Edge, Tapered Wood Edge	Horizon Wood Edge
HS2048R22	Grade 1 Laminate	\$15,255	\$15,451	\$15,721	\$17,189
	Grade 2 Laminate	\$15,550	\$15,746	\$16,016	\$17,484
	Grade 1 Veneer	\$16,713	\$16,909	\$17,179	\$18,647
	Grade 2 Veneer	\$18,232	\$18,428	\$18,698	\$20,166

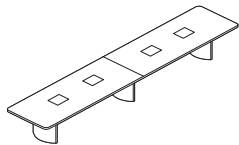

4 TAPS

Style Number	Finish	Flat Wood Edge	Bullnose Wood Edge	Beveled Wood Edge, Tapered Wood Edge	Horizon Wood Edge
HS2048R24	Grade 1 Laminate	\$18,431	\$18,627	\$18,897	\$20,365
	Grade 2 Laminate	\$18,726	\$18,922	\$19,192	\$20,660
	Grade 1 Veneer	\$19,889	\$20,085	\$20,355	\$21,823
	Grade 2 Veneer	\$21,408	\$21,604	\$21,874	\$23,342

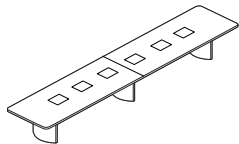

6 TAPS

Style Number	Finish	Flat Wood Edge	Bullnose Wood Edge	Beveled Wood Edge, Tapered Wood Edge	Horizon Wood Edge
HS2048R26	Grade 1 Laminate	\$21,604	\$21,800	\$22,070	\$23,538
	Grade 2 Laminate	\$21,899	\$22,095	\$22,365	\$23,833
	Grade 1 Veneer	\$23,062	\$23,258	\$23,528	\$24,996
	Grade 2 Veneer	\$24,581	\$24,777	\$25,047	\$26,515

▶ Specification Information, continued on next page

Host Collection

Rectangular Tables with Three Bases
DESIGN F/P DESIGN AND VECTA DESIGN TEAM

SIN 711.11





Tip: Prices shown include top, TAP(s), and slim bases.
▶ See base options for flared bases, page 174

Tip: Last digit of style number indicates number of TAP(s).

Tip: For tech corridor, 20'L tables have eight long doors and four short doors.

▶ Specification Information, continued from previous page

Specification Information

Style Number	Finish	Base Prices			
					
		Flat Wood Edge:	Bullnose Wood Edge:	Beveled Wood Edge, Tapered Wood Edge:	Horizon Wood Edge:

20'L x 48"W Three Piece Top

0 TAP

HS2048R30	Grade 1 Laminate	\$12,460	\$12,656	\$12,926	\$14,394
	Grade 2 Laminate	\$12,755	\$12,951	\$13,221	\$14,689
	Grade 1 Veneer	\$13,918	\$14,114	\$14,384	\$15,852
	Grade 2 Veneer	\$15,437	\$15,633	\$15,903	\$17,371

1 TAP

HS2048R31	Grade 1 Laminate	\$14,048	\$14,244	\$14,514	\$15,982
	Grade 2 Laminate	\$14,343	\$14,539	\$14,809	\$16,277
	Grade 1 Veneer	\$15,506	\$15,702	\$15,972	\$17,440
	Grade 2 Veneer	\$17,025	\$17,221	\$17,491	\$18,959

2 TAPS

HS2048R32	Grade 1 Laminate	\$15,636	\$15,832	\$16,102	\$17,570
	Grade 2 Laminate	\$15,931	\$16,127	\$16,397	\$17,865
	Grade 1 Veneer	\$17,094	\$17,290	\$17,560	\$19,028
	Grade 2 Veneer	\$18,613	\$18,809	\$19,079	\$20,547

4 TAPS

HS2048R34	Grade 1 Laminate	\$18,811	\$19,007	\$19,277	\$20,745
	Grade 2 Laminate	\$19,106	\$19,302	\$19,572	\$21,040
	Grade 1 Veneer	\$20,269	\$20,465	\$20,735	\$22,203
	Grade 2 Veneer	\$21,788	\$21,984	\$22,254	\$23,722

6 TAPS

HS2048R36	Grade 1 Laminate	\$21,984	\$22,180	\$22,450	\$23,918
	Grade 2 Laminate	\$22,279	\$22,475	\$22,745	\$24,213
	Grade 1 Veneer	\$23,442	\$23,638	\$23,908	\$25,376
	Grade 2 Veneer	\$24,961	\$25,157	\$25,427	\$26,895

▶ Specification Information, continued on next page

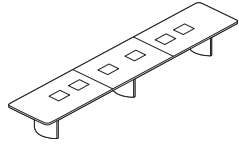
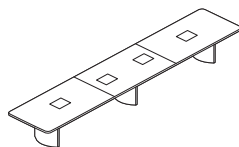
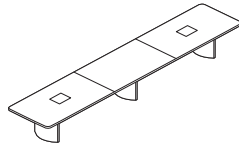
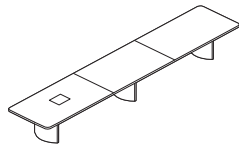
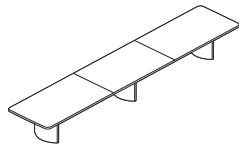

Host Collection

Rectangular Tables with Three Bases *continued*
 DESIGN F/P DESIGN AND VECTA DESIGN TEAM

SIN 711.11





Tip: Prices shown include top, TAP(s), and slim bases.
 ▶ See base options for flared bases, page 174

Tip: Last digit of style number indicates number of TAP(s).

Tip: For tech corridor, 20'L tables have eight long doors and four short doors.

▶ Specification Information, continued from previous page

Specification Information

Style Number	Finish	Base Prices			
					
		Flat Wood Edge:	Bullnose Wood Edge:	Beveled Wood Edge, Tapered Wood Edge:	Horizon Wood Edge:

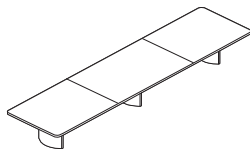

20'L x 60"W Two Piece Top

0 TAP

Style Number	Finish	Flat Wood Edge	Bullnose Wood Edge	Beveled Wood Edge, Tapered Wood Edge	Horizon Wood Edge
HS2060R20	Grade 1 Laminate	\$12,333	\$12,537	\$12,819	\$14,298
	Grade 2 Laminate	\$12,703	\$12,907	\$13,189	\$14,668
	Grade 1 Veneer	\$15,149	\$15,353	\$15,635	\$17,114
	Grade 2 Veneer	\$17,077	\$17,281	\$17,563	\$19,042

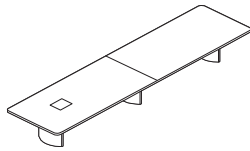

1 TAP

Style Number	Finish	Flat Wood Edge	Bullnose Wood Edge	Beveled Wood Edge, Tapered Wood Edge	Horizon Wood Edge
HS2060R21	Grade 1 Laminate	\$13,919	\$14,123	\$14,405	\$15,884
	Grade 2 Laminate	\$14,289	\$14,493	\$14,775	\$16,254
	Grade 1 Veneer	\$16,735	\$16,939	\$17,221	\$18,700
	Grade 2 Veneer	\$18,663	\$18,867	\$19,149	\$20,628

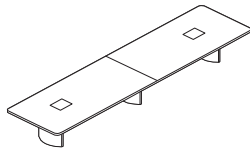

2 TAPS

Style Number	Finish	Flat Wood Edge	Bullnose Wood Edge	Beveled Wood Edge, Tapered Wood Edge	Horizon Wood Edge
HS2060R22	Grade 1 Laminate	\$15,507	\$15,711	\$15,993	\$17,472
	Grade 2 Laminate	\$15,877	\$16,081	\$16,363	\$17,842
	Grade 1 Veneer	\$18,323	\$18,527	\$18,809	\$20,288
	Grade 2 Veneer	\$20,251	\$20,455	\$20,737	\$22,216

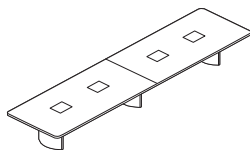

4 TAPS

Style Number	Finish	Flat Wood Edge	Bullnose Wood Edge	Beveled Wood Edge, Tapered Wood Edge	Horizon Wood Edge
HS2060R24	Grade 1 Laminate	\$18,680	\$18,884	\$19,166	\$20,645
	Grade 2 Laminate	\$19,050	\$19,254	\$19,536	\$21,015
	Grade 1 Veneer	\$21,496	\$21,700	\$21,982	\$23,461
	Grade 2 Veneer	\$23,424	\$23,628	\$23,910	\$25,389

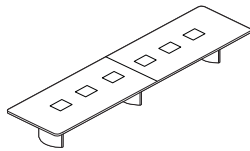

6 TAPS

Style Number	Finish	Flat Wood Edge	Bullnose Wood Edge	Beveled Wood Edge, Tapered Wood Edge	Horizon Wood Edge
HS2060R26	Grade 1 Laminate	\$21,854	\$22,058	\$22,340	\$23,819
	Grade 2 Laminate	\$22,224	\$22,428	\$22,710	\$24,189
	Grade 1 Veneer	\$24,670	\$24,874	\$25,156	\$26,635
	Grade 2 Veneer	\$26,598	\$26,802	\$27,084	\$28,563

▶ Specification Information, continued on next page

Host Collection

Rectangular Tables with Three Bases
DESIGN F/P DESIGN AND VECTA DESIGN TEAM

SIN 711.11





Tip: Prices shown include top, TAP(s), and slim bases.
▶ See base options for flared bases, page 174

Tip: Last digit of style number indicates number of TAP(s).

Tip: For tech corridor, 20'L tables have eight long doors and four short doors.

▶ Specification Information, continued from previous page

Specification Information

Style Number	Finish	Base Prices			
					
		Flat Wood Edge:	Bullnose Wood Edge:	Beveled Wood Edge, Tapered Wood Edge:	Horizon Wood Edge:

20'L x 60"W Three Piece Top

0 TAP

HS2060R30	Grade 1 Laminate	\$12,711	\$12,915	\$13,197	\$14,676
	Grade 2 Laminate	\$13,081	\$13,285	\$13,567	\$15,046
	Grade 1 Veneer	\$15,527	\$15,731	\$16,013	\$17,492
	Grade 2 Veneer	\$17,455	\$17,659	\$17,941	\$19,420

1 TAP

HS2060R31	Grade 1 Laminate	\$14,298	\$14,502	\$14,784	\$16,263
	Grade 2 Laminate	\$14,668	\$14,872	\$15,154	\$16,633
	Grade 1 Veneer	\$17,114	\$17,318	\$17,600	\$19,079
	Grade 2 Veneer	\$19,042	\$19,246	\$19,528	\$21,007

2 TAPS

HS2060R32	Grade 1 Laminate	\$15,887	\$16,091	\$16,373	\$17,852
	Grade 2 Laminate	\$16,257	\$16,461	\$16,743	\$18,222
	Grade 1 Veneer	\$18,703	\$18,907	\$19,189	\$20,668
	Grade 2 Veneer	\$20,631	\$20,835	\$21,117	\$22,596

4 TAPS

HS2060R34	Grade 1 Laminate	\$19,061	\$19,265	\$19,547	\$21,026
	Grade 2 Laminate	\$19,431	\$19,635	\$19,917	\$21,396
	Grade 1 Veneer	\$21,877	\$22,081	\$22,363	\$23,842
	Grade 2 Veneer	\$23,805	\$24,009	\$24,291	\$25,770

6 TAPS

HS2060R36	Grade 1 Laminate	\$22,235	\$22,439	\$22,721	\$24,200
	Grade 2 Laminate	\$22,605	\$22,809	\$23,091	\$24,570
	Grade 1 Veneer	\$25,051	\$25,255	\$25,537	\$27,016
	Grade 2 Veneer	\$26,979	\$27,183	\$27,465	\$28,944

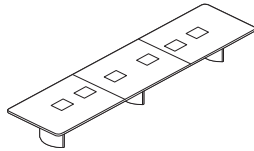
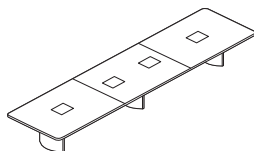
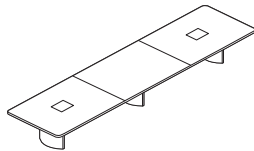
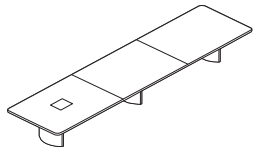
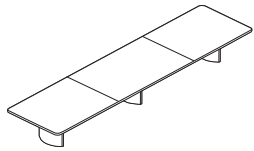

Host Collection

Soft Radiused Tables with Two Bases
 DESIGN F/P DESIGN AND VECTA DESIGN TEAM

SIN 711.11

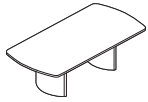

Tip: Shipped knocked down and top ships in one piece.

Tip: Grain direction for wood-grain laminate runs the length of the table.

Tip: Clips are provided with table. One clip per foot of table length.

Tip: The wood edge on a table top with woodgrain laminate may not match the top.

Tip: You must send a sample of reasonable size for Stain-to-Match.

Tip: 96"L tables available with zero, one, or two TAP(s). 10'L and 12'L tables available with zero, one, two, or three TAP(s).

Tip: In addition to the data and audio/video AAPs available from Coalesse, other styles of AAPs are available through Extron Electronics. For an Extron dealer, call 1-800-633-9876.

Tip: See TAP options for electrical systems and faceplate list.

Standard Includes		Required to Specify
<ul style="list-style-type: none"> ▶ Need help? Product details, see <i>Coalesse Tables, Storage, and Accessories Specification Guide</i> 	<ul style="list-style-type: none"> • Top: 1¼" particle board core with laminate • Flat wood edge • TAP(s), if selected: 10"W x 12"L opening(s) trimmed with a flat solid wood profile and with brushed anodized aluminum TAP doors • Tech corridor: two aluminum beams for top support provide tracks for hinged aluminum doors that clip shut: satin anodized finish • Universal clip: black plastic • Two 27"W bases: wood veneer on MDF with aluminum universal bracket • Concealed leveling glides: non-marring, black plastic 	<ol style="list-style-type: none"> 1 Style number 2 Base selection (see below) and wood color number for base 3 Laminate color number for table top, if selected 4 Wood color number for wood edge <p>▶ See <i>Hardwood and Veneer Matrix</i>, page 364</p> <ol style="list-style-type: none"> 5 Door color number for storage tray or TAP door, if selected: <ul style="list-style-type: none"> - 8044 Black - 8047 Silver 6 Options, if selected (see below) <p>▶ See <i>Surface Materials</i>, page 350.</p>

Options	Price	Required to Specify
Surface Materials <ul style="list-style-type: none"> • Top • Grade 2 laminate • Grade 1 wood veneer • Grade 2 wood veneer • Stain-to-Match 	<ul style="list-style-type: none"> Prices at right Prices at right Prices at right No cost 	<ul style="list-style-type: none"> Specify with <i>Grade 2 laminate</i> and select color number. Specify with <i>Grade 1 wood veneer</i> and select color number. Specify with <i>Grade 2 wood veneer</i> and select color number. Specify with <i>Stain-to-Match</i>. <p>▶ Page 385</p>

Edges	Wood	Price	Required to Specify
	<ul style="list-style-type: none"> • Bullnose wood edge • Horizon wood edge 	<ul style="list-style-type: none"> Prices at right Prices at right 	<ul style="list-style-type: none"> Specify with <i>bullnose wood edge</i>. Specify with <i>Horizon wood edge</i>.

Bases	Options	Price	Required to Specify
<p>Slim Flared</p>	<ul style="list-style-type: none"> • Two slim bases • One slim and one flared base • Two flared bases 	<ul style="list-style-type: none"> No cost +\$ 827 +\$1656 	<ul style="list-style-type: none"> Specify with <i>two slim bases</i>. Specify with <i>one slim base</i> and one flared base. Specify with <i>two flared bases</i>.

TAP Electrical System with Faceplate Options	Options	Price	Required to Specify
<p>Field Wired</p>	<ul style="list-style-type: none"> • Field-wired tray (no electrical) <ul style="list-style-type: none"> - PAFW field-wired tray (no electrical) with blank AAPs - PDFW field-wired tray (no electrical) with two data AAPs - PVFW field-wired tray (no electrical) with two of each video/audio and data AAPs 	<ul style="list-style-type: none"> No cost 	<ul style="list-style-type: none"> Specify with <i>power data</i>, and select TAP type and TAP door color number.
<p>Cord and Plug</p>	<ul style="list-style-type: none"> • Cord and plug tray (10' cord) <ul style="list-style-type: none"> - PACP cord and plug tray with outlets and blank AAPs - PDCP cord and plug tray with outlets and two data AAPs - PAVC cord and plug tray with outlets and two of each video/audio and data AAPs 	<ul style="list-style-type: none"> No cost 	<ul style="list-style-type: none"> Specify with <i>power data</i>, and select TAP type and TAP door color number.
<p>Hardwired</p>	<ul style="list-style-type: none"> • Hard-wired tray (6' conduit) <ul style="list-style-type: none"> - PAHW hard-wired tray with outlets and blank AAPs - PDHW hard-wired tray with outlets and two data AAPs - PAVH hard-wired tray with outlets and two of each video/audio and data AAPs 	<ul style="list-style-type: none"> No cost 	<ul style="list-style-type: none"> Specify with <i>power data</i>, and select TAP type and TAP door color number.

▶ Options, continued on next page

Host Collection

Soft Radiused Tables with Two Bases
DESIGN F/P DESIGN AND VECTA DESIGN TEAM

SIN 711.11

► Options, continued from previous page

Tip: For single TAP style numbers, the modular system tray is not available. Specify the hard-wired tray option.

Tip: If the specified table has multiple TAP(s), any one TAP can be replaced with a storage tray.

Tip: Wood veneer doors for storage tray and TAP will always be cross grain.

Tip: Connectrac must be the same wiring schematic as the table.

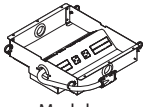
Options	Price	Required to Specify
TAP Electrical System with Faceplate Options  Modular	<ul style="list-style-type: none"> Modular system tray (hardwire base power infeed) <ul style="list-style-type: none"> - PAMH modular system tray with outlets and blank AAPs - PDMH modular system tray with outlets and two data AAPs - PVMH modular system tray with outlets and two of each video/audio and data AAPs 	+\$141 each tray Specify with modular power data, and select TAP type and TAP door color number.
Storage Tray	<ul style="list-style-type: none"> Storage tray 	-\$593 Specify with storage tray and select door color number.
Doors	<ul style="list-style-type: none"> Storage tray wood veneer doors TAP wood veneer doors 	+\$298 per door +\$298 per door Specify with wood doors. Specify with wood doors.
Related Products	<ul style="list-style-type: none"> Floor kit: Connectrac Corridor shelf 	► Page 283 ► Page 283

TAP Locations

96"L x 48"W TAP Locations—One piece top

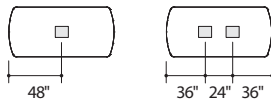

10'L x 48"W TAP Locations—One piece top

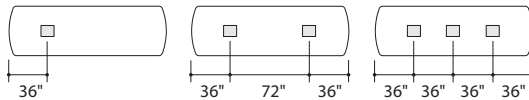

10'L x 48"W TAP Locations—Two piece top

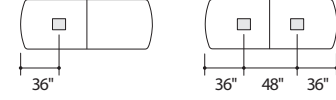

10'L x 60"W TAP Locations—One piece top

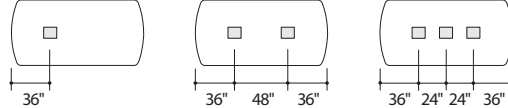

10'L x 60"W TAP Locations—Two piece top

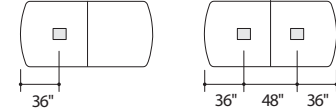

12'L x 48"W TAP Locations—One piece top

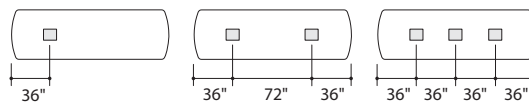

12'L x 48"W TAP Locations—Two piece top

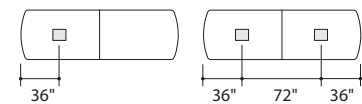

12'L x 60"W TAP Locations—One piece top

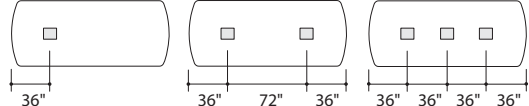

12'L x 60"W TAP Locations—Two piece top

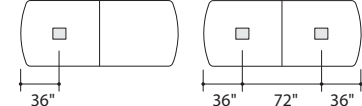

► Specification Information, on next page

Host Collection Soft Radiused Tables with Two Bases *continued*

DESIGN F/P DESIGN AND VECTA DESIGN TEAM



SIN 711.11

Tip: Prices shown include top, TAP(s), and slim bases.
 ▶ See base options for flared bases, page 194

Tip: Last digit of style number indicates number of TAP(s).

▶ Options, on previous page

Specification Information

Style Number	Finish	Base Prices		
				
		Flat Wood Edge:	Bullnose Wood Edge:	Horizon Wood Edge:

96"L x 48"W One Piece Top

0 TAP

HS9648S10	Grade 1 Laminate	\$ 6753	\$ 6853	\$ 8830
	Grade 2 Laminate	\$ 6871	\$ 6971	\$ 8948
	Grade 1 Veneer	\$ 7261	\$ 7361	\$ 9338
	Grade 2 Veneer	\$ 7864	\$ 7964	\$ 9941

1 TAP

HS9648S11	Grade 1 Laminate	\$ 8338	\$ 8438	\$10,415
	Grade 2 Laminate	\$ 8456	\$ 8556	\$10,533
	Grade 1 Veneer	\$ 8846	\$ 8946	\$10,923
	Grade 2 Veneer	\$ 9449	\$ 9549	\$11,526

2 TAPS

HS9648S12	Grade 1 Laminate	\$ 9925	\$10,025	\$12,001
	Grade 2 Laminate	\$10,043	\$10,143	\$12,119
	Grade 1 Veneer	\$10,433	\$10,533	\$12,509
	Grade 2 Veneer	\$11,036	\$11,136	\$13,112

▶ Specification Information, continued on next page

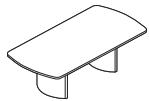

Tip: For tech corridor, 96"L tables have two long doors and four short doors.

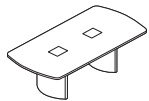
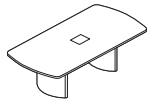

Host Collection

Soft Radiused Tables with Two Bases
 DESIGN F/P DESIGN AND VECTA DESIGN TEAM



SIN 711.11

Tip: Prices shown include top, TAP(s), and slim bases.
 ▶ See base options for flared bases, page 194

Tip: Last digit of style number indicates number of TAP(s).

▶ Specification Information, continued from previous page

Specification Information

Style Number	Finish	Base Prices		
				
		Flat Wood Edge:	Bullnose Wood Edge:	Horizon Wood Edge:

10'L x 48"W One Piece Top

0 TAP

HS1048S10	Grade 1 Laminate	\$ 7285	\$ 7401	\$ 9517
	Grade 2 Laminate	\$ 7435	\$ 7551	\$ 9667
	Grade 1 Veneer	\$ 7904	\$ 8020	\$10,136
	Grade 2 Veneer	\$ 8657	\$ 8773	\$10,889

1 TAP

HS1048S11	Grade 1 Laminate	\$ 8871	\$ 8987	\$11,103
	Grade 2 Laminate	\$ 9021	\$ 9137	\$11,253
	Grade 1 Veneer	\$ 9490	\$ 9606	\$11,722
	Grade 2 Veneer	\$10,243	\$10,359	\$12,475

2 TAPS

HS1048S12	Grade 1 Laminate	\$10,458	\$10,574	\$12,690
	Grade 2 Laminate	\$10,608	\$10,724	\$12,840
	Grade 1 Veneer	\$11,077	\$11,193	\$13,309
	Grade 2 Veneer	\$11,830	\$11,946	\$14,062

3 TAPS

HS1048S13	Grade 1 Laminate	\$12,046	\$12,162	\$14,278
	Grade 2 Laminate	\$12,196	\$12,312	\$14,428
	Grade 1 Veneer	\$12,665	\$12,781	\$14,897
	Grade 2 Veneer	\$13,418	\$13,534	\$15,650

▶ Specification Information, continued on next page

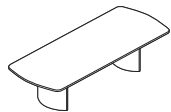

Tip: For tech corridor, 10'L tables have four long doors and four short doors.

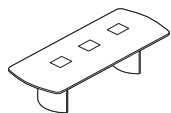
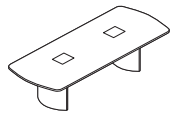
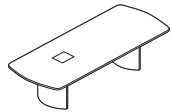

Host Collection

Soft Radiused Tables with Two Bases *continued*
 DESIGN F/P DESIGN AND VECTA DESIGN TEAM



SIN 711.11

Tip: Prices shown include top, TAP(s), and slim bases.
 ▶ See base options for flared bases, page 194

Tip: Last digit of style number indicates number of TAP(s).

▶ Specification Information, continued from previous page

Specification Information

Style Number	Finish	Base Prices		
				
		Flat Wood Edge:	Bullnose Wood Edge:	Horizon Wood Edge:

10'L x 48"W Two Piece Top

0 TAP

HS1048S20	Grade 1 Laminate	\$ 7665	\$ 7781	\$ 9897
	Grade 2 Laminate	\$ 7815	\$ 7931	\$10,047
	Grade 1 Veneer	\$ 8284	\$ 8400	\$10,516
	Grade 2 Veneer	\$ 9037	\$ 9153	\$11,269

1 TAP

HS1048S21	Grade 1 Laminate	\$ 9251	\$ 9367	\$11,483
	Grade 2 Laminate	\$ 9401	\$ 9517	\$11,633
	Grade 1 Veneer	\$ 9870	\$ 9986	\$12,102
	Grade 2 Veneer	\$10,623	\$10,739	\$12,855

2 TAPS

HS1048S22	Grade 1 Laminate	\$10,838	\$10,954	\$13,070
	Grade 2 Laminate	\$10,988	\$11,104	\$13,220
	Grade 1 Veneer	\$11,457	\$11,573	\$13,689
	Grade 2 Veneer	\$12,210	\$12,326	\$14,442

10'L x 60"W One Piece Top

0 TAP

HS1060S10	Grade 1 Laminate	\$ 7481	\$ 7605	\$ 9737
	Grade 2 Laminate	\$ 7664	\$ 7788	\$ 9920
	Grade 1 Veneer	\$ 8571	\$ 8695	\$10,827
	Grade 2 Veneer	\$ 9525	\$ 9649	\$11,781

1 TAP

HS1060S11	Grade 1 Laminate	\$ 9069	\$ 9193	\$11,325
	Grade 2 Laminate	\$ 9252	\$ 9376	\$11,508
	Grade 1 Veneer	\$10,159	\$10,283	\$12,415
	Grade 2 Veneer	\$11,113	\$11,237	\$13,369

2 TAPS

HS1060S12	Grade 1 Laminate	\$10,656	\$10,780	\$12,912
	Grade 2 Laminate	\$10,839	\$10,963	\$13,095
	Grade 1 Veneer	\$11,746	\$11,870	\$14,002
	Grade 2 Veneer	\$12,700	\$12,824	\$14,956

▶ Specification Information, continued on next page

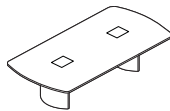
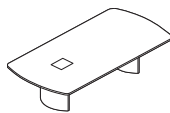
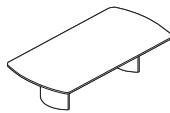
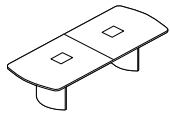
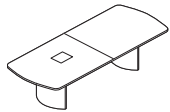
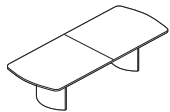

Host Collection

Soft Radiused Tables with Two Bases
DESIGN F/P DESIGN AND VECTA DESIGN TEAM



SIN 711.11

Tip: Prices shown include top, TAP(s), and slim bases.
▶ See base options for flared bases, page 194

Tip: Last digit of style number indicates number of TAP(s).

▶ Specification Information, continued from previous page

Specification Information

Style Number	Finish	Base Prices		
				
		Flat Wood Edge:	Bullnose Wood Edge:	Horizon Wood Edge:

10'L x 60"W One Piece Top, continued

3 TAPS

HS1060S13	Grade 1 Laminate	\$12,244	\$12,368	\$14,500
	Grade 2 Laminate	\$12,427	\$12,551	\$14,683
	Grade 1 Veneer	\$13,334	\$13,458	\$15,590
	Grade 2 Veneer	\$14,288	\$14,412	\$16,544

10'L x 60"W Two Piece Top

0 TAP

HS1060S20	Grade 1 Laminate	\$ 7862	\$ 7986	\$10,118
	Grade 2 Laminate	\$ 8045	\$ 8169	\$10,301
	Grade 1 Veneer	\$ 8952	\$ 9076	\$11,208
	Grade 2 Veneer	\$ 9906	\$10,030	\$12,162

1 TAP

HS1060S21	Grade 1 Laminate	\$ 9449	\$ 9573	\$11,705
	Grade 2 Laminate	\$ 9632	\$ 9756	\$11,888
	Grade 1 Veneer	\$10,539	\$10,663	\$12,795
	Grade 2 Veneer	\$11,493	\$11,617	\$13,749

2 TAPS

HS1060S22	Grade 1 Laminate	\$11,037	\$11,161	\$13,293
	Grade 2 Laminate	\$11,220	\$11,344	\$13,476
	Grade 1 Veneer	\$12,127	\$12,251	\$14,383
	Grade 2 Veneer	\$13,081	\$13,205	\$15,337

12'L x 48"W One Piece Top

0 TAP

HS1248S10	Grade 1 Laminate	\$ 7759	\$ 7890	\$10,031
	Grade 2 Laminate	\$ 7936	\$ 8067	\$10,208
	Grade 1 Veneer	\$ 8576	\$ 8707	\$10,848
	Grade 2 Veneer	\$ 9486	\$ 9617	\$11,758

1 TAP

HS1248S11	Grade 1 Laminate	\$ 9346	\$ 9477	\$11,618
	Grade 2 Laminate	\$ 9523	\$ 9654	\$11,795
	Grade 1 Veneer	\$10,163	\$10,294	\$12,435
	Grade 2 Veneer	\$11,073	\$11,204	\$13,345

▶ Specification Information, continued on next page

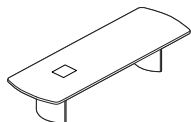
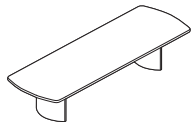
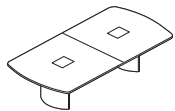
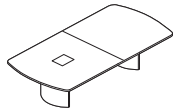
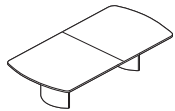
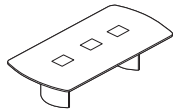

Host Collection

Soft Radiused Tables with Two Bases *continued*
 DESIGN F/P DESIGN AND VECTA DESIGN TEAM

SIN 711.11

Tip: Prices shown include top, TAP(s), and slim bases.
 ▶ See base options for flared bases, page 194

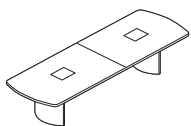
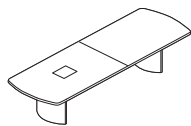
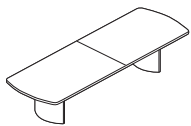
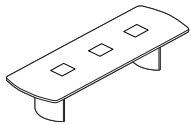
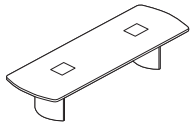

Tip: Last digit of style number indicates number of TAP(s).

Tip: For tech corridor, 12'L tables have four long doors and four short doors.



▶ Specification Information, continued from previous page

Specification Information

Style Number	Finish	Base Prices		
				
		Flat Wood Edge:	Bullnose Wood Edge:	Horizon Wood Edge:

12'L x 48" W One Piece Top, continued

2 TAPS

Style Number	Finish	Flat Wood Edge	Bullnose Wood Edge	Horizon Wood Edge
HS1248S12	Grade 1 Laminate	\$10,932	\$11,063	\$13,204
	Grade 2 Laminate	\$11,109	\$11,240	\$13,381
	Grade 1 Veneer	\$11,749	\$11,880	\$14,021
	Grade 2 Veneer	\$12,659	\$12,790	\$14,931

3 TAPS

Style Number	Finish	Flat Wood Edge	Bullnose Wood Edge	Horizon Wood Edge
HS1248S13	Grade 1 Laminate	\$12,521	\$12,652	\$14,793
	Grade 2 Laminate	\$12,698	\$12,829	\$14,970
	Grade 1 Veneer	\$13,338	\$13,469	\$15,610
	Grade 2 Veneer	\$14,248	\$14,379	\$16,520

12'L x 48" W Two Piece Top

0 TAP

Style Number	Finish	Flat Wood Edge	Bullnose Wood Edge	Horizon Wood Edge
HS1248S20	Grade 1 Laminate	\$ 8137	\$ 8268	\$10,409
	Grade 2 Laminate	\$ 8314	\$ 8445	\$10,586
	Grade 1 Veneer	\$ 8954	\$ 9085	\$11,226
	Grade 2 Veneer	\$ 9864	\$ 9995	\$12,136

1 TAP

Style Number	Finish	Flat Wood Edge	Bullnose Wood Edge	Horizon Wood Edge
HS1248S21	Grade 1 Laminate	\$ 9727	\$ 9858	\$11,999
	Grade 2 Laminate	\$ 9904	\$10,035	\$12,176
	Grade 1 Veneer	\$10,544	\$10,675	\$12,816
	Grade 2 Veneer	\$11,454	\$11,585	\$13,726

2 TAPS

Style Number	Finish	Flat Wood Edge	Bullnose Wood Edge	Horizon Wood Edge
HS1248S22	Grade 1 Laminate	\$11,313	\$11,444	\$13,585
	Grade 2 Laminate	\$11,490	\$11,621	\$13,762
	Grade 1 Veneer	\$12,130	\$12,261	\$14,402
	Grade 2 Veneer	\$13,040	\$13,171	\$15,312

▶ Specification Information, continued on next page

Host Collection

Soft Radiused Tables with Two Bases
DESIGN F/P DESIGN AND VECTA DESIGN TEAM



SIN 711.11

Tip: Prices shown include top, TAP(s), and slim bases.
▶ See base options for flared bases, page 194

Tip: Last digit of style number indicates number of TAP(s).

▶ Specification Information, continued from previous page

Specification Information

Style Number	Finish	Base Prices		
				
		Flat Wood Edge:	Bullnose Wood Edge:	Horizon Wood Edge:

12'L x 60"W One Piece Top

0 TAP

HS1260S10	Grade 1 Laminate	\$ 7965	\$ 8103	\$10,262
	Grade 2 Laminate	\$ 8186	\$ 8324	\$10,483
	Grade 1 Veneer	\$ 9305	\$ 9443	\$11,602
	Grade 2 Veneer	\$10,450	\$10,588	\$12,747

1 TAP

HS1260S11	Grade 1 Laminate	\$ 9554	\$ 9692	\$11,851
	Grade 2 Laminate	\$ 9775	\$ 9913	\$12,072
	Grade 1 Veneer	\$10,894	\$11,032	\$13,191
	Grade 2 Veneer	\$12,039	\$12,177	\$14,336

2 TAPS

HS1260S12	Grade 1 Laminate	\$11,140	\$11,278	\$13,437
	Grade 2 Laminate	\$11,361	\$11,499	\$13,658
	Grade 1 Veneer	\$12,480	\$12,618	\$14,777
	Grade 2 Veneer	\$13,625	\$13,763	\$15,922

3 TAPS

HS1260S13	Grade 1 Laminate	\$12,727	\$12,865	\$15,024
	Grade 2 Laminate	\$12,948	\$13,086	\$15,245
	Grade 1 Veneer	\$14,067	\$14,205	\$16,364
	Grade 2 Veneer	\$15,212	\$15,350	\$17,509

▶ Specification Information, continued on next page

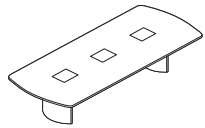
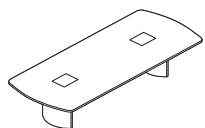
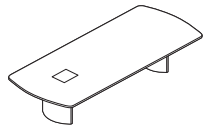
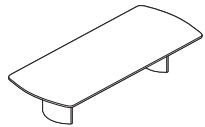

Host Collection

Soft Radiused Tables with Two Bases *continued*
 DESIGN F/P DESIGN AND VECTA DESIGN TEAM



SIN 711.11

Tip: Prices shown include top, TAP(s), and slim bases.
 ▶ See base options for flared bases, page 194

Tip: Last digit of style number indicates number of TAP(s).

▶ Specification Information, continued from previous page

Specification Information

Style Number	Finish	Base Prices		
				
		Flat Wood Edge:	Bullnose Wood Edge:	Horizon Wood Edge:

12'L x 60"W Two Piece Top

0 TAP

HS1260S20	Grade 1 Laminate	\$ 8344	\$ 8482	\$10,641
	Grade 2 Laminate	\$ 8565	\$ 8703	\$10,862
	Grade 1 Veneer	\$ 9684	\$ 9822	\$11,981
	Grade 2 Veneer	\$10,829	\$10,967	\$13,126

1 TAP

HS1260S21	Grade 1 Laminate	\$ 9932	\$10,070	\$12,229
	Grade 2 Laminate	\$10,153	\$10,291	\$12,450
	Grade 1 Veneer	\$11,272	\$11,410	\$13,569
	Grade 2 Veneer	\$12,417	\$12,555	\$14,714

2 TAPS

HS1260S22	Grade 1 Laminate	\$11,520	\$11,658	\$13,817
	Grade 2 Laminate	\$11,741	\$11,879	\$14,038
	Grade 1 Veneer	\$12,860	\$12,998	\$15,157
	Grade 2 Veneer	\$14,005	\$14,143	\$16,302

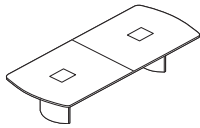
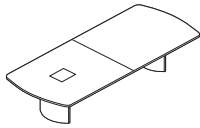
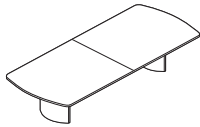

Coalesse

Host Collection

Soft Radiused Tables with Two Bases
DESIGN F/P DESIGN AND VECTA DESIGN TEAM

SIN 711.11

Host Collection

Soft Radiused Tables with Three Bases
DESIGN F/P DESIGN AND VECTA DESIGN TEAM

SIN 711.11

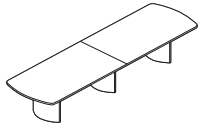

Tip: Shipped knocked down and top ships in one piece.

Tip: Grain direction for wood-grain laminate runs the length of the table.

Tip: Clips are provided with table. One clip per foot of table length.

Tip: The wood edge on a table top with woodgrain laminate may not match the top.

Tip: You must send a sample of reasonable size for Stain-to-Match.

Tip: 14'L and 16'L tables available with zero, one, two, or four TAP(s). 18'L and 20'L tables available with zero, one, two, four, or six TAP(s).

Tip: In addition to the data and audio/video AAPs available from Coalesse, other styles of AAPs are available through Extron Electronics. For an Extron dealer, call 1-800-633-9876.

Tip: See TAP options for electrical systems and faceplate list.

Veneer direction



Standard Includes	Required to Specify
<ul style="list-style-type: none"> ▶ Need help? Product details, see <i>Coalesse Tables, Storage, and Accessories Specification Guide</i> • Top: 1¼" particle board core with laminate • Flat wood edge • TAP(s), if selected: 10"W x 12"L opening(s) trimmed with a flat solid wood profile and with brushed anodized aluminum TAP doors • Tech corridor: four aluminum beams for top support provide tracks for hinged aluminum doors that clip shut: satin anodized finish • Universal clip: black plastic • Three 27"W bases: wood veneer on MDF with aluminum universal bracket, see below • Concealed leveling glides: non-marring, black plastic 	<ol style="list-style-type: none"> 1 Style number 2 Base selection (see below) and wood color number for base 3 Laminate color number for table top, if selected 4 Wood color number for wood edge <ul style="list-style-type: none"> ▶ See <i>Veneer Matrix</i>, page 365 5 Door color number for storage tray or TAP door, if selected: <ul style="list-style-type: none"> - 8044 Black - 8047 Silver 6 Options, if selected (see below) <ul style="list-style-type: none"> ▶ See <i>Surface Materials</i>, page 350.

Options	Price	Required to Specify
Surface Materials <ul style="list-style-type: none"> • Top • Grade 2 laminate • Grade 1 wood veneer • Grade 2 wood veneer • Stain-to-Match 	<ul style="list-style-type: none"> Prices at right Prices at right Prices at right No cost 	<ul style="list-style-type: none"> Specify with <i>Grade 2 laminate</i> and select color number. Specify with <i>Grade 1 wood veneer</i> and select color number. Specify with <i>Grade 2 wood veneer</i> and select color number. Specify with <i>Stain-to-Match</i>. ▶ Page 385

Edges	Wood	Price	Required to Specify
	<ul style="list-style-type: none"> • Bullnose wood edge • Horizon wood edge 	<ul style="list-style-type: none"> Prices at right Prices at right 	<ul style="list-style-type: none"> Specify with <i>bullnose wood edge</i>. Specify with <i>Horizon wood edge</i>.

Bases	Price	Required to Specify
<ul style="list-style-type: none"> • Three slim bases • Two slim and one flared bases • One slim and two flared bases • Three flared bases 	<ul style="list-style-type: none"> No cost +\$ 827 +\$1654 +\$2481 	<ul style="list-style-type: none"> Specify with <i>three slim bases</i>. Specify with <i>two slim and one flared bases</i>. Specify with <i>one slim and two flared bases</i>. Specify with <i>three flared bases</i>.

TAP Electrical System with Faceplate Options	Price	Required to Specify
<ul style="list-style-type: none"> • Field-wired tray (no electrical) <ul style="list-style-type: none"> - PAFW field-wired tray (no electrical) with blank AAPs - PDFW field-wired tray (no electrical) with two data AAPs - PVFW field-wired tray (no electrical) with two of each video/audio and data AAPs 	<ul style="list-style-type: none"> No cost 	<ul style="list-style-type: none"> Specify with <i>power data</i>, and select TAP type and TAP door color number.
<ul style="list-style-type: none"> • Cord and plug tray (10' cord) <ul style="list-style-type: none"> - PACP cord and plug tray with outlets and blank AAPs - PDCP cord and plug tray with outlets and two data AAPs - PAVC cord and plug tray with outlets and two of each video/audio and data AAPs 	<ul style="list-style-type: none"> No cost 	<ul style="list-style-type: none"> Specify with <i>power data</i>, and select TAP type and TAP door color number.
<ul style="list-style-type: none"> • Hard-wired tray (6' conduit) <ul style="list-style-type: none"> - PAHW hard-wired tray with outlets and blank AAPs - PDHW hard-wired tray with outlets and two data AAPs - PAVH hard-wired tray with outlets and two of each video/audio and data AAPs 	<ul style="list-style-type: none"> No cost 	<ul style="list-style-type: none"> Specify with <i>power data</i>, and select TAP type and TAP door color number.

▶ Options, continued on next page

Host Collection

Soft Radiused Tables with Three Bases
DESIGN F/P DESIGN AND VECTA DESIGN TEAM

SIN 711.11

► Options, continued from previous page

Tip: For single TAP style numbers, the modular system tray is not available. Specify the hard-wired tray option.

Tip: If the specified table has multiple TAPs, any one TAP can be replaced with a storage tray.

Tip: Wood veneer doors for storage tray or TAP will always be cross grain.

Tip: Connectrac must be the same wiring schematic as the table.

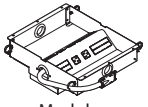
Options	Price	Required to Specify
TAP Electrical System with Faceplate Options  Modular	<ul style="list-style-type: none"> Modular system tray (hardwire base power infeed) <ul style="list-style-type: none"> - PAMH modular system tray with outlets and blank AAPs - PDMH modular system tray with outlets and two data AAPs - PVMH modular system tray with outlets and two of each video/audio and data AAPs +\$141 each tray	Specify with <i>modular power data</i> , and select TAP type and TAP door color number.
Storage Tray	<ul style="list-style-type: none"> Storage tray -\$593	Specify with <i>storage tray</i> and select door color number.
Doors	<ul style="list-style-type: none"> Storage tray wood veneer doors TAP wood veneer doors +\$298 per door +\$298 per door	Specify with <i>wood doors</i> . Specify with <i>wood doors</i> .
Related Products	<ul style="list-style-type: none"> Floor kit: Connectrac Corridor shelf 	► Page 283 ► Page 283

TAP Locations

14'L x 48"W TAP Locations—Two piece top

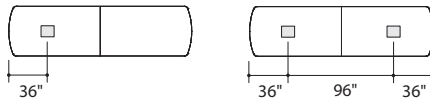

14'L x 48"W TAP Locations—Three piece top

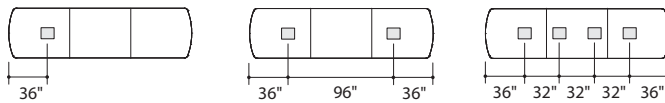

14'L x 60"W TAP Locations—Two piece top

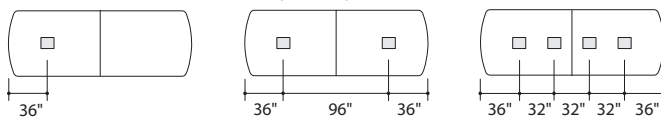

14'L x 60"W TAP Locations—Three piece top

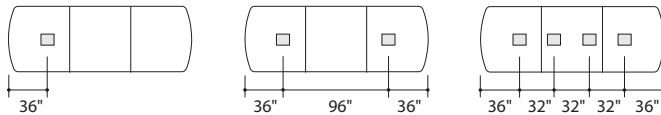

16'L x 48"W TAP Locations—Two piece top

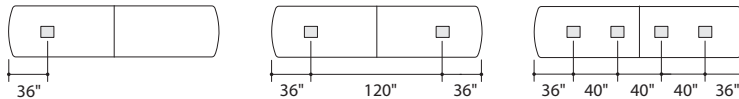

16'L x 48"W TAP Locations—Three piece top

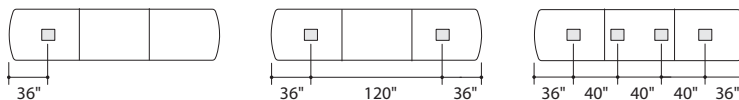

16'L x 60"W TAP Locations—Two piece top

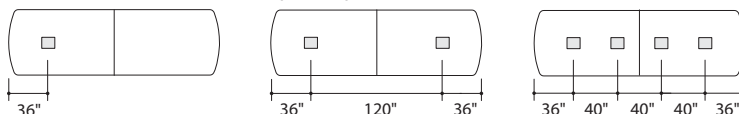

Host Collection Soft Radiused Tables with Three Bases *continued*

DESIGN F/P DESIGN AND VECTA DESIGN TEAM

SIN 711.11

►Options, continued from previous page

TAP Locations

16'L x 60"W TAP Locations—Three piece top

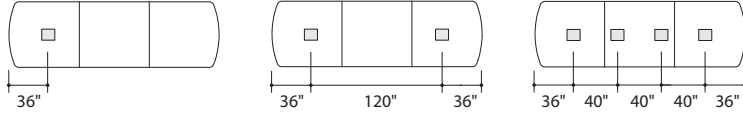

18'L x 48"W TAP Locations—Two piece top

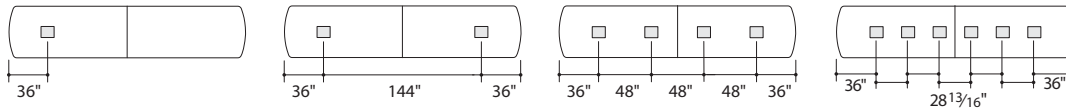

18'L x 48"W TAP Locations—Three piece top

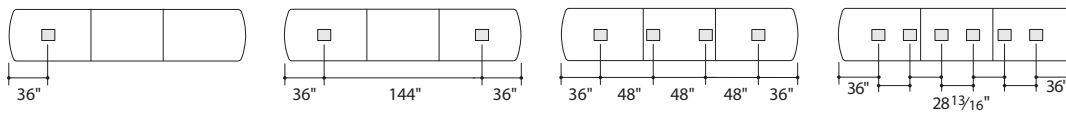

18'L x 60"W TAP Locations—Two piece top

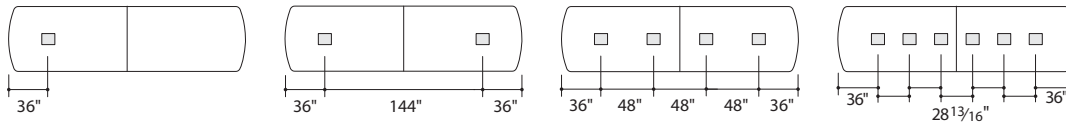

18'L x 60"W TAP Locations—Three piece top

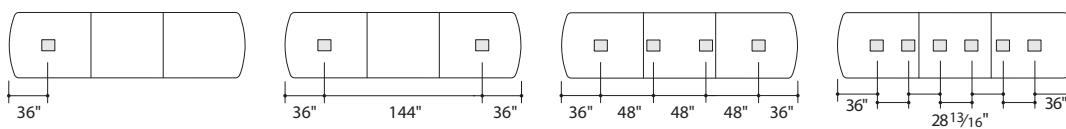

20'L x 48"W TAP Locations—Two piece top

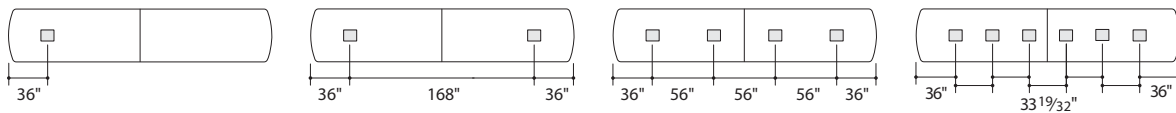

20'L x 48"W TAP Locations—Three piece top

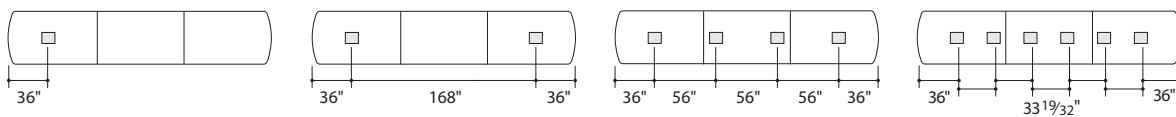

20'L x 60"W TAP Locations—Two piece top

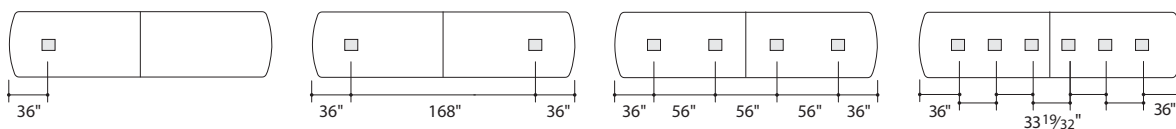

20'L x 60"W TAP Locations—Three piece top

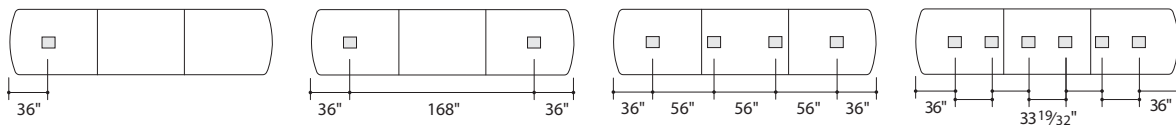

Host Collection

Soft Radiused Tables with Three Bases
DESIGN F/P DESIGN AND VECTA DESIGN TEAM

SIN 711.11



Tip: Prices shown include top, TAP(s), and slim bases.
► See base options for flared bases, page 204

Tip: Last digit of style number indicates number of TAP(s).

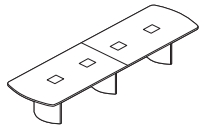
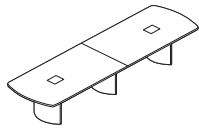
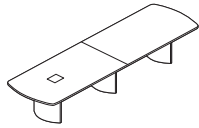
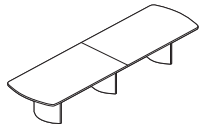
Tip: For tech corridor, 14'L tables have four long doors and four short doors.



Specification Information

Style Number	Finish	Base Prices		
				
		Flat Wood Edge:	Bullnose Wood Edge:	Horizon Wood Edge:

14'L x 48"W Two Piece Top

0 TAP				
HS1448S20	Grade 1 Laminate	\$10,539	\$10,689	\$12,852
	Grade 2 Laminate	\$10,747	\$10,897	\$13,060
	Grade 1 Veneer	\$11,688	\$11,838	\$14,001
	Grade 2 Veneer	\$12,754	\$12,904	\$15,067
1 TAP				
HS1448S21	Grade 1 Laminate	\$12,126	\$12,276	\$14,439
	Grade 2 Laminate	\$12,334	\$12,484	\$14,647
	Grade 1 Veneer	\$13,275	\$13,425	\$15,588
	Grade 2 Veneer	\$14,341	\$14,491	\$16,654
2 TAPS				
HS1448S22	Grade 1 Laminate	\$13,714	\$13,864	\$16,027
	Grade 2 Laminate	\$13,922	\$14,072	\$16,235
	Grade 1 Veneer	\$14,863	\$15,013	\$17,176
	Grade 2 Veneer	\$15,929	\$16,079	\$18,242
4 TAPS				
HS1448S24	Grade 1 Laminate	\$16,887	\$17,037	\$19,200
	Grade 2 Laminate	\$17,095	\$17,245	\$19,408
	Grade 1 Veneer	\$18,036	\$18,186	\$20,349
	Grade 2 Veneer	\$19,102	\$19,252	\$21,415

► Specification Information, continued on next page

Host Collection

Soft Radiused Tables with Three Bases *continued*
 DESIGN F/P DESIGN AND VECTA DESIGN TEAM

SIN 711.11

Tip: Prices shown include top, TAP(s), and slim bases.
 ▶ See base options for flared bases, page 204

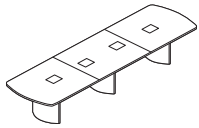
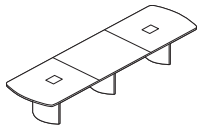
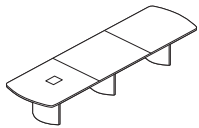
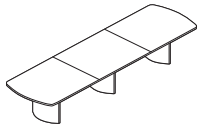

Tip: Last digit of style number indicates number of TAP(s).

Tip: For tech corridor, 14'L tables have four long doors and four short doors.



▶ Specification Information, continued from previous page

Specification Information

Style Number	Finish	Base Prices		
				
		Flat Wood Edge:	Bullnose Wood Edge:	Horizon Wood Edge:

14'L x 48"W Three Piece Top

0 TAP

HS1448S30	Grade 1 Laminate	\$10,919	\$11,069	\$13,232
	Grade 2 Laminate	\$11,127	\$11,277	\$13,440
	Grade 1 Veneer	\$12,068	\$12,218	\$14,381
	Grade 2 Veneer	\$13,134	\$13,284	\$15,447

1 TAP

HS1448S31	Grade 1 Laminate	\$12,507	\$12,657	\$14,820
	Grade 2 Laminate	\$12,715	\$12,865	\$15,028
	Grade 1 Veneer	\$13,656	\$13,806	\$15,969
	Grade 2 Veneer	\$14,722	\$14,872	\$17,035

2 TAPS

HS1448S32	Grade 1 Laminate	\$14,095	\$14,245	\$16,408
	Grade 2 Laminate	\$14,303	\$14,453	\$16,616
	Grade 1 Veneer	\$15,244	\$15,394	\$17,557
	Grade 2 Veneer	\$16,310	\$16,460	\$18,623

4 TAPS

HS1448S34	Grade 1 Laminate	\$17,267	\$17,417	\$19,580
	Grade 2 Laminate	\$17,475	\$17,625	\$19,788
	Grade 1 Veneer	\$18,416	\$18,566	\$20,729
	Grade 2 Veneer	\$19,482	\$19,632	\$21,795

▶ Specification Information, continued on next page

Host Collection

Soft Radiused Tables with Three Bases
DESIGN F/P DESIGN AND VECTA DESIGN TEAM

SIN 711.11

Tip: Prices shown include top, TAP(s), and slim bases.
▶ See base options for flared bases, page 204

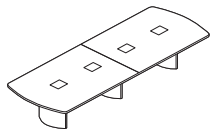
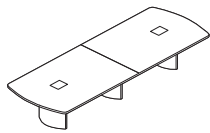
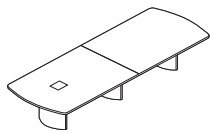
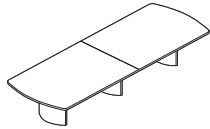

Tip: Last digit of style number indicates number of TAP(s).

Tip: For tech corridor, 14'L tables have four long doors and four short doors.



▶ Specification Information, continued from previous page

Specification Information

Style Number	Finish	Base Prices		
				
		Flat Wood Edge:	Bullnose Wood Edge:	Horizon Wood Edge:

14'L x 60"W Two Piece Top

0 TAP				
HS1460S20	Grade 1 Laminate	\$11,008	\$11,164	\$13,338
	Grade 2 Laminate	\$11,268	\$11,424	\$13,598
	Grade 1 Veneer	\$13,121	\$13,277	\$15,451
	Grade 2 Veneer	\$14,474	\$14,630	\$16,804
1 TAP				
HS1460S21	Grade 1 Laminate	\$12,596	\$12,752	\$14,926
	Grade 2 Laminate	\$12,856	\$13,012	\$15,186
	Grade 1 Veneer	\$14,709	\$14,865	\$17,039
	Grade 2 Veneer	\$16,062	\$16,218	\$18,392
2 TAPS				
HS1460S22	Grade 1 Laminate	\$14,182	\$14,338	\$16,512
	Grade 2 Laminate	\$14,442	\$14,598	\$16,772
	Grade 1 Veneer	\$16,295	\$16,451	\$18,625
	Grade 2 Veneer	\$17,648	\$17,804	\$19,978
4 TAPS				
HS1460S24	Grade 1 Laminate	\$17,358	\$17,514	\$19,688
	Grade 2 Laminate	\$17,618	\$17,774	\$19,948
	Grade 1 Veneer	\$19,471	\$19,627	\$21,801
	Grade 2 Veneer	\$20,824	\$20,980	\$23,154

▶ Specification Information, continued on next page

Host Collection

Soft Radiused Tables with Three Bases *continued*
 DESIGN F/P DESIGN AND VECTA DESIGN TEAM

SIN 711.11

Tip: Prices shown include top, TAP(s), and slim bases.
 ▶ See base options for flared bases, page 204

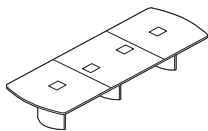
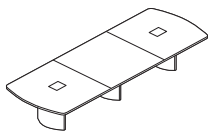
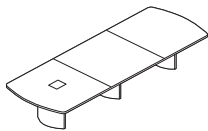
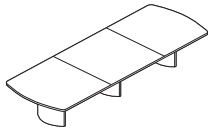

Tip: Last digit of style number indicates number of TAP(s).

Tip: For tech corridor, 14'L tables have four long doors and four short doors.



▶ Specification Information, continued from previous page

Specification Information

Style Number	Finish	Base Prices		
				
		Flat Wood Edge:	Bullnose Wood Edge:	Horizon Wood Edge:

14'L x 60"W Three Piece Top

0 TAP

HS1460S30	Grade 1 Laminate	\$11,388	\$11,544	\$13,718
	Grade 2 Laminate	\$11,648	\$11,804	\$13,978
	Grade 1 Veneer	\$13,501	\$13,657	\$15,831
	Grade 2 Veneer	\$14,854	\$15,010	\$17,184

1 TAP

HS1460S31	Grade 1 Laminate	\$12,976	\$13,132	\$15,306
	Grade 2 Laminate	\$13,236	\$13,392	\$15,566
	Grade 1 Veneer	\$15,089	\$15,245	\$17,419
	Grade 2 Veneer	\$16,442	\$16,598	\$18,772

2 TAPS

HS1460S32	Grade 1 Laminate	\$14,563	\$14,719	\$16,893
	Grade 2 Laminate	\$14,823	\$14,979	\$17,153
	Grade 1 Veneer	\$16,676	\$16,832	\$19,006
	Grade 2 Veneer	\$18,029	\$18,185	\$20,359

4 TAPS

HS1460S34	Grade 1 Laminate	\$17,738	\$17,894	\$20,068
	Grade 2 Laminate	\$17,998	\$18,154	\$20,328
	Grade 1 Veneer	\$19,851	\$20,007	\$22,181
	Grade 2 Veneer	\$21,204	\$21,360	\$23,534

▶ Specification Information, continued on next page

Host Collection

Soft Radiused Tables with Three Bases
DESIGN F/P DESIGN AND VECTA DESIGN TEAM

SIN 711.11

Tip: Prices shown include top, TAP(s), and slim bases.
▶ See base options for flared bases, page 204

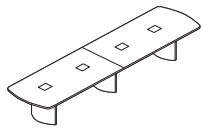
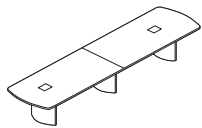
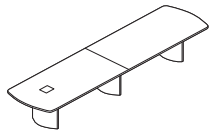
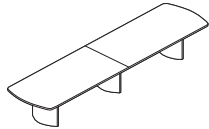

Tip: Last digit of style number indicates number of TAP(s).

Tip: For tech corridor, 16'L tables have eight long doors and four short doors.



▶ Specification Information, continued from previous page

Specification Information

Style Number	Finish	Base Prices		
				
		Flat Wood Edge:	Bullnose Wood Edge:	Horizon Wood Edge:

16'L x 48"W Two Piece Top

0 TAP				
HS1648S20	Grade 1 Laminate	\$10,970	\$11,133	\$13,323
	Grade 2 Laminate	\$11,207	\$11,370	\$13,560
	Grade 1 Veneer	\$12,114	\$12,277	\$14,467
	Grade 2 Veneer	\$13,330	\$13,493	\$15,683
1 TAP				
HS1648S21	Grade 1 Laminate	\$12,556	\$12,719	\$14,909
	Grade 2 Laminate	\$12,793	\$12,956	\$15,146
	Grade 1 Veneer	\$13,700	\$13,863	\$16,053
	Grade 2 Veneer	\$14,916	\$15,079	\$17,269
2 TAPS				
HS1648S22	Grade 1 Laminate	\$14,144	\$14,307	\$16,497
	Grade 2 Laminate	\$14,381	\$14,544	\$16,734
	Grade 1 Veneer	\$15,288	\$15,451	\$17,641
	Grade 2 Veneer	\$16,504	\$16,667	\$18,857
4 TAPS				
HS1648S24	Grade 1 Laminate	\$17,318	\$17,481	\$19,671
	Grade 2 Laminate	\$17,555	\$17,718	\$19,908
	Grade 1 Veneer	\$18,462	\$18,625	\$20,815
	Grade 2 Veneer	\$19,678	\$19,841	\$22,031

▶ Specification Information, continued on next page

Host Collection

Soft Radiused Tables with Three Bases *continued*
 DESIGN F/P DESIGN AND VECTA DESIGN TEAM

SIN 711.11

Tip: Prices shown include top, TAP(s), and slim bases.
 ▶ See base options for flared bases, page 204

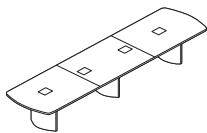
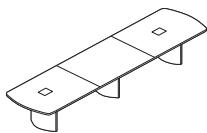
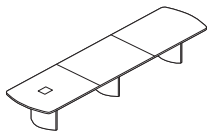
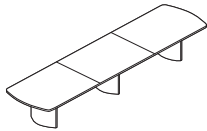

Tip: Last digit of style number indicates number of TAP(s).

Tip: For tech corridor, 16'L tables have eight long doors and four short doors.



▶ Specification Information, continued from previous page

Specification Information

Style Number	Finish	Base Prices		
				
		Flat Wood Edge:	Bullnose Wood Edge:	Horizon Wood Edge:

16'L x 48"W Three Piece Top

0 TAP

HS1648S30	Grade 1 Laminate	\$11,351	\$11,514	\$13,704
	Grade 2 Laminate	\$11,588	\$11,751	\$13,941
	Grade 1 Veneer	\$12,495	\$12,658	\$14,848
	Grade 2 Veneer	\$13,711	\$13,874	\$16,064

1 TAP

HS1648S31	Grade 1 Laminate	\$12,938	\$13,101	\$15,291
	Grade 2 Laminate	\$13,175	\$13,338	\$15,528
	Grade 1 Veneer	\$14,082	\$14,245	\$16,435
	Grade 2 Veneer	\$15,298	\$15,461	\$17,651

2 TAPS

HS1648S32	Grade 1 Laminate	\$14,522	\$14,685	\$16,875
	Grade 2 Laminate	\$14,759	\$14,922	\$17,112
	Grade 1 Veneer	\$15,666	\$15,829	\$18,019
	Grade 2 Veneer	\$16,882	\$17,045	\$19,235

4 TAPS

HS1648S34	Grade 1 Laminate	\$17,698	\$17,861	\$20,051
	Grade 2 Laminate	\$17,935	\$18,098	\$20,288
	Grade 1 Veneer	\$18,842	\$19,005	\$21,195
	Grade 2 Veneer	\$20,058	\$20,221	\$22,411

▶ Specification Information, continued on next page

Host Collection

Soft Radiused Tables with Three Bases
DESIGN F/P DESIGN AND VECTA DESIGN TEAM

SIN 711.11

Tip: Prices shown include top, TAP(s), and slim bases.
▶ See base options for flared bases, page 204

Tip: Last digit of style number indicates number of TAP(s).

Tip: For tech corridor, 16'L tables have eight long doors and four short doors.

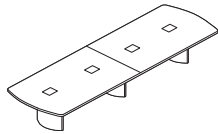
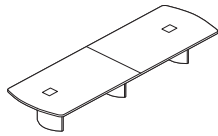
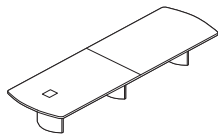
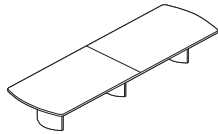

▶ Specification Information, continued from previous page

Specification Information

Style Number	Finish	Base Prices		
		Flat Wood Edge:	Bullnose Wood Edge:	Horizon Wood Edge:

16'L x 60"W Two Piece Top

0 TAP				
HS1660S20	Grade 1 Laminate	\$11,438	\$11,610	\$13,835
	Grade 2 Laminate	\$11,733	\$11,905	\$14,130
	Grade 1 Veneer	\$13,546	\$13,718	\$15,943
	Grade 2 Veneer	\$15,085	\$15,257	\$17,482
1 TAP				
HS1660S21	Grade 1 Laminate	\$13,025	\$13,197	\$15,422
	Grade 2 Laminate	\$13,320	\$13,492	\$15,717
	Grade 1 Veneer	\$15,133	\$15,305	\$17,530
	Grade 2 Veneer	\$16,672	\$16,844	\$19,069
2 TAPS				
HS1660S22	Grade 1 Laminate	\$14,613	\$14,785	\$17,010
	Grade 2 Laminate	\$14,908	\$15,080	\$17,305
	Grade 1 Veneer	\$16,721	\$16,893	\$19,118
	Grade 2 Veneer	\$18,260	\$18,432	\$20,657
4 TAPS				
HS1660S24	Grade 1 Laminate	\$17,786	\$17,958	\$20,183
	Grade 2 Laminate	\$18,081	\$18,253	\$20,478
	Grade 1 Veneer	\$19,894	\$20,066	\$22,291
	Grade 2 Veneer	\$21,433	\$21,605	\$23,830

▶ Specification Information, continued on next page

Host Collection

Soft Radiused Tables with Three Bases *continued*
 DESIGN F/P DESIGN AND VECTA DESIGN TEAM

SIN 711.11

Tip: Prices shown include top, TAP(s), and slim bases.
 ▶ See base options for flared bases, page 204

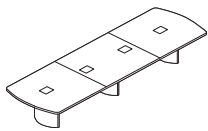
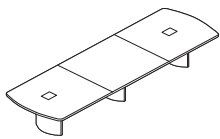
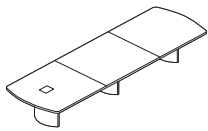
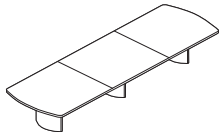

Tip: Last digit of style number indicates number of TAP(s).

Tip: For tech corridor, 16'L tables have eight long doors and four short doors.



▶ Specification Information, continued from previous page

Specification Information

Style Number	Finish	Base Prices		
				
		Flat Wood Edge:	Bullnose Wood Edge:	Horizon Wood Edge:

16'L x 60"W Three Piece Top

0 TAP

HS1660S30	Grade 1 Laminate	\$11,818	\$11,990	\$14,215
	Grade 2 Laminate	\$12,113	\$12,285	\$14,510
	Grade 1 Veneer	\$13,926	\$14,098	\$16,323
	Grade 2 Veneer	\$15,465	\$15,637	\$17,862

1 TAP

HS1660S31	Grade 1 Laminate	\$13,406	\$13,578	\$15,803
	Grade 2 Laminate	\$13,701	\$13,873	\$16,098
	Grade 1 Veneer	\$15,514	\$15,686	\$17,911
	Grade 2 Veneer	\$17,053	\$17,225	\$19,450

2 TAPS

HS1660S32	Grade 1 Laminate	\$14,993	\$15,165	\$17,390
	Grade 2 Laminate	\$15,288	\$15,460	\$17,685
	Grade 1 Veneer	\$17,101	\$17,273	\$19,498
	Grade 2 Veneer	\$18,640	\$18,812	\$21,037

4 TAPS

HS1660S34	Grade 1 Laminate	\$18,166	\$18,338	\$20,563
	Grade 2 Laminate	\$18,461	\$18,633	\$20,858
	Grade 1 Veneer	\$20,274	\$20,446	\$22,671
	Grade 2 Veneer	\$21,813	\$21,985	\$24,210

▶ Specification Information, continued on next page

Host Collection

Soft Radiused Tables with Three Bases
DESIGN F/P DESIGN AND VECTA DESIGN TEAM

SIN 711.11

Tip: Prices shown include top, TAP(s), and slim bases.
▶ See base options for flared bases, page 204

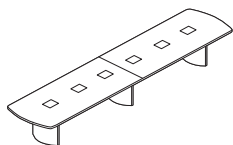
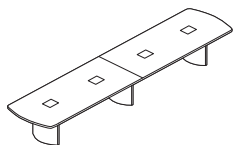
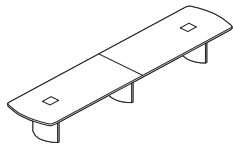
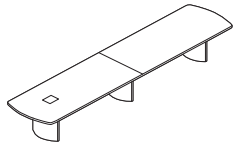
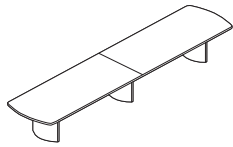

Tip: Last digit of style number indicates number of TAP(s).

Tip: For tech corridor, 18'L tables have eight long doors and four short doors.



▶ Specification Information, continued from previous page

Specification Information

Style Number	Finish	Base Prices		
				
		Flat Wood Edge:	Bullnose Wood Edge:	Horizon Wood Edge:

18'L x 48"W Two Piece Top

0 TAP

HS1848S20	Grade 1 Laminate	\$11,651	\$11,830	\$14,060
	Grade 2 Laminate	\$11,918	\$12,097	\$14,327
	Grade 1 Veneer	\$13,112	\$13,291	\$15,521
	Grade 2 Veneer	\$14,481	\$14,660	\$16,890

1 TAP

HS1848S21	Grade 1 Laminate	\$13,238	\$13,417	\$15,647
	Grade 2 Laminate	\$13,505	\$13,684	\$15,914
	Grade 1 Veneer	\$14,699	\$14,878	\$17,108
	Grade 2 Veneer	\$16,068	\$16,247	\$18,477

2 TAPS

HS1848S22	Grade 1 Laminate	\$14,826	\$15,005	\$17,235
	Grade 2 Laminate	\$15,093	\$15,272	\$17,502
	Grade 1 Veneer	\$16,287	\$16,466	\$18,696
	Grade 2 Veneer	\$17,656	\$17,835	\$20,065

4 TAPS

HS1848S24	Grade 1 Laminate	\$17,999	\$18,178	\$20,408
	Grade 2 Laminate	\$18,266	\$18,445	\$20,675
	Grade 1 Veneer	\$19,460	\$19,639	\$21,869
	Grade 2 Veneer	\$20,829	\$21,008	\$23,238

6 TAPS

HS1848S26	Grade 1 Laminate	\$21,175	\$21,354	\$23,584
	Grade 2 Laminate	\$21,442	\$21,621	\$23,851
	Grade 1 Veneer	\$22,636	\$22,815	\$25,045
	Grade 2 Veneer	\$24,005	\$24,184	\$26,414

▶ Specification Information, continued on next page

Host Collection

Soft Radiused Tables with Three Bases *continued*
 DESIGN F/P DESIGN AND VECTA DESIGN TEAM

SIN 711.11

Tip: Prices shown include top, TAP(s), and slim bases.
 ▶ See base options for flared bases, page 204

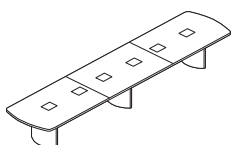
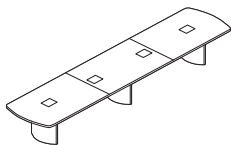
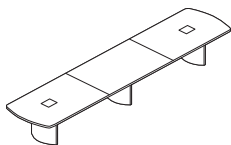
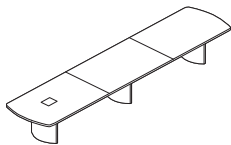
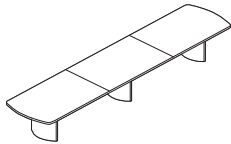

Tip: Last digit of style number indicates number of TAP(s).

Tip: For tech corridor, 18'L tables have eight long doors and four short doors.



▶ Specification Information, continued from previous page

Specification Information

Style Number	Finish	Base Prices		
				
		Flat Wood Edge:	Bullnose Wood Edge:	Horizon Wood Edge:

18'L x 48"W Three Piece Top

0 TAP

Style Number	Finish	Flat Wood Edge	Bullnose Wood Edge	Horizon Wood Edge
HS1848S30	Grade 1 Laminate	\$12,033	\$12,212	\$14,442
	Grade 2 Laminate	\$12,300	\$12,479	\$14,709
	Grade 1 Veneer	\$13,494	\$13,673	\$15,903
	Grade 2 Veneer	\$14,863	\$15,042	\$17,272

1 TAP

Style Number	Finish	Flat Wood Edge	Bullnose Wood Edge	Horizon Wood Edge
HS1848S31	Grade 1 Laminate	\$13,617	\$13,796	\$16,026
	Grade 2 Laminate	\$13,884	\$14,063	\$16,293
	Grade 1 Veneer	\$15,078	\$15,257	\$17,487
	Grade 2 Veneer	\$16,447	\$16,626	\$18,856

2 TAPS

Style Number	Finish	Flat Wood Edge	Bullnose Wood Edge	Horizon Wood Edge
HS1848S32	Grade 1 Laminate	\$15,204	\$15,383	\$17,613
	Grade 2 Laminate	\$15,471	\$15,650	\$17,880
	Grade 1 Veneer	\$16,665	\$16,844	\$19,074
	Grade 2 Veneer	\$18,034	\$18,213	\$20,443

4 TAPS

Style Number	Finish	Flat Wood Edge	Bullnose Wood Edge	Horizon Wood Edge
HS1848S34	Grade 1 Laminate	\$18,379	\$18,558	\$20,788
	Grade 2 Laminate	\$18,646	\$18,825	\$21,055
	Grade 1 Veneer	\$19,840	\$20,019	\$22,249
	Grade 2 Veneer	\$21,209	\$21,388	\$23,618

6 TAPS

Style Number	Finish	Flat Wood Edge	Bullnose Wood Edge	Horizon Wood Edge
HS1848S36	Grade 1 Laminate	\$21,554	\$21,733	\$23,963
	Grade 2 Laminate	\$21,821	\$22,000	\$24,230
	Grade 1 Veneer	\$23,015	\$23,194	\$25,424
	Grade 2 Veneer	\$24,384	\$24,563	\$26,793

▶ Specification Information, continued on next page

Host Collection

Soft Radiused Tables with Three Bases
DESIGN F/P DESIGN AND VECTA DESIGN TEAM

SIN 711.11

Tip: Prices shown include top, TAP(s), and slim bases.
▶ See base options for flared bases, page 204

Tip: Last digit of style number indicates number of TAP(s).

Tip: For tech corridor, 18'L tables have eight long doors and four short doors.

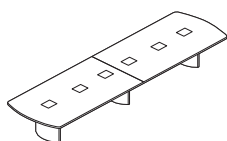
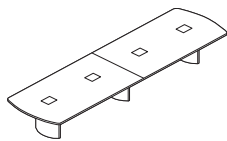
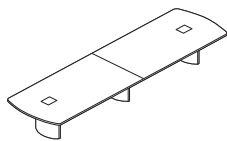
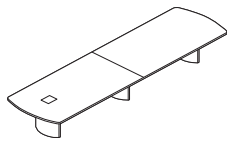
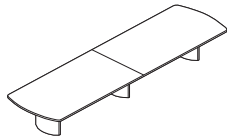

▶ Specification Information, continued from previous page

Specification Information

Style Number	Finish	Base Prices		
		Flat Wood Edge:	Bullnose Wood Edge:	Horizon Wood Edge:

18'L x 60"W Two Piece Top

0 TAP				
HS1860S20	Grade 1 Laminate	\$11,901	\$12,087	\$14,350
	Grade 2 Laminate	\$12,234	\$12,420	\$14,683
	Grade 1 Veneer	\$14,720	\$14,906	\$17,169
	Grade 2 Veneer	\$16,465	\$16,651	\$18,914
1 TAP				
HS1860S21	Grade 1 Laminate	\$13,490	\$13,676	\$15,939
	Grade 2 Laminate	\$13,823	\$14,009	\$16,272
	Grade 1 Veneer	\$16,309	\$16,495	\$18,758
	Grade 2 Veneer	\$18,054	\$18,240	\$20,503
2 TAPS				
HS1860S22	Grade 1 Laminate	\$15,078	\$15,264	\$17,527
	Grade 2 Laminate	\$15,411	\$15,597	\$17,860
	Grade 1 Veneer	\$17,897	\$18,083	\$20,346
	Grade 2 Veneer	\$19,642	\$19,828	\$22,091
4 TAPS				
HS1860S24	Grade 1 Laminate	\$18,252	\$18,438	\$20,701
	Grade 2 Laminate	\$18,585	\$18,771	\$21,034
	Grade 1 Veneer	\$21,071	\$21,257	\$23,520
	Grade 2 Veneer	\$22,816	\$23,002	\$25,265
6 TAPS				
HS1860S26	Grade 1 Laminate	\$21,426	\$21,612	\$23,875
	Grade 2 Laminate	\$21,759	\$21,945	\$24,208
	Grade 1 Veneer	\$24,245	\$24,431	\$26,694
	Grade 2 Veneer	\$25,990	\$26,176	\$28,439

▶ Specification Information, continued on next page

Host Collection Soft Radiused Tables with Three Bases *continued*

DESIGN F/P DESIGN AND VECTA DESIGN TEAM

SIN 711.11

Tip: Prices shown include top, TAP(s), and slim bases.
 ▶ See base options for flared bases, page 204

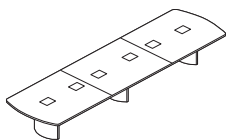
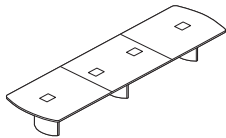
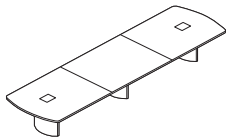
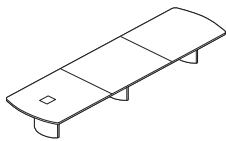
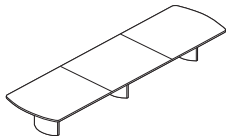

Tip: Last digit of style number indicates number of TAP(s).

Tip: For tech corridor, 18'L tables have eight long doors and four short doors.



▶ Specification Information, continued from previous page

Specification Information

Style Number	Finish	Base Prices		
				
		Flat Wood Edge:	Bullnose Wood Edge:	Horizon Wood Edge:

18'L x 60"W Three Piece Top

0 TAP

Style Number	Finish	Flat Wood Edge	Bullnose Wood Edge	Horizon Wood Edge
HS1860S30	Grade 1 Laminate	\$12,283	\$12,469	\$14,732
	Grade 2 Laminate	\$12,616	\$12,802	\$15,065
	Grade 1 Veneer	\$15,102	\$15,288	\$17,551
	Grade 2 Veneer	\$16,847	\$17,033	\$19,296

1 TAP

Style Number	Finish	Flat Wood Edge	Bullnose Wood Edge	Horizon Wood Edge
HS1860S31	Grade 1 Laminate	\$13,871	\$14,057	\$16,320
	Grade 2 Laminate	\$14,204	\$14,390	\$16,653
	Grade 1 Veneer	\$16,690	\$16,876	\$19,139
	Grade 2 Veneer	\$18,435	\$18,621	\$20,884

2 TAPS

Style Number	Finish	Flat Wood Edge	Bullnose Wood Edge	Horizon Wood Edge
HS1860S32	Grade 1 Laminate	\$15,457	\$15,643	\$17,906
	Grade 2 Laminate	\$15,790	\$15,976	\$18,239
	Grade 1 Veneer	\$18,276	\$18,462	\$20,725
	Grade 2 Veneer	\$20,021	\$20,207	\$22,470

4 TAPS

Style Number	Finish	Flat Wood Edge	Bullnose Wood Edge	Horizon Wood Edge
HS1860S34	Grade 1 Laminate	\$18,633	\$18,819	\$21,082
	Grade 2 Laminate	\$18,966	\$19,152	\$21,415
	Grade 1 Veneer	\$21,452	\$21,638	\$23,901
	Grade 2 Veneer	\$23,197	\$23,383	\$25,646

6 TAPS

Style Number	Finish	Flat Wood Edge	Bullnose Wood Edge	Horizon Wood Edge
HS1860S36	Grade 1 Laminate	\$21,807	\$21,993	\$24,256
	Grade 2 Laminate	\$22,140	\$22,326	\$24,589
	Grade 1 Veneer	\$24,626	\$24,812	\$27,075
	Grade 2 Veneer	\$26,371	\$26,557	\$28,820

▶ Specification Information, continued on next page

Host Collection

Soft Radiused Tables with Three Bases
DESIGN F/P DESIGN AND VECTA DESIGN TEAM

SIN 711.11

Tip: Prices shown include top, TAP(s), and slim bases.
▶ See base options for flared bases, page 204

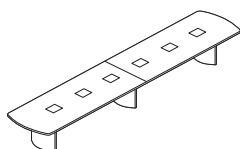
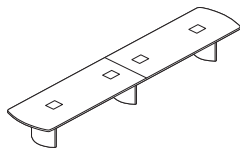
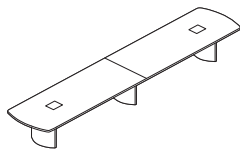
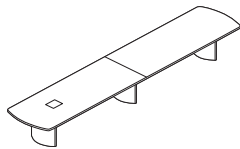
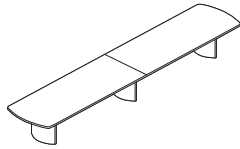

Tip: Last digit of style number indicates number of TAP(s).

Tip: For tech corridor, 20'L tables have eight long doors and four short doors.



▶ Specification Information, continued from previous page

Specification Information

Style Number	Finish	Base Prices		
				
		Flat Wood Edge:	Bullnose Wood Edge:	Horizon Wood Edge:

20'L x 48"W Two Piece Top

0 TAP				
HS2048S20	Grade 1 Laminate	\$12,081	\$12,277	\$14,656
	Grade 2 Laminate	\$12,376	\$12,572	\$14,951
	Grade 1 Veneer	\$13,539	\$13,735	\$16,114
	Grade 2 Veneer	\$15,058	\$15,254	\$17,633
1 TAP				
HS2048S21	Grade 1 Laminate	\$13,669	\$13,865	\$16,244
	Grade 2 Laminate	\$13,964	\$14,160	\$16,539
	Grade 1 Veneer	\$15,127	\$15,323	\$17,702
	Grade 2 Veneer	\$16,646	\$16,842	\$19,221
2 TAPS				
HS2048S22	Grade 1 Laminate	\$15,255	\$15,451	\$17,830
	Grade 2 Laminate	\$15,550	\$15,746	\$18,125
	Grade 1 Veneer	\$16,713	\$16,909	\$19,288
	Grade 2 Veneer	\$18,232	\$18,428	\$20,807
4 TAPS				
HS2048S24	Grade 1 Laminate	\$18,431	\$18,627	\$21,006
	Grade 2 Laminate	\$18,726	\$18,922	\$21,301
	Grade 1 Veneer	\$19,889	\$20,085	\$22,464
	Grade 2 Veneer	\$21,408	\$21,604	\$23,983
6 TAPS				
HS2048S26	Grade 1 Laminate	\$21,604	\$21,800	\$24,179
	Grade 2 Laminate	\$21,899	\$22,095	\$24,474
	Grade 1 Veneer	\$23,062	\$23,258	\$25,637
	Grade 2 Veneer	\$24,581	\$24,777	\$27,156

▶ Specification Information, continued on next page

Host Collection

Soft Radiused Tables with Three Bases *continued*
 DESIGN F/P DESIGN AND VECTA DESIGN TEAM

SIN 711.11

Tip: Prices shown include top, TAP(s), and slim bases.
 ▶ See base options for flared bases, page 204

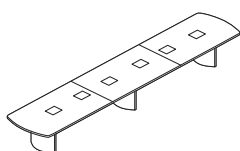
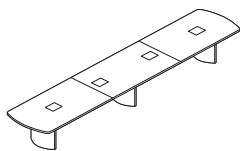
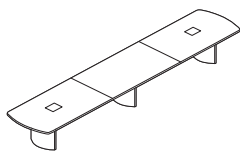
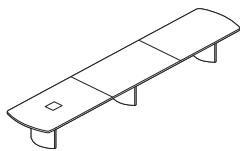
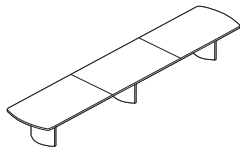

Tip: Last digit of style number indicates number of TAP(s).

Tip: For tech corridor, 20'L tables have eight long doors and four short doors.



▶ Specification Information, continued from previous page

Specification Information

Style Number	Finish	Base Prices		
				
		Flat Wood Edge:	Bullnose Wood Edge:	Horizon Wood Edge:

20'L x 48''W Three Piece Top

0 TAP

Style Number	Finish	Flat Wood Edge	Bullnose Wood Edge	Horizon Wood Edge
HS2048S30	Grade 1 Laminate	\$12,460	\$12,656	\$15,035
	Grade 2 Laminate	\$12,755	\$12,951	\$15,330
	Grade 1 Veneer	\$13,918	\$14,114	\$16,493
	Grade 2 Veneer	\$15,437	\$15,633	\$18,012

1 TAP

Style Number	Finish	Flat Wood Edge	Bullnose Wood Edge	Horizon Wood Edge
HS2048S31	Grade 1 Laminate	\$14,048	\$14,244	\$16,623
	Grade 2 Laminate	\$14,343	\$14,539	\$16,918
	Grade 1 Veneer	\$15,506	\$15,702	\$18,081
	Grade 2 Veneer	\$17,025	\$17,221	\$19,600

2 TAPS

Style Number	Finish	Flat Wood Edge	Bullnose Wood Edge	Horizon Wood Edge
HS2048S32	Grade 1 Laminate	\$15,636	\$15,832	\$18,211
	Grade 2 Laminate	\$15,931	\$16,127	\$18,506
	Grade 1 Veneer	\$17,094	\$17,290	\$19,669
	Grade 2 Veneer	\$18,613	\$18,809	\$21,188

4 TAPS

Style Number	Finish	Flat Wood Edge	Bullnose Wood Edge	Horizon Wood Edge
HS2048S34	Grade 1 Laminate	\$18,811	\$19,007	\$21,384
	Grade 2 Laminate	\$19,106	\$19,302	\$21,679
	Grade 1 Veneer	\$20,269	\$20,465	\$22,842
	Grade 2 Veneer	\$21,788	\$21,984	\$24,361

6 TAPS

Style Number	Finish	Flat Wood Edge	Bullnose Wood Edge	Horizon Wood Edge
HS2048S36	Grade 1 Laminate	\$21,984	\$22,180	\$24,557
	Grade 2 Laminate	\$22,279	\$22,475	\$24,852
	Grade 1 Veneer	\$23,442	\$23,638	\$26,015
	Grade 2 Veneer	\$24,961	\$25,157	\$27,534

▶ Specification Information, continued on next page

Host Collection

Soft Radiused Tables with Three Bases
DESIGN F/P DESIGN AND VECTA DESIGN TEAM

SIN 711.11

Tip: Prices shown include top, TAP(s), and slim bases.
▶ See base options for flared bases, page 204

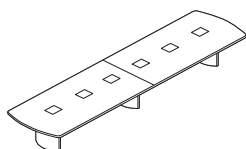
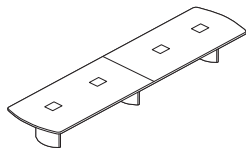
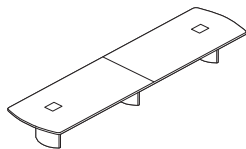
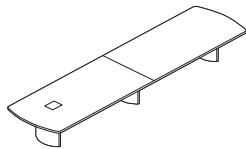
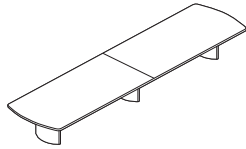

Tip: Last digit of style number indicates number of TAP(s).

Tip: For tech corridor, 20'L tables have eight long doors and four short doors.



▶ Specification Information, continued from previous page

Specification Information

Style Number	Finish	Base Prices		
				
		Flat Wood Edge:	Bullnose Wood Edge:	Horizon Wood Edge:

20'L x 60" W Two Piece Top

0 TAP

HS2060S20	Grade 1 Laminate	\$12,333	\$12,537	\$14,961
	Grade 2 Laminate	\$12,703	\$12,907	\$15,331
	Grade 1 Veneer	\$15,149	\$15,353	\$17,777
	Grade 2 Veneer	\$17,077	\$17,281	\$19,705

1 TAP

HS2060S21	Grade 1 Laminate	\$13,919	\$14,123	\$16,547
	Grade 2 Laminate	\$14,289	\$14,493	\$16,917
	Grade 1 Veneer	\$16,735	\$16,939	\$19,363
	Grade 2 Veneer	\$18,663	\$18,867	\$21,291

2 TAPS

HS2060S22	Grade 1 Laminate	\$15,507	\$15,711	\$18,135
	Grade 2 Laminate	\$15,877	\$16,081	\$18,505
	Grade 1 Veneer	\$18,323	\$18,527	\$20,951
	Grade 2 Veneer	\$20,251	\$20,455	\$22,879

4 TAPS

HS2060S24	Grade 1 Laminate	\$18,680	\$18,884	\$21,308
	Grade 2 Laminate	\$19,050	\$19,254	\$21,678
	Grade 1 Veneer	\$21,496	\$21,700	\$24,124
	Grade 2 Veneer	\$23,424	\$23,628	\$26,052

6 TAPS

HS2060S26	Grade 1 Laminate	\$21,854	\$22,058	\$24,482
	Grade 2 Laminate	\$22,224	\$22,428	\$24,852
	Grade 1 Veneer	\$24,670	\$24,874	\$27,298
	Grade 2 Veneer	\$26,598	\$26,802	\$29,226

▶ Specification Information, continued on next page

Host Collection

Soft Radiused Tables with Three Bases *continued*
 DESIGN F/P DESIGN AND VECTA DESIGN TEAM

SIN 711.11

Tip: Prices shown include top, TAP(s), and slim bases.
 ▶ See base options for flared bases, page 204

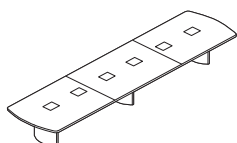
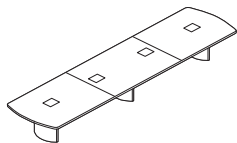
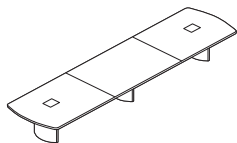
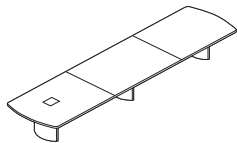
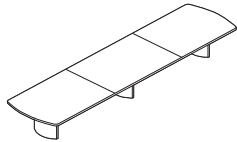

Tip: Last digit of style number indicates number of TAP(s).

Tip: For tech corridor, 20'L tables have eight long doors and four short doors.



▶ Specification Information, continued from previous page

Specification Information

Style Number	Finish	Base Prices		
				
		Flat Wood Edge:	Bullnose Wood Edge:	Horizon Wood Edge:

20'L x 60"W Three Piece Top

0 TAP

Style Number	Finish	Flat Wood Edge	Bullnose Wood Edge	Horizon Wood Edge
HS2060S30	Grade 1 Laminate	\$12,711	\$12,915	\$15,339
	Grade 2 Laminate	\$13,081	\$13,285	\$15,709
	Grade 1 Veneer	\$15,527	\$15,731	\$18,155
	Grade 2 Veneer	\$17,455	\$17,659	\$20,083

1 TAP

Style Number	Finish	Flat Wood Edge	Bullnose Wood Edge	Horizon Wood Edge
HS2060S31	Grade 1 Laminate	\$14,298	\$14,502	\$16,926
	Grade 2 Laminate	\$14,668	\$14,872	\$17,296
	Grade 1 Veneer	\$17,114	\$17,318	\$19,742
	Grade 2 Veneer	\$19,042	\$19,246	\$21,670

2 TAPS

Style Number	Finish	Flat Wood Edge	Bullnose Wood Edge	Horizon Wood Edge
HS2060S32	Grade 1 Laminate	\$15,887	\$16,091	\$18,515
	Grade 2 Laminate	\$16,257	\$16,461	\$18,885
	Grade 1 Veneer	\$18,703	\$18,907	\$21,331
	Grade 2 Veneer	\$20,631	\$20,835	\$23,259

4 TAPS

Style Number	Finish	Flat Wood Edge	Bullnose Wood Edge	Horizon Wood Edge
HS2060S34	Grade 1 Laminate	\$19,061	\$19,265	\$21,689
	Grade 2 Laminate	\$19,431	\$19,635	\$22,059
	Grade 1 Veneer	\$21,877	\$22,081	\$24,505
	Grade 2 Veneer	\$23,805	\$24,009	\$26,433

6 TAPS

Style Number	Finish	Flat Wood Edge	Bullnose Wood Edge	Horizon Wood Edge
HS2060S36	Grade 1 Laminate	\$22,235	\$22,439	\$24,863
	Grade 2 Laminate	\$22,605	\$22,809	\$25,233
	Grade 1 Veneer	\$25,051	\$25,255	\$27,679
	Grade 2 Veneer	\$26,979	\$27,183	\$29,607

Coalesse

Host Collection

Soft Radiused Tables with Three Bases
DESIGN F/P DESIGN AND VECTA DESIGN TEAM

SIN 711.11

Host Collection Racetrack Tables with Two Bases

DESIGN F/P DESIGN AND VECTA DESIGN TEAM

SIN 711.11

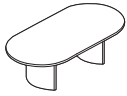

Tip: Shipped knocked down.

Tip: Grain direction for wood-grain laminate runs the length of the table.

Tip: Clips are provided with table: one clip per foot of table length.

Tip: The wood edge on a table top with woodgrain laminate may not match the top.

Tip: You must send a sample of reasonable size for Stain-to-Match.

Standard Includes		Required to Specify
<ul style="list-style-type: none"> ▶ Need help? Product details, see <i>Coalesse Tables, Storage, and Accessories Specification Guide</i> 	<ul style="list-style-type: none"> • Top: 1¼" particle board core with laminate • Flat wood edge • TAP(s), if selected: 10"W x 12"L opening(s) trimmed with a flat solid wood profile and with brushed anodized aluminum TAP doors • Tech corridor: two aluminum beams for top support provide tracks for hinged aluminum doors that clip shut: satin anodized finish • Universal clip: black plastic • Two 27"W bases: wood veneer on MDF with aluminum universal bracket • Concealed leveling glides: non-marring, black plastic 	<ol style="list-style-type: none"> 1 Style number 2 Base selection (see below) and wood color number for base 3 Laminate color number for table top, if selected 4 Wood color number for wood edge <ul style="list-style-type: none"> ▶ See <i>Veneer Matrix</i>, page 365 5 Door color number for storage tray or TAP door, if selected: <ul style="list-style-type: none"> - 8044 Black - 8047 Silver 6 Options, if selected (see below) <ul style="list-style-type: none"> ▶ See <i>Surface Materials</i>, page 350.

Options	Price	Required to Specify
Surface Materials <ul style="list-style-type: none"> • Top • Grade 2 laminate • Grade 1 wood veneer • Grade 2 wood veneer • Stain-to-Match 	<ul style="list-style-type: none"> Prices at right Prices at right Prices at right No cost 	<ul style="list-style-type: none"> Specify with <i>Grade 2 laminate</i> and select color number. Specify with <i>Grade 1 wood veneer</i> and select color number. Specify with <i>Grade 2 wood veneer</i> and select color number. Specify with <i>Stain-to-Match</i>. ▶ Page 385

Edges	Wood	Price	Required to Specify
	<ul style="list-style-type: none"> • Bullnose wood edge • Beveled wood edge • Horizon wood edge 	<ul style="list-style-type: none"> Prices at right Prices at right Prices at right 	<ul style="list-style-type: none"> Specify with <i>bullnose wood edge</i>. Specify with <i>beveled wood edge</i>. Specify with <i>Horizon wood edge</i>.

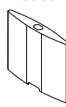
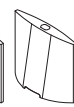
Bases	Options	Price	Required to Specify
 Slim  Flared	<ul style="list-style-type: none"> • Two slim bases • One slim and one flared base • Two flared bases 	<ul style="list-style-type: none"> No cost +\$ 827 +\$1656 	<ul style="list-style-type: none"> Specify with <i>two slim bases</i>. Specify with <i>one slim base</i> and one flared base. Specify with <i>two flared bases</i>.

Tip: 96"L tables available with zero, one, or two TAP(s). 10'L and 12'L tables available with zero, one, two, or three TAP(s).

Tip: In addition to the data and audio/video AAPs available from Coalesse, other styles of AAPs are available through Extron Electronics. For an Extron dealer, call 1-800-633-9876.

Tip: See TAP options for electrical systems and faceplate list.

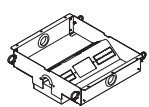
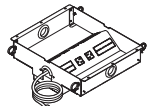
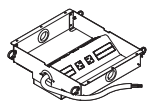
TAP Electrical System with Faceplate Options	Options	Price	Required to Specify
 Field Wired  Cord and Plug  Hardwired	<ul style="list-style-type: none"> • Field-wired tray (no electrical) <ul style="list-style-type: none"> - PAFW field-wired tray (no electrical) with blank AAPs - PDFW field-wired tray (no electrical) with two data AAPs - PVFW field-wired tray (no electrical) with two of each video/audio and data AAPs • Cord and plug tray (10' cord) <ul style="list-style-type: none"> - PACP cord and plug tray with outlets and blank AAPs - PDCP cord and plug tray with outlets and two data AAPs - PAVC cord and plug tray with outlets and two of each video/audio and data AAPs • Hard-wired tray (6' conduit) <ul style="list-style-type: none"> - PAHW hard-wired tray with outlets and blank AAPs - PDHW hard-wired tray with outlets and two data AAPs - PAVH hard-wired tray with outlets and two of each video/audio and data AAPs 	<ul style="list-style-type: none"> No cost No cost No cost 	<ul style="list-style-type: none"> Specify with <i>power data</i>, and select TAP type and TAP door color number. Specify with <i>power data</i>, and select TAP type and TAP door color number. Specify with <i>power data</i>, and select TAP type and TAP door color number.

▶ Options, continued on next page

Host Collection

Racetrack Tables with Two Bases
DESIGN F/P DESIGN AND VECTA DESIGN TEAM

SIN 711.11

► Options, continued from previous page

Tip: For single TAP style numbers, the modular system tray is not available. Specify the hardwired tray option.

Tip: If the specified table has multiple TAP(s), any one TAP can be replaced with a storage tray.

Tip: Wood veneer doors for storage tray and TAP will always be cross grain.

Tip: Connectrac must be the same wiring schematic as the table.

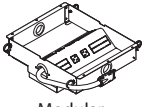
Options	Price	Required to Specify
TAP Electrical System with Faceplate Options  Modular	<ul style="list-style-type: none"> Modular system tray (hardwire base power infeed) <ul style="list-style-type: none"> - PAMH modular system tray with outlets and blank AAPs - PDMH modular system tray with outlets and two data AAPs - PVMH modular system tray with outlets and two of each video/audio and data AAPs 	+\$141 each tray Specify with modular power data, and select TAP type and TAP door color number.
Storage Tray	<ul style="list-style-type: none"> Storage tray 	-\$593 Specify with storage tray and select door color number.
Doors	<ul style="list-style-type: none"> Storage tray wood veneer doors TAP wood veneer doors 	+\$298 per door +\$298 per door Specify with wood doors. Specify with wood doors.
Related Products	<ul style="list-style-type: none"> Floor kit: Connectrac Corridor shelf 	► Page 283 ► Page 283

TAP Locations

96"L x 48"W TAP Locations—One piece top

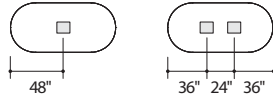

10'L x 48"W TAP Locations—One piece top

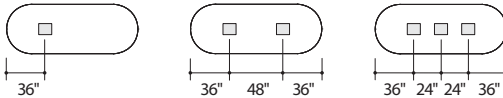

10'L x 48"W TAP Locations—Two piece top

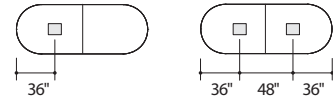

10'L x 60"W TAP Locations—One piece top

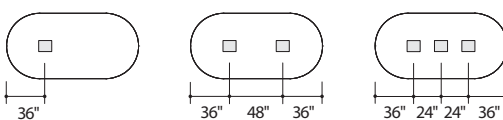

10'L x 60"W TAP Locations—Two piece top

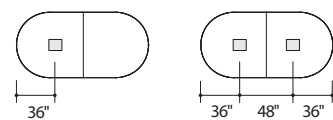

12'L x 48"W TAP Locations—One piece top

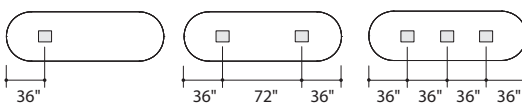

12'L x 48"W TAP Locations—Two piece top

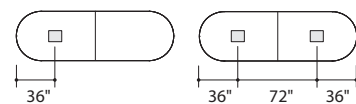

12'L x 60"W TAP Locations—One piece top

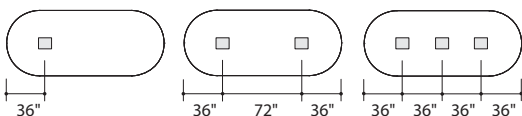

12'L x 60"W TAP Locations—Two piece top

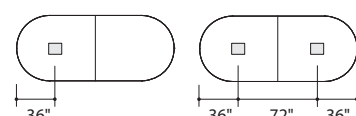

► Specification Information, on next page

Host Collection

Racetrack Tables with Two Bases *continued*
 DESIGN F/P DESIGN AND VECTA DESIGN TEAM

SIN 711.11

Tip: Prices shown include top, TAP(s), and slim bases.
 ▶ See base options for flared bases, page 224



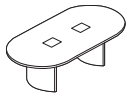
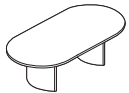

Tip: Last digit of style number indicates number of TAP(s).

Tip: For tech corridor, 96"L tables have two long doors and four short doors.



▶ Options, on previous page

Specification Information

Style Number	Finish	Base Prices			
					
		Flat Wood Edge:	Bullnose Wood Edge:	Beveled Wood Edge:	Horizon Wood Edge:

96"L x 48"W One Piece Top

0 TAP

HS9648C10	Grade 1 Laminate	\$ 6884	\$ 6984	\$ 7122	\$ 8994
	Grade 2 Laminate	\$ 7002	\$ 7102	\$ 7240	\$ 9112
	Grade 1 Veneer	\$ 7584	\$ 7684	\$ 7822	\$ 9694
	Grade 2 Veneer	\$ 8194	\$ 8294	\$ 8432	\$10,304

1 TAP

HS9648C11	Grade 1 Laminate	\$ 8470	\$ 8570	\$ 8708	\$10,580
	Grade 2 Laminate	\$ 8588	\$ 8688	\$ 8826	\$10,698
	Grade 1 Veneer	\$ 9170	\$ 9270	\$ 9408	\$11,280
	Grade 2 Veneer	\$ 9780	\$ 9880	\$10,018	\$11,890

2 TAPS

HS9648C12	Grade 1 Laminate	\$10,057	\$10,157	\$10,295	\$12,167
	Grade 2 Laminate	\$10,175	\$10,275	\$10,413	\$12,285
	Grade 1 Veneer	\$10,757	\$10,857	\$10,995	\$12,867
	Grade 2 Veneer	\$11,367	\$11,467	\$11,605	\$13,477

▶ Specification Information, continued on next page

Host Collection Racetrack Tables with Two Bases

DESIGN F/P DESIGN AND VECTA DESIGN TEAM

SIN 711.11

Tip: Prices shown include top, TAP(s), and slim bases.
 ▶ See base options for flared bases, page 224



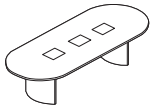
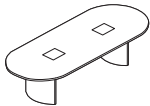
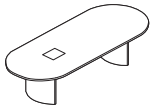
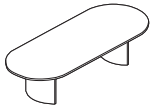

Tip: Last digit of style number indicates number of TAP(s).

Tip: For tech corridor, 10'L tables have four long doors and four short doors.



▶ Specification Information, continued from previous page

Specification Information

Style Number	Finish	Base Prices			
					
		Flat Wood Edge:	Bullnose Wood Edge:	Beveled Wood Edge:	Horizon Wood Edge:

10'L x 48"W One Piece Top

0 TAP					
HS1048C10	Grade 1 Laminate	\$ 7488	\$ 7604	\$ 7765	\$ 9635
	Grade 2 Laminate	\$ 7638	\$ 7754	\$ 7915	\$ 9785
	Grade 1 Veneer	\$ 8333	\$ 8449	\$ 8610	\$10,480
	Grade 2 Veneer	\$ 9097	\$ 9213	\$ 9374	\$11,244
1 TAP					
HS1048C11	Grade 1 Laminate	\$ 9076	\$ 9192	\$ 9353	\$11,223
	Grade 2 Laminate	\$ 9226	\$ 9342	\$ 9503	\$11,373
	Grade 1 Veneer	\$ 9921	\$10,037	\$10,198	\$12,068
	Grade 2 Veneer	\$10,685	\$10,801	\$10,962	\$12,832
2 TAPS					
HS1048C12	Grade 1 Laminate	\$10,662	\$10,778	\$10,939	\$12,809
	Grade 2 Laminate	\$10,812	\$10,928	\$11,089	\$12,959
	Grade 1 Veneer	\$11,508	\$11,624	\$11,785	\$13,655
	Grade 2 Veneer	\$12,271	\$12,387	\$12,548	\$14,418
3 TAPS					
HS1048C13	Grade 1 Laminate	\$12,251	\$12,367	\$12,528	\$14,398
	Grade 2 Laminate	\$12,401	\$12,517	\$12,678	\$14,548
	Grade 1 Veneer	\$13,096	\$13,212	\$13,373	\$15,243
	Grade 2 Veneer	\$13,860	\$13,976	\$14,137	\$16,007

▶ Specification Information, continued on next page

Host Collection

Racetrack Tables with Two Bases *continued*
 DESIGN F/P DESIGN AND VECTA DESIGN TEAM

SIN 711.11

Tip: Prices shown include top, TAP(s), and slim bases.
 ▶ See base options for flared bases, page 224

Tip: Last digit of style number indicates number of TAP(s).

Tip: For tech corridor, 10'L tables have four long doors and four short doors.

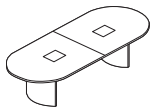
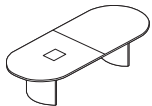
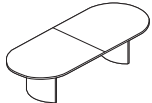

▶ Specification Information, continued from previous page

Specification Information

Style Number	Finish	Base Prices			
		Flat Wood Edge:	Bullnose Wood Edge:	Beveled Wood Edge:	Horizon Wood Edge:

10'L x 48"W Two Piece Top

0 TAP

HS1048C20	Grade 1 Laminate	\$ 7869	\$ 7985	\$ 8146	\$10,016
	Grade 2 Laminate	\$ 8019	\$ 8135	\$ 8296	\$10,166
	Grade 1 Veneer	\$ 8714	\$ 8830	\$ 8991	\$10,861
	Grade 2 Veneer	\$ 9478	\$ 9594	\$ 9755	\$11,625

1 TAP

HS1048C21	Grade 1 Laminate	\$ 9456	\$ 9572	\$ 9733	\$11,603
	Grade 2 Laminate	\$ 9606	\$ 9722	\$ 9883	\$11,753
	Grade 1 Veneer	\$10,301	\$10,417	\$10,578	\$12,448
	Grade 2 Veneer	\$11,065	\$11,181	\$11,342	\$13,212

2 TAPS

HS1048C22	Grade 1 Laminate	\$11,043	\$11,159	\$11,320	\$13,190
	Grade 2 Laminate	\$11,193	\$11,309	\$11,470	\$13,340
	Grade 1 Veneer	\$11,888	\$12,004	\$12,165	\$14,035
	Grade 2 Veneer	\$12,652	\$12,768	\$12,929	\$14,799

▶ Specification Information, continued on next page

Host Collection

Racetrack Tables with Two Bases

DESIGN F/P DESIGN AND VECTA DESIGN TEAM

SIN 711.11

Tip: Prices shown include top, TAP(s), and slim bases.
 ▶ See base options for flared bases, page 224



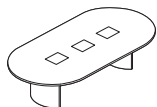
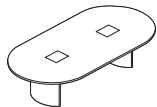
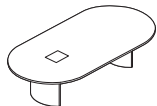
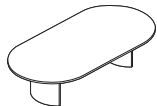

Tip: Last digit of style number indicates number of TAP(s).

Tip: For tech corridor, 10'L tables have four long doors and four short doors.



▶ Specification Information, continued from previous page

Specification Information

Style Number	Finish	Base Prices			
					
		Flat Wood Edge:	Bullnose Wood Edge:	Beveled Wood Edge:	Horizon Wood Edge:

10'L x 60"W One Piece Top

0 TAP					
HS1060C10	Grade 1 Laminate	\$ 7644	\$ 7768	\$ 7939	\$ 9811
	Grade 2 Laminate	\$ 7827	\$ 7951	\$ 8122	\$ 9994
	Grade 1 Veneer	\$ 8974	\$ 9098	\$ 9269	\$11,141
	Grade 2 Veneer	\$ 9936	\$10,060	\$10,231	\$12,103
1 TAP					
HS1060C11	Grade 1 Laminate	\$ 9232	\$ 9356	\$ 9527	\$11,399
	Grade 2 Laminate	\$ 9415	\$ 9539	\$ 9710	\$11,582
	Grade 1 Veneer	\$10,562	\$10,686	\$10,857	\$12,729
	Grade 2 Veneer	\$11,524	\$11,648	\$11,819	\$13,691
2 TAPS					
HS1060C12	Grade 1 Laminate	\$10,821	\$10,945	\$11,116	\$12,988
	Grade 2 Laminate	\$11,004	\$11,128	\$11,299	\$13,171
	Grade 1 Veneer	\$12,151	\$12,275	\$12,446	\$14,318
	Grade 2 Veneer	\$13,113	\$13,237	\$13,408	\$15,280
3 TAPS					
HS1060C13	Grade 1 Laminate	\$12,408	\$12,532	\$12,703	\$14,575
	Grade 2 Laminate	\$12,591	\$12,715	\$12,886	\$14,758
	Grade 1 Veneer	\$13,738	\$13,862	\$14,033	\$15,905
	Grade 2 Veneer	\$14,700	\$14,824	\$14,995	\$16,867

▶ Specification Information, continued on next page

Host Collection

Racetrack Tables with Two Bases *continued*
 DESIGN F/P DESIGN AND VECTA DESIGN TEAM

SIN 711.11

Tip: Prices shown include top, TAP(s), and slim bases.
 ▶ See base options for flared bases, page 224



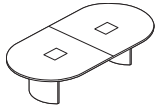
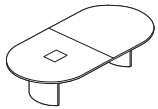
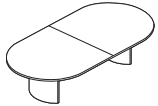

Tip: Last digit of style number indicates number of TAP(s).

Tip: For tech corridor, 10'L tables have four long doors and four short doors.



► Specification Information, continued from previous page

Specification Information

Style Number	Finish	Base Prices			
					
		Flat Wood Edge:	Bullnose Wood Edge:	Beveled Wood Edge:	Horizon Wood Edge:

10'L x 60"W Two Piece Top

0 TAP

HS1060C20	Grade 1 Laminate	\$ 8026	\$ 8150	\$ 8321	\$10,193
	Grade 2 Laminate	\$ 8209	\$ 8333	\$ 8504	\$10,376
	Grade 1 Veneer	\$ 9356	\$ 9480	\$ 9651	\$11,523
	Grade 2 Veneer	\$10,318	\$10,442	\$10,613	\$12,485

1 TAP

HS1060C21	Grade 1 Laminate	\$ 9613	\$ 9737	\$ 9908	\$11,780
	Grade 2 Laminate	\$ 9796	\$ 9920	\$10,091	\$11,963
	Grade 1 Veneer	\$10,943	\$11,067	\$11,238	\$13,110
	Grade 2 Veneer	\$11,905	\$12,029	\$12,200	\$14,072

2 TAPS

HS1060C22	Grade 1 Laminate	\$11,199	\$11,323	\$11,494	\$13,366
	Grade 2 Laminate	\$11,382	\$11,506	\$11,677	\$13,549
	Grade 1 Veneer	\$12,529	\$12,653	\$12,824	\$14,696
	Grade 2 Veneer	\$13,491	\$13,615	\$13,786	\$15,658

► Specification Information, continued on next page

Host Collection Racetrack Tables with Two Bases

DESIGN F/P DESIGN AND VECTA DESIGN TEAM

SIN 711.11

Tip: Prices shown include top, TAP(s), and slim bases.
 ▶ See base options for flared bases, page 224



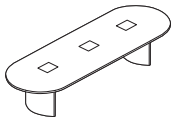
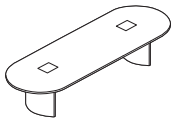
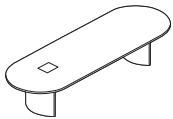
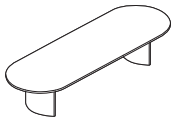

Tip: Last digit of style number indicates number of TAP(s).

Tip: For tech corridor, 12'L tables have four long doors and four short doors.



▶ Specification Information, continued from previous page

Specification Information

Style Number	Finish	Base Prices			
					
		Flat Wood Edge:	Bullnose Wood Edge:	Beveled Wood Edge:	Horizon Wood Edge:

12'L x 48"W One Piece Top

0 TAP					
HS1248C10	Grade 1 Laminate	\$ 8035	\$ 8166	\$ 8349	\$10,222
	Grade 2 Laminate	\$ 8212	\$ 8343	\$ 8526	\$10,399
	Grade 1 Veneer	\$ 9118	\$ 9249	\$ 9432	\$11,305
	Grade 2 Veneer	\$10,038	\$10,169	\$10,352	\$12,225
1 TAP					
HS1248C11	Grade 1 Laminate	\$ 9623	\$ 9754	\$ 9937	\$11,810
	Grade 2 Laminate	\$ 9800	\$ 9931	\$10,114	\$11,987
	Grade 1 Veneer	\$10,706	\$10,837	\$11,020	\$12,893
	Grade 2 Veneer	\$11,626	\$11,757	\$11,940	\$13,813
2 TAPS					
HS1248C12	Grade 1 Laminate	\$11,210	\$11,341	\$11,524	\$13,397
	Grade 2 Laminate	\$11,387	\$11,518	\$11,701	\$13,574
	Grade 1 Veneer	\$12,293	\$12,424	\$12,607	\$14,480
	Grade 2 Veneer	\$13,213	\$13,344	\$13,527	\$15,400
3 TAPS					
HS1248C13	Grade 1 Laminate	\$12,796	\$12,927	\$13,110	\$14,983
	Grade 2 Laminate	\$12,973	\$13,104	\$13,287	\$15,160
	Grade 1 Veneer	\$13,879	\$14,010	\$14,193	\$16,066
	Grade 2 Veneer	\$14,799	\$14,930	\$15,113	\$16,986

▶ Specification Information, continued on next page

Host Collection

Racetrack Tables with Two Bases *continued*
 DESIGN F/P DESIGN AND VECTA DESIGN TEAM

SIN 711.11

Tip: Prices shown include top, TAP(s), and slim bases.
 ▶ See base options for flared bases, page 224



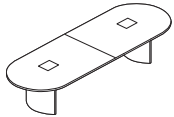
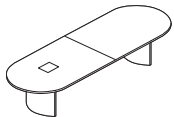
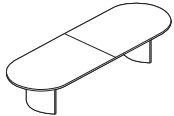

Tip: Last digit of style number indicates number of TAP(s).

Tip: For tech corridor, 12'L tables have four long doors and four short doors.



▶ Specification Information, continued from previous page

Specification Information

Style Number	Finish	Base Prices			
					
		Flat Wood Edge:	Bullnose Wood Edge:	Beveled Wood Edge:	Horizon Wood Edge:

12'L x 48"W Two Piece Top

0 TAP

HS1248C20	Grade 1 Laminate	\$ 8415	\$ 8546	\$ 8729	\$10,602
	Grade 2 Laminate	\$ 8592	\$ 8723	\$ 8906	\$10,779
	Grade 1 Veneer	\$ 9498	\$ 9629	\$ 9812	\$11,685
	Grade 2 Veneer	\$10,418	\$10,549	\$10,732	\$12,605

1 TAP

HS1248C21	Grade 1 Laminate	\$10,003	\$10,134	\$10,317	\$12,190
	Grade 2 Laminate	\$10,180	\$10,311	\$10,494	\$12,367
	Grade 1 Veneer	\$11,086	\$11,217	\$11,400	\$13,273
	Grade 2 Veneer	\$12,006	\$12,137	\$12,320	\$14,193

2 TAPS

HS1248C22	Grade 1 Laminate	\$11,590	\$11,721	\$11,904	\$13,777
	Grade 2 Laminate	\$11,767	\$11,898	\$12,081	\$13,954
	Grade 1 Veneer	\$12,673	\$12,804	\$12,987	\$14,860
	Grade 2 Veneer	\$13,593	\$13,724	\$13,907	\$15,780

▶ Specification Information, continued on next page

Host Collection

Racetrack Tables with Two Bases
DESIGN F/P DESIGN AND VECTA DESIGN TEAM

SIN 711.11

Tip: Prices shown include top, TAP(s), and slim bases.
▶ See base options for flared bases, page 224

Tip: Last digit of style number indicates number of TAP(s).

Tip: For tech corridor, 12'L tables have four long doors and four short doors.

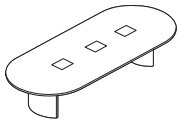
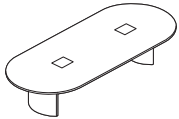
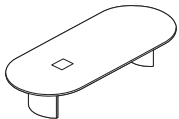
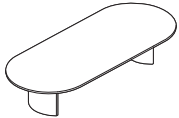

▶ Specification Information, continued from previous page

Specification Information					
Style Number	Finish	Base Prices			
		Flat Wood Edge:	Bullnose Wood Edge:	Beveled Wood Edge:	Horizon Wood Edge:
12'L x 60"W One Piece Top					
0 TAP					
HS1260C10	Grade 1 Laminate	\$ 8203	\$ 8341	\$ 8537	\$10,410
	Grade 2 Laminate	\$ 8424	\$ 8562	\$ 8758	\$10,631
	Grade 1 Veneer	\$ 9818	\$ 9956	\$10,152	\$12,025
	Grade 2 Veneer	\$10,974	\$11,112	\$11,308	\$13,181
1 TAP					
HS1260C11	Grade 1 Laminate	\$ 9791	\$ 9929	\$10,125	\$11,998
	Grade 2 Laminate	\$10,012	\$10,150	\$10,346	\$12,219
	Grade 1 Veneer	\$11,406	\$11,544	\$11,740	\$13,613
	Grade 2 Veneer	\$12,562	\$12,700	\$12,896	\$14,769
2 TAPS					
HS1260C12	Grade 1 Laminate	\$11,376	\$11,514	\$11,710	\$13,583
	Grade 2 Laminate	\$11,597	\$11,735	\$11,931	\$13,804
	Grade 1 Veneer	\$12,991	\$13,129	\$13,325	\$15,198
	Grade 2 Veneer	\$14,147	\$14,285	\$14,481	\$16,354
3 TAPS					
HS1260C13	Grade 1 Laminate	\$12,964	\$13,102	\$13,298	\$15,171
	Grade 2 Laminate	\$13,185	\$13,323	\$13,519	\$15,392
	Grade 1 Veneer	\$14,579	\$14,717	\$14,913	\$16,786
	Grade 2 Veneer	\$15,735	\$15,873	\$16,069	\$17,942

▶ Specification Information, continued on next page

Host Collection Racetrack Tables with Two Bases *continued*

DESIGN F/P DESIGN AND VECTA DESIGN TEAM

SIN 711.11

Tip: Prices shown include top, TAP(s), and slim bases.
 ▶ See base options for flared bases, page 224



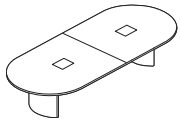
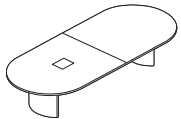
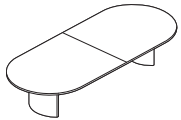

Tip: Last digit of style number indicates number of TAP(s).

Tip: For tech corridor, 12'L tables have four long doors and four short doors.



▶ Specification Information, continued from previous page

Specification Information

Style Number	Finish	Base Prices			
					
		Flat Wood Edge:	Bullnose Wood Edge:	Beveled Wood Edge:	Horizon Wood Edge:

12'L x 60"W Two Piece Top

0 TAP

HS1260C20	Grade 1 Laminate	\$ 8583	\$ 8721	\$ 8917	\$10,790
	Grade 2 Laminate	\$ 8804	\$ 8942	\$ 9138	\$11,011
	Grade 1 Veneer	\$10,198	\$10,336	\$10,532	\$12,405
	Grade 2 Veneer	\$11,354	\$11,492	\$11,688	\$13,561

1 TAP

HS1260C21	Grade 1 Laminate	\$10,170	\$10,308	\$10,504	\$12,377
	Grade 2 Laminate	\$10,391	\$10,529	\$10,725	\$12,598
	Grade 1 Veneer	\$11,785	\$11,923	\$12,119	\$13,992
	Grade 2 Veneer	\$12,941	\$13,079	\$13,275	\$15,148

2 TAPS

HS1260C22	Grade 1 Laminate	\$11,757	\$11,895	\$12,091	\$13,964
	Grade 2 Laminate	\$11,978	\$12,116	\$12,312	\$14,185
	Grade 1 Veneer	\$13,372	\$13,510	\$13,706	\$15,579
	Grade 2 Veneer	\$14,528	\$14,666	\$14,862	\$16,735

Coalesse

Host Collection

Racetrack Tables with Two Bases
DESIGN F/P DESIGN AND VECTA DESIGN TEAM

SIN 711.11

Host Collection Racetrack Tables with Three Bases

DESIGN F/P DESIGN AND VECTA DESIGN TEAM

SIN 711.11

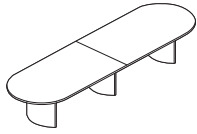

Tip: Shipped knocked down.

Tip: Grain direction for wood-grain laminate runs the length of the table.

Tip: Clips are provided with table: One clip per foot of table length.

Tip: The wood edge on a table top with woodgrain laminate may not match the top.

Tip: You must send a sample of reasonable size for Stain-to-Match.

Standard Includes	Required to Specify
<ul style="list-style-type: none"> ▶ Need help? Product details, see <i>Coalesse Tables, Storage, and Accessories Specification Guide</i> • Top: 1¼" particle board core with laminate • Flat wood edge • TAP(s), if selected: 10"W x 12"L opening(s) trimmed with a flat solid wood profile and with brushed anodized aluminum TAP doors • Tech corridor: four aluminum beams for top support provide tracks for hinged aluminum doors that clip shut: satin anodized finish • Universal clip: black plastic • Three 27"W bases: wood veneer on MDF with aluminum universal bracket, see below • Concealed leveling glides: non-marring, black plastic 	<ol style="list-style-type: none"> 1 Style number 2 Base selection (see below) and wood color number for base 3 Laminate color number for table top, if selected 4 Wood color number for wood edge <ul style="list-style-type: none"> ▶ See <i>Veneer Matrix</i>, page 365 5 Door color number for storage tray or TAP door, if selected: <ul style="list-style-type: none"> - 8044 Black - 8047 Silver 6 Options, if selected (see below) <ul style="list-style-type: none"> ▶ See <i>Surface Materials</i>, page 350.

Options	Price	Required to Specify
Surface Materials <ul style="list-style-type: none"> • Top <ul style="list-style-type: none"> • Grade 2 laminate • Grade 1 wood veneer • Grade 2 wood veneer • Stain-to-Match 	<ul style="list-style-type: none"> Prices at right Prices at right Prices at right No cost 	<ul style="list-style-type: none"> Specify with <i>Grade 2 laminate</i> and select color number. Specify with <i>Grade 1 wood veneer</i> and select color number. Specify with <i>Grade 2 wood veneer</i> and select color number. Specify with <i>Stain-to-Match</i>. ▶ Page 385

Edges	Wood	Price	Required to Specify
	<ul style="list-style-type: none"> • Bullnose wood edge • Beveled wood edge • Horizon wood edge 	<ul style="list-style-type: none"> Prices at right Prices at right Prices at right 	<ul style="list-style-type: none"> Specify with <i>bullnose wood edge</i>. Specify with <i>beveled wood edge</i>. Specify with <i>Horizon wood edge</i>.

Bases	Price	Required to Specify
<ul style="list-style-type: none"> • Three slim bases • Two slim and one flared bases • One slim and two flared bases • Three flared bases 	<ul style="list-style-type: none"> No cost +\$ 827 +\$1656 +\$2481 	<ul style="list-style-type: none"> Specify with <i>three slim bases</i>. Specify with <i>two slim</i> and one flared bases. Specify with <i>one slim</i> and two flared bases. Specify with <i>three flared bases</i>.

Tip: 14'L and 16'L tables available with zero, one, two, or four TAP(s). 18'L and 20'L tables available with zero, one, two, four, or six TAP(s).

Tip: In addition to the data and audio/video AAPs available from Coalesse, other styles of AAPs are available through Extron Electronics. For an Extron dealer, call 1.800.633.9876.

Tip: See TAP options for electrical systems and faceplate list.

TAP Electrical System with Faceplate Options	Price	Required to Specify
<ul style="list-style-type: none"> • Field-wired tray (no electrical) <ul style="list-style-type: none"> - PAFW field-wired tray (no electrical) with blank AAPs - PDFW field-wired tray (no electrical) with two data AAPs - PVFW field-wired tray (no electrical) with two of each video/audio and data AAPs 	<ul style="list-style-type: none"> No cost 	<ul style="list-style-type: none"> Specify with <i>power data</i>, and select TAP type and TAP door color number.
<ul style="list-style-type: none"> • Cord and plug tray (10' cord) <ul style="list-style-type: none"> - PACP cord and plug tray with outlets and blank AAPs - PDCP cord and plug tray with outlets and two data AAPs - PAVC cord and plug tray with outlets and two of each video/audio and data AAPs 	<ul style="list-style-type: none"> No cost 	<ul style="list-style-type: none"> Specify with <i>power data</i>, and select TAP type and TAP door color number.
<ul style="list-style-type: none"> • Hard-wired tray (6' conduit) <ul style="list-style-type: none"> - PAHW hard-wired tray with outlets and blank AAPs - PDHW hard-wired tray with outlets and two data AAPs - PAVH hard-wired tray with outlets and two of each video/audio and data AAPs 	<ul style="list-style-type: none"> No cost 	<ul style="list-style-type: none"> Specify with <i>power data</i>, and select TAP type and TAP door color number.

▶ Options, continued on next page

Host Collection

Racetrack Tables with Three Bases
DESIGN F/P DESIGN AND VECTA DESIGN TEAM

SIN 711.11

►Options, continued from previous page

Tip: For single TAP style numbers, the modular system tray is not available. Specify the hard-wired tray option.

Tip: If the specified table has multiple TAP(s), any one TAP can be replaced with a storage tray.

Tip: Wood veneer doors for storage tray and TAP will always be cross grain.

Tip: Connectrac must be the same wiring schematic as the table.

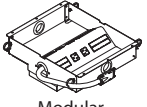
Options	Price	Required to Specify
TAP Electrical System with Faceplate Options  Modular	<ul style="list-style-type: none"> Modular system tray (hardwire base power infeed) <ul style="list-style-type: none"> - PAMH modular system tray with outlets and blank AAPs - PDMH modular system tray with outlets and two data AAPs - PVMH modular system tray with outlets and two of each video/audio and data AAPs +\$141 each tray	Specify with <i>modular power data</i> , and select TAP type and TAP door color number.
Storage Tray	<ul style="list-style-type: none"> Storage tray -\$593	Specify with <i>storage tray</i> and select door color number.
Doors	<ul style="list-style-type: none"> Storage tray wood veneer doors +\$298 per door TAP wood veneer doors +\$298 per door 	Specify with <i>wood doors</i> .
Related Products	<ul style="list-style-type: none"> Floor kit: Connectrac Corridor shelf 	► Page 283 ► Page 283

TAP Locations

14'L x 48"W TAP Locations—Two piece top

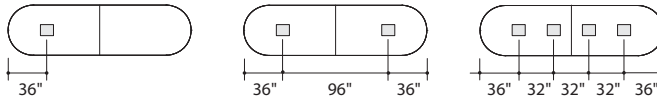

14'L x 48"W TAP Locations—Three piece top

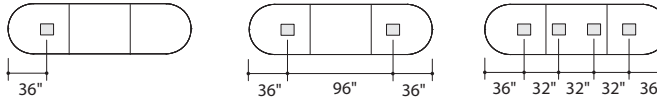

14'L x 60"W TAP Locations—Two piece top

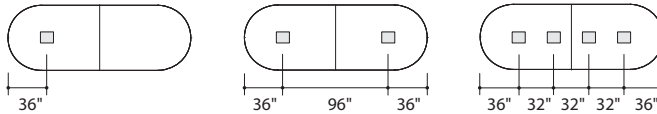

14'L x 60"W TAP Locations—Three piece top

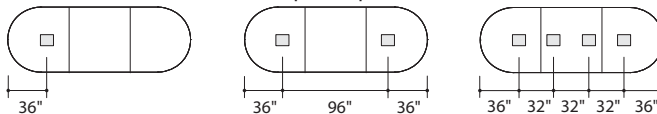

►Options, continued on next page

Host Collection

Racetrack Tables with Three Bases *continued*
DESIGN F/P DESIGN AND VECTA DESIGN TEAM

SIN 711.11

► Options, continued from previous page

TAP Locations

16'L x 48"W TAP Locations—Two piece top

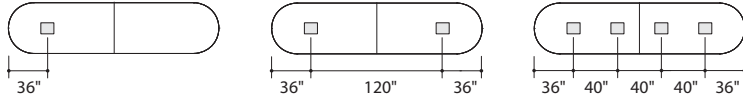

16'L x 48"W TAP Locations—Three piece top

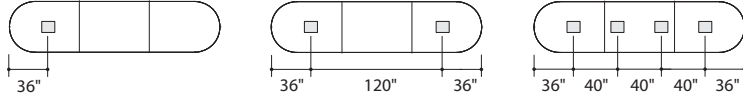

16'L x 60"W TAP Locations—Two piece top

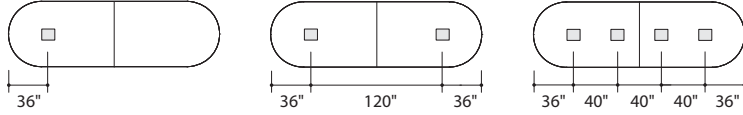

16'L x 60"W TAP Locations—Three piece top

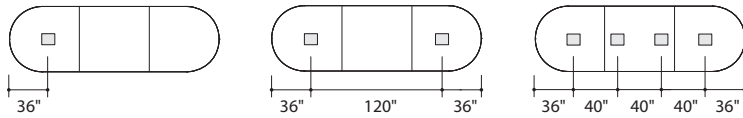

18'L x 48"W TAP Locations—Two piece top

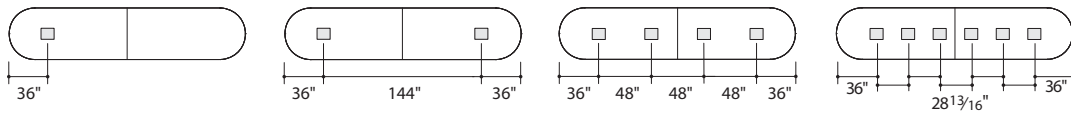

18'L x 48"W TAP Locations—Three piece top

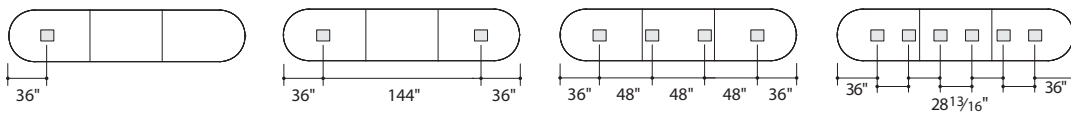

18'L x 60"W TAP Locations—Two piece top

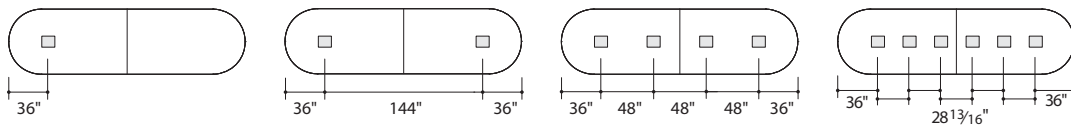

18'L x 60"W TAP Locations—Three piece top

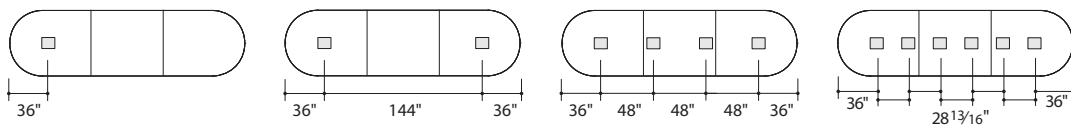

► Options, continued on next page

Host Collection

Racetrack Tables with Three Bases
DESIGN F/P DESIGN AND VECTA DESIGN TEAM

SIN 711.11

► Options, continued from previous page

TAP Locations

20'L x 48"W TAP Locations—Two piece top

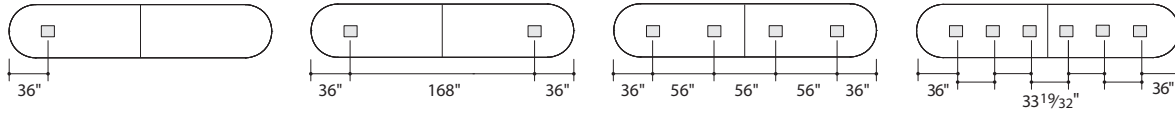

20'L x 48"W TAP Locations—Three piece top

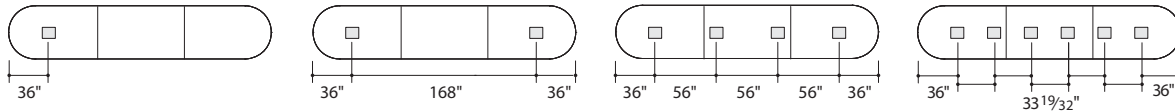

20'L x 60"W TAP Locations—Two piece top

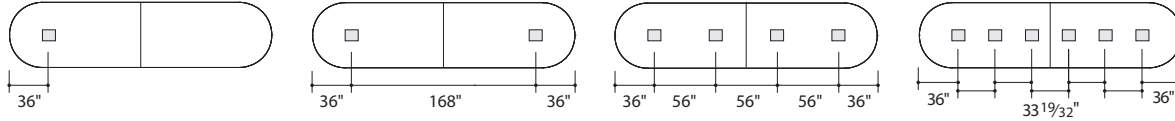

20'L x 60"W TAP Locations—Three piece top

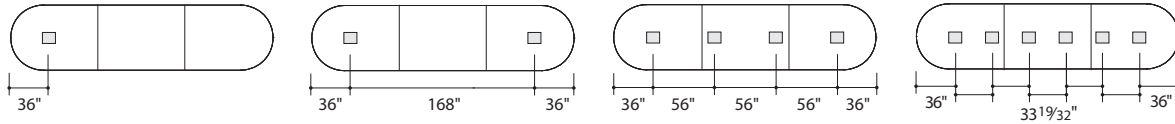

► Specification Information, on next page

Host Collection

Racetrack Tables with Three Bases *continued*
 DESIGN F/P DESIGN AND VECTA DESIGN TEAM

SIN 711.11

Tip: Prices shown include top, TAP(s), and slim bases.
 ▶ See base options for flared bases, page 236



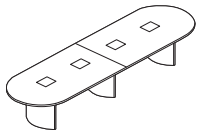
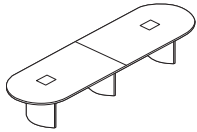
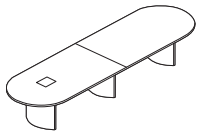
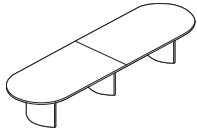

Tip: Last digit of style number indicates number of TAP(s).

Tip: For tech corridor, 14'L tables have four long doors and four short doors.



▶ Options, on previous page

Specification Information

Style Number	Finish	Base Prices			
					
		Flat Wood Edge:	Bullnose Wood Edge:	Beveled Wood Edge:	Horizon Wood Edge:

14'L x 48"W Two Piece Top

0 TAP

HS1448C20	Grade 1 Laminate	\$10,880	\$11,030	\$11,232	\$13,108
	Grade 2 Laminate	\$11,088	\$11,238	\$11,440	\$13,316
	Grade 1 Veneer	\$12,332	\$12,482	\$12,684	\$14,560
	Grade 2 Veneer	\$13,408	\$13,558	\$13,760	\$15,636

1 TAP

HS1448C21	Grade 1 Laminate	\$12,464	\$12,614	\$12,816	\$14,692
	Grade 2 Laminate	\$12,672	\$12,822	\$13,024	\$14,900
	Grade 1 Veneer	\$13,916	\$14,066	\$14,268	\$16,144
	Grade 2 Veneer	\$14,992	\$15,142	\$15,344	\$17,220

2 TAPS

HS1448C22	Grade 1 Laminate	\$14,053	\$14,203	\$14,405	\$16,281
	Grade 2 Laminate	\$14,261	\$14,411	\$14,613	\$16,489
	Grade 1 Veneer	\$15,505	\$15,655	\$15,857	\$17,733
	Grade 2 Veneer	\$16,581	\$16,731	\$16,933	\$18,809

4 TAPS

HS1448C24	Grade 1 Laminate	\$17,228	\$17,378	\$17,580	\$19,456
	Grade 2 Laminate	\$17,436	\$17,586	\$17,788	\$19,664
	Grade 1 Veneer	\$18,680	\$18,830	\$19,032	\$20,908
	Grade 2 Veneer	\$19,756	\$19,906	\$20,108	\$21,984

▶ Specification Information, continued on next page

Host Collection

Racetrack Tables with Three Bases
DESIGN F/P DESIGN AND VECTA DESIGN TEAM

SIN 711.11

Tip: Prices shown include top, TAP(s), and slim bases.
▶ See base options for flared bases, page 236



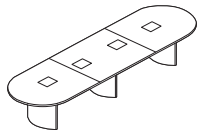
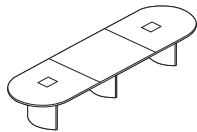
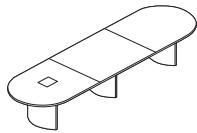
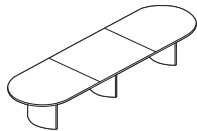

Tip: Last digit of style number indicates number of TAP(s).

Tip: For tech corridor, 14'L tables have four long doors and four short doors.



▶ Specification Information, continued from previous page

Specification Information

Style Number	Finish	Base Prices			
					
		Flat Wood Edge:	Bullnose Wood Edge:	Beveled Wood Edge:	Horizon Wood Edge:

14'L x 48"W Three Piece Top

0 TAP					
HS1448C30	Grade 1 Laminate	\$11,259	\$11,409	\$11,611	\$13,487
	Grade 2 Laminate	\$11,467	\$11,617	\$11,819	\$13,695
	Grade 1 Veneer	\$12,711	\$12,861	\$13,063	\$14,939
	Grade 2 Veneer	\$13,787	\$13,937	\$14,139	\$16,015
1 TAP					
HS1448C31	Grade 1 Laminate	\$12,846	\$12,996	\$13,198	\$15,074
	Grade 2 Laminate	\$13,054	\$13,204	\$13,406	\$15,282
	Grade 1 Veneer	\$14,298	\$14,448	\$14,650	\$16,526
	Grade 2 Veneer	\$15,374	\$15,524	\$15,726	\$17,602
2 TAPS					
HS1448C32	Grade 1 Laminate	\$14,433	\$14,583	\$14,785	\$16,661
	Grade 2 Laminate	\$14,641	\$14,791	\$14,993	\$16,869
	Grade 1 Veneer	\$15,885	\$16,035	\$16,237	\$18,113
	Grade 2 Veneer	\$16,961	\$17,111	\$17,313	\$19,189
4 TAPS					
HS1448C34	Grade 1 Laminate	\$17,607	\$17,757	\$17,959	\$19,835
	Grade 2 Laminate	\$17,815	\$17,965	\$18,167	\$20,043
	Grade 1 Veneer	\$19,059	\$19,209	\$19,411	\$21,287
	Grade 2 Veneer	\$20,135	\$20,285	\$20,487	\$22,363

▶ Specification Information, continued on next page

Host Collection

Racetrack Tables with Three Bases *continued*
 DESIGN F/P DESIGN AND VECTA DESIGN TEAM

SIN 711.11

Tip: Prices shown include top, TAP(s), and slim bases.
 ▶ See base options for flared bases, page 236



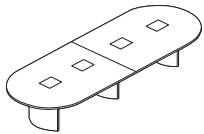
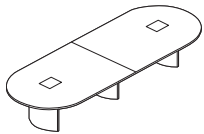
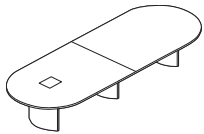
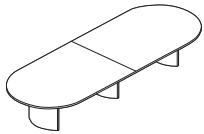

Tip: Last digit of style number indicates number of TAP(s).

Tip: For tech corridor, 14'L tables have four long doors and four short doors.



▶ Specification Information, continued from previous page

Specification Information

Style Number	Finish	Base Prices			
					
		Flat Wood Edge:	Bullnose Wood Edge:	Beveled Wood Edge:	Horizon Wood Edge:

14'L x 60"W Two Piece Top

0 TAP

HS1460C20	Grade 1 Laminate	\$11,306	\$11,462	\$11,678	\$13,555
	Grade 2 Laminate	\$11,566	\$11,722	\$11,938	\$13,815
	Grade 1 Veneer	\$13,732	\$13,888	\$14,104	\$15,981
	Grade 2 Veneer	\$15,094	\$15,250	\$15,466	\$17,343

1 TAP

HS1460C21	Grade 1 Laminate	\$12,895	\$13,051	\$13,267	\$15,144
	Grade 2 Laminate	\$13,155	\$13,311	\$13,527	\$15,404
	Grade 1 Veneer	\$15,321	\$15,477	\$15,693	\$17,570
	Grade 2 Veneer	\$16,683	\$16,839	\$17,055	\$18,932

2 TAPS

HS1460C22	Grade 1 Laminate	\$14,481	\$14,637	\$14,853	\$16,730
	Grade 2 Laminate	\$14,741	\$14,897	\$15,113	\$16,990
	Grade 1 Veneer	\$16,907	\$17,063	\$17,279	\$19,156
	Grade 2 Veneer	\$18,269	\$18,425	\$18,641	\$20,518

4 TAPS

HS1460C24	Grade 1 Laminate	\$17,655	\$17,811	\$18,027	\$19,904
	Grade 2 Laminate	\$17,915	\$18,071	\$18,287	\$20,164
	Grade 1 Veneer	\$20,081	\$20,237	\$20,453	\$22,330
	Grade 2 Veneer	\$21,443	\$21,599	\$21,815	\$23,692

▶ Specification Information, continued on next page

Host Collection Racetrack Tables with Three Bases

DESIGN F/P DESIGN AND VECTA DESIGN TEAM

SIN 711.11

Tip: Prices shown include top, TAP(s), and slim bases.
 ▶ See base options for flared bases, page 236



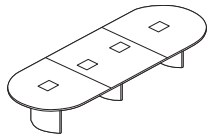
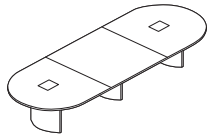
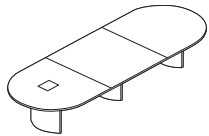
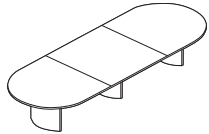

Tip: Last digit of style number indicates number of TAP(s).

Tip: For tech corridor, 14'L tables have four long doors and four short doors.



▶ Specification Information, continued from previous page

Specification Information

Style Number	Finish	Base Prices			
					
		Flat Wood Edge:	Bullnose Wood Edge:	Beveled Wood Edge:	Horizon Wood Edge:

14'L x 60"W Three Piece Top

0 TAP

HS1460C30	Grade 1 Laminate	\$11,687	\$11,843	\$12,059	\$13,936
	Grade 2 Laminate	\$11,947	\$12,103	\$12,319	\$14,196
	Grade 1 Veneer	\$14,113	\$14,269	\$14,485	\$16,362
	Grade 2 Veneer	\$15,475	\$15,631	\$15,847	\$17,724

1 TAP

HS1460C31	Grade 1 Laminate	\$13,273	\$13,429	\$13,645	\$15,522
	Grade 2 Laminate	\$13,533	\$13,689	\$13,905	\$15,782
	Grade 1 Veneer	\$15,699	\$15,855	\$16,071	\$17,948
	Grade 2 Veneer	\$17,061	\$17,217	\$17,433	\$19,310

2 TAPS

HS1460C32	Grade 1 Laminate	\$14,861	\$15,017	\$15,233	\$17,110
	Grade 2 Laminate	\$15,121	\$15,277	\$15,493	\$17,370
	Grade 1 Veneer	\$17,287	\$17,443	\$17,659	\$19,536
	Grade 2 Veneer	\$18,649	\$18,805	\$19,021	\$20,898

4 TAPS

HS1460C34	Grade 1 Laminate	\$18,036	\$18,192	\$18,408	\$20,285
	Grade 2 Laminate	\$18,296	\$18,452	\$18,668	\$20,545
	Grade 1 Veneer	\$20,462	\$20,618	\$20,834	\$22,711
	Grade 2 Veneer	\$21,824	\$21,980	\$22,196	\$24,073

▶ Specification Information, continued on next page

Host Collection Racetrack Tables with Three Bases *continued*

DESIGN F/P DESIGN AND VECTA DESIGN TEAM

SIN 711.11

Tip: Prices shown include top, TAP(s), and slim bases.
 ▶ See base options for flared bases, page 236



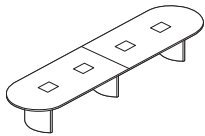
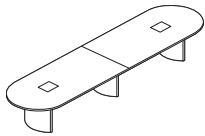
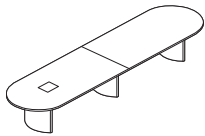
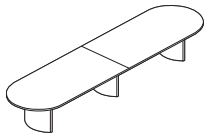

Tip: Last digit of style number indicates number of TAP(s).

Tip: For tech corridor, 16'L tables have eight long doors and four short doors.



▶ Specification Information, continued from previous page

Specification Information

Style Number	Finish	Base Prices			
					
		Flat Wood Edge:	Bullnose Wood Edge:	Beveled Wood Edge:	Horizon Wood Edge:

16'L x 48"W Two Piece Top

0 TAP

HS1648C20	Grade 1 Laminate	\$11,381	\$11,544	\$11,772	\$13,648
	Grade 2 Laminate	\$11,618	\$11,781	\$12,009	\$13,885
	Grade 1 Veneer	\$12,865	\$13,028	\$13,256	\$15,132
	Grade 2 Veneer	\$14,089	\$14,252	\$14,480	\$16,356

1 TAP

HS1648C21	Grade 1 Laminate	\$12,967	\$13,130	\$13,358	\$15,234
	Grade 2 Laminate	\$13,204	\$13,367	\$13,595	\$15,471
	Grade 1 Veneer	\$14,451	\$14,614	\$14,842	\$16,718
	Grade 2 Veneer	\$15,675	\$15,838	\$16,066	\$17,942

2 TAPS

HS1648C22	Grade 1 Laminate	\$14,554	\$14,717	\$14,945	\$16,821
	Grade 2 Laminate	\$14,791	\$14,954	\$15,182	\$17,058
	Grade 1 Veneer	\$16,038	\$16,201	\$16,429	\$18,305
	Grade 2 Veneer	\$17,262	\$17,425	\$17,653	\$19,529

4 TAPS

HS1648C24	Grade 1 Laminate	\$17,728	\$17,891	\$18,119	\$19,995
	Grade 2 Laminate	\$17,965	\$18,128	\$18,356	\$20,232
	Grade 1 Veneer	\$19,212	\$19,375	\$19,603	\$21,479
	Grade 2 Veneer	\$20,436	\$20,599	\$20,827	\$22,703

▶ Specification Information, continued on next page

Host Collection Racetrack Tables with Three Bases

DESIGN F/P DESIGN AND VECTA DESIGN TEAM

SIN 711.11

Tip: Prices shown include top, TAP(s), and slim bases.
 ▶ See base options for flared bases, page 236

Tip: Last digit of style number indicates number of TAP(s).

Tip: For tech corridor, 16'L tables have eight long doors and four short doors.

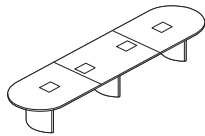
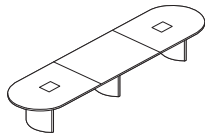
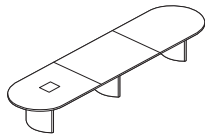
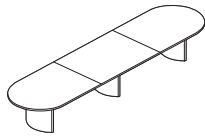

▶ Specification Information, continued from previous page

Specification Information

Style Number	Finish	Base Prices			
		Flat Wood Edge:	Bullnose Wood Edge:	Beveled Wood Edge:	Horizon Wood Edge:

16'L x 48"W Three Piece Top

0 TAP					
HS1648C30	Grade 1 Laminate	\$11,760	\$11,923	\$12,151	\$14,027
	Grade 2 Laminate	\$11,997	\$12,160	\$12,388	\$14,264
	Grade 1 Veneer	\$13,244	\$13,407	\$13,635	\$15,511
	Grade 2 Veneer	\$14,468	\$14,631	\$14,859	\$16,735
1 TAP					
HS1648C31	Grade 1 Laminate	\$13,348	\$13,511	\$13,739	\$15,615
	Grade 2 Laminate	\$13,585	\$13,748	\$13,976	\$15,852
	Grade 1 Veneer	\$14,832	\$14,995	\$15,223	\$17,099
	Grade 2 Veneer	\$16,056	\$16,219	\$16,447	\$18,323
2 TAPS					
HS1648C32	Grade 1 Laminate	\$14,935	\$15,098	\$15,326	\$17,202
	Grade 2 Laminate	\$15,172	\$15,335	\$15,563	\$17,439
	Grade 1 Veneer	\$16,419	\$16,582	\$16,810	\$18,686
	Grade 2 Veneer	\$17,643	\$17,806	\$18,034	\$19,910
4 TAPS					
HS1648C34	Grade 1 Laminate	\$18,109	\$18,272	\$18,500	\$20,376
	Grade 2 Laminate	\$18,346	\$18,509	\$18,737	\$20,613
	Grade 1 Veneer	\$19,593	\$19,756	\$19,984	\$21,860
	Grade 2 Veneer	\$20,817	\$20,980	\$21,208	\$23,084

▶ Specification Information, continued on next page

Host Collection

Racetrack Tables with Three Bases *continued*
 DESIGN F/P DESIGN AND VECTA DESIGN TEAM

SIN 711.11

Tip: Prices shown include top, TAP(s), and slim bases.
 ▶ See base options for flared bases, page 236



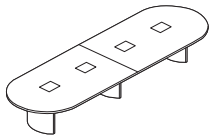
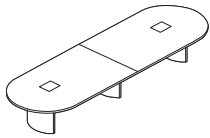
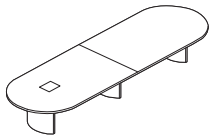
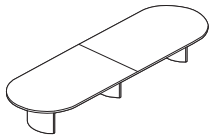

Tip: Last digit of style number indicates number of TAP(s).

Tip: For tech corridor, 16'L tables have eight long doors and four short doors.



▶ Specification Information, continued from previous page

Specification Information

Style Number	Finish	Base Prices			
					
		Flat Wood Edge:	Bullnose Wood Edge:	Beveled Wood Edge:	Horizon Wood Edge:

16'L x 60"W Two Piece Top

0 TAP

HS1660C20	Grade 1 Laminate	\$11,808	\$11,980	\$12,218	\$14,100
	Grade 2 Laminate	\$12,103	\$12,275	\$12,513	\$14,395
	Grade 1 Veneer	\$14,265	\$14,437	\$14,675	\$16,557
	Grade 2 Veneer	\$15,815	\$15,987	\$16,225	\$18,107

1 TAP

HS1660C21	Grade 1 Laminate	\$13,395	\$13,567	\$13,805	\$15,687
	Grade 2 Laminate	\$13,690	\$13,862	\$14,100	\$15,982
	Grade 1 Veneer	\$15,852	\$16,024	\$16,262	\$18,144
	Grade 2 Veneer	\$17,402	\$17,574	\$17,812	\$19,694

2 TAPS

HS1660C22	Grade 1 Laminate	\$14,982	\$15,154	\$15,392	\$17,274
	Grade 2 Laminate	\$15,277	\$15,449	\$15,687	\$17,569
	Grade 1 Veneer	\$17,439	\$17,611	\$17,849	\$19,731
	Grade 2 Veneer	\$18,989	\$19,161	\$19,399	\$21,281

4 TAPS

HS1660C24	Grade 1 Laminate	\$18,157	\$18,329	\$18,567	\$20,449
	Grade 2 Laminate	\$18,452	\$18,624	\$18,862	\$20,744
	Grade 1 Veneer	\$20,614	\$20,786	\$21,024	\$22,906
	Grade 2 Veneer	\$22,164	\$22,336	\$22,574	\$24,456

▶ Specification Information, continued on next page

Host Collection Racetrack Tables with Three Bases

DESIGN F/P DESIGN AND VECTA DESIGN TEAM

SIN 711.11

Tip: Prices shown include top, TAP(s), and slim bases.
 ▶ See base options for flared bases, page 236



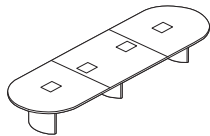
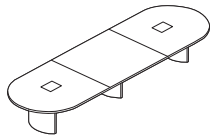
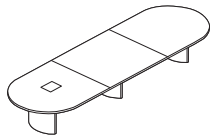
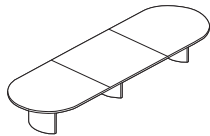

Tip: Last digit of style number indicates number of TAP(s).

Tip: For tech corridor, 16'L tables have eight long doors and four short doors.



▶ Specification Information, continued from previous page

Specification Information

Style Number	Finish	Base Prices			
		 Flat Wood Edge:	 Bullnose Wood Edge:	 Beveled Wood Edge:	 Horizon Wood Edge:

16'L x 60"W Three Piece Top

0 TAP					
HS1660C30	Grade 1 Laminate	\$12,187	\$12,359	\$12,597	\$14,479
	Grade 2 Laminate	\$12,482	\$12,654	\$12,892	\$14,774
	Grade 1 Veneer	\$14,644	\$14,816	\$15,054	\$16,936
	Grade 2 Veneer	\$16,194	\$16,366	\$16,604	\$18,486
1 TAP					
HS1660C31	Grade 1 Laminate	\$13,775	\$13,947	\$14,185	\$16,067
	Grade 2 Laminate	\$14,070	\$14,242	\$14,480	\$16,362
	Grade 1 Veneer	\$16,232	\$16,404	\$16,642	\$18,524
	Grade 2 Veneer	\$17,782	\$17,954	\$18,192	\$20,074
2 TAPS					
HS1660C32	Grade 1 Laminate	\$15,363	\$15,535	\$15,773	\$17,655
	Grade 2 Laminate	\$15,658	\$15,830	\$16,068	\$17,950
	Grade 1 Veneer	\$17,820	\$17,992	\$18,230	\$20,112
	Grade 2 Veneer	\$19,370	\$19,542	\$19,780	\$21,662
4 TAPS					
HS1660C34	Grade 1 Laminate	\$18,538	\$18,710	\$18,948	\$20,830
	Grade 2 Laminate	\$18,833	\$19,005	\$19,243	\$21,125
	Grade 1 Veneer	\$20,995	\$21,167	\$21,405	\$23,287
	Grade 2 Veneer	\$22,545	\$22,717	\$22,955	\$24,837

▶ Specification Information, continued on next page

Host Collection Racetrack Tables with Three Bases *continued*

DESIGN F/P DESIGN AND VECTA DESIGN TEAM

SIN 711.11

Tip: Prices shown include top, TAP(s), and slim bases.
 ▶ See base options for flared bases, page 236



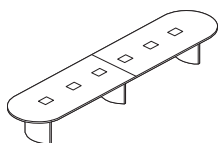
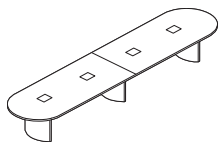
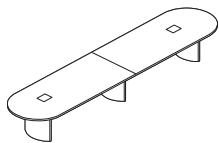
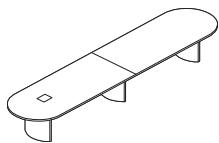
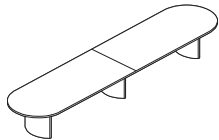

Tip: Last digit of style number indicates number of TAP(s).

Tip: For tech corridor, 18'L tables have eight long doors and four short doors.



▶ Specification Information, continued from previous page

Specification Information

Style Number	Finish	Base Prices			
					
		Flat Wood Edge:	Bullnose Wood Edge:	Beveled Wood Edge:	Horizon Wood Edge:

18'L x 48"W Two Piece Top

0 TAP

HS1848C20	Grade 1 Laminate	\$12,138	\$12,317	\$12,565	\$14,468
	Grade 2 Laminate	\$12,405	\$12,584	\$12,832	\$14,735
	Grade 1 Veneer	\$13,975	\$14,154	\$14,402	\$16,305
	Grade 2 Veneer	\$15,358	\$15,537	\$15,785	\$17,688

1 TAP

HS1848C21	Grade 1 Laminate	\$13,725	\$13,904	\$14,152	\$16,055
	Grade 2 Laminate	\$13,992	\$14,171	\$14,419	\$16,322
	Grade 1 Veneer	\$15,562	\$15,741	\$15,989	\$17,892
	Grade 2 Veneer	\$16,945	\$17,124	\$17,372	\$19,275

2 TAPS

HS1848C22	Grade 1 Laminate	\$15,312	\$15,491	\$15,739	\$17,642
	Grade 2 Laminate	\$15,579	\$15,758	\$16,006	\$17,909
	Grade 1 Veneer	\$17,149	\$17,328	\$17,576	\$19,479
	Grade 2 Veneer	\$18,532	\$18,711	\$18,959	\$20,862

4 TAPS

HS1848C24	Grade 1 Laminate	\$18,487	\$18,666	\$18,914	\$20,817
	Grade 2 Laminate	\$18,754	\$18,933	\$19,181	\$21,084
	Grade 1 Veneer	\$20,324	\$20,503	\$20,751	\$22,654
	Grade 2 Veneer	\$21,707	\$21,886	\$22,134	\$24,037

6 TAPS

HS1848C26	Grade 1 Laminate	\$21,662	\$21,841	\$22,089	\$23,992
	Grade 2 Laminate	\$21,929	\$22,108	\$22,356	\$24,259
	Grade 1 Veneer	\$23,499	\$23,678	\$23,926	\$25,829
	Grade 2 Veneer	\$24,882	\$25,061	\$25,309	\$27,212

▶ Specification Information, continued on next page

Host Collection Racetrack Tables with Three Bases

DESIGN F/P DESIGN AND VECTA DESIGN TEAM

SIN 711.11

Tip: Prices shown include top, TAP(s), and slim bases.
 ▶ See base options for flared bases, page 236

Tip: Last digit of style number indicates number of TAP(s).

Tip: For tech corridor, 18'L tables have eight long doors and four short doors.

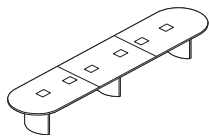
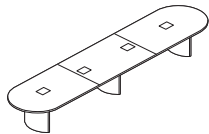
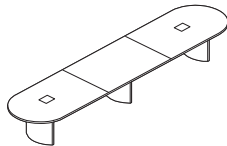
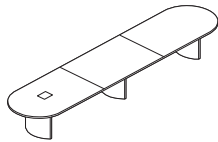
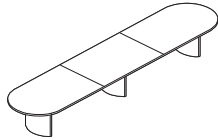

▶ Specification Information, continued from previous page

Specification Information

Style Number	Finish	Base Prices			
		Flat Wood Edge:	Bullnose Wood Edge:	Beveled Wood Edge:	Horizon Wood Edge:

18'L x 48"W Three Piece Top

0 TAP

HS1848C30	Grade 1 Laminate	\$12,518	\$12,697	\$12,945	\$14,848
	Grade 2 Laminate	\$12,785	\$12,964	\$13,212	\$15,115
	Grade 1 Veneer	\$14,355	\$14,534	\$14,782	\$16,685
	Grade 2 Veneer	\$15,738	\$15,917	\$16,165	\$18,068

1 TAP

HS1848C31	Grade 1 Laminate	\$14,105	\$14,284	\$14,532	\$16,435
	Grade 2 Laminate	\$14,372	\$14,551	\$14,799	\$16,702
	Grade 1 Veneer	\$15,942	\$16,121	\$16,369	\$18,272
	Grade 2 Veneer	\$17,325	\$17,504	\$17,752	\$19,655

2 TAPS

HS1848C32	Grade 1 Laminate	\$15,693	\$15,872	\$16,120	\$18,023
	Grade 2 Laminate	\$15,960	\$16,139	\$16,387	\$18,290
	Grade 1 Veneer	\$17,530	\$17,709	\$17,957	\$19,860
	Grade 2 Veneer	\$18,913	\$19,092	\$19,340	\$21,243

4 TAPS

HS1848C34	Grade 1 Laminate	\$18,867	\$19,046	\$19,294	\$21,197
	Grade 2 Laminate	\$19,134	\$19,313	\$19,561	\$21,464
	Grade 1 Veneer	\$20,704	\$20,883	\$21,131	\$23,034
	Grade 2 Veneer	\$22,087	\$22,266	\$22,514	\$24,417

6 TAPS

HS1848C36	Grade 1 Laminate	\$22,041	\$22,220	\$22,468	\$24,371
	Grade 2 Laminate	\$22,308	\$22,487	\$22,735	\$24,638
	Grade 1 Veneer	\$23,878	\$24,057	\$24,305	\$26,208
	Grade 2 Veneer	\$25,261	\$25,440	\$25,688	\$27,591

▶ Specification Information, continued on next page

Host Collection Racetrack Tables with Three Bases continued

DESIGN F/P DESIGN AND VECTA DESIGN TEAM

SIN 711.11

Tip: Prices shown include top, TAP(s), and slim bases.
 ▶ See base options for flared bases, page 236



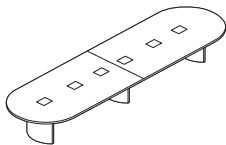
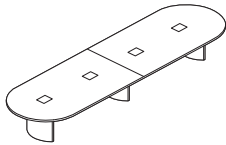
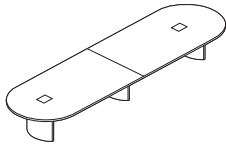
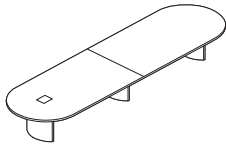
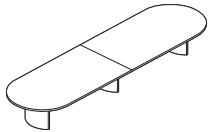

Tip: Last digit of style number indicates number of TAP(s).

Tip: For tech corridor, 18'L tables have eight long doors and four short doors.



▶ Specification Information, continued from previous page

Specification Information

Style Number	Finish	Base Prices			
					
		Flat Wood Edge:	Bullnose Wood Edge:	Beveled Wood Edge:	Horizon Wood Edge:

18'L x 60"W Two Piece Top

0 TAP					
HS1860C20	Grade 1 Laminate	\$12,345	\$12,531	\$12,793	\$14,693
	Grade 2 Laminate	\$12,678	\$12,864	\$13,126	\$15,026
	Grade 1 Veneer	\$15,551	\$15,737	\$15,999	\$17,899
	Grade 2 Veneer	\$17,306	\$17,492	\$17,754	\$19,654
1 TAP					
HS1860C21	Grade 1 Laminate	\$13,934	\$14,120	\$14,382	\$16,282
	Grade 2 Laminate	\$14,267	\$14,453	\$14,715	\$16,615
	Grade 1 Veneer	\$17,140	\$17,326	\$17,588	\$19,488
	Grade 2 Veneer	\$18,895	\$19,081	\$19,343	\$21,243
2 TAPS					
HS1860C22	Grade 1 Laminate	\$15,521	\$15,707	\$15,969	\$17,869
	Grade 2 Laminate	\$15,854	\$16,040	\$16,302	\$18,202
	Grade 1 Veneer	\$18,727	\$18,913	\$19,175	\$21,075
	Grade 2 Veneer	\$20,482	\$20,668	\$20,930	\$22,830
4 TAPS					
HS1860C24	Grade 1 Laminate	\$18,694	\$18,880	\$19,142	\$21,042
	Grade 2 Laminate	\$19,027	\$19,213	\$19,475	\$21,375
	Grade 1 Veneer	\$21,900	\$22,086	\$22,348	\$24,248
	Grade 2 Veneer	\$23,655	\$23,841	\$24,103	\$26,003
6 TAPS					
HS1860C26	Grade 1 Laminate	\$21,870	\$22,056	\$22,318	\$24,218
	Grade 2 Laminate	\$22,203	\$22,389	\$22,651	\$24,551
	Grade 1 Veneer	\$25,076	\$25,262	\$25,524	\$27,424
	Grade 2 Veneer	\$26,831	\$27,017	\$27,279	\$29,179

▶ Specification Information, continued on next page

Host Collection Racetrack Tables with Three Bases

DESIGN F/P DESIGN AND VECTA DESIGN TEAM

SIN 711.11

Tip: Prices shown include top, TAP(s), and slim bases.
 ▶ See base options for flared bases, page 236



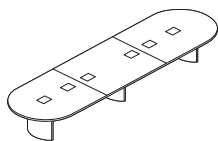
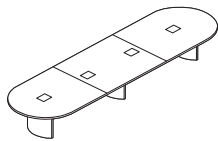
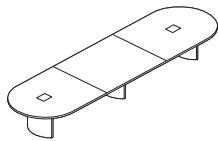
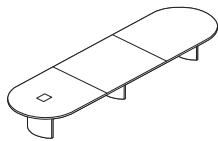
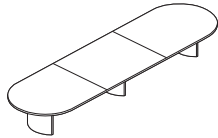

Tip: Last digit of style number indicates number of TAP(s).

Tip: For tech corridor, 18'L tables have eight long doors and four short doors.



► Specification Information, continued from previous page

Specification Information

Style Number	Finish	Base Prices			
					
		Flat Wood Edge:	Bullnose Wood Edge:	Beveled Wood Edge:	Horizon Wood Edge:

18'L x 60"W Three Piece Top

0 TAP

HS1860C30	Grade 1 Laminate	\$12,727	\$12,913	\$13,175	\$15,075
	Grade 2 Laminate	\$13,060	\$13,246	\$13,508	\$15,408
	Grade 1 Veneer	\$15,933	\$16,119	\$16,381	\$18,281
	Grade 2 Veneer	\$17,688	\$17,874	\$18,136	\$20,036

1 TAP

HS1860C31	Grade 1 Laminate	\$14,313	\$14,499	\$14,761	\$16,661
	Grade 2 Laminate	\$14,646	\$14,832	\$15,094	\$16,994
	Grade 1 Veneer	\$17,519	\$17,705	\$17,967	\$19,867
	Grade 2 Veneer	\$19,274	\$19,460	\$19,722	\$21,622

2 TAPS

HS1860C32	Grade 1 Laminate	\$15,901	\$16,087	\$16,349	\$18,249
	Grade 2 Laminate	\$16,234	\$16,420	\$16,682	\$18,582
	Grade 1 Veneer	\$19,107	\$19,293	\$19,555	\$21,455
	Grade 2 Veneer	\$20,862	\$21,048	\$21,310	\$23,210

4 TAPS

HS1860C34	Grade 1 Laminate	\$19,075	\$19,261	\$19,523	\$21,423
	Grade 2 Laminate	\$19,408	\$19,594	\$19,856	\$21,756
	Grade 1 Veneer	\$22,281	\$22,467	\$22,729	\$24,629
	Grade 2 Veneer	\$24,036	\$24,222	\$24,484	\$26,384

6 TAPS

HS1860C36	Grade 1 Laminate	\$22,250	\$22,436	\$22,698	\$24,598
	Grade 2 Laminate	\$22,583	\$22,769	\$23,031	\$24,931
	Grade 1 Veneer	\$25,456	\$25,642	\$25,904	\$27,804
	Grade 2 Veneer	\$27,211	\$27,397	\$27,659	\$29,559

► Specification Information, continued on next page

Host Collection

Racetrack Tables with Three Bases *continued*
 DESIGN F/P DESIGN AND VECTA DESIGN TEAM

SIN 711.11

Tip: Prices shown include top, TAP(s), and slim bases.
 ▶ See base options for flared bases, page 236



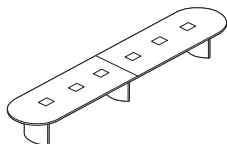
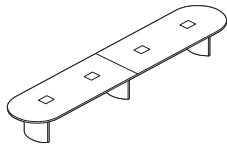
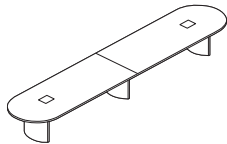
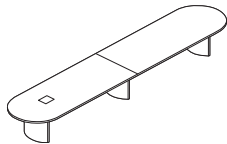
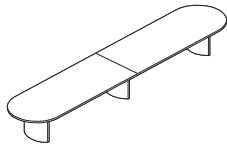

Tip: Last digit of style number indicates number of TAP(s).

Tip: For tech corridor, 20'L tables have eight long doors and four short doors.



▶ Specification Information, continued from previous page

Specification Information

Style Number	Finish	Base Prices			
					
		Flat Wood Edge:	Bullnose Wood Edge:	Beveled Wood Edge:	Horizon Wood Edge:

20'L x 48"W Two Piece Top

0 TAP

HS2048C20	Grade 1 Laminate	\$12,641	\$12,837	\$13,107	\$15,009
	Grade 2 Laminate	\$12,936	\$13,132	\$13,402	\$15,304
	Grade 1 Veneer	\$14,512	\$14,708	\$14,978	\$16,880
	Grade 2 Veneer	\$16,041	\$16,237	\$16,507	\$18,409

1 TAP

HS2048C21	Grade 1 Laminate	\$14,227	\$14,423	\$14,693	\$16,595
	Grade 2 Laminate	\$14,522	\$14,718	\$14,988	\$16,890
	Grade 1 Veneer	\$16,098	\$16,294	\$16,564	\$18,466
	Grade 2 Veneer	\$17,627	\$17,823	\$18,093	\$19,995

2 TAPS

HS2048C22	Grade 1 Laminate	\$15,815	\$16,011	\$16,281	\$18,183
	Grade 2 Laminate	\$16,110	\$16,306	\$16,576	\$18,478
	Grade 1 Veneer	\$17,686	\$17,882	\$18,152	\$20,054
	Grade 2 Veneer	\$19,215	\$19,411	\$19,681	\$21,583

4 TAPS

HS2048C24	Grade 1 Laminate	\$18,990	\$19,186	\$19,456	\$21,358
	Grade 2 Laminate	\$19,285	\$19,481	\$19,751	\$21,653
	Grade 1 Veneer	\$20,861	\$21,057	\$21,327	\$23,229
	Grade 2 Veneer	\$22,390	\$22,586	\$22,856	\$24,758

6 TAPS

HS2048C26	Grade 1 Laminate	\$22,165	\$22,361	\$22,631	\$24,533
	Grade 2 Laminate	\$22,460	\$22,656	\$22,926	\$24,828
	Grade 1 Veneer	\$24,036	\$24,232	\$24,502	\$26,404
	Grade 2 Veneer	\$25,565	\$25,761	\$26,031	\$27,933

▶ Specification Information, continued on next page

Host Collection Racetrack Tables with Three Bases

DESIGN F/P DESIGN AND VECTA DESIGN TEAM

SIN 711.11

Tip: Prices shown include top, TAP(s), and slim bases.
 ▶ See base options for flared bases, page 236



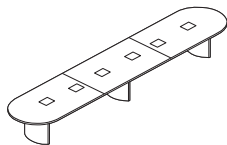
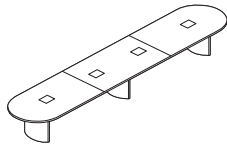
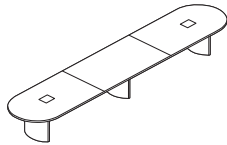
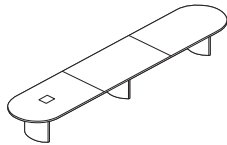
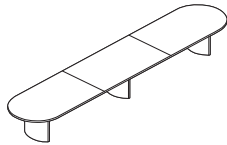

Tip: Last digit of style number indicates number of TAP(s).

Tip: For tech corridor, 20'L tables have eight long doors and four short doors.



▶ Specification Information, continued from previous page

Specification Information

Style Number	Finish	Base Prices			
		 Flat Wood Edge:	 Bullnose Wood Edge:	 Beveled Wood Edge:	 Horizon Wood Edge:

20'L x 48''W Three Piece Top

0 TAP					
HS2048C30	Grade 1 Laminate	\$13,021	\$13,217	\$13,487	\$15,389
	Grade 2 Laminate	\$13,316	\$13,512	\$13,782	\$15,684
	Grade 1 Veneer	\$14,892	\$15,088	\$15,358	\$17,260
	Grade 2 Veneer	\$16,421	\$16,617	\$16,887	\$18,789
1 TAP					
HS2048C31	Grade 1 Laminate	\$14,607	\$14,803	\$15,073	\$16,975
	Grade 2 Laminate	\$14,902	\$15,098	\$15,368	\$17,270
	Grade 1 Veneer	\$16,478	\$16,674	\$16,944	\$18,846
	Grade 2 Veneer	\$18,007	\$18,203	\$18,473	\$20,375
2 TAPS					
HS2048C32	Grade 1 Laminate	\$16,195	\$16,391	\$16,661	\$18,563
	Grade 2 Laminate	\$16,490	\$16,686	\$16,956	\$18,858
	Grade 1 Veneer	\$18,066	\$18,262	\$18,532	\$20,434
	Grade 2 Veneer	\$19,595	\$19,791	\$20,061	\$21,963
4 TAPS					
HS2048C34	Grade 1 Laminate	\$19,371	\$19,567	\$19,837	\$21,739
	Grade 2 Laminate	\$19,666	\$19,862	\$20,132	\$22,034
	Grade 1 Veneer	\$21,242	\$21,438	\$21,708	\$23,610
	Grade 2 Veneer	\$22,771	\$22,967	\$23,237	\$25,139
6 TAPS					
HS2048C36	Grade 1 Laminate	\$22,544	\$22,740	\$23,010	\$24,912
	Grade 2 Laminate	\$22,839	\$23,035	\$23,305	\$25,207
	Grade 1 Veneer	\$24,415	\$24,611	\$24,881	\$26,783
	Grade 2 Veneer	\$25,944	\$26,140	\$26,410	\$28,312

▶ Specification Information, continued on next page

Host Collection Racetrack Tables with Three Bases *continued*

DESIGN F/P DESIGN AND VECTA DESIGN TEAM

SIN 711.11

Tip: Prices shown include top, TAP(s), and slim bases.
 ▶ See base options for flared bases, page 236



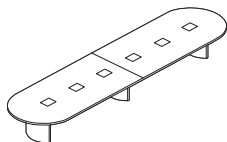
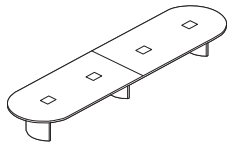
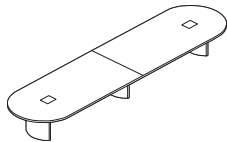
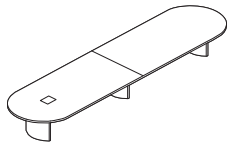
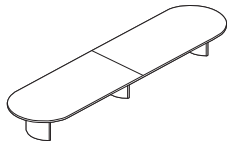

Tip: Last digit of style number indicates number of TAP(s).

Tip: For tech corridor, 20'L tables have eight long doors and four short doors.



▶ Specification Information, continued from previous page

Specification Information

Style Number	Finish	Base Prices			
					
		Flat Wood Edge:	Bullnose Wood Edge:	Beveled Wood Edge:	Horizon Wood Edge:

20'L x 60"W Two Piece Top

0 TAP

HS2060C20	Grade 1 Laminate	\$12,848	\$13,052	\$13,334	\$15,232
	Grade 2 Laminate	\$13,218	\$13,422	\$13,704	\$15,602
	Grade 1 Veneer	\$16,089	\$16,293	\$16,575	\$18,473
	Grade 2 Veneer	\$18,028	\$18,232	\$18,514	\$20,412

1 TAP

HS2060C21	Grade 1 Laminate	\$14,435	\$14,639	\$14,921	\$16,819
	Grade 2 Laminate	\$14,805	\$15,009	\$15,291	\$17,189
	Grade 1 Veneer	\$17,676	\$17,880	\$18,162	\$20,060
	Grade 2 Veneer	\$19,615	\$19,819	\$20,101	\$21,999

2 TAPS

HS2060C22	Grade 1 Laminate	\$16,023	\$16,227	\$16,509	\$18,407
	Grade 2 Laminate	\$16,393	\$16,597	\$16,879	\$18,777
	Grade 1 Veneer	\$19,264	\$19,468	\$19,750	\$21,648
	Grade 2 Veneer	\$21,203	\$21,407	\$21,689	\$23,587

4 TAPS

HS2060C24	Grade 1 Laminate	\$19,198	\$19,402	\$19,684	\$21,582
	Grade 2 Laminate	\$19,568	\$19,772	\$20,054	\$21,952
	Grade 1 Veneer	\$22,439	\$22,643	\$22,925	\$24,823
	Grade 2 Veneer	\$24,378	\$24,582	\$24,864	\$26,762

6 TAPS

HS2060C26	Grade 1 Laminate	\$22,372	\$22,576	\$22,858	\$24,756
	Grade 2 Laminate	\$22,742	\$22,946	\$23,228	\$25,126
	Grade 1 Veneer	\$25,613	\$25,817	\$26,099	\$27,977
	Grade 2 Veneer	\$27,552	\$27,756	\$28,038	\$29,936

▶ Specification Information, continued on next page

Host Collection Racetrack Tables with Three Bases

DESIGN F/P DESIGN AND VECTA DESIGN TEAM

SIN 711.11





Tip: Prices shown include top, TAP(s), and slim bases.
 ▶ See base options for flared bases, page 236

Tip: Last digit of style number indicates number of TAP(s).

Tip: For tech corridor, 20'L tables have eight long doors and four short doors.

▶ Specification Information, continued from previous page

Specification Information

Style Number	Finish	Base Prices			
					
		Flat Wood Edge:	Bullnose Wood Edge:	Beveled Wood Edge:	Horizon Wood Edge:

20'L x 60"W Three Piece Top

0 TAP

HS2060C30	Grade 1 Laminate	\$13,229	\$13,433	\$13,715	\$15,613
	Grade 2 Laminate	\$13,599	\$13,803	\$14,085	\$15,983
	Grade 1 Veneer	\$16,470	\$16,674	\$16,956	\$18,854
	Grade 2 Veneer	\$18,409	\$18,613	\$18,895	\$20,793

1 TAP

HS2060C31	Grade 1 Laminate	\$14,815	\$15,019	\$15,301	\$17,199
	Grade 2 Laminate	\$15,185	\$15,389	\$15,671	\$17,569
	Grade 1 Veneer	\$18,056	\$18,260	\$18,542	\$20,440
	Grade 2 Veneer	\$19,995	\$20,199	\$20,481	\$22,379

2 TAPS

HS2060C32	Grade 1 Laminate	\$16,403	\$16,607	\$16,889	\$18,787
	Grade 2 Laminate	\$16,773	\$16,977	\$17,259	\$19,157
	Grade 1 Veneer	\$19,644	\$19,848	\$20,130	\$22,028
	Grade 2 Veneer	\$21,583	\$21,787	\$22,069	\$23,967

4 TAPS

HS2060C34	Grade 1 Laminate	\$19,577	\$19,781	\$20,063	\$21,961
	Grade 2 Laminate	\$19,947	\$20,151	\$20,433	\$22,331
	Grade 1 Veneer	\$22,818	\$23,022	\$23,304	\$25,202
	Grade 2 Veneer	\$24,757	\$24,961	\$25,243	\$27,141

6 TAPS

HS2060C36	Grade 1 Laminate	\$22,751	\$22,955	\$23,237	\$25,135
	Grade 2 Laminate	\$23,121	\$23,325	\$23,607	\$25,505
	Grade 1 Veneer	\$25,992	\$26,196	\$26,478	\$28,376
	Grade 2 Veneer	\$27,931	\$28,135	\$28,417	\$30,315

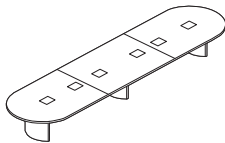
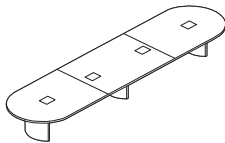
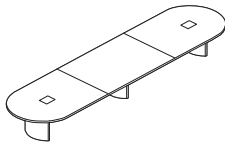
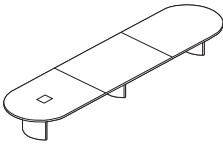
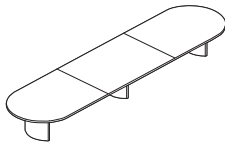

Host Collection Boat Shaped Tables with Two Bases

DESIGN F/P DESIGN AND VECTA DESIGN TEAM

SIN 711.11

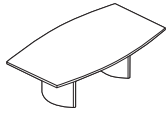

Tip: Shipped knocked down.

Tip: Grain direction for wood-grain laminate runs the length of the table.

Tip: Clips are provided with table: One clip per foot of table length.

Tip: The wood edge on a table top with woodgrain laminate may not match the top.

Tip: You must send a sample of reasonable size for Stain-to-Match.

Tip: 96"L tables available with zero, one, or two TAP(s). 10'L and 12'L tables available with zero, one, two, or three TAP(s).

Tip: Last digit of style number indicates number of TAP(s).

Tip: In addition to the data and audio/video AAPs available from Coalesse, other styles of AAPs are available through Extron Electronics. For an Extron dealer, call 1-800-633-9876.

Tip: See TAP options for electrical systems and faceplate list.

Standard Includes		Required to Specify
<ul style="list-style-type: none"> ▶ Need help? Product details, see <i>Coalesse Tables, Storage, and Accessories Specification Guide</i> 	<ul style="list-style-type: none"> • Top: 1¼" particle board core with laminate • Flat wood edge • TAP(s), if selected: 10"W x 12"L opening(s) trimmed with a flat solid wood profile and with brushed anodized aluminum TAP doors • Tech corridor: two aluminum beams for top support provide tracks for hinged aluminum doors that clip shut: satin anodized finish • Universal clip: black plastic • Two 27"W bases: wood veneer on MDF with aluminum universal bracket • Concealed leveling glides: non-marring, black plastic 	<ol style="list-style-type: none"> 1 Style number 2 Base section (see below) and wood color number for base 3 Laminate color number for table top, if selected 4 Wood color number for wood edge <p>▶ See <i>Hardwood and Veneer Matrix</i>, page 364</p> <ol style="list-style-type: none"> 5 Door color number for storage tray or TAP door, if selected: <ul style="list-style-type: none"> - 8044 Black - 8047 Silver 6 Options, if selected (see below) <p>▶ See <i>Surface Materials</i>, page 350.</p>

Options	Price	Required to Specify
Surface Materials <ul style="list-style-type: none"> • Top • Grade 2 laminate • Grade 1 wood veneer • Grade 2 wood veneer • Stain-to-Match 	<ul style="list-style-type: none"> Prices at right Prices at right Prices at right No cost 	<ul style="list-style-type: none"> Specify with <i>Grade 2 laminate</i> and select color number. Specify with <i>Grade 1 wood veneer</i> and select color number. Specify with <i>Grade 2 wood veneer</i> and select color number. Specify with <i>Stain-to-Match</i>. <p>▶ Page 385</p>

Edges	Wood	Price	Required to Specify
	<ul style="list-style-type: none"> • Bullnose wood edge 	Prices at right	Specify with <i>bullnose wood edge</i> .

Bases	Options	Price	Required to Specify
<p>Slim Flared</p>	<ul style="list-style-type: none"> • Two slim bases • One slim and one flared base • Two flared bases 	<ul style="list-style-type: none"> No cost +\$ 827 +\$1656 	<ul style="list-style-type: none"> Specify with <i>two slim bases</i>. Specify with <i>one slim base</i> and one flared base. Specify with <i>two flared bases</i>.

TAP Electrical System with Faceplate Options	Options	Price	Required to Specify
<p>Field Wired</p>	<ul style="list-style-type: none"> • Field-wired tray (no electrical) <ul style="list-style-type: none"> - PAFW field-wired tray (no electrical) with blank AAPs - PDFW field-wired tray (no electrical) with two data AAPs - PVFW field-wired tray (no electrical) with two of each video/audio and data AAPs 	No cost	Specify with <i>power data</i> , and select TAP type and TAP door color number.
<p>Cord and Plug</p>	<ul style="list-style-type: none"> • Cord and plug tray (10' cord) <ul style="list-style-type: none"> - PACP cord and plug tray with outlets and blank AAPs - PDCP cord and plug tray with outlets and two data AAPs - PAVC cord and plug tray with outlets and two of each video/audio and data AAPs 	No cost	Specify with <i>power data</i> , and select TAP type and TAP door color number.
<p>Hardwired</p>	<ul style="list-style-type: none"> • Hard-wired tray (6' conduit) <ul style="list-style-type: none"> - PAHW hard-wired tray with outlets and blank AAPs - PDHW hard-wired tray with outlets and two data AAPs - PAVH hard-wired tray with outlets and two of each video/audio and data AAPs 	No cost	Specify with <i>power data</i> , and select TAP type and TAP door color number.

▶ Options, continued on next page

Host Collection Boat Shaped Tables with Two Bases

DESIGN F/P DESIGN AND VECTA DESIGN TEAM

SIN 711.11

Tip: For single TAP style numbers, the modular system tray is not available. Specify the hardwired tray option.

Tip: If the specified table has multiple TAP(s), any one TAP can be replaced with a storage tray.

Tip: Wood veneer doors for storage tray and TAP(s) will always be cross grain.

Tip: Connectrac must be the same wiring schematic as the table.

► Options, continued from previous page

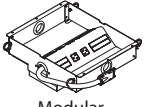
Options	Price	Required to Specify
TAP Electrical System with Faceplate Options  Modular	<ul style="list-style-type: none"> Modular system tray (hardwire base power infeed) <ul style="list-style-type: none"> - PAMH modular system tray with outlets and blank AAPs - PDMH modular system tray with outlets and two data AAPs - PVMH modular system tray with outlets and two of each video/audio and data AAPs +\$141 each tray	Specify with <i>modular power data</i> , and select TAP type and TAP door color number.
Storage Tray	<ul style="list-style-type: none"> Storage tray -\$593	Specify with <i>storage tray</i> and select door color number.
Doors	<ul style="list-style-type: none"> Storage tray wood veneer doors +\$298 per door TAP wood veneer doors +\$298 per door 	Specify with <i>wood doors</i> .
Related Products	<ul style="list-style-type: none"> Floor kit: Connectrac Corridor shelf 	► Page 283 ► Page 283

TAP Locations

96"L, 54"W Center, 42"W End TAP Locations—One piece top

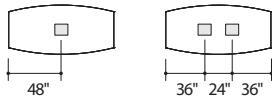

10'L, 60"W Center, 48"W End TAP Locations—One piece top

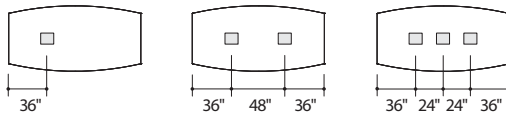

10'L, 60"W Center, 48"W End TAP Locations—Two piece top

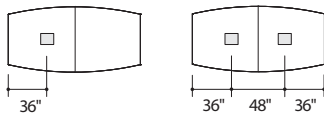

12'L, 60"W Center, 48"W End TAP Locations—One piece top

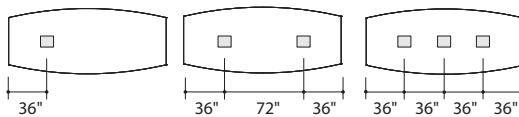

12'L, 60"W Center, 48"W Ends TAP Locations—Two piece top

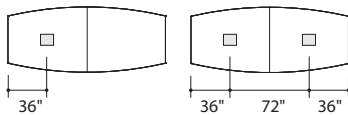

► Specification Information, on next page

Host Collection Boat Shaped Tables with Two Bases *continued*

DESIGN F/P DESIGN AND VECTA DESIGN TEAM

SIN 711.11

Tip: Prices shown include top, TAP(s), and slim bases.
 ▶ See base options for flared bases, page 256

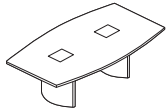
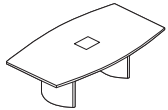
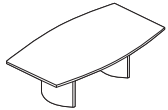

Tip: Last digit of style number indicates number of TAP(s).

Tip: For tech corridor, 96"L tables have two long doors and four short doors.



▶ Options, on previous page

Specification Information

Style Number	Finish	Base Prices	
			
		Flat Wood Edge:	Bullnose Wood Edge:

96"L, 54"W Center, 42"W End One Piece Top

0 TAP

Style Number	Finish	Flat Wood Edge	Bullnose Wood Edge
HS9654B10	Grade 1 Laminate	\$ 6884	\$ 6984
	Grade 2 Laminate	\$ 7002	\$ 7102
	Grade 1 Veneer	\$ 7584	\$ 7684
	Grade 2 Veneer	\$ 8194	\$ 8294

1 TAP

Style Number	Finish	Flat Wood Edge	Bullnose Wood Edge
HS9654B11	Grade 1 Laminate	\$ 8470	\$ 8570
	Grade 2 Laminate	\$ 8588	\$ 8688
	Grade 1 Veneer	\$ 9170	\$ 9270
	Grade 2 Veneer	\$ 9780	\$ 9880

2 TAPS

Style Number	Finish	Flat Wood Edge	Bullnose Wood Edge
HS9654B12	Grade 1 Laminate	\$10,057	\$10,157
	Grade 2 Laminate	\$10,175	\$10,275
	Grade 1 Veneer	\$10,757	\$10,857
	Grade 2 Veneer	\$11,367	\$11,467

▶ Specification Information, continued on next page

Host Collection

Boat Shaped Tables with Two Bases
DESIGN F/P DESIGN AND VECTA DESIGN TEAM

SIN 711.11

Tip: Prices shown include top, TAP(s), and slim bases.
▶ See base options for flared bases, page 256

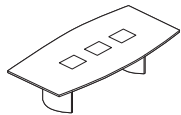
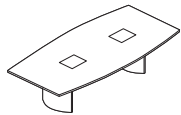
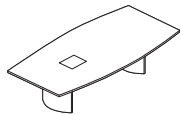
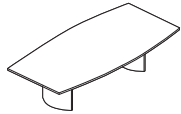

Tip: Last digit of style number indicates number of TAP(s).

Tip: For tech corridor, 10'L tables have four long doors and four short doors.



▶ Specification Information, continued from previous page

Specification Information

Style Number	Finish	Base Prices	
			
		Flat Wood Edge:	Bullnose Wood Edge:

10'L, 60"W Center, 48"W End One Piece Top

0 TAP

HS1060B10	Grade 1 Laminate	\$ 7644	\$ 7768
	Grade 2 Laminate	\$ 7827	\$ 7951
	Grade 1 Veneer	\$ 8974	\$ 9098
	Grade 2 Veneer	\$ 9936	\$10,060

1 TAP

HS1060B11	Grade 1 Laminate	\$ 9232	\$ 9356
	Grade 2 Laminate	\$ 9415	\$ 9539
	Grade 1 Veneer	\$10,562	\$10,686
	Grade 2 Veneer	\$11,524	\$11,648

2 TAPS

HS1060B12	Grade 1 Laminate	\$10,821	\$10,945
	Grade 2 Laminate	\$11,004	\$11,128
	Grade 1 Veneer	\$12,151	\$12,275
	Grade 2 Veneer	\$13,113	\$13,237

3 TAPS

HS1060B13	Grade 1 Laminate	\$12,408	\$12,532
	Grade 2 Laminate	\$12,591	\$12,715
	Grade 1 Veneer	\$13,738	\$13,862
	Grade 2 Veneer	\$14,700	\$14,824

▶ Specification Information, continued on next page

Host Collection Boat Shaped Tables with Two Bases *continued*

DESIGN F/P DESIGN AND VECTA DESIGN TEAM

SIN 711.11

Tip: Prices shown include top, TAP(s), and slim bases.
 ▶ See base options for flared bases, page 256

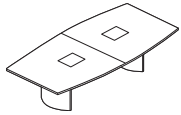
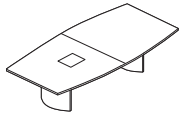
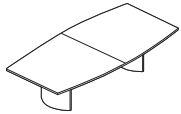

Tip: Last digit of style number indicates number of TAP(s).

Tip: For tech corridor, 10'L tables have four long doors and four short doors.



▶ Specification Information, continued from previous page

Specification Information

Style Number	Finish	Base Prices	
			
		Flat Wood Edge:	Bullnose Wood Edge:

10'L, 60"W Center, 48"W End Two Piece Top

0 TAP

HS1060B20	Grade 1 Laminate	\$ 8026	\$ 8150
	Grade 2 Laminate	\$ 8209	\$ 8333
	Grade 1 Veneer	\$ 9356	\$ 9480
	Grade 2 Veneer	\$10,318	\$10,442

1 TAP

HS1060B21	Grade 1 Laminate	\$ 9613	\$ 9737
	Grade 2 Laminate	\$ 9796	\$ 9920
	Grade 1 Veneer	\$10,943	\$11,067
	Grade 2 Veneer	\$11,905	\$12,029

2 TAPS

HS1060B22	Grade 1 Laminate	\$11,199	\$11,323
	Grade 2 Laminate	\$11,382	\$11,506
	Grade 1 Veneer	\$12,529	\$12,653
	Grade 2 Veneer	\$13,491	\$13,615

▶ Specification Information, continued on next page

Host Collection

Boat Shaped Tables with Two Bases
DESIGN F/P DESIGN AND VECTA DESIGN TEAM

SIN 711.11

Tip: Prices shown include top, TAP(s), and slim bases.
▶ See base options for flared bases, page 256

Tip: Last digit of style number indicates number of TAP(s).

Tip: For tech corridor, 12'L tables have four long doors and four short doors.

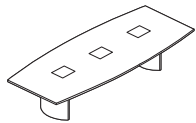
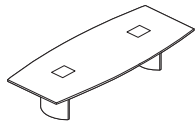
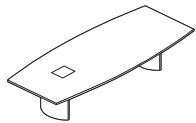
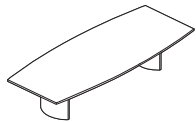

▶ Specification Information, continued from previous page

Specification Information

Style Number	Finish	Base Prices	
		Flat Wood Edge:	Bullnose Wood Edge:

12'L, 60"W Center, 48"W End One Piece Top

0 TAP			
HS1260B10	Grade 1 Laminate	\$ 8203	\$ 8341
	Grade 2 Laminate	\$ 8424	\$ 8562
	Grade 1 Veneer	\$ 9818	\$ 9956
	Grade 2 Veneer	\$10,974	\$11,112
1 TAP			
HS1260B11	Grade 1 Laminate	\$ 9791	\$ 9929
	Grade 2 Laminate	\$10,012	\$10,150
	Grade 1 Veneer	\$11,406	\$11,544
	Grade 2 Veneer	\$12,562	\$12,700
2 TAPS			
HS1260B12	Grade 1 Laminate	\$11,376	\$11,514
	Grade 2 Laminate	\$11,597	\$11,735
	Grade 1 Veneer	\$12,991	\$13,129
	Grade 2 Veneer	\$14,147	\$14,285
3 TAPS			
HS1260B13	Grade 1 Laminate	\$12,964	\$13,102
	Grade 2 Laminate	\$13,185	\$13,323
	Grade 1 Veneer	\$14,579	\$14,717
	Grade 2 Veneer	\$15,735	\$15,873

▶ Specification Information, continued on next page

Host Collection

Boat Shaped Tables with Two Bases *continued*
 DESIGN F/P DESIGN AND VECTA DESIGN TEAM

SIN 711.11

Tip: Prices shown include top, TAP(s), and slim bases.
 ▶ See base options for flared bases, page 256

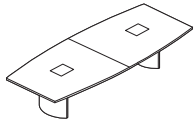
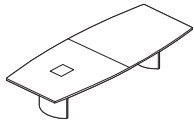
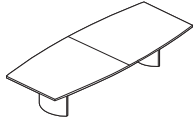

Tip: Last digit of style number indicates number of TAP(s).

Tip: For tech corridor, 12'L tables have four long doors and four short doors.



▶ Specification Information, continued from previous page

Specification Information

Style Number	Finish	Base Prices	
			
		Flat Wood Edge:	Bullnose Wood Edge:

12'L, 60"W Center, 48"W End Two Piece Top

0 TAP

HS1260B20	Grade 1 Laminate	\$ 8583	\$ 8721
	Grade 2 Laminate	\$ 8804	\$ 8942
	Grade 1 Veneer	\$10,198	\$10,336
	Grade 2 Veneer	\$11,354	\$11,492

1 TAP

HS1260B21	Grade 1 Laminate	\$10,170	\$10,308
	Grade 2 Laminate	\$10,391	\$10,529
	Grade 1 Veneer	\$11,785	\$11,923
	Grade 2 Veneer	\$12,941	\$13,079

2 TAPS

HS1260B22	Grade 1 Laminate	\$11,757	\$11,895
	Grade 2 Laminate	\$11,978	\$12,116
	Grade 1 Veneer	\$13,372	\$13,510
	Grade 2 Veneer	\$14,528	\$14,666

Coalesse

Host Collection

Boat Shaped Tables with Two Bases
DESIGN F/P DESIGN AND VECTA DESIGN TEAM

SIN 711.11

Host Collection Boat Shaped Tables with Three Bases

DESIGN F/P DESIGN AND VECTA DESIGN TEAM

SIN 711.11

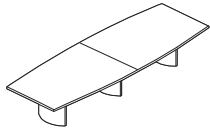

Tip: Shipped knocked down.

Tip: Grain direction for wood-grain laminate runs the length of the table.

Tip: Clips are provided with table: One clip per foot of table length.

Tip: The wood edge on a table top with woodgrain laminate may not match the top.

Tip: You must send a sample of reasonable size for Stain-to-Match.

Standard Includes		Required to Specify
<ul style="list-style-type: none"> ▶ Need help? Product details, see <i>Coalesse Tables, Storage, and Accessories Specification Guide</i> 	<ul style="list-style-type: none"> • Top: 1¼" particle board core with laminate • Flat wood edge • TAP(s), if selected: 10"W x 12"L opening(s) trimmed with a flat solid wood profile and with brushed anodized aluminum TAP doors • Tech corridor: four aluminum beams for top support provide tracks for hinged aluminum doors that clip shut: satin anodized finish • Universal clip: black plastic • Three 27"W bases: wood veneer on MDF with aluminum universal bracket • Concealed leveling glides: non-marring, black plastic 	<ol style="list-style-type: none"> 1 Style number 2 Base selection 3 Laminate color number for table top, if selected 4 Wood color number for wood edge <p>▶ See <i>Veneer Matrix</i>, page 365</p> <ol style="list-style-type: none"> 5 Laminate color number for table top 6 Door color number for storage tray or TAP door, if selected: <ul style="list-style-type: none"> - 8044 Black - 8047 Silver 7 Options, if selected (see below) <p>▶ See <i>Surface Materials</i>, page 350.</p>

Options	Price	Required to Specify
Surface Materials <ul style="list-style-type: none"> • Top • Grade 2 laminate • Grade 1 wood veneer • Grade 2 wood veneer • Stain-to-Match 	<ul style="list-style-type: none"> Prices at right Prices at right Prices at right No cost 	<ul style="list-style-type: none"> Specify with <i>Grade 2 laminate</i> and select color number. Specify with <i>Grade 1 wood veneer</i> and select color number. Specify with <i>Grade 2 wood veneer</i> and select color number. Specify with <i>Stain-to-Match</i>. <p>▶ Page 385</p>

Edges	Wood	Price	Required to Specify
	<ul style="list-style-type: none"> • Bullnose wood edge 	Prices at right	Specify with <i>bullnose wood edge</i> .

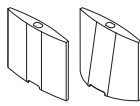
Bases	Price	Required to Specify
 <ul style="list-style-type: none"> • Three slim bases • Two slim and one flared bases • One slim and two flared bases • Three flared bases 	<ul style="list-style-type: none"> No cost +\$ 827 +\$1654 +\$2481 	<ul style="list-style-type: none"> Specify with <i>three slim bases</i>. Specify with <i>two slim</i> and one flared bases. Specify with <i>one slim</i> and two flared bases. Specify with <i>three flared bases</i>.

Tip: 14'L and 16'L tables available with zero, one, two, or four TAP(s). 18'L and 20'L tables available with zero, one, two, four, or six TAP(s).

Tip: In addition to the data and audio/video AAPs available from Coalesse, other styles of AAPs are available through Extron Electronics. For an Extron dealer, call 1.800.633.9876.

Tip: See TAP options for electrical systems and faceplate list.

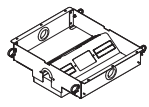
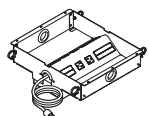
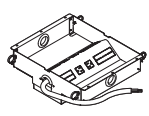
TAP Electrical System with Faceplate Options	Price	Required to Specify
 <ul style="list-style-type: none"> • Field-wired tray (no electrical) <ul style="list-style-type: none"> - PAFW field-wired tray (no electrical) with blank AAPs - PDFW field-wired tray (no electrical) with two data AAPs - PVFW field-wired tray (no electrical) with two of each video/audio and data AAPs 	No cost	Specify with <i>power data</i> , and select TAP type and TAP door color number.
 <ul style="list-style-type: none"> • Cord and plug tray (10' cord) <ul style="list-style-type: none"> - PACP cord and plug tray with outlets and blank AAPs - PDCP cord and plug tray with outlets and two data AAPs - PAVC cord and plug tray with outlets and two of each video/audio and data AAPs 	No cost	Specify with <i>power data</i> , and select TAP type and TAP door color number.
 <ul style="list-style-type: none"> • Hard-wired tray (6' conduit) <ul style="list-style-type: none"> - PAHW hard-wired tray with outlets and blank AAPs - PDHW hard-wired tray with outlets and two data AAPs - PAVH hard-wired tray with outlets and two of each video/audio and data AAPs 	No cost	Specify with <i>power data</i> , and select TAP type and TAP door color number.

▶ Options, continued on next page

Host Collection

Boat Shaped Tables with Three Bases
DESIGN F/P DESIGN AND VECTA DESIGN TEAM

SIN 711.11

Tip: For single TAP style numbers, the modular system tray is not available. Specify the hard-wired tray option.

Tip: If the specified table has multiple TAP(s), any one TAP can be replaced with a storage tray.

Tip: Wood veneer doors for storage tray or TAP will always be cross grain.

Tip: Connectrac must be the same wiring schematic as the table.

► Options, continued from previous page

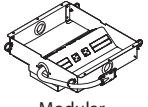
Options	Price	Required to Specify
TAP Electrical System with Faceplate Options  Modular	<ul style="list-style-type: none"> Modular system tray (hardwire base power infeed) <ul style="list-style-type: none"> - PAMH modular system tray with outlets and blank AAPs - PDMH modular system tray with outlets and two data AAPs - PVMH modular system tray with outlets and two of each video/audio and data AAPs +\$141 each tray	Specify with <i>modular power data</i> , and select TAP type and TAP door color number.
Storage Tray	<ul style="list-style-type: none"> Storage tray -\$593	Specify with <i>storage tray</i> and select door color number.
Doors	<ul style="list-style-type: none"> Storage tray wood veneer doors TAP wood veneer doors +\$298 per door +\$298 per door	Specify with <i>wood doors</i> . Specify with <i>wood doors</i> .
Related Products	<ul style="list-style-type: none"> Floor kit: Connectrac Corridor shelf 	► Page 283 ► Page 283

TAP Locations

14'L, 60"W Center, 48"W End TAP Locations—Two piece top

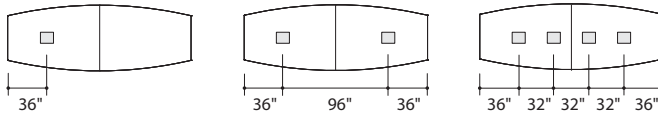

14'L, 60"W Center, 48"W End TAP Locations—Three piece top

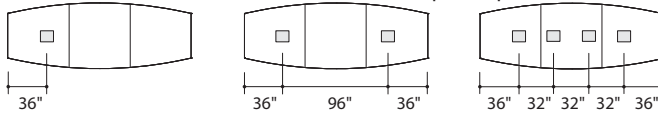

16'L, 60"W Center, 48"W End TAP Locations—Two piece top

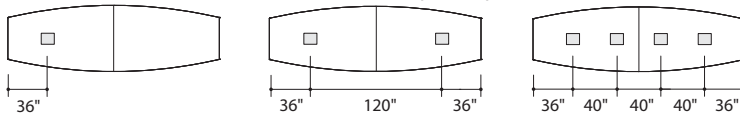

16'L, 60"W Center, 48"W End TAP Locations—Three piece top

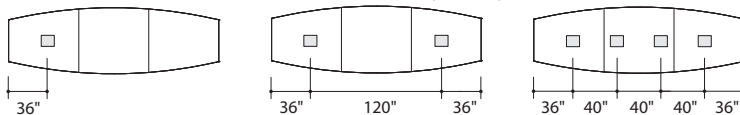

► Options, continued on next page

Host Collection

Boat Shaped Tables with Three Bases *continued*
DESIGN F/P DESIGN AND VECTA DESIGN TEAM

SIN 711.11

► Options, continued from previous page

TAP Locations

18'L, 60"W Center, 48"W End TAP Locations—Two piece top

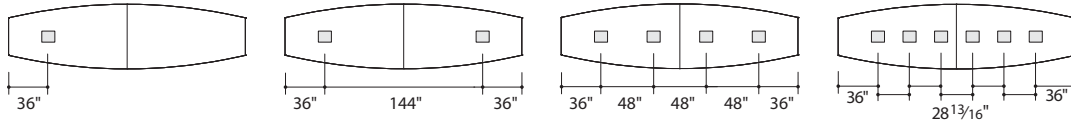

18'L, 60"W Center, 48"W End TAP Locations—Three piece top

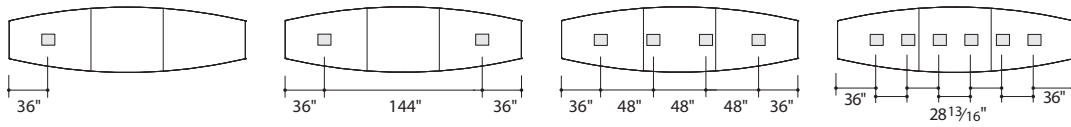

20'L, 60"W Center, 48"W End TAP Locations—Two piece top

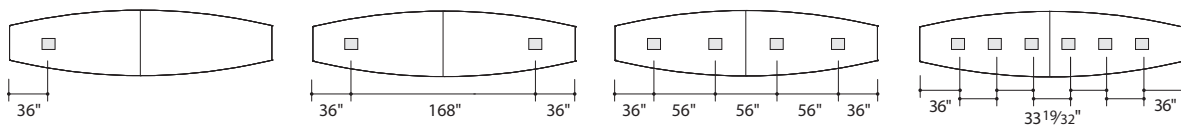

20'L, 60"W Center, 48"W End TAP Locations—Three piece top

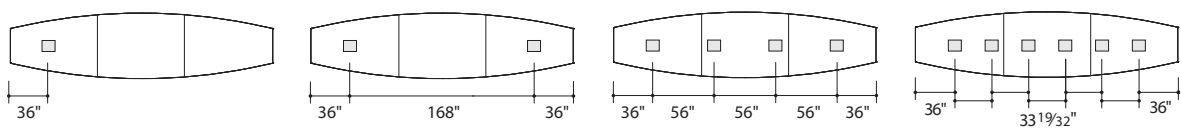

Host Collection

Boat Shaped Tables with Three Bases
DESIGN F/P DESIGN AND VECTA DESIGN TEAM

SIN 711.11



Tip: Prices shown include top, TAP(s), and slim bases.
► See base options for flared bases, page 264

Tip: Last digit of style number indicates number of TAP(s).

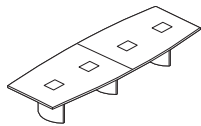
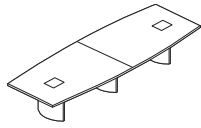
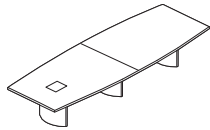
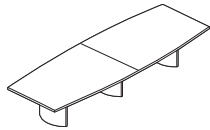
Tip: For tech corridor, 14'L tables have four long doors and four short doors.



Specification Information

Style Number	Finish	Base Prices	
			
		Flat Wood Edge:	Bullnose Wood Edge:

14'L, 60"W Center, 48"W End Two Piece Top

0 TAP

HS1460B20	Grade 1 Laminate	\$11,306	\$11,462
	Grade 2 Laminate	\$11,566	\$11,722
	Grade 1 Veneer	\$13,732	\$13,888
	Grade 2 Veneer	\$15,094	\$15,250

1 TAP

HS1460B21	Grade 1 Laminate	\$12,895	\$13,051
	Grade 2 Laminate	\$13,155	\$13,311
	Grade 1 Veneer	\$15,321	\$15,477
	Grade 2 Veneer	\$16,683	\$16,839

2 TAPS

HS1460B22	Grade 1 Laminate	\$14,481	\$14,637
	Grade 2 Laminate	\$14,741	\$14,897
	Grade 1 Veneer	\$16,907	\$17,063
	Grade 2 Veneer	\$18,269	\$18,425

4 TAPS

HS1460B24	Grade 1 Laminate	\$17,655	\$17,811
	Grade 2 Laminate	\$17,915	\$18,071
	Grade 1 Veneer	\$20,081	\$20,237
	Grade 2 Veneer	\$21,443	\$21,599

► Specification Information, continued on next page

Host Collection Boat Shaped Tables with Three Bases *continued*

DESIGN F/P DESIGN AND VECTA DESIGN TEAM

SIN 711.11

Tip: Prices shown include top, TAP(s), and slim bases.
 ▶ See base options for flared bases, page 264

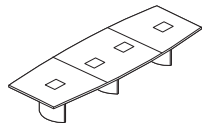
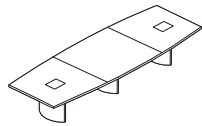
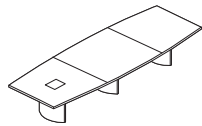
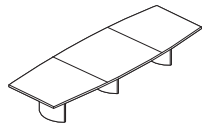

Tip: Last digit of style number indicates number of TAP(s).

Tip: For tech corridor, 14'L tables have four long doors and four short doors.



▶ Specification Information, continued from previous page

Specification Information

Style Number	Finish	Base Prices	
			
		Flat Wood Edge:	Bullnose Wood Edge:

14'L, 60"W Center, 48"W End Three Piece Top

0 TAP

HS1460B30	Grade 1 Laminate	\$11,687	\$11,843
	Grade 2 Laminate	\$11,947	\$12,103
	Grade 1 Veneer	\$14,113	\$14,269
	Grade 2 Veneer	\$15,475	\$15,631

1 TAP

HS1460B31	Grade 1 Laminate	\$13,273	\$13,429
	Grade 2 Laminate	\$13,533	\$13,689
	Grade 1 Veneer	\$15,699	\$15,855
	Grade 2 Veneer	\$17,061	\$17,217

2 TAPS

HS1460B32	Grade 1 Laminate	\$14,861	\$15,017
	Grade 2 Laminate	\$15,121	\$15,277
	Grade 1 Veneer	\$17,287	\$17,443
	Grade 2 Veneer	\$18,649	\$18,805

4 TAPS

HS1460B34	Grade 1 Laminate	\$18,036	\$18,192
	Grade 2 Laminate	\$18,296	\$18,452
	Grade 1 Veneer	\$20,462	\$20,618
	Grade 2 Veneer	\$21,824	\$21,980

▶ Specification Information, continued on next page

Host Collection

Boat Shaped Tables with Three Bases
DESIGN F/P DESIGN AND VECTA DESIGN TEAM

SIN 711.11

Tip: Prices shown include top, TAP(s), and slim bases.
▶ See base options for flared bases, page 264

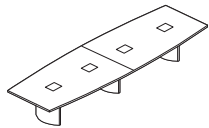
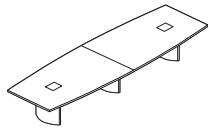
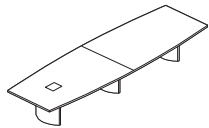
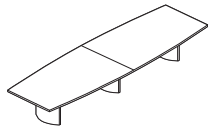

Tip: Last digit of style number indicates number of TAP(s).

Tip: For tech corridor, 16'L tables have eight long doors and four short doors.



▶ Specification Information, continued from previous page

Specification Information

Style Number	Finish	Base Prices	
			
		Flat Wood Edge:	Bullnose Wood Edge:

16'L, 60"W Center, 48"W End Two Piece Top

0 TAP			
HS1660B20	Grade 1 Laminate	\$11,808	\$11,980
	Grade 2 Laminate	\$12,103	\$12,275
	Grade 1 Veneer	\$14,265	\$14,437
	Grade 2 Veneer	\$15,815	\$15,987
1 TAP			
HS1660B21	Grade 1 Laminate	\$13,395	\$13,567
	Grade 2 Laminate	\$13,690	\$13,862
	Grade 1 Veneer	\$15,852	\$16,024
	Grade 2 Veneer	\$17,402	\$17,574
2 TAPS			
HS1660B22	Grade 1 Laminate	\$14,982	\$15,154
	Grade 2 Laminate	\$15,277	\$15,449
	Grade 1 Veneer	\$17,439	\$17,611
	Grade 2 Veneer	\$18,989	\$19,161
4 TAPS			
HS1660B24	Grade 1 Laminate	\$18,157	\$18,329
	Grade 2 Laminate	\$18,452	\$18,624
	Grade 1 Veneer	\$20,614	\$20,786
	Grade 2 Veneer	\$22,164	\$22,336

▶ Specification Information, continued on next page

Host Collection Boat Shaped Tables with Three Bases *continued*

DESIGN F/P DESIGN AND VECTA DESIGN TEAM

SIN 711.11

Tip: Prices shown include top, TAP(s), and slim bases.
 ▶ See base options for flared bases, page 264

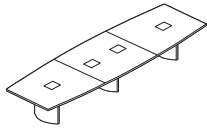
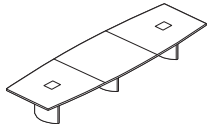
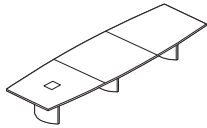
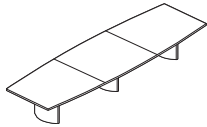

Tip: Last digit of style number indicates number of TAP(s).

Tip: For tech corridor, 16'L tables have eight long doors and four short doors.



▶ Specification Information, continued from previous page

Specification Information

Style Number	Finish	Base Prices	
			
		Flat Wood Edge:	Bullnose Wood Edge:

16'L, 60"W Center, 48"W End Three Piece Top

0 TAP

HS1660B30	Grade 1 Laminate	\$ 12,187	\$12,359
	Grade 2 Laminate	\$12,482	\$12,654
	Grade 1 Veneer	\$14,644	\$14,816
	Grade 2 Veneer	\$ 16,194	\$16,366

1 TAP

HS1660B31	Grade 1 Laminate	\$13,775	\$13,947
	Grade 2 Laminate	\$14,070	\$14,242
	Grade 1 Veneer	\$16,232	\$16,404
	Grade 2 Veneer	\$17,782	\$17,954

2 TAPS

HS1660B32	Grade 1 Laminate	\$15,363	\$15,535
	Grade 2 Laminate	\$15,658	\$15,830
	Grade 1 Veneer	\$17,820	\$17,992
	Grade 2 Veneer	\$19,370	\$19,542

4 TAPS

HS1660B34	Grade 1 Laminate	\$18,538	\$18,710
	Grade 2 Laminate	\$18,833	\$19,005
	Grade 1 Veneer	\$20,995	\$21,167
	Grade 2 Veneer	\$22,545	\$22,717

▶ Specification Information, continued on next page

Host Collection

Boat Shaped Tables with Three Bases
DESIGN F/P DESIGN AND VECTA DESIGN TEAM

SIN 711.11

Tip: Prices shown include top, TAP(s), and slim bases.
▶ See base options for flared bases, page 264

Tip: Last digit of style number indicates number of TAP(s).

Tip: For tech corridor, 18'L tables have eight long doors and four short doors.

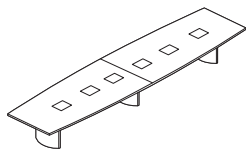
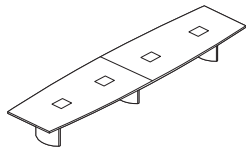
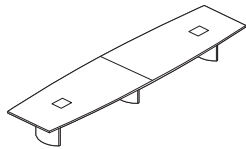
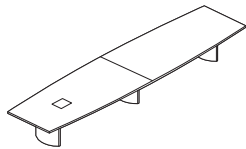
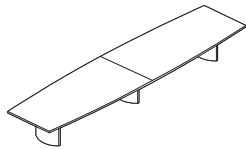

▶ Specification Information, continued from previous page

Specification Information

Style Number	Finish	Base Prices	
		Flat Wood Edge:	Bullnose Wood Edge:

18'L, 60"W Center, 48"W End Two Piece Top

0 TAP			
HS1860B20	Grade 1 Laminate	\$12,345	\$12,531
	Grade 2 Laminate	\$12,678	\$12,864
	Grade 1 Veneer	\$15,551	\$15,737
	Grade 2 Veneer	\$17,306	\$17,492
1 TAP			
HS1860B21	Grade 1 Laminate	\$13,934	\$14,120
	Grade 2 Laminate	\$14,267	\$14,453
	Grade 1 Veneer	\$17,140	\$17,326
	Grade 2 Veneer	\$18,895	\$19,081
2 TAPS			
HS1860B22	Grade 1 Laminate	\$15,521	\$15,707
	Grade 2 Laminate	\$15,854	\$16,040
	Grade 1 Veneer	\$18,727	\$18,913
	Grade 2 Veneer	\$20,482	\$20,668
4 TAPS			
HS1860B24	Grade 1 Laminate	\$18,694	\$18,880
	Grade 2 Laminate	\$19,027	\$19,213
	Grade 1 Veneer	\$21,900	\$22,086
	Grade 2 Veneer	\$23,655	\$23,841
6 TAPS			
HS1860B26	Grade 1 Laminate	\$21,870	\$22,056
	Grade 2 Laminate	\$22,203	\$22,389
	Grade 1 Veneer	\$25,076	\$25,262
	Grade 2 Veneer	\$26,831	\$27,017

▶ Specification Information, continued on next page

Host Collection Boat Shaped Tables with Three Bases *continued*

DESIGN F/P DESIGN AND VECTA DESIGN TEAM

SIN 711.11

Tip: Prices shown include top, TAP(s), and slim bases.
 ▶ See base options for flared bases, page 264

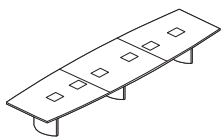
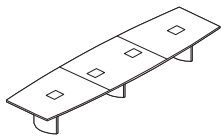
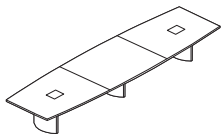
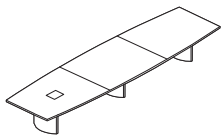
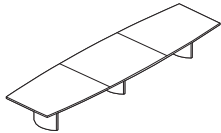

Tip: Last digit of style number indicates number of TAP(s).

Tip: For tech corridor, 18'L tables have eight long doors and four short doors.



▶ Specification Information, continued from previous page

Specification Information

Style Number	Finish	Base Prices	
			
		Flat Wood Edge:	Bullnose Wood Edge:

18'L, 60"W Center, 48"W End Three Piece Top

0 TAP

HS1860B30	Grade 1 Laminate	\$12,727	\$12,913
	Grade 2 Laminate	\$13,060	\$13,246
	Grade 1 Veneer	\$15,933	\$16,119
	Grade 2 Veneer	\$17,688	\$17,874

1 TAP

HS1860B31	Grade 1 Laminate	\$14,313	\$14,499
	Grade 2 Laminate	\$14,646	\$14,832
	Grade 1 Veneer	\$17,519	\$17,705
	Grade 2 Veneer	\$19,274	\$19,460

2 TAPS

HS1860B32	Grade 1 Laminate	\$15,901	\$16,087
	Grade 2 Laminate	\$16,234	\$16,420
	Grade 1 Veneer	\$ 19,107	\$19,293
	Grade 2 Veneer	\$20,862	\$21,048

4 TAPS

HS1860B34	Grade 1 Laminate	\$19,075	\$19,261
	Grade 2 Laminate	\$19,408	\$19,594
	Grade 1 Veneer	\$ 22,281	\$22,467
	Grade 2 Veneer	\$24,036	\$24,222

6 TAPS

HS1860B36	Grade 1 Laminate	\$22,250	\$22,436
	Grade 2 Laminate	\$22,583	\$22,769
	Grade 1 Veneer	\$25,456	\$25,642
	Grade 2 Veneer	\$ 27,211	\$27,397

▶ Specification Information, continued on next page

Host Collection

Boat Shaped Tables with Three Bases
DESIGN F/P DESIGN AND VECTA DESIGN TEAM

SIN 711.11

Tip: Prices shown include top, TAP(s), and slim bases.
▶ See base options for flared bases, page 264

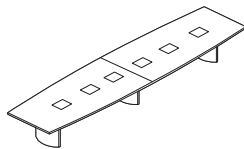
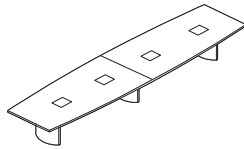
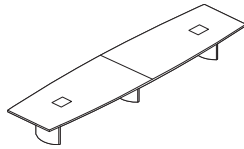
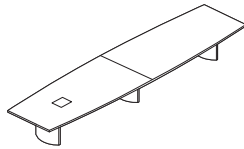
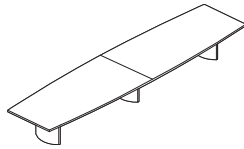

Tip: Last digit of style number indicates number of TAP(s).

Tip: For tech corridor, 20'L tables have eight long doors and four short doors.



▶ Specification Information, continued from previous page

Specification Information

Style Number	Finish	Base Prices	
			
		Flat Wood Edge:	Bullnose Wood Edge:

20'L, 60"W Center, 48"W End Two Piece Top

0 TAP			
HS2060B20	Grade 1 Laminate	\$12,848	\$13,052
	Grade 2 Laminate	\$13,218	\$13,422
	Grade 1 Veneer	\$16,089	\$16,293
	Grade 2 Veneer	\$18,028	\$18,232
1 TAP			
HS2060B21	Grade 1 Laminate	\$14,435	\$14,639
	Grade 2 Laminate	\$14,805	\$15,009
	Grade 1 Veneer	\$17,676	\$17,880
	Grade 2 Veneer	\$19,615	\$19,819
2 TAPS			
HS2060B22	Grade 1 Laminate	\$16,023	\$16,227
	Grade 2 Laminate	\$16,393	\$16,597
	Grade 1 Veneer	\$19,264	\$19,468
	Grade 2 Veneer	\$21,203	\$21,407
4 TAPS			
HS2060B24	Grade 1 Laminate	\$19,198	\$19,402
	Grade 2 Laminate	\$19,568	\$19,772
	Grade 1 Veneer	\$22,439	\$22,643
	Grade 2 Veneer	\$24,378	\$24,582
6 TAPS			
HS2060B26	Grade 1 Laminate	\$22,372	\$22,576
	Grade 2 Laminate	\$22,742	\$22,946
	Grade 1 Veneer	\$25,613	\$25,817
	Grade 2 Veneer	\$27,552	\$27,756

▶ Specification Information, continued on next page

Host Collection Boat Shaped Tables with Three Bases *continued*

DESIGN F/P DESIGN AND VECTA DESIGN TEAM

SIN 711.11

► Specification Information, continued from previous page



Tip: Prices shown include top, TAP(s), and slim bases.
 ► See base options for flared bases, page 264

Tip: Last digit of style number indicates number of TAP(s).

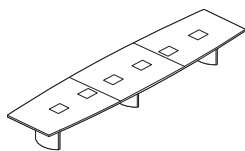
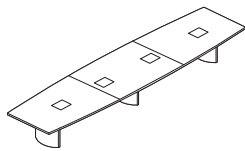
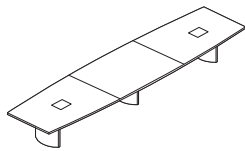
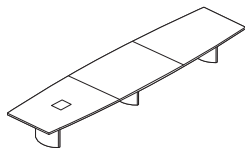
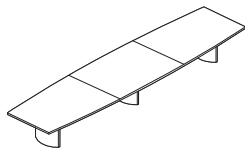
Tip: For tech corridor, 20'L tables have eight long doors and four short doors.



Specification Information

Style Number	Finish	Base Prices	
			
		Flat Wood Edge:	Bullnose Wood Edge:

20'L, 60"W Center, 48"W End Three Piece Top

0 TAP			
HS2060B30	Grade 1 Laminate	\$13,229	\$13,433
	Grade 2 Laminate	\$13,599	\$13,803
	Grade 1 Veneer	\$16,470	\$16,674
	Grade 2 Veneer	\$18,409	\$18,613
1 TAP			
HS2060B31	Grade 1 Laminate	\$14,815	\$15,019
	Grade 2 Laminate	\$15,185	\$15,389
	Grade 1 Veneer	\$18,056	\$18,260
	Grade 2 Veneer	\$19,995	\$20,199
2 TAPS			
HS2060B32	Grade 1 Laminate	\$16,403	\$16,607
	Grade 2 Laminate	\$16,773	\$16,977
	Grade 1 Veneer	\$19,644	\$19,848
	Grade 2 Veneer	\$21,583	\$21,787
4 TAPS			
HS2060B34	Grade 1 Laminate	\$19,577	\$19,781
	Grade 2 Laminate	\$19,947	\$20,151
	Grade 1 Veneer	\$22,818	\$23,022
	Grade 2 Veneer	\$24,757	\$24,961
6 TAPS			
HS2060B36	Grade 1 Laminate	\$22,751	\$22,955
	Grade 2 Laminate	\$23,121	\$23,325
	Grade 1 Veneer	\$25,992	\$26,196
	Grade 2 Veneer	\$27,931	\$28,135

Coalesse

Host Collection

Boat Shaped Tables with Three Bases
DESIGN F/P DESIGN AND VECTA DESIGN TEAM

SIN 711.11

Host Collection Trapezoid Tables with Two Bases

DESIGN F/P DESIGN AND VECTA DESIGN TEAM

SIN 711.11

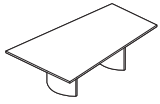

Tip: Shipped knocked down.

Tip: Grain direction for wood-grain laminate runs the length of the table.

Tip: See TAP options for electrical systems and faceplate list.

Tip: Clips are provided with table. One clip per foot of table length.

Tip: The wood edge on a table top with woodgrain laminate may not match the top.

Tip: You must send a sample of reasonable size for Stain-to-Match.

Standard Includes		Required to Specify
<ul style="list-style-type: none"> ▶ Need help? Product details, see <i>Coalesse Tables, Storage, and Accessories Specification Guide</i> 	<ul style="list-style-type: none"> • Top: 1¼" particle board core with laminate • Flat wood edge • TAP(s), if selected: 10"W x 12"L opening(s) trimmed with a flat solid wood profile and with brushed anodized aluminum TAP doors • Tech corridor: two aluminum beams for top support provide tracks for hinged aluminum doors that clip shut: satin anodized finish • Universal clip: black plastic • Two 27"W bases: wood veneer on MDF with aluminum universal bracket • Concealed leveling glides: non-marring, black plastic 	<ol style="list-style-type: none"> 1 Style number 2 Base selection (see below) and wood color number for base 3 Laminate color number for table top, if selected 4 Wood color number for wood edge <ul style="list-style-type: none"> ▶ See <i>Veneer Matrix</i>, page 365 5 Door color number for storage tray or TAP door, if selected: <ul style="list-style-type: none"> - 8044 Black - 8047 Silver 6 Options, if selected (see below) <ul style="list-style-type: none"> ▶ See <i>Surface Materials</i>, page 350.

Options	Price	Required to Specify
Surface Materials <ul style="list-style-type: none"> • Top • Grade 2 laminate • Grade 1 Wood veneer • Grade 2 wood veneer • Stain-to-Match 	<ul style="list-style-type: none"> Prices at right Prices at right Prices at right No cost 	<ul style="list-style-type: none"> Specify with <i>Grade 2 laminate</i> and select color number. Specify with <i>Grade 1 wood veneer</i> and select color number. Specify with <i>Grade 2 wood veneer</i> and select color number. Specify with <i>Stain-to-Match</i>. ▶ Page 385

Edges <ul style="list-style-type: none"> • Bullnose wood edge • Horizon wood edge 	<ul style="list-style-type: none"> Prices at right Prices at right 	<ul style="list-style-type: none"> Specify with <i>bullnose wood edge</i>. Specify with <i>horizon wood edge</i>.
--	--	---

Bases <p>Slim Flared</p>	<ul style="list-style-type: none"> • Two slim bases • One slim and one flared base • Two flared bases 	<ul style="list-style-type: none"> No cost +\$ 827 +\$1656 	<ul style="list-style-type: none"> Specify with <i>two slim bases</i>. Specify with <i>one slim base</i> and one flared base. Specify with <i>two flared bases</i>.
---------------------------------	--	---	--

Tip: 96"L tables available with zero, one, or two TAP(s). 10'L and 12'L tables available with zero, one, two, or three TAP(s).

Tip: In addition to the data and audio/video AAPs available from Coalesse, other styles of AAPs are available through Extron Electronics. For an Extron dealer, call 1-800-633-9876.

Tip: See TAP options for electrical systems and faceplate list.

TAP Electrical System with Faceplate Options <p>Field Wired</p> <p>Cord and Plug</p> <p>Hardwired</p>	<ul style="list-style-type: none"> • Field-wired tray (no electrical) <ul style="list-style-type: none"> - PAFW field-wired tray (no electrical) with blank AAPs - PDFW field-wired tray (no electrical) with two data AAPs - PVFW field-wired tray (no electrical) with two of each video/audio and data AAPs • Cord and plug tray (10' cord) <ul style="list-style-type: none"> - PACP cord and plug tray with outlets and blank AAPs - PDCP cord and plug tray with outlets and two data AAPs - PAVC cord and plug tray with outlets and two of each video/audio and data AAPs • Hard-wired tray (6' conduit) <ul style="list-style-type: none"> - PAHW hard-wired tray with outlets and blank AAPs - PDHW hard-wired tray with outlets and two data AAPs - PAVH hard-wired tray with outlets and two of each video/audio and data AAPs 	<ul style="list-style-type: none"> No cost No cost No cost 	<ul style="list-style-type: none"> Specify with <i>power data</i>, and select TAP type and TAP door color number. Specify with <i>power data</i>, and select TAP type and TAP door color number. Specify with <i>power data</i>, and select TAP type and TAP door color number.
--	---	---	--

▶ Options, continued on next page

Host Collection

Trapezoid Tables with Two Bases
DESIGN F/P DESIGN AND VECTA DESIGN TEAM

SIN 711.11

► Options, continued from previous page

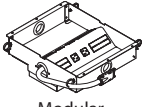
Options	Price	Required to Specify
TAP Electrical System with Faceplate Options  Modular	<ul style="list-style-type: none"> Modular system tray (hardwire base power infeed) <ul style="list-style-type: none"> - PAMH modular system tray with outlets and blank AAPs - PDMH modular system tray with outlets and two data AAPs - PVMH modular system tray with outlets and two of each video/audio and data AAPs +\$141 each tray	Specify with <i>modular power data</i> , and select TAP type and TAP door color number.
Storage Tray	<ul style="list-style-type: none"> Storage tray -\$593	Specify with <i>storage tray</i> and select door color number.
Doors	<ul style="list-style-type: none"> Storage tray wood veneer doors TAP wood veneer doors +\$298 per door +\$298 per door	Specify with <i>wood doors</i> . Specify with <i>wood doors</i> .
Related Products	<ul style="list-style-type: none"> Floor kit: Connectrac Corridor shelf 	► Page 283 ► Page 283

Tip: If the specified table has multiple TAP(s), any one TAP can be replaced with a storage tray.

Tip: Wood veneer doors for storage tray or TAP will always be cross grain.

Tip: Connectrac must be the same wiring schematic as the table.

TAP Locations

96"L x 42"W x 60"W TAP Locations—One piece top

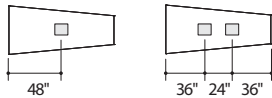

10'L x 42"W x 60"W TAP Locations—One piece top

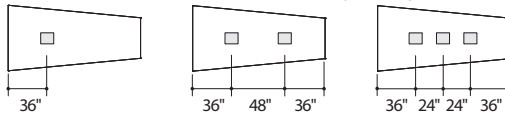

10'L x 42"W x 60"W TAP Locations—Two piece top

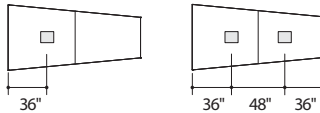

12'L x 42"W x 60"W TAP Locations—One piece top

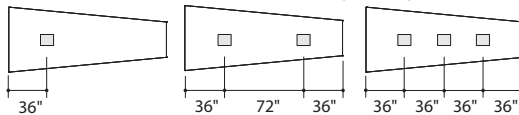

12'L x 42"W x 60"W TAP Locations—Two piece top

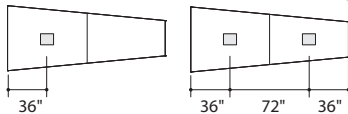

► Specification Information, on next page

Host Collection Trapezoid Tables with Two Bases *continued*

DESIGN F/P DESIGN AND VECTA DESIGN TEAM

SIN 711.11

Tip: Prices shown include top, TAP(s), and slim bases.
 ▶ See base options for flared bases, page 276

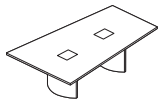
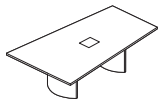
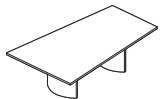

Tip: Last digit of style number indicates number of TAP(s).

Tip: For tech corridor, 96"L tables have two long doors and four short doors.



▶ Options, on previous page

Specification Information

Style Number	Finish	Base Prices		
				
		Flat Wood Edge:	Bullnose Wood Edge:	Horizon Wood Edge:

96"L x 42"W x 60"W One Piece Top

0 TAP

Style Number	Finish	Flat Wood Edge	Bullnose Wood Edge	Horizon Wood Edge
HS9660T10	Grade 1 Laminate	\$ 6911	\$ 7011	\$ 8308
	Grade 2 Laminate	\$ 7061	\$ 7161	\$ 8458
	Grade 1 Veneer	\$ 7611	\$ 7711	\$ 9008
	Grade 2 Veneer	\$ 8370	\$ 8470	\$ 9767

1 TAP

Style Number	Finish	Flat Wood Edge	Bullnose Wood Edge	Horizon Wood Edge
HS9660T11	Grade 1 Laminate	\$ 8498	\$ 8598	\$ 9895
	Grade 2 Laminate	\$ 8648	\$ 8748	\$10,045
	Grade 1 Veneer	\$ 9198	\$ 9298	\$10,595
	Grade 2 Veneer	\$ 9957	\$10,057	\$11,354

2 TAPS

Style Number	Finish	Flat Wood Edge	Bullnose Wood Edge	Horizon Wood Edge
HS9660T12	Grade 1 Laminate	\$10,086	\$10,186	\$11,483
	Grade 2 Laminate	\$10,236	\$10,336	\$11,633
	Grade 1 Veneer	\$10,786	\$10,886	\$12,183
	Grade 2 Veneer	\$11,545	\$11,645	\$12,942

▶ Specification Information, continued on next page

Host Collection Trapezoid Tables with Two Bases

DESIGN F/P DESIGN AND VECTA DESIGN TEAM

SIN 711.11

Tip: Prices shown include top, TAP(s), and slim bases.
 ▶ See base options for flared bases, page 276

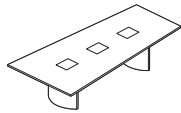
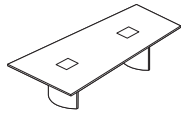
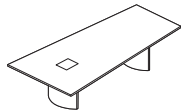
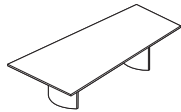

Tip: Last digit of style number indicates number of TAP(s).

Tip: For tech corridor, 10'L tables have four long doors and four short doors.



▶ Specification Information, continued from previous page

Specification Information

Style Number	Finish	Base Prices		
				
		Flat Wood Edge:	Bullnose Wood Edge:	Horizon Wood Edge:

10'L x 42"W x 60"W One Piece Top

0 TAP				
HS1060T10	Grade 1 Laminate	\$ 7377	\$ 7501	\$ 8814
	Grade 2 Laminate	\$ 7560	\$ 7684	\$ 8997
	Grade 1 Veneer	\$ 8223	\$ 8347	\$ 9660
	Grade 2 Veneer	\$ 9170	\$ 9294	\$10,607
1 TAP				
HS1060T11	Grade 1 Laminate	\$ 8961	\$ 9085	\$10,398
	Grade 2 Laminate	\$ 9144	\$ 9268	\$10,581
	Grade 1 Veneer	\$ 9807	\$ 9931	\$11,244
	Grade 2 Veneer	\$10,754	\$10,878	\$12,191
2 TAPS				
HS1060T12	Grade 1 Laminate	\$10,549	\$10,673	\$11,986
	Grade 2 Laminate	\$10,732	\$10,856	\$12,169
	Grade 1 Veneer	\$11,395	\$11,519	\$12,832
	Grade 2 Veneer	\$12,342	\$12,466	\$13,779
3 TAPS				
HS1060T13	Grade 1 Laminate	\$12,137	\$12,261	\$13,574
	Grade 2 Laminate	\$12,320	\$12,444	\$13,757
	Grade 1 Veneer	\$12,983	\$13,107	\$14,420
	Grade 2 Veneer	\$13,930	\$14,054	\$15,367

▶ Specification Information, continued on next page

Host Collection Trapezoid Tables with Two Bases *continued*

DESIGN F/P DESIGN AND VECTA DESIGN TEAM

SIN 711.11

Tip: Prices shown include top, TAP(s), and slim bases.
 ▶ See base options for flared bases, page 276

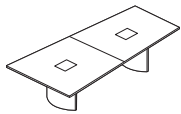
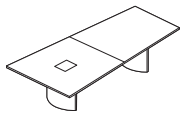
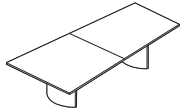

Tip: Last digit of style number indicates number of TAP(s).

Tip: For tech corridor, 10'L tables have four long doors and four short doors.



▶ Specification Information, continued from previous page

Specification Information

Style Number	Finish	Base Prices		
				
		Flat Wood Edge:	Bullnose Wood Edge:	Horizon Wood Edge:

10'L x 42"W x 60"W Two Piece Top

0 TAP

Style Number	Finish	Flat Wood Edge	Bullnose Wood Edge	Horizon Wood Edge
HS1060T20	Grade 1 Laminate	\$ 7753	\$ 7877	\$ 9190
	Grade 2 Laminate	\$ 7936	\$ 8060	\$ 9373
	Grade 1 Veneer	\$ 8599	\$ 8723	\$10,036
	Grade 2 Veneer	\$ 9546	\$ 9670	\$10,983

1 TAP

Style Number	Finish	Flat Wood Edge	Bullnose Wood Edge	Horizon Wood Edge
HS1060T21	Grade 1 Laminate	\$ 9343	\$ 9467	\$10,780
	Grade 2 Laminate	\$ 9526	\$ 9650	\$10,963
	Grade 1 Veneer	\$10,189	\$10,313	\$11,626
	Grade 2 Veneer	\$11,136	\$11,260	\$12,573

2 TAPS

Style Number	Finish	Flat Wood Edge	Bullnose Wood Edge	Horizon Wood Edge
HS1060T22	Grade 1 Laminate	\$10,929	\$11,053	\$12,366
	Grade 2 Laminate	\$11,112	\$11,236	\$12,549
	Grade 1 Veneer	\$11,775	\$11,899	\$13,212
	Grade 2 Veneer	\$12,722	\$12,846	\$14,159

▶ Specification Information, continued on next page

Host Collection Trapezoid Tables with Two Bases

DESIGN F/P DESIGN AND VECTA DESIGN TEAM

SIN 711.11

Tip: Prices shown include top, TAP(s), and slim bases.
 ▶ See base options for flared bases, page 276

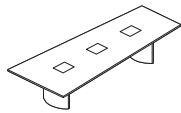
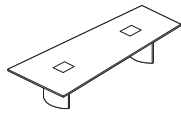
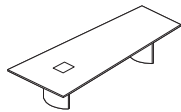
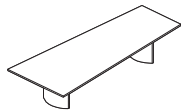

Tip: Last digit of style number indicates number of TAP(s).

Tip: For tech corridor, 12'L tables have four long doors and four short doors.



▶ Specification Information, continued from previous page

Specification Information

Style Number	Finish	Base Prices		
				
		Flat Wood Edge:	Bullnose Wood Edge:	Horizon Wood Edge:

12'L x 42"W x 60"W One Piece Top

0 TAP				
HS1260T10	Grade 1 Laminate	\$ 7857	\$ 7995	\$ 9333
	Grade 2 Laminate	\$ 8078	\$ 8216	\$ 9554
	Grade 1 Veneer	\$ 9187	\$ 9325	\$10,663
	Grade 2 Veneer	\$10,332	\$10,470	\$11,808
1 TAP				
HS1260T11	Grade 1 Laminate	\$ 9446	\$ 9584	\$10,922
	Grade 2 Laminate	\$ 9667	\$ 9805	\$11,143
	Grade 1 Veneer	\$10,776	\$10,914	\$12,252
	Grade 2 Veneer	\$11,921	\$12,059	\$13,397
2 TAPS				
HS1260T12	Grade 1 Laminate	\$11,034	\$11,172	\$12,510
	Grade 2 Laminate	\$11,255	\$11,393	\$12,731
	Grade 1 Veneer	\$12,364	\$12,502	\$13,840
	Grade 2 Veneer	\$13,509	\$13,647	\$14,985
3 TAPS				
HS1260T13	Grade 1 Laminate	\$12,620	\$12,758	\$14,096
	Grade 2 Laminate	\$12,841	\$12,979	\$14,317
	Grade 1 Veneer	\$13,950	\$14,088	\$15,426
	Grade 2 Veneer	\$15,095	\$15,233	\$16,571

▶ Specification Information, continued on next page

Host Collection Trapezoid Tables with Two Bases *continued*

DESIGN F/P DESIGN AND VECTA DESIGN TEAM

SIN 711.11

Tip: Prices shown include top, TAP(s), and slim bases.
 ▶ See base options for flared bases, page 276

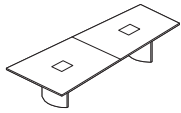
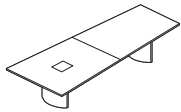
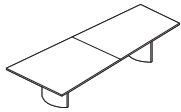

Tip: Last digit of style number indicates number of TAP(s).

Tip: For tech corridor, 12'L tables have four long doors and four short doors.



▶ Specification Information, continued from previous page

Specification Information

Style Number	Finish	Base Prices		
				
		Flat Wood Edge:	Bullnose Wood Edge:	Horizon Wood Edge:

12'L x 42"W x 60"W Two Piece Top

0 TAP

HS1260T20	Grade 1 Laminate	\$ 8239	\$ 8377	\$ 9715
	Grade 2 Laminate	\$ 8460	\$ 8598	\$ 9936
	Grade 1 Veneer	\$ 9569	\$ 9707	\$11,045
	Grade 2 Veneer	\$10,714	\$10,852	\$12,190

1 TAP

HS1260T21	Grade 1 Laminate	\$ 9824	\$ 9962	\$11,300
	Grade 2 Laminate	\$10,045	\$10,183	\$11,521
	Grade 1 Veneer	\$11,154	\$11,292	\$12,630
	Grade 2 Veneer	\$12,299	\$12,437	\$13,775

2 TAPS

HS1260T22	Grade 1 Laminate	\$11,413	\$11,551	\$12,889
	Grade 2 Laminate	\$11,634	\$11,772	\$13,110
	Grade 1 Veneer	\$12,743	\$12,881	\$14,219
	Grade 2 Veneer	\$13,888	\$14,026	\$15,364

Floor Kit: Connectrac

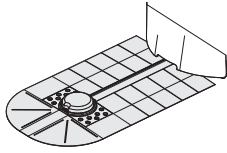

Tip: Shipped knocked down.

Standard Includes	Required to Specify
<ul style="list-style-type: none"> • Dome to cover floor monument (maximum size 5⁹/₁₆" W X 5⁹/₁₆" L X 3"H): black plastic • Low profile aluminum/PVC raceway to conceal wires from the dome to the table base <ul style="list-style-type: none"> - Aluminum bottom track and removable black powder-coated aluminum top cap for carpet strip: natural - Moisture-resistant MDF transition ramps run along both sides of raceway - Standard 4 foot length - Raceway can be field-cut to desired length • ADA compliant 	Style number

Specification Information	
Style Number	Price
HSFCONPT	\$581

Corridor Shelf

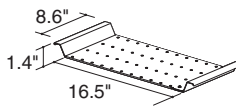

Standard Includes	Required to Specify
<ul style="list-style-type: none"> • Perforated steel shelf in silver power coat • Hangs from the lower rail on the beams to hold routers, hubs, line drivers, scalers and other technical equipment • 1/2" rack units of space, 2³/₄" H • Shipped assembled with adjustment screws 	Style number

Specification Information	
Style Number	Price
HSFSHLF	\$99

Host Collection Accessories *continued*

DESIGN F/P DESIGN AND VECTA DESIGN TEAM

SIN 711.11

Six Outlet Plug Strip

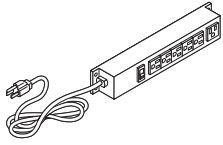

Standard Includes	Required to Specify
-------------------	---------------------

- Power strip with 15' cord and three-prong plug: black
- Six power outlets
- On-off switch
- Surge suppressor
- Dual lock adhesive strips for tech corridor installation

Style number

Specification Information	
Style Number	Price

793330	\$256
--------	-------

Corridor Power Kit, Modular

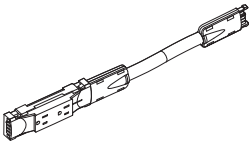

Tip: Corridor power kit can only be used when modular TAPs are specified.

Standard Includes	Required to Specify
-------------------	---------------------

- Modular duplex receptacle
- Dual lock adhesive strip

Style number

Specification Information	
Style Number	Price

HS4WXFRM	\$104
----------	-------

Reunion Collection

Rectangular Seminar Tables with Removable Snap Legs (SIN 711.11)	286
Rectangular Seminar Tables with Fixed Snap Legs (SIN 711.11)	290
Square Seminar Tables with Removable Snap Legs (SIN 711.11)	294
Square Seminar Tables with Fixed Snap Legs (SIN 711.11)	296
60° Trapezoid Seminar Tables with Removable Snap Legs (SIN 711.11)	298
60° Trapezoid Seminar Tables with Fixed Snap Legs (SIN 711.11)	299
Half Round Seminar Tables with Removable Snap Legs (SIN 711.11)	300
Half Round Seminar Tables with Fixed Snap Legs (SIN 711.11)	301
90° Connecting Tops for Seminar Tables (SIN 711.11)	302
Accessories (SIN 711.11)	303

Reunion Seminar Rectangular Seminar Tables with Removable Snap Legs

DESIGN FM DESIGN

SIN 711.11

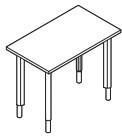

Tip: Shipped knocked down.

Standard Includes	Required to Specify
<ul style="list-style-type: none"> ▶ Need help? Product details, see <i>Coalesse Tables, Storage, and Accessories Specification Guide</i> • Top: 1¼" particle board core with laminate • Reunion vinyl edge: black • Four 2½" x 1¾" removable snap legs: extruded aluminum and die-cast aluminum head with single powder coat and black tubular steel foot • Integral wire manager in leg to accommodate up to two ¾" diameter cords • Leveling glides with adjustability range of ½"H: black plastic 	<ol style="list-style-type: none"> 1 Style number 2 Powder coat color number for legs 3 Laminate color number for top 4 Options, if selected (see below) <p>▶ See <i>Surface Materials</i>, page 350.</p>

Tip: You must send a sample of reasonable size for *Stain-to-Match*.

Tip: If you specify a wood edge on a top with woodgrain laminate, the edge and top may not match.

Tip: For grain matching always include a drawing or sketch along with your specification showing the arrangement of tables you plan so that we can ensure proper grain matching.

Tip: When the factory-installed flex ganger option is specified, the flex gangers will be installed in the end-to-end ganging configuration. If side-to-side or end-and-side ganging is required, change the position of the flex gangers at time of installation. All flex ganger locations are pre-drilled for simple re-location when desired.

Tip: When three grommets are specified, grommets will be located left, right, and center.

Tip: For sphere location availability.

Tip: If couplers are needed on PCS or CSP they must be ordered separately.

Tip: For installation of grommets, spheres, Interport, Mini-Port, Interact, Axil Z, or Ellora submit a drawing indicating the desired location for a factory installed cutout(s). Field installation is also available. All require the grommet(s), sphere(s), Interport, Mini-Port, Interact, Axil Z, or Ellora to be ordered as a separate item.

Tip: Table height adjustment range changes to 28½"H to 34½"H when casters are specified.

Options	Price	Required to Specify
Surface Materials <ul style="list-style-type: none"> • Top • Grade 2 laminate • Grade 1 wood veneer • Grade 2 wood veneer • Stain-to-Match 	<ul style="list-style-type: none"> Prices at right Prices at right Prices at right No cost 	<ul style="list-style-type: none"> Specify with <i>Grade 2 laminate</i> and select color number. Specify with <i>Grade 1 wood veneer</i> and select color number. Specify with <i>Grade 2 wood veneer</i> and select color number. Specify with <i>Stain-to-Match</i>. <p>▶ Page 385</p>
Edge <ul style="list-style-type: none"> • Wood • Flat wood edge 	<ul style="list-style-type: none"> Prices at right 	<ul style="list-style-type: none"> Specify with <i>flat wood edge</i>.
Flex ganger package (Not to be used with wood edge) <ul style="list-style-type: none"> • End-to-end 	<ul style="list-style-type: none"> +\$ 80 	<ul style="list-style-type: none"> Specify with <i>end-to-end flex gangers</i>.
Modesty Panel <ul style="list-style-type: none"> ▶ Page 304 • 42"L • 48"L • 60"L • 72"L 	<ul style="list-style-type: none"> +\$227 +\$242 +\$257 +\$275 	<ul style="list-style-type: none"> Specify with <i>modesty panel</i> and select powder coat color number. Specify with <i>modesty panel</i> and select powder coat color number. Specify with <i>modesty panel</i> and select powder coat color number. Specify with <i>modesty panel</i> and select powder coat color number.
Grommets <ul style="list-style-type: none"> • One grommet: black plastic • Two grommets: black plastic • Three grommets: black plastic 	<ul style="list-style-type: none"> +\$ 70 +\$140 +\$210 	<ul style="list-style-type: none"> Specify with <i>grommet</i> and select location of left, right, or center. Specify with <i>two grommets</i> and select location of left/center, right/center, or right/left. Specify with <i>three grommets</i>.
Spheres <ul style="list-style-type: none"> • Factory-installed opening and sphere to be installed on site: black plastic only • CSP = Four data jack locations • PCS = Two simplex power outlets and two data jack locations • PSP = Four simplex power 	<ul style="list-style-type: none"> +\$176 each +\$269 each +\$390 each 	<ul style="list-style-type: none"> Specify with <i>CSP sphere</i> and select location of left, right, or center. Specify with <i>PCS sphere</i> and select location of left, right, or center. Specify with <i>PSP sphere</i> and select location of left, right, or center.
Casters <ul style="list-style-type: none"> • 3" diameter, locking, single-wheel casters: black plastic 	<ul style="list-style-type: none"> +\$161 	<ul style="list-style-type: none"> Add suffix C to the style number.

Veneer direction



Reunion Seminar

Rectangular Seminar Tables with Removable Snap Legs

DESIGN FM DESIGN

SIN 711.11

Specification Information

Dimensions			Style Number	Finish	Base Prices	
L	W	H			Flat Vinyl Edge:	Flat Wood Edge:



Flat Vinyl Edge:



Flat Wood Edge:

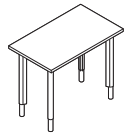

24"W Rectangular Seminar Tables with Removable Snap Legs

Dimensions	Style Number	Grade 1	Grade 2
42" 24" 26½"-32½"	50611625	Grade 1 Laminate	\$1703 \$2347
		Grade 2 Laminate	\$1737 \$2381
		Grade 1 Wood Veneer	\$2247 \$2891
		Grade 2 Wood Veneer	\$2390 \$3034
48" 24" 26½"-32½"	50621625	Grade 1 Laminate	\$1710 \$2353
		Grade 2 Laminate	\$1748 \$2391
		Grade 1 Wood Veneer	\$2254 \$2897
		Grade 2 Wood Veneer	\$2402 \$3045
60" 24" 26½"-32½"	50631625	Grade 1 Laminate	\$1754 \$2398
		Grade 2 Laminate	\$1800 \$2444
		Grade 1 Wood Veneer	\$2300 \$2944
		Grade 2 Wood Veneer	\$2486 \$3130
72" 24" 26½"-32½"	50641625	Grade 1 Laminate	\$1778 \$2422
		Grade 2 Laminate	\$1833 \$2477
		Grade 1 Wood Veneer	\$2324 \$2968
		Grade 2 Wood Veneer	\$2547 \$3191

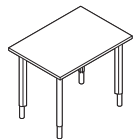

30"W Rectangular Seminar Tables with Removable Snap Legs

Dimensions	Style Number	Grade 1	Grade 2
42" 30" 26½"-32½"	50612625	Grade 1 Laminate	\$1908 \$2632
		Grade 2 Laminate	\$1949 \$2673
		Grade 1 Wood Veneer	\$2662 \$3386
		Grade 2 Wood Veneer	\$2819 \$3543
48" 30" 26½"-32½"	50622625	Grade 1 Laminate	\$1940 \$2664
		Grade 2 Laminate	\$1986 \$2710
		Grade 1 Wood Veneer	\$2694 \$3418
		Grade 2 Wood Veneer	\$2882 \$3606
60" 30" 26½"-32½"	50632625	Grade 1 Laminate	\$1991 \$2715
		Grade 2 Laminate	\$2048 \$2772
		Grade 1 Wood Veneer	\$2745 \$3469
		Grade 2 Wood Veneer	\$2980 \$3704
72" 30" 26½"-32½"	50642625	Grade 1 Laminate	\$2026 \$2750
		Grade 2 Laminate	\$2095 \$2819
		Grade 1 Wood Veneer	\$2780 \$3504
		Grade 2 Wood Veneer	\$3061 \$3785

► Specification Information, continued on next page

► Specification Information, continued from previous page

Specification Information						
Dimensions			Style Number	Finish	Base Prices	
L	W	H			Flat Vinyl Edge:	Flat Wood Edge:

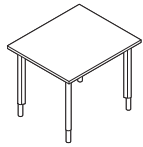

36"W Rectangular Seminar Tables with Removable Snap Legs

42"	36"	26½"-32½"	50613625	Grade 1 Laminate	\$2090	\$2814
				Grade 2 Laminate	\$2139	\$2863
				Grade 1 Wood Veneer	\$2919	\$3643
				Grade 2 Wood Veneer	\$3085	\$3809
48"	36"	26½"-32½"	50623625	Grade 1 Laminate	\$2140	\$2864
				Grade 2 Laminate	\$2195	\$2919
				Grade 1 Wood Veneer	\$2969	\$3693
				Grade 2 Wood Veneer	\$3192	\$3916
60"	36"	26½"-32½"	50633625	Grade 1 Laminate	\$2223	\$2947
				Grade 2 Laminate	\$2292	\$3016
				Grade 1 Wood Veneer	\$3052	\$3776
				Grade 2 Wood Veneer	\$3330	\$4054
72"	36"	26½"-32½"	50643625	Grade 1 Laminate	\$2310	\$3034
				Grade 2 Laminate	\$2393	\$3117
				Grade 1 Wood Veneer	\$3139	\$3863
				Grade 2 Wood Veneer	\$3474	\$4198

Coalesse

Reunion Seminar

DESIGN FM DESIGN

Rectangular Seminar Tables with Removable Snap Legs

SIN 711.11

Reunion Seminar Rectangular Seminar Tables with Fixed Snap Legs

DESIGN FM DESIGN

SIN 711.11

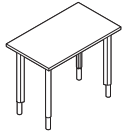

Tip: Shipped knocked down.

Tip: Reunion Seminar tables 24"W with fixed snap legs cannot be used with corner connecting tops.

Tip: You must send a sample of reasonable size for Stain-to-Match.

Tip: If you specify a wood edge on a top with woodgrain laminate, the edge and top may not match.

Tip: For grain matching always include a drawing or sketch along with your specification showing the arrangement of tables you plan so that we can ensure proper grain matching.

Tip: When the factory-installed flex ganger option is specified, the flex gangers will be installed in the end-to-end ganging configuration. If side-to-side or end-and-side ganging is required, change the position of the flex gangers at time of installation. All flex ganger locations are pre-drilled for simple re-location when desired.

Tip: When three grommets are specified, grommets will be located left, right, and center.

Tip: For sphere location availability.

Tip: If couplers are needed on PCS or CSP they must be ordered separately.

Tip: For installation of grommets, spheres, Interport, Mini-Port, Interact, Axil Z, or Ellora submit a drawing indicating the desired location for a factory installed cutout(s). Field installation is also available. All require the grommet(s), sphere(s), Interport, Mini-Port, Interact, Axil Z, or Ellora to be ordered as a separate item.

Tip: Table height adjustment range changes to 28½"H to 34½"H when casters are specified.

Standard Includes	Required to Specify
-------------------	---------------------

- | | | |
|---|---|---|
| <ul style="list-style-type: none"> ▶ Need help? Product details, see <i>Coalesse Tables, Storage, and Accessories Specification Guide</i> | <ul style="list-style-type: none"> • Top: 1¼" particle board core with laminate • Reunion vinyl edge: black • Four 2½" x 1¾" fixed snap legs: extruded aluminum and die-cast aluminum head with single powder coat and black tubular steel foot • Integral wire manager in leg to accommodate up to two ¾" diameter cords • Leveling glides with adjustability range of ½"H: black plastic | <ol style="list-style-type: none"> 1 Style number 2 Powder coat color number for legs 3 Laminate color number for top 4 Options, if selected (see below) <p>▶ See <i>Surface Materials</i>, page 350.</p> |
|---|---|---|

Options	Price	Required to Specify
---------	-------	---------------------

Surface Materials	Top		
	• Grade 2 laminate	Prices at right	Specify with <i>Grade 2 laminate</i> and select color number.
	• Grade 1 wood veneer	Prices at right	Specify with <i>Grade 1 wood veneer</i> and select color number.
	• Grade 2 wood veneer	Prices at right	Specify with <i>Grade 2 wood veneer</i> and select color number.
	• Stain-to-Match	No cost	Specify with <i>Stain-to-Match</i> . ▶ Page 385
Edge	Wood		
	• Flat wood edge	Prices at right	Specify with <i>flat wood edge</i> .
Flex ganger package (Not to be used with wood edge)	• End-to-end	+\$ 80	Specify with <i>end-to-end flex gangers</i> .
Modesty Panel ▶ Page 304	• 42"L	+\$227	Specify with <i>modesty panel</i> and select powder coat color number.
	• 48"L	+\$242	Specify with <i>modesty panel</i> and select powder coat color number.
	• 60"L	+\$257	Specify with <i>modesty panel</i> and select powder coat color number.
	• 72"L	+\$275	Specify with <i>modesty panel</i> and select powder coat color number.
Grommets	• One grommet: black plastic	+\$ 70	Specify with <i>grommet</i> and select location of left, right, or center.
	• Two grommets: black plastic	+\$140	Specify with <i>two grommets</i> and select location of left/center, right/center, or right/left.
	• Three grommets: black plastic	+\$210	Specify with <i>three grommets</i> .
Spheres	Factory-installed opening and sphere to be installed on site: black plastic only		
	• CSP = Four data jack locations	+\$176 each	Specify with <i>CSP sphere</i> and select location of left, right, or center.
	• PCS = Two simplex power outlets and two data jack locations	+\$269 each	Specify with <i>PCS sphere</i> and select location of left, right, or center.
	• PSP = Four simplex power	+\$390 each	Specify with <i>PSP sphere</i> and select location of left, right, or center.
Casters	• 3" diameter, locking, single-wheel casters: black plastic	+\$161	Add suffix C to the style number.

Veneer direction



Reunion Seminar

Rectangular Seminar Tables with Fixed Snap Legs

DESIGN FM DESIGN

SIN 711.11

Specification Information

Dimensions			Style Number	Finish	Base Prices	
L	W	H			Flat Vinyl Edge:	Flat Wood Edge:



Flat Vinyl Edge:



Flat Wood Edge:

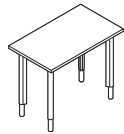

24"W Rectangular Seminar Tables with Fixed Snap Legs

Length	Width	Height	Style Number	Grade 1	Grade 2
42"	24"	26½"-32½"	50611655	Grade 1 Laminate	\$1567 \$2211
				Grade 2 Laminate	\$1601 \$2245
				Grade 1 Wood Veneer	\$2111 \$2755
				Grade 2 Wood Veneer	\$2254 \$2898
48"	24"	26½"-32½"	50621655	Grade 1 Laminate	\$1577 \$2221
				Grade 2 Laminate	\$1615 \$2259
				Grade 1 Wood Veneer	\$2121 \$2765
				Grade 2 Wood Veneer	\$2269 \$2913
60"	24"	26½"-32½"	50631655	Grade 1 Laminate	\$1618 \$2262
				Grade 2 Laminate	\$1664 \$2308
				Grade 1 Wood Veneer	\$2164 \$2808
				Grade 2 Wood Veneer	\$2350 \$2994
72"	24"	26½"-32½"	50641655	Grade 1 Laminate	\$1643 \$2287
				Grade 2 Laminate	\$1698 \$2342
				Grade 1 Wood Veneer	\$2189 \$2833
				Grade 2 Wood Veneer	\$2412 \$3056

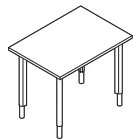

30"W Rectangular Seminar Tables with Fixed Snap Legs

Length	Width	Height	Style Number	Grade 1	Grade 2
42"	30"	26½"-32½"	50612655	Grade 1 Laminate	\$1770 \$2494
				Grade 2 Laminate	\$1811 \$2535
				Grade 1 Wood Veneer	\$2524 \$3248
				Grade 2 Wood Veneer	\$2681 \$3405
48"	30"	26½"-32½"	50622655	Grade 1 Laminate	\$1804 \$2528
				Grade 2 Laminate	\$1850 \$2574
				Grade 1 Wood Veneer	\$2558 \$3282
				Grade 2 Wood Veneer	\$2746 \$3470
60"	30"	26½"-32½"	50632655	Grade 1 Laminate	\$1857 \$2581
				Grade 2 Laminate	\$1914 \$2638
				Grade 1 Wood Veneer	\$2611 \$3335
				Grade 2 Wood Veneer	\$2846 \$3570
72"	30"	26½"-32½"	50642655	Grade 1 Laminate	\$1890 \$2614
				Grade 2 Laminate	\$1959 \$2683
				Grade 1 Wood Veneer	\$2644 \$3368
				Grade 2 Wood Veneer	\$2925 \$3649

► Specification Information, continued on next page

Reunion Seminar Rectangular Seminar Tables with Fixed Snap Legs *continued*
 DESIGN FM DESIGN

SIN 711.11

► Specification Information, continued from previous page

Specification Information						
Dimensions			Style Number	Finish	Base Prices	
L	W	H			Flat Vinyl Edge:	Flat Wood Edge:

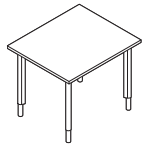

36"W Rectangular Seminar Tables with Fixed Snap Legs

Dimensions	Style Number	Grade 1	Grade 2
42" 36" 26½"-32½"	50613655	Grade 1 Laminate	\$1954 \$2678
		Grade 2 Laminate	\$2003 \$2727
		Grade 1 Wood Veneer	\$2783 \$3507
		Grade 2 Wood Veneer	\$2949 \$3673
48" 36" 26½"-32½"	50623655	Grade 1 Laminate	\$2006 \$2730
		Grade 2 Laminate	\$2061 \$2785
		Grade 1 Wood Veneer	\$2835 \$3559
		Grade 2 Wood Veneer	\$3058 \$3782
60" 36" 26½"-32½"	50633655	Grade 1 Laminate	\$2090 \$2814
		Grade 2 Laminate	\$2159 \$2883
		Grade 1 Wood Veneer	\$2919 \$3643
		Grade 2 Wood Veneer	\$3197 \$3921
72" 36" 26½"-32½"	50643655	Grade 1 Laminate	\$2174 \$2898
		Grade 2 Laminate	\$2257 \$2981
		Grade 1 Wood Veneer	\$3003 \$3727
		Grade 2 Wood Veneer	\$3338 \$4062

Coalesse

Reunion Seminar

DESIGN FM DESIGN

Rectangular Seminar Tables with Fixed Snap Legs

SIN 711.11

Reunion Seminar Square Seminar Tables with Removable Snap Legs

DESIGN FM DESIGN

SIN 711.11

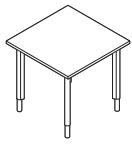

Tip: Shipped knocked down.

Tip: You must send a sample of reasonable size for Stain-to-Match.

Tip: If you specify a wood edge on a top with woodgrain laminate, the edge and top may not match.

Tip: For grain matching always include a drawing or sketch along with your specification showing the arrangement of tables you plan so that we can ensure proper grain matching.

Tip: When the factory-installed flex ganger option is specified, the flex gangers will be installed in the end-to-end ganging configuration. If side-to-side or end-and-side ganging is required, change the position of the flex gangers at time of installation. All flex ganger locations are pre-drilled for simple re-location when desired.

Tip: Table height adjustment range changes to 28½"H to 34½"H when casters are specified.

Standard Includes		Required to Specify
<ul style="list-style-type: none"> ▶ Need help? Product details, see <i>Coalesse Tables, Storage, and Accessories Specification Guide</i> 	<ul style="list-style-type: none"> • Top: 1¼" particle board core with laminate • Reunion vinyl edge: black • Four 2½" x 1¾" removable snap legs: extruded aluminum and die-cast aluminum head with single powder coat and black tubular steel foot • Integral wire manager in leg to accommodate up to two ¾" diameter cords • Leveling glides with adjustability range of ½"H: black plastic 	<ol style="list-style-type: none"> 1 Style number 2 Powder coat color number for legs 3 Laminate color number for top 4 Options, if selected (see below) <ul style="list-style-type: none"> ▶ See <i>Surface Materials</i>, page 350.

Options	Price	Required to Specify
Surface Materials <ul style="list-style-type: none"> • Top • Grade 2 laminate • Grade 1 wood veneer • Grade 2 wood veneer • Stain-to-Match 	<ul style="list-style-type: none"> Prices at right Prices at right Prices at right No cost 	<ul style="list-style-type: none"> Specify with <i>Grade 2 laminate</i> and select color number. Specify with <i>Grade 1 wood veneer</i> and select color number. Specify with <i>Grade 2 wood veneer</i> and select color number. Specify with <i>Stain-to-Match</i>. ▶ Page 385
Edge <ul style="list-style-type: none"> • Wood • Flat wood edge 	<ul style="list-style-type: none"> Prices at right 	<ul style="list-style-type: none"> Specify with <i>flat wood edge</i>.
Flex ganger package (Not to be used with wood edge) <ul style="list-style-type: none"> • End-to-end 	<ul style="list-style-type: none"> +\$ 80 	<ul style="list-style-type: none"> Specify with <i>end-to-end flex gangers</i>.
Modesty Panel <ul style="list-style-type: none"> ▶ Page 304 • 42"L • 48"L • 60"L 	<ul style="list-style-type: none"> +\$250 +\$268 +\$289 	<ul style="list-style-type: none"> Specify with <i>modesty panel</i> and select powder coat color number. Specify with <i>modesty panel</i> and select powder coat color number. Specify with <i>modesty panel</i> and select powder coat color number.
Casters <ul style="list-style-type: none"> • 3" diameter, locking, single-wheel casters: black plastic 	<ul style="list-style-type: none"> +\$161 	<ul style="list-style-type: none"> Add suffix C to the style number.

Veneer direction



Reunion Seminar

DESIGN FM DESIGN

SIN 711.11

Square Seminar Tables with Removable Snap Legs

Specification Information

Dimensions			Style Number	Finish	Base Prices	
L	W	H			Flat Vinyl Edge:	Flat Wood Edge:
36"	36"	26½"-32½"	50436625	Grade 1 Laminate	\$1833	\$2517
				Grade 2 Laminate	\$1875	\$2559
				Grade 1 Wood Veneer	\$2662	\$3346
				Grade 2 Wood Veneer	\$2828	\$3512
42"	42"	26½"-32½"	50442625	Grade 1 Laminate	\$1868	\$2552
				Grade 2 Laminate	\$1924	\$2608
				Grade 1 Wood Veneer	\$2697	\$3381
				Grade 2 Wood Veneer	\$2930	\$3614
48"	48"	26½"-32½"	50448625	Grade 1 Laminate	\$1952	\$2636
				Grade 2 Laminate	\$2024	\$2708
				Grade 1 Wood Veneer	\$2781	\$3465
				Grade 2 Wood Veneer	\$3032	\$3716
60"	60"	26½"-32½"	50460625	Grade 1 Laminate	\$2106	\$2790
				Grade 2 Laminate	\$2221	\$2905
				Grade 1 Wood Veneer	\$2935	\$3619
				Grade 2 Wood Veneer	\$3326	\$4010

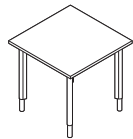

Reunion Seminar Square Seminar Tables with Fixed Snap Legs

DESIGN FM DESIGN

SIN 711.11

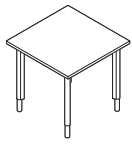

Tip: Shipped knocked down.

Standard Includes		Required to Specify
<ul style="list-style-type: none"> ▶ Need help? Product details, see <i>Coalesse Tables, Storage, and Accessories Specification Guide</i> 	<ul style="list-style-type: none"> • Top: 1/4" particle board core with laminate • Reunion vinyl edge: black • Four 2 1/2" x 1 3/4" fixed snap legs: extruded aluminum and die-cast aluminum head with single powder coat and black tubular steel foot • Integral wire manager in leg to accommodate up to two 3/8" diameter cords • Leveling glides with adjustability range of 1/2"H: black plastic 	<ol style="list-style-type: none"> 1 Style number 2 Powder coat color number for legs 3 Laminate color number for top 4 Options, if selected (see below) <p>▶ See <i>Surface Materials</i>, page 350.</p>

Options	Price	Required to Specify
Surface Materials <ul style="list-style-type: none"> • Grade 2 laminate • Grade 1 wood veneer • Grade 2 wood veneer • Stain-to-Match 	<p>Prices at right</p> <p>Prices at right</p> <p>Prices at right</p> <p>No cost</p>	<p>Specify with <i>Grade 2 laminate</i> and select color number.</p> <p>Specify with <i>Grade 1 wood veneer</i> and select color number.</p> <p>Specify with <i>Grade 2 wood veneer</i> and select color number.</p> <p>Specify with <i>Stain-to-Match</i>.</p> <p>▶ Page 385</p>
Edge <ul style="list-style-type: none"> • Flat wood edge 	<p>Prices at right</p>	<p>Specify with <i>flat wood edge</i>.</p>
Flex ganger package (Not to be used with wood edge) <ul style="list-style-type: none"> • End-to-end 	<p>+\$ 80</p>	<p>Specify with <i>end-to-end flex gangers</i>.</p>
Modesty Panel <ul style="list-style-type: none"> • 42"L • 48"L • 60"L <p>▶ Page 304</p>	<p>+\$250</p> <p>+\$268</p> <p>+\$289</p>	<p>Specify with <i>modesty panel</i> and select powder coat color number.</p> <p>Specify with <i>modesty panel</i> and select powder coat color number.</p> <p>Specify with <i>modesty panel</i> and select powder coat color number.</p>
Casters <ul style="list-style-type: none"> • 3" diameter, locking, single-wheel casters: black plastic 	<p>+\$161</p>	<p>Add suffix C to the style number.</p>

Tip: You must send a sample of reasonable size for *Stain-to-Match*.

Tip: If you specify a wood edge on a top with woodgrain laminate, the edge and top may not match.

Tip: For grain matching always include a drawing or sketch along with your specification showing the arrangement of tables you plan so that we can ensure proper grain matching.

Tip: When the factory-installed flex ganger option is specified, the flex gangers will be installed in the end-to-end ganging configuration. If side-to-side or end-and-side ganging is required, change the position of the flex gangers at time of installation. All flex ganger locations are pre-drilled for simple re-location when desired.

Tip: Table height adjustment range changes to 28 1/2"H to 34 1/2"H when casters are specified.

Veneer direction



Reunion Seminar

DESIGN FM DESIGN

Square Seminar Tables with Fixed Snap Legs

SIN 711.11

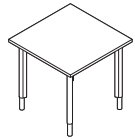

Specification Information							
Dimensions			Style Number	Finish	Base Prices		
L	W	H			Flat Vinyl Edge:	Flat Wood Edge:	
36"	36"	26½"-32½"	50436655	Grade 1 Laminate	\$1700	\$2384	
				Grade 2 Laminate	\$1742	\$2426	
				Grade 1 Wood Veneer	\$2529	\$3213	
				Grade 2 Wood Veneer	\$2695	\$3379	
42"	42"	26½"-32½"	50442655	Grade 1 Laminate	\$1733	\$2417	
				Grade 2 Laminate	\$1789	\$2473	
				Grade 1 Wood Veneer	\$2562	\$3246	
				Grade 2 Wood Veneer	\$2795	\$3479	
48"	48"	26½"-32½"	50448655	Grade 1 Laminate	\$1822	\$2506	
				Grade 2 Laminate	\$1894	\$2578	
				Grade 1 Wood Veneer	\$2651	\$3335	
				Grade 2 Wood Veneer	\$2902	\$3586	
60"	60"	26½"-32½"	50460655	Grade 1 Laminate	\$1972	\$2656	
				Grade 2 Laminate	\$2087	\$2771	
				Grade 1 Wood Veneer	\$2801	\$3485	
				Grade 2 Wood Veneer	\$3192	\$3876	

Reunion Seminar 60° Trapezoid Seminar Tables with Removable Snap Legs

DESIGN FM DESIGN

SIN 711.11



Tip: Shipped knocked down.

Tip: You must send a sample of reasonable size for Stain-to-Match.

Tip: If you specify a wood edge on a top with woodgrain laminate, the edge and top may not match.

Tip: For grain matching always include a drawing or sketch along with your specification showing the arrangement of tables you plan so that we can ensure proper grain matching.

Tip: When the factory-installed flex ganger option is specified, the flex gangers will be installed in the end-to-end ganging configuration. If side-to-side or end-and-side ganging is required, change the position of the flex gangers at time of installation. All flex ganger locations are pre-drilled for simple re-location when desired.

Tip: Table height adjustment range changes to 28½"H to 34½"H when casters are specified.

Standard Includes		Required to Specify
<ul style="list-style-type: none"> ▶ Need help? Product details, see <i>Coalesse Tables, Storage, and Accessories Specification Guide</i> 	<ul style="list-style-type: none"> • Top: 1/4" particle board core with laminate • Reunion vinyl edge: black • Four 2½" x 1¾" removable snap legs: extruded aluminum and die-cast aluminum head with single powder coat and black tubular steel foot • Integral wire manager in leg to accommodate up to two ¾" diameter cords • Leveling glides with adjustability range of ½"H: black plastic 	<ol style="list-style-type: none"> 1 Style number 2 Powder coat color number for legs 3 Laminate color number for top 4 Options, if selected (see below) <ul style="list-style-type: none"> ▶ See <i>Surface Materials</i>, page 350.

Options	Price	Required to Specify
Surface Materials Top <ul style="list-style-type: none"> • Grade 2 laminate • Grade 1 wood veneer • Grade 2 wood veneer • Stain-to-Match 	<ul style="list-style-type: none"> Prices below Prices below Prices below No cost 	<ul style="list-style-type: none"> Specify with <i>Grade 2 laminate</i> and select color number. Specify with <i>Grade 1 wood veneer</i> and select color number. Specify with <i>Grade 2 wood veneer</i> and select color number. Specify with <i>Stain-to-Match</i>. <p>▶ Page 385</p>
Edge Wood <ul style="list-style-type: none"> • Flat wood edge 	<ul style="list-style-type: none"> Prices below 	<ul style="list-style-type: none"> Specify with <i>flat wood edge</i>.
Flex ganger package (Not to be used with wood edge) <ul style="list-style-type: none"> • End-to-end 	<ul style="list-style-type: none"> +\$ 80 	<ul style="list-style-type: none"> Specify with <i>end-to-end flex gangers</i>.
Casters <ul style="list-style-type: none"> • 3" diameter, locking, single-wheel casters: black plastic 	<ul style="list-style-type: none"> +\$161 	<ul style="list-style-type: none"> Add suffix C to the style number.

Specification Information							
Dimensions			Style Number	Finish	Base Prices		
L	W	H			Flat Vinyl Edge:	Flat Wood Edge:	
48"	24"	26½"–32½"	51421625		Grade 1 Laminate	\$1817	\$2541
					Grade 2 Laminate	\$1855	\$2579
					Grade 1 Wood Veneer	\$2363	\$3087
					Grade 2 Wood Veneer	\$2511	\$3235
60"	30"	26½"–32½"	51432625		Grade 1 Laminate	\$1986	\$2710
					Grade 2 Laminate	\$2043	\$2767
					Grade 1 Wood Veneer	\$2740	\$3464
					Grade 2 Wood Veneer	\$2975	\$3699

Veneer direction



Reunion Seminar 60° Trapezoid Seminar Tables with Fixed Snap Legs

DESIGN FM DESIGN

SIN 711.11



Tip: Shipped knocked down.

Tip: You must send a sample of reasonable size for Stain-to-Match.

Tip: If you specify a wood edge on a top with woodgrain laminate, the edge and top may not match.

Tip: For grain matching always include a drawing or sketch along with your specification showing the arrangement of tables you plan so that we can ensure proper grain matching.

Tip: When the factory-installed flex ganger option is specified, the flex gangers will be installed in the end-to-end ganging configuration. If side-to-side or end-and-side ganging is required, change the position of the flex gangers at time of installation. All flex ganger locations are pre-drilled for simple re-location when desired.

Tip: Table height adjustment range changes to 28½"H to 34½"H when casters are specified.

Standard Includes	Required to Specify
<ul style="list-style-type: none"> ▶ Need help? Product details, see <i>Coalesse Tables, Storage, and Accessories Specification Guide</i> • Top: 1¼" particle board core with laminate • Reunion vinyl edge: black • Four 2½" x 1¾" fixed snap legs: extruded aluminum and die-cast aluminum head with single powder coat and black tubular steel foot • Integral wire manager in leg to accommodate up to two ¾" diameter cords • Leveling glides with adjustability range of ½"H: black plastic 	<ol style="list-style-type: none"> 1 Style number 2 Powder coat color number for legs 3 Laminate color number for top 4 Options, if selected (see below) <p>▶ See <i>Surface Materials</i>, page 350.</p>

Options	Price	Required to Specify
Surface Materials <ul style="list-style-type: none"> • Top • Grade 2 laminate • Grade 1 wood veneer • Grade 2 wood veneer • Stain-to-Match 	<ul style="list-style-type: none"> Prices below Prices below Prices below No cost 	<ul style="list-style-type: none"> Specify with <i>Grade 2 laminate</i> and select color number. Specify with <i>Grade 1 wood veneer</i> and select color number. Specify with <i>Grade 2 wood veneer</i> and select color number. Specify with <i>Stain-to-Match</i>. <p>▶ Page 385</p>
Edge <ul style="list-style-type: none"> • Wood • Flat wood edge 	<ul style="list-style-type: none"> Prices below 	<ul style="list-style-type: none"> Specify with <i>flat wood edge</i>.
Flex ganger package (Not to be used with wood edge) <ul style="list-style-type: none"> • End-to-end 	<ul style="list-style-type: none"> +\$ 80 	<ul style="list-style-type: none"> Specify with <i>end-to-end flex gangers</i>.
Casters <ul style="list-style-type: none"> • 3" diameter, locking, single-wheel casters: black plastic 	<ul style="list-style-type: none"> +\$161 	<ul style="list-style-type: none"> Add suffix C to the style number.

Specification Information							
Dimensions			Style Number	Finish	Base Prices		
L	W	H			Flat Vinyl Edge:	Flat Wood Edge:	
48"	24"	26½"-32½"	51421655	Grade 1 Laminate	\$1684	\$2408	
					Grade 2 Laminate	\$1722	\$2446
					Grade 1 Wood Veneer	\$2230	\$2954
					Grade 2 Wood Veneer	\$2378	\$3102
60"	30"	26½"-32½"	51432655	Grade 1 Laminate	\$1852	\$2576	
					Grade 2 Laminate	\$1909	\$2633
					Grade 1 Wood Veneer	\$2606	\$3330
					Grade 2 Wood Veneer	\$2841	\$3565

Veneer direction



Reunion Seminar Half Round Seminar Tables with Removable Snap Legs

DESIGN FM DESIGN

SIN 711.11

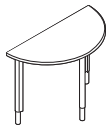

Tip: Shipped knocked down.

Standard Includes		Required to Specify
<ul style="list-style-type: none"> ▶ Need help? Product details, see <i>Coalesse Tables, Storage, and Accessories Specification Guide</i> 	<ul style="list-style-type: none"> • Top: 1/4" particle board core with laminate • Reunion vinyl edge: black • Three 2 1/2" x 1 3/4" snap legs: extruded aluminum and die-cast aluminum head with single powder coat and black tubular steel foot • Integral wire manager in leg to accommodate up to two 3/8" diameter cords • Leveling glides with adjustability range of 1/2"H: black plastic 	<ol style="list-style-type: none"> 1 Style number 2 Powder coat color number for legs 3 Laminate color number for top 4 Options, if selected (see below) <ul style="list-style-type: none"> ▶ See <i>Surface Materials</i>, page 350.

Tip: You must send a sample of reasonable size for *Stain-to-Match*.

Tip: If you specify a wood edge on a top with woodgrain laminate, the edge and top may not match.

Tip: For grain matching always include a drawing or sketch along with your specification showing the arrangement of tables you plan so that we can ensure proper grain matching.

Tip: When the factory-installed flex ganger option is specified, the flex gangers will be installed in the end-to-end ganging configuration. If side-to-side or end-and-side ganging is required, change the position of the flex gangers at time of installation. All flex ganger locations are pre-drilled for simple re-location when desired.

Tip: Table height adjustment range changes to 28 1/2"H to 34 1/2"H when casters are specified.

Options	Price	Required to Specify
Surface Materials <ul style="list-style-type: none"> • Top • Grade 2 laminate • Grade 1 wood veneer • Grade 2 wood veneer • Stain-to-Match 	<ul style="list-style-type: none"> Prices below Prices below Prices below No cost 	<ul style="list-style-type: none"> Specify with <i>Grade 2 laminate</i> and select color number. Specify with <i>Grade 1 wood veneer</i> and select color number. Specify with <i>Grade 2 wood veneer</i> and select color number. Specify with <i>Stain-to-Match</i>. ▶ Page 385
Edge <ul style="list-style-type: none"> • Wood • Flat wood edge 	<ul style="list-style-type: none"> Prices below 	<ul style="list-style-type: none"> Specify with <i>flat wood edge</i>.
Flex ganger package (Not to be used with wood edge)	<ul style="list-style-type: none"> • Factory-installed flex gangers to join adjacent tables: black plastic +\$ 80 	<ul style="list-style-type: none"> Specify with <i>flex gangers</i>.
Casters	<ul style="list-style-type: none"> • 3" diameter, locking, single-wheel casters: black plastic +\$122 	<ul style="list-style-type: none"> Add suffix C to the style number.

Specification Information						
Dimensions			Style Number	Finish	Base Prices	
L	W	H			Flat Vinyl Edge:	Flat Wood Edge:
48"	24"	26 1/2"–32 1/2"	50348625			
60"	30"	26 1/2"–32 1/2"	50360625			
72"	36"	26 1/2"–32 1/2"	50372625			

With Removable Snap Legs						
Dimensions	Style Number	Grade 1 Laminate	Grade 2 Laminate	Grade 1 Wood Veneer	Grade 2 Wood Veneer	
48" x 24" x 26 1/2"–32 1/2"	50348625	\$1602	\$1640	\$2148	\$2296	\$2201 / \$2239
60" x 30" x 26 1/2"–32 1/2"	50360625	\$1769	\$1826	\$2523	\$2758	\$2446 / \$2503
72" x 36" x 26 1/2"–32 1/2"	50372625	\$2151	\$2234	\$2980	\$3315	\$2828 / \$2911 / \$3657 / \$3992

Veneer direction



Reunion Seminar Half Round Seminar Tables with Fixed Snap Legs

DESIGN FM DESIGN

SIN 711.11

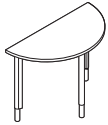

Tip: Shipped knocked down.

Tip: You must send a sample of reasonable size for Stain-to-Match.



Tip: If you specify a wood edge on a top with woodgrain laminate, the edge and top may not match.

Tip: For grain matching always include a drawing or sketch along with your specification showing the arrangement of tables you plan so that we can ensure proper grain matching.

Tip: Table height adjustment range changes to 28 1/2" H to 34 1/2" H when casters are specified.

Standard Includes	Required to Specify
<ul style="list-style-type: none"> ▶ Need help? Product details, see <i>Coalesse Tables, Storage, and Accessories Specification Guide</i> • Top: 1/4" particle board core with laminate • Reunion vinyl edge: black • Three 2 1/2" x 1 3/4" snap legs: extruded aluminum and die-cast aluminum head with single powder coat and black tubular steel foot • Integral wire manager in leg to accommodate up to two 3/8" diameter cords • Leveling glides with adjustability range of 1/2"H: black plastic 	<ol style="list-style-type: none"> 1 Style number 2 Powder coat color number for legs 3 Laminate color number for top 4 Options, if selected (see below) <p>▶ See <i>Surface Materials</i>, page 350.</p>

Options	Price	Required to Specify
Surface Materials <ul style="list-style-type: none"> • Top • Grade 2 laminate • Grade 1 wood veneer • Grade 2 wood veneer • Stain-to-Match 	<ul style="list-style-type: none"> Prices below Prices below Prices below No cost 	<ul style="list-style-type: none"> Specify with <i>Grade 2 laminate</i> and select color number. Specify with <i>Grade 1 wood veneer</i> and select color number. Specify with <i>Grade 2 wood veneer</i> and select color number. Specify with <i>Stain-to-Match</i>. <p>▶ Page 385</p>
Edge <ul style="list-style-type: none"> • Wood • Flat wood edge 	<ul style="list-style-type: none"> Prices below 	<ul style="list-style-type: none"> Specify with <i>flat wood edge</i>.
Flex ganger package (Not to be used with wood edge) <ul style="list-style-type: none"> • Factory-installed flex gangers to join adjacent tables: black plastic 	<ul style="list-style-type: none"> +\$ 80 	<ul style="list-style-type: none"> Specify with <i>flex gangers</i>.
Casters <ul style="list-style-type: none"> • 3" diameter, locking, single-wheel casters: black plastic 	<ul style="list-style-type: none"> +\$122 	<ul style="list-style-type: none"> Add suffix C to the style number.

Specification Information			
Dimensions	Style Number	Finish	Base Prices
L W H			
			 Flat Vinyl Edge:
			 Flat Wood Edge:

With Fixed Snap Legs

Dimensions	Style Number	Grade 1 Laminate	Grade 2 Laminate	Grade 1 Wood Veneer	Grade 2 Wood Veneer
48" 24" 26 1/2"-32 1/2"	50348655	\$1500	\$1538	\$2046	\$2194
		\$2099	\$2137	\$2645	\$2793
60" 30" 26 1/2"-32 1/2"	50360655	\$1668	\$1725	\$2422	\$2657
		\$2345	\$2402	\$3099	\$3334
72" 36" 26 1/2"-32 1/2"	50372655	\$2045	\$2128	\$2874	\$3209
		\$2722	\$2805	\$3551	\$3886

Reunion Seminar 90° Connecting Tops for Seminar Tables

DESIGN FM DESIGN

SIN 711.11



Tip: Shipped knocked down.

Tip: Corner connecting tops cannot be used with Reunion Seminar tables 24"W with fixed snap legs.

Tip: You must send a sample of reasonable size for Stain-to-Match.

Tip: If you specify a wood edge on a top with woodgrain laminate, the edge and top may not match.

Tip: For grain matching always include a drawing or sketch along with your specification showing the arrangement of tables you plan so that we can ensure proper grain matching.

Standard Includes

- ▶ Need help? Product details, see *Coalesse Tables, Storage, and Accessories Specification Guide*
- Top: 1/4" particle board core with laminate
- Reunion vinyl edge: black
- Connecting hardware

Required to Specify

- 1 Style number
 - 2 Laminate color number for top
 - 3 Options, if selected (see below)
- ▶ See *Surface Materials*, page 350.

Options

Surface Materials	Top	Price	Required to Specify
	• Grade 2 laminate	Prices below	Specify with <i>Grade 2 laminate</i> and select color number.
	• Grade 1 wood veneer	Prices below	Specify with <i>Grade 1 wood veneer</i> and select color number.
	• Grade 2 wood veneer	Prices below	Specify with <i>Grade 2 wood veneer</i> and select color number.
	• Stain-to-Match	No cost	Specify with <i>Stain-to-Match</i> . ▶ Page 385
Edge	Wood		
	• Flat wood edge	Prices below	Specify with <i>flat wood edge</i> .

Specification Information

Dimensions W	Style Number	Finish	Prices	
			Flat Vinyl Edge:	Flat Wood Edge:
24"	51091000	Grade 1 Laminate	\$ 392	\$1036
		Grade 2 Laminate	\$ 409	\$1053
		Grade 1 Wood Veneer	\$ 938	\$1582
		Grade 2 Wood Veneer	\$1012	\$1656
30"	51092000	Grade 1 Laminate	\$ 428	\$1152
		Grade 2 Laminate	\$ 459	\$1183
		Grade 1 Wood Veneer	\$ 974	\$1698
		Grade 2 Wood Veneer	\$1091	\$1815
36"	51093000	Grade 1 Laminate	\$ 473	\$1197
		Grade 2 Laminate	\$ 515	\$1239
		Grade 1 Wood Veneer	\$1019	\$1743
		Grade 2 Wood Veneer	\$1185	\$1909

Veneer direction



Flex Ganger Package

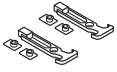

Tip: Order one ganger package for each table-to-table combination.

	Standard Includes	Required to Specify
▶ Need help? Product details, see <i>Coalesse Tables, Storage, and Accessories Specification Guide</i>	<ul style="list-style-type: none"> Two field-installed flexible ganger loops and four hooks: black plastic only Installation instructions 	Style number

Specification Information		
Style Number		Price
793365		\$80

Bar Ganger Package

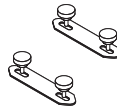

	Standard Includes	Required to Specify
▶ Need help? Product details, see <i>Coalesse Tables, Storage, and Accessories Specification Guide</i>	<ul style="list-style-type: none"> Two field-installed steel bars and four threaded hand knobs: black steel only 	Style number

Specification Information		
Style Number		Price
793335		\$56

Field-Installed Horizontal Wire Manager for Reunion Seminar



	Standard Includes	Required to Specify
▶ Need help? Product details, see <i>Coalesse Tables, Storage, and Accessories Specification Guide</i>	<ul style="list-style-type: none"> Horizontal wire manager: black plastic Attachment velcro Installation instructions 	Style number

Specification Information		
Length	Style Number	Price
42"	793442	\$ 89
48"	793448	\$103
60"	793460	\$116
72"	793472	\$132

Field-Installed Modesty Panel for Reunion Seminar

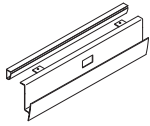

Standard Includes		Required to Specify
<ul style="list-style-type: none"> ▶ Need help? Product details, see <i>Coalesse Tables, Storage, and Accessories Specification Guide</i> 	<ul style="list-style-type: none"> • Modesty panel with integral horizontal wire manager: extruded aluminum with powder coat • Attachment hardware • Installation instructions 	<ol style="list-style-type: none"> 1 Style number 2 Powder coat color number for modesty panel

Specification Information		
Length	Style Number	Price
42"	793742	\$254
48"	793748	\$269
60"	793760	\$288
72"	793772	\$306

Mobile Storage Cart

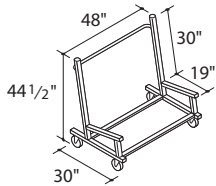

Tip: Shipped knocked down.

Tip: Mobile storage cart accommodates folding Reunion tables of lengths from 48"-72" and widths up to 42". Folded height is 35/8".

Standard Includes		Required to Specify
<ul style="list-style-type: none"> ▶ Need help? Product details, see <i>Coalesse Tables, Storage, and Accessories Specification Guide</i> 	<ul style="list-style-type: none"> • Cart to accommodate up to 12 folding Reunion table tops and up to 16 Reunion legs: black only • Bumpers: black 	Style number

Specification Information	
Style Number	Price
Accommodates 48"L, 60"L, or 72"L Tables up to 42"W	
793333	\$2197

SW_1

Specifying

Low Collaborative Conference Tables (SIN 711.11)	306
Conference Tables (SIN 711.11)	310
Round, Square, and Super-Square Tables (SIN 711.11)	314
Occasional Tables (SIN 711.11)	316
Work Tables (SIN 711.11)	318
Accessories (SIN 711.11)	319

SW_1 Low Collaborative Conference Tables

DESIGN SCOTT WILSON & MINIMAL

SIN 711.11



Tip: Your specification is not complete until you add the fifth letter to the style number to define top surface.

- L - Laminate top
- V - Wood veneer top
- C - Corian top
- G - Glass top

Tip: Glass tops are not secured to the substructure. Glass tops are placed on rubber pads that are adhered to the substructure. If the glass tables need to be moved, remove the glass top prior to moving the table.

Tip: Standard grain direction runs the width of the table (front-to-back).

Tip: If grommet with wire manager is selected, the finish is not selectable, it will be the same as the substructure finish choice.

Tip: Tablets are an optional pick for the 42" and 84" square and 84"L and 120"L rectangular tables only. Tablets are available in black or milk finish.

Veneer direction



Standard Includes	Required to Specify
-------------------	---------------------

- | | |
|---|---|
| <ul style="list-style-type: none"> ▶ Need help? Product details, see <i>Coalesse Tables, Storage, and Accessories Specification Guide</i> • 1/2" thick top surface: <ul style="list-style-type: none"> - Laminate (Grade 1) with 3 mm edge band, if selected - Wood veneer (Grade 1) with matching 3 mm edge band, if selected - Corian, if selected: white only - Glass, if selected • 1/4" thick bottom substructure: black or milk • Base, column, and cone: 8040 Polished Matte Aluminum • Glides • Ships ready-to-assemble | <ol style="list-style-type: none"> 1 Style number with appropriate top series letter indicated in the space provided. (For example: COWX_Q42 becomes COWXLQ42 for a laminate top surface): <ul style="list-style-type: none"> L - Laminate top V - Wood veneer top C - Corian top G - Glass top 2 Laminate, wood, or glass color number for top, if selected 3 Plastic color for edge band of laminate top, if selected 4 Bottom substructure: <ul style="list-style-type: none"> 6000 Black 6052 Milk 5 Options, if selected (see below) <ul style="list-style-type: none"> ▶ See <i>Surface Materials</i>, page 350. |
|---|---|

Options	Price	Required to Specify
---------	-------	---------------------

Surface Materials	Laminate <ul style="list-style-type: none"> • Grade 2 laminate Wood <ul style="list-style-type: none"> • Grade 2 wood veneer • Stain-to-Match 	Prices at right Prices at right No cost	Specify with <i>Grade 2 laminate</i> and select color number. Specify with <i>Grade 2 wood veneer</i> and select color number. Specify with <i>Stain-to-Match</i> . ▶ Page 385
Wood Veneer Grain Direction	<ul style="list-style-type: none"> • Lengthwise grain direction for tops up to 96"L 	No cost	Specify with <i>lengthwise grain direction</i> .
Grommet with Wire Management	42" square and 120"L tables (center only) <ul style="list-style-type: none"> • One grommet 60" and 72" large round and square tables <ul style="list-style-type: none"> • One grommet • Two grommets 84" and 96" large round and square tables <ul style="list-style-type: none"> • Two grommets • Four grommets 72"L, 84"L, and 96"L tables (end (V-leg) location only) <ul style="list-style-type: none"> • One grommet 72"L, 84"L, 96"L, and 120"L tables (outer ends (V-legs) location only) <ul style="list-style-type: none"> • Two grommets 	+\$ 201 +\$ 201 +\$ 402 +\$ 402 +\$ 804 +\$ 201 +\$ 402	Specify with <i>one grommet with wire manager</i> . Specify with <i>one grommet with wire manager</i> . Specify with <i>two grommets with wire manager</i> . Specify with <i>two grommets with wire manager</i> . Specify with <i>four grommets with wire manager</i> . Specify with <i>one grommet with wire manager</i> . Specify with <i>two grommets with wire manager</i> .
Tablets	42" square tables <ul style="list-style-type: none"> • Two tablets: black or milk plastic • Four tablets: black or milk plastic 84"L rectangular tables <ul style="list-style-type: none"> • Six tablets: black or milk plastic 84" square table and 120"L rectangular tables <ul style="list-style-type: none"> • Eight tablets: black or milk plastic 	+\$ 957 +\$1914 +\$2871 +\$3828	Specify with <i>two tablets</i> and select plastic color number. Specify with <i>four tablets</i> and select plastic color number. Specify with <i>six tablets</i> and select plastic color number. Specify with <i>eight tablets</i> and select plastic color number.
Related Products	<ul style="list-style-type: none"> • SW_1 seating 		▶ See <i>GSA Volume 5a Specification Guide</i> .

SW_1 Low Collaborative Conference Tables

DESIGN SCOTT WILSON & MINIMAL

SIN 711.11

Tip: Your specification is not complete until you add the fifth letter to the style number to define top surface.

- L - Laminate top
- V - Wood veneer top
- C - Corian top
- G - Glass top

Tip: Glass tops are not secured to the substructure. Glass tops are placed on rubber pads that are adhered to the substructure. If the glass tables need to be moved, remove the glass top prior to moving the table.

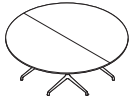
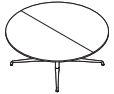

Tip: 60" and 72" round and square table base consists of four single legs. The 84" and 96" round and square table base consists of four v-legs.



Tip: Tablets are an optional pick for the 42" square tables only.

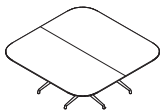

Veneer direction



Specification Information

Dimensions			Style Number	# of (optional) Tablets	Base Prices					
L	W	H			Laminate Grade 1	Laminate Grade 2	Veneer Grade 1	Veneer Grade 2	Wedge Veneer Grade 1	Wedge Veneer Layup Grade 2

Large Round Tables

One-Piece Top

60" dia	26"	COWX_RND60	N.A.	\$3149	\$3259	\$4414	\$ 4806	\$ 7458	\$ 7825	\$ 6615	\$ 7886
---------	-----	------------	------	--------	--------	--------	---------	---------	---------	---------	---------

Two-Piece Top

72" dia	26"	COWX_RND72	N.A.	\$4034	\$4172	\$5803	\$ 6317	\$ 9805	\$10,286	\$ 8474	\$10,089
---------	-----	------------	------	--------	--------	--------	---------	---------	----------	---------	----------

84" dia	26"	COWX_RND84	N.A.	\$5027	\$5200	\$7330	\$ 7982	\$12,386	\$13,012	\$12,062	\$13,824
---------	-----	------------	------	--------	--------	--------	---------	----------	----------	----------	----------

96" dia	26"	COWX_RND96	N.A.	\$6297	\$6514	\$9281	\$10,105	\$15,386	\$16,452	\$13,225	\$15,743
---------	-----	------------	------	--------	--------	--------	----------	----------	----------	----------	----------

Square Table

42"	42"	26"	COWX_Q42	2 or 4	\$2030	\$2089	\$2902	\$ 3141	N.A.	N.A.	\$ 3022	\$ 4112
-----	-----	-----	----------	--------	--------	--------	--------	---------	------	------	---------	---------

Large Square Tables

One-Piece Top

60"	60"	26"	COWX_SQ60	N.A.	\$3241	\$3353	\$4536	\$ 4939	N.A.	N.A.	\$ 6799	\$ 8254
-----	-----	-----	-----------	------	--------	--------	--------	---------	------	------	---------	---------

Two-Piece Top

72"	72"	26"	COWX_SQ72	N.A.	\$4127	\$4217	\$5925	\$ 6451	N.A.	N.A.	\$ 8658	\$10,454
-----	-----	-----	-----------	------	--------	--------	--------	---------	------	------	---------	----------

84"	84"	26"	COWX_SQ84	8	\$5118	\$5294	\$7457	\$ 8115	N.A.	N.A.	\$12,247	\$14,190
-----	-----	-----	-----------	---	--------	--------	--------	---------	------	------	----------	----------

96"	96"	26"	COWX_SQ96	N.A.	\$6389	\$6609	\$9403	\$10,237	N.A.	N.A.	\$13,408	\$16,109
-----	-----	-----	-----------	------	--------	--------	--------	----------	------	------	----------	----------

► Specification Information, continued on next page

SW_1

SW_1 Low Collaborative Conference Tables *continued*
 DESIGN SCOTT WILSON & MINIMAL

SIN 711.11

► Specification Information, continued from previous page

Tip: Your specification is not complete until you add the fifth letter to the style number to define top surface.

- L - Laminate top
- V - Wood veneer top
- C - Corian top
- G - Glass top

Tip: Glass tops are not secured to the substructure. Glass tops are placed on rubber pads that are adhered to the substructure. If the glass tables need to be moved, remove the glass top prior to moving the table.

Specification Information

Dimensions			Style Number	# of (optional) Tablets	Base Prices				Corian	Glass
L	W	H			Laminate Grade 1	Grade 2	Veneer Grade 1	Grade 2		

Rectangular Tables

84"	42"	26"	COWX_R4284	6	\$2936	\$3055	\$4052	\$4500	\$ 6849	\$ 8059
-----	-----	-----	------------	---	--------	--------	--------	--------	---------	---------

120"	42"	26"	COWX_R4120	8	\$4088	\$4256	\$6533	\$7190	\$11,501	\$14,163
------	-----	-----	------------	---	--------	--------	--------	--------	----------	----------

Super Elliptical Tables

One-Piece Top

72"	40"	26"	COWX_SE4072	N.A.	\$2311	\$2426	\$3445	\$3808	\$ 6668	\$ 7878
-----	-----	-----	-------------	------	--------	--------	--------	--------	---------	---------

84"	40"	26"	COWX_SE4084	N.A.	\$2997	\$3116	\$4112	\$4560	\$ 7030	\$ 8241
-----	-----	-----	-------------	------	--------	--------	--------	--------	---------	---------

96"	40"	26"	COWX_SE4096	N.A.	\$3421	\$3551	\$4536	\$5073	\$ 7393	\$ 8847
-----	-----	-----	-------------	------	--------	--------	--------	--------	---------	---------

120"	44"	26"	COWX_SE4120	N.A.	\$4209	\$4392	\$6655	\$7370	\$11,743	\$14,406
------	-----	-----	-------------	------	--------	--------	--------	--------	----------	----------

*Tablets are only available as an option on square tables.

Two-Piece Top

120"	44"	26"	COWX_SE4122	N.A.	\$4573	\$4756	\$7019	\$7734	\$12,105	\$14,770
------	-----	-----	-------------	------	--------	--------	--------	--------	----------	----------



Tip: 96"L corian and glass tables require a center in-line leg as standard. The 96"L laminate and veneer tables do not require a center in-line leg for support.

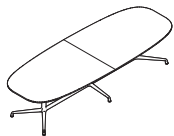

Coalesce

SW_1 Low Collaborative Conference Tables

DESIGN SCOTT WILSON & MINIMAL

SIN 711.11

SW_1

SW_1 Conference Tables

DESIGN SCOTT WILSON & MINIMAL

SIN 711.11



Tip: Your specification is not complete until you add the fifth letter to the style number to define top surface.

- L - Laminate top
- V - Wood veneer top
- C - Corian top
- G - Glass top

Tip: Glass tops are not secured to the substructure. Glass tops are placed on rubber pads that are adhered to the substructure. If the glass tables need to be moved, remove the glass top prior to moving the table.

Tip: You must send a sample of reasonable size for Stain-to-Match.

Tip: Standard grain direction runs the width of the table (front-to-back)

Tip: If grommet with wire manager is selected, the finish is not selectable, it will be the same as the substructure finish choice.

Standard Includes	Required to Specify
-------------------	---------------------

- ▶ Need help?
- Product details, see *Coalesse Tables, Storage, and Accessories Specification Guide*
- 1/2" thick top surface:
 - Laminate (Grade 1) with 3 mm edge band, if selected
 - Wood veneer (Grade 1) with matching 3 mm edge band, if selected
 - Corian, if selected: white only
 - Glass, if selected
- 1/4" thick bottom substructure: black or milk
- Base, column and cone: 8040 Polished Matte Aluminum
- Glides
- Ships ready-to-assemble

- 1 Style number with appropriate top series letter indicated in the space provided. (For example: COW_RC4284 becomes COWLRC4284 for a laminate top surface):
 - L - Laminate top
 - V - Wood veneer top
 - C - Corian top
 - G - Glass top
- 2 Laminate, wood, or glass color number for top, if selected
- 3 Plastic color for edge band of laminate top, if selected
- 4 Bottom substructure:
 - 6000 Black
 - 6052 Milk
- 5 Options, if selected (see below)
 - ▶ See *Surface Materials*, page 350.

Options	Price	Required to Specify
---------	-------	---------------------

Surface Materials	Laminate		
	• Grade 2 laminate	Prices at right	Specify with <i>Grade 2 laminate</i> and select color number.
	Wood		
	• Grade 2 wood veneer	Prices at right	Specify with <i>Grade 2 wood veneer</i> and select color number.
	• Stain-to-Match	No cost	Specify with <i>Stain-to-Match</i> . ▶ Page 385
Wood Veneer Grain Direction	• Lengthwise grain direction for tops up to 96"L	No cost	Specify with <i>lengthwise grain direction</i> .
Grommet with Wire Management	60" and 72" large round and square tables		
	• One grommet	+\$201	Specify with <i>one grommet with wire manager</i> .
	• Two grommets	+\$402	Specify with <i>two grommets with wire manager</i> .
	84" and 96" large round and square tables		
	• Two grommets	+\$402	Specify with <i>two grommets with wire manager</i> .
	• Four grommets	+\$804	Specify with <i>four grommets with wire manager</i> .
	96"L (corian and glass), 120"L, 144"L (laminate and veneer), tables (center only)		
	• One grommet	+\$201	Specify with <i>one grommet with wire manager</i> .
	84"L and 96"L (laminate and veneer) tables (end (V-leg) location only)		
	• One grommet	+\$201	Specify with <i>one grommet with wire manager</i> .
	84"L, 96"L, 120"L, 144"L, 168"L, 192"L, 216"L, and 240"L tables (outer ends V-legs) location only)		
	• Two grommets	+\$402	Specify with <i>two grommets with wire manager</i> .
144"L (corian and glass), 168"L, 192"L, 216"L, and 240"L tables (inner in-line leg locations only)			
• Two grommets	+\$402	Specify with <i>two grommets with wire manager</i> .	
216"L and 240"L tables (center and outer ends (V-legs) location only)			
• Three grommets	+\$603	Specify with <i>three grommets with wire manager</i> .	

Related Products • SW_1 seating ▶ See *GSA Volume 5a Specification Guide*.

Veneer direction



SW_1 Conference Tables

DESIGN SCOTT WILSON & MINIMAL

SIN 711.11

Tip: Your specification is not complete until you add the fifth letter to the style number to define top surface.

- L - Laminate top
- V - Wood veneer top
- C - Corian top
- G - Glass top

Tip: Glass tops are not secured to the substructure. Glass tops are placed on rubber pads that are adhered to the substructure. If the glass tables need to be moved, remove the glass top prior to moving the table.

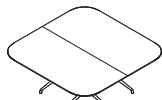
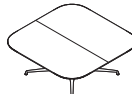
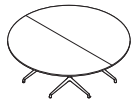
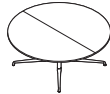

Tip: 60" and 72" round and square table base consists of four single legs. The 84" and 96" round and square table base consists of four v-legs.

Specification Information

Dimensions			Style Number	Base Prices							
L	W	H		Laminate		Veneer		Wedge Veneer Layup		Corian	Glass
				Grade 1	Grade 2	Grade 1	Grade 2	Grade 1	Grade 2		

Large Round Tables

One-Piece Top

60" diameter	28½"	COW_RND60	\$3149	\$3259	\$4414	\$ 4806	\$ 7458	\$ 7825	\$ 6615	\$ 7886
--------------	------	------------------	--------	--------	--------	---------	---------	---------	---------	---------

Two-Piece Top

72" diameter	28½"	COW_RND72	\$4034	\$4172	\$5803	\$ 6317	\$ 9805	\$10,286	\$ 8474	\$10,089
--------------	------	------------------	--------	--------	--------	---------	---------	----------	---------	----------

84" diameter	28½"	COW_RND84	\$5027	\$5200	\$7330	\$ 7982	\$12,386	\$13,012	\$12,062	\$13,824
--------------	------	------------------	--------	--------	--------	---------	----------	----------	----------	----------

96" diameter	28½"	COW_RND96	\$6297	\$6514	\$9281	\$10,105	\$15,683	\$16,452	\$13,225	\$15,743
--------------	------	------------------	--------	--------	--------	----------	----------	----------	----------	----------

Large Square Tables

One-Piece Top

60"	60"	28½"	COW_SQ60	\$3241	\$3353	\$4536	\$ 4939	N.A.	N.A.	\$ 6799	\$ 8254
-----	-----	------	-----------------	--------	--------	--------	---------	------	------	---------	---------

Two-Piece Top

72"	72"	28½"	COW_SQ72	\$4127	\$4271	\$5295	\$ 6451	N.A.	N.A.	\$ 8658	\$10,454
-----	-----	------	-----------------	--------	--------	--------	---------	------	------	---------	----------

84"	84"	28½"	COW_SQ84	\$5118	\$5294	\$7454	\$ 8115	N.A.	N.A.	\$12,247	\$14,190
-----	-----	------	-----------------	--------	--------	--------	---------	------	------	----------	----------

96"	96"	28½"	COW_SQ96	\$6389	\$6609	\$9403	\$10,237	N.A.	N.A.	\$13,408	\$16,109
-----	-----	------	-----------------	--------	--------	--------	----------	------	------	----------	----------

► Specification Information, continued on next page

SW_1 Conference Tables *continued*
 DESIGN SCOTT WILSON & MINIMAL

SIN 711.11

► Specification Information, continued from previous page

Tip: Your specification is not complete until you add the fifth letter to the style number to define top surface.

- L - Laminate top
- V - Wood veneer top
- C - Corian top
- G - Glass top

Tip: Glass tops are not secured to the substructure. Glass tops are placed on rubber pads that are adhered to the substructure. If the glass tables need to be moved, remove the glass top prior to moving the table.

Specification Information

Dimensions			Style Number	Base Prices				Corian	Glass
L	W	H		Laminate		Veneer			
				Grade 1	Grade 2	Grade 1	Grade 2		

Rectangular Tables

One-Piece Top

84"	42"	28½"	COW_RC4284	\$2936	\$3055	\$4052	\$4500	\$ 6849	\$ 8059
96"	48"	28½"	COW_RC4896	\$3361	\$3512	\$4475	\$5072	\$ 7212	\$ 8665
120"	48"	28½"	COW_RC48120	\$4088	\$4256	\$6533	\$7190	\$11,501	\$14,163



Tip: 96"L corian and glass tables require a center in-line leg as standard. The 96"L laminate and veneer tables do not require a center in-line leg for support. Refer to base matrix in the Coalesse Conferencing and Storage specification guide.

Two-Piece Top

120"	48"	28½"	COW_RC48122	\$4451	\$4634	\$6897	\$7612	\$11,863	\$14,528
144"	48"	28½"	COW_RC48144	\$4814	\$5041	\$8230	\$9126	\$12,711	\$15,375

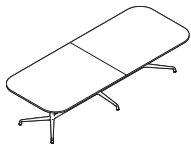

Tip: 144"L and longer are two-piece tops, all three piece tops are noted.

Tip: 144"L corian and glass tables require a center in-line leg as standard. The 144"L laminate and veneer tables do not require a center in-line leg for support. Refer to base matrix in the Coalesse Conferencing and Storage specification guide.

► Specification Information, continued on next page

SW_1 Conference Tables
DESIGN SCOTT WILSON & MINIMAL

SIN 711.11

► Specification Information, continued from previous page

Specification Information

Dimensions			Style Number	Base Prices				Corian	Glass
L	W	H		Laminate Grade 1	Laminate Grade 2	Veneer Grade 1	Veneer Grade 2		

Super Elliptical Tables

One-Piece Top

84"	40"	28½"	COW_SEC84	\$2997	\$ 3116	\$ 4112	\$ 4560	\$ 7030	\$ 8241
96"	40"	28½"	COW_SEC96	\$3421	\$3551	\$ 4536	\$ 5073	\$ 7393	\$ 8847
120"	44"	28½"	COW_SEC120	\$4209	\$4392	\$ 6655	\$ 7370	\$11,743	\$14,406

Two-Piece Top

120"	44"	28½"	COW_SEC122	\$4573	\$4756	\$ 7019	\$ 7734	\$12,105	\$14,770
144"	48"	28½"	COW_SEC144	\$4934	\$ 5161	\$ 8350	\$ 9246	\$12,953	\$15,618
168"	52"	28½"	COW_SEC168	\$5661	\$5948	\$10,294	\$11,655	N.A.	N.A.
192"	56"	28½"	COW_SEC192	\$6449	\$6795	\$12,596	\$14,148	N.A.	N.A.
216"	60"	28½"	COW_SEC216	\$7297	\$7714	\$13,928	\$15,684	N.A.	N.A.
240"	60"	28½"	COW_SEC240	\$8206	\$8696	\$15,260	\$17,199	N.A.	N.A.

Three-Piece Top

216"	60"	28½"	COW_SEC213	\$7660	\$8077	\$14,290	\$16,046	N.A.	N.A.
240"	60"	28½"	COW_SEC243	\$8569	\$9059	\$15,623	\$17,562	N.A.	N.A.

Tip: Glass tops are not secured to the substructure. Glass tops are placed on rubber pads that are adhered to the substructure. If the glass tables need to be moved, remove the glass top prior to moving the table.

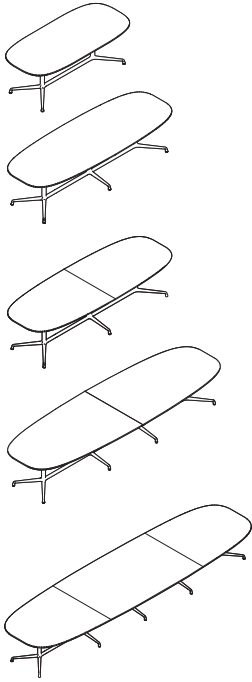

SW_1

SW_1 Round, Square, and Super-Square Tables

DESIGN SCOTT WILSON & MINIMAL

SIN 711.11

Tip: Your specification is not complete until you add the fifth letter to the style number to define top surface.

- L - Laminate top
- V - Wood veneer top
- C - Corian top
- G - Glass top

Tip: Glass tops are not secured to the substructure. Glass tops are placed on rubber pads that are adhered to the substructure. If the glass tables need to be moved, remove the glass top prior to moving the table.

Standard Includes	Required to Specify
<ul style="list-style-type: none"> ▶ Need help? Product details, see <i>Coalesse Tables, Storage, and Accessories Specification Guide</i> • 1/2" thick top surface: <ul style="list-style-type: none"> - Laminate (Grade 1) with 3 mm edge band, if selected - Wood veneer (Grade 1) with matching 3 mm edge band, if selected - Corian, if selected: white only - Glass, if selected • 1/4" thick bottom substructure: black or milk • Base, column, and cone: 8040 Polished Matte Aluminum • Glides • Ships ready-to-assemble 	<ol style="list-style-type: none"> 1 Style number with appropriate top series letter indicated in the space provided. (For example: COW_RND30 becomes COWLRND30 for a laminate top surface): <ul style="list-style-type: none"> L - Laminate top V - Wood veneer top C - Corian top G - Glass top 2 Laminate, wood, or glass color number for top, if selected 3 Plastic color for edge band of laminate top, if selected 4 Bottom substructure: <ul style="list-style-type: none"> 6000 Black 6052 Milk 5 Options, if selected (see below) <ul style="list-style-type: none"> ▶ See <i>Surface Materials</i>, page 350.

Options	Price	Required to Specify
Surface Materials Laminate <ul style="list-style-type: none"> • Grade 2 laminate Wood <ul style="list-style-type: none"> • Grade 2 wood veneer • Grade 1 wedge layup veneer • Grade 2 wedge layup veneer • Stain-to-Match 	Prices below Prices below Prices below No cost	Specify with <i>Grade 2 laminate</i> and select color number. Specify with <i>Grade 2 wood veneer</i> and select color number. Specify with <i>Grade 1 wedge veneer layup</i> and select color number. Specify with <i>Grade 2 wedge veneer layup</i> and select color number. Specify with <i>Stain-to-Match</i> . ▶ Page 385

Veneer direction



Tip: If grommet with wire manager is selected, the finish is not selectable, it will be the same as the substructure finish choice.

Grommet with Wire Management	42" and 48" round, 42" square, and 45 1/2" super-square tables (center only) <ul style="list-style-type: none"> • One grommet 	+\$201	Specify with <i>one grommet with wire manager</i> .
-------------------------------------	--	--------	---

Specification Information

Dimensions L W H	Style Number	Base Prices									
		Laminate		Veneer		Wedge Veneer Layup		Corian	Glass		
		Grade 1	Grade 2	Grade 1	Grade 2	Grade 1	Grade 2				

Round Tables

30 diameter	28 1/2"	COW_RND30	\$1847	\$1878	\$2561	\$2680	N.A.	N.A.	\$2720	\$3264
36 diameter	28 1/2"	COW_RND36	\$1908	\$1950	\$2645	\$2823	\$4077	\$4256	\$2841	\$3566
42 diameter	28 1/2"	COW_RND42	\$1968	\$2027	\$2731	\$2970	\$4581	\$4820	\$2961	\$3869
48 diameter	28 1/2"	COW_RND48	\$2089	\$ 2167	\$2902	\$3171	\$4930	\$5200	\$3083	\$4173

Square Tables

30"	30"	28 1/2"	COW_SQ30	\$1908	\$1939	\$2645	\$2764	N.A.	N.A.	\$2841	\$3566
36"	36"	28 1/2"	COW_SQ36	\$1968	\$2010	\$2731	\$2909	N.A.	N.A.	\$2961	\$3869
42"	42"	28 1/2"	COW_SQ42	\$2089	\$2148	\$2902	\$3141	N.A.	N.A.	\$3083	\$4173

Super-Square Table

45 1/2"	45 1/2"	28 1/2"	COW_SSQ45	\$2179	\$2257	\$3022	\$3291	\$5050	\$5302	\$3264	\$4475
---------	---------	---------	-----------	--------	--------	--------	--------	--------	--------	--------	--------



Coalesce

SW_1 Round, Square, and Super-Square Tables

DESIGN SCOTT WILSON & MINIMAL

SIN 711.11

SW_1

SW_1 Occasional Tables
DESIGN SCOTT WILSON & MINIMAL

SIN 711.11



Standard Includes	Required to Specify
<ul style="list-style-type: none"> ▶ Need help? Product details, see <i>Coalesse Tables, Storage, and Accessories Specification Guide</i> • 1/2" thick top surface: <ul style="list-style-type: none"> - Laminate (Grade 1) with 3 mm edge band, if selected - Wood veneer (Grade 1) with matching 3 mm edge band, if selected - Corian, if selected: white only - Glass, if selected • 1/4" thick bottom substructure: black or milk • Base, column, and cone: 8040 Aluminum Matte Polished • Glides • Ships ready-to assemble 	<ol style="list-style-type: none"> 1 Style number with appropriate top series letter indicated in the space provided. (For example: COWO_RND30 becomes COWOLRND30 for a laminate top surface): <ul style="list-style-type: none"> L - Laminate top V - Wood veneer top C - Corian top G - Glass top 2 Laminate, wood, or glass color number for top, if selected 3 Plastic color for edge band of laminate top, if selected 4 Bottom substructure: <ul style="list-style-type: none"> 6000 Black 6052 Milk 5 Options, if selected (see below) <ul style="list-style-type: none"> ▶ See <i>Surface Materials</i>, page 350.

Options	Price	Required to Specify
Surface Materials Laminate <ul style="list-style-type: none"> • Grade 2 laminate Wood <ul style="list-style-type: none"> • Grade 2 wood veneer • Grade 1 wedge layup veneer • Grade 2 wedge layup veneer • Stain-to-Match 	<ul style="list-style-type: none"> Prices at right Prices at right Prices at right Prices at right No cost 	<ul style="list-style-type: none"> Specify with <i>Grade 2 laminate</i> and select color number. Specify with <i>Grade 2 wood veneer</i> and select color number. Specify with <i>Grade 1 wedge veneer layup</i> and select color number. Specify with <i>Grade 2 wedge veneer layup</i> and select color number. Specify with <i>Stain-to-Match</i>. ▶ Page 385

Veneer direction



Tip: If grommet with wire manager is selected, the finish is not selectable, it will be the same as the substructure finish choice.

Tip: Your specification is not complete until you add the fifth letter to the style number to define top surface.

- L - Laminate top
- V - Wood veneer top
- C - Corian top
- G - Glass top

Grommet <ul style="list-style-type: none"> • One grommet (center only) • One grommet • Two grommets 	42" and 48" round, 42" square and 45 1/2" super-square tables +\$121 60" round and square tables +\$121 60" large round and large square tables +\$242	<ul style="list-style-type: none"> Specify with <i>one grommet</i>. Specify with <i>one grommet</i>. Specify with <i>two grommets</i>.
Related Products <ul style="list-style-type: none"> • SW_1 seating 	<ul style="list-style-type: none"> ▶ See <i>GSA Volume 5a Specification Guide</i>. 	

SW_1 Occasional Tables
DESIGN SCOTT WILSON & MINIMAL

SIN 711.11

Tip: Glass tops are not secured to the substructure. Glass tops are placed on rubber pads that are adhered to the substructure. If the glass tables need to be moved, remove the glass top prior to moving the table.



Specification Information

Dimensions			Style Number	Base Prices							
L	W	H		Laminate		Veneer		Wedge Veneer Layup		Corian	Glass
				Grade 1	Grade 2	Grade 1	Grade 2	Grade 1	Grade 2		

Round Tables

30 diameter	15"	COWO_RND30	\$1787	\$1818	\$2502	\$2621	N.A.	N.A.	\$2660	\$3203
36 diameter	15"	COWO_RND36	\$1847	\$1889	\$2584	\$2762	\$4016	\$4195	\$2780	\$3507
42 diameter	15"	COWO_RND42	\$1908	\$1967	\$2670	\$2909	\$4520	\$4759	\$2902	\$3809
48 diameter	15"	COWO_RND48	\$2030	\$2108	\$2841	\$3110	\$4869	\$5139	\$3022	\$4112

Large Round Table

60" diameter	15"	COWO_RND60	\$3088	\$3198	\$4352	\$4744	\$7396	\$7763	\$6555	\$7827
--------------	-----	-------------------	--------	--------	--------	--------	--------	--------	--------	--------

Square Tables

30"	30"	15"	COWO_SQ30	\$1847	\$1878	\$2584	\$2703	N.A.	N.A.	\$2780	\$3507
36"	36"	15"	COWO_SQ36	\$1908	\$1950	\$2670	\$2848	N.A.	N.A.	\$2902	\$3809
42"	42"	15"	COWO_SQ42	\$2030	\$2089	\$2841	\$3080	N.A.	N.A.	\$3022	\$4112

Large Square Table

60"	60"	15"	COWO_SQ60	\$3180	\$3292	\$4475	\$4878	N.A.	N.A.	\$6738	\$8193
-----	-----	-----	------------------	--------	--------	--------	--------	------	------	--------	--------

Super-Square Table

45½"	45½"	15"	COWO_SSQ45	\$2120	\$2198	\$2961	\$3230	\$4989	\$5241	\$3203	\$4415
------	------	-----	-------------------	--------	--------	--------	--------	--------	--------	--------	--------

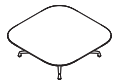

SW_1

SW_1 Work Tables

DESIGN SCOTT WILSON & MINIMAL

SIN 711.11

Standard Includes		Required to Specify
<ul style="list-style-type: none"> ▶ Need help? Product details, see <i>Coalesse Tables, Storage, and Accessories Specification Guide</i> 	<ul style="list-style-type: none"> • 1/2" thick top surface: <ul style="list-style-type: none"> - Laminate (Grade 1) with 3 mm edge band, if selected - Wood veneer (Grade 1) with matching 3 mm edge band, if selected - Corian, if selected: white only - Glass, if selected • 1/4" thick bottom substructure: black or milk • Base, column, and cone: 8040 Polished Matte Aluminum • Glides • Ships ready-to assemble 	<ol style="list-style-type: none"> 1 Style number with appropriate top series letter indicated in the space provided. (For example: COW_RT3060 becomes COWLRT3060 for a laminate top surface): <ul style="list-style-type: none"> L - Laminate top V - Wood veneer top C - Corian top G - Glass top 2 Laminate, wood, or glass color number for top, if selected 3 Plastic color for edge band of laminate top, if selected 4 Bottom substructure: <ul style="list-style-type: none"> 6000 Black 6052 Milk 5 Options, if selected (see below) <ul style="list-style-type: none"> ▶ See <i>Surface Materials</i>, page 350.

Tip: Standard grain direction runs the width of the table (front-to-back).

Tip: Your specification is not complete until you add the fifth letter to the style number to define top surface.

- L - Laminate top
- V - Wood veneer top
- C - Corian top
- G - Glass top

Tip: Glass tops are not secured to the substructure. Glass tops are placed on rubber pads that are adhered to the substructure. If the glass tables need to be moved, remove the glass top prior to moving the table.

Options	Price	Required to Specify
Surface Materials <ul style="list-style-type: none"> • Laminate <ul style="list-style-type: none"> • Grade 2 laminate • Wood <ul style="list-style-type: none"> • Grade 2 wood veneer • Stain-to-Match 	<ul style="list-style-type: none"> Prices below Prices below No cost 	<ul style="list-style-type: none"> Specify with <i>Grade 2 laminate</i> and select color number. Specify with <i>Grade 2 wood veneer</i> and select color number. Specify with <i>Stain-to-Match</i>. ▶ Page 385
Wood Veneer Grain Direction <ul style="list-style-type: none"> • Lengthwise grain direction for tops up to 96"L 	No cost	Specify with <i>lengthwise grain direction</i> .
Related Products <ul style="list-style-type: none"> • SW_1 seating 		▶ See <i>GSA Volume 5a Specification Guide</i> .

Specification Information

Dimensions			Style Number	Prices				Corian	Glass
L	W	H		Laminate	Veneer				
				Grade 1	Grade 2	Grade 1	Grade 2		

Rectangular Tables

60"	30"	28½"	COW_RT3060	\$1908	\$1967	\$3022	\$3261	\$5940	\$6910
72"	30"	28½"	COW_RT3072	\$2030	\$2101	\$3143	\$3424	\$6182	\$7150
60"	36"	28½"	COW_RT3660	\$2030	\$2101	\$3143	\$3424	\$6182	\$7150
72"	36"	28½"	COW_RT3672	\$2150	\$2233	\$3264	\$3588	\$6425	\$7393

Super-Elliptical Tables

60"	40"	28½"	COW_SE4060	\$2089	\$2172	\$3203	\$3527	\$6546	\$7515
72"	40"	28½"	COW_SE4072	\$2331	\$2426	\$3445	\$3808	\$6668	\$7878



Veneer direction



Standard Includes **Required to Specify**

- | | |
|--|---|
| <ul style="list-style-type: none"> • Vertical wire managers: milk or black plastic • Horizontal wire manager, 6-pack: velcro and attachment hardware • Manages small amounts of cords and wires | <ul style="list-style-type: none"> 1 Style number for vertical wire manager, if selected
6000 Black
6052 Milk 2 Style number for horizontal wire manager, if selected ▶ See <i>Coalesse Surface Materials Reference Guide</i>. |
|--|---|

Related Products

- SW_1 tables

Specification Information

Dimensions			Style	Price
L	W	H	Number	

Vertical Wire Manager For Use with Low Conference Tables

N.A.	N.A.	26"	COWVWM26	\$121
------	------	-----	----------	-------

Vertical Wire Manager For Use with Standard Height Tables

N.A.	N.A.	28½"	COWVWM28	\$121
------	------	------	----------	-------

Horizontal Wire Manager Clips (Package of 6)

½"	8"	½"	COWHWM	\$ 49
----	----	----	--------	-------



Tip: Horizontal wire manager clips attach under the work surface with screws.

Storage/Ancillary



Statement of Line 322



Exponents 325

Storage/Ancillary

Statement of Line

Exponents

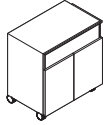

Specifying
▶ Page 326

Exponents Mobile Cart

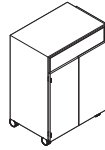

Specifying
▶ Page 328

Exponents Moby

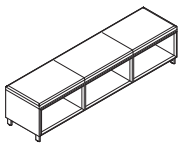

Open

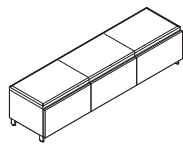

Closed

Specifying
▶ Page 330

Exponents Benches

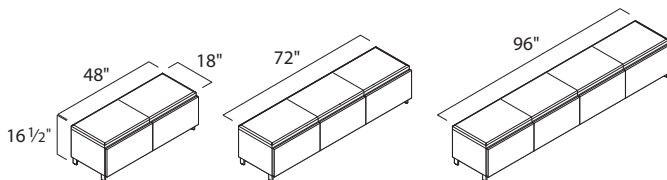
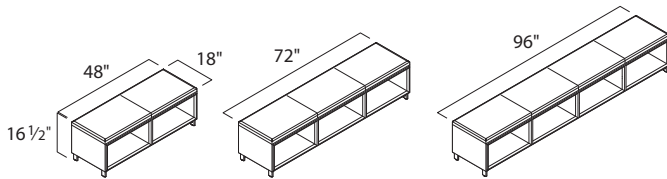

In-line



End-of-Run

Specifying
▶ Page 333

Exponents Bench Bridges

Statement of Line

Exponents

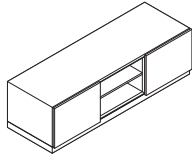

Partial - Open

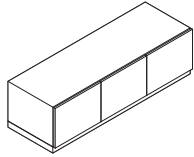

Closed

Specifying
▶ Page 334-340

Exponents Credenzas

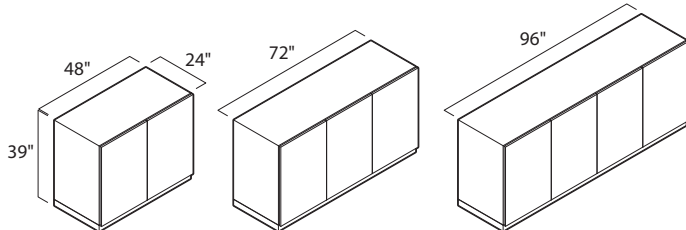
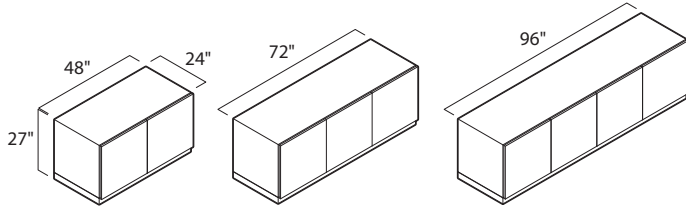
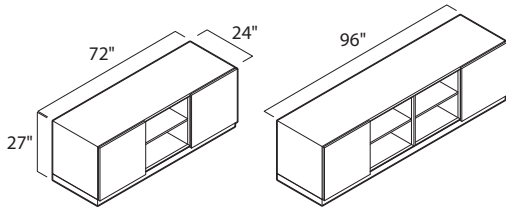

Storage/Ancillary

Statement of Line *continued*

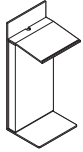

Specifying
▶ Page 343

Exponents Lectern



Specifying
▶ Page 344

Exponents Mobile Whiteboard Display

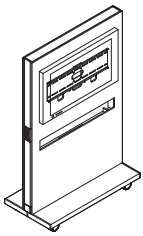

Specifying
▶ Page 345

Exponents Mobile Mediaboard Display

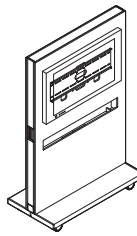

Specifying
▶ Page 346

Exponents Mobile Mediaboard Display with Steelcase media:scape Technology



Specifying
▶ Page 347

Exponents Mediaboard Shelf

Exponents

Carts (SIN 711.2)	326
Benches (SIN 711.2)	330
Bench Bridges (SIN 711.2)	333
Credenzas (SIN 711.2)	334
Accessories (SIN 711.2)	343

Exponents Mobile Cart

DESIGN COALESSE DESIGN GROUP

SIN 711.2

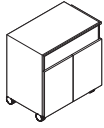

Tip: The handle finish is recommended to match the ribbon finish.

Standard Includes	Required to Specify
<ul style="list-style-type: none"> ▶ Need help? Product details, see <i>Coalesse Tables, Storage, and Accessories Specification Guide</i> • Case with top opening: painted MDF • Door fronts with 110° soft close hinges: painted MDF • Handle: paint • Accent ribbon: paint • One adjustable shelf behind doors: matches case finish • Wire management entry and exit points at bottom • Casters: 6009 Arctic White plastic for V145 Milk painted MDF case or 6000 Black plastic for all other finish choices • Ships assembled, casters require installation • Additional adjustable shelf(s), if selected: painted MDF 	<ol style="list-style-type: none"> 1 Style number 2 Painted MDF color number for case: V145 Milk V197 Black 3 Painted MDF color number for door fronts: V145 Milk V197 Black 4 Paint color number for handle: 4135 Black Matte 4141 Platinum Matte 5 Paint color number for accent ribbon: 4135 Black Matte 4141 Platinum Matte 6 Painted MDF color number for additional adjustable shelf(s), if selected: V145 Milk V197 Black 7 Options, if selected (see below) <p>▶ See <i>Surface Materials</i>, page 350.</p>

Options	Price	Required to Specify
Surface Materials Case and door fronts <ul style="list-style-type: none"> • Grade 1 wood veneer • Grade 2 wood veneer • Stain-to-Match 	<p>Prices at right</p> <p>Prices at right</p> <p>No cost</p>	<p>Specify with <i>Grade 1 wood veneer</i> and select color number.</p> <p>Specify with <i>Grade 2 wood veneer</i> and select color number.</p> <p>Specify with <i>Stain-to-Match</i>.</p> <p>▶ Page 385</p>
Accent ribbon <ul style="list-style-type: none"> • Grade 1 wood veneer • Grade 2 wood veneer • Stain-to-Match 	<p>+\$ 59</p> <p>+\$ 62</p> <p>No cost</p>	<p>Specify with <i>Grade 1 wood veneer</i> and select color number.</p> <p>Specify with <i>Grade 2 wood veneer</i> and select color number.</p> <p>Specify with <i>Stain-to-Match</i>.</p> <p>▶ Page 385</p>
Power <ul style="list-style-type: none"> • 3 power receptacles 	<p>+\$291</p>	<p>Specify with <i>power</i>.</p>
Service Tray Painted MDF <ul style="list-style-type: none"> • Painted MDF: V145 Milk or V197 Black 	<p>+\$756</p>	<p>Specify with <i>painted MDF</i> and select color number.</p>
Wood <ul style="list-style-type: none"> • Grade 1 wood veneer • Grade 2 wood veneer • Stain-to-Match 	<p>+\$907</p> <p>+\$939</p> <p>No cost</p>	<p>Specify with <i>Grade 1 wood veneer</i> and select color number.</p> <p>Specify with <i>Grade 2 wood veneer</i> and select color number.</p> <p>Specify with <i>Stain-to-Match</i>.</p> <p>▶ Page 385</p>
Pull-out Shelf Painted MDF <ul style="list-style-type: none"> • Painted MDF: V145 Milk or V197 Black 	<p>+\$696</p>	<p>Specify with <i>painted MDF</i> and select color number.</p>
Wood <ul style="list-style-type: none"> • Grade 1 wood veneer • Grade 2 wood veneer • Stain-to-Match 	<p>+\$847</p> <p>+\$877</p> <p>No cost</p>	<p>Specify with <i>Grade 1 wood veneer</i> and select color number.</p> <p>Specify with <i>Grade 2 wood veneer</i> and select color number.</p> <p>Specify with <i>Stain-to-Match</i>.</p> <p>▶ Page 385</p>

▶ Options, continued on next page

Tip: When wood veneer is specified on the case and wood veneer is specified for the ribbon, it is recommended the ribbon finish match the wood veneer case selection.

Tip: The power device finish is non-specifiable. If V145 Milk painted MDF is specified, the power device will be white gloss. For all other finish specifications, the power device will be black gloss.

Tip: Power device attaches to the wire management gap at the back of the adjustable shelf.

Tip: Service tray can fit in pull-out shelf, sit in top opening or sit, on top of cart.

Tip: Pull-out shelf is available for the top opening only.

Exponents Mobile Cart

DESIGN COALESSE DESIGN GROUP

SIN 711.2

► Options, continued from previous page

Options	Price	Required to Specify
Lock and Keying		
Lock		
• Nickel	+\$145	Specify with 9211 Nickel lock.
• Ember Chrome	+\$145	Specify with 9250 Ember Chrome lock.
Keying		
• Factory- and field-installed keying units		► See GSA Volume 5a Specification Guide.

Specification Information

Dimensions			Style	Case	Base Prices		
D	W	H	Number		Door Fronts		
					Painted	Grade 1	Grade 2
					MDF	Veneer	Veneer

Mobile Cart

19¾"	30"	32"	COCCD303219	Painted MDF	\$3331	\$3450	\$3481
				Grade 1 Veneer	\$3928	\$4047	\$4078
				Grade 2 Veneer	\$4059	\$4178	\$4209

Specification Information

Dimensions			Style	Base Prices		
D	W	H	Number	Painted	Grade 1	Grade 2
				MDF	Veneer	Veneer

Adjustable Shelf

16½"	28¼"	¾"	COCCMAS30	\$201	\$238	\$246
------	------	----	-----------	-------	-------	-------

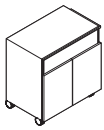

Tip: Adjustable shelf is in addition to the adjustable shelf that is standard on the mobile cart.

Exponents Moby

DESIGN COALESSE DESIGN GROUP

SIN 711.2

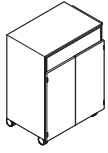

Tip: The handle finish is recommended to match the ribbon finish.

Standard Includes	Required to Specify
-------------------	---------------------

- | | | |
|---|--|---|
| <ul style="list-style-type: none"> ▶ Need help? Product details, see <i>Coalesse Tables, Storage, and Accessories Specification Guide</i> | <ul style="list-style-type: none"> • Case with top opening: painted MDF • Door fronts with 270° hinges: painted MDF • Handle: paint • Accent ribbon: paint • Two adjustable shelves behind doors: matches case finish • Wire management entry and exit points at bottom • Casters: 6009 Arctic White plastic for V145 Milk painted MDF case or 6000 Black plastic for all other finish choices • Ships assembled, casters require installation • Additional adjustable shelf(s), if selected: painted MDF | <ol style="list-style-type: none"> 1 Style number 2 Painted MDF color number for case:
V145 Milk
V197 Black 3 Painted MDF color number for door fronts:
V145 Milk
V197 Black 4 Paint color number for handle:
4135 Black Matte
4141 Platinum Matte 5 Paint color number for accent ribbon:
4135 Black Matte
4141 Platinum Matte 6 Painted MDF color number for additional adjustable shelf(s), if selected:
V145 Milk
V197 Black 7 Options, if selected (see below) <p>▶ See <i>Surface Materials</i>, page 350.</p> |
|---|--|---|

Options	Price	Required to Specify
---------	-------	---------------------

Surface Materials	Case and door fronts <ul style="list-style-type: none"> • Grade 1 wood veneer • Grade 2 wood veneer • Stain-to-Match 	<p>Prices at right</p> <p>Prices at right</p> <p>No cost</p>	<p>Specify with <i>Grade 1 wood veneer</i> and select color number.</p> <p>Specify with <i>Grade 2 wood veneer</i> and select color number.</p> <p>Specify with <i>Stain-to-Match</i>.</p> <p>▶ Page 385</p>
	Accent ribbon <ul style="list-style-type: none"> • Grade 1 wood veneer • Grade 2 wood veneer • Stain-to-Match 	<p>+\$ 90</p> <p>+\$ 93</p> <p>No cost</p>	<p>Specify with <i>Grade 1 wood veneer</i> and select color number.</p> <p>Specify with <i>Grade 2 wood veneer</i> and select color number.</p> <p>Specify with <i>Stain-to-Match</i>.</p> <p>▶ Page 385</p>
Power	<ul style="list-style-type: none"> • 3 power receptacles 	<p>+\$291</p>	<p>Specify with <i>power</i>.</p>
Interior Configurations	<ul style="list-style-type: none"> • Personal drawer and adjustable shelf interior to match case • Fixed shelf, personal drawer and file drawer interior to match case 	<p>+\$239</p> <p>+\$571</p>	<p>Specify with <i>personal drawer and adjustable shelf interior</i>.</p> <p>Specify with <i>fixed shelf, personal drawer, and file drawer interior</i>.</p>
Lock and Keying	Lock <ul style="list-style-type: none"> • Nickel • Ember Chrome 	<p>+\$145</p> <p>+\$145</p>	<p>Specify with <i>9211 Nickel lock</i>.</p> <p>Specify with <i>9250 Ember Chrome lock</i>.</p>
	Keying <ul style="list-style-type: none"> • Factory- and field-installed keying units 		<p>▶ See <i>GSA Volume 5a Specification Guide</i>.</p>

Tip: When wood veneer is specified on the case and wood veneer is specified for the ribbon, it is recommended the ribbon finish match the wood veneer case selection.

Tip: The power device finish is non-specifiable. If V145 Milk painted MDF is specified, the power device will be white gloss. For all other finish specifications, the power device will be black gloss.

Tip: Interior configurations match the case selection finish.

Exponents Moby

DESIGN COALESSE DESIGN GROUP

SIN 711.2

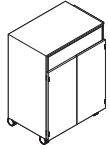

Specification Information

Dimensions			Style	Case	Base Prices		
D	W	H	Number		Door Fronts		
					Painted	Grade 1	Grade 2
					MDF	Veneer	Veneer

Moby

19 ³ / ₄ "	30"	42"	COCMD304219	Painted MDF	\$3785	\$3904	\$3937
				Grade 1 Veneer	\$4442	\$4561	\$4594
				Grade 2 Veneer	\$4591	\$4710	\$4743

Specification Information

Dimensions			Style	Base Prices		
D	W	H	Number	Painted	Grade 1	Grade 2
				MDF	Veneer	Veneer

Adjustable Shelf

16 ¹ / ₂ "	28 ¹ / ₄ "	3 ³ / ₄ "	COCCMAS30	\$201	\$238	\$246
----------------------------------	----------------------------------	---------------------------------	-----------	-------	-------	-------



Tip: Adjustable shelf is in addition to the adjustable shelf that is standard on the mobile cart.

Exponents Benches

DESIGN COALESSE DESIGN GROUP

SIN 711.2

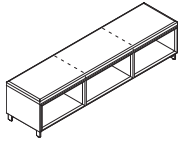

► Need help?
Product details, see *Coalesse Tables, Storage, and Accessories Specification Guide*

Standard Includes

- Case: painted MDF
- Unfinished outside back: black backer
- Door fronts with pull down self opening door with soft close catch, if selected: painted MDF
- Accent ribbon: paint
- Metal base: paint
- Ships assembled, seat cushion requires installation

Required to Specify

- 1 Style number
- 2 Painted MDF color number for case:
V145 Milk
V197 Black
- 3 Paint color number for metal base:
4135 Black Matte
4141 Platinum Matte
- 4 Painted MDF color number for door fronts, if selected:
V145 Milk
V197 Black
- 5 Paint color number for accent ribbon:
4135 Black Matte
4141 Platinum Matte
- 6 Seat cushion finish number:
- Fabric
- Leather
- 7 Options, if selected (see below)
► See *Surface Materials*, page 350.

Tip: Specification is not complete until a fabric selection is specified.

Required Selections	Price	Required to Specify
Upholstery for 48"W and 72"W benches		
• Fabric price group 6	+\$ 47	Specify <i>with upholstery</i> and select fabric color number.
• Fabric price group 7	+\$ 72	Specify <i>with upholstery</i> and select fabric color number.
• Fabric price group 8	+\$ 94	Specify <i>with upholstery</i> and select fabric color number.
• Fabric price group 9	+\$145	Specify <i>with upholstery</i> and select fabric color number.
• Fabric price group 10	+\$180	Specify <i>with upholstery</i> and select fabric color number.
• Fabric price group 11	+\$207	Specify <i>with upholstery</i> and select fabric color number.
• Fabric price group 12	+\$223	Specify <i>with upholstery</i> and select fabric color number.
• Fabric price group 13	+\$306	Specify <i>with upholstery</i> and select fabric color number.
• Fabric price group 14	+\$419	Specify <i>with upholstery</i> and select fabric color number.
• COM	+\$ 70	Specify <i>with upholstery</i> and select fabric color number.
• COL	+\$281	Specify <i>with upholstery</i> and select fabric color number.
• Leather price group C for 48"W only	+\$583	Specify <i>with upholstery</i> and select fabric color number.
• Leather price group E for 48"W only	+\$644	Specify <i>with upholstery</i> and select fabric color number.
• Leather price group C for 72"W only	+\$670	Specify <i>with upholstery</i> and select fabric color number.
• Leather price group E for 72"W only	+\$742	Specify <i>with upholstery</i> and select fabric color number.
Upholstery for 96"W benches		
• Fabric price group 6	+\$ 67	Specify <i>with upholstery</i> and select fabric color number.
• Fabric price group 7	+\$104	Specify <i>with upholstery</i> and select fabric color number.
• Fabric price group 8	+\$133	Specify <i>with upholstery</i> and select fabric color number.
• Fabric price group 9	+\$206	Specify <i>with upholstery</i> and select fabric color number.
• Fabric price group 10	+\$260	Specify <i>with upholstery</i> and select fabric color number.
• Fabric price group 11	+\$294	Specify <i>with upholstery</i> and select fabric color number.

► Required Selections, continued on next page

Exponents Benches

DESIGN COALESSE DESIGN GROUP

SIN 711.2

► Required Selections, continued from previous page

Tip: Specification is not complete until a fabric selection is specified.

Required Selections	Price	Required to Specify
Upholstery for 96"W benches, continued		
• Fabric price group 12	+\$322	Specify with <i>upholstery</i> and select fabric color number.
• Fabric price group 13	+\$439	Specify with <i>upholstery</i> and select fabric color number.
• Fabric price group 14	+\$600	Specify with <i>upholstery</i> and select fabric color number.
• COM	+\$ 98	Specify with <i>upholstery</i> and select fabric color number.
• COL	+\$281	Specify with <i>upholstery</i> and select fabric color number.
• Leather price group C for 96"W only	+\$882	Specify with <i>upholstery</i> and select fabric color number.
• Leather price group E for 96"W only	+\$975	Specify with <i>upholstery</i> and select fabric color number.

Tip: When wood veneer is specified on the case and wood veneer is specified for the ribbon, it is recommended the ribbon finish match the wood veneer case selection.

Options	Price	Required to Specify
Surface Materials		
Acrylic backer for seat cushion		
• Backer for 48"W and 72"W benches	+\$ 17	Specify with <i>acrylic backer</i> .
• Backer for 96"W benches	+\$ 23	Specify with <i>acrylic backer</i> .
Case and door fronts		
• Grade 1 wood veneer	Prices at right	Specify with <i>Grade 1 wood veneer</i> and select color number.
• Grade 2 wood veneer	Prices at right	Specify with <i>Grade 2 wood veneer</i> and select color number.
• Stain-to-Match	No cost	Specify with <i>Stain-to-Match</i> . ► Page 385
Accent ribbon		
• 48"W bench with Grade 1 wood veneer	+\$ 59	Specify with <i>Grade 1 wood veneer</i> accent and select color number.
• 48"W bench with Grade 2 wood veneer	+\$ 62	Specify with <i>Grade 2 wood veneer</i> accent and select color number.
• 72"W bench with Grade 1 wood veneer	+\$ 90	Specify with <i>Grade 1 wood veneer</i> accent and select color number.
• 72"W bench with Grade 2 wood veneer	+\$ 93	Specify with <i>Grade 2 wood veneer</i> accent and select color number.
• 96"W bench with Grade 1 wood veneer	+\$119	Specify with <i>Grade 1 wood veneer</i> accent and select color number.
• 96"W bench with Grade 2 wood veneer	+\$124	Specify with <i>Grade 2 wood veneer</i> accent and select color number.
• Stain-to-Match	No cost	Specify with <i>Stain-to-Match</i> . ► Page 385
Finished back panel		
• 48"W credenza	+\$169	Specify with <i>finished back panel</i> .
• 72"W credenza	+\$233	Specify with <i>finished back panel</i> .
• 96"W credenza	+\$286	Specify with <i>finished back panel</i> .
Lock and Keying		
Locks		
• 48"W bench	+\$226	Specify with <i>9211 Nickel locks</i> or with <i>9250 Ember Chrome locks</i> .
• 72"W bench	+\$339	Specify with <i>9211 Nickel locks</i> or with <i>9250 Ember Chrome locks</i> .
• 96"W bench	+\$452	Specify with <i>9211 Nickel locks</i> or with <i>9250 Ember Chrome locks</i> .
Keying		
• Factory- and field-installed keying units		► See <i>GSA Volume 5a Specification Guide</i> .

Tip: When finished back panel is specified, the finish will match the case finish.

► Specification Information, on next page

Exponents Benches *continued*

DESIGN COALESSE DESIGN GROUP

SIN 711.2

► Options, on previous page

Specification Information

Dimensions			Style Number	Base Prices		
D	W	H		Painted MDF	Grade 1 Veneer	Grade 2 Veneer

Open Benches

48"W

18"	48"	16½"	COCZBOC184815	\$2301	\$2659	\$2750
COM/yds = 1¾, COL/sq ft = 33						

72"W

18"	72"	16½"	COCZBOC187215	\$2754	\$3142	\$3248
COM/yds = 1¾, COL/sq ft = 33						

96"W

18"	96"	16½"	COCZBOC189615	\$3240	\$3628	\$3747
COM/yds = 2½, COL/sq ft = 50						

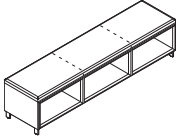

Specification Information

Dimensions			Style Number	Case	Base Prices			
D	W	H			Door Fronts			
						Painted MDF	Grade 1 Veneer	Grade 2 Veneer

Benches with Doors

48"W

18¾"	48"	16½"	COCZBDC184815	Painted MDF	\$3210	\$3388	\$3431
				Grade 1 Veneer	\$3568	\$3746	\$3789
				Grade 2 Veneer	\$3659	\$3837	\$3880
COM/yds = 1¾, COL/sq ft = 33							

72"W

18¾"	72"	16½"	COCZBDC187215	Painted MDF	\$3916	\$4150	\$4204
				Grade 1 Veneer	\$4304	\$4538	\$4592
				Grade 2 Veneer	\$4410	\$4644	\$4698
COM/yds = 1¾, COL/sq ft = 33							

96"W

18¾"	96"	16½"	COCZBDC189615	Painted MDF	\$4645	\$4932	\$4998
				Grade 1 Veneer	\$5033	\$5320	\$5386
				Grade 2 Veneer	\$5152	\$5439	\$5505
COM/yds = 2½, COL/sq ft = 50							

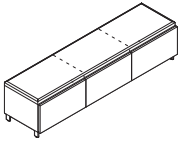

Exponents Bench Bridges

DESIGN COALESSE DESIGN GROUP

SIN 711.2

Standard Includes		Required to Specify
<ul style="list-style-type: none"> ▶ Need help? Product details, see <i>Coalesse Tables, Storage, and Accessories Specification Guide</i> 	<ul style="list-style-type: none"> • Case: painted MDF • In-line bridges: unfinished sides, black backer • Metal base, end-of-run bridge only: paint • Brackets with connecting hardware: black matte paint only • Corner bridge back corner leg: black matte paint only • Ships assembled 	<ol style="list-style-type: none"> 1 Style number 2 Painted MDF color number for case: V145 Milk V197 Black 3 Paint color number for end-of-run base, if selected: 4135 Black Matte 4141 Platinum Matte 4 Options, if selected (see below) <p>▶ See <i>Surface Materials</i>, page 350.</p>

	Options	Price	Required to Specify
Surface Materials	Case		
	• Grade 1 wood veneer	Prices below	Specify with <i>Grade 1 wood veneer</i> and select color number.
	• Grade 2 wood veneer	Prices below	Specify with <i>Grade 2 wood veneer</i> and select color number.
	• Stain-to-Match	No cost	Specify with <i>Stain-to-Match</i> . ▶ Page 385
Power	• 3 power receptacles	+\$291	Specify with <i>power</i> .

Tip: The power device finish is non-specifiable. If V145 Milk painted MDF is specified, the power device will be white gloss. For all other finish specifications, the power device will be black gloss.

Specification Information

Dimensions			Style Number	Base Prices		
D	W	H		Painted MDF	Grade 1 Veneer	Grade 2 Veneer

In-Line Bridge

18"	24"	15"	COCZB1182415	\$1342	\$1541	\$1602
-----	-----	-----	--------------	--------	--------	--------

End-of-Run Bridge

18"	24"	15"	COCZBE182415	\$1574	\$1808	\$1877
-----	-----	-----	--------------	--------	--------	--------



Exponents Credenzas 27"H

DESIGN COALESSE DESIGN GROUP

SIN 711.2

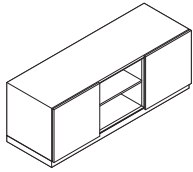

► Need help?
Product details, see *Coalesse Tables, Storage, and Accessories Specification Guide*

Standard Includes

- Case: painted MDF
- Unfinished outside back: black backer
- Door fronts with 110° soft close hinges, if selected: painted MDF
- Accent ribbon: paint
- Plinth base: matches case finish
- One adjustable shelf per opening, behind doors: matches case
- One adjustable shelf per opening, without doors (for open or partial open credenzas): painted MDF
- Ships assembled
- Additional adjustable shelf(s), if selected: painted MDF

Required to Specify

- 1 Style number
- 2 Painted MDF color number for case:
V145 Milk
V197 Black
- 3 Painted MDF color number for door fronts, if selected:
V145 Milk
V197 Black
- 4 Paint color number for accent ribbon:
4135 Black Matte
4141 Platinum Matte
- 5 Painted MDF color number for additional adjustable shelf(s), if selected:
V145 Milk MDF
V197 Black MDF
- 6 Options, if selected (see below)
► See *Surface Materials*, page 350.

Tip: When wood veneer is specified on the case and wood veneer is specified for the ribbon, it is recommended the ribbon finish match the wood veneer case selection.

Options	Price	Required to Specify
Surface Materials		
Case and door fronts		
• Grade 1 wood veneer	Prices at right	Specify with <i>Grade 1 wood veneer</i> and select color number.
• Grade 2 wood veneer	Prices at right	Specify with <i>Grade 2 wood veneer</i> and select color number.
• Stain-to-Match	No cost	Specify with <i>Stain-to-Match</i> . ► Page 385
Accent ribbon		
• 48"W credenza with Grade 1 wood veneer	+\$119	Specify with <i>Grade 1 wood veneer</i> accent and select color number.
• 48"W credenza with Grade 2 wood veneer	+\$124	Specify with <i>Grade 2 wood veneer</i> accent and select color number.
• 72"W credenza with Grade 1 wood veneer	+\$151	Specify with <i>Grade 1 wood veneer</i> accent and select color number.
• 72"W credenza with Grade 2 wood veneer	+\$156	Specify with <i>Grade 2 wood veneer</i> accent and select color number.
• 96"W credenza with Grade 1 wood veneer	+\$178	Specify with <i>Grade 1 wood veneer</i> accent and select color number.
• 96"W credenza with Grade 2 wood veneer	+\$185	Specify with <i>Grade 2 wood veneer</i> accent and select color number.
• Stain-to-Match	No cost	Specify with <i>Stain-to-Match</i> . ► Page 385
Finished back panel		
• 48"W credenza	+\$233	Specify with <i>finished back panel</i> .
• 72"W credenza	+\$291	Specify with <i>finished back panel</i> .
• 96"W credenza	+\$338	Specify with <i>finished back panel</i> .
Adjustable shelf		
• 1 Adjustable shelf		
- With Grade 1 wood veneer	+\$ 31	Specify with <i>one open adjustable shelf</i> and select color number, if required.
- With Grade 2 wood veneer	+\$ 38	Specify with <i>one open adjustable shelf</i> and select color number, if required.
- With Stain-to-Match	No cost	Specify with <i>Stain-to-Match</i> . ► Page 385
• 2 Adjustable shelves		
- With Grade 1 wood veneer	+\$ 62	Specify with <i>two open adjustable shelves</i> and select color number, if required.
- With Grade 2 wood veneer	+\$ 76	Specify with <i>two open adjustable shelves</i> and select color number, if required.
- With Stain-to-Match	No cost	Specify with <i>Stain-to-Match</i> . ► Page 385

Tip: When finished back panel is specified, the finish will match the case finish.

Tip: For the adjustable shelf without doors, open or partial open credenzas, a contrasting finish can be specified. The adjustable shelves behind the doors are not specifiable and will match the case specification.

► Options, continued on next page

Exponents Credenzas 27"H

DESIGN COALESSE DESIGN GROUP

SIN 711.2

►Options, continued from previous page

	Options	Price	Required to Specify
Metal Legs	• Black matte or platinum matte – 48"W credenza	+\$ 273	Specify with <i>metal legs</i> and select paint color number.
	– 72"W credenza	+\$ 334	Specify with <i>metal legs</i> and select paint color number.
	– 96"W credenza	+\$ 395	Specify with <i>metal legs</i> and select paint color number.

Tip: Pull-out shelf is available for the middle open section(s) only. For a 72"W credenza, the pull-out shelf is available in the middle open section only. For a 96"W credenza, the pull-out shelf is available in the middle two open sections only.

Tip: The pull-out shelf does not replace the adjustable shelf.

Pull-out Shelf for 72"W and 96"W Credenzas only	72"W (center/middle location only)		
	• With painted MDF	+\$ 696	Specify with <i>one pull-out shelf</i> and select color number.
	• With Grade 1 wood veneer	+\$ 847	Specify with <i>one pull-out shelf</i> and select color number.
	• With Grade 2 wood veneer	+\$ 877	Specify with <i>one pull-out shelf</i> and select color number.
	• Stain-to-Match	No cost	Specify with <i>Stain-to-Match</i> . ► Page 385
	96"W (two center/middle locations only)		
	Left center location only		
	• With painted MDF	+\$ 696	Specify with <i>one pull-out shelf</i> , left center location and select color number.
	• With Grade 1 wood veneer	+\$ 847	Specify with <i>one pull-out shelf</i> , left center location and select color number.
	• With Grade 2 wood veneer	+\$ 877	Specify with <i>one pull-out shelf</i> , left center location and select color number.
	• Stain-to-Match	No cost	Specify with <i>Stain-to-Match</i> . ► Page 385
	Right center location only		
• With painted MDF	+\$ 696	Specify with <i>one pull-out shelf</i> , right center location and select color number.	
• With Grade 1 wood veneer	+\$ 847	Specify with <i>one pull-out shelf</i> , right center location and select color number.	
• With Grade 2 wood veneer	+\$ 877	Specify with <i>one pull-out shelf</i> , right center location and select color number.	
• Stain-to-Match	No cost	Specify with <i>Stain-to-Match</i> . ► Page 385	
Left and right center locations			
• With painted MDF	+\$1392	Specify with <i>two pull-out shelves</i> , left center and right center location and select color number.	
• With Grade 1 wood veneer	+\$1694	Specify with <i>two pull-out shelves</i> , left center and right center location and select color number.	
• With Grade 2 wood veneer	+\$1754	Specify with <i>two pull-out shelves</i> , left center and right center location and select color number.	
• Stain-to-Match	No cost	Specify with <i>Stain-to-Match</i> . ► Page 385	

Tip: Painted MDF accent top should be specified with a veneer case. Wood veneer accent top should be specified with a painted MDF case. Corian and glass accent tops can be specified with a wood veneer or painted MDF case.

Accent Top	Painted MDF for wood veneer cases		
	• 48"W credenza	+\$ 606	Specify with <i>painted MDF accent top</i> and select color number.
	• 72"W credenza	+\$ 762	Specify with <i>painted MDF accent top</i> and select color number.
	• 96"W credenza	+\$1000	Specify with <i>painted MDF accent top</i> and select color number.
	Grade 1 wood veneer for painted MDF cases		
	• 48"W credenza	+\$ 726	Specify with <i>Grade 1 wood veneer accent top</i> and select color number.
	• 72"W credenza	+\$ 914	Specify with <i>Grade 1 wood veneer accent top</i> and select color number.
	• 96"W credenza	+\$1200	Specify with <i>Grade 1 wood veneer accent top</i> and select color number.
	• Stain-to-Match	No cost	Specify with <i>Stain-to-Match</i> . ► Page 385

►Options, continued on next page

Exponents Credenzas 27"H *continued*

DESIGN COALESSE DESIGN GROUP

SIN 711.2

►Options, continued from previous page

	Options	Price	Required to Specify				
Accent Top	Grade 2 wood veneer for painted MDF cases						
	• 48"W credenza	+\$ 726	Specify with <i>Grade 2 wood veneer accent top</i> and select color number.				
	• 72"W credenza	+\$ 914	Specify with <i>Grade 2 wood veneer accent top</i> and select color number.				
	• 96"W credenza	+\$1200	Specify with <i>Grade 2 wood veneer accent top</i> and select color number.				
	• Stain-to-Match	No cost	Specify with <i>Stain-to-Match</i> .				
	<hr/>						
	Corian: glacier white only						
	• 48"W credenza	+\$1235	Specify with <i>Corian accent top</i> .				
	• 72"W credenza	+\$1554	Specify with <i>Corian accent top</i> .				
	• 96"W credenza	+\$2038	Specify with <i>Corian accent top</i> .				
<hr/>							
Glass							
• 48"W credenza	+\$1453	Specify with <i>glass accent top</i> and select color number.					
• 72"W credenza	+\$1829	Specify with <i>glass accent top</i> and select color number.					
• 96"W credenza	+\$2397	Specify with <i>glass accent top</i> and select color number.					
<hr/>							
<p><i>Tip: Multiple grommet locations can be specified on any given credenza. For a 48"W credenza, a maximum of two grommets can be specified. For a 72"W credenza, a maximum of three grommets can be specified. For a 96"W credenza, a maximum of four grommets can be specified.</i></p> <p><i>Tip: Grommets can be specified on credenzas with and without accent tops.</i></p>	Grommets: black matte or platinum matte	No Accent Top, Painted MDF Accent Top or Wood Veneer Accent Top					
		48"W credenza					
		• Grommet, left	+\$ 60	+\$91		+\$121	Specify with <i>grommet left</i> and select color number.
		• Grommet, right	+\$ 60	+\$91		+\$121	Specify with <i>grommet right</i> and select color number.
		72"W credenza					
		• Grommet, left	+\$ 60	+\$91		+\$121	Specify with <i>grommet left center</i> and select color number.
		• Grommet, center	+\$ 60	+\$91		+\$121	Specify with <i>grommet center</i> and select color number.
		• Grommet, right	+\$ 60	+\$91		+\$121	Specify with <i>grommet right</i> and select color number.
		96"W credenza					
		• Grommet, left	+\$ 60	+\$91		+\$121	Specify with <i>grommet left</i> and select color number.
		• Grommet, left center	+\$ 60	+\$91		+\$121	Specify with <i>grommet left center</i> and select color number.
		• Grommet, right center	+\$ 60	+\$91		+\$121	Specify with <i>grommet right center</i> and select color number.
		• Grommet, right	+\$ 60	+\$91		+\$121	Specify with <i>grommet right</i> and select color number.
		<hr/>					
		Lock and Keying	Lock				
• 2 doors	+\$ 226		Specify with <i>9211 Nickel locks</i> or with <i>9250 Ember Chrome locks</i> .				
• 3 doors	+\$ 339		Specify with <i>9211 Nickel locks</i> or with <i>9250 Ember Chrome locks</i> .				
• 4 doors	+\$ 452		Specify with <i>9211 Nickel locks</i> or with <i>9250 Ember Chrome locks</i> .				
<hr/>							
Keying							
• Factory- and field-installed keying units			► See <i>GSA Volume 5a Specification Guide</i> .				

►Options, continued on next page

Exponents Credenzas 27"H

DESIGN COALESSE DESIGN GROUP

SIN 711.2

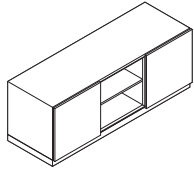

Specification Information

Dimensions			Style Number	Case	Base Prices		
D	W	H			Door Fronts		
					Painted MDF	Grade 1 Veneer	Grade 2 Veneer

Partial Open Credenzas

72"W

24 ³ / ₄ "	72"	27"	COCZD0257227	Painted MDF	\$5107	\$5298	\$5346
				Grade 1 Veneer	\$5822	\$6013	\$6061
				Grade 2 Veneer	\$5995	\$6186	\$6234

96"W

24 ³ / ₄ "	96"	27"	COCZD0259627	Painted MDF	\$5804	\$5995	\$6043
				Grade 1 Veneer	\$6580	\$6771	\$6819
				Grade 2 Veneer	\$6776	\$6967	\$7015

Credenzas with Doors

48"W

24 ³ / ₄ "	48"	27"	COCZD254827	Painted MDF	\$4590	\$4781	\$4829
				Grade 1 Veneer	\$5187	\$5378	\$5426
				Grade 2 Veneer	\$5339	\$5530	\$5578

72"W

24 ³ / ₄ "	72"	27"	COCZD257227	Painted MDF	\$5571	\$5840	\$5904
				Grade 1 Veneer	\$6286	\$6555	\$6619
				Grade 2 Veneer	\$6465	\$6734	\$6798

96"W

24 ³ / ₄ "	96"	27"	COCZD259627	Painted MDF	\$6565	\$6899	\$6980
				Grade 1 Veneer	\$7401	\$7735	\$7816
				Grade 2 Veneer	\$7601	\$7935	\$8016

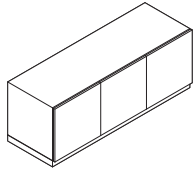

Tip: Adjustable shelf is in addition to the adjustable shelves that are standard on the credenza.

Specification Information

Dimensions			Style Number	Base Prices		
D	W	H		Painted MDF	Grade 1 Veneer	Grade 2 Veneer

Adjustable Shelf for 48"W Credenzas

22 ¹ / ₄ "	22 ⁷ / ₈ "	3/4"	COCZAS48	\$201	\$238	\$246
----------------------------------	----------------------------------	------	----------	-------	-------	-------

Adjustable Shelf for 72"W Credenzas, End Compartments

22 ¹ / ₄ "	22 ¹ / ₂ "	3/4"	COCZASEND72	\$201	\$238	\$246
----------------------------------	----------------------------------	------	-------------	-------	-------	-------

Adjustable Shelf for 72"W Credenzas, Middle Compartments

22 ¹ / ₄ "	24"	3/4"	COCZASMID72	\$201	\$238	\$246
----------------------------------	-----	------	-------------	-------	-------	-------

► Specification Information, continued on next page

Exponents Credenzas 27"H *continued*

DESIGN COALESSE DESIGN GROUP

SIN 711.2

► Specification Information, continued from previous page

Specification Information

Dimensions			Style Number	Base Prices		
D	W	H		Painted MDF	Grade 1 Veneer	Grade 2 Veneer

Adjustable Shelf for 96"W Credenzas, End Compartments

22¼"	22½"	¾"	COCZASND96	\$201	\$238	\$246
------	------	----	------------	-------	-------	-------

Adjustable Shelf for 96"W Credenzas, Middle Compartments

22¼"	23⅝"	¾"	COCZASMD96	\$201	\$238	\$246
------	------	----	------------	-------	-------	-------



Tip: Adjustable shelf is in addition to the adjustable shelves that are standard on the credenza.

Coalesse

Exponents Credenzas 27"H

DESIGN COALESSE DESIGN GROUP

SIN 711.2

Exponents Credenzas 39"H

DESIGN COALESSE DESIGN GROUP

SIN 711.2

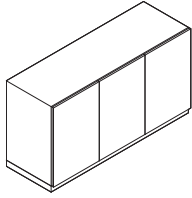

► Need help?
Product details, see *Coalesse Tables, Storage, and Accessories Specification Guide*

- Standard Includes**
- Case: painted MDF
 - Unfinished outside back: black backer
 - Door fronts with 110° soft close hinges, if selected: painted MDF
 - Accent ribbon: paint
 - Plinth base: matches case finish
 - Two adjustable shelves per opening, behind doors: matches case
 - Ships assembled
 - Additional adjustable shelf(s), if selected: painted MDF

- Required to Specify**
- 1 Style number
 - 2 Painted MDF color number for case:
V145 Milk
V197 Black
 - 3 Painted MDF color number for door fronts, if selected:
V145 Milk
V197 Black
 - 4 Paint color number for accent ribbon:
4135 Black Matte
4141 Platinum Matte
 - 5 Painted MDF color number for additional adjustable shelf(s), if selected:
V145 Milk MDF
V197 Black MDF
 - 6 Options, if selected (see below)
► See *Surface Materials*, page 350.

Tip: When wood veneer is specified on the case and wood veneer is specified for the ribbon, it is recommended the ribbon finish match the wood veneer case selection.

	Options	Price	Required to Specify
Surface Materials	Case and door fronts		
	• Grade 1 wood veneer	Prices at right	Specify with <i>Grade 1 wood veneer</i> and select color number.
	• Grade 2 wood veneer	Prices at right	Specify with <i>Grade 2 wood veneer</i> and select color number.
	• Stain-to-Match	No cost	Specify with <i>Stain-to-Match</i> . ► Page 385
	Accent ribbon		
	• 48"W credenza with Grade 1 wood veneer	+\$ 151	Specify with <i>Grade 1 wood veneer</i> accent and select color number.
	• 48"W credenza with Grade 2 wood veneer	+\$ 156	Specify with <i>Grade 2 wood veneer</i> accent and select color number.
	• 72"W credenza with Grade 1 wood veneer	+\$ 178	Specify with <i>Grade 1 wood veneer</i> accent and select color number.
	• 72"W credenza with Grade 2 wood veneer	+\$ 185	Specify with <i>Grade 2 wood veneer</i> accent and select color number.
	• 96"W credenza with Grade 1 wood veneer	+\$ 210	Specify with <i>Grade 1 wood veneer</i> accent and select color number.
• 96"W credenza with Grade 2 wood veneer	+\$ 217	Specify with <i>Grade 2 wood veneer</i> accent and select color number.	
• Stain-to-Match	No cost	Specify with <i>Stain-to-Match</i> . ► Page 385	
	Finished back panel		
	• 48"W credenza	+\$ 291	Specify with <i>finished back panel</i> .
	• 72"W credenza	+\$ 338	Specify with <i>finished back panel</i> .
• 96"W credenza	+\$ 402	Specify with <i>finished back panel</i> .	
Metal Legs	• Black matte or platinum matte - 48"W credenza	+\$ 273	Specify with <i>metal legs</i> and select paint color number.
	- 72"W credenza	+\$ 334	Specify with <i>metal legs</i> and select paint color number.
	- 96"W credenza	+\$ 395	Specify with <i>metal legs</i> and select paint color number.
Accent Top	Painted MDF for wood veneer cases		
	• 48"W credenza	+\$ 606	Specify with <i>painted MDF accent top</i> and select color number.
	• 72"W credenza	+\$ 762	Specify with <i>painted MDF accent top</i> and select color number.
• 96"W credenza	+\$1000	Specify with <i>painted MDF accent top</i> and select color number.	

Tip: When finished back panel is specified, the finish will match the case finish.

Tip: Painted MDF accent top should be specified with a veneer case. Wood veneer accent top should be specified with a painted MDF case. Corian and glass accent tops can be specified with a wood veneer or painted MDF case.

► Options, continued on next page

Exponents Credenzas 39"H

DESIGN COALESSE DESIGN GROUP

SIN 711.2

► Options, continued from previous page

Options	Price	Required to Specify
Accent Top		
Grade 1 wood veneer for painted MDF cases		
• 48"W credenza	+\$ 726	Specify with <i>Grade 1 wood veneer accent top</i> and select color number. Specify with <i>Grade 1 wood veneer accent top</i> and select color number. Specify with <i>Grade 1 wood veneer accent top</i> and select color number. Specify with <i>Stain-to-Match</i> . ► Page 385
• 72"W credenza	+\$ 914	
• 96"W credenza	+\$1200	
• Stain-to-Match	No cost	
Grade 2 wood veneer for painted MDF cases		
• 48"W credenza	+\$ 726	Specify with <i>Grade 2 wood veneer accent top</i> and select color number. Specify with <i>Grade 2 wood veneer accent top</i> and select color number. Specify with <i>Grade 2 wood veneer accent top</i> and select color number. Specify with <i>Stain-to-Match</i> . ► Page 385
• 72"W credenza	+\$ 914	
• 96"W credenza	+\$1200	
• Stain-to-Match	No cost	
Corian: glacier white only		
• 48"W credenza	+\$1235	Specify with <i>Corian accent top</i> . Specify with <i>Corian accent top</i> . Specify with <i>Corian accent top</i> .
• 72"W credenza	+\$1554	
• 96"W credenza	+\$2038	
Glass		
• 48"W credenza	+\$1453	Specify with <i>glass accent top</i> and select color number. Specify with <i>glass accent top</i> and select color number. Specify with <i>glass accent top</i> and select color number.
• 72"W credenza	+\$1829	
• 96"W credenza	+\$2397	
Grommets: black matte or platinum matte		
48"W credenza		
• Grommet, left	+\$ 60	Specify with <i>grommet left</i> and select color number. Specify with <i>grommet right</i> and select color number.
• Grommet, right	+\$ 60	
72"W credenza		
• Grommet, left	+\$ 60	Specify with <i>grommet left center</i> and select color number. Specify with <i>grommet center</i> and select color number. Specify with <i>grommet right</i> and select color number.
• Grommet, center	+\$ 60	
• Grommet, right	+\$ 60	
96"W credenza		
• Grommet, left	+\$ 60	Specify with <i>grommet left</i> and select color number. Specify with <i>grommet left center</i> and select color number. Specify with <i>grommet right center</i> and select color number. Specify with <i>grommet right</i> and select color number.
• Grommet, left center	+\$ 60	
• Grommet, right center	+\$ 60	
• Grommet, right	+\$ 60	
Lock and Keying		
Lock		
• 2 doors	+\$ 226	Specify with <i>9211 Nickel locks</i> or with <i>9250 Ember Chrome locks</i> . Specify with <i>9211 Nickel locks</i> or with <i>9250 Ember Chrome locks</i> . Specify with <i>9211 Nickel locks</i> or with <i>9250 Ember Chrome locks</i> .
• 3 doors	+\$ 339	
• 4 doors	+\$ 452	
Keying		
• Factory- and field-installed keying units		► See <i>GSA Volume 5a Specification Guide</i> .

Tip: Multiple grommet locations can be specified on any given credenza. For a 48"W credenza, a maximum of two grommets can be specified. For a 72"W credenza, a maximum of three grommets can be specified. For a 96"W credenza, a maximum of four grommets can be specified.

Tip: Grommets can be specified on credenzas with and without accent tops.

► Specification Information, on next page

Exponents Credenzas 39"H *continued*

DESIGN COALESSE DESIGN GROUP

SIN 711.2

► Options, on previous page

Specification Information

Dimensions			Style Number	Case	Base Prices		
D	W	H			Door Fronts	Grade 1	Grade 2
					Painted MDF	Veneer	Veneer

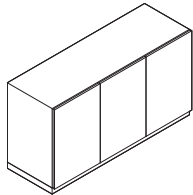

Credenzas with Doors

48"W

24 ³ / ₄ "	48"	39"	COCZUD254839	Painted MDF	\$5209	\$5448	\$5500
				Grade 1 Veneer	\$5806	\$6045	\$6097
				Grade 2 Veneer	\$5966	\$6205	\$6257

72"W

24 ³ / ₄ "	72"	39"	COCZUD257239	Painted MDF	\$6430	\$6717	\$6788
				Grade 1 Veneer	\$7145	\$7432	\$7503
				Grade 2 Veneer	\$7332	\$7619	\$7690

96"W

24 ³ / ₄ "	96"	39"	COCZUD259639	Painted MDF	\$7631	\$7989	\$8080
				Grade 1 Veneer	\$8467	\$8825	\$8916
				Grade 2 Veneer	\$8677	\$9035	\$9126

Specification Information

Dimensions			Style Number	Base Prices		
D	W	H		Painted MDF	Grade 1 Veneer	Grade 2 Veneer



Tip: Adjustable shelf is in addition to the adjustable shelves that are standard on the credenza.

Adjustable Shelf for 48"W Credenzas

22 ¹ / ₄ "	22 ⁷ / ₈ "	3/4"	COCZAS48	\$201	\$238	\$246
----------------------------------	----------------------------------	------	----------	-------	-------	-------

Adjustable Shelf for 72"W Credenzas, End Compartments

22 ¹ / ₄ "	22 ¹ / ₂ "	3/4"	COCZASEND72	\$201	\$238	\$246
----------------------------------	----------------------------------	------	-------------	-------	-------	-------

Adjustable Shelf for 72"W Credenzas, Middle Compartments

22 ¹ / ₄ "	24"	3/4"	COCZASMID72	\$201	\$238	\$246
----------------------------------	-----	------	-------------	-------	-------	-------

Adjustable Shelf for 96"W Credenzas, End Compartments

22 ¹ / ₄ "	22 ¹ / ₂ "	3/4"	COCZASEND96	\$201	\$238	\$246
----------------------------------	----------------------------------	------	-------------	-------	-------	-------

Adjustable Shelf for 96"W Credenzas, Middle Compartments

22 ¹ / ₄ "	23 ⁵ / ₈ "	3/4"	COCZASMID96	\$201	\$238	\$246
----------------------------------	----------------------------------	------	-------------	-------	-------	-------

Exponents Lectern

DESIGN COALESSE DESIGN GROUP

SIN 711.2

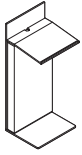

Standard Includes		Required to Specify
<ul style="list-style-type: none"> ▶ Need help? Product details, see <i>Coalesse Tables, Storage, and Accessories Specification Guide</i> 	<ul style="list-style-type: none"> • Case: painted MDF • Removable back panel for easy access to wire management: painted MDF • Metal base: paint • Accent ribbon: paint • Integrated 160° hinged cover for power and data or storage • Wire management entry and exit points at bottom • Glides: nylon non-marring • Ships assembled 	<ol style="list-style-type: none"> 1 Style number 2 Painted MDF color number for case: V145 Milk V197 Black 3 Painted MDF color number for back panel: V145 Milk V197 Black 4 Paint color number for base: 4135 Black Matte 4141 Platinum Matte 5 Paint color number for accent ribbon: 4135 Black Matte 4141 Platinum Matte 6 Options, if selected (see below) <p>▶ See <i>Surface Materials</i>, page 350.</p>

	Options	Price	Required to Specify
Surface Materials	Case and back panel		
	• Grade 1 wood veneer	Prices below	Specify with <i>Grade 1 wood veneer</i> and select color number.
	• Grade 2 wood veneer	Prices below	Specify with <i>Grade 2 wood veneer</i> and select color number.
	• Stain-to-Match	No cost	Specify with <i>Stain-to-Match</i> . ▶ Page 385
	Accent ribbon		
	• Grade 1 wood veneer	+\$ 59	Specify with <i>Grade 1 wood veneer</i> and select color number.
	• Grade 2 wood veneer	+\$ 62	Specify with <i>Grade 2 wood veneer</i> and select color number.
	• Stain-to-Match	No cost	Specify with <i>Stain-to-Match</i> . ▶ Page 385
Power and Data	• 2 power receptacles, 2 data, and 1 VGA with audio: black gloss only	+\$407	Specify with <i>PVD</i> .

Tip: When wood veneer is specified on the case and wood veneer is specified for the ribbon, it is recommended the ribbon finish match the wood veneer case selection.

Specification Information							
Dimensions			Style Number	Case	Base Prices		
D	W	H			Painted MDF	Grade 1 Veneer	Grade 2 Veneer
18 ³ / ₄ "	23 ¹ / ₂ "	48"	COCL42	Painted MDF	\$3210	\$3329	\$3362
				Grade 1 Veneer	\$3687	\$3806	\$3839
				Grade 2 Veneer	\$3807	\$3926	\$3959

Tip: The height of the lectern includes the back panel.

Exponents Mobile Whiteboard Display

DESIGN COALESSE DESIGN GROUP

SIN 711.2

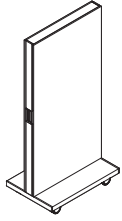

Tip: The e³ CeramicSteel markerboard surface is magnetic.

Tip: See CeramicSteel Care and Maintenance for additional information.

► Page 386

Standard Includes

- Need help? Product details, see *Coalesse Tables, Storage, and Accessories Specification Guide*
- One removable and one fixed whiteboard panel: 7655 e³ CeramicSteel markerboard surface with 4145 Milk Gloss painted aluminum trim
- Base, handle, and inner frame: paint
- Base bumper: plastic to complement paint on base
- Outer frame trim: painted MDF
- Two directional and two locking swivel 4" casters: 6009 Arctic White plastic for 4145 Milk Gloss paint selection or 6000 Black plastic for 4135 Black Matte paint selection
- Ships assembled

Required to Specify

- 1 Style number
- 2 Paint color number for base, handle, and inner frame:
 - 4135 Black Matte
 - 4145 Milk Gloss
- 3 Painted MDF color number for trim panels:
 - V145 Milk
 - V197 Black
- 4 Options, if selected (see below)
 - See *Surface Materials*, page 350.

Options

Options	Price	Required to Specify
Surface Materials		
Wood trim panels		
• Grade 1 wood veneer	+\$137	Specify with <i>Grade 1 wood veneer trim panels</i> and select color number.
• Grade 2 wood veneer	+\$145	Specify with <i>Grade 2 wood veneer trim panels</i> and select color number.
• Stain-to-Match	No cost	Specify with <i>Stain-to-Match</i> .
		► Page 385

Specification Information

Dimensions			Style	Base
D	W	H	Number	Price
24 ¹ / ₈ "	36"	75 ⁷ / ₈ "	COCWBN	\$3408
24 ¹ / ₈ "	48"	75 ⁷ / ₈ "	COCWBW	\$4136

Exponents Mobile Mediaboard Display

DESIGN COALESSE DESIGN GROUP

SIN 711.2

Tip: The e³ CeramicSteel markerboard surface is magnetic.

	Standard Includes	Required to Specify
<p>► Need help? Product details, see <i>Coalesse Tables, Storage, and Accessories Specification Guide</i></p>	<ul style="list-style-type: none"> • One removable back panel and one front fixed whiteboard panel: 7655 e³ CeramicSteel markerboard surface with 4145 Milk Gloss painted aluminum trim • Base, handle, and inner frame: paint • Base bumper: plastic to complement paint on base • Outer frame trim: painted MDF • Mediaboard well for power and display module: black • Power and display module: five white waterproof simplex power outlets, one VGA jack, and one audio jack with cable connection to monitor, faceplate is black gloss paint • Monitor mount bracket kit: black paint • Wire management grommet for plug: black plastic • Two directional and two locking swivel 4" casters: 6009 Arctic White plastic for 4145 Milk Gloss paint selection or 6000 Black plastic for 4135 Black Matte paint selection • Shelf: paint • Ships assembled except for monitor mount 	<ol style="list-style-type: none"> 1 Style number 2 Paint color number for base, handle, and inner frame: <ul style="list-style-type: none"> 4135 Black Matte 4145 Milk Gloss 3 Painted MDF color number for trim panels: <ul style="list-style-type: none"> V145 Milk V197 Black 4 Paint color number for shelf, if selected: <ul style="list-style-type: none"> 4135 Black Matte 4145 Milk Gloss 5 Options, if selected (see below) <ul style="list-style-type: none"> ► See <i>Surface Materials</i>, page 350.

Tip: See CeramicSteel Care and Maintenance for additional information.
► Page 386

	Options	Price	Required to Specify
Surface Materials	<p>Wood trim panels</p> <ul style="list-style-type: none"> • Grade 1 wood veneer • Grade 2 wood veneer • Stain-to-Match 	<p>+\$137</p> <p>+\$145</p> <p>No cost</p>	<p>Specify with <i>Grade 1 wood veneer trim panels</i> and select color number.</p> <p>Specify with <i>Grade 2 wood veneer trim panels</i> and select color number.</p> <p>Specify with <i>Stain-to-Match</i>.</p> <p>► Page 385</p>
Power and Data	<ul style="list-style-type: none"> • Five power outlets, one HDMI, and one blank 	No cost	Specify with <i>five power and HDMI</i> .

Specification Information

Dimensions			Style	Base
D	W	H	Number	Price

Mobile Mediaboard Display

24 ¹ / ₈ "	48"	75 ⁷ / ₈ "	COCMBW	\$5564
----------------------------------	-----	----------------------------------	--------	--------

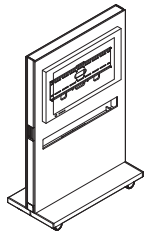

Shelf

9 ¹³ / ₁₆ "	15"	4 ³ / ₁₆ "	COCMBSHLF	\$ 222
-----------------------------------	-----	----------------------------------	-----------	--------

Exponents Mobile Mediaboard Display with Steelcase media:scape Technology

DESIGN COALESSE DESIGN GROUP

SIN 711.2

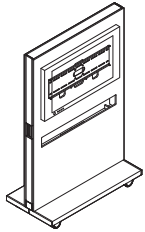

Tip: The e³ CeramicSteel marker-board surface is magnetic.

	Standard Includes	Required to Specify
<p>► Need help?</p> <p>Product details, see <i>Coalesse Tables, Storage, and Accessories Specification Guide</i></p>	<ul style="list-style-type: none"> One removable back panel and one front fixed whiteboard panel: 7655 e³ CeramicSteel markerboard surface with 4145 Milk Gloss painted aluminum trim Base, handle, and inner frame: paint Base bumper: plastic to complement paint on base Outer frame trim: painted MDF Mediaboard well for power module: black Wire management: five white waterproof simplex power outlets, faceplate is black gloss paint Integrated media:scape componentry, includes four PUCKs Monitor mount bracket kit: black paint Wire management grommet for plug: black plastic Two directional and two locking swivel 4" casters: 6009 Arctic White plastic for 4145 Milk Gloss paint selection or 6000 Black plastic for 4135 Black Matte paint selection Shelf: paint Ships assembled, except for monitor mount and media:scape components 	<ol style="list-style-type: none"> Style number Paint color number for base, handle, and inner frame: <ul style="list-style-type: none"> 4135 Black Matte 4145 Milk Gloss Painted MDF color number for trim panels: <ul style="list-style-type: none"> V145 Milk V197 Black Paint color number for shelf, if selected: <ul style="list-style-type: none"> 4135 Black Matte 4145 Milk Gloss Maintenance agreement (see below under Required Selections) PUCKs (see below under Required Selections) Options, if selected (see below) <p>► See <i>Surface Materials</i>, page 350.</p>

Tip: See *CeramicSteel Care and Maintenance* for additional information.
► Page 386

	Required Selections	Price	Required to Specify
Maintenance Agreement	<ul style="list-style-type: none"> One year Two years Three years Four years 	<ul style="list-style-type: none"> +\$ 700 +\$1260 +\$1785 +\$1960 	<p>Specify with <i>one year maintenance agreement</i>.</p> <p>Specify with <i>two year maintenance agreement</i>.</p> <p>Specify with <i>three year maintenance agreement</i>.</p> <p>Specify with <i>four year maintenance agreement</i>.</p>

PUCKs	All PUCKs same type	Price	Required to Specify
	<ul style="list-style-type: none"> VGA HDMI DisplayPort Mini DisplayPort 	<ul style="list-style-type: none"> No cost No cost No cost No cost 	<p>Specify with <i>VGA PUCKs</i>.</p> <p>Specify with <i>HDMI PUCKs</i>.</p> <p>Specify with <i>DisplayPort PUCKs</i>.</p> <p>Specify with <i>Mini DisplayPort PUCKs</i>.</p>
	Mixed PUCK types		
	<ul style="list-style-type: none"> PUCK 1 <ul style="list-style-type: none"> - VGA - HDMI - DisplayPort - Mini DisplayPort PUCK 2 <ul style="list-style-type: none"> - VGA - HDMI - DisplayPort - Mini DisplayPort PUCK 3 <ul style="list-style-type: none"> - VGA - HDMI - DisplayPort - Mini DisplayPort PUCK 4 <ul style="list-style-type: none"> - VGA - HDMI - DisplayPort 	<ul style="list-style-type: none"> No cost No cost No cost No cost No cost No cost No cost No cost No cost No cost No cost No cost No cost 	<p>Specify with <i>VGA PUCK</i>.</p> <p>Specify with <i>HDMI PUCK</i>.</p> <p>Specify with <i>DisplayPort PUCK</i>.</p> <p>Specify with <i>Mini DisplayPort PUCK</i>.</p> <p>Specify with <i>VGA PUCK</i>.</p> <p>Specify with <i>HDMI PUCK</i>.</p> <p>Specify with <i>DisplayPort PUCK</i>.</p> <p>Specify with <i>Mini DisplayPort PUCK</i>.</p> <p>Specify with <i>VGA PUCK</i>.</p> <p>Specify with <i>HDMI PUCK</i>.</p> <p>Specify with <i>DisplayPort PUCK</i>.</p>

	Options	Price	Required to Specify
Surface Materials	Wood Trim Panels		
	<ul style="list-style-type: none"> Grade 1 wood veneer Grade 2 wood veneer Stain-to-Match 	<ul style="list-style-type: none"> +\$ 137 +\$ 145 No cost 	<p>Specify with <i>Grade 1 wood veneer trim panels</i> and select color number.</p> <p>Specify with <i>Grade 2 wood veneer trim panels</i> and select color number.</p> <p>Specify with <i>Stain-to-Match</i>.</p> <p>► Page 385</p>

Exponents Mobile Mediaboard Display with Steelcase media:scape Technology

DESIGN COALESSE DESIGN GROUP

SIN 711.2

Specification Information

Dimensions			Style	Base
D	W	H	Number	Price

Mobile Mediaboard Display with Steelcase media:scape Technology

24 ¹ / ₈ "	48"	75 ⁷ / ₈ "	COC1MBWMS	\$16,537
----------------------------------	-----	----------------------------------	-----------	----------

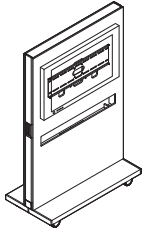

Shelf

9 ¹³ / ₁₆ "	15"	4 ³ / ₁₆ "	COCMBSHLF	\$ 222
-----------------------------------	-----	----------------------------------	-----------	--------

Surface Materials

► For more detailed Coalesse surface material information, see the *Coalesse Surface Materials Reference Guide* or consult your Steelcase dealer.

Surface Materials-Upholstery	350
Customer's Own Material	352
Flammability Information	354
Upholstery Matrix	355
Surface Materials-Leather/Faux	358
Cut Yardage Net Price List	360
Leather and Faux Leather Matrix	361
Surface Materials-Wood	362
Hardwood Matrix	364
Veneer Matrix	365
Surface Materials-Laminate	366
High-Pressure Laminate Matrix	368
Laminate Edge Band Matrix	372
Surface Materials-Glass	374
Glass Matrix	375
Surface Materials-Metal/Paint	376
Metal/Paint Matrix	378
Emu Advanced Collection Paint Matrix	382
Surface Materials-Miscellaneous	383
Ordering	384
Care and Maintenance	386

Surface Materials - Upholstery

Upholstery

All Coalesse textiles are priced by grades. Some Coalesse fabrics can be treated for flame retardancy, contact Customer Service. All Coalesse products are handcrafted making each unique. Certain fabrics and leathers will appear loose and may differ from like products due to comfort wrinkles when upholstered.

A contrasting welt is available on some products. Consult Customer Service for yardage or square feet requirements and prices. All stripes will be applied vertically unless customer specifies otherwise. Loose cushions on Coalesse products are not fully upholstered (not reversible).

Designtex, Maharam, Steelcase, and select Luna fabrics are graded in our pricing. Simply order Coalesse products with Designtex, Maharam, Steelcase, and select Luna specified. Designtex, Maharam, Steelcase, and select Luna fabrics are graded in on Coalesse products; however, Coalesse does not stock fabrics and can only respond based on Designtex, Maharam, Steelcase, and select Luna fabrics lead times. For current grades, refer to Coalesse website: www.Coalesse.com.

Special Fabric Applications

Backing

- Backing information is found on each product page. Select this option when ordering your product to have backing applied. Price varies by product according to yardage it requires.

Tip: Prices subject to change without notice and an additional 2 week lead time will apply for 54" wide fabrics. Wider fabrics will require 4 week additional lead time. Check fabric database to determine if backing is required at www.Coalesse.com.

Seating Upholstery

Coalesse fabrics are priced by grades from 6 through 14 and leathers C and E. Fabrics and leathers may be purchased separately as cut yardage, see page 360. All products are handcrafted, making each unique. Certain fabrics and leathers will appear loose and may differ from like products due to wrinkles when upholstered. A contrasting welt is available on some products. Consult Customer Service for yardage or square feet requirements for pricing.

All stripes will be applied vertically unless customer specifies otherwise. Loose cushions on Coalesse products are not fully upholstered (not reversible). Any graded-in or COM textile should be reviewed with supplier to verify availability. In some cases a textile supplier may require minimums that exceed your furniture order requirements. In these situations, you will be contacted with an option to select a different textile or continue with your original textile selection as a COM-DTP. If you choose to continue with your textile selection as COM-DTP to allow you to order the minimum required, please ship only the textile needed to Coalesse for your furniture order.

Emu Upholstery

Applies to: Emu Advanced Collection Outdura Collection

Fabric Grade 6

5G30	Natural White
5G31	Kona
5G32	Sandstone
5G33	Cadet Grey
5G34	Stone
5G35	China Red
5G36	Cardinal Red
5G37	Solid Aquamarine
5G38	Canary
5G39	Pesto
5G41	Island Blue

SW_1 Knit

Applies to: SW_1 Collection

5KG0	Stone
5KG1	Grey
5KG2	Brown
5KG3	Black
5KG4	Ivory
5KG5	Coal
5KG6	Garnet
5KG7	Golden
5KG8	Royal

Lagunitas Knit

Applies to: Lagunitas focus nook and lounge system

Grade 1

5K50	Stone
5K51	Grey
5K54	Black
5K58	Ivory
5K59	Coal

Grade 2

5K52	Cement
5K53	Brown
5K55	Garnet
5K56	Golden
5K57	Royal
5K60	Glacier
5K61	Cadet
5K62	Grass
5K63	Forest
5K64	Amber
5K65	Terracotta
5K66	Crimson
5K67	Berry
5K68	Violet
5K69	Khaki

Hexa Upholstery

Applies to: Hosu

Fabric Grade 10

CL50	Dark Grey
CL51	Light Grey
CL52	Blue
CL53	Green
CL54	Red
CL55	Yellow

Fusion Upholstery

Applies to: Hosu lounge and Lagunitas personal table

Fabric Grade 11

CL60	Caviar
CL61	Portobello
CL62	Graphite
CL63	Java
CL64	Steam*

* Not available on Hosu

Surface Materials - Steelcase Upholstery

Steelcase Upholstery

Coalesse offers a select palette of Steelcase fabrics as standard. This provides the convenience of an integrated finish offering and ease of specification. See the Steelcase Standard Fabric Matrix for availability by product line. For a visual reference, please refer to the Steelcase Finish Library.

Grade 6

Cogent: Connect

- 5S15 Coconut
- 5S16 Turmeric/Honey
- 5S17 Tangerine
- 5S18 Scarlet
- 5S19 Concord
- 5S20 Maya Blue
- 5S21 Blue Jay
- 5S23 Wasabi
- 5S24 Nickel
- 5S25 Graphite
- 5S26 Licorice
- 5S27 Malt
- 5S28 Root Beer
- 5S93 Blueprint
- 5S94 Lizard/Jungle
- 5S95 Sailor
- 5S96 Quicksilver
- 5S98 Canary
- 5S99 Lipstick/Merlot
- 5SD0 Royal Blue

Jacks

- 5B61 Taupe
- 5B62 Camel
- 5B64 Pewter
- 5B70 Midnight

Seating Vinyl

- 5801 Topaz
- 5805 Foggy Night
- 5809 Black
- 5810 Forest
- 5812 Navy
- 5813 Currant
- 5814 Leaf
- 5815 Seaside
- 5817 Pebble
- 5818 Spice
- 5819 Thistle
- 5820 Coffee
- 5822 Iris

Spyder

- 5B01 Foggy Night
- 5B04 Peri

Nitelights

- 5F58 Hazelnut
- 5F61 Earth
- 5F62 Shore
- 5F63 Moss
- 5F65 Regal Blue
- 5F66 Stone
- 5F67 Moon

Link

- 5A20 Burgundy
- 5A23 Green
- 5A24 Blue
- 5A25 Navy
- 5A26 Purple
- 5A27 Black
- 5A28 Ocean
- 5A30 Chamois

Grade 7

Stand In

- 5621 Sleet
- 5622 Lunar
- 5623 Cyclone
- 5624 Eclipse
- 5625 Powder
- 5626 Chardonnay
- 5627 Graham
- 5628 Sediment
- 5629 Allspice
- 5630 Apple
- 5631 Lava
- 5632 Cayenne
- 5633 Plantain
- 5634 Parsley
- 5635 Scallion
- 5636 Atlantis
- 5691 Orca
- 5740 Burlap
- 5741 Porter
- 5742 Tusk
- 5743 Putty
- 5744 Blueberry
- 5745 Charteuse
- 5746 Mango
- 5747 Sedona
- 5748 Juniper
- 5749 Peanut

Cogent: Trails

- 5S29 Bronzite
- 5S85 Agate
- 5S86 Lapis
- 5S87 Malachite
- 5S88 Quartz
- 5S90 Tiger Eye
- 5S91 Travertine
- 5S92 Topaz

New Black

- 5J08 Jack
- 5J09 James
- 5J12 Harley

Imperma

- TM01 Toffee
- TM02 Pigeon
- TM03 Fossil
- TM04 Poppyseed
- TM05 Auburn
- TM06 Cumin
- TM07 Marble
- TM08 Cliff
- TM09 Tarragon
- TM10 Pesto
- TM11 Wave
- TM12 Niagara
- TM13 Tuscan
- TM14 Peppercorn

Grade 8

Billiard Multi-Use by Designtex

- 5H10 Bone
- 5H11 Poppy
- 5H12 Tangelo
- 5H13 Citron
- 5H14 Avocado
- 5H15 Hunter
- 5H16 Indigo
- 5H17 Mallard
- 5H18 Teak
- 5H19 Cumulus
- 5H20 Pewter
- 5H21 Gunmetal
- 5H22 Ink

Texel

- TM20 Angora
- TM21 Grist
- TM22 Galaxy
- TM23 Terracotta
- TM24 Nude
- TM25 Field
- TM26 Haze

Grade 9

Remix

- RE01 Rust
- RE02 Pumpkin
- RE03 Pebble
- RE04 Dark Chocolate
- RE05 Beige
- RE06 Linen Beige
- RE07 Hazelnut
- RE08 Concrete
- RE09 Sky Blue
- RE10 Blue Jean
- RE11 Ivy Green
- RE12 Primavera Yellow
- RE13 Night Blue

Bo Peep

- 5G66 Pita
- 5G67 Bone
- 5G68 Safari
- 5G69 Brown Sugar
- 5G70 Chocolate
- 5G71 Candlelight
- 5G72 Honey Mustard
- 5G73 Marmalade
- 5G74 Picnic
- 5G75 Pinot
- 5G76 Bloom
- 5G77 Grapevine
- 5G78 Firefly
- 5G79 Artichoke
- 5G80 Serpent
- 5G81 Carolina
- 5G82 Blue Bonnet
- 5G83 Nautical
- 5G84 Gravel
- 5G85 Sharkskin
- 5G86 Kohl

Customer's Own Material

CUSTOMER'S OWN MATERIAL

Coalesse is pleased to cooperate with COM/COL selections. Prior to order placement for exact yardage requirements, a sample cutting of actual COM/COL must be submitted to Coalesse for approval only if fabric approval is not found in Coalesse fabric database. Identify the name and number of units on which the fabric/leather is to be applied. If COM has a repeat the sample should be large enough to show the entire repeat. Coalesse will not accept nor use any painted leathers. A painted leather is described as any suede or leather which is not aniline dyed with the same color throughout the thickness of the hide.

Even after preliminary approval, Coalesse reserves the right to reject COM/COL if necessary when the quality is not satisfactory for the item it is intended to be used on. Once COM/COL is accepted Coalesse assumes no responsibility for its overall appearance, flammability, normal durability, colorfastness, or any other quality, after upholstered on a Coalesse product.

COALESSE STANDARD TO BUY PROGRAM

The Customer's Own Material (COM) Program offers the opportunity for customers to select fabrics that are not offered through the standard Coalesse surface materials program for use on our products. Through the COM program, Coalesse will test your materials for application on Coalesse products. Once approved, you can place your order. Coalesse will facilitate the entire ordering process and give you a production schedule. Coalesse will order the COM fabric directly from the textile manufacturer. For up-to-date information regarding fabric test results for all COM fabrics and details regarding yardage requirements for most Seating lines, visit the fabric database at www.coalesse.com.

CUSTOMERS TO BUY SCHEDULING POLICY/COM/COL POLICY

COM/COL must be received at manufacturing location no later than 20 working days prior to the order scheduled delivery date. If COM/COL is not received in this time frame, scheduling will move the order's delivery date out to the best available ship date. Customer Service will notify the dealer via e-mail of the order's new scheduled delivery date. Project size order shipment may be affected due to size of order. If the COM/COL is received and the COM/COL requires backing, scheduling will move order out to best available ship date. Backing charges will apply. If COM/COL is received defective or short yardage/sq. ft., the replacement COM/COL order must be received within 3 days to maintain scheduled delivery date on order. It is the responsibility of the dealer to advise Coalesse on what to do with defective materials. In addition, customers may request Coalesse to order for COM/COL materials.

SQUARE FOOTAGE/ YARDAGE REQUIREMENTS

COM and COL price includes application of Customer's Own Material or Leather to frames. All COM and COL should be shipped freight prepaid to designated manufacturing location. Labels will be provided by your Customer Service representative to ensure clear textile identification.

Please have customers send COM/COL and add TAG: COM/ COL.

COM and COL must be identified as follows to prevent order delays:

1. Name and address (Should match purchase order)
2. Your furniture purchase order number/sales order
3. Style number to which fabric is to be applied
4. Supplier name and fabric name, number, and color

COL hides must be rolled for shipment to manufacturing location in a neat manner, avoiding creases and excessive roll marks. All leathers will be rejected if sent in a folded manner.

To determine COL square footage, see COL requirements for each product. Square footage requirements are based on an average hide size of 45-50 square feet of clean, usable leather. If the COL has a smaller average hide size, please consult Customer Service for quotation. Please note, leather is a natural product and all square footage requirements are estimations. The shape of the COL hides supplied and the usable, clean square footage may make it necessary for us to request more leather after COL is received.

Yardage requirements shown are based on 54" width plain material. If fabric design requires vertical/top out, Customer Service should be consulted for additional yards required. If fabric is under 54", refer to fabric database at www.coalesse.com.

EXCESS COM/COL POLICY

All excess COM/COL will be disposed of after order is completed unless prior arrangements have been made with Coalesse Customer Service. Fedex account number and address to ship to must be referenced. Excess WILL NOT be returned with shipment of furniture.

Customer's Own Material

Cutting Direction Guidelines

Cutting direction is based on the fabric width and the way the fabric is cut from the roll and applied to Coalesse products. There are two cutting directions: railroaded or horizontal.

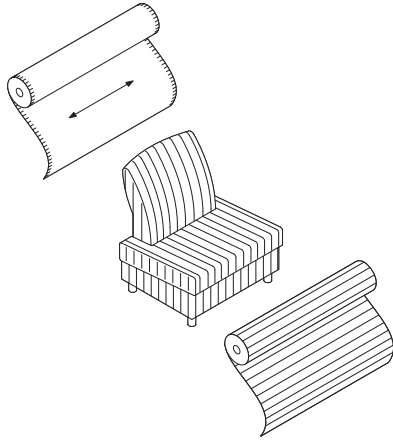

Horizontal or railroaded (across roll, warp horizontal) means fabric is cut across the roll; selvages are on the top and bottom.

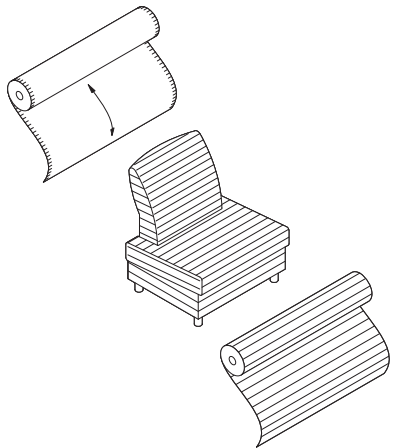

Vertical or top out (down roll, warp vertical) means fabric is cut in the same direction it is woven; selvages are on the left and right sides.

Flammability Information

California Technical Bulletin 133

Definition: California Technical Bulletin 133 (CAL 133) is a flammability test procedure for seating furniture specified in public occupancies. Specifications, test procedures and requirements pertaining to flammability regulations are changing rapidly. Coalesse will make every effort to keep our information and services pertaining to flammability specifications up-to-date.

Coalesse reserves the right to make deletions and additions and cannot guarantee fabric manufacturer materials nor its specifications will not change. A new evaluation will be necessary if materials are altered by manufacturer. This approval information on our website is subject to change without notice. Coalesse is not responsible for textile manufacturer's changes. Contact fabric manufacturer for availability.

For fabrics not pre-approved, please submit the fabric supplier name, fabric name, style number, content, weight, Coalesse product number, and fabric name to be applied to Customer Service at 1.800.627.6770 or fax to 888.413.5161. Our Customer Service representative will contact you within 48 hours of your request with information on the fabric's CAL 133 compliance. Actual fabric sample may be required. **If not approved, a burn test may be required at a fee. Contact Customer Service for a quote.**

UFAC – All upholstered seating is constructed to conform to UFAC (Upholstered Furniture Action Council) specifications. This is comparable to NFPA 260. All Coalesse fabrics and leathers meet UFAC specifications and NFPA 260 requirements.

California Bureau of Home Furnishings Technical Bulletin 117

All Coalesse upholstered seating, fabrics, and leathers meet California Technical Bulletin 117. All products manufactured after May 1, 1993 have CAL 117 label attached.

California Bureau of Home Furnishings Technical Bulletin 133

On March 1, 1992 Technical Bulletin 133 (TB 133), a fire test for seating furniture in public buildings, became law in California. On and after March 1, 1992 all seating furniture sold in California for use in the public buildings specified in the regulations, must be in compliance with the requirements of TB 133, and each product must be labeled stating that the furniture meets TB 133. If a building is fully sprinklered, compliance with TB 133 becomes discretionary, however, even in sprinklered buildings all furniture must meet the minimum fire standards of the bureau's Technical Bulletin 117.

California Technical Bulletin 133 requires special construction procedures and is based on fabric and product design. For applicable CAL 133 upcharge, refer to up-charge, refer to individual product pages in the specification guide or the fabric database at www.coalesse.com.

Pre-Approved Fabrics – www.coalesse.com If a model or fabric is not listed, consult Customer Service for details at 800.627.6770.

***Note** – California Technical Bulletin 133 is a unit test and requires specific product testing of unit for certification. If certification is required the test of a unit constructed exactly as the unit(s) to be specified in the installation, the cost of the test unit plus the cost of testing (\$500 net per test) must be added to obtain certification. Coalesse is not responsible for any charges for COM/COL purchased prior to evaluation if unit fails. Textile and unit cannot be returned.

Please consult Customer Service at 1.800.627.6770 or Fax 888.413.5161 for suggested fabrics/leathers, upcharges and minimums required for meeting California Technical Bulletin 133.

General Information

-Specifications, test procedures and requirements pertaining to flammability regulations are changing rapidly. Coalesse will make every effort to keep our information and services pertaining to flame specifications up-to-date. However, we do reserve the right to alter the products, fabrics/leathers or upcharges associated with any of the above or any other flame specifications.

When COM or COL is specified for use on Coalesse seating that is to meet the New York Port Authority Code, the COM or COL must be treated to meet this code prior to receipt by Coalesse. Coalesse is not responsible for the flammability treatment or certification of any COM or COL. All upcharges indicated are to be added to list prices. ▶ See specific product pages for CAL 133 approval, option, and pricing.

Upholstery Matrix

Note: Coalesse reserves the right to reject fabrics when necessary if the quality or construction is not satisfactory for intended use. For most up to date information on fabric usage, please check the fabric database on www.coalesse.com.

Legend

- = Not available
- = Available
- = Available but requires backer
- ⊙ = Available but requires contrasting fabric
- = Available but requires backer and contrasting fabric
- ▶ See specification pages for details.

	Chance Grade 12	Connoisseur 3 Grade 13	Conservation Grade 10	Divina Melange Grade 14/2CH	Frolic Grade 14	Hallingdal Grade 14/2CH	Link Grade 6	Pigment Grade 13	React Grade 10	Remix Grade 12	Restore Grade 10	Rocket Grade 9	Salon Grade 9	Samba Grade 12	Sequence Grade 12	Souvenir Grade 10	Square Grade 12	Steady Grade 11	Steelcut Grade 13	Sustain Grade 10	Swayed All Over Grade COM	Tempera Grade 14	Whimsy Grade 11
Bindu	■	□	•	□	■	□	■	□	•	■	•	□	•	■	•	•	•	•	■	■	■	□	•
Bix	■	□	⊙	□	■	□	■	□	□	■	□	□	□	■	■	•	⊙	•	■	■	■	□	⊙
Chord	■	□	■	□	■	□	■	□	■	■	■	□	□	■	■	•	■	•	■	■	■	□	■
Circa	■	□	•	□	■	□	■	□	•	■	•	□	•	■	•	•	•	•	■	■	■	□	•
Coupe	■	□	■	□	■	□	■	□	■	■	■	□	□	■	■	■	■	•	■	■	■	□	■
Enea	■	□	■	□	■	□	■	□	■	■	■	□	□	■	■	■	■	•	■	■	■	□	■
Kathryn	■	□	■	□	■	□	■	□	■	■	■	□	□	■	■	■	■	•	■	■	■	□	■
Ripple	■	□	•	□	■	□	■	□	•	■	•	□	•	■	•	•	•	•	■	■	■	□	•
Swathmore	■	□	■	□	■	□	■	□	■	■	■	□	□	■	■	■	■	•	■	■	■	□	■
Swathmore Grande	■	□	■	□	■	□	■	□	■	■	■	□	□	■	■	■	■	•	■	■	■	□	■

Disclaimer: Coalesse is pleased to provide this information. However, even after preliminary approval, Coalesse reserves the right to reject fabrics/leathers when necessary if the quality or construction is not satisfactory for the item it is intended for use on. Coalesse reserves the right to evaluate data daily and make any necessary changes or improvements to the information provided. Textile recommendations do not imply a warranty for the textiles. The textile manufacturer provides all warranties for textiles. All trademarks and trade names are the property of the different manufacturers. All pricing quotes for product should be obtained from your local Sales Representative or a Coalesse Customer Service Representative. Recommendations such as latex backing, Gore SP and CAL 133 will require additional cost and may require additional lead-time. All specifications are subject to change without notice.

Steelcase Upholstery Matrix

Note: Coalesse reserves the right to reject fabrics when necessary if the quality or construction is not satisfactory for intended use. For most up to date information on fabric usage please check the fabric database on www.coalesse.com.

Legend

- = Not available
- = Available
- ▶ See specification pages in the *Coalesse Specification Guides* for details.

	Steelcase Fabrics													
	Cogent: Connect Grade 06	Jacks Grade 06	Seating Vinyl Grade 06	Spyder Grade 06	Nitelights Grade 06	Link Grade 06	Stand In Grade 07	Cogent: Trails Grade 07	New Black Grade 07	Imperma Grade 07	Billiard Multi-Use by Designtex Grade 08	Texel Grade 08	Remix Grade 09	Bo Peep Grade 10
Await	•	■	■	■	■	■	■	■	■	■	■	■	■	■
Bindu	■	■	■	■	■	■	■	■	■	■	■	■	■	■
Bix Cushions	■	■	■	■	■	■	■	■	■	■	■	■	■	■
Bix Screen	■	■	•	■	•	■	■	■	■	■	■	■	■	■
Bob	■	■	■	■	■	■	■	■	■	■	■	■	■	■
Capa	■	■	■	■	■	■	■	■	■	■	■	■	■	■
Chord	■	■	■	■	■	■	■	■	■	■	■	■	■	■
Circa	•	■	■	■	■	■	■	■	■	■	■	■	■	■
Coupe	■	■	■	■	■	■	■	■	■	■	■	■	■	■
Davos	■	■	■	■	■	■	■	■	■	■	■	■	■	■
Elbow Chair CH20	•	•	•	•	•	•	•	•	•	•	•	•	•	•
Emu Outdoor Cushion	•	•	•	•	•	•	•	•	•	•	•	•	•	•
Emu Indoor Cushion	■	■	■	■	■	■	■	■	■	■	■	■	■	■
Emu Terramare	•	•	•	•	•	•	•	•	•	•	•	•	•	•
Enea	■	■	■	■	■	■	■	■	■	■	■	■	■	■
Enea Lottus	■	■	■	■	■	■	■	■	■	■	■	■	■	■
Exponents, Benches	■	■	■	■	■	■	■	■	■	■	■	■	■	■
Hosu	■	■	■	■	■	■	■	■	■	■	■	■	■	■
Joel	■	■	■	■	■	■	■	■	■	■	■	■	■	■
Kathryn	■	■	■	■	■	■	■	■	■	■	■	■	■	■
Last Minute	■	■	■	■	■	■	■	■	■	■	■	■	■	■
Lounge Seating CH100 Series	•	•	•	•	•	•	•	•	•	•	•	•	•	•
Millbrae Contract	■	■	■	■	■	■	■	■	■	■	■	■	■	■
Millbrae Lifestyle	•	■	■	■	■	■	■	■	■	■	•	■	•	■

▶ Continued on next page

The above Steelcase fabrics are available as standard without a backer on select Coalesse product lines. For those product lines that are noted as unavailable, it may be specifiable with a backer as a Graded-In fabric. Additional Steelcase fabrics are available through the Graded-In program. Please consult the Coalesse Fabric Database for availability. Disclaimer: Coalesse is pleased to provide this information. However, even after preliminary approval, Coalesse reserves the right to reject fabrics/leathers when necessary if the quality or construction is not satisfactory for the item it is intended for use on. Coalesse reserves the right to evaluate data daily and make any necessary changes or improvements to the information provided. Textile recommendations do not imply a warranty for the textiles. The textile manufacturer provides all warranties for textiles. All trademarks and trade names are the property of the different manufacturers. All pricing quotes for product should be obtained from your local Sales Representative or a Coalesse Customer Service Representative. Recommendations such as backing and CAL 133 will require additional cost and may require additional lead-time. All specifications are subject to change without notice.

Steelcase Upholstery Matrix

Note: Coalesse reserves the right to reject fabrics when necessary if the quality or construction is not satisfactory for intended use. For most up to date information on fabric usage please check the fabric database on www.coalesse.com.

► Continued, from previous page

Legend

- = Not available
- = Available
- See specification pages in the *Coalesse Specification Guides* for details.

	Steelcase Fabrics													
	Cogent: Connect Grade 06	Jacks Grade 06	Seating Vinyl Grade 06	Spyder Grade 06	Nitelights Grade 06	Link Grade 06	Stand In Grade 07	Cogent: Trails Grade 07	New Black Grade 07	Imperma Grade 07	Billiard Multi-Use by DesignTex Grade 08	Texel Grade 08	Remix Grade 09	Bo Peep Grade 10
Lagunitas Cushion	■	■	■	■	■	■	■	■	■	■	■	■	■	■
Lox	•	■	■	■	■	■	■	■	■	■	•	■	•	■
Montara650	■	■	■	■	■	■	■	■	■	■	■	■	■	■
Passerelle	■	■	■	■	■	■	■	■	■	■	■	■	■	■
Ripple	•	■	■	■	■	■	■	■	■	■	■	■	■	■
Sidewalk	■	■	■	■	■	■	■	■	■	■	■	■	■	■
SW_1	■	■	■	■	■	■	•	•	■	■	■	■	■	■
Swathmore	■	■	■	■	■	■	■	■	■	■	■	■	■	■
Swathmore Grande	■	■	■	■	■	■	■	■	■	■	■	■	■	■
Switch	■	■	■	■	■	■	■	■	■	■	■	■	■	■
Together	■	■	■	■	■	■	■	■	■	■	■	■	■	■
Topo Lounge	■	■	■	■	■	■	■	■	■	■	■	■	■	■
Topo Mobile Lounge	■	■	■	■	■	■	■	■	■	■	■	■	■	■
Visalia	■	■	■	■	■	■	■	■	■	■	■	■	■	■
Wrapp	•	■	■	■	■	■	■	■	■	■	•	■	•	■

The above Steelcase fabrics are available as standard without a backer on select Coalesse product lines. For those product lines that are noted as unavailable, it may be specifiable with a backer as a Graded-In fabric. Additional Steelcase fabrics are available through the Graded-In program. Please consult the Coalesse Fabric Database for availability. Disclaimer: Coalesse is pleased to provide this information. However, even after preliminary approval, Coalesse reserves the right to reject fabrics/leathers when necessary if the quality or construction is not satisfactory for the item it is intended for use on. Coalesse reserves the right to evaluate data daily and make any necessary changes or improvements to the information provided. Textile recommendations do not imply a warranty for the textiles. The textile manufacturer provides all warranties for textiles. All trademarks and trade names are the property of the different manufacturers. All pricing quotes for product should be obtained from your local Sales Representative or a Coalesse Customer Service Representative. Recommendations such as backing and CAL 133 will require additional cost and may require additional lead-time. All specifications are subject to change without notice.

Surface Materials - Leather/Faux

Leather

ELMOSOFT, ELMORUSTICAL LEATHER CARE

Only the finest hides are used for Elmo leather. Expect some color variations from hide to hide due to the aniline state of the product. Color fading may occur if leather is exposed to direct or intense light. Care is required to allow this product to achieve the rich natural patina that beautiful natural leather develops. The hallmarks of this leather include some naturally occurring markings, such as healed scars, insect bites, stretch marks, and fat wrinkles. Elmorustical's leather treatment is very natural with little protection from spills or body oils. This rich leather will exhibit stains and oils through normal use. Coalesse is not responsible for discoloration, spotting, or staining on this leather.

Special Color Match Leather

Coalesse can provide a special color match in its leather to any supplier's leather color, paint color, carpet color, wall-paper color, etc. Sample to match must be submitted to Coalesse with purchase order. Sample for approval can be supplied if requested.

Note: Minimum order 2,500 sq. ft.

Special Fabric Applications

Backing

- Backing information is found on each product page. Select this option when ordering your product to have backing applied. Price varies by product according to yardage it requires.

Tip: Prices subject to change without notice and an additional 2 week lead time will apply for 54" wide fabrics. Wider fabrics will require 4 week additional lead time.

Elmo Leather

Coalesse uses leathers that are provided by Elmo of Sweden. Elmosoft is a full grain, aniline dyed, semi-aniline finish. With Elmosoft leather, now recyclable and chromium-free, you have the opportunity to bid on green projects when requested. Elmosoft leathers are never corrected, buffed, or altered in any way. Coalesse purchases only original full grain leathers. The quality of this genuine leather can be felt in the hand immediately. Other leathers are often stiff because of the amount of pigment needed to cover the imperfections of an inferior hide. Using leather of low quality affects the overall quality of the furniture it is upholstered on. You can feel confident in leather purchased from Coalesse.

Elmosoft

Grade C

Elmosoft

- L110 Maritime Blue
- L111 Midnight Blue
- L112 Ebony
- L113 Gunmetal
- L114 Mica
- L115 Dove Grey
- L116 Plum Pleasure
- L122 Truffle
- L128 Red Birch
- L132 Violet
- L133 Espresso
- L134 Ruby
- L135 Scarlet
- L138 Bourbon
- L139 Cinder
- L140 Garnet
- L143 Pecan
- L144 Chamois
- L146 Russet
- L147 Saddle
- L151 White
- L709 Sugar
- L711 Parchment
- L712 Buff
- L716 Khaki
- L717 Cameo
- L721 Rock
- L722 Desert
- L723 Storm
- L725 Teal
- L727 Egyptian Blue
- L728 Bright Blue
- L730 Hunter
- L736 Lemon
- L737 Sunshine
- L738 Drama
- L740 Dazzle
- L743 Forest Green
- L744 Turtle
- L745 Grass
- L746 Envy
- L747 Cigar
- L748 Light Chocolate
- L749 Beaver
- L750 Bluffstone
- L751 Sienna
- L752 Oxblood
- L753 Dough
- L754 Acorn
- L755 Peanut Butter
- L756 Quinoa
- L757 Dark Sand
- L758 Mustard
- L759 Amber Orange
- L760 Bengal
- L761 Periwinkle
- L762 Canvas
- L763 Macadamia
- L764 True Blue
- L765 Storm Blue
- L766 Powder Blue
- L767 Blush
- L768 Tropical
- L769 Mauve
- L770 Cadet
- L771 Powder Mint
- L772 Timberwolf
- L773 Chalice
- L774 Oil
- L775 Coyote

Elmorustical Leather and Elmotique

Elmorustical and Elmotique is a full top grain, aniline dyed leather.

Elmorustical has a grain which varies in structure and offers outstanding comfort. It is an aniline leather with all the distinct features of the natural hide.

Elmotique is a thinner aniline leather with a batique-effect and displays all the features possessed by the original hide.

Only the finest hides are used for Elmorustical and Elmotique leathers. Expect some color variations from hide to hide due to the aniline state of the product. Color fading may occur if leather is exposed to direct or intense light. Care is required to allow this product to achieve the rich natural patina that beautiful leather develops. The hallmarks of this leather include some naturally occurring markings such as healed scars, insect bites, stretch marks, and fat wrinkles. Elmorustical and Elmotique's leather treatment is very natural with little protection from spills or body oils. This rich leather will exhibit stains and oils through normal use. Coalesse is not responsible for discoloration, spotting, or staining on this leather.

Grade E

Elmorustical

- L318 Loam
- L319 Ebony
- L321 Beige
- L323 Buff
- L325 Camel
- L326 Charbrown
- L330 Flame
- L332 Honey
- L334 Mist Green
- L337 Russet
- L338 Rust
- L363 Tendril
- L364 Fog
- L365 Sunflower
- L366 Terra Cotta
- L367 Cadet
- L368 Marine
- L369 Mallard
- L370 Smoke
- L371 Merlot
- LD54 Twilight

Elmotique

- L310 Sage Brush
- L311 Flaxen
- L312 Earth
- L313 Clay
- L314 Blue Mountain
- L315 Juniper

Faux Leather

Coalesse offers a variety of faux leathers. Not all faux leathers are available on all products, check seating matrix to determine availability. **►Page 361**

Grade 10

Brisa
(For a visual palette, please refer to the Steelcase Finish Library)

- BR01 Black Onyx
- BR04 Truffle
- BR06 Ash
- BR07 Sage
- BR08 Celery
- BR09 Sterling Blue
- BR10 Night Navy
- BR11 Cambridge Blue
- BR12 Abyss
- BR13 Canyon
- BR14 Pompeia
- BR15 Salsa
- BR16 Cinnabar
- BR17 Aztec
- BR18 New Sand
- BR19 Cream
- BR20 White
- BR21 Moccasin
- BR22 Buckskin
- BR23 Praire
- BR24 Mineral
- BR25 Skyway
- BR26 Iron
- BR27 Stormy
- BR28 Esmeralda
- BR29 Seaweed
- BR30 Bone
- BR31 Caramel
- BR32 Bridle
- BR33 Moon

Surface Materials - Leather/Faux

<p>Grade 11</p> <p>Destiny</p> <p>DY01 Black</p> <p>DY02 Raisin</p> <p>DY03 Blueberry</p> <p>DY04 Chestnut</p> <p>DY05 Cedar</p> <p>DY06 Black Rose</p> <p>DY07 Wine</p> <p>DY09 Dune</p> <p>DY10 Truffle</p> <p>DY11 Oak</p> <p>DY12 Newport</p> <p>DY13 Evergreen</p> <p>DY14 Storm</p> <p>DY15 Juniper</p> <p>DY16 Olive</p> <p>DY17 Mocha</p> <p>DY18 Ash</p> <p>DY21 Butter</p> <p>DY23 Deep Red</p> <p>DY24 Eggshell</p> <p>DY26 Parchment</p> <p>DY27 Periwinkle</p> <p>DY30 Royal Purple</p> <p>DY31 Saddle</p> <p>DY32 Cactus Green</p> <p>DY33 Cypress</p> <p>DY34 Mink</p> <p>DY35 Football</p> <p>DY36 Root</p> <p>Finesse</p> <p>AM00 White Cloud</p> <p>AM01 Gelato</p> <p>AM02 Winter White</p> <p>AM04 Mushroom</p> <p>AM06 Charbrown</p> <p>AM08 Iceberg</p> <p>AM09 Gravel</p> <p>AM10 Colonial Blue</p> <p>AM24 Rye</p> <p>AM25 Barley</p> <p>AM26 Stucco</p> <p>AM27 Beaver</p> <p>AM28 Otter</p> <p>AM65 Bordeaux</p> <p>AM66 Navy</p> <p>AM67 Cinder</p> <p>AM80 Cameo</p> <p>AM81 Oyster Grey</p> <p>AM83 Taupe</p> <p>AM85 Chestnut</p> <p>AM87 Indigo</p> <p>AM88 Bone</p> <p>AM89 Jet Black</p> <p>AM92 Burgundy</p> <p>AM93 Hunter Green</p> <p>AM98 Oxford Brown</p> <p>Ovation</p> <p>O500 Dark Brown</p> <p>O501 Light Grey</p> <p>O502 Sage</p> <p>O503 Indigo</p> <p>O504 Lilac</p> <p>O505 Terra</p> <p>O506 Moss</p> <p>O507 Teal</p> <p>O508 Stone</p> <p>O509 Cappuccino</p>	<p>Panache</p> <p>P800 Ebony</p> <p>P801 Cactus</p> <p>P802 Sherwood</p> <p>P803 Teal Blue</p> <p>P804 Sweet Sage</p> <p>P805 Coffee</p> <p>P806 True Taupe</p> <p>P807 Cashew</p> <p>P808 Acorn</p> <p>P809 Redwood</p> <p>P810 Exotic Orchid</p> <p>P811 Maize</p> <p>P812 Chartreuse</p> <p>P813 Regal Blue</p> <p>Prestige</p> <p>AFA1 Onyx</p> <p>AFB2 Soft White</p> <p>AFC3 Saxe Blue</p> <p>AFD3 Buff</p> <p>AFDG Antique White</p> <p>AFE1 Sandstone</p> <p>AFH1 Pecan</p> <p>AFH2 Buttercreme</p> <p>AFI1 Havana</p> <p>AFI2 Brick</p> <p>AFK1 Parchment</p> <p>AFL8 French Grey</p> <p>AFP1 Willow</p> <p>AFP2 Boxwood Green</p> <p>AFPA Tree Moss</p> <p>AFPC Celadon</p> <p>AFS3 Wild Plum</p>	<p>Grade 12</p> <p>Elegance</p> <p>EL01 Ivory</p> <p>EL02 Cream</p> <p>EL03 Char</p> <p>EL04 Saddle</p> <p>EL05 Dune</p> <p>EL06 Camel</p> <p>EL07 Sage</p> <p>EL08 Gray</p> <p>EL09 Walnut</p> <p>EL10 Burgundy</p> <p>EL11 Green</p> <p>EL12 Navy</p> <p>EL13 Black</p>	<p>Grade 13</p> <p>Destiny Perforated</p> <p>DP01 Black</p> <p>DP02 Raisin</p> <p>DP03 Blueberry</p> <p>DP04 Chestnut</p> <p>DP05 Cedar</p> <p>DP06 Black Rose</p> <p>DP07 Wine</p> <p>DP09 Dune</p> <p>DP10 Truffle</p> <p>DP11 Oak</p> <p>DP12 Newport</p> <p>DP13 Evergreen</p> <p>DP14 Storm</p> <p>DP15 Juniper</p> <p>DP16 Olive</p> <p>DP17 Mocha</p> <p>DP21 Butter</p> <p>DP23 Deep Red</p> <p>DP24 Eggshell</p> <p>DP26 Parchment</p> <p>DP27 Periwinkle</p> <p>DP30 Royal Purple</p> <p>DP31 Saddle</p> <p>DP32 Cactus Green</p> <p>DP33 Cypress</p> <p>DP34 Mink</p> <p>DP35 Football</p> <p>DP36 Root</p> <p>Finesse Perforated</p> <p>AP00 White Cloud</p> <p>AP01 Gelato</p> <p>AP02 Winter White</p> <p>AP04 Mushroom</p> <p>AP06 Charbrown</p> <p>AP08 Iceberg</p> <p>AP09 Gravel</p> <p>AP10 Colonial Blue</p> <p>AP24 Rye</p> <p>AP25 Barley</p> <p>AP26 Stucco</p> <p>AP27 Beaver</p> <p>AP28 Otter</p> <p>AP65 Bordeaux</p> <p>AP66 Navy</p> <p>AP67 Cinder</p> <p>AP80 Cameo</p> <p>AP81 Oyster Grey</p> <p>AP83 Taupe</p> <p>AP85 Chestnut</p> <p>AP87 Indigo</p> <p>AP88 Bone</p> <p>AP89 Jet Black</p> <p>AP92 Burgundy</p> <p>AP93 Hunter Green</p> <p>AP98 Oxford Brown</p>	<p>Panache Perforated</p> <p>PR00 Ebony</p> <p>PR01 Cactus</p> <p>PR02 Sherwood</p> <p>PR03 Teal Blue</p> <p>PR04 Sweet Sage</p> <p>PR05 Coffee</p> <p>PR06 True Taupe</p> <p>PR07 Cashew</p> <p>PR08 Acorn</p> <p>PR09 Redwood</p> <p>PR10 Exotic Orchid</p> <p>PR11 Maize</p> <p>PR12 Chartreuse</p> <p>PR13 Regal Blue</p> <p>Prestige Perforated</p> <p>APA1 Onyx</p> <p>APB2 Soft White</p> <p>APC3 Saxe Blue</p> <p>APD3 Buff</p> <p>APDG Antique White</p> <p>APE1 Sandstone</p> <p>APH1 Pecan</p> <p>APH2 Buttercream</p> <p>API1 Havana</p> <p>API2 Brick</p> <p>APK1 Parchment</p> <p>APL8 French Grey</p> <p>APP1 Willow</p> <p>APP2 Boxwood Green</p> <p>APPA Tree Moss</p> <p>APPC Celadon</p> <p>APS3 Wild Plum</p>
--	---	---	---	---

Cut Yardage Net Price List

FABRIC NAME	Under 60 Yards	60 Yards & Over
Elegance®	\$86.00/yd.	\$82.00/yd.
Finesse®	\$52.00/yd.	\$51.00/yd.
Finesse® Perforated (min. 5 yds)	\$63.00/yd.	\$62.00/yd.
Prestige®	\$57.00/yd.	\$54.00/yd.
Prestige® Perforated (min. 5 yds)	\$68.00/yd.	\$65.00/yd.
Destiny®	\$58.00/yd.	\$56.00/yd.
Destiny® Perforated (min. 5 yds)	\$69.00/yd.	\$66.00/yd.
Ovation	\$58.00/yd.	\$54.00/yd.
Panache	\$58.00/yd.	\$56.00/yd.

LEATHER NAME	Under 500 sq. ft.	500-1000 sq. ft.	Over 1000 sq. ft.
Elmosoft	\$9.00/sq. ft.	\$8.00/sq. ft.	\$7.50/sq. ft.
Elmorustical*	\$11.00/sq. ft.	\$9.00/sq. ft.	\$8.50/sq. ft.

ORDERING INFORMATION

- Minimum Order Requirements
 - Fabric: 1 yd. - 1/8 yd. increments.
 - Leather: 1 full hide (avg. sq. ft./hide - 50).
 - All orders will be filled in full hides only.
 - Overage will be invoiced accordingly.
- Special match leather: 2,500 sq. ft. minimum (Check delivery date)
- The embossing techniques used on Novasuede Perforated to achieve these looks involve very high temperatures. Color and shade may vary slightly based on the fiber density being embossed.
- Cancelled textile orders are subject to a 30% restocking fee. Order must be cancelled 5 days before ship date.
- Due to the natural processes of dyeing, sanding and embossing necessary to achieve these special looks, actual production may vary slightly in appearance from the swatches shown.

COALESSE TEXTILE WARRANTY

Coalesse textile merchandise is produced in accordance with Coalesse high standards. Coalesse does not guarantee, warrant or accept any responsibility whatsoever by reason of its fabrics or leathers fading, wearing, cracking, shrinking, stretching, tearing, seam slippage, alteration in color due to any finish treatment (flameproofing, stain repellent, etc.) or discoloration from liquid contact. Printed textiles are not warranted against irregularity in register. Coalesse is not responsible for dye lot differences or discrepancies in widths of fabrics. Coalesse does not guarantee, warrant or represent an exact color match to cuttings, tabs, memos or sample cards. Coalesse does not warrant exact matching of color or grain of leather. Leather hides may contain certain natural marks, scars, scratches, wrinkles and shade variations within hides, etc., considered by leather tanneries and Coalesse to be inherent characteristics part of the natural beauty of leather and the size or location of such markings cannot be controlled. In any event, upon inspection, Coalesse's responsibility shall be limited to either replacement of merchandise or refund of purchase price at Coalesse's option. The foregoing constitutes the sole and exclusive remedy of the customer. Coalesse is not responsible for the application or installation of our products. In no event shall Coalesse be responsible for any consequential damages or any charges, costs, expenses, or obligations other than as expressly herein set forth. Coalesse makes no other warranties, expressed or implied, as to any product sold by Coalesse. All other warranties (including any warranty of merchantability or fitness for any particular purpose) are hereby excluded.

Leather and Faux Leather Matrix

Note: Coalesse reserves the right to reject fabrics when necessary if the quality or construction is not satisfactory for intended use. For most up to date information on fabric usage, please check the fabric database on www.coalesse.com.

Legend

- = Not available
- = Available
- ☐ = Must be ordered as COM or COL
- ☒ = Available but will puddle
- ▶ See specification pages for details.

	Elmosoft Grade C	Elmoique Grade E	Elmorustical Grade E	Loke Leather	Brisa Grade 10	Destiny Grade 11	Destiny Perforated Grade 13	Prestige Grade 11	Prestige Perforated Grade 13	Finesse Grade 11	Finesse Perforated Grade 13	Elegance Grade 12	Panache Grade 11	Panache Perforated Grade 13	Ovation Grade 11
Await	■	•	■	☐	■	■	■	■	■	■	■	■	■	■	■
Bindu	■	•	■	☐	■	■	■	■	■	■	■	■	■	■	■
Bix	■	•	■	•	■	■	•	■	•	■	•	■	■	•	■
Bob	■	•	■	•	■	■	•	■	•	■	•	■	■	■	■
Capa	■	•	■	☐	■	■	■	■	■	■	■	■	■	■	■
Chord	■	•	■	☐	■	■	■	■	■	■	■	■	■	■	■
Circa	■	•	■	☐	■	■	■	■	■	■	■	■	■	■	■
Coupe	■	•	■	☐	■	■	■	■	■	■	■	■	■	■	■
Davos	■	•	■	•	■	■	•	■	•	■	•	■	■	•	■
Emu Indoor Cushion	■	■	■	•	■	■	■	■	■	■	■	■	■	•	■
Enea	■	•	■	☐	■	■	■	■	■	■	■	■	■	■	■
Enea Lottus	■	■	■	•	■	■	•	■	•	■	•	■	■	•	■
Exponents (Benches)	■	•	■	•	■	■	•	■	•	■	•	■	■	•	■
Joel	■	•	■	•	■	■	•	■	•	■	•	■	■	•	■
Kathryn	■	■	■	☐	■	■	■	■	■	■	■	■	■	■	■
Lagunitas	■	•	■	•	■	■	■	■	■	■	■	■	■	■	■
Lox	■	■	■	•	■	■	•	■	•	■	•	■	■	•	■
Millbrae Contract	■	•	■	☐	■	■	■	■	■	■	■	■	■	■	■
Millbrae Lifestyle	■	■	■	☐	■	■	■	■	■	■	■	■	■	■	■
Montara650	■	•	■	•	■	■	•	■	•	■	•	■	■	■	■
Passerelle	■	•	■	☐	■	■	■	■	■	■	■	■	■	■	■
Ripple	■	•	■	☐	■	■	■	■	■	■	■	■	■	■	■
SW_1	■	•	■	•	■	■	•	■	•	■	•	■	■	•	■
Swathmore	■	•	■	☐	■	■	■	■	■	■	■	■	■	■	■
Swathmore Grande	■	•	■	☐	■	■	■	■	■	■	■	■	■	■	■
Switch	■	•	■	☐	■	■	■	■	■	■	■	■	■	■	■
Together	☒	•	☒	•	☒	☒	•	☒	•	☒	•	☒	☒	•	■
Topo	■	•	■	•	■	■	•	■	•	■	•	■	■	•	■
Visalia	■	•	■	☐	■	■	■	■	■	■	■	■	■	■	■
Wrapp	■	•	■	•	■	■	■	■	■	■	■	■	■	■	■

Disclaimer: Coalesse is pleased to provide this information. However, even after preliminary approval, Coalesse reserves the right to reject fabrics/leathers when necessary if the quality or construction is not satisfactory for the item it is intended for use on. Coalesse reserves the right to evaluate data daily and make any necessary changes or improvements to the information provided. Textile recommendations do not imply a warranty for the textiles. The textile manufacturer provides all warranties for textiles. All trademarks and trade names are the property of the different manufacturers. All pricing quotes for product should be obtained from your local Sales Representative or a Coalesse Customer Service Representative. Recommendations such as latex backing, Gore SP and CAL 133 will require additional cost and may require additional lead-time. All specifications are subject to change without notice.

Surface Materials - Wood

Wood

Standard Wood Finishes

Coalesse's primary wood finish, Clarity, is a water-borne UV topcoat, which protects the environment while providing exceptional durability and resistance to water and chemical stains. Contoured products, such as wood guest chairs and occasional tables, are finished with post-catalyzed vinyl, which provides similar properties and matches the sheen and color of Clarity. Due to natural variations in wood, finished products may vary from samples in color, texture, and grain.

Wood will develop a deep, rich patina over time as the wood ages. Mineral streaks, gum pockets, and pin knots are some of the unique characteristics that are visible in veneers and solids.

All wood products will darken with age and exposure to ultraviolet light. This is especially apparent with cherry and maple veneer.

When storing your wood furniture, please follow the following guidelines:

- Do not store products in trailers
- Store products in areas that simulate office temperatures (60°F to 90°F)
- Store products in areas that maintain constant, office-like humidity levels
- Keep product away from light. Cover products to make sure they are not exposed to light.

Samples contact Customer Service at 1.800.627.6770

Steelcase Wood Finishes

Coalesse will match current Steelcase wood finishes at no upcharge. Finish matches are for color only and do not match the Steelcase finish in sheen. Samples will be provided upon request from Customer Service at 1.800.627.6770 and will be produced within 10 working days.

Stain-To-Match Wood Finish on cherry, maple, walnut, or oak

Coalesse will Stain-To-Match any wood finish at no upcharge. Samples submitted for matching must be at least 12" x 12" in surface dimension. Customers must specify cherry, maple, oak, or walnut species. Coalesse will produce a strike-off within 5 working days following acknowledgement of the order. Coalesse will not schedule the order for production until the strike-off has been approved and received by Coalesse.

Tip: For a visual palette, please refer to the Steelcase Finish Library.

Painted MDF

The painted medium density fiberboard (MDF) is utilizing molding grade MDF, therefore, the 45 lb density is consistent throughout the entire thickness of the board. This allows for a smooth edge when painted. Three coats of water reducible finish is applied to the board in a milk or black. The painted MDF has durability and care properties like a wood veneer, thus, must be treated as such.

Veneer Specifications

Cherry

- American Black Cherry
- Flat cut, plain sliced/book matched
- Quarter cut/book matched
- Narrow cathedrals, mild grain, minimal pitch
- 5-10" wide leaves of 1/42" thick veneer, balanced on panel
- No gaps between leaves
- PB (particle board) core
- Low sheen 15 or high sheen 35

Maple

- Eastern Hard White Maple
- Flat cut, plain sliced/slip matched
- Quarter cut/book matched
- Narrow cathedrals, mild grain, minimal pitch
- 5-10" wide leaves of 1/42" thick veneer, balanced on panel
- No gaps between leaves
- PB (particle board) core
- Low sheen 15 or high sheen 35

Oak

- White Oak
- Rift cut
- Slip match
- Mild grain
- 4-8" wide leaves of 1/42" thick veneer, balanced on panel
- No gaps between leaves
- PB (particle board) core
- Low sheen 15 or high sheen 35

Walnut

- American Black Walnut
- Flat cut, plain sliced/book matched
- Quarter cut/book matched
- Narrow cathedrals, mild grain
- 5-10" wide leaves of 1/42" thick veneer, balanced on panel
- No gaps between leaves
- PB (particle board) core
- Low sheen 15 or high sheen 35

Exclusive (by product)

Teak

- Quarter cut/book match
- 15 sheen

Ash (Grey)

- Quarter cut/book match
- 15 sheen

Flat-cut – High Sheen

Grade 1

- V10C FC/HS Natural Cherry
- V11C FC/HS Clear Cherry
- V12C FC/HS Medium Amber Cherry
- V13C FC/HS Dark Cherry
- V10M FC/HS Clear Maple
- V11M FC/HS Natural Beech on Maple
- V12M FC/HS Medium Maple
- V10W FC/HS Natural Walnut
- V11W FC/HS Clear Walnut
- V12W FC/HS Medium Walnut
- V13W FC/HS Black Walnut
- V14W FC/HS Dark Walnut

Flat-cut – Low Sheen

Grade 1

- V1AC FC/LS Natural Cherry
- V1BC FC/LS Clear Cherry
- V1CC FC/LS Medium Amber Cherry
- V1DC FC/LS Dark Cherry
- V1AM FC/LS Clear Maple
- V1BM FC/LS Natural Beech on Maple
- V1CM FC/LS Medium Maple
- V1AW FC/LS Natural Walnut
- V1BW FC/LS Clear Walnut
- V1CW FC/LS Medium Walnut
- V1EW FC/LS Dark Walnut

Rift-cut – High Sheen

Grade 1

- V30K RC/HS Natural Oak
- V31K RC/HS Desert Oak
- V32K RC/HS Medium Brown Oak
- V33K RC/HS Medium Gray Oak
- V34K RC/HS Black Brown Oak

Rift-cut – Low Sheen

Grade 1

- V3AK RC/LS Natural Oak
- V3BK RC/LS Desert Oak
- V3CK RC/LS Medium Brown Oak
- V3DK RC/LS Medium Gray Oak
- V3EK RC/LS Black Brown Oak

Quarter-cut – High Sheen

Grade 2

- V20C QC/HS Natural Cherry
- V21C QC/HS Clear Cherry
- V22C QC/HS Medium Amber Cherry
- V23C QC/HS Dark Cherry
- V20M QC/HS Clear Maple
- V21M QC/HS Natural Beech on Maple
- V22M QC/HS Medium Maple
- V20W QC/HS Natural Walnut
- V21W QC/HS Clear Walnut
- V22W QC/HS Medium Walnut
- V23W QC/HS Black Walnut
- V24W QC/HS Dark Walnut

FC=Flat Cut
RC=Rift Cut
QC=Quarter Cut
WL=Wedge Lay-up
HS=High Sheen
LS=Low Sheen

Surface Materials - Wood

Quarter-cut – Low Sheen

Grade 2

- V2AA QC/LS Ash Natural FSC
- V2AC QC/LS Natural Cherry
- V2BC QC/LS Clear Cherry
- V2CC QC/LS Medium Amber Cherry
- V2DC QC/LS Dark Cherry
- V2AM QC/LS Clear Maple
- V2BM QC/LS Natural Beech on Maple
- V2CM QC/LS Medium Maple
- V2AW QC/LS Natural Walnut
- V2BW QC/LS Clear Walnut
- V2CW QC/LS Medium Walnut
- V2EW QC/LS Dark Walnut
- V2AT QC/LS Teak Natural Raw FSC

Wedge Lay-up* – Flat cut – High Sheen

Grade 1

- W10C WC/FC/HS Natural (Raw) Cherry
- W11C WC/FC/HS Clear Cherry
- W12C WC/FC/HS Medium Amber Cherry
- W13C WC/FC/HS Dark Cherry
- W10M WC/FC/HS Clear Maple
- W11M WC/FC/HS Natural Beech on Maple
- W12M WC/FC/HS Medium Maple
- W10W WC/FC/HS Natural (Raw) Walnut
- W11W WC/FC/HS Clear Walnut
- W12W WC/FC/HS Medium Walnut
- W13W WC/FC/HS Black Walnut
- W14W WC/FC/HS Dark Walnut

Wedge Lay-up* – Flat cut – Low Sheen

Grade 1

- W1AC WC/FC/LS Natural (Raw) Cherry
- W1BC WC/FC/LS Clear Cherry
- W1CC WC/FC/LS Medium Amber Cherry
- W1DC WC/FC/LS Dark Cherry
- W1AM WC/FC/LS Clear Maple
- W1BM WC/FC/LS Natural Beech on Maple
- W1CM WC/FC/LS Medium Maple
- W1AW WC/FC/LS Natural (Raw) Walnut
- W1BW WC/FC/LS Clear Walnut
- W1CW WC/FC/LS Medium Walnut
- W1EW WC/FC/LS Dark Walnut

Wedge Lay-up* – Rift cut – High Sheen

Grade 1

- W30K WC/RC/HS Natural (Raw) Oak
- W31K WC/RC/HS Desert Oak
- W32K WC/RC/HS Medium Brown Oak
- W33K WC/RC/HS Medium Gray Oak
- W34K WC/RC/HS Black Brown Oak

Wedge Lay-up* – Rift cut – Low Sheen

Grade 1

- W3AK WC/RC/LS Natural (Raw) Oak
- W3BK WC/RC/LS Desert Oak
- W3CK WC/RC/LS Medium Brown Oak
- W3DK WC/RC/LS Medium Gray Oak
- W3EK WC/RC/LS Black Brown Oak

- FC=Flat Cut
- RC=Rift Cut
- QC=Quarter Cut
- WL=Wedge Lay-up
- HS=High Sheen
- LS=Low Sheen
- OP=Open Pore

Wedge Lay-up* – Quarter cut – High Sheen

Grade 2

- W20C WC/QC/HS Natural (Raw) Cherry
- W21C WC/QC/HS Clear Cherry
- W22C WC/QC/HS Medium Amber Cherry
- W23C WC/QC/HS Dark Cherry
- W20M WC/QC/HS Clear Maple
- W21M WC/QC/HS Natural Beech on Maple
- W22M WC/QC/HS Medium Maple
- W20W WC/QC/HS Natural (Raw) Walnut
- W21W WC/QC/HS Clear Walnut
- W22W WC/QC/HS Medium Walnut
- W23W WC/QC/HS Black Walnut
- W24W WC/QC/HS Dark Walnut

Wedge Lay-up* – Quarter cut – Low Sheen

Grade 2

- W2AC WC/QC/LS Natural (Raw) Cherry
- W2BC WC/QC/LS Clear Cherry
- W2CC WC/QC/LS Medium Amber Cherry
- W2DC WC/QC/LS Dark Cherry
- W2AM WC/QC/LS Clear Maple
- W2BM WC/QC/LS Natural Beech on Maple
- W2CM WC/QC/LS Medium Maple
- W2AW WC/QC/LS Natural (Raw) Walnut
- W2BW WC/QC/LS Clear Walnut
- W2CW WC/QC/LS Medium Walnut
- W2EW WC/QC/LS Dark Walnut

*Available on select tables, refer to pricing pages for availability.

Steelcase Veneers, Open Pore Only

Cherry, Flat Cut

Grade 1

- 3402 FC/OP Clear Cherry
- 3412 FC/OP Natural Cherry
- 3422 FC/OP Medium Cherry

Maple, Flat Cut

Grade 1

- 3522 FC/OP Clear Maple
- 3572 FC/OP Amber on Maple
- 3582 FC/OP Winter on Maple
- 3592 FC/OP Blonde on Maple

Maple, Quarter Cut

Grade 1

- 3222 QC/OP Clear Maple
- 3272 QC/OP Amber on Maple
- 3292 QC/OP Blonde on Maple

Walnut, Flat Cut

Grade 1

- 3062 FC/OP Graphite Walnut
- 3702 FC/OP Clear Walnut
- 3712 FC/OP Natural Walnut
- 3722 FC/OP Dark Mahogany on Walnut
- 3752 FC/OP Medium Walnut
- 3762 FC/OP Dark Walnut
- 3772 FC/OP Medium Mahogany on Walnut

Walnut, Quarter Cut

Grade 1

- 3302 QC/OP Clear Walnut
- 3312 QC/OP Natural Walnut
- 3322 QC/OP Dark Mahogany on Walnut
- 3352 QC/OP Medium Walnut
- 3362 QC/OP Dark Walnut
- 3372 QC/OP Medium Mahogany on Walnut
- 3382 QC/OP Graphite Walnut

Oak, Rift Cut

Grade 1

- 3602 RC/OP Desert Oak
- 3612 RC/OP Warm Oak
- 3692 RC/OP Espresso Oak

Natural Veneer

Grade 1

- 32A2 QC/OP Blanch Maple
- 33A2 QC/OP Thunder Walnut
- 3342 FC/OP Black Walnut
- 35A2 FC/OP Blanch Maple
- 36A2 RC/OP Volcanic Oak
- 37A2 FC/OP Thunder Walnut

Grade 2

- 3082 FC/OP Washed Walnut
- 3392 QC/OP Black Walnut

Planked Veneer

- 3P41 OP Planked Cherry
- 3P51 OP Planked Maple
- 3P61 OP Planked Oak
- 3P71 OP Planked Walnut

Painted MDF

Applies to: Exponents

- V145 Milk
- V197 Black

Hardwood Matrix

For Collaboration Chair Bases, Guest Chairs, Occasional Tables, and Lounge Chairs

Legend

- = Not available
- = Available
- M = Stain color only on maple
- B = Stain color only on beach
- ▶ See specification pages for details.

	Maple Flat Cut – High Sheen	Maple Flat Cut – Low Sheen	Maple Quarter Cut – High Sheen	Maple Quarter Cut – Low Sheen	Cherry Flat Cut – High Sheen	Cherry Flat Cut – Low Sheen	Cherry Quarter Cut – High Sheen	Cherry Quarter Cut – Low Sheen	Oak Rift Cut – High Sheen	Oak Rift Cut – Low Sheen	Walnut Flat Cut – High Sheen	Walnut Flat Cut – Low Sheen	Walnut Quarter Cut – High Sheen	Walnut Quarter Cut – Low Sheen	Teak Quarter Cut – High Sheen	Teak Quarter Cut – Low Sheen	Grey Ash – High Sheen	Grey Ash – Low Sheen	Exclusive Finishes for Trees	Carl Hansen Exclusive Wood Finishes
Seating																				
Circa	■	■	•	•	M	M	•	•	M	M	■	■	•	•	•	•	•	•	•	•
Coupe	■	■	•	•	M	M	•	•	M	M	■	■	•	•	•	•	•	•	•	•
Detour Tablet	■	■	•	•	M	M	•	•	M	M	M	M	•	•	•	•	•	•	•	•
Enea	■	■	•	•	M	M	•	•	M	M	M	M	•	•	•	•	•	•	•	•
Kathryn	B	B	•	•	B	B	•	•	B	B	B	B	•	•	•	•	•	•	•	•
Passerelle	■	■	•	•	M	M	•	•	M	M	M	M	•	•	•	•	•	•	•	•
Swathmore	■	■	•	•	M	M	•	•	M	M	M	M	•	•	•	•	•	•	•	•
Swathmore Grande	■	■	•	•	M	M	•	•	M	M	M	M	•	•	•	•	•	•	•	•
Occasional Tables																				
Bix Tables	■	■	•	•	■	■	•	•	■	■	■	■	•	•	•	•	•	•	•	•
Circa	■	■	•	•	M	M	•	•	M	M	■	■	•	•	•	•	•	•	•	•
Diekman	■	■	•	•	M	M	•	•	M	M	M	M	•	•	•	•	•	•	•	•
Enea	■	■	•	•	M	M	•	•	M	M	M	M	•	•	•	•	•	•	•	•
Passerelle	■	■	•	•	M	M	•	•	M	M	M	M	•	•	•	•	•	•	•	•
Sidewalk	■	■	•	•	M	M	•	•	M	M	M	M	•	•	•	•	•	•	•	•
Trees	•	•	•	•	•	•	•	•	•	•	•	•	•	•	•	•	•	•	■	•

Surface Materials - Laminate

Laminate

Coalesse's graded laminate program includes our standard laminates, Steelcase High-Pressure Laminates, and standard High-Pressure Laminates from Nevamar, Wilsonart, Formica, and Pionite.

Coalesse Standard Laminate

Grade 1

Coalesse High-Pressure Laminates are priced as Grade 1.

High-Pressure Laminates listed below are not available on all products, check laminate matrix for availability.

- 2730 Arctic White
- 2746 Black
- 2826 White Nebula
- 2829 Poppysseed
- 2830 Charcoal
- 2884 Milk
- 2886 Maple
- 2887 Amber Cherry
- 2890 Folkstone BMW
- 2891 Ingot
- 2892 Ash
- 2894 Natural Cork
- 2895 Natural Walnut
- 2896 Dark Cork
- 2897 Desert Oak
- 2898 Satin Stainless

Steelcase Standard Laminate

Grade 1

Steelcase High-Pressure Laminates are priced as Grade 1. All Steelcase High-Pressure Laminates may be specified on Coalesse products with exception (must be ordered as Special): Awaiting tables, Enea tables, Enea Lottus tables, and Sidewalk tables. The use of Steelcase High-Pressure Laminate may be subject to extended lead times.

Tip: For a visual palette, please refer to the Steelcase Finish Library.

Fiber Laminate

- 2850 Vanadium Fiber
- 2851 Rhyme Fiber
- 2852 Tungsten Fiber
- 2854 Vellum Fiber
- 2859 Novell Fiber
- 2860 Granite Fiber
- 2861 Coconut Fiber
- 2862 Stucco Fiber

Micro Laminate

- 2920 Marl Micro
- 2921 Gypsum Micro
- 2922 Clay Micro
- 2923 Shadow Micro

Patina Laminate

- 2870 Blonde Bronze Patina
- 2871 Balckened Bronze Patina
- 2873 Instant Iron Patina

Solid Laminate

- 2722 Cream
- 2730 Arctic White
- 2746 Black
- 2759 Warm White
- 2811 Mist
- 2883 Seagull
- 2884 Milk
- 2885 Dune
- 2HMG Merle

Speckle Laminate

- 2820 Coffee Speckle
- 2822 Woodrose Speckle
- 2823 Driftwood Speckle
- 2824 Smoke Speckle
- 2825 Vanadium Speckle

Woodgrain Laminate

- 2406 Clear Cherry
- 2409 Clear Maple
- 2410 Graphite Walnut
- 2412 Natural Cherry
- 2422 Medium Cherry
- 2511 Winter on Maple
- 2538 Clear Walnut
- 2539 Warm Oak
- 2592 Blonde on Maple
- 2714 Natural Walnut
- 2772 Medium Mahogany on Walnut
- 2HAK Clear Oak
- 2HAN Ash Noce
- 2HAT Acacia
- 2HAW Ash Wenge
- 2HBN Bisque Noce
- 2HBW Bisque Wenge
- 2HCN Clay Noce
- 2HCW Clay Wenge
- 2HSN Storm Noce
- 2HSW Storm Wenge

turnstone Laminate Collection

A selection of laminates and edgebands are available on some Coalesse brand products. This collection is stocked and available with standard lead times and supported like standard laminates to help make ordering easy.

Tip: For a visual palette, please refer to the Steelcase Finish Library.

- 2535 Virginia Walnut
- 2536 Blackwood
- 2612 Marbled Maple
- 2614 Chocolate Walnut
- 2615 Marbled Cherry

Steelcase Select Surfaces Laminate

Grade 2

Textured Woodgrain Laminate

- 2TH2 Fawn Cypress
- 2TH3 Weathered Char
- 2TH4 Saddle Oak
- 2TH5 Veranda Teak
- 2TH6 Persian Cherry
- 2TH7 Walnut Heights

Tip: Because these finishes are part of Steelcase Select Surfaces, they may have additional lead times.

Textured Industrial Laminate

- 2UH1 Reclaimed Aggregate
- 2UH2 Reclaimed Gravel
- 2UH4 Cement*
- 2UH6 Sheetrock

Tip: Because these finishes are part of Steelcase Select Surfaces, they may have additional lead times.

*2UH4 Cement is only available on select table sizes.

Open Line Laminates

Customers can select laminates that are not offered as standard from select suppliers. Standard grade High-Pressure Laminates can be specified in Grade 1 (290A) or Grade 2 (290B) as indicated below (subject to availability). Grade 2 laminates will have extended lead time. Select from any Coalesse or Steelcase standard edge band finishes.

Contact Customer Service at 1.800.627.6770 to verify that your laminate selection falls within the categories noted below.

Directional patterns and woodgrains may be used on freestanding systems products, but will not be patterned matched.

Some standard High-Pressure Laminates, may not be available in the appropriate size to produce large products.

Wilsonart (Grade 1)
Standards (matte finish)
Exceptions: High definition which must be quoted as a special. Marker board which is grade 2.

Nevamar (Grade 2)
Solids (textured finish)
Patterns (textured finish)

Formica (Grade 2)
Color portfolio (matte finish)
Patterns (matte finish)
Formations (matte finish)

Pionite (Grade 2)
Decorative surfaces (suede finish)

Non-Standard Laminates

Coalesse can supply additional laminates for an upcharge. Contact your Coalesse sales consultant for a custom quotation. Custom upcharges will vary based upon the cost of the material specified and additional labor required to manufacture the products. Some non-standard laminates will not be available in the appropriate size to produce large Coalesse products. A sample of the laminate may be requested for approval. Some non-standard laminates may be subject to extended lead times.

Coalesse does not use the following types of laminate materials on Topo:

- Formica solid surfacing – Surell Solids, Surell Granites
- Nevamar – Fountainhead
- Dupont – Corian
- Metal Laminates – textured, brushed or polished

Coalesse

Surface Materials - Laminate

High-Pressure Laminate Matrix

Legend

- = Not available
- = Available
- ▶ See specification pages for details.

Seating

Await	■	■	•	•	•	•	•	•	•	•	•	•	•	•	•	•	■
Bix Podium Drawer Front	■	■	■	■	■	■	■	■	■	■	■	■	■	■	■	■	•
Coupe	■	■	•	•	•	■	•	•	■	■	■	■	■	■	■	■	•
Sidewalk Tablet	■	■	•	•	•	■	•	•	■	■	■	■	■	■	■	■	•
Swathmore Grande	■	■	•	•	•	■	•	•	■	■	■	■	■	■	■	■	•

Occasional Tables

Await	■	■	•	•	•	•	•	•	•	•	•	•	•	•	•	•	■
Bix Tables	■	■	■	■	■	■	■	■	■	■	■	■	■	■	■	■	•
Bob Tables	■	■	■	■	■	■	■	■	■	■	■	■	■	■	■	■	•
Circa Tables	■	■	■	■	■	■	■	■	■	■	■	■	■	■	■	■	•
Enea	■	■	■	■	■	■	■	■	■	■	■	■	■	■	■	■	•
Enea Lottus	■	■	■	■	■	■	■	■	■	■	■	■	■	■	■	■	•
Lagunitas Tables	■	■	■	■	■	■	■	■	■	■	■	■	■	■	■	■	•
Lagunitas Focus Nook	■	■	■	■	■	■	■	■	■	■	■	■	■	■	■	■	•
Montara650	■	■	■	■	■	■	■	■	■	■	■	■	■	■	■	■	•
Sidewalk	■	■	■	■	■	■	■	■	■	■	■	■	■	■	■	■	•
SW_1	■	■	■	■	■	■	■	■	■	■	■	■	■	■	■	■	•

Tables and Casegoods

Au Lait	■	■	■	■	■	■	■	■	■	■	■	■	■	■	■	■	•
Ballet	■	■	■	■	■	■	■	■	■	■	■	■	■	■	■	■	•
E-Table 2 Top	■	■	■	■	■	■	■	■	■	■	■	■	■	■	■	■	•
E-Table 2 Laminate Base	■	■	•	•	•	■	•	•	■	■	■	■	■	■	■	■	•
Enea	■	■	■	■	■	■	■	■	■	■	■	■	■	■	■	■	•
Enea Lottus	■	■	■	■	■	■	■	■	■	■	■	■	■	■	■	■	•
Host Collection	■	■	■	■	■	■	■	■	■	■	■	■	■	■	■	■	•
Montara650	■	■	■	■	■	■	■	■	■	■	■	■	■	■	■	■	•
Reunion Collection	■	■	■	■	■	■	■	■	■	■	■	■	■	■	■	■	•
SW_1	■	■	■	■	■	■	■	■	■	■	■	■	■	■	■	■	•
Train	■	■	■	■	■	■	■	■	■	■	■	■	■	■	■	■	•

Standard Coalesse High-Pressure Laminate																	Standard Steelcase High-Pressure Laminate																
2730 Arctic White	2746 Black	2826 White Nebula	2829 Poppyseed	2830 Charcoal	2884 Milk	2886 Maple	2887 Amber Cherry	2890 Folkstone	2891 Ingot	2892 Ash	2894 Natural Cork	2895 Natural Walnut	2896 Dark Cork	2897 Desert Oak	2898 Satin Stainless	290N North Sea	2406 Clear Cherry	2409 Clear Maple	2410 Graphite Walnut	2412 Natural Cherry	2422 Medium Cherry	2503 Brushed Silver	2511 Winter on Maple	2535 Virginia Walnut	2536 Blackwood	2538 Clear Walnut							
Seating																	Seating																
Occasional Tables																	Occasional Tables																
Tables and Casegoods																	Tables and Casegoods																

High-Pressure Laminate Matrix *continued*

Legend

- = Not available
- = Available
- ▶ See specification pages for details.

	2HBW Bisque Wenge	2HCN Clay Noce	2HCW Clay Wenge	2HMG Merle	2HSN Storm Noce	2HSW Storm Wenge	Select Surfaces Steelcase High-Pressure Laminate*									
							2TH2 Fawn Cypress	2TH3 Weathered Char	2TH4 Saddle Oak	2TH5 Veranda Teak	2TH6 Persian Cherry	2TH7 Walnut Heights	2UH1 Reclaimed Aggregate	2UH2 Reclaimed Gravel	2UH4 Cement	2UH6 Sheetrock
Seating																
Await	•	•	•	•	•	•	•	•	•	•	•	•	•	•	•	•
Bix Podium Drawer Front	■	■	■	■	■	■	■	■	■	■	■	■	■	■	■	■
Coupe	•	•	•	•	•	•	•	•	•	•	•	•	•	•	•	•
Sidewalk Tablet	•	•	•	■	•	•	■	■	■	■	■	■	■	■	■	■
Swathmore Grande	•	•	•	•	•	•	•	•	•	•	•	•	•	•	•	•
Occasional Tables																
Await	•	•	•	•	•	•	•	•	•	•	•	•	•	•	•	•
Bix Tables	■	■	■	■	■	■	■	■	■	■	■	■	■	■	■	■
Bob Tables	■	■	■	■	■	■	■	■	■	■	■	■	■	■	■	■
Circa Tables	■	■	■	■	■	■	■	■	■	■	■	■	■	■	■	■
Enea	■	■	■	■	■	■	■	■	■	■	■	■	■	■	■	■
Enea Lottus	■	■	■	■	■	■	•	•	•	•	•	•	•	•	•	•
Lagunitas Tables	■	■	■	■	■	■	■	■	■	■	■	■	■	■	■	■
Lagunitas Focus Nook	■	■	■	■	■	■	■	■	■	■	■	■	■	■	■	■
Montara650	■	■	■	■	■	■	■	■	■	■	■	■	■	■	■	■
Sidewalk	■	■	■	■	■	■	■	■	■	■	■	■	■	■	■	■
SW_1	■	■	■	■	■	■	■	■	■	■	■	■	■	■	■	■
Tables and Casegoods																
Au Lait	■	■	■	■	■	■	■	■	■	■	■	■	■	■	■	■
Ballet	■	■	■	■	■	■	■	■	■	■	■	■	■	■	■	■
Bob	■	■	■	■	■	■	■	■	■	■	■	■	■	■	■	■
E-Table 2 Top	■	■	■	■	■	■	■	■	■	■	■	■	■	•	■	■
E-Table 2 Laminate Base	■	•	•	•	•	•	•	•	•	•	•	•	•	•	•	•
Enea	■	■	■	■	■	■	■	■	■	■	■	■	■	■	■	■
Enea Lottus	■	■	■	■	■	■	•	•	•	•	•	•	•	•	•	•
Host Collection	■	■	■	■	■	■	■	■	■	■	■	■	■	■	•	■
Montara650	■	■	■	■	■	■	■	■	■	■	■	■	■	■	■	■
Reunion Collection	■	■	■	■	■	■	■	■	■	■	■	■	■	■	■	■
SW_1	■	■	■	■	■	■	■	■	■	■	■	■	■	■	■	■
Train	■	■	■	■	■	■	■	■	■	■	■	■	■	■	■	■

* Because these finishes are part of Steelcase Select Surfaces, they may have additional lead times.

High-Pressure Laminate Matrix

Laminate Edge Band Matrix

Legend

- = Not available
- = Available
- ▶ See specification pages for details.

6000 Black	6001 Coffee	6009 Artic White	6011 Ash	6012 Ingot	6034 Natural Cherry	6036 Medium Cherry	6037 Winter on Maple	6038 Blonde on Maple	6041 Natural Walnut	6045 Medium Mahogany on Walnut	6052 Milk	6053 Seagull	6086 Folkstone	6090 Amber Cherry	6091 Fusion Maple	6093 Dove Grey	6125 Graystone	6126 Greige	6127 Stonedust	6128 Taupe	6130 Dark Gray	6134 North Sea	6213 Acacia	6219 Clear Oak	6231 Graphite Walnut	6234 Clear Cherry	6237 Clear Maple	6242 Virginia Walnut	6243 Blackwood	6245 Clear Walnut	6246 Warm Oak	6249 Platinum Solid
------------	-------------	------------------	----------	------------	---------------------	--------------------	----------------------	----------------------	---------------------	--------------------------------	-----------	--------------	----------------	-------------------	-------------------	----------------	----------------	-------------	----------------	------------	----------------	----------------	-------------	----------------	----------------------	-------------------	------------------	----------------------	----------------	-------------------	---------------	---------------------

Seating

Swathmore Grande Mobile Tablet Self Edge	■	•	•	•	•	•	•	•	•	•	•	•	•	•	•	•	•	•	•	•	•	•	•	•	•	•	•	•	•	•	•	•	•	•
--	---	---	---	---	---	---	---	---	---	---	---	---	---	---	---	---	---	---	---	---	---	---	---	---	---	---	---	---	---	---	---	---	---	---

Occasional Tables

Await Table 3 mm Edge	■	•	■	•	•	•	•	•	•	•	•	•	•	•	•	•	•	•	•	•	•	•	■	•	•	•	•	•	•	•	•	•	•	•		
Bix Edge	■	■	■	■	■	■	■	■	■	■	■	■	■	■	■	■	■	■	■	■	■	■	■	■	■	■	■	■	■	■	■	■	■	■	■	
Enea T-Mold Edge	■	•	•	•	•	•	•	•	•	•	•	•	•	•	•	•	•	•	•	•	•	•	•	•	•	•	•	•	•	•	•	•	•	•	•	
Enea Lottus	■	•	•	•	•	•	•	•	•	•	•	•	•	•	•	•	•	•	•	•	•	•	•	•	•	•	•	•	•	•	•	•	•	•	•	
Montara650	■	■	■	■	■	■	■	■	■	■	■	■	■	■	■	■	■	■	■	■	■	■	■	■	■	■	■	■	■	■	■	■	■	■	■	■

Tables and Casegoods

Au Lait Convex Vinyl Edge	■	•	•	•	•	•	•	•	•	•	•	•	•	•	•	•	•	•	•	•	•	•	•	•	•	•	•	•	•	•	•	•	•	•			
Au Lait Cast Urethane Edge	■	•	•	•	•	•	•	•	•	•	•	•	•	•	•	•	•	•	•	•	•	•	•	•	•	•	•	•	•	•	•	•	•	•	•		
Await Table 3 mm Edge	■	•	■	•	•	•	•	•	•	•	•	•	•	•	•	•	•	•	•	•	•	•	■	•	•	•	•	•	•	•	•	•	•	•	•		
Ballet Ribbed Vinyl Edge	■	•	•	•	•	•	•	•	•	•	•	•	•	•	•	•	•	•	•	•	•	•	•	•	•	•	•	•	•	•	•	•	•	•	•		
Bix Edge (Bridge, work booth tables)	■	■	■	■	■	■	■	■	■	■	■	■	■	■	■	■	■	■	■	■	■	■	■	■	■	■	■	■	■	■	■	■	■	■	■	■	
Bob Tables	■	■	■	■	■	■	■	■	■	■	■	■	■	■	■	■	■	■	■	■	■	■	■	■	■	■	■	■	■	■	■	■	■	■	■	■	
E-Table 2 Convex Vinyl Edge	■	•	•	•	•	•	•	•	•	•	•	•	•	•	•	•	•	•	•	•	•	•	•	•	•	•	•	•	•	•	•	•	•	•	•		
E-Table 2 3 mm Edge	■	■	■	■	■	■	■	■	■	■	■	■	■	■	■	■	■	■	■	■	■	■	■	■	■	■	■	■	■	■	■	■	■	■	■	■	
Enea T-mold edge	■	•	•	•	•	•	•	•	•	•	•	•	•	•	•	•	•	•	•	•	•	•	•	•	•	•	•	•	•	•	•	•	•	•	•	•	
Enea Lottus Phenolic Edge	■	•	•	•	•	•	•	•	•	•	•	•	•	•	•	•	•	•	•	•	•	•	•	•	•	•	•	•	•	•	•	•	•	•	•	•	
Host Collection	•	•	•	•	•	•	•	•	•	•	•	•	•	•	•	•	•	•	•	•	•	•	•	•	•	•	•	•	•	•	•	•	•	•	•	•	
Lagunitas Table 3 mm Edge	■	■	■	■	■	■	■	■	■	■	■	■	■	■	■	■	■	■	■	■	■	■	■	■	■	■	■	■	■	■	■	■	■	■	■	■	■
Lagunitas Focus Nook	■	■	■	■	■	■	■	■	■	■	■	■	■	■	■	■	■	■	■	■	■	■	■	■	■	■	■	■	■	■	■	■	■	■	■	■	■
Montara650	■	■	■	■	■	■	■	■	■	■	■	■	■	■	■	■	■	■	■	■	■	■	■	■	■	■	■	■	■	■	■	■	■	■	■	■	■
Reunion Collection Bullnose Vinyl Edge	■	•	•	•	•	•	•	•	•	•	•	•	•	•	•	•	•	•	•	•	•	•	•	•	•	•	•	•	•	•	•	•	•	•	•	•	
Reunion Seminar Flat Vinyl Edge	■	•	•	•	•	•	•	•	•	•	•	•	•	•	•	•	•	•	•	•	•	•	•	•	•	•	•	•	•	•	•	•	•	•	•	•	•
SW_1	■	■	■	■	■	■	■	■	■	■	■	■	■	■	■	■	■	■	■	■	■	■	■	■	■	■	■	■	■	■	■	■	■	■	■	■	■
Train Signature Edge	■	•	•	•	•	•	•	•	•	•	•	•	•	•	•	•	•	•	•	•	•	•	•	•	•	•	•	•	•	•	•	•	•	•	•	•	•

Laminate Edge Band Matrix

6271 Plywood	6527 Merle	6607 Woodrose	6609 Smoke	6615 Grey V5	6619 Ice	6631 Cream	6635 Dawn	6636 Mist	6654 Sand	6655 Warm White	6676 Marbled Maple	6677 Chocolate Walnut	6678 Marbled Cherry	6694 Slate	6695 Midnight	6697 Fog	6698 Fieldstone	6703 Ash Wenge	6704 Storm Wenge	6705 Bisque Wenge	6706 Clay Wenge	6707 Ash Noce	6708 Bisque Noce	6709 Clay Noce	6710 Storm Noce	6D10 Silver Metallic	6D11 Black	6D12 White	6T02 Fawn Cypress*	6T03 Weathered Char*	6T04 Saddle Oak*	6T05 Veranda Teak*	6T06 Persian Cherry*	6T07 Walnut Heights*	2UH1 Reclaimed Aggregate*	2UH2 Reclaimed Gravel*	2UH4 Cement*	2UH6 Sheetrock*						
.		
■	■	.	.	■	■	■	■	■	■	■	■	■	■	■	■	■	■	■	■	■	■	■	■	■	■	■	■	■	■	■	■	■	■	■	■	■	■	■	■	■	■			
.		
■	■	.	.	■	■	■	■	■	■	■	■	■	■	■	■	■	■	■	■	■	■	■	■	■	■	■	■	■	■	■	■	■	■	■	■	■	■	■	■	■	■	■		
.	.	■	■	■		
■	■	.	.	■	■	■	■	■	■	■	■	■	■	■	■	■	■	■	■	■	■	■	■	■	■	■	■	■	■	■	■	■	■	■	■	■	■	■	■	■	■	■		
.	
■	■	.	.	■	■	■	■	■	■	■	■	■	■	■	■	■	■	■	■	■	■	■	■	■	■	■	■	■	■	■	■	■	■	■	■	■	■	■	■	■	■	■	■	
.
■	■	.	.	■	■	■	■	■	■	■	■	■	■	■	■	■	■	■	■	■	■	■	■	■	■	■	■	■	■	■	■	■	■	■	■	■	■	■	■	■	■	■	■	■
.

* Because these finishes are part of Steelcase Select Surfaces, they may have additional lead times.

Surface Materials - Glass

Glass

Not all glass selections are available on every product. Refer to glass matrix for availability by product.

Back-Painted Glass

6720	Sand
6721	Pewter
6722	Mojave
6723	Terra
6724	Jade
6725	Ocean
ACM	Absolute Clear with Moonlight
ACS	Absolute Clear with Sage
ACP	Absolute Clear with Poppy
ACG	Absolute Clear with Goldenrod
ACB	Absolute Clear with Black
ACC	Absolute Clear with Crystal Spring

Glass

6511	Acid Etched
AC	Absolute Clear
ACF	Absolute Clear Frosted
CG	Clear Green
CGF	Clear Green Laminated/Frosted Appearance

Exclusive to Emu products:

6547	Transparent
6548	Smoke Grey

Surface Materials - Metal/Paint

Metal/Paint

Coalesse powder coats all painted metal components for an exceptionally durable, environmentally responsible finish — eliminating VOC's (volatile organic compounds) from being released into the environment. Electrostatically charged powder coat material is applied to an exacting thickness and then temperature baked, resulting in a smooth, flawless finish that is abrasion and impact resistant. The following Coalesse metal finishes are available:

Paint

Coalesse Standard Paint—Neutrals

Grade 1

Standard Coat Paint

- 4138 Graphite Gloss
- 4140 Arctic White Gloss
- 4141 Platinum Matte
- 4142 Platinum Gloss
- 4144 Black Gloss (formerly anthracite gloss)
- 4145 Milk Gloss
- 4146 Champagne Matte
- 4147 Champagne Gloss
- 4148 Midnight Brown Gloss
- 4180 Graphite Matte
- 4193 Midnight Brown Matte
- 4242 Milk Matte
- 4710 Low Gloss Black
- 7196 Midnight Brown Textured
- 7197 Anthracite Textured

Coalesse Standard Paint—Colors

Grade 1

- 4065 Blue Ink Textured
- 4066 Ocean Textured
- 4067 Ice Textured
- 4068 Olive Textured
- 4069 Honey Textured
- 4070 Currant Textured
- 4071 Saffron Textured

Steelcase Select Surfaces Paint

Accent Paints

Grade 3

Allow customers to add trend-driven color to painted surfaces. We evolve this collection often, to ensure that fresh new colors are always available.

- 1ATB Cloud
- 1ATG Rose Quartz
- 1ATH Olivine
- 1ATJ Seasalt
- 1ATK Citrine
- 4AQB Wasabi
- 4AQ9 Scarlet
- 4AV3 Blue Jay
- 4AV4 Baltic
- 4AX0 Flash
- 4AX1 Citron
- 4AY2 Chili
- 4AZ5 Marlin
- 4BH7 Canary
- 4BQ7 Fuchsia
- 4CZ1 Aubergine
- 4CZ2 Peacock
- 4CZ3 Jungle
- 4CZ4 Merlot
- 4CZ5 Honey
- 4CZ6 Lagoon
- 4CZ7 Saffron
- 4CZ8 Light Peacock
- 4EE9 Electric Indigo

Lux Coatings

Grade 3

Introduces a softer, more human-centered aesthetic to the workplace. These powder coat paints provide tasteful accent for your spaces.

- 4B20 Obsidian
- 4B22 Matte Brass
- 4B23 Burnished Bronze
- 4B24 Night Bronze
- 4B25 Matte Copper
- 4B26 Smoked Mica
- 4B27 Blue Steel
- 4B28 Silver Lilac
- 4B29 Cast Iron
- 4B30 Bright Gold

Applies to: Emu Advanced Collection*

- 4251 Emu Indian Brown
 - 4256 Aluminum
 - 4257 Antique Iron
 - 7234 Emu Black
 - 7271 Emu White
 - 7272 Blue
 - 7273 Green
 - 7294 Emu Grey/Green
 - 7296 Emu Taupe
 - 7297 Emu Corten
 - 7298 Emu Copper
 - 7391 Emu Poppy
- *Not all colors available on all products as standard, consult Emu advanced paint matrix.

Applies to: Enea

- 4018 Silver Metallic
- 4016 White Gloss
- 4017 Black Gloss

Applies to: Enea Lottus

- 4062 Anthracite Grey Textured
 - 4063 Cool Grey Textured
 - 4064 Sand Textured
 - 4216 Red*
 - 4217 Brown
 - 4218 Platinum Silver
 - 7207 Black Textured
 - 7241 Arctic White Textured
- *Not available on Enea Lottus tables.

Applies to: Exponents (Base, Accent Ribbon, Handle, and Grommet)

- 4135 Black Matte
- 4141 Platinum Matte

Applies to: Exponents mobile displays (Base, Handle, and Inner Frame)

- 4135 Black Matte
- 4145 Milk Gloss

Metal

Anodized Aluminum

Applies to: Rod or disc pulls
5200 Satin Aluminum

Brushed Aluminum

Applies to: Lox stool
9251 Brushed Aluminum

Polished Aluminum

Applies to: Lox chair, Potrero415, and Bindu conference bases
8046 Polished Aluminum

Applies to: Bob and SW_1

8040 Aluminum Matte
Polished

Chrome

- 9201 Chrome
- 9207 Polished trivalent chrome
- 9208 Etched trivalent chrome

Brushed Nickel

Applies to: Millbrae seating and tables
9238 Brushed Nickel

Coalesce

Surface Materials - Metal/Paint

Metal/Paint Matrix

Legend

- = Not available
- = Available
- ▶ See specification pages for details.

Seating

Bindu Conference
Bindu Guest
Bix
Bob
Capa
Chord
Circa
Coupe
Enea
Enea Lottus
Lagunitas
Last Minute
Lox Stool
Millbrae
Montara650
SW_1
Switch
Topo Lounge
Visalia
Wrapp

Occasional Tables

Bix (vinyl version)
Bob
Circa
Enea
Enea Lottus
Lagunitas
Lagunitas Focus Nook
Millbrae
Montara650
Switch
SW_1

Coalesse Standard Paint—Neutrals										Coalesse Standard Paint—Colors										Product Line Exclusives								
4135 Black Matte	4138 Graphite Gloss	4140 Arctic White Gloss	4141 Platinum Matte	4142 Platinum Gloss	4144 Black Gloss	4145 Milk Gloss	4146 Champagne Matte	4147 Champagne Gloss	4148 Midnight Brown Gloss	4180 Graphite Matte	4193 Midnight Brown Matte	4242 Milk Matte	4710 Low Gloss Black	7196 Midnight Brown Textured	7197 Anthracite Textured	4065 Blue Ink Textured	4066 Ocean Textured	4067 Ice Textured	4068 Olive Textured	4069 Honey Textured	4070 Currant Textured	4071 Saffron Textured	LessThanFive	LessThanFive Essential	Enea Exclusive Finishes	Enea Café Wood Exclusive Finishes	Enea Lottus Exclusive Finishes	
Bindu Conference	•	•	•	•	•	•	•	•	•	•	•	•	•	•	•	•	•	•	•	•	•	•	•	•	•	•	•	•
Bindu Guest	•	•	•	•	•	•	•	•	•	•	•	•	•	•	•	•	•	•	•	•	•	•	•	•	•	•	•	•
Bix	•	■	■	■	■	■	■	■	■	■	■	■	■	■	■	•	•	•	•	•	•	•	•	•	•	•	•	•
Bob	•	■	•	■	■	■	■	■	■	■	■	■	■	■	■	•	•	•	•	•	•	•	•	•	•	•	•	•
Capa	•	•	•	•	•	•	•	•	•	•	•	•	•	•	•	•	•	•	•	•	•	•	•	•	•	•	•	•
Chord	•	•	•	•	•	•	•	•	•	•	•	•	•	•	•	•	•	•	•	•	•	•	•	•	•	•	•	•
Circa	•	■	■	■	■	■	■	■	■	■	■	■	■	■	■	•	•	•	•	•	•	•	•	•	•	•	•	•
Coupe	•	■	■	•	■	■	•	•	■	•	•	•	•	•	•	•	•	•	•	•	•	•	•	•	•	•	•	•
Enea	•	•	•	•	•	•	•	•	•	•	•	•	•	•	•	•	•	•	•	•	•	•	•	•	■	•	•	•
Enea Lottus	•	•	■	•	■	■	■	■	■	•	•	•	•	•	•	■	■	■	■	■	■	■	■	•	•	•	■	•
Lagunitas	•	•	•	■	•	•	•	•	•	•	•	•	•	■	•	•	•	•	•	•	•	•	•	•	•	•	•	•
Last Minute	•	•	•	•	•	•	•	•	•	•	•	•	•	•	•	•	•	•	•	•	•	•	•	•	•	•	•	•
Lox Stool	•	•	•	•	•	•	•	•	•	•	•	•	•	•	•	•	•	•	•	•	•	•	•	•	•	•	•	•
Millbrae	•	■	•	■	•	■	■	•	•	■	■	■	■	■	■	■	■	■	■	■	■	■	■	•	•	•	•	•
Montara650	•	■	•	■	•	■	■	•	•	■	■	■	■	■	■	■	■	■	■	■	■	■	■	•	•	•	•	•
SW_1	•	•	•	•	•	•	•	•	•	•	•	•	•	•	•	•	•	•	•	•	•	•	•	•	•	•	•	•
Switch	•	•	•	•	•	•	•	•	•	•	•	•	•	•	•	•	•	•	•	•	•	•	•	•	•	•	•	•
Topo Lounge	•	■	■	■	■	■	■	■	■	■	■	■	■	■	■	•	•	•	•	•	•	•	•	•	•	•	•	•
Visalia	•	■	•	■	•	■	■	•	•	■	■	■	■	■	■	■	■	■	■	■	■	■	■	•	•	•	•	•
Wrapp	•	•	•	•	•	•	•	•	•	•	•	•	•	•	•	•	•	•	•	•	•	•	•	•	•	•	•	•
Bix (vinyl version)	•	■	■	■	■	■	■	■	■	■	■	■	■	■	■	•	•	•	•	•	•	•	•	•	•	•	•	•
Bob	•	■	•	■	■	■	■	■	■	■	■	■	■	■	■	•	•	•	•	•	•	•	•	•	•	•	•	•
Circa	•	■	■	■	■	■	■	■	■	■	■	■	■	■	■	•	•	•	•	•	•	•	•	•	•	•	•	•
Enea	•	•	•	•	•	•	•	•	•	•	•	•	•	•	•	•	•	•	•	•	•	•	•	•	■	•	•	•
Enea Lottus	•	•	■	•	■	■	■	■	■	•	•	•	•	•	•	■	■	■	■	■	■	■	■	•	•	■	•	•
Lagunitas	•	■	■	■	■	■	■	■	■	■	■	■	■	■	■	■	■	■	■	■	■	■	■	•	•	•	•	•
Lagunitas Focus Nook	•	■	■	■	■	■	■	■	■	■	■	■	■	■	■	■	■	■	■	■	■	■	■	•	•	•	•	•
Millbrae	•	■	•	■	•	■	■	•	•	■	■	■	■	■	■	■	■	■	■	■	■	■	■	•	•	•	•	•
Montara650	•	■	•	■	•	■	■	•	•	■	■	■	■	■	■	■	■	■	■	■	■	■	■	•	•	•	•	•
Switch	•	•	•	•	•	•	•	•	•	•	•	•	•	•	•	•	•	•	•	•	•	•	•	•	•	•	•	•
SW_1	•	•	•	•	•	•	•	•	•	•	•	•	•	•	•	•	•	•	•	•	•	•	•	•	•	•	•	•

Emu Advanced Collection Paint Matrix

Legend

- = Not available
- = Available
- ▶ See specification pages for details.

	4251 Emu Indian Brown	4256 Aluminum	4257 Antique Iron	7234 Emu Black	7271 Emu White	7272 Blue	7273 Green	7294 Emu Grey/Green	7296 Emu Taupe	7297 Emu Corten	7298 Emu Copper	7391 Emu Poppy
Heaven Seating, Tables, and Pouf	•	■	•	■	■	•	•	•	•	•	•	•
Heaven Vases	•	•	•	•	■	•	•	•	•	•	•	•
Ivy Collection	•	•	•	•	■	•	•	•	•	•	•	•
Pattern Collection	•	•	•	■	■	■	■	•	•	•	•	■
Retrouvé Collection	•	•	•	•	■	•	•	•	•	•	•	•
Round Collection	■	•	■	■	■	•	•	•	•	•	•	•

Tip: Select product lines allow for other Emu paint finishes (those shown as not available on the matrix) as an available option. Consult the Coalesse Seating and Outdoor Specification Guide for details.

Surface Materials - Miscellaneous

Convex Vinyl Edge Band

- Applies to:
- Au Lait (includes cast urethane) and E-Table:
- 6000 Black
 - 6607 Woodrose
 - 6609 Smoke
 - 6655 Warm White

Cast Urethane Edge

- Applies to:
- Au Lait
- 6000 Black
 - 6607 Woodrose
 - 6609 Smoke
 - 6655 Warm White

Plastic

- Applies to:
- Enea
- 003 White
 - 0013 Sunset Orange
 - 0014 Clover Green
 - 0015 Sand
 - 0016 Walnut Brown
 - 0017 Cool Grey
 - 0400 Black
 - 0405 Periwinkle
 - 0406 Alabaster
 - 0409 Red
 - 0414 Anthracite Grey
 - 0421 Blue

- Applies to:
- Enea Lottus
- 003 White
 - 0013 Sunset Orange
 - 0014 Clover Green
 - 0015 Sand
 - 0016 Walnut Brown
 - 0017 Cool Grey
 - 0400 Black
 - 0409 Red
 - 0414 Anthracite Grey
 - 0421 Blue
 - 0422 Blue Ink
 - 0423 Ocean
 - 0424 Ice
 - 0425 Olive
 - 0426 Honey
 - 0427 Currant
 - 0428 Saffron

Tip: Not all colors available on all products. Consult the Enea plastic matrix for product line availability.

- Applies to:
- Exponents mobile cart, moby, and mobile display casters
- 6000 Black
 - 6009 Arctic White

- Applies to:
- Lox stools
- 6347 Black Gloss
 - 6348 White Gloss

- Applies to:
- SW_1 tablets, grommet, barrier, wire manager, sub-structure, lounge tablet, Sebastopol grommet
- 6000 Black
 - 6052 Milk

- Applies to:
- Grommet, spheres, flex-gangers, Mini-Port, Interport, casters, horizontal wire manager, and vertical wire manager
- Black plastic

- Applies to:
- Lagunitas focus nook
- 6000 Black
 - 6052 Milk
 - 6D03 Graphite

TAP Power Module Door Finishes

Brushed Anodized Aluminum

- Applies to:
- Host
- 8043 Silver
 - 8044 Black

Utility Bay

- Applies to:
- E-Table 2
- 4137 Matte Black
 - 4745 Nickel Mica
 - 4746 Silver Mica
 - 4747 Charcoal Mica

Glass Doors

- Applies to:
- Host credenzas
 - Frosted glass

Locks

- Applies to:
- Denizen and Exponents
- 9211 Nickel
 - 9250 Ember Chrome

Interior and Plinth

- Applies to:
- Host credenzas
- Black Melamine

Solid

- Applies to:
- Exponents and SW_1 tables
- 2801 Glacier White

Grommet

- Applies to:
- Exponents
- 4135 Black Matte
 - 4141 Platinum Black

Power, Voice Data Modules

- Applies to:
- Exponents
- 4140 Arctic White Gloss
 - 4141 Black Gloss

Glossy Laminate

- Applies to:
- Sebastopol
- 2001 Smoky White Glossy
 - 2002 Studio Grey Glossy
 - 2003 Wrought Iron Glossy
 - 2004 Black Pearl Glossy
 - 2005 Liberty Red Glossy

Ordering

How to Order

Coalesse furniture is available through authorized dealers and retailers. Select products are available for order from our web site. The authorized dealer can help you with everything from surface material selection and order placement, to specialized services, such as space planning and design, delivery and installation. Best of all, they are part of your local community, providing expert advice with a thorough understanding of local needs. For more information and a listing of dealers and retailers, visit www.coalesse.com or call 1.800.627.6770.

Coalesse reserves the right to limit distribution of any or all models.

Credit, Prices, and Terms

Credit may be established upon acceptance of satisfactory references. For payment terms, contact Coalesse's Credit Department. Coalesse may cancel or change credit terms at its discretion and may request advance payment at any time.

The order confirmation will be deemed by the customer and by Coalesse, as the final expression of agreement and will be deemed the exclusive statement of terms. The order confirmation supersedes all prior writings and may not be modified or rescinded, except by a revised Coalesse order confirmation signed by the customer. No changes are binding on Coalesse until delivery of the order confirmation.

Any storage charges and applicable sales taxes are in addition to the prices shown for merchandise. Inside delivery, uncartoning and installation are customer's responsibility unless separately quoted. All list pricing shown includes freight prepaid to one destination for delivery in the 48 contiguous United States. Hawaii and Alaska are not included. We reserve the right to increase prices without notice due to increases in labor and material costs. If timely payment is not made, customer is liable for reasonable collection costs, including attorney's fees.

Shipping and Storage

Coalesse reserves the right to select carrier and packaging method. Partial shipments may be delivered. Coalesse is not liable for delays or delivery failure due to strikes, lockouts, labor, or transportation difficulties, failure or delay of supply sources, accidents, fire, acts of God, or any other cause of like or unlike nature beyond Coalesse's control. Coalesse may transfer merchandise to storage if not accepted when shipment scheduled. Transfer and storage charges will be the customer's expense. Coalesse's invoice is payable upon transfer. If transfer is made prior to confirmed shipping date, storage expenses will be borne by customer.

Shipping charges MAY be calculated per order. Lead-times vary by product. Coalesse reserves the right to select carrier. Partial shipments may be delivered. Coalesse will make every effort to provide current and accurate lead-time information, however, Coalesse is not liable for delays or delivery failure due to strikes, lockouts, labor, or transportation difficulties, failure or delay of supply sources, accidents, fire, acts of God, or any other cause of like or unlike nature beyond Coalesse's control.

Freight is included on domestically manufactured products within the 48 contiguous states of the United States and standard freight service of Carl Hansen & Søn and Emu.

Claims

Merchandise shipped from Coalesse is thoroughly inspected and properly packed before leaving the factory. Responsibility of its safe delivery is assumed by the carrier at the time of shipment. Customer must match the freight delivered with the bill of lading. Customer must examine packaging material upon delivery and note any damage on the carrier bill of lading. If there is damage to the packaging material, inspect the furniture immediately. If concealed damage is found, contact the carrier within 10 days of delivery date. Save all packaging materials until after inspection.

Freight damage and claims must be reported by the purchaser to the carrier. Coalesse is not responsible for freight claims. Claims for loss or damage must not be deducted from our invoice, nor payment withheld awaiting adjustment of such claims. Do not return any merchandise to Coalesse without a Return Authorization number. By following these procedures carefully, Coalesse guarantees our full support of your claims to protect you against loss or damages. All claims against Coalesse for defects, errors or shortages must be made by customer in writing within ten (10) days after delivery. Failure to make claims within ten (10) days constitutes acceptance of merchandise and waives claims. Cutting of textiles deems acceptance of yardage and waives all defects, errors, and shortages. Coalesse is not liable for subsequent damages.

Special/Custom Products

Coalesse prides itself on being responsive to our customer's needs. Contact our Customer Service team at 1.800.627.6770 to discuss a special opportunity. Due to product modifications and engineering time, special orders may not be cancelled. Charges will apply.

FOR MORE INFORMATION (on ordering our products) Please contact Coalesse Customer Service at: 1.800.627.6770.

Order Cancellations/Changes

All order change/cancellation requests must be submitted using the Coalesse order change/cancellation request form. Late changes could jeopardize the committed delivery of an order.

Rapid10 program, no change or cancellations allowed.

Coalesse Products:

- No charges will be assessed for change or cancellation 14 or more calendar days prior to the manufacturing completion date (excludes holidays and/or large quantity project size orders). For import products, charges may apply.

- No manufacturing changes are allowed 0-13 calendar days prior to the manufacturing completion date. Simple changes including shipping address changes are subject to approval but will be accommodated when possible.

- No cancellations or product changes will be accepted for quick ship or special/custom product orders including special laminates. A cancellation fee will be applicable for any custom product and/or change may jeopardize lead time.

- If COM/COL has been received at time of change or cancellation, it is the dealer's responsibility to advise disposition or return of materials. Coalesse will not store materials after 30 days.

Additional Charges

- Changes or cancellations that involve any of the following may be subject to a charge earlier and/or greater than shown above: Special engineering product, CSM, pre-ordered components, materials with extended lead times (e.g., veneers, special paint, etc.) or large quantities of standard materials.

- Use our Order Change/Cancellation Request Form for all order changes. It is Coalesse responsibility to accurately process change order requests. It is the dealer's responsibility to verify that we have accurately interpreted your change requests by checking the acknowledgement after the change has been made. If you do not use the web-based change order form process and an error occurs during our translation which cannot be corrected prior to ship, all costs will be shared on a 50/50 basis. Changing ship dates or adding product to your order is subject to the availability of manufacturing capacity.

- Cartoning changes and shipping address changes are subject to approval and to a change charge. Please consult your Customer Service for specific information pertaining to your order.

Reserved Fabric Policy

Prior to order receipt, reserving textiles (COM/COL, Maharam, Designtex, and select Luna Graded-In) is the responsibility of the dealer. Coalesse cannot reserve textiles based on projected orders. Coalesse cannot guarantee Maharam or Designtex fabric availability. If dealer reserves Maharam or Designtex textiles, Coalesse will require the reserve number and zip code for locating purposes when ordering.

Schedule Enhancements

Coalesse will entertain schedule enhancements on a case-by-case basis; however, please understand that we must receive complete information such as installation date, opening date, etc., to make informed scheduling decisions.

No order move-ups or move-outs are allowed on any order that falls within the 15-working day period of its manufacturing completion date. If it is within the 15-working day period, Coalesse will invoice at shipment but may offer storage options at a charge for manufactured product.

Ordering

Surface Materials

ELMOSOFT, ELMORUSTICAL LEATHER CARE

Only the finest hides are used for Elmo leather. Expect some color variations from hide to hide due to the aniline state of the product. Color fading may occur if leather is exposed to direct or intense light. Care is required to allow this product to achieve the rich natural patina that beautiful natural leather develops. The hallmarks of this leather include some naturally occurring markings, such as healed scars, insect bites, stretch marks, and fat wrinkles. Elmorustical's leather treatment is very natural with little protection from spills or body oils. This rich leather will exhibit stains and oils through normal use. Coalesse is not responsible for discoloration, spotting, or staining on this leather.

Special Color Match Leather

Coalesse can provide a special color match in its leather to any supplier's leather color, paint color, carpet color, wall-paper color, etc. Sample to match must be submitted to Coalesse with purchase order. Sample for approval can be supplied if requested.

Note: Minimum order 2,500 sq. ft.

Special Fabric Applications

(available on GradedIn or Coalesse to purchase orders)

Teflon protection

- Minimum charge:
- 1-30 yards \$125 list
 - 31+ yards \$2.50 list/per yard

Latex backing

- 1-50 yards \$260 list minimum charge
- 50+ yards \$8.00 list/per yard

Tip: Prices subject to change without notice and an additional 2 week lead time will apply for 54" wide fabrics. Wider fabrics will require 4 week additional lead time. Multiple rolls will incur additional charges per roll.

Upholstery

All Coalesse textiles are priced by grades. Some Coalesse fabrics can be treated for flame retardancy, contact Customer Service. All Coalesse products are handcrafted making each unique. Certain fabrics and leathers will appear loose and may differ from like products due to comfort wrinkles when upholstered.

A contrasting welt is available on some products. Consult Customer Service for yardage or square feet requirements and prices. All stripes will be applied vertically unless customer specifies otherwise. Loose cushions on Coalesse products are not fully upholstered (not reversible).

Designtex, Maharam, and select Luna fabrics are graded in our pricing. Simply order Coalesse products with Designtex, Maharam, and select Luna specified. Designtex and Maharam fabrics are graded in on Coalesse products; however, Coalesse does not stock fabrics and can only respond based on Designtex and Maharam lead times. For current grades, refer to Coalesse website: www.Coalesse.com.

Pre-approved CAL 133 Textiles Designtex and Maharam textiles have been graded into our pricing; however, not all textiles are recommended on all seating. For current grade and approval information, please visit our website and click on FABRICEVALUATIONS to obtain grade pricing for a specific pattern.

Wood and Finish Specifications

Solid hardwood is a renewable natural resource, and each section of a tree is unique. The color and grain pattern will vary emphasizing the natural beauty of each product built. Wood is a natural material and will accept stain differently. Coalesse cannot guarantee finished products to be an exact match to finish samples due to the natural characteristics of wood. Light finishes will exhibit some mineral streaks and dark graining due to the natural wood.

The finish used by Coalesse on hardwood frames and occasional tables is pre-catalyzed lacquer which can be easily repaired in the field if damage occurs. Veneer is sanded prior to finish application, and sanded between coats. The lacquer top coat is then polished after final application with wool wax. 4 to 6 layers of finish are applied during the process. The CH process varies from our internal processes.

Coalesse Tables and Casegoods

Coalesse's primary wood finish, Clarity, is a water-borne UV topcoat, which protects the environment while providing exceptional durability and resistance to water and chemical stains. contoured products, such as wood guest chairs & occasional tables, are finished with post-catalyzed vinyl, which provides similar properties and matches the sheen and color of Clarity, due to natural variations in wood, finished products may vary from samples in color, texture, and grain.

Stain-To-Match Program

Coalesse will offer a stain to match program at no additional upcharge for all products with wood finish options.

Customer must supply Coalesse Customer Service with sample to be matched. (internal note - CSR's will have samples of bare wood to compare and define species when applicable that will be used to accomplish the closest stain to match).

Coalesse high sheen will be standard unless specified by customer.

Sheen to match is available as part of the stain/sheen to match program at no upcharge.

Species to match is considered a special and requires to special request to Coalesse Customer Service. Species to match may require an upcharge.

Care and Maintenance

Chrome

Use commercial cleanser and polish, according to manufacturer's directions.

Fabric

Under normal use, clean with soft cloth dampened with water. For spots and spills, we recommend professional cleaning. For COM, refer to the specific cleaning instructions recommended by the fabric supplier.

Emu Outdoor Fabric:

Remove loose dirt with soft bristle brush or hose down with cold water. Clean with mixture of water and mild soap. Rub in mixture with soft brush and allow to thoroughly soak into fabric. Rinse thoroughly with cold water and air dry. Never use water over 100 degrees Fahrenheit. Do not machine dry. For light cleaning, avoid using detergents.

For stubborn stains use mixture of one gallon cold water, 1/2 cup bleach and 1/4 cup mild soap for one hour.

Detergents can be used without harm, though they may remove some of the water and stain resistant properties in the fabric.

SW_1 Knit:

Clean with warm water and soap. Wet sponge and wipe fabric. Household cleaners such as Windex™ may be used. Do NOT use cleaners containing bleach.

Laminate and solid phenolic

should be cleaned with soap and water. For stubborn stains, use a non-abrasive household cleaner.

SW_1 Tablet

surfaces clean with soft cloth dampened with water and soap, if needed. The use of general purpose cleaners are acceptable but must be void of citric content that has z-butoxyethanol in the formulation listing.

Cleaning Laminate

Markerboard Surface

Use dry erase markers only. Remove dry-erase markings with a markerboard eraser or soft cloth as often as possible. Change erasers, as they become dirty. Dirty erasers will leave ink residue on the surface.

For daily cleaning, or as needed, use a dry erase cleaner, or a non-abrasive household cleaner, such as glass cleaner. This may be done with a soft cloth or sponge. Dry the surface with a soft cloth prior to writing. All markings should be removed weekly.

Caution:

- Do not use permanent markers on markerboard surfaces. In the event a permanent marker is used, removal of markings may be attempted by using dry erase cleaner, or by writing over the marking with a dry erase marker and erasing with a markerboard eraser or soft cloth.
- Do not use abrasive cleaners or solvent type cleaning solutions, such as Ketones (Acetone, MEK, etc.) lacquer thinner, nail polish remover, etc. because they may remove the finish from the markerboard surface.

Cleaning CeramicSteel

Markerboard Surface

- Care and maintenance applies to both a³ CeramicSteel and e³ CeramicSteel.
- Wipe board with a clean cloth moistened by a liquid markerboard cleaner or a solution of 50% water and 50% isopropyl alcohol.
- Rinse with clear water.
- Wipe dry with a clean cloth. If your board is used daily, the cleaning should be performed at least 2-3 times a week.

More thorough cleaning may be required if writing is left on the board for more than two days.

Markers

Use any high-quality dry erase marker.

CAUTION! The use of Low Odor markers may cause ghosting to occur. If Low Odor markers have been used, the surface can be completely cleaned by following the cleaning instructions above. Remember to discard eraser if used with Low Odor markers.

Removing Permanent Marker

Option 1:

- Write over the top of the permanent marker ink with a dry-erase marker
- Simply erase

Option 2:

- Moisten a clean, dry cloth with isopropyl alcohol
- Wipe the board in a circular motion to loosen marker residue
- Rinse with clear water
- Dry the board with a clean cloth
- Repeat these steps as necessary

Installer's Instructions for Initial Cleaning at Time of Installation

NOTE: These initial cleaning instructions are shipped with every board.

- For initial cleaning, wipe your board with a clean cloth moistened by a mild, alcohol-based cleaner.
- Rinse with clear water. This step is simple, but very important.
- Wipe dry with a clean cloth.

Leather

Under normal use, regular dusting and vacuum cleaning are all that is necessary. For spots and spills, wipe excess liquid immediately. If necessary, use lukewarm water cleaning the entire area where spot occurred and air dry. For stubborn spots or stains, use a solution of mild non-detergent soap and air dry. For butter, oil, or grease, wipe excess with dry cloth and then leave alone. The spot will dissipate into the leather. Do not apply water.

Faux Leather

Under normal use, clean with soft cloth dampened with water. For spots and stains, use the recommended mixture of Woolite and water. Rinse with clean water and air dry.

Granite/Glass

Under normal use, clean with Windex and soft cotton cloth.

Powder coat finishes on chairs and table bases

should be cleaned with a liquid detergent and water. Remove stubborn stains with liquid cleanser, such as Formula 409.

Emu Outdoor Paint:

Store in an enclosed and dry area during winter to avoid condensation. Before winter and regularly every quarter, clean the metal surfaces with a cloth dipped in water or detergent and protect them with vasoline oil or car polish. Do not use ethyl alcohol or detergents that contain even in small quantities acetone, trichloroethylene, or ammonia (or solvents in general). When storing tables, do not stack them or put the table tops in direct contact with each other. Handle the seats with care when stacking them to avoid damaging the varnished surfaces.

Polished Aluminum finishes

on table bases should be cleaned with a commercial powder, liquid, or paste metal cleaner and polish. Follow the manufacturer's directions.

Veneers and painted MDF

should be cleaned regularly with mild soap and water and dried with a soft cloth. *Tip: Never use ammonia-based cleaners or wax on wood surfaces.*

Veneers should be cleaned regularly with mild soap and water and dried with a soft cloth.

Tip: Never use ammonia-based cleaners or wax on wood surfaces.

Protecting Wood Surfaces

Use desk pads and coasters to help protect the finish against dents, scratches, moisture and hot and cold liquids. Do not use desk pads that have plastic backing. Use felt or leather pads on the bottoms of office equipments and accessories.

Periodically move desk accessories and other objects kept on the worksurface to ensure even aging.

Lift objects when you move them, instead of pulling or pushing them across the surface, to avoid scratching the surface. Avoid leaving vinyl binders on worksurface for long periods.

If you use a protective glass top, insert felt pads between the glass and the worksurface to create an air space and allow the wood to breathe.

Keep your furniture away from direct sunlight. Avoid extreme temperatures and humidity. Maintain temperatures between 60 and 80 degrees Fahrenheit and humidity levels between 30 and 50 percent.

Cleaning Wood Surfaces

Keep a supply of soft, clean, absorbent cloths handy for wiping up spills and regular dusting.

To dust, wipe with a slightly damp, soft cloth, using another soft cloth to dry. Always wipe the surface in the direction of the woodgrain.

Use a quality cleaner or flax soap formulated especially for use on wood surfaces. Do not use oils or ammonia. Dilute the cleaner as directed by the manufacturer. Dampen but do not saturate a soft cloth with the diluted cleaning solution. Wipe the surface in the direction of the woodgrain to remove dirt and fingerprints. Wipe the surface clean with a soft, dry cloth.

Care and Maintenance

Vinyl

Under normal use, clean with soft cloth dampened with mild soap solution. For stubborn stains and spills, a sponge or soft brush may be used with mild non-abrasive cleaner.

Transolid/Corian:

Clean regularly with mild soap and water. Dry with a soft cloth.

Tables should be inspected and maintained regularly by tightening screws and bolts, inspecting casters and glides for damage, and inspecting all moving parts for damage and wear.

Resources

Style Number Index

390

Style Number Index

Style Number	Page	Description	Style Number	Page	Description
100-T1	70	Bob Round Occasional Table	50632625	287	Reunion 30"W Rect Seminar
100-T2	70	Bob Round Occasional Table	50632655	291	Reunion 30"W Rect Seminar
100-T3	71	Bob Round Occasional Table	50633625	288	Reunion 36"W Rect Seminar
100-T4	71	Bob Round Occasional Table	50633655	292	Reunion 36"W Rect Seminar
105-T1	71	Bob Round Conference Dining Table	50641625	287	Reunion 24"W Rect Seminar
105-T2	71	Bob Round Conference Dining Table	50641655	291	Reunion 24"W Rect Seminar
105-T3	72	Bob Round Conference Dining Table	50642625	287	Reunion 30"W Rect Seminar
105-T4	72	Bob Round Conference Dining Table	50642655	291	Reunion 30"W Rect Seminar
321891	101	Train Receptacle, Circuit 1	50643625	288	Reunion 36"W Rect Seminar
321892	101	Train Receptacle, Circuit 2	50643655	292	Reunion 36"W Rect Seminar
321893	101	Train Receptacle, Circuit 3	51091000	302	Reunion 90° Connect Top
321894	101	Train Receptacle, Circuit 4	51092000	302	Reunion 90° Connect Top
321899	108	Wall Jack/Faceplate	51093000	302	Reunion 90° Connect Top
39-2424	85	Switch Square	51421625	298	Reunion 60° Trapezoid Seminar
39-2442	85	Switch Rectangle	51421655	299	Reunion 60° Trapezoid Seminar
39-3636	85	Switch Square	51432625	298	Reunion 60° Trapezoid Seminar
44-T164830	84	Passerelle Occasional Table	51432655	299	Reunion 60° Trapezoid Seminar
44-T242417	84	Passerelle Occasional Table	793215	20	Grommet
44-T242421	84	Passerelle Occasional Table	793330	29, 68, 110, 284	Power Strip
47-T1326C	73	Diekman Wood Table	793332	68	Ballet Vertical Wire Mgr
47-T1623A	73	Diekman Wood Table	793333	69, 304	Ballet Mobile Strg Cart
47-T1623B	73	Diekman Wood Table	793335	68, 303	Bar Ganger Package
47-T17ELG	73	Diekman Wood Table	793365	303	Flex Ganger Package
47-T17RG1	73	Diekman Wood Table	793369	161	Floor Monument Kit
47-T2217E	73	Diekman	793442	30, 303	Horizontal Wire Mngr
47-T23EL	73	Diekman	793448	30, 303	Horizontal Wire Mngr
47-T2617D	73	Diekman	793460	30, 303	Horizontal Wire Mngr
50348625	300	Reunion Half Round Seminar	793472	30, 303	Horizontal Wire Mngr
50348655	301	Reunion Half Round Seminar	793742	304	Reunion Seminar Modsty Pnl
50360625	300	Reunion Half Round Seminar	793748	304	Reunion Seminar Modsty Pnl
50360655	301	Reunion Half Round Seminar	793760	304	Reunion Seminar Modsty Pnl
50372625	300	Reunion Half Round Seminar	793772	304	Reunion Seminar Modsty Pnl
50372655	301	Reunion Half Round Seminar	793893	30, 48	Vertical Wire Manager
50436625	295	Reunion Square Seminar	802511	61	Ballet Folding K-Base
50436655	297	Reunion Square Seminar	802561	61	Ballet Folding K-Base
50442625	295	Reunion Square Seminar	803512	61	Ballet Folding K-Base
50442655	297	Reunion Square Seminar	803562	61	Ballet Folding K-Base
50448625	295	Reunion Square Seminar	804513	61	Ballet Folding K-Base
50448655	297	Reunion Square Seminar	804563	61	Ballet Folding K-Base
50460625	295	Reunion Square Seminar	809000	67	Ballet Connecting Top
50460655	297	Reunion Square Seminar	814412	57	Ballet Folding X-Base
50611625	287	Reunion 24"W Rect Seminar	814462	57	Ballet Folding X-Base
50611655	291	Reunion 24"W Rect Seminar	815413	57	Ballet Folding X-Base
50612625	287	Reunion 24"W Rect Seminar	815463	57	Ballet Folding X-Base
50612655	291	Reunion 24"W Rect Seminar	816414	57	Ballet Folding X-Base
50613625	288	Reunion 36"W Rect Seminar	816464	57	Ballet Folding X-Base
50613655	292	Reunion 36"W Rect Seminar	823411	57	Ballet Folding X-Base
50621625	287	Reunion 30"W Rect Seminar	823461	57	Ballet Folding X-Base
50621655	291	Reunion 30"W Rect Seminar	824412	57	Ballet Folding X-Base
50622625	287	Reunion 30"W Rect Seminar	824462	57	Ballet Folding X-Base
50622655	291	Reunion 30"W Rect Seminar	825413	57	Ballet Folding X-Base
50623625	288	Reunion 36"W Rect Seminar	825463	57	Ballet Folding X-Base
50623655	292	Reunion 36"W Rect Seminar	826414	57	Ballet Folding X-Base
50631625	287	Reunion 24"W Rect Seminar	826464	57	Ballet Folding X-Base
50631655	291	Reunion 24"W Rect Seminar	834402	59	Ballet Non-Folding X-Base

Style Number Index

Style Number	Page	Description	Style Number	Page	Description
834452	59	Ballet Non-Folding X-Base	912501	66	Ballet Non-Folding K-Base
835403	59	Ballet Non-Folding X-Base	912551	66	Ballet Non-Folding K-Base
835453	59	Ballet Non-Folding X-Base	913502	66	Ballet Non-Folding K-Base
836404	59	Ballet Non-Folding X-Base	913552	66	Ballet Non-Folding K-Base
836454	59	Ballet Non-Folding X-Base	914503	66	Ballet Non-Folding K-Base
842511	61	Ballet Folding K-Base	914553	66	Ballet Non-Folding K-Base
842561	61	Ballet Folding K-Base	915405	51	Ballet Arc
843512	61	Ballet Folding K-Base	915415	51	Ballet Arc
843562	61	Ballet Folding K-Base	916406	51	Ballet Arc
844513	61	Ballet Folding K-Base	916416	51	Ballet Arc
844563	61	Ballet Folding K-Base	919423C	52	Ballet Non-Folding Side
849000	67	Ballet Connecting Top	920424C	52	Ballet Non-Folding Side
853411	56	Ballet Folding X-Base	926421	54	Ballet Sqr Pedestal Base
853461	56	Ballet Folding X-Base	927422	54	Ballet Pedestal
854412	56	Ballet Folding X-Base	933421	53	Ballet Rnd Pedestal Base
854462	56	Ballet Folding X-Base	933421T	50	Ballet Round Café
855413	56	Ballet Folding X-Base	934421	53	Ballet Rnd Pedestal Base
855463	56	Ballet Folding X-Base	934422T	50	Ballet Round Café
856414	56	Ballet Folding X-Base	AL2424SC	44	Au Lait Square Table Solid Core Top
856464	56	Ballet Folding X-Base	AL2424USC	44	Au Lait Square Table Solid Core Top
862501	65	Ballet Non-Folding K-Base	AL2430SC	46	Au Lait Rect Solid Core Top
862551	65	Ballet Non-Folding K-Base	AL2430USC	46	Au Lait Rect Solid Core Top
863502	65	Ballet Non-Folding K-Base	AL2436SC	46	Au Lait Rect Solid Core Top
863552	65	Ballet Non-Folding K-Base	AL2436USC	46	Au Lait Rect Solid Core Top
864503	65	Ballet Non-Folding K-Base	AL3000SC	42	Au Lait Round Table Solid Core Top
864553	65	Ballet Non-Folding K-Base	AL3000USC	42	Au Lait Round Table Solid Core Top
873401	58	Ballet Non-Folding X-Base	AL3030SC	44	Au Lait Square Table Solid Core Top
873451	58	Ballet Non-Folding X-Base	AL3030USC	44	Au Lait Square Table Solid Core Top
874402	58	Ballet Non-Folding X-Base	AL3036SC	46	Au Lait Rect Solid Core Top
874452	58	Ballet Non-Folding X-Base	AL3036USC	47	Au Lait Rect Solid Core Top
875403	58	Ballet Non-Folding X-Base	AL3042MC	47	Au Lait Rect Solid Core Top
875453	58	Ballet Non-Folding X-Base	AL3042UMC	47	Au Lait Rect Solid Core Top
876404	58	Ballet Non-Folding X-Base	AL3600SC	43	Au Lait Round Table Solid Core Top
876454	58	Ballet Non-Folding X-Base	AL3600USC	43	Au Lait Round Table Solid Core Top
883401	59	Ballet Non-Folding X-Base	AL3636MC	45	Au Lait Square Table Solid Core Top
883451	59	Ballet Non-Folding X-Base	AL3636UMC	45	Au Lait Square Table Solid Core Top
884402	59	Ballet Non-Folding X-Base	AL4200MC	43	Au Lait Round Table Solid Core Top
884452	59	Ballet Non-Folding X-Base	AL4200UMC	43	Au Lait Round Table Solid Core Top
885403	59	Ballet Non-Folding X-Base	ALB2424SC	44	Au Lait Square Table Solid Core Top
885453	59	Ballet Non-Folding X-Base	ALB2424USC	44	Au Lait Square Table Solid Core Top
886404	59	Ballet Non-Folding X-Base	ALB3000SC	43	Au Lait Round Table Solid Core Top
886454	59	Ballet Non-Folding X-Base	ALB3000USC	43	Au Lait Round Table Solid Core Top
892501	65	Ballet Non-Folding K-Base	ALB3030MC	45	Au Lait Square Table Solid Core Top
892551	65	Ballet Non-Folding K-Base	ALB3030USC	45	Au Lait Square Table Solid Core Top
893502	65	Ballet Non-Folding K-Base	ALB3600MC	43	Au Lait Round Table Solid Core Top
893552	65	Ballet Non-Folding K-Base	ALB3600UMC	43	Au Lait Round Table Solid Core Top
894503	65	Ballet Non-Folding K-Base	ALB3636MC	45	Au Lait Square Table Solid Core Top
894553	65	Ballet Non-Folding K-Base	ALB3636UMC	45	Au Lait Square Table Solid Core Top
902511	62	Ballet Folding K-Base	ALCASTER	48	Au Lait Caster
902561	62	Ballet Folding K-Base	ALGLIDE	48	Au Lait Glide
903512	62	Ballet Folding K-Base	ALW2424SC	44	Au Lait Square Table Solid Core Top
903562	62	Ballet Folding K-Base	ALW2424USC	44	Au Lait Square Table Solid Core Top
904513	62	Ballet Folding K-Base	ALW2430SC	46	Au Lait Rect Solid Core Top
904563	62	Ballet Folding K-Base	ALW2430USC	46	Au Lait Rect Solid Core Top
909000	67	Ballet Connecting Top	ALW2436SC	46	Au Lait Rect Solid Core Top

Style Number Index *continued*

Style Number	Page	Description	Style Number	Page	Description
ALW2436USC	46	Au Lait Rect Solid Core Top	COMOTL2020	83	Millbrae Side Table
ALW3000SC	42	Au Lait Round Table Solid Core Top	COMOTL2054	83	Millbrae Rectangular Table
ALW3000USC	42	Au Lait Round Table Solid Core Top	COMOTL3030	83	Millbrae Square Table
ALW3030SC	45	Au Lait Square Table Solid Core Top	COMOTL3060	83	Millbrae Rectangular Table
ALW3030USC	45	Au Lait Square Table Solid Core Top	COMOTL3636	83	Millbrae Square Table
ALW3036SC	47	Au Lait Rect Solid Core Top	COMOTL4848	83	Millbrae Square Table
ALW3036USC	47	Au Lait Rect Solid Core Top	COSFZCTRD	91	Montara650 Café-Height Table
ALW3042MC	47	Au Lait Rect Solid Core Top	COSFZCTSQ	91	Montara650 Café-Height Table
ALW3042UMC	47	Au Lait Rect Solid Core Top	COSFZOTRD	92	Montara650 Occasional Table
ALW3600SC	43	Au Lait Round Table Solid Core Top	COSFZOTSQ	92	Montara650 Occasional Table
ALW3600USC	43	Au Lait Round Table Solid Core Top	COSFZWTRD	89	Montara650 Work-Height Table
ALW3636MC	45	Au Lait Square Table Solid Core Top	COSFZWTSQ	89	Montara650 Work-Height Table
ALW3636UMC	45	Au Lait Square Table Solid Core Top	COW_RC4284	312	SW_1 Rectangular Conference Table
ALW4200MC	43	Au Lait Round Table Solid Core Top	COW_RC48120	312	SW_1 Rectangular Conference Table
ALW4200UMC	43	Au Lait Round Table Solid Core Top	COW_RC48122	312	SW_1 Rectangular Conference Table
COBPIFMH	28, 109	Two-Circuit Hdwr Base Pwr Infeed	COW_RC48144	312	SW_1 Rectangular Conference Table
COBPIFMP20	28, 109	Single-Circuit 20-Amp Plug Base Pwr Infeed	COW_RC4896	312	SW_1 Rectangular Conference Table
COC1MBWMS	347	Mobile Mediaboard Dsp. w/SC media:scape Tech.	COW_RND30	314	SW_1 Round Table
COCCD303219	327	Exponents Mobile Cart	COW_RND36	314	SW_1 Round Table
COCCMAS30	327, 329	Exponents Adjustable Shelf	COW_RND42	314	SW_1 Round Table
COCL42	343	Exponents Lectern	COW_RND48	314	SW_1 Round Table
COCMBSHLF	345, 347	Eponents Shelf	COW_RND60	311	SW_1 Conference Table
COCMBW	345	Mobile Mediaboard Display	COW_RND72	311	SW_1 Conference Table
COCMD304219	329	Exponents Moby	COW_RND84	311	SW_1 Conference Table
COCWBN	344	Mobile Whiteboard Display	COW_RND96	311	SW_1 Conference Table
COCWBW	344	Mobile Whiteboard Display	COW_RT3060	318	SW_1 Rectangular Work Table
COCZAS48	337, 342	Adjustable Shelf for 48"W Credenza	COW_RT3072	318	SW_1 Rectangular Work Table
COCZASEND72	337, 342	Adjustable Shelf for 72"W Credenza, End	COW_RT3660	318	SW_1 Rectangular Work Table
COCZASEND96	338, 342	Adjustable Shelf for 96"W Credenza, End	COW_RT3672	318	SW_1 Rectangular Work Table
COCZASMD72	337, 342	Adjustable Shelf for 72"W Credenza, Middle	COW_SE4060	318	SW_1 Super-Elliptical Work Table
COCZASMD96	338, 342	Adjustable Shelf for 96"W Credenza, Middle	COW_SE4072	318	SW_1 Super-Elliptical Work Table
COCZBDC184815	332	Exponents Bench with Doors	COW_SEC120	313	SW_1 Super Elliptical Conference Table
COCZBDC187215	332	Exponents Bench with Doors	COW_SEC122	313	SW_1 Super Elliptical Conference Table
COCZBDC189615	332	Exponents Bench with Doors	COW_SEC144	313	SW_1 Super Elliptical Conference Table
COCZBE182415	333	Exponents End-of-Run Bench Bridge	COW_SEC168	313	SW_1 Super Elliptical Conference Table
COCZBI182415	333	Exponents In-Line Bench Bridge	COW_SEC192	313	SW_1 Super Elliptical Conference Table
COCZBOC184815	332	Exponents Open Bench	COW_SEC213	313	SW_1 Super Elliptical Conference Table
COCZBOC187215	332	Exponents Open Bench	COW_SEC216	313	SW_1 Super Elliptical Conference Table
COCZBOC189615	332	Exponents Open Bench	COW_SEC240	313	SW_1 Super Elliptical Conference Table
COCZD254827	337	Exponents Credenza 27"H	COW_SEC243	313	SW_1 Super Elliptical Conference Table
COCZD257227	337	Exponents Credenza 27"H	COW_SEC84	313	SW_1 Super Elliptical Conference Table
COCZD259627	337	Exponents Credenza 27"H	COW_SEC96	313	SW_1 Super Elliptical Conference Table
COCZDO257227	337	Exponents Credenza 27"H	COW_SQ30	314	SW_1 Square Table
COCZDO259627	337	Exponents Credenza 27"H	COW_SQ36	314	SW_1 Square Table
COCZUD254839	342	Exponents Credenza 39"H	COW_SQ42	314	SW_1 Square Table
COCZUD257239	342	Exponents Credenza 39"H	COW_SQ60	311	SW_1 Conference Table
COCZUD259639	342	Exponents Credenza 39"H	COW_SQ72	311	SW_1 Conference Table
CODHA4	25, 104	Axil Z, Hardwire	COW_SQ84	311	SW_1 Conference Table
CODHE4	27, 106	Ellora, Hardwire	COW_SQ96	311	SW_1 Conference Table
CODPA4	24, 103	Axil Z, Hardwire	COW_SSQ45	314	SW_1 Super-Square Table
CODPE4	26, 105	Ellora, Hardwire	COWHWM	319	SW_1 Horizontal Wire Manager Clips
COLAGTO	81	Lagunitas Occasional Table	COWO_RND30	317	SW_1 Round Occasional Table
COLAGTP	82	Lagunitas Personal Table	COWO_RND36	317	SW_1 Round Occasional Table
COLAGTRECT	80	Lagunitas Work Table	COWO_RND42	317	SW_1 Round Occasional Table
COLAGTW	80	Work Tables	COWO_RND48	317	SW_1 Round Occasional Table

Style Number Index

Style Number	Page	Description	Style Number	Page	Description
COWO_RND60	317	SW_1 Occasional Table	E2C9636A	132	E-Table 2 Racetrack
COWO_SQ30	317	SW_1 Square Occasional Table	E2C9642A	132	E-Table 2 Racetrack
COWO_SQ36	317	SW_1 Square Occasional Table	E2C9648L	137	E-Table 2 Racetrack
COWO_SQ42	317	SW_1 Square Occasional Table	E2C9654L	137	E-Table 2 Racetrack
COWO_SQ60	317	SW_1 Occasional Table	E2C9660L	137	E-Table 2 Racetrack
COWO_SSQ45	317	SW_1 Super-Square Occasional Table	E2F1048L	139	E-Table 2 Faceted
COWVWM26	319	SW_1 Vertical Wire Manager	E2F1054L	139	E-Table 2 Faceted
COWVWM28	319	SW_1 Vertical Wire Manager	E2F1060L	139	E-Table 2 Faceted
COWX_Q42	307	SW_1 Square Low Coll Conf Tbl	E2F1248L	139	E-Table 2 Faceted
COWX_R4120	308	SW_1 Rectangular Low Coll Conf Tbl	E2F1254L	139	E-Table 2 Faceted
COWX_R4284	308	SW_1 Rectangular Low Coll Conf Tbl	E2F1260L	139	E-Table 2 Faceted
COWX_RND60	307	SW_1 Low Collaborative Conference Table	E2F1448L	145	E-Table 2 Faceted
COWX_RND72	307	SW_1 Low Collaborative Conference Table	E2F1454L	145	E-Table 2 Faceted
COWX_RND84	307	SW_1 Low Collaborative Conference Table	E2F1460L	145	E-Table 2 Faceted
COWX_RND96	307	SW_1 Low Collaborative Conference Table	E2F1648L	145	E-Table 2 Faceted
COWX_SE4072	308	SW_1 Super Elliptical Low Coll Conf Tbl	E2F1654L	146	E-Table 2 Faceted
COWX_SE4084	308	SW_1 Super Elliptical Low Coll Conf Tbl	E2F1660L	146	E-Table 2 Faceted
COWX_SE4096	308	SW_1 Super Elliptical Low Coll Conf Tbl	E2F1848L	146	E-Table 2 Faceted
COWX_SE4120	308	SW_1 Super Elliptical Low Coll Conf Tbl	E2F1854L	146	E-Table 2 Faceted
COWX_SE4122	308	SW_1 Super Elliptical Low Coll Conf Tbl	E2F1860L	146	E-Table 2 Faceted
COWX_SQ60	307	SW_1 Low Collaborative Conference Table	E2F2048L	146	E-Table 2 Faceted
COWX_SQ72	307	SW_1 Low Collaborative Conference Table	E2F2054L	146	E-Table 2 Faceted
COWX_SQ84	307	SW_1 Low Collaborative Conference Table	E2F2060L	146	E-Table 2 Faceted
COWX_SQ96	307	SW_1 Low Collaborative Conference Table	E2F2248L	152	E-Table 2 Faceted
CSP	21	Communications Sphere	E2F2254L	152	E-Table 2 Faceted
E2C1048L	137	E-Table 2 Racetrack	E2F2260L	152	E-Table 2 Faceted
E2C1054L	137	E-Table 2 Racetrack	E2F2448L	153	E-Table 2 Faceted
E2C1060L	137	E-Table 2 Racetrack	E2F2454L	153	E-Table 2 Faceted
E2C1248L	138	E-Table 2 Racetrack	E2F2460L	153	E-Table 2 Faceted
E2C1254L	138	E-Table 2 Racetrack	E2F7236A	132	E-Table 2 Faceted
E2C1260L	138	E-Table 2 Racetrack	E2F7242A	132	E-Table 2 Faceted
E2C1448L	143	E-Table 2 Racetrack	E2F7248A	132	E-Table 2 Faceted
E2C1454L	143	E-Table 2 Racetrack	E2F8436A	132	E-Table 2 Faceted
E2C1460L	143	E-Table 2 Racetrack	E2F8442A	132	E-Table 2 Faceted
E2C1648L	144	E-Table 2 Racetrack	E2F8448A	132	E-Table 2 Faceted
E2C1654L	144	E-Table 2 Racetrack	E2F9636A	133	E-Table 2 Faceted
E2C1660L	144	E-Table 2 Racetrack	E2F9642A	133	E-Table 2 Faceted
E2C1848L	144	E-Table 2 Racetrack	E2F9648L	138	E-Table 2 Faceted
E2C1854L	144	E-Table 2 Racetrack	E2F9654L	138	E-Table 2 Faceted
E2C1860L	144	E-Table 2 Racetrack	E2F9660L	138	E-Table 2 Faceted
E2C2048L	145	E-Table 2 Racetrack	E2R1048L	140	E-Table 2 Rectangle
E2C2054L	145	E-Table 2 Racetrack	E2R1054L	140	E-Table 2 Rectangle
E2C2060L	145	E-Table 2 Racetrack	E2R1060L	140	E-Table 2 Rectangle
E2C2248L	151	E-Table 2 Racetrack	E2R1248L	140	E-Table 2 Rectangle
E2C2254L	151	E-Table 2 Racetrack	E2R1254L	140	E-Table 2 Rectangle
E2C2260L	151	E-Table 2 Racetrack	E2R1260L	140	E-Table 2 Rectangle
E2C2448L	152	E-Table 2 Racetrack	E2R1448L	147	E-Table 2 Rectangle
E2C2454L	152	E-Table 2 Racetrack	E2R1454L	147	E-Table 2 Rectangle
E2C2460L	152	E-Table 2 Racetrack	E2R1460L	147	E-Table 2 Rectangle
E2C7236A	131	E-Table 2 Racetrack	E2R1648L	147	E-Table 2 Rectangle
E2C7242A	131	E-Table 2 Racetrack	E2R1654L	147	E-Table 2 Rectangle
E2C7248A	131	E-Table 2 Racetrack	E2R1660L	147	E-Table 2 Rectangle
E2C8436A	131	E-Table 2 Racetrack	E2R1848L	147	E-Table 2 Rectangle
E2C8442A	131	E-Table 2 Racetrack	E2R1854L	147	E-Table 2 Rectangle
E2C8448A	131	E-Table 2 Racetrack	E2R1860L	148	E-Table 2 Rectangle

Style Number Index *continued*

Style Number	Page	Description	Style Number	Page	Description
E2R2048L	148	E-Table 2 Rectangle	E2S9648L	141	E-Table 2 Soft Radius End
E2R2054L	148	E-Table 2 Rectangle	E2S9654L	141	E-Table 2 Soft Radius End
E2R2060L	148	E-Table 2 Rectangle	E2S9660L	141	E-Table 2 Soft Radius End
E2R2248L	153	E-Table 2 Rectangle	E2T1036A	157	E-Table 2 Trapezoid
E2R2254L	153	E-Table 2 Rectangle	E2T1048L	160	E-Table 2 Trapezoid
E2R2260L	153	E-Table 2 Rectangle	E2T1236A	157	E-Table 2 Trapezoid
E2R2448L	153	E-Table 2 Rectangle	E2T1248L	160	E-Table 2 Trapezoid
E2R2454L	154	E-Table 2 Rectangle	E2T1436A	157	E-Table 2 Trapezoid
E2R2460L	154	E-Table 2 Rectangle	E2T1448L	160	E-Table 2 Trapezoid
E2R7236A	133	E-Table 2 Rectangle	E2T9636A	157	E-Table 2 Trapezoid
E2R7242A	133	E-Table 2 Rectangle	E2T9648L	160	E-Table 2 Trapezoid
E2R7248A	133	E-Table 2 Rectangle	E2TK	161	E-Table 2 Transformer Kit
E2R8436A	133	E-Table 2 Rectangle	H35-T2436L	77	Enea Table Single Base
E2R8442A	133	E-Table 2 Rectangle	H35-T2436W	77	Enea Table Single Base
E2R8448A	133	E-Table 2 Rectangle	H35-T2442L	77	Enea Table Single Base
E2R9636A	134	E-Table 2 Rectangle	H35-T2442W	77	Enea Table Single Base
E2R9642A	134	E-Table 2 Rectangle	H35-T3030L	76	Enea Table Single Base
E2R9648L	139	E-Table 2 Rectangle	H35-T3030W	76	Enea Table Single Base
E2R9654L	140	E-Table 2 Rectangle	H35-T3036L	77	Enea Table Single Base
E2R9660L	140	E-Table 2 Rectangle	H35-T3036W	77	Enea Table Single Base
E2RND48L	129	E-Table 2 48" Dia Round Table	H35-T3042L	77	Enea Table Single Base
E2RND54L	129	E-Table 2 54" Dia Round Table	H35-T3042W	77	Enea Table Single Base
E2RND60L	129	E-Table 2 60" Dia Round Table	H35-T307230GL	78	Enea Table Twin Base
E2S1048L	141	E-Table 2 Soft Radius End	H35-T307230GW	78	Enea Table Twin Base
E2S1054L	141	E-Table 2 Soft Radius End	H35-T307230KL	79	Enea Table Twin Base
E2S1060L	141	E-Table 2 Soft Radius End	H35-T307230KW	79	Enea Table Twin Base
E2S1248L	141	E-Table 2 Soft Radius End	H35-T307230VL	79	Enea Table Twin Base
E2S1254L	141	E-Table 2 Soft Radius End	H35-T307230VW	79	Enea Table Twin Base
E2S1260L	141	E-Table 2 Soft Radius End	H35-T307236GL	78	Enea Table Twin Base
E2S1448L	148	E-Table 2 Soft Radius End	H35-T307236GW	78	Enea Table Twin Base
E2S1454L	148	E-Table 2 Soft Radius End	H35-T307236KL	79	Enea Table Twin Base
E2S1460L	148	E-Table 2 Soft Radius End	H35-T307236KW	79	Enea Table Twin Base
E2S1648L	148	E-Table 2 Soft Radius End	H35-T307236VL	79	Enea Table Twin Base
E2S1654L	149	E-Table 2 Soft Radius End	H35-T307236VW	79	Enea Table Twin Base
E2S1660L	149	E-Table 2 Soft Radius End	H35-T307242GL	78	Enea Table Twin Base
E2S1848L	149	E-Table 2 Soft Radius End	H35-T307242GW	78	Enea Table Twin Base
E2S1854L	149	E-Table 2 Soft Radius End	H35-T307242KL	79	Enea Table Twin Base
E2S1860L	149	E-Table 2 Soft Radius End	H35-T307242KW	79	Enea Table Twin Base
E2S2048L	149	E-Table 2 Soft Radius End	H35-T307242VL	79	Enea Table Twin Base
E2S2054L	149	E-Table 2 Soft Radius End	H35-T307242VW	79	Enea Table Twin Base
E2S2060L	149	E-Table 2 Soft Radius End	H35-T3618L	76	Enea Table Single Base
E2S2248L	154	E-Table 2 Soft Radius End	H35-T3618W	76	Enea Table Single Base
E2S2254L	154	E-Table 2 Soft Radius End	H35-T3630L	76	Enea Table Single Base
E2S2260L	154	E-Table 2 Soft Radius End	H35-T3630W	76	Enea Table Single Base
E2S2448L	154	E-Table 2 Soft Radius End	H35-T3636L	77	Enea Table Single Base
E2S2454L	154	E-Table 2 Soft Radius End	H35-T3636W	77	Enea Table Single Base
E2S2460L	154	E-Table 2 Soft Radius End	H35-T3642L	77	Enea Table Single Base
E2S7236A	134	E-Table 2 Soft Radius End	H35-T3642W	77	Enea Table Single Base
E2S7242A	134	E-Table 2 Soft Radius End	H35-T4218L	76	Enea Table Single Base
E2S7248A	134	E-Table 2 Soft Radius End	H35-T4218W	76	Enea Table Single Base
E2S8436A	134	E-Table 2 Soft Radius End	H35-T4230L	76	Enea Table Single Base
E2S8442A	134	E-Table 2 Soft Radius End	H35-T4230W	76	Enea Table Single Base
E2S8448A	134	E-Table 2 Soft Radius End	H35-T4236L	77	Enea Table Single Base
E2S9636A	135	E-Table 2 Soft Radius End	H35-T4236W	77	Enea Table Single Base
E2S9642A	135	E-Table 2 Soft Radius End	HS1048C10	227	Host Racetrack

Style Number Index

Style Number	Page	Description	Style Number	Page	Description
HS1048C11	227	Host Racetrack	HS1248C10	231	Host Racetrack
HS1048C12	227	Host Racetrack	HS1248C11	231	Host Racetrack
HS1048C13	227	Host Racetrack	HS1248C12	231	Host Racetrack
HS1048C20	228	Host Racetrack	HS1248C13	231	Host Racetrack
HS1048C21	228	Host Racetrack	HS1248C20	232	Host Racetrack
HS1048C22	228	Host Racetrack	HS1248C21	232	Host Racetrack
HS1048R10	168	Host Rectangular	HS1248C22	232	Host Racetrack
HS1048R11	168	Host Rectangular	HS1248R10	171	Host Rectangular
HS1048R12	168	Host Rectangular	HS1248R11	171	Host Rectangular
HS1048R13	169	Host Rectangular	HS1248R12	171	Host Rectangular
HS1048R20	169	Host Rectangular	HS1248R13	171	Host Rectangular
HS1048R21	169	Host Rectangular	HS1248R20	172	Host Rectangular
HS1048R22	169	Host Rectangular	HS1248R21	172	Host Rectangular
HS1048S10	197	Host Soft Radiused	HS1248R22	172	Host Rectangular
HS1048S11	197	Host Soft Radiused	HS1248S10	199	Host Soft Radiused
HS1048S12	197	Host Soft Radiused	HS1248S11	199	Host Soft Radiused
HS1048S13	197	Host Soft Radiused	HS1248S12	200	Host Soft Radiused
HS1048S20	198	Host Soft Radiused	HS1248S13	200	Host Soft Radiused
HS1048S21	198	Host Soft Radiused	HS1248S20	200	Host Soft Radiused
HS1048S22	198	Host Soft Radiused	HS1248S21	200	Host Soft Radiused
HS1060B10	259	Host Boat	HS1248S22	200	Host Soft Radiused
HS1060B11	259	Host Boat	HS1260B10	261	Host Boat
HS1060B12	259	Host Boat	HS1260B11	261	Host Boat
HS1060B13	259	Host Boat	HS1260B12	261	Host Boat
HS1060B20	260	Host Boat	HS1260B13	261	Host Boat
HS1060B21	260	Host Boat	HS1260B20	262	Host Boat
HS1060B22	260	Host Boat	HS1260B21	262	Host Boat
HS1060C10	229	Host Racetrack	HS1260B22	262	Host Boat
HS1060C11	229	Host Racetrack	HS1260C10	233	Host Racetrack
HS1060C12	229	Host Racetrack	HS1260C11	233	Host Racetrack
HS1060C13	229	Host Racetrack	HS1260C12	233	Host Racetrack
HS1060C20	230	Host Racetrack	HS1260C13	233	Host Racetrack
HS1060C21	230	Host Racetrack	HS1260C20	234	Host Racetrack
HS1060C22	230	Host Racetrack	HS1260C21	234	Host Racetrack
HS1060R10	169	Host Rectangular	HS1260C22	234	Host Racetrack
HS1060R11	169	Host Rectangular	HS1260R10	172	Host Rectangular
HS1060R12	170	Host Rectangular	HS1260R11	172	Host Rectangular
HS1060R13	170	Host Rectangular	HS1260R12	172	Host Rectangular
HS1060R20	170	Host Rectangular	HS1260R13	173	Host Rectangular
HS1060R21	170	Host Rectangular	HS1260R20	173	Host Rectangular
HS1060R22	170	Host Rectangular	HS1260R21	173	Host Rectangular
HS1060S10	198	Host Soft Radiused	HS1260R22	173	Host Rectangular
HS1060S11	198	Host Soft Radiused	HS1260S10	201	Host Soft Radiused
HS1060S12	198	Host Soft Radiused	HS1260S11	201	Host Soft Radiused
HS1060S13	199	Host Soft Radiused	HS1260S12	201	Host Soft Radiused
HS1060S20	199	Host Soft Radiused	HS1260S13	201	Host Soft Radiused
HS1060S21	199	Host Soft Radiused	HS1260S20	202	Host Soft Radiused
HS1060S22	199	Host Soft Radiused	HS1260S21	202	Host Soft Radiused
HS1060T10	279	Host Trapezoid Table	HS1260S22	202	Host Soft Radiused
HS1060T11	279	Host Trapezoid Table	HS1260T10	281	Host Trapezoid Table
HS1060T12	279	Host Trapezoid Table	HS1260T11	281	Host Trapezoid Table
HS1060T13	279	Host Trapezoid Table	HS1260T12	281	Host Trapezoid Table
HS1060T20	280	Host Trapezoid Table	HS1260T13	281	Host Trapezoid Table
HS1060T21	280	Host Trapezoid Table	HS1260T20	282	Host Trapezoid Table
HS1060T22	280	Host Trapezoid Table	HS1260T21	282	Host Trapezoid Table

Style Number Index *continued*

Style Number	Page	Description	Style Number	Page	Description
HS1260T22	282	Host Trapezoid Table	HS1460S32	210	Host Soft Radiused
HS1448C20	240	Host Racetrack	HS1460S34	210	Host Soft Radiused
HS1448C21	240	Host Racetrack	HS1648C20	244	Host Racetrack
HS1448C22	240	Host Racetrack	HS1648C21	244	Host Racetrack
HS1448C24	240	Host Racetrack	HS1648C22	244	Host Racetrack
HS1448C30	241	Host Racetrack	HS1648C24	244	Host Racetrack
HS1448C31	241	Host Racetrack	HS1648C30	245	Host Racetrack
HS1448C32	241	Host Racetrack	HS1648C31	245	Host Racetrack
HS1448C34	241	Host Racetrack	HS1648C32	245	Host Racetrack
HS1448R20	178	Host Rectangular	HS1648C34	245	Host Racetrack
HS1448R21	178	Host Rectangular	HS1648R20	182	Host Rectangular
HS1448R22	178	Host Rectangular	HS1648R21	182	Host Rectangular
HS1448R24	178	Host Rectangular	HS1648R22	182	Host Rectangular
HS1448R30	179	Host Rectangular	HS1648R24	182	Host Rectangular
HS1448R31	179	Host Rectangular	HS1648R30	183	Host Rectangular
HS1448R32	179	Host Rectangular	HS1648R31	183	Host Rectangular
HS1448R34	179	Host Rectangular	HS1648R32	183	Host Rectangular
HS1448S20	207	Host Soft Radiused	HS1648R34	183	Host Rectangular
HS1448S21	207	Host Soft Radiused	HS1648S20	211	Host Soft Radiused
HS1448S22	207	Host Soft Radiused	HS1648S21	211	Host Soft Radiused
HS1448S24	207	Host Soft Radiused	HS1648S22	211	Host Soft Radiused
HS1448S30	208	Host Soft Radiused	HS1648S24	211	Host Soft Radiused
HS1448S31	208	Host Soft Radiused	HS1648S30	212	Host Soft Radiused
HS1448S32	208	Host Soft Radiused	HS1648S31	212	Host Soft Radiused
HS1448S34	208	Host Soft Radiused	HS1648S32	212	Host Soft Radiused
HS1460B20	267	Host Boat	HS1648S34	212	Host Soft Radiused
HS1460B21	267	Host Boat	HS1660B20	269	Host Boat
HS1460B22	267	Host Boat	HS1660B21	269	Host Boat
HS1460B24	267	Host Boat	HS1660B22	269	Host Boat
HS1460B30	268	Host Boat	HS1660B24	269	Host Boat
HS1460B31	268	Host Boat	HS1660B30	270	Host Boat
HS1460B32	268	Host Boat	HS1660B31	270	Host Boat
HS1460B34	268	Host Boat	HS1660B32	270	Host Boat
HS1460C20	242	Host Racetrack	HS1660B34	270	Host Boat
HS1460C21	242	Host Racetrack	HS1660C20	246	Host Racetrack
HS1460C22	242	Host Racetrack	HS1660C21	246	Host Racetrack
HS1460C24	242	Host Racetrack	HS1660C22	246	Host Racetrack
HS1460C30	243	Host Racetrack	HS1660C24	246	Host Racetrack
HS1460C31	243	Host Racetrack	HS1660C30	247	Host Racetrack
HS1460C32	243	Host Racetrack	HS1660C31	247	Host Racetrack
HS1460C34	243	Host Racetrack	HS1660C32	247	Host Racetrack
HS1460R20	180	Host Rectangular	HS1660C34	247	Host Racetrack
HS1460R21	180	Host Rectangular	HS1660R20	184	Host Rectangular
HS1460R22	180	Host Rectangular	HS1660R21	184	Host Rectangular
HS1460R24	180	Host Rectangular	HS1660R22	184	Host Rectangular
HS1460R30	181	Host Rectangular	HS1660R24	184	Host Rectangular
HS1460R31	181	Host Rectangular	HS1660R30	185	Host Rectangular
HS1460R32	181	Host Rectangular	HS1660R31	185	Host Rectangular
HS1460R34	181	Host Rectangular	HS1660R32	185	Host Rectangular
HS1460S20	209	Host Soft Radiused	HS1660R34	185	Host Rectangular
HS1460S21	209	Host Soft Radiused	HS1660S20	213	Host Soft Radiused
HS1460S22	209	Host Soft Radiused	HS1660S21	213	Host Soft Radiused
HS1460S24	209	Host Soft Radiused	HS1660S22	213	Host Soft Radiused
HS1460S30	210	Host Soft Radiused	HS1660S24	213	Host Soft Radiused
HS1460S31	210	Host Soft Radiused	HS1660S30	214	Host Soft Radiused

Style Number Index

Style Number	Page	Description	Style Number	Page	Description
HS1660S31	214	Host Soft Radiused	HS1860R22	188	Host Rectangular
HS1660S32	214	Host Soft Radiused	HS1860R24	188	Host Rectangular
HS1660S34	214	Host Soft Radiused	HS1860R26	188	Host Rectangular
HS1848C20	248	Host Racetrack	HS1860R30	189	Host Rectangular
HS1848C21	248	Host Racetrack	HS1860R31	189	Host Rectangular
HS1848C22	248	Host Racetrack	HS1860R32	189	Host Rectangular
HS1848C24	248	Host Racetrack	HS1860R34	189	Host Rectangular
HS1848C26	248	Host Racetrack	HS1860R36	189	Host Rectangular
HS1848C30	249	Host Racetrack	HS1860S20	217	Host Soft Radiused
HS1848C31	249	Host Racetrack	HS1860S21	217	Host Soft Radiused
HS1848C32	249	Host Racetrack	HS1860S22	217	Host Soft Radiused
HS1848C34	249	Host Racetrack	HS1860S24	217	Host Soft Radiused
HS1848C36	249	Host Racetrack	HS1860S26	217	Host Soft Radiused
HS1848R20	186	Host Rectangular	HS1860S30	218	Host Soft Radiused
HS1848R21	186	Host Rectangular	HS1860S31	218	Host Soft Radiused
HS1848R22	186	Host Rectangular	HS1860S32	218	Host Soft Radiused
HS1848R24	186	Host Rectangular	HS1860S34	218	Host Soft Radiused
HS1848R26	186	Host Rectangular	HS1860S36	218	Host Soft Radiused
HS1848R30	187	Host Rectangular	HS2048C20	252	Host Racetrack
HS1848R31	187	Host Rectangular	HS2048C21	252	Host Racetrack
HS1848R32	187	Host Rectangular	HS2048C22	252	Host Racetrack
HS1848R34	187	Host Rectangular	HS2048C24	252	Host Racetrack
HS1848R36	187	Host Rectangular	HS2048C26	252	Host Racetrack
HS1848S20	215	Host Soft Radiused	HS2048C30	253	Host Racetrack
HS1848S21	215	Host Soft Radiused	HS2048C31	253	Host Racetrack
HS1848S22	215	Host Soft Radiused	HS2048C32	253	Host Racetrack
HS1848S24	215	Host Soft Radiused	HS2048C34	253	Host Racetrack
HS1848S26	215	Host Soft Radiused	HS2048C36	253	Host Racetrack
HS1848S30	216	Host Soft Radiused	HS2048R20	190	Host Rectangular
HS1848S31	216	Host Soft Radiused	HS2048R21	190	Host Rectangular
HS1848S32	216	Host Soft Radiused	HS2048R22	190	Host Rectangular
HS1848S34	216	Host Soft Radiused	HS2048R24	190	Host Rectangular
HS1848S36	216	Host Soft Radiused	HS2048R26	190	Host Rectangular
HS1860B20	271	Host Boat	HS2048R30	191	Host Rectangular
HS1860B21	271	Host Boat	HS2048R31	191	Host Rectangular
HS1860B22	271	Host Boat	HS2048R32	191	Host Rectangular
HS1860B24	271	Host Boat	HS2048R34	191	Host Rectangular
HS1860B26	271	Host Boat	HS2048R36	191	Host Rectangular
HS1860B30	272	Host Boat	HS2048S20	219	Host Soft Radiused
HS1860B31	272	Host Boat	HS2048S21	219	Host Soft Radiused
HS1860B32	272	Host Boat	HS2048S22	219	Host Soft Radiused
HS1860B34	272	Host Boat	HS2048S24	219	Host Soft Radiused
HS1860B36	272	Host Boat	HS2048S26	219	Host Soft Radiused
HS1860C20	250	Host Racetrack	HS2048S30	220	Host Soft Radiused
HS1860C21	250	Host Racetrack	HS2048S31	220	Host Soft Radiused
HS1860C22	250	Host Racetrack	HS2048S32	220	Host Soft Radiused
HS1860C24	250	Host Racetrack	HS2048S34	220	Host Soft Radiused
HS1860C26	250	Host Racetrack	HS2048S36	220	Host Soft Radiused
HS1860C30	251	Host Racetrack	HS2060B20	273	Host Boat
HS1860C31	251	Host Racetrack	HS2060B21	273	Host Boat
HS1860C32	251	Host Racetrack	HS2060B22	273	Host Boat
HS1860C34	251	Host Racetrack	HS2060B24	273	Host Boat
HS1860C36	251	Host Racetrack	HS2060B26	273	Host Boat
HS1860R20	188	Host Rectangular	HS2060B30	274	Host Boat
HS1860R21	188	Host Rectangular	HS2060B31	274	Host Boat

Style Number Index continued

Style Number	Page	Description	Style Number	Page	Description
HS2060B32	274	Host Boat	INTHW	23	Interact, Hardwire
HS2060B34	274	Host Boat	INTSC	23	Interact, 6' Cord
HS2060B36	274	Host Boat	PCS	21	Power/Comm Sphere
HS2060C20	254	Host Racetrack	PODHW	102	Train POD
HS2060C21	254	Host Racetrack	PODMD1	102	3' Conduit with Modular Connector
HS2060C22	254	Host Racetrack	PODMD2	102	3' Conduit with Modular Connector
HS2060C24	254	Host Racetrack	PODMD3	102	3' Conduit with Modular Connector
HS2060C26	254	Host Racetrack	PODMD4	102	3' Conduit with Modular Connector
HS2060C30	255	Host Racetrack	PODPL	102	Train POD
HS2060C31	255	Host Racetrack	PSP	21	Power Sphere
HS2060C32	255	Host Racetrack	RJ11	22	Coupler
HS2060C34	255	Host Racetrack	RJ45	22	Coupler
HS2060C36	255	Host Racetrack	TN4824C	99	Train 24"W Rectangular
HS2060R20	192	Host Rectangular	TN4830C	99	Train 30"W Rectangular
HS2060R21	192	Host Rectangular	TN6024C	99	Train 24"W Rectangular
HS2060R22	192	Host Rectangular	TN6030C	99	Train 30"W Rectangular
HS2060R24	192	Host Rectangular	TN7224C	99	Train 24"W Rectangular
HS2060R26	192	Host Rectangular	TN7230C	99	Train 30"W Rectangular
HS2060R30	193	Host Rectangular	TN90D24	100	Train Corner Top
HS2060R31	193	Host Rectangular	TN90D30	100	Train Corner Top
HS2060R32	193	Host Rectangular	TNBPIHW	107	Train Power Infeed
HS2060R34	193	Host Rectangular	TNBPIMD	108	Train Power Infeed
HS2060R36	193	Host Rectangular	TNBPINY	107	Train Power Infeed
HS2060S20	221	Host Soft Radiused	TNGL	101	Train Glides
HS2060S21	221	Host Soft Radiused			
HS2060S22	221	Host Soft Radiused			
HS2060S24	221	Host Soft Radiused			
HS2060S26	221	Host Soft Radiused			
HS2060S30	222	Host Soft Radiused			
HS2060S31	222	Host Soft Radiused			
HS2060S32	222	Host Soft Radiused			
HS2060S34	222	Host Soft Radiused			
HS2060S36	222	Host Soft Radiused			
HS4800D10	165	Host Round			
HS4800D11	165	Host Round			
HS4WXFRM	284	Host Corridor Power Kit, Modular			
HS6000D10	165	Host Round			
HS6000D11	165	Host Round			
HS9648C10	226	Host Racetrack			
HS9648C11	226	Host Racetrack			
HS9648C12	226	Host Racetrack			
HS9648R10	168	Host Rectangular			
HS9648R11	168	Host Rectangular			
HS9648R12	168	Host Rectangular			
HS9648S10	196	Host Soft Radiused			
HS9648S11	196	Host Soft Radiused			
HS9648S12	196	Host Soft Radiused			
HS9654B10	258	Host Boat			
HS9654B11	258	Host Boat			
HS9654B12	258	Host Boat			
HS9660T10	278	Host Trapezoid Table			
HS9660T11	278	Host Trapezoid Table			
HS9660T12	278	Host Trapezoid Table			
HSFCONPT	283	Host Floor Kit: Connectrac			
HSFSHLF	283	Host Corridor Shelf			

Style Number Index

Trademark List

- ® The following are registered trademarks for products of Steelcase Inc. or one of its related corporate entities: 4 o'clock, 900 Series, à la carte, Airtouch, Ally, Amia, Answer, Archipelago, Avenir, Ballet, Bix, Brayton International, Cachet, Canopy, Canto, Chancellor, Coalesse, Confidante, Context, Convene, CopyCam, Criterion, Crushed Can, Currency, dash, Designtex, Details, Detour, Drive, Elective Elements, Ellipse, Ember Chrome, Emerge, E-Table 2, FYI, Garland, Gentry, Ginkgo Biloba, Groupwork, Ideo, Jacket, Jenny, Jersey, Kart, Kick, LaCosta, Leap, Let's B, LiveBack, Max-Stacker, media:scape, Metro, Migrations, Mitra, Montage, Nurture, Oriana, Parade, Pathways, PCT, Permiso, Player, Portal, Power Pincher, Progeny, Protégé, R2, Rally, Relevant, Reply, Rizzi Arc, Sensor, Series 9000, Siento, Sieste, Sine, Softcare, Springboard, Steelcase, Steelcase Design Partnership, Stella, Stow Davis, Swathmore, Sylvi, TeamWork, Technique, Texpress, Think, Thunder, Topo, Train, turnstone, Underline, Unison, Vecta, Viridian, Walden, Werndl, and X-Stack.
- ® The following registered trademarks are under license from AWI Licensing Company, Dover, DE: SoundScapes, DuraBrite, BioBlock, and Armstrong.
- ® The following registered trademarks are under license from Byrne Electrical, Rockford, MI: Interport, Mini-Port, Axil Z, and Ellora.
- ® The following is a registered trademark of DuPont, Wilmington, DE: Corian.
- ® The following is a registered trademark of Genlyte Thomas Company, Louisville, KY: Lightolier.
- ® The following is a registered trademark of Hilti Corporation, FL-9494 Schaan, Principality of Liechtenstein: Hilti.
- ® The following is a registered trademark of Leviton Manufacturing Company, Little Neck, NY: Decora.
- ® The following is a registered trademark of Mechanical Plastics Corp, Elmsford, NY: Toggler.
- ® The following is a registered trademark of Microsoft Corporation, Redmond, WA: Microsoft.
- ® The following is a registered trademark of Panduit Corporation, Lockport, IL: Panduit.
- ® The following is a registered trademark of Trav (Press), Cuneo, Italy: Assisa.
- ® The following is a registered trademark of Virtual Ink, Boston, MA: mimioActive.
- ® The following registered trademarks are under license from Wilkhahn Furniture Products: Avera, Senzo, Versal, and Wilkhahn FS.

- ® The following is a registered trademark of Wilsonart International, Temple, TX: Chemsurf.
- ® The following is a registered trademark of Wiremold, West Hartford, CT: Wiremold.
- ® The following is a registered trademark of EMU Group S.P.A., Perugia, Italy: Emu.
- ® The following is a registered trademark of Security People, Inc.: Digilock.
- ™ The following are trademarks for products of Steelcase Inc. or one of its related corporate entities: Access, Active/Passive Shelf, Ainsley, Akira, Alcove, Alerion, Alight, Amaris, American Elect, American Tradition, ap40, Arbor, Arriva, Asana, Ascot, Aspekt, Astor, Await, Bassline, B-Free, Bira, Bivi, Bixby, Bottomline, Brody, Brook, Buoy, Burton, c:scape, Calla, Calm, Camber, Campfire, Capa, Cappuccino, Cesar, Chester, Chord, Circa, Clarendon, Classic Rectangular, Clipper, cobì, Collaboration, Community, Company, Convey, Cortex, Coupe, Crea, Crew, Cura, Cypress, Davenport, Dearborn, Deck, Déjà, Denizen, Denska, Derby, Divisio, Donovan, Dune, Duo, Echo, Edge, Elsna, Empath, Empress, Enea, ēno, EnSync, Enviro, Escapade, Exchange, Exponents, Field, Flat Top, FlexFrame, Flip Top, Flute, Folio, FrameOne, FreeFlow, Frontier, Galliei, Gesture, Ginger, Ginkgo, Go Wall, Grip, Groove, Hatchback, Hawthorne, Hitch, Host Collection, Hosu, Huddleboard, i2i, Impact, Indy, InfoLink, IOS, I-Solve, Jack, Jarrah, Jetty, Juice, Kami, Kast, Kathryn, Lagunitas, Lark, L'Attitude, LearnLab, Leela, LessThanFive, Lincoln, Linden, LiveSeat, Loria, Lyric, Malibu, Malibu Too, Mansfield, Marathon, Martini, Mason, Masque, Migration, Millbrae, Mineral, Mingle, Mystic, Mystic Metal, Mystic Wood, Montara650, Montreal, Move, Nadia, Neighbor, nesso, Nickel, Nikko, Nod, Node, Norfolk, Ology, Ontrak, Oom, Opus, Orchid, Outlook Collection, Ovation, Paloma, Paperflo, Parliament, Pasio, Passerelle, Patriarch, Payback, Peek, Pile File, Pisa, Pool, Potrero415, PUCK, QiVi, Quba, Rave, Reed, Regard, Relay, Reunion, Ripple, Riser, Roam, Rocco, Rocky, RoomWizard, Runner, Satellite, Sawyer, ScapeSeries, Senti, Sentinel, Senza, Sequoia, Session, ShareLink, Shield, Shortcut, Sidewalk, SILQ, Skylar, Slumber, Smoke, Snug, Soft Leaf, Sonata, Sorrel, SOTO, Southside, Stationkits, Steelcase Series, Stiletto, Surprise!, Surround, Switch, Symphony, Sync, TagWizard, Tava, TeamStudio, TeamTheater, Tenaro, Terrazzo, Theorem, Thread, Topaz, Touchdown, Tour, Tower Too, Trees, Trillium, Trolley, tX2, U-Free, Umami, Underscore, Uno, V.I.A., Verb, Verge, Verlay, Victor2, Visalia, Waldorf, Woodruff, Workspring, and X-tenz.
- ™ The following is a trademark of Microsoft Corporation, Redmond, WA: Windows.
- ™ The following is a trademark of Rodman Industries, Inc., Oconomowoc, WI: ResinCore1.
- ™ The following is a trademark of Ultrafabrics, LLC, Elmsford, NY: Ultraleather.

- ™ The following trademarks are under license from Wilkhahn Furniture products: Cana, Linus, Logon, Picto, Range, Stitz, Thema, Timetable, and Tubis.
 - ™ The following trademark is used under license from Cradle to Cradle Products Innovation Institute, Oakland, CA: Cradle to Cradle Certified.
 - ™ The following trademarks are under license from Walter Knoll: Andoo, Bob, Lazlo, Lox, Ribbon, and Together.
 - ™ The following trademarks are under license from PP Møbler: Bar and Flag Halyard.
 - ™ The following trademarks are under license from Viccarbe: Davos, Holy Day, Last Minute, RS, Sistema, and Wrapp.
 - ™ The following trademarks are under license from Carl Hansen: Elbow, Paddle, Shell, Wing, and Wishbone.
 - ™ The following trademarks are under license from Cambridge Sound Management, LLC, Cambridge, MA: QtPro Soundmasking, Qt Quiet Technology, and Sonet Qt.
 - ™ The following is a trademark of Electri-Cable Assemblies, Shelton, CT: Interact.
 - ™ The following is a trademark of Clestra Hauserman: IRYS.
 - ™ The following is a trademark of Wiesner-Hager Möbel GmbH: Nooi.
 - ™ The following are trademarks of PolyVision: a³, e³, Flow, Motif, PolyVision, Sans, and Serif.
 - ™ The following is a trademark of Bostock Company, Inc: SnapCab.
 - ™ The following is a trademark of Williams-Sonoma, Inc: West Elm.
 - ™ The following is a trademark of Elena Marquina Testor: nanimarquina.
 - ™ The following is a trademark of Forbo International SA: Forbo.
- Trademarks used here in are the property of Steelcase, Inc. or of their respective owners.*