Coalesse Seating and Occasional Tables

Volume 5a

► For more detailed product information, see the *Coalesse Specification Guides* or consult your Steelcase dealer.

Terms and Conditions	2
Sample Order Form	10
Participating Steelcase Dealers	12
Steelcase Showrooms and Manufacturing Locations	17

Seating/Occasional Tables	19
Lounge Seating	45
Guest/Side/Stack Seating	175
Collaboration Seating	217
Occasional Tables	225
Outdoor	243

Surface Materials	259
Resources	299

► For a list of all trademarks, refer to the last page of this specification guide.

Terms and Conditions

Customer Information

For more information, please contact your participating Steelcase GSA dealer.

For more information, please contact your participating Steelcase GSA dealer.

For more information, please contact your participating Steelcase GSA dealer.

For more information, please contact your participating Steelcase GSA dealer.

For more information, please contact your participating Steelcase GSA dealer.

For more information, please contact your participating Steelcase GSA dealer.

For more information, please contact your participating Steelcase GSA dealer.

For more information, please contact your participating Steelcase GSA dealer.

Sample Order Form

Sample Order Form

ORDER FOR SUPPLIES OR SERVICES			PAGE	OF	PAGES
IMPORTANT: Mark all packages and papers with contract and/or order numbers.					
DATE OF ORDER 1 6-1-04	CONTRACT NO. (If any) 2 GS-27F-0014V	ORDER NO. 3 10 - 000	REQUISITION/REFERENCE NO.		
ISSUING OFFICE (Address correspondence to) 4 GSA 1 Town Street City, State, Zip Name and Telephone Number		SHIP TO: (Consignee and address, ZIP Code) 5 GSA 2 Town Street City, State, Zip Name and Telephone Number			
TO: CONTRACTOR (Name, address and ZIP Code) 6 Steelcase Inc. c/o Participating Dealer 901 44th Street, SE Grand Rapids, MI 49508 Attn: Solutions Fullfillment Team CH-2W-SS (GSA)		Cage Code: 39880		TYPE OF ORDER <input type="checkbox"/> A. PURCHASE — Reference your _____ Please furnish the following on the terms and conditions specified on both sides of this order and on the attached sheets, if any, including delivery as indicated. This purchase is negotiated under authority of: <input type="checkbox"/> B. DELIVERY — Except for billing instructions on the reverse, this delivery order is subject to instructions contained on this side only of this form and is issued subject to the terms and conditions of the above-numbered contract.	
ACCOUNTING AND APPROPRIATION DATA			REQUISITIONING OFFICE		
			BUSINESS CLASSIFICATION (Check appropriate box(es)) 20 <input type="checkbox"/> SMALL <input checked="" type="checkbox"/> OTHER THAN SMALL <input type="checkbox"/> DIS-ADVAN-TAGED <input type="checkbox"/> WOMEN-OWNED		
FCA DESTINATION 7		GOVERNMENT NO.	DELIVER TO FCA DESTINATION ON OR BEFORE (Date) 8 ARO date	DISCOUNT TERMS 9 Net 30 days	
PLACE OF INSPECTION AND ACCEPTANCE					

(See reverse for Rejections)

ITEM NO. (A)	SUPPLIES OR SERVICES (B)	QUANTITY ORDERED (C)	UNIT (D)	UNIT PRICE (E)	AMOUNT (F)	QUANTITY ACCEPTED (G)
1	10 One lot of Steelcase Office Furniture: See attached specifications	13 1		14 \$000	15 \$000	
2	11 Design: \$55.41/hour	2 hrs		\$000	\$000	
3	12 Installation	1		\$000	\$000	
SEE BILLING INSTRUCTIONS ON REVERSE		SHIPPING POINT		GROSS SHIPPING WEIGHT		INVOICE NO.
		MAIL INVOICE TO: (Include ZIP Code) 17 GSA, 3 Town Street, City, State, Zip				16 \$000
UNITED STATES OF AMERICA BY (Signature) 18 Contracting Officer signature and telephone no.			NAME (Typed) 19 John Doe, Department Manager TITLE: CONTRACTING/ORDERING OFFICER			
				(H) TOT. (Cont. pages) ◀		(I) GRAND TOTAL ◀

NSN 7540_01_152_8083

50347-101

OPTIONAL FORM 347 (10-83)
Prescribed by GSA
FAR (48 CFR) 53.213 (e)

- 1 Order date
- 2 Contract number
- 3 Order number
- 4 Issuing office: Requester name and telephone number
- 5 Shipping address: Contact name and telephone number
- 6 Contractor:
Steelcase Inc.
c/o Participating Dealer
901 - 44th Street, S.E.
Grand Rapids, MI 49508
Attn: Solutions Fulfillment Team
- 7 FCA destination
- 8 ARO date (After Receipt of Order)
- 9 Terms: Net 30 days
- 10 Complete product description, including SIN number, style number, all applicable surface materials.
- 11 Separate line for design
- 12 Separate line for installation
- 13 Quantity ordered
- 14 Individual unit price
- 15 Amount (quantity x unit price)
- 16 Total cost
- 17 Invoice address
- 18 Authorized contracting officer signature and telephone number
- 19 Authorized contracting officer name and title (typed)
- 20 Steelcase is the seller of record and is not registered as "small," "disadvantaged," or "woman-owned." If one of these boxes is checked in error, a modification will be required.

Please note on order that all invoice payments must be sent to:

Steelcase Inc.
62087 Collection Center Dr.
Chicago, IL 60693-0620

Storage and Delays

(Open Market) In the event that the site is not accessible, or safe and adequate storage space is not available during installation, the furnishings will be stored until delivery or installation can be accomplished. Pricing for storage will be negotiated on a project-by-project basis. Invoices will be sent to the local government purchasing facility upon delivery of the furniture to a designated storage facility. Steelcase shall provide notice to the Government purchasing facility that the furnishings are available for inspection by the Government at the Storage facility. Upon this notice, the Government, or representative for the Government, must inspect and accept the furniture prior to payment of any invoice. The inspection and acceptance must be completed within reasonable time frame agreed upon by both parties. Payment will be made by the Government 30 days after acceptance of the furniture.

Participating Steelcase Dealers

Alabama

Dekalb Office of Alabama
2901 Second Ave South
Birmingham, AL 35233
Phone: (205) 933-9100

Kyser OfficeWorks Inc.
2400 Spruce Street
Montgomery, AL 36107-3150
Phone: (334) 834-9400
Fax: (334) 262-0701

OEC Business Interiors
104 East I-65 Service Road North
Mobile, AL 36607-2501
Phone: (251) 471-3368
Fax: (251) 471-0019

Office Interiors by OSCO
1300 Meridian Street
Suite 203
Huntsville, AL 35801
Phone: (256) 604-5696
Fax: (256) 604-5699

OSCO Inc.
229 Grant Street SE
Decatur, AL 35601-2511
Phone: (256) 340-5100
Fax: (256) 340-5108

Alaska

Capital Office Systems
1120 East 35th Avenue
Anchorage, AK 99508-4257
Phone: (907) 777-1500
Fax: (907) 777-1515

Capital Office Systems
3201 Industrial Avenue
Fairbanks, AK 99701-7370
Phone: (907) 456-3946
Fax: (907) 452-6257

Capital Office Systems
3143 Channel Drive
Juneau, AK 99801-7214
Phone: (907) 780-3636
Fax: (907) 780-2290

Arizona

Atmosphere Commercial Interiors
815 North Central Avenue
Phoenix, AZ 85004
Phone: (602) 252-6971

Atmosphere Commercial Interiors
Suite 100
88 East Broadway Boulevard
Tucson, Arizona 85701-1720
Phone: (520) 792-4200

Atmosphere Commercial Interiors
Suite 100
88 East Broadway Boulevard
Tucson, Arizona 85701-1720
Phone: (520) 792-4200
Fax: (540) 791-9568

Arkansas

ImageWorks
Suite B
1424 North Shackelford
Little Rock, AR 72211
Phone: (501) 944-7501

Today's Office Inc.
717 West 7th Street
Little Rock, AR 72201-4044
Phone: (501) 375-5050
Fax: (501) 375-1350

Today's Office Inc.
3157 West Sunset Avenue
Springdale, AR 72762-4945
Phone: (479) 751-5861
Fax: (479) 756-2233

California

BKM Office Environments
816 Via Alondra
Camarillo, CA 93012
Phone: (877) 256-1256
Fax: (805) 339-9032

BKM San Diego
Suite 100
9201 Spectrum Center Blvd.
San Diego, CA 92123-1407
Phone: (858) 569-4700
Fax: (858) 277-8931

One Workplace L. Ferrari
2500 De La Cruz Blvd.
Santa Clara, CA 95050
Phone: (669) 800-2500
Fax: (669) 800-2501

One Workplace L. Ferrari
7220 Edgewater Drive
Oakland, CA 94621
Phone: (510) 729-7800
Fax: (510) 729-7801

One Workplace L. Ferrari
475 Brannan Street
San Francisco, CA 94107-1731
Phone: (415) 357-2200
Fax: (415) 357-2201

Peninsula Business Interiors
325 Main Street
Salinas, CA 93901-2705
Phone: (831) 757-4107
Fax: (831) 757-1339

Tangram Interiors
Suite 102
4057 W Shaw Ave
Fresno, CA 93722-6212
Phone: (559) 275-7070
Fax: (559) 275-7080

Tangram Interiors
Suite 100
2850 South Red Hill Avenue
Santa Ana, CA 92705-5532
Phone: (949) 955-6700
Fax: (949) 955-6799

Tangram Interiors
9200 Sorensen Avenue
Santa Fe Springs, CA 90670-2645
Phone: (562) 365-5000
Fax: (562) 365-5399

United Corporate Furnishings
1780 North Market Blvd.
Sacramento, CA 95834-1997
Phone: (916) 553-5900
Fax: (916) 553-5800

Colorado

Office Outfitters & Planners Inc.
749 Main Street
Grand Junction, CO 81501-3535
Phone: (970) 245-6300
Fax: (970) 245-6301

OfficeScapes
2506 Zeppelin Rd
Colorado Springs, CO 80916
Phone: (719) 574-1113
Fax: (719) 574-1133

OfficeScapes
9900 East 51st Avenue
Denver, CO 80238-2430
Phone: (303) 574-1115
Fax: (303) 574-1116

OfficeScapes
Suite 180
4812 McMurry Avenue
Fort Collins, CO 80525-6222
Phone: (970) 223-5959
Fax: (970) 223-5858

Connecticut

Red Thread
300 East River Drive
East Hartford, CT 06108-4205
Phone: (860) 528-9981
Fax: (860) 528-1843

Red Thread
488 Wheelers Farm Rd.
Milford, CT 06461
Phone: (203) 874-7754
Fax: (203) 876-7915

Red Thread
700 Canal St 3rd Fl
Stamford, CT 06902
Phone: (860) 528-9981

Red Thread
40 Main Street
Torrington, CT 06790
Phone: (860) 482-2679
Fax: (860) 482-3590

Delaware

Corporate Interiors Inc.
223 Lisa Drive
New Castle, DE 19720-4193
Phone: (302) 323-9100
Fax: (302) 323-9251

Florida

American Business Interiors
215 Waverly Place
Melbourne, FL 32901-5444
Phone: (321) 723-5003
Fax: (321) 984-4221

Empire Office
Suite 140
2 Oakwood Boulevard
Hollywood, FL 33020
Phone: (954) 707-6200

Empire Office
South Florida
3201 Commerce Parkway
Miramar, FL 33025-3908
Phone: (954) 435-7300
Fax: (954) 435-7212

Empire Office
Suite 17
2315 Lynx Lane
Orlando, FL 32804
Phone: (407) 628-2400

Empire Office
5112 West Linebaugh Avenue
Tampa, FL 33624
Phone: (813) 418-3300

Empire Office
Suite 2
7830 Byron Drive
West Palm Beach, FL 33404-3332
Phone: (561) 840-8600
Fax: (561) 840-1873

Leitz & Reed Office Products
1119 Florida Avenue
Lynn Haven, FL 32444-4622
Phone: (850) 271-2600
Fax: (850) 271-0076

OEC Business Interiors
1601 NW 80th Boulevard
Gainesville, FL 32606-9140
Phone: (352) 332-1192
Fax: (352) 333-8002

· OEC Business Interiors
· 2393 SW College Road
· Ocala, FL 34474-1661
· Phone: (352) 620-2888
· Fax: (352) 620-2891

· OEC Business Interiors
· 6254 North W Street
· Pensacola, FL 32503-2746
· Phone: (850) 438-1100
· Fax: (850) 432-0003

· Office Furniture & Design Concepts
· 11866 Metro Parkway
· Ft. Myers, FL 33966-1307
· Phone: (239) 337-1212
· Fax: (239) 337-4910

· Perdue Office Interiors
· Suite 100
· 5 W Forsyth
· Jacksonville, FL 32256-7440
· Phone: (904) 737-5858
· Fax: (904) 737-6088

· Perdue Office Interiors
· Suite C7
· 1516 Capital Circle SE
· Tallahassee, FL 32301
· Phone: (850) 383-4225

Georgia

· Advent Business Interiors
· 1318 U.S. HWY 82 West
· Leesburg, GA 31721
· Phone: (229) 439-7418
· Fax: (229) 435-1279

· Advent Business Interiors
· 110 West Macon Park Dr.
· Macon, GA 31210
· Phone: (478) 471-0600

· DeKalb Office Environments
· 1320 Ridgeland Parkway
· Alpharetta, GA 30004-8442
· Phone: (770) 360-0200
· Fax: (770) 360-0305

· McWaters Inc.
· 3708 Benchmark Drive
· Augusta, GA 30907
· Phone: (706) 396-5400
· Fax: (706) 396-5401

· McWaters Inc.
· 117 Prosperity Drive
· Savannah, GA 31408-9551
· Phone: (912) 352-9000
· Fax: (912) 352-2034

Hawaii

· Interior Showplace Ltd.
· 956 Queen Street
· Honolulu, HI 96814-4118
· Phone: (808) 593-8420
· Fax: (808) 591-8324

Idaho

· Porter's Office Products
· 435 West Center Street
· Pocatello, ID 83204-3241
· Phone: (208) 232-1233
· Fax: (208) 232-8759

· Porter's Office Products
· 1050 North 2nd East
· Rexburg, ID 83440-5127
· Phone: (208) 356-4616
· Fax: (208) 356-8901

· Office Environment Company
· 623 South Americana Blvd.
· Boise, ID 83702-5120
· Phone: (208) 385-0507
· Fax: (208) 385-9392

Illinois

· A. Pomerantz
· Suite 940
· 222 Merchandise Mart Plaza
· Chicago, IL 60654-1223
· Phone: (312) 929-3335
· Fax: (312) 929-3311

· Atmosphere Commercial Interiors
· 801 North Perryville Road
· Rockford, IL 61107
· Phone: (815) 398-3300

· Egyptian Business Furniture
· 129 West Main Street
· Belleville, IL 62220-1501
· Phone: (618) 234-2323
· Fax: (618) 236-3295

· Interiors for Business Inc.
· 409 N River Street
· Batavia, IL 60510-2359
· Phone: (630) 761-1070
· Fax: (630) 761-1065

· Lincoln Office
· 205 Eastgate Drive
· Washington, IL 61571-9238
· Phone: (309) 427-2500
· Fax: (309) 427-2625

· Forward Space
· Suite 614
· 222 Merchandise Mart Plaza
· Chicago, IL 60654-1223
· Phone: (312) 563-5206

· Forward Space
· 1142 N North Branch Street
· Chicago, IL 60642
· Phone: (312) 942-1100
· Fax: (312) 942-9840

· Forward Space
· 13820 West Business Center Drive
· Lake Forest, IL 60045-1181
· Phone: (847) 573-8890
· Fax: (847) 573-8891

· Forward Space
· Suite 150
· 1111 West 22nd Street
· Oak Brook, IL 60523
· Phone: (312) 563-5206

Indiana

· Business Furnishings LLC
· 4102 Meghan Beeler Court
· South Bend, IN 46628
· Phone: (574) 243-3255
· Fax: (574) 243-3266

· Business Furniture LLC
· 6102 Victory Way
· Indianapolis, IN 46278-2934
· Phone: (317) 216-1600
· Fax: (317) 216-1601

· Corporate Design Inc.
· Suite 400
· 1419 West Lloyd Expressway
· Evansville, IN 47710-1002
· Phone: (812) 422-3000
· Fax: (812) 422-3413

· Lincoln Office
· 1200 Arrowhead Court
· Crown Point, IN 46307-8222
· Phone: (219) 662-2777
· Fax: (219) 662-7770

Iowa

· Lincoln Office
· 1026 Mound St
· Davenport, IA 52803
· Phone: (563) 322-5660

· Tallgrass Business Resources
· Highway 6 West
· 218 Second Street
· Coralville, IA 52241-2608
· Phone: (319) 338-3135
· Fax: (319) 338-7484

· Workspace Inc.
· 309 Locust Street
· Des Moines, IA 50309-1788
· Phone: (515) 288-7090
· Fax: (515) 288-0250

Kansas

· Design Central Inc.
· 152 South 5th Street
· Salina, KS 67401
· Phone: (785) 825-4131
· Fax: (785) 825-4778

· Scott Rice Office Interiors
· 224 East Douglas
· Wichita, KS 67211-1640
· Phone: (316) 269-2700
· Fax: (316) 269-3527

· Scott Rice Office Works
· 14720 West 105th Street
· Lenexa, KS 66215-4414
· Phone: (913) 888-7600
· Fax: (913) 227-7793

Kentucky

· Office Resources Inc.
· 530 Corvette Drive
· Bowling Green, KY 42101-7132
· Phone: (270) 781-5858
· Fax: (270) 781-5884

· Office Resources Inc.
· 101 Bradley Drive
· Nicholasville, KY 40356-9121
· Phone: (859) 885-6161
· Fax: (859) 885-9610

· Office Resources Inc.
· 816 East Broadway
· Louisville, KY 40204-1053
· Phone: (502) 589-8400
· Fax: (502) 589-8408

Louisiana

· Frost-Barber Inc.
· 9322 Interline Avenue
· Baton Rouge, LA 70809-1966
· Phone: (225) 926-5000
· Fax: (225) 926-5011

· Workplace Solutions
· 401 St. Joseph Street.
· New Orleans, LA 70130
· Phone: (504) 522-9558
· Fax: (504) 522-7070

Maine

· Red Thread
· One City Center
· Portland, ME 04101
· Phone: (207) 774-4900
· Fax: (207) 774-8155

Maryland

· Arbee Associates
· 6311 Ammendale Road
· Beltsville, MD 20705-1249
· Phone: (410) 385-5180
· Fax: (410) 385-5199

· Arbee Associates
· 9300 Gaither Road
· Gaithersburg, MD 20877
· Phone: (301) 963-3900
· Fax: (301) 977-1734

· Dancker, Sellow & Douglas Inc.
· Suite 309
· 509 Exeter Street
· Baltimore, MD 21202
· Phone: (301) 671-2541
· Fax: (301) 797-1504

Participating Steelcase Dealers, continued

Dancker, Sellaw & Douglas Inc.
9200 Alaking Court
Suite 100
Capitol Heights, MD 20743
Phone: (301) 350-8700
Fax: (301) 350-9393

Massachusetts

Red Thread
Suite 600
101 Seaport Blvd.
Boston, MA 02210-1838
Phone: (617) 439-4900
Fax: (617) 439-4131

Red Thread
Suite 150
293 Boston Post Road West
Marlborough, MA 01752-4615
Phone: (508) 449-6550
Fax: (508) 449-6570

Red Thread
Suite 1108
1350 Main Street
Springfield, MA 01103
Phone: (413) 736-1802

Red Thread
100 Fordham Road
Wilmington, MA 01887
Phone: (978) 658-3900
Fax: (978) 694-4107

Michigan

Custer Office Environments Inc.
2435 Plaza Drive
Benton Harbor, MI 49022-2229
Phone: (616) 926-8719
Fax: (616) 926-9482

Custer Office Environments Inc.
217 Grandville Ave SW
Grand Rapids, MI 49503-4013
Phone: (616) 458-6322
Fax: (616) 458-1117

Custer Office Environments Inc.
5737 East Cork Street
Kalamazoo, MI 49048-9668
Phone: (269) 342-3919
Fax: (269) 342-3923

Custer Office Environments
442 East Michigan
Marquette, MI 49885
Phone: (906) 226-1161
Fax: (906) 226-1164

Custer Office Environments
120 East Front Street
Traverse City, MI 49684
Phone: (616) 402-8489

NBS
701 Salzburg Avenue
Bay City, MI 48706-5390
Phone: (989) 895-8574
Fax: (989) 895-8545

NBS
5133 West Grand River Avenue
Lansing, MI 48906-9117
Phone: (517) 886-0072
Fax: (517) 886-0014

NBS
2595 Bellingham Drive
Troy, MI 48083-2036
Phone: (248) 823-5400
Fax: (248) 823-5401

Minnesota

Atmosphere Commercial Interiors
Suite 350
81 South 9th Street
Minneapolis, MN 55402-3226
Phone: (612) 343-0868
Fax: (612) 332-5733

Burgher Office Equipment Company
101 East Chestnut Street
Virginia, MN 55792-2512
Phone: (218) 749-2661
Fax: (218) 749-2662

Duluth Typewriter & Business Furniture
30 N 3rd. Ave W
Duluth, MN 55802-1607
Phone: (218) 722-5811
Fax: (218) 722-4876

General Office Products Company
4521 Highway 7
Minneapolis, MN 55416-4098
Phone: (952) 925-7500
Fax: (952) 925-7531

Mississippi

Workplace Solutions
251 West South Street
Jackson, MS 39203-3636
Phone: (601) 354-4960
Fax: (601) 353-6231

Workplace Solutions
2207 5th Street
Meridian, MS 38652
Phone: (601) 484-7279

Workplace Solutions
520 Main Street
Natchez, MS 39120
Phone: (601) 442-1494
Fax: (601) 442-0457

Workplace Solutions
718 West Bankhead St.
New Albany, MS 38652
Phone: (662) 534-0882
Fax: (662) 534-5753

OEC Business Interiors
12199 Highway 49 N.
Suite 300
Gulfport, MS 39503-3167
Phone: (228) 539-9575
Fax: (228) 539-9566

Missouri

Color-Art Integrated Interiors
1325 North Warson Road
Saint Louis, MO 63132-1807
Phone: (314) 432-3000
Fax: (314) 993-2752

Marathon Office Interiors
1715 Paris Road
Columbia, MO 65201-5571
Phone: (573) 875-7115
Fax: (573) 875-7116

Montana

KR Office Interiors
119 North 7th Avenue
Bozeman, MT 59715
Phone: (406) 587-3775
Fax: (406) 587-4636

KR Office Interiors
1710 North Montana Avenue
Helena, MT 59601
Phone: (406) 513-1004
Fax: (406) 513-1006

Missoula's Office City
115 West Broadway Street
Missoula, MT 59802-4217
Phone: (406) 543-7171
Fax: (406) 543-4254

Peterson's Quality Office Equipment
502 North 32nd Street
Billings, MT 59101-6003
Phone: (406) 245-5151
Fax: (406) 245-7516

Western Office Equipment
317 2nd Street South
Great Falls, MT 59405-1802
Phone: (406) 761-7473
Fax: (406) 761-0245

Nebraska

Eakes Office Plus
2911 13th Street
Columbus, NE 68601-4829
Phone: (402) 564-2679
Fax: (402) 564-0295

Eakes Office Plus
Suite 201
2630 North Yager Road
Fremont, NE 68025-7800
Phone: (402) 941-5001
Fax: (402) 941-5002

Eakes Office Plus
617 West Third Street
Grand Island, NE 68801-5946
Phone: (308) 382-8026
Fax: (308) 382-7401

Eakes Office Plus
839 West Second Street
Hastings, NE 68901-5099
Phone: (402) 463-2537
Fax: (402) 463-6802

Eakes Office Plus
2401 Avenue A
Kearney, NE 68847-5498
Phone: (308) 234-2538
Fax: (308) 234-2540

Eakes Office Plus
110 N 35th Street
Lincoln, NE 68503
Phone: (402) 438-6700
Fax: (402) 438-6701

Eakes Office Plus
1803 North 6th Street
Beatrice, NE 68310
Phone: (402) 228-7202
Fax: (402) 228-0262

Eakes Office Plus
120 Norris Avenue
McCook, NE 69001
Phone: (308) 345-5447
Fax: (308) 345-5237

Eakes Office Plus
510 W. 13th Street
Souix City, NE 68776
Phone: (402) 412-2334

Eakes Office Plus
201 South 1st Street
Norfolk, NE 68701-5303
Phone: (402) 371-4181
Fax: (402) 371-5139

Eakes Office Plus
520 North Vine Street
North Platte, NE 69101-3954
Phone: (308) 534-7800
Fax: (308) 534-3936

Eakes Office Plus
710 North Lincoln Ave.
York, NE 68467
Phone: (402) 362-5442
Fax: (402) 362-7530

Sheppard's Business Interiors Inc.
725 South 72nd Street
Omaha, NE 68114-4665
Phone: (402) 393-8888
Fax: (402) 393-0113

Nevada

Machabee Office Environments
6435 Sunset Corporate Drive
Las Vegas, NV 89120-2798
Phone: (702) 263-8800
Fax: (702) 263-8801

Machabee Office Environments
1335 Greg Parkway #101
Sparks, NV 89431
Phone: (775) 329-3145
Fax: (775) 786-5710

New Hampshire

Red Thread
Suite 103
650 Elm Street
Manchester, NH 03101-1160
Phone: (603) 668-5511
Fax: (603) 668-6851

New Jersey

Arbee Associates
1531 South Washington Avenue
Piscataway, NJ 08854-3815
Phone: (732) 424-3900
Fax: (732) 752-6034

Concepts Office Furnishings
280 North Midland Avenue
Building J
Saddle Brook, NJ 07663-5708
Phone: (201) 727-9110
Fax: (201) 727-9112

Dancker, Sellow, and Douglas
291 Evans Way
Somerville, NJ 08876-3766
Phone: (908) 231-1600
Fax: (908) 231-6469

W.S. Goff Company Inc.
5104 Oakland Blvd.
Mays Landing, NJ 08330-2016
Phone: (609) 625-5600
Fax: (609) 625-5633

New Mexico

Business Environments
5351 Wilshire Avenue, N.E.
Albuquerque, NM 87113-1834
Phone: (505) 888-4400
Fax: (505) 889-9146

New York

AFD Contract Furniture Inc
810 7th Avenue
New York, NY 10019
Phone: (212) 721-7100
Fax: (212) 721-7175

Merkel-Donohue
1 Interstate Avenue
Albany, NY 12205
Phone: (518) 273-9359
Fax: (518) 272-1552

Empire Office Inc.
105 Madison Avenue
New York, NY 10016-8810
Phone: (212) 607-5500
Fax: (212) 607-5654

Merkel-Donohue
1349 University Avenue Suite 2
Rochester, NY 14607
Phone: (585) 325-7696
Fax: (585) 325-3065

Prentice Office Environments
472 Franklin Street
Buffalo, NY 14202-1302
Phone: (716) 884-8452
Fax: (716) 884-0894

Stevens Office Interiors
6804 Manlius Center Road
East Syracuse, NY 13057-3902
Phone: (315) 479-5595
Fax: (315) 428-1688

Waldner's Business Environments
125 Route 110
Farmingdale, NY 11735-4864
Phone: (631) 844-9300
Fax: (631) 694-3503

Waldner's Business Environments
215 Lexington Avenue, 9th Floor
New York, NY 10016-6023
Phone: (212) 696-7500
Fax: (212) 696-7699

Waldner's Business Environments
411 Theodore Fremd Avenue
3rd Floor, South Building
Rye, NY 10580-1410
Phone: (914) 921-8500
Fax: (914) 921-0991

North Carolina

Office Environments Inc.
11407 Granite Street
Charlotte, NC 28273-6429
Phone: (704) 714-7200
Fax: (704) 714-7400

Young Office Environments
of Asheville Inc.
71 Thompson St
Asheville, NC 28803-2328
Phone: (888) 202-0508
Fax: (828) 505-1974

Storr Office Environments Inc.
496 Gallimore Dairy Road
Greensboro, NC 27409-9202
Phone: (336) 217-4500
Fax: (336) 217-4501

Storr Office Environments Inc.
10800 World Trade Blvd.
Raleigh, NC 27617-4200
Phone: (919) 313-3700
Fax: (919) 313-3701

Williams Office Environments Inc.
407 Ray Avenue
Fayetteville, NC 28301-4915
Phone: (910) 483-0354
Fax: (910) 486-4077

North Dakota

Fireside Office Products Inc.
1713 East Bismarck Expressway
Bismarck, ND 58504-6706
Phone: (701) 258-8586
Fax: (701) 223-9598

Hannaher's
1809 13th Avenue North
Grand Forks, ND 58203-2323
Phone: (701) 746-6466
Fax: (701) 746-0737

Hannaher's Inc.
4324 20th Avenue SW
Fargo, ND 58103-4434
Phone: (701) 277-7222
Fax: (701) 277-7097

Ohio

Business Furniture
8 North Main Street
Dayton, OH 45439
Phone: (937) 293-1010
Fax: (937) 293-7501

Loth Inc.
3574 East Kemper Road
Cincinnati, OH 45241-2009
Phone: (513) 554-4900
Fax: (513) 554-8737

Loth Company
855 Grandview Avenue
Columbus, OH 43215-1123
Phone: (614) 487-4000
Fax: (614) 487-4306

NBS
4 North St. Clair Street
Toledo, OH 43604
Phone: (419) 662-2040
Fax: (419) 662-2041

Ohio Desk
34 Swartz Road
Akron, OH 44319
Phone: (330) 499-1030

Ohio Desk
1122 Prospect Avenue
Cleveland, OH 44115-1292
Phone: (216) 623-0600
Fax: (216) 623-0611

Ohio Desk
5100 Market Street
Youngstown, OH 44512
Phone: (330) 782-3331

Oklahoma

Scott Rice
2900 North Hemlock Circle
Broken Arrow, OK 74012-1185
Phone: (918) 362-4300
Fax: (918) 362-4303

Scott Rice
7501 Broadway Ext
Oklahoma City, OK 73116-9015
Phone: (405) 848-2224
Fax: (405) 848-3999

Oregon

Hypn
Suite 103/104
150 SW Scalehouse Loop
Bend, OR 97702
Phone: (541) 317-8777
Fax: (541) 317-2833

Hypn
620 NE 19th Avenue
Portland, OR 97232-2832
Phone: (503) 226-4151
Fax: (503) 226-9233

Pennsylvania

A. Pomerantz & Company
Suite 7000
701 Market Street
Philadelphia, PA 19106-1597
Phone: (215) 408-2100
Fax: (215) 408-2110

Corporate Interiors
Suite 200
161 Washington Street
Conshohocken, PA 19428-2083
Phone: (610) 631-5400
Fax: (610) 631-2720

Interior Workplace Solutions LLC.
145 Stewart Road
Wilkes-Barre, PA 18706
Phone: (570) 288-7211
Fax: (570) 970-5817

Franklin Interiors
Suite 600
2740 Smallman Street
Pittsburgh, PA 15222-4720
Phone: (412) 261-2525
Fax: (412) 255-4089

Participating Steelcase Dealers, continued

Pennsylvania

Interior Workplace Solutions LLC.
6765 Ambassador Drive
Allentown, PA 18106-9510
Phone: (610) 391-0733
Fax: (610) 391-1155

Interior Workplace Solutions LLC.
Suite B-25
2209 Quarry Drive
Reading, PA 19609-1155
Phone: (610) 670-1800
Fax: (610) 670-8181

McCartney's Inc.
819 Howard Avenue
Altoona, PA 16601-4727
Phone: (814) 505-1111
Fax: (814) 949-6197

Phillips Workplace Interiors
6345 Flank Drive
Harrisburg, PA 17112
Phone: (844) 228-2600

South Carolina

Aiken Office Supply Inc.
2560 Whiskey Road
Aiken, SC 29803-9664
Phone: (803) 648-8339
Fax: (803) 649-4470

McWaters Inc.
1104 Shop Road
Columbia, SC 29201-4743
Phone: (803) 256-8303
Fax: (803) 252-5567

McWaters Inc.
3841 Commercial Center Drive
Ladson, SC 29456-4146
Phone: (843) 486-1823

Wulbern-Koval Company Inc.
1111 Morrison Drive
Charleston, SC 29403-3119
Phone: (843) 577-7666
Fax: (843) 577-7299

Young Office Environments
1280 Ridge Road
Greenville, SC 29607-4626
Phone: (864) 281-9500
Fax: (864) 281-9555

South Dakota

Interstate Office Products Inc.
228 South Main Avenue
Sioux Falls, SD 57104-6310
Phone: (605) 339-0300
Fax: (605) 339-1989

Western Stationers
714 Saint Joseph Street
Rapid City, SD 57701-2721
Phone: (605) 342-3310
Fax: (605) 342-4746

Tennessee

Bentco Office Solutions
1501 Stuart Street
Chattanooga, TN 37406
Phone: (423) 756-4437
Fax: (423) 756-6198

Memphis Business Interiors
4539 West Distriplex Drive
Memphis, TN 38118-7280
Phone: (901) 360-8899
Fax: (901) 360-8370

Office Resources Inc.
4020 Armory Oaks Drive
Nashville, TN 37204
Phone: (615) 376-1200
Fax: (615) 376-1245

Workspace Interiors
Suite 300
200 E. Main Street
Kingsport, TN 37660-4354
Phone: (423) 392-2600
Fax: (423) 392-2601

Workspace Interiors
2820 Middlebrook Pike
Knoxville, TN 39721
Phone: (865) 223-5404
Fax: (865) 223-5405

Texas

Abilene Printing & Stationery
218 Cedar Street
Abilene, TX 79601-5720
Phone: (915) 677-2673
Fax: (915) 675-6963

BKM Total Office of Texas
9755 Clifford Drive
Dallas, TX 75220
Phone: (214) 902-7200
Fax: (214) 902-7201

Business Interiors
1111 Valley View Lane
Irving, TX 75061-6008
Phone: (817) 858-2000
Fax: (817) 858-2020

McCoys Inc.
6869 Old Katy Road
Houston, TX 77024-2105
Phone: (713) 862-4600
Fax: (713) 862-7676

Rockford Business Interiors
211 East Riverside Drive
Austin, TX 78704-1203
Phone: (512) 442-0703
Fax: (512) 442-6555

Texas Wilson Office Furniture & Services
5801 George McVay Drive
McAllen, Texas 78503
Phone: (210) 647-8800
Fax: (210) 647-3110

Texas Wilson Office Furniture & Services
6812 Fairgrounds Pkwy
San Antonio, TX 78238-4536
Phone: (210) 647-8800
Fax: (210) 647-3110

West Supply Company
1601 Scurry
Big Spring, TX 79720
Phone: (432) 264-1788
Fax: (432) 264-1789

West Supply Company
2 South Chadbourne Street
San Angelo, TX 76903-5875
Phone: (325) 655-8181
Fax: (325) 655-5480

Utah

MidWest Office Furniture
987 South West Temple
Salt Lake City, UT 84101-2988
Phone: (801) 359-7681
Fax: (801) 355-2713

Vermont

Red Thread
180 Battery St Ste 210
Burlington, VT 05401-5212
Phone: (802) 862-0434
Fax: (802) 862-0729

Virginia

Barrows
1302 Rockland Avenue
Roanoke, VA 24012-3838
Phone: (540) 362-5700
Fax: (540) 362-4826

Creative Office Environments
11798 North Lakeridge Boulevard
Ashland, VA 23005-8152
Phone: (804) 329-0400
Fax: (804) 321-3134

Creative Office Environments LLC
650 Peter Jefferson Parkway #140
Charlottesville, VA 22911
Phone: (434) 327-1898
Fax: (434) 327-1896

Creative Office Environments LLC
Suite C
500 Woodlake Circle
Chesapeake, VA 23320-2807
Phone: (757) 549-4801
Fax: (757) 549-2795

reDistrict
Suite 30
66 Canal Center Plaza
Arlington, VA 22314
Phone: (703) 276-8901
Fax: (703) 276-8908

Washington

OpenSquare
6th Floor
5601 Sixth Avenue South
Seattle, WA 98108-2522
Phone: (206) 768-8000
Fax: (206) 768-0236

OpenSquare
126 South Sheridan Street
Spokane, WA 99202-1527
Phone: (509) 483-1000
Fax: (509) 483-1011

Wisconsin

Atmosphere Commercial Interiors
999 Fourier Drive Suite 200
Madison, WI 53717
Phone: (608) 257-0521
Fax: (608) 257-1859

Puerto Rico

AFD Contract Furnishings
Suite 250
350 Chardon Avenue
Torre Chardon
San Juan, Puerto Rico 00918-2123
Phone: (787) 754-2938
Fax: (787) 754-8076

Showrooms

Atlanta

Steelcase Inc.
Suite AL-175
303 Peachtree Center
Atlanta, GA 30303
Phone: (404) 523-2201

Chicago

Steelcase Worklife Chicago
Suite 300
222 Merchandise Mart
Chicago, IL 60654-1174
Phone: (312) 321-3720

Chicago

Coalesse
Suite 1032
222 Merchandise Mart
Chicago, IL 60654
Phone: (312) 467-1783

Dallas

Steelcase Inc.
1616 Hi Line Drive
Dallas, TX 75207
Phone: (214) 871-3044

Grand Rapids

Steelcase Inc.
901 44th Street, SE
Grand Rapids, MI 49508-7594
Phone: (616) 247-2710

New York

Steelcase Worklife New York
4 Columbus Circle
New York, NY 10019-1100
Phone: (212) 445-8800

Philadelphia

Steelcase Inc.
One Liberty Place
1650 Market Street, 3rd Floor
Philadelphia, PA 19103-7307
Phone: (215) 561-5331

San Francisco

Steelcase Inc.
Suite 110
475 Brannan Street
San Francisco, CA 94107
Phone: (415) 344-6700

Santa Monica

Steelcase Inc.
1217 2nd Street
Santa Monica, CA 90401-1180
Phone: (310) 633-2200

Washington D.C.

Steelcase Inc.
1121 14th Street NW
4th Floor
Washington, DC 20005

Manufacturing Sites

Amex de Mexico

Calle 5 Sur No.160
Ciudad Industrial
Tijuana, Mexico B.C. 22500
Phone: 52-662-342-6234

Athens

214 Durham Drive
Athens, AL 35611
Phone: (256) 232-8112

Grand Rapids Wood Furniture

4100 68th Street SE
Caledonia, MI 49316
Phone: (616) 698-5735

Kentwood Distribution Center

4384 52nd Street SE
Kentwood, MI 49512-9673

Kentwood West

4360 52nd Street SE
Kentwood, MI 49512

Details

901 44th Street SE
Grand Rapids, MI 49508
Phone: (616) 247-2710

Reynosa Plant

Ave. Prologis S/N Ed. 8 Suite
801 Prologis Park Pharr Bridge
Reynosa,
Tamaulipas, Mx CP. 88780
Phone: 52-899-263-9000



Seating/Occasional Tables

Statement of Line 20

Lounge Seating	45
Guest/Side/Stack Seating	175
Collaboration Seating	217
Occasional Tables	225
Outdoor	243

Statement of Line

Lounge Seating

Await Lounge System

Specifying
▶ Page 46

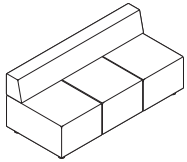

Three-Seat Lounge

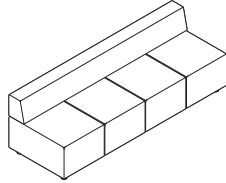

Four-Seat Lounge

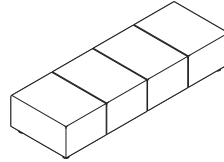

Four-Seat Bench



Mobile Ottoman

Await Lounge System Connector Benches and Tables

Specifying
▶ Pages 48 and 49

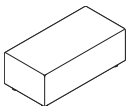

1-Section Connector Bench

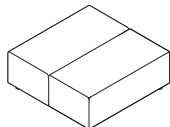

2-Section Connector Bench

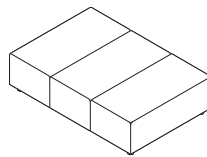

3-Section Connector Bench

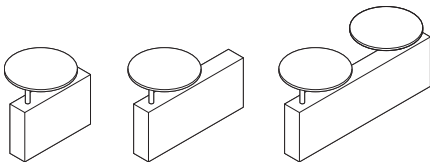

Connector Tables

Bix Lounge System Lounge Chairs

Specifying
▶ Page 52

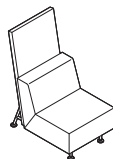

Bix Lounge System Sled Lounge Chairs

Specifying
▶ Page 53

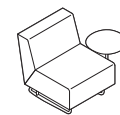
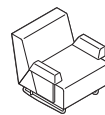
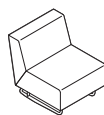

Statement of Line

Lounge Seating, continued

Bix Lounge System Sectional Seating

Specifying
► Page 54

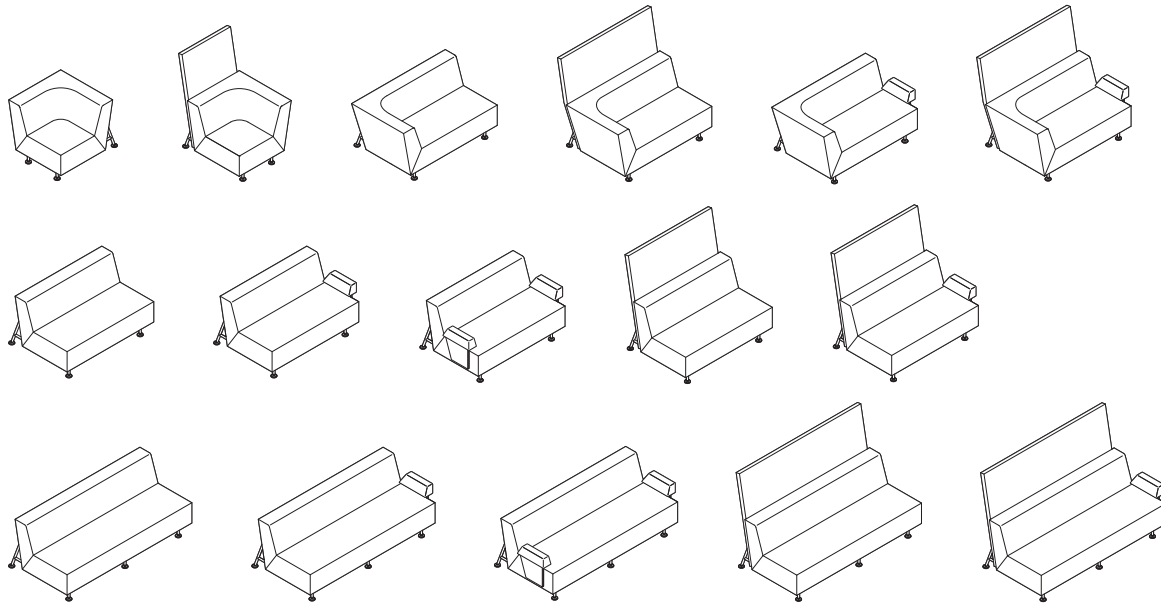

Bix Lounge System Benches

Specifying
► Page 60

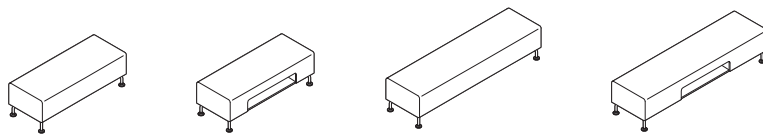

Bix Lounge System Podium

Specifying
► Page 62

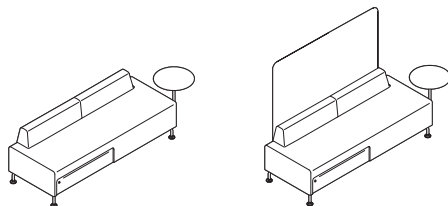

Statement of Line *continued*

Lounge Seating, continued

Bix Lounge System Bridge Tables

Specifying
▶ Page 68

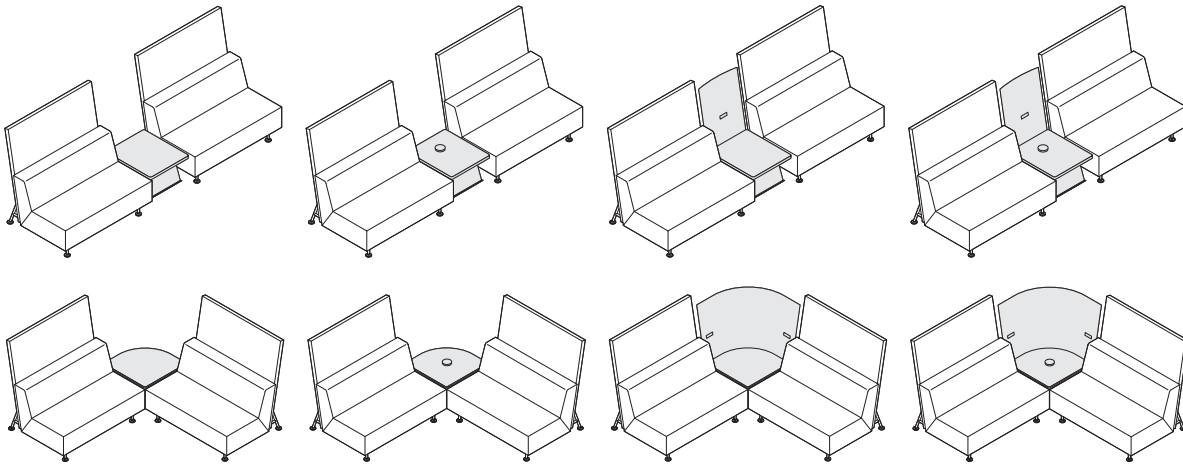

Bob Lounge Chairs

Specifying
▶ Page 74



Lounge Chair



Lounge Chair with
Headrest

Statement of Line

Lounge Seating, continued

Circa Lounge System

Specifying
► Page 76

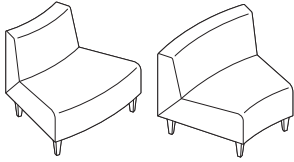

30° Outside/Inside
Facing Wedge
1-Seat Lounge

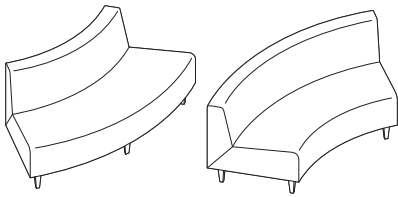

60° Wedge
2-Seat Lounge

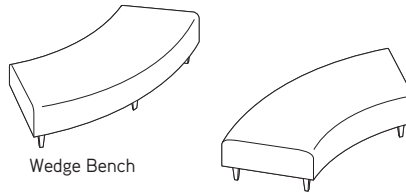

Wedge Bench

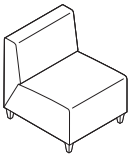

Straight Seat
1-Seat Lounge

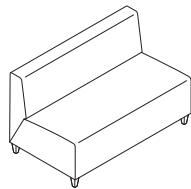

Straight
2-Seat Lounge

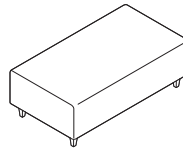

Straight Bench

Lounge Seating, continued

Circa Lounge System Upholstered Modular Arm Rests and Ottoman

Specifying
▶ Page 80



Straight Armrest
Intermediate without Legs

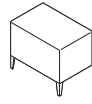

Straight Armrest
End-of-Run with Two Legs



15° Inside Armrest
Intermediate without Legs

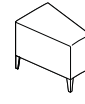

15° Inside Armrest
End-of-Run with Two Legs



15° Outside Armrest
Intermediate without Legs



15° Outside Armrest
End-of-Run with Two Legs

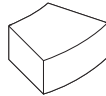

30° Inside Armrest
Intermediate without Legs

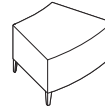

30° Inside Armrest
End-of-Run with Two Legs

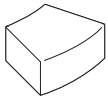

30° Outside Armrest
Intermediate without Legs

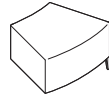

30° Outside Armrest
End-of-Run with Two Legs

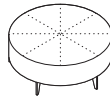

Round Ottoman

Statement of Line

Lounge Seating, continued

Circa Lounge System Modular Tables

Specifying
► Page 82

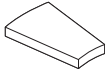

15° Low Wedge Table, Ganging

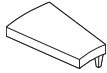

15° Low Wedge Table, End-of-Run, Two Legs

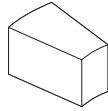

15° High Wedge Table, Ganging

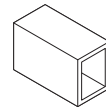

Straight High Table, Ganging

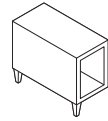

Straight High Table, End-of-Run, Two Legs

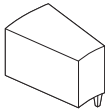

15° High Wedge Table, End-of-Run, Two Legs

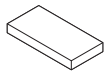

Straight Low Table, Ganging

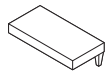

Straight Low Table, End-of-Run, Two Legs

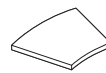

30° Low Wedge Table, Ganging

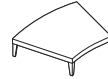

30° Low Wedge Table, End-of-Run, Two Legs



30° End-of-Run with One Leg

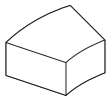

30° High Wedge Table, Ganging

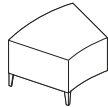

30° High Wedge Table, End-of-Run, Two Legs

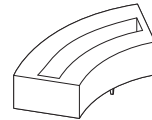

60° Planter Table, Ganging, Two Legs

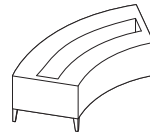

60° Planter Table, End-of-Run, Three Legs

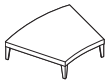

30° Low Wedge Table, Freestanding, Four Legs

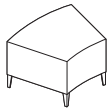

30° High Wedge Table, Freestanding, Four Legs

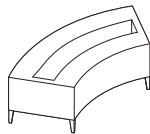

60° Planter Table, Freestanding, Five Legs

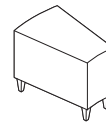

High Wedge

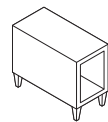

High Straight

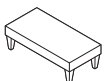

Low Straight

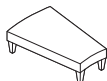

Low Wedge

Circa Lounge System Freestanding Round Table

Specifying
► Page 86

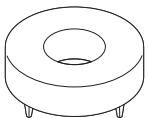

Round

Statement of Line *continued*

Lounge Seating, continued

Coupe Lounge Seating

Specifying
▶ Page 88

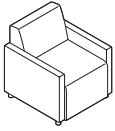

Lounge Chair

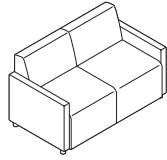

Two-Seat Lounge

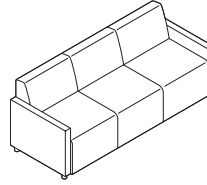

Three-Seat Lounge



Ottoman

Coupe Grande/Mobile Lounge Seating

Specifying
▶ Page 90

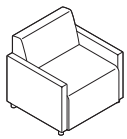

Grande Lounge Chair

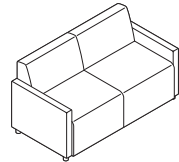

Grande Two-Seat Lounge

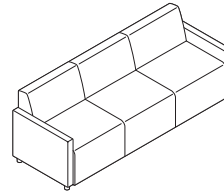

Grande Three-Seat Lounge

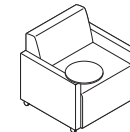

Grande Mobile Lounge Chair

Coupe Wood Lounge Chair

Specifying
▶ Page 92

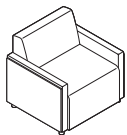

Wood Lounge Chair

Joel Lounge Chair

Specifying
▶ Page 93



Ripple Bench

Specifying
▶ Page 95

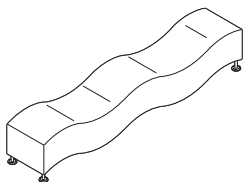

Upholstered Wave Seat

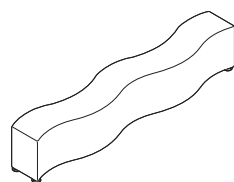

Upholstered Flat Seat

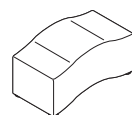

Little Ripple Wave Seat

Statement of Line

Lounge Seating, continued

Sidewalk Lounge Seating

Specifying
▶ Page 96

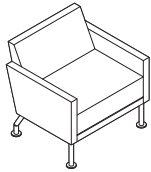

Low-Back Lounge Chair

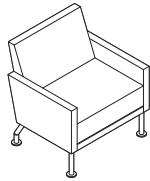

High-Back Lounge Chair

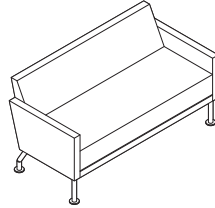

Two-Seat Lounge

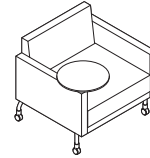

Mobile Low-Back Lounge Chair with Tablet

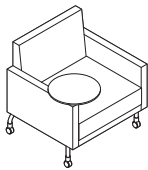

Mobile High-Back Lounge Chair with Tablet



Arm Bolster

Sidewalk Collaborative Lounge Seating

Specifying
▶ Page 100

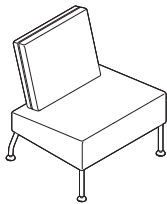

Lounge Chair

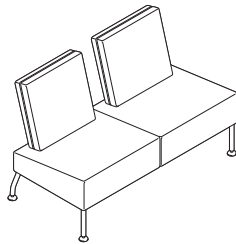

Two-Seat Lounge

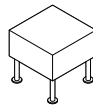

Ottoman

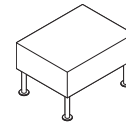
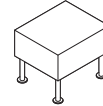

Sidewalk Lounge Seating Benches/Ottoman

Specifying
▶ Page 102

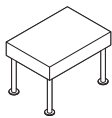

Benches

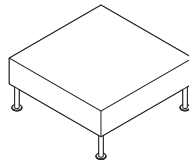
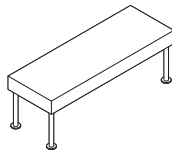
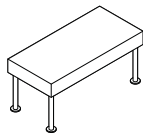

Ottoman

Swathmore Lounge Seating

Specifying
▶ Page 104

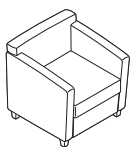

Lounge Chair with Wood Legs

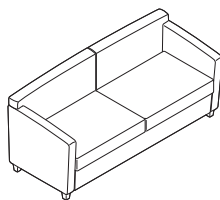

Three-Seat Lounge with Wood Legs

Statement of Line *continued*

Lounge Seating, continued

Swathmore Lounge Seating Louver

Specifying
▶ Page 105

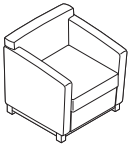

Lounge Chair with
Wood Louver Base

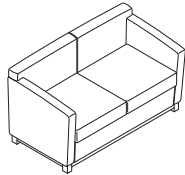

Two-Seat Lounge with
Wood Louver Base

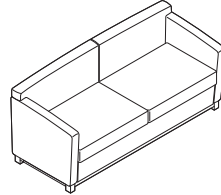

Three-Seat Lounge with
Wood Louver Base

Swathmore Grande Lounge Seating with Wood Legs

Specifying
▶ Page 106

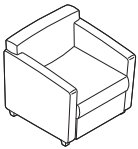

Chair with Wood Legs

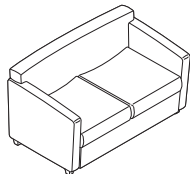

Two-Seat Lounge
with Wood Legs

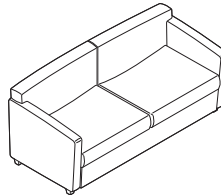

Three-Seat Lounge
with Wood Legs

Swathmore Grande Louver

Specifying
▶ Page 107

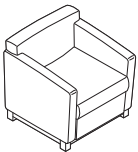

Grande Lounge
Chair with Wood
Louver Base

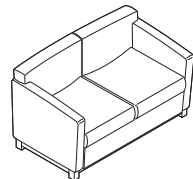

Grande Two-Seat
Lounge with Wood
Louver Base

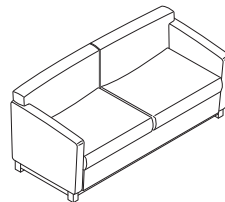

Grande Three-Seat
Lounge with Wood
Louver Base

Swathmore Grande Lounge Seating Mobile

Specifying
▶ Page 108

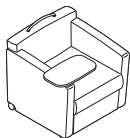

Grande Mobile Lounge
Chair/Tablet Left Facing

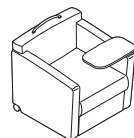

Grande Mobile Lounge
Chair/Tablet Right Facing

Statement of Line

Lounge Seating, continued

Topo Lounge Seating

Specifying
► Pages 110 and 111



Lounge Chair



Lounge Jr.

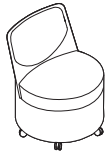

Mobile Lounge
Chair

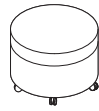

Mobile Lounge Jr.

Davos Lounge Seating

Specifying
► Page 114

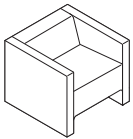

Lounge Chair

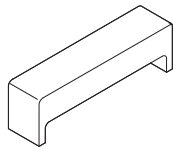

Large Bench

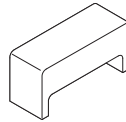

Medium Bench



Small Bench

Hosu Lounge Seating

Specifying
► Page 116

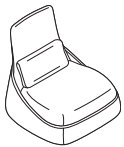

Lounge Chair with
Lumbar Pillow

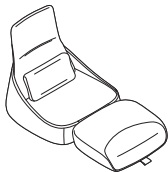

Lounge Chair with Ottoman
and Lumbar Pillow

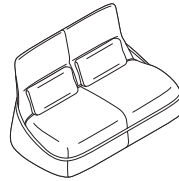

Two-Seat Lounge with
Two Lumbar Pillows

Millbrae Lifestyle Lounge Seating

Specifying
► Page 118

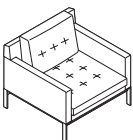

Lounge

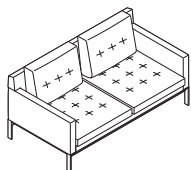

Two-Seat Lounge

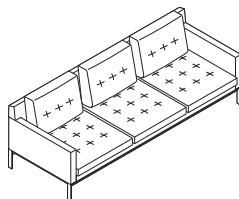

Three-Seat Lounge



Round Arm Bolster



Square Arm Bolster

Lounge Seating, continued

Millbrae Contract Lounge Seating

Specifying
▶ Page 118

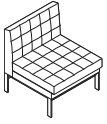

Lounge without Arms

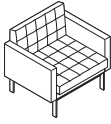

Lounge with Arms



Lounge with Left Arm Facing

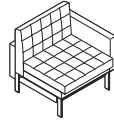

Lounge with Right Arm Facing

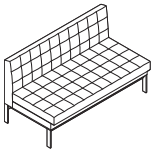

Two-Seat Lounge without Arms

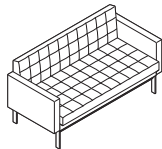

Two-Seat Lounge with Arms

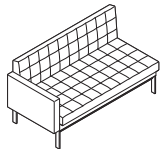

Two-Seat Lounge with Left Arm Facing

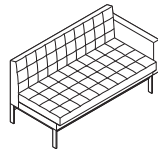

Two-Seat Lounge with Right Arm Facing

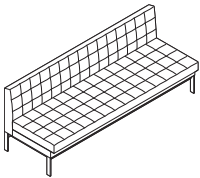

Three-Seat Lounge without Arms

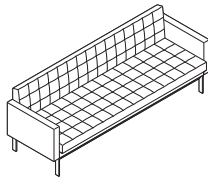

Three-Seat Lounge with Arms

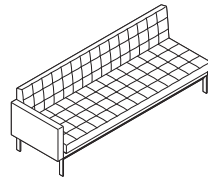

Three-Seat Lounge with Left Arm Facing

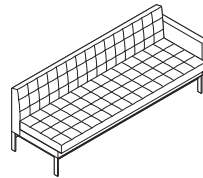

Three-Seat Lounge with Right Arm Facing

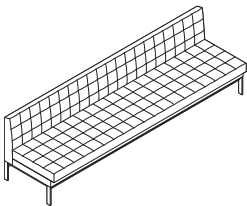

Four-Seat Lounge without Arms

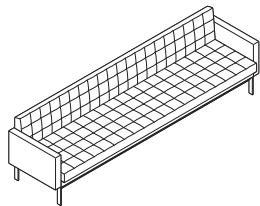

Four-Seat Lounge with Arms

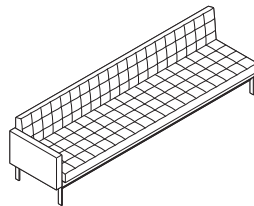

Four-Seat Lounge with Left Arm Facing

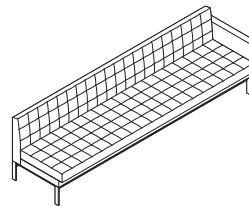

Four-Seat Lounge with Right Arm Facing

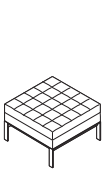

One-Seat Bench

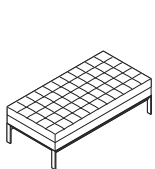

Two-Seat Bench

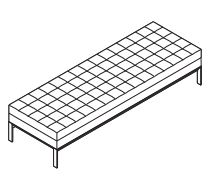

Three-Seat Bench

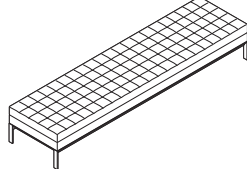

Four-Seat Bench

Statement of Line

Lounge Seating, continued

Lagunitas Lounge System

Specifying
▶ Pages 124-153

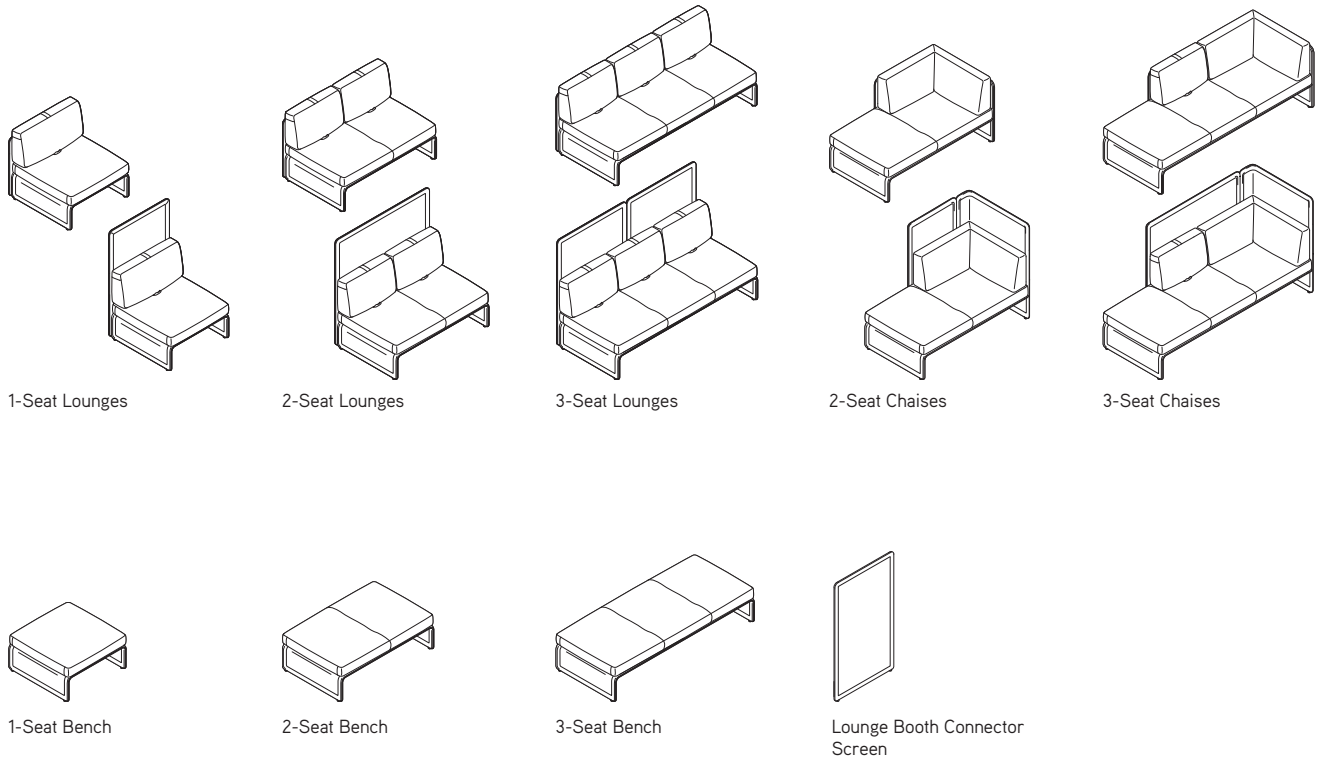

Lagunitas Focus Nook

Specifying
▶ Page 154

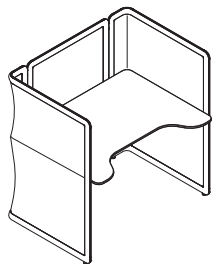

Statement of Line *continued*

Lounge Seating, continued

Passerelle Lounge Seating

Specifying
▶ Pages 156-159

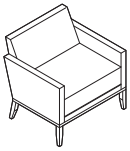

Lounge Chair

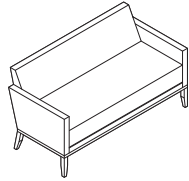

2-Seat Lounge

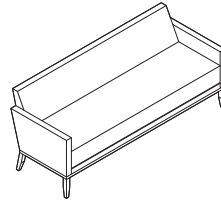

3-Seat Lounge



Arm Bolster

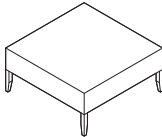
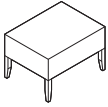

Ottomans

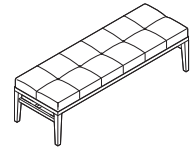
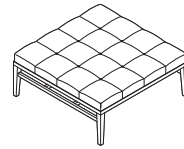
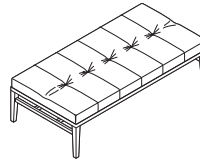

Benches

Switch Lounge Seating

Specifying
▶ Page 160



Lounge Chair

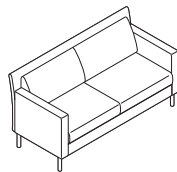

Two-Seat Lounge

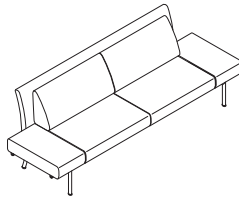

Two-Seat Lounge with Extensions

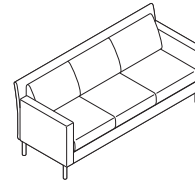

Three-Seat Lounge



Arm Bolster

SW_1 Lounge Seating

Specifying
▶ Page 162



Low-Back Collaborative Lounge Chair



High-Back Collaborative Lounge Chair



Ottoman

Statement of Line

Lounge Seating, continued

Together Bench

Specifying
▶ Page 166

70½"D 96½"W 31"H

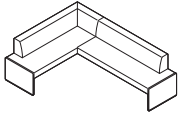

Left Corner with Back 8" Offset

97¼"D 96½"W 31"H

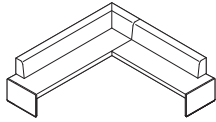

70½"D 96½"W 31"H

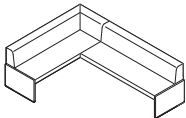

Right Corner with Back 8" Offset

97¼"D 96½"W 31"H

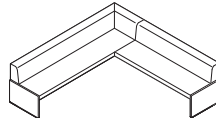

70½"D 123¼"W 31"H

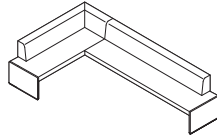

70½"D 123¼"W 31"H

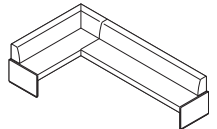

97¼"D 123¼"W 31"H

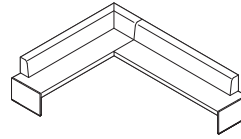

97¼"D 123¼"W 31"H

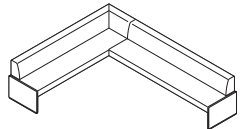

70½"D 96½"W 31"H

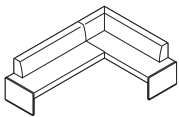

Straight with 8" Offset Back

97¼"D 96½"W 31"H

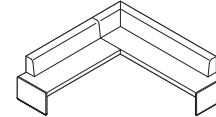

70½"D 123¼"W 31"H

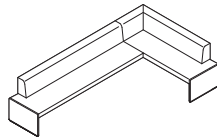

70½"D 123¼"W 31"H

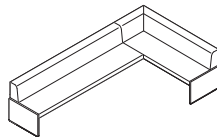

97¼"D 123¼"W 31"H

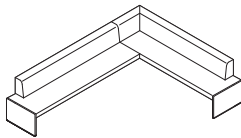

70½"D 96½"W 31"H

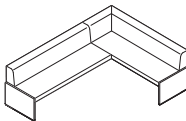

Straight without Back

26¾"D 69¾"W 31"H

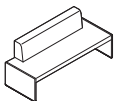

Straight with 8" Offset Back

26¾"D 96½"W 31"H

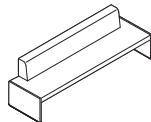

26¾"D 69¾"W 31"H

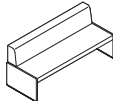

Straight with 1.5" Offset Back

26¾"D 96½"W 31"H

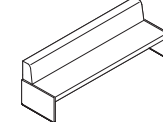

26¾"D 69¾"W 18½"H

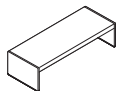

Straight without Back

26¾"D 96½"W 18½"H

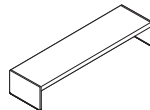

Statement of Line *continued*

Lounge Seating, continued

Visalia Lounge Seating

Specifying
▶ Page 172

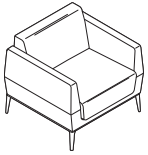

Lounge Chair

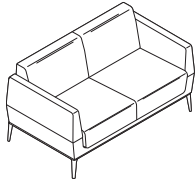

Two-Seat Lounge

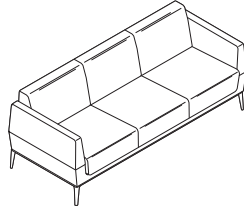

Three-Seat Lounge

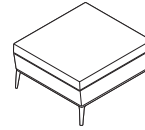

Ottoman

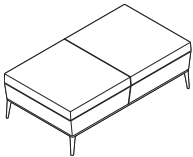

Bench

Statement of Line

Guest/Side/Stack Seating

Bindu Chairs

Specifying
▶ Page 176

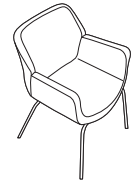

Low-Back Chair



Mid-Back Chair

Bob Chair

Specifying
▶ Page 177



Guest Chair

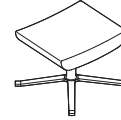

Ottoman

Capa Chair

Specifying
▶ Page 178



Enea Stacker Chairs

Specifying
▶ Pages 180-182



Wood Seat and Back with Arms



Metal Stacker with Upholstered Seat and Back with Arms



Metal Stacker with Upholstered Seat and Wood Back with Arms



Metal Stacker with Polypropylene Seat and Back with Arms



Wood Seat and Back without Arms

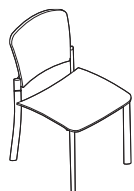

Upholstered Seat and Back without Arms



Upholstered Seat and Wood Back without Arms



Polypropylene Seat and Back without Arms

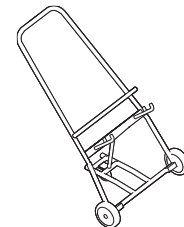

Dolly

Statement of Line *continued*

Guest/Side/Stack Seating, continued

Enea Bar Stools

Specifying
▶ Pages 184-186

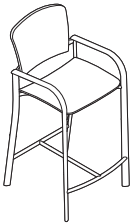

Bar-Height Stool with Wood Seat and Back with Arms

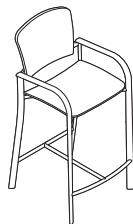

Bar-Height Stool with Upholstered Seat and Back with Arms

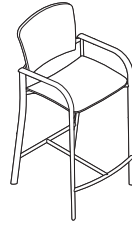

Bar-Height Stool with Upholstered Seat and Wood Back with Arms

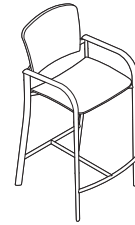

Bar-Height Stool with Polypropylene Seat and Back with Arms

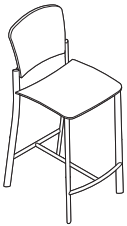

Bar-Height Stool with Wood Seat and Back without Arms

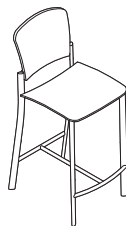

Bar-Height Stool with Upholstered Seat and Back without Arms

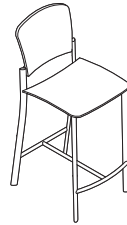

Bar-Height Stool with Upholstered Seat and Wood Back without Arms

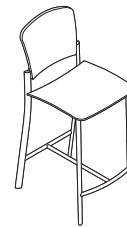

Bar-Height Stool with Polypropylene Seat and Back without Arms

Enea Café Post Stools

Specifying
▶ Pages 188-190



Café Counter-Height Stool with Back



Café Bar-Height Stool with Back



Low Stool Upholstered Seat



Café Counter-Height Stool Upholstered Seat

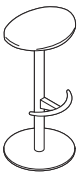

Café Bar-Height Stool Upholstered Seat

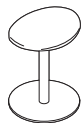

Low Stool



Café Counter-Height Stool

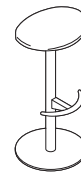

Café Bar-Height Stool

Statement of Line

Guest/Side/Stack Seating, continued

Enea Lottus Seating

Specifying
▶ Pages 192-198



Armless Chair



Cantilever Arm Chair



Aluminum Loop
Arm Chair



Counter-Height
Sled Base Stool



Bar-Height
Sled Base Stool

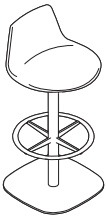

Counter-Height
Post Base Stool

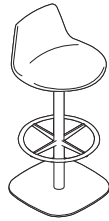

Base-Height
Post Base Stool

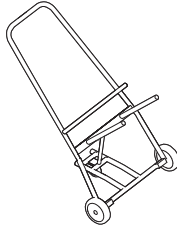

Dolly

Kathryn Chairs

Specifying
▶ Page 200

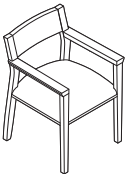

Open Wood Back

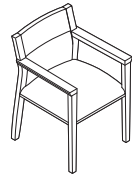

Upholstered Wood
Back Panel

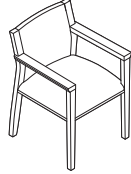

Fully Upholstered
Back

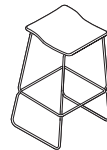

High Stool

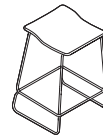

Medium Stool

Last Minute Stools

Specifying
▶ Page 202

Lox Stools

Specifying
▶ Page 203



Counter-Height
Stool



Bar-Height Stool

Statement of Line *continued*

Guest/Side/Stack Seating, continued

Switch Chairs and Stools

Specifying
▶ Pages 204–206

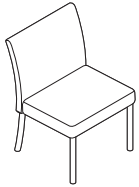

Armless Chair

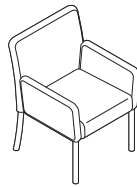

Arm Chair

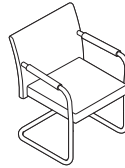

Low-Back Sled Base Chair

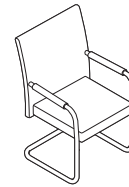

High-Back Sled Base Chair

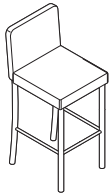

Counter-Height Stool

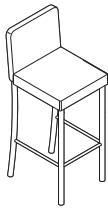

Bar-Height Stool

Montara650 Chairs and Stools

Specifying
▶ Pages 208–212



Wood Shell, Wood Shell with Upholstered Seat, Wood Shell with $\frac{3}{4}$ Upholstery, and Fully Upholstered



Wood Shell with Upholstered Seat, Wood Shell with $\frac{3}{4}$ Upholstery, and Fully Upholstered



Counter-Height or Bar-Height Stool: Wood Shell, Wood Shell with Upholstered Seat, and Fully Upholstered

Montara650 Rocker

Specifying
▶ Page 214



Wood Shell with Upholstered Seat, Wood Shell with $\frac{3}{4}$ Upholstery, and Fully Upholstered

Wrapp Chairs

Specifying
▶ Page 216



Four-Leg Chair

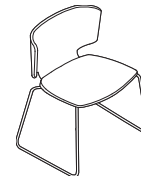

Sled-Base Chair

Statement of Line

Collaboration Seating

Bindu Conference Seating

Specifying
▶ Page 218



Mid-Back Conference
Chair



High-Back Conference
Chair

Chord Conference Seating

Specifying
▶ Page 220



Conference Narrow

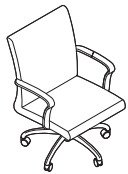

Mid-Back



High-Back Narrow



High-Back/Large Scale

SW_1 Conference Seating

Specifying
▶ Page 222



Conference Chair
with 4-Star Base



Conference Chair
with 5-Star Base

Statement of Line *continued*

Occasional Tables

Await Occasional Tables

Specifying
▶ Page 226

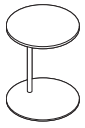

Freestanding
Low Round

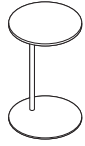

Freestanding
High Round

Bix 18"H Occasional Tables

Specifying
▶ Pages 70 and 228

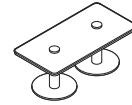
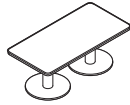

Bix 27" Work-Booth Tables

Specifying
▶ Page 71

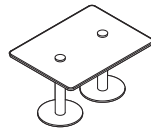
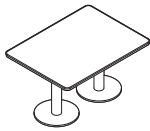

Bix Side Table

Specifying
▶ Pages 72 and 227

Statement of Line

Occasional Tables, continued

Enea Single Base

Specifying
► Page 230

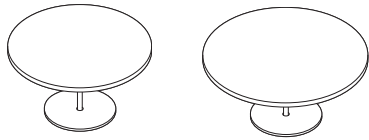

Occasional

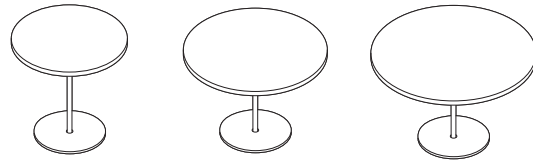

Conference

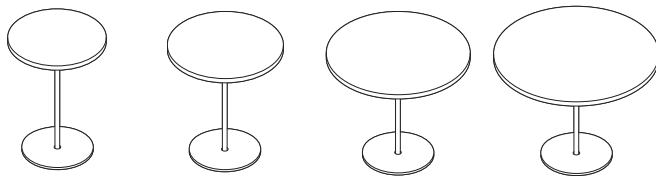

Café/Counter Height

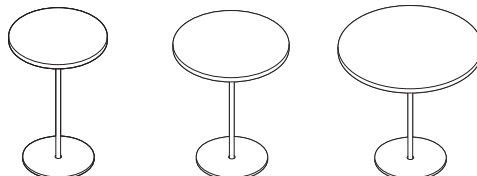

Café/Bar Height

Enea Twin Bases

Specifying
► Pages 232

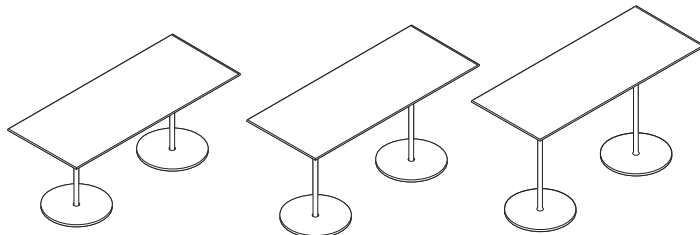

Rectangular

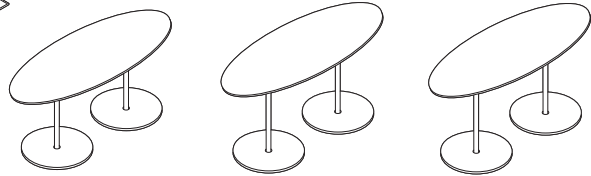

Oval

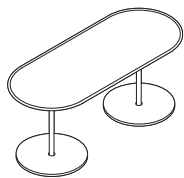

Conference
Racetrack

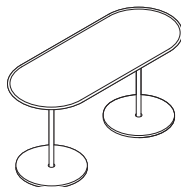

Counter Racetrack

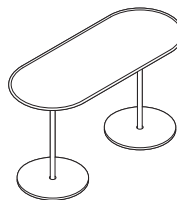

Café Racetrack

Statement of Line *continued*

Occasional Tables, continued

Enea Lottus Tables

Specifying
▶ Pages 235–239

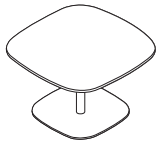

Occasional



Conference

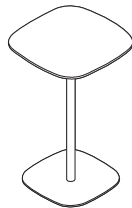

Café Counter Height

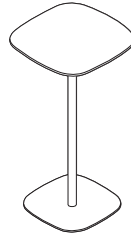

Café Bar Height

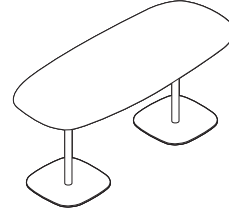

Rectangular

Sebastopol Occasional Tables

Specifying
▶ Page 240

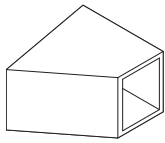

16" High Tables

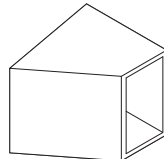
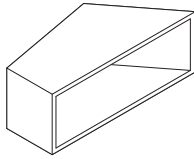

22" High Tables

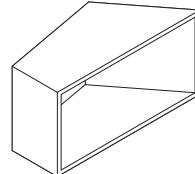

Sidewalk Occasional Tables

Specifying
▶ Page 241

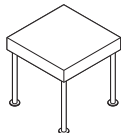
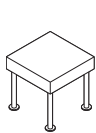

Trees Occasional Tables

Specifying
▶ Page 242

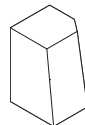

Bevel High–
Embossed Wood

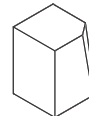

Bevel Medium–
Embossed Wood

Statement of Line

Outdoor

Emu Heaven

Specifying
▶ Pages 244–248

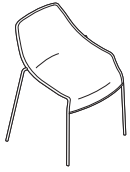

Chair

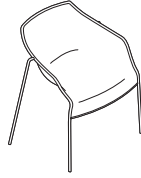

Arm Chair

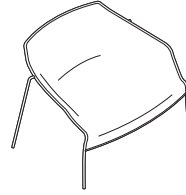

Lounge Chair



Pouf/Side Table



Low Vase

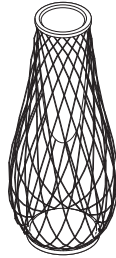

High Vase



Cushions

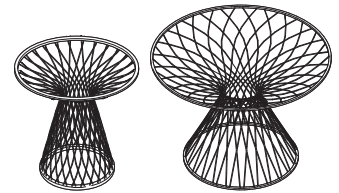

Round Table Bases

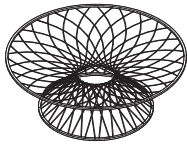

Low Table Base

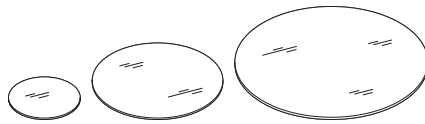

Glass Tops

Tip: Cushions are available for indoor and outdoor use.

Emu Ivy

Specifying
▶ Pages 250–252

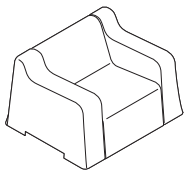

Arm Chair

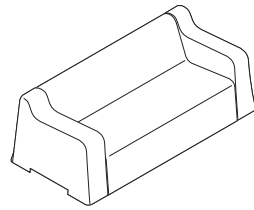

Lounge



Pouf

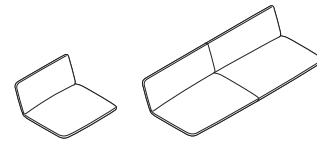

Cushions

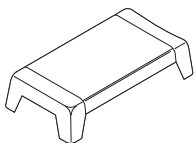

Rectangular Side Table

Tip: Cushions are available for indoor and outdoor use.

Statement of Line *continued*

Outdoor, continued

Emu Re-Trouvé

Specifying
▶ Page 254



Midback Chair



Highback Chair



Pouf



Low Vase Frame



High Vase Frame

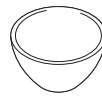

Vase Insert



Cushions

Tip: Cushions are available for indoor and outdoor use.

Emu Round

Specifying
▶ Pages 256–258

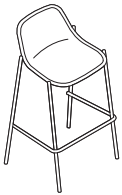

Stool



Chair



Arm Chair

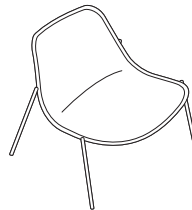

Lounge

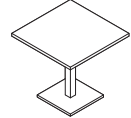
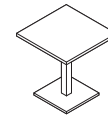
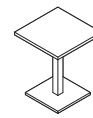

Square Tables



Round Table

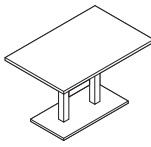

Rectangle Table

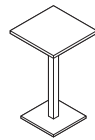

Counter Table

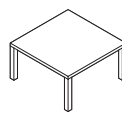

Side Table

Lounge Seating

Await (SIN 711.16)	46
Bix (SIN 711.18)	52
Bob Chairs (SIN 711.18)	74
Circa (SIN 711.17)	76
Coupe (SIN 711.16)	88
Coupe Grande/Mobile (SIN 711.16)	90
Joel Lounge (SIN 711.16)	93
Ripple (SIN 711.16)	95
Sidewalk (SIN 711.16)	96
Swathmore (SIN 711.16)	104
Swathmore Grande (SIN 711.16)	106
Topo (SIN 711.16)	110
Davos (SIN 711.16)	114
Hosu (SIN 711.16)	116
Millbrae (SIN 711.16)	118
Lagunitas (SIN 711.16)	124
Lagunitas Focus Nook (SIN 711.16)	154
Passerelle (SIN 711.16)	156
Switch (SIN 711.16)	160
SW_1 (SIN 711.18)	162
Together Bench (SIN 711.16)	166
Visalia (SIN 711.16)	172

Await Lounge System

DESIGN E00S

SIN 711.16

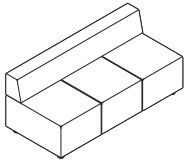

Tip: Recommended leathers are Elmosoft Grade C and Elmorustical Grade E.

Tip: Special color match, consult Customer Service.

Tip: For Customer's Own Material or Leather, see necessary requirements, important processing instructions, and ordering information.
 ▶ Page 262

Tip: Contrasting option available only on lounges.

Tip: Please include sketch for ganging.

Tip: Fabrics and leathers will appear loose with comfort wrinkles when upholstered.

	Standard Includes	Required to Specify
▶ Need help? Product details, see <i>Coalesse Seating and Outdoor Specification Guide</i>	<ul style="list-style-type: none"> • Frame: unibody construction with finger-jointed plywood • Multiple densities of polyurethane foam and polyester foam and polyester fiber • Lounge: <ul style="list-style-type: none"> - Seat and back: fabric or leather - Legs: black high-density polyurethane resin - Glides: non-adjustable • Ottoman: <ul style="list-style-type: none"> - Seat: fabric or leather - Casters: non-locking 	<ol style="list-style-type: none"> 1 Style number 2 Number of fabrics if contrasting fabric style number is selected 3 Fabric or leather color number for upholstery on seat and back 4 Options, if selected (see below) ▶ See <i>Surface Materials</i> , page 260.

	Options	Price	Required to Specify
Surface Materials	<ul style="list-style-type: none"> • Contrasting fabric 	+\$121 per fabric	Add suffix K to the style number and select fabric color number.
	Fire code seating <ul style="list-style-type: none"> • 3-seat lounge, four-seat lounge, and bench • Ottoman 	+\$615 +\$237	Specify with <i>fire code seating</i> . Specify with <i>fire code seating</i> . ▶ See <i>Fire Code Seating</i> , page 264.
	Acrylic backer <ul style="list-style-type: none"> • 3-seat lounge • Four-seat lounge • Four-seat bench • Ottoman 	+\$ 55 +\$ 69 +\$ 47 +\$ 15	Specify with <i>acrylic backer</i> . Specify with <i>acrylic backer</i> . Specify with <i>acrylic backer</i> . Specify with <i>acrylic backer</i> . ▶ See <i>Surface Materials</i> , page 260.
Floor Mount Legs	<ul style="list-style-type: none"> • Floor mount legs 	+\$126 per unit	Specify with <i>floor mount legs</i>
Related Products	<ul style="list-style-type: none"> • Connector benches • Occasional tables 		▶ Page 48 ▶ Page 226

Await Lounge System

DESIGN EOOS

SIN 711.16

Specification Information

Style Number	Base Prices										Leather Grades:		
	Fabric Grades:										COL	C	E
	COM	6	7	8	9	10	11	12	13	14			

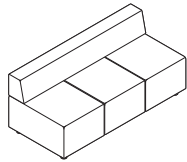

Overall: 30"D 66"W 27"H
 Inside: 22"D 66"W 27"H
 Seat: 16½"H
 Arm: 10½"H

3-Seat Lounge

460-3	\$3429	\$3477	\$3516	\$3581	\$3781	\$3911	\$4061	\$4165	\$4350	\$4608	\$3576	\$6192	\$6665
--------------	--------	--------	--------	--------	--------	--------	--------	--------	--------	--------	--------	--------	--------

COM/yds = 5¾, COL/sq ft = 147

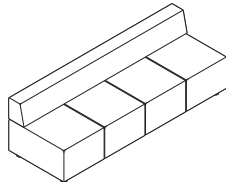

Overall: 30"D 88"W 27"H
 Inside: 22"D 88"W 27"H
 Seat: 16½"H
 Arm: 10½"H

Four-Seat Lounge

460-4	\$4181	\$4282	\$4330	\$4413	\$4666	\$4829	\$5018	\$5149	\$5383	\$5708	\$4328	\$7645	\$8236
--------------	--------	--------	--------	--------	--------	--------	--------	--------	--------	--------	--------	--------	--------

COM/yds = 7¼, COL/sq ft = 185

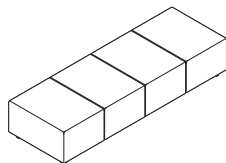

Overall: 30"D 88"W 16½"H
 Seat: 16½"H

Four-Seat Bench

460-4B	\$3102	\$3142	\$3179	\$3241	\$3433	\$3556	\$3699	\$3800	\$3977	\$4223	\$3249	\$5753	\$6200
---------------	--------	--------	--------	--------	--------	--------	--------	--------	--------	--------	--------	--------	--------

COM/yds = 5½, COL/sq ft = 100



Overall: 22"D 22"W 16½"H

Mobile Ottoman

460-H	\$ 767	\$ 767	\$ 778	\$ 795	\$ 847	\$ 881	\$ 920	\$ 948	\$ 996	\$1062	\$1016	\$1665	\$1783
--------------	--------	--------	--------	--------	--------	--------	--------	--------	--------	--------	--------	--------	--------

COM/yds = 1½, COL/sq ft = 33

Await Lounge System Connector Benches

DESIGN E00S

SIN 711.16

Tip: Recommended leathers are Elmosoft Grade C and Elmorustical Grade E.

Tip: Special color match, consult Customer Service.

Tip: For Customer's Own Material or Leather, see necessary requirements, important processing instructions, and ordering information.

► Page 262

Tip: Please include sketch for ganging.

Tip: Fabrics and leathers will appear loose with comfort wrinkles when upholstered.

Standard Includes		Required to Specify			
► Need help?	<ul style="list-style-type: none"> Bench: fabric or leather Frame: unibody construction with finger-jointed plywood Multiple densities of polyurethane foam Fixed seat Top and double needle stitching on seams Legs: black high-density polyurethane resin Glides 	1 Style number	2 Fabric or leather color number for upholstery on bench		
Product details, see <i>Coalesse Seating and Outdoor Specification Guide</i>		3 Options, if selected (see below)	► See <i>Surface Materials</i> , page 260.		
Options		Price		Required to Specify	
Surface Materials	Fire code seating			Specify with <i>fire code seating</i> .	
	• One-section connector bench	+\$237		Specify with <i>fire code seating</i> .	
	• Two-section connector bench	+\$473		Specify with <i>fire code seating</i> .	
	• Three-section connector bench	+\$615		► See <i>Fire Code Seating</i> , page 264.	
	Acrylic backer			Specify with <i>acrylic backer</i> .	
	• One-section connector bench	+\$ 23		Specify with <i>acrylic backer</i> .	
	• Two-section connector bench	+\$ 34		Specify with <i>acrylic backer</i> .	
	• Three-section connector bench	+\$ 49		► See <i>Surface Materials</i> , page 260.	
Floor Mount Legs	• Field-installed Floor mount legs	+\$126 per unit		Specify with <i>floor mount legs</i> .	
Related Products	• Occasional tables			► Page 226	

Specification Information

Style Number	Base Prices														Leather Grades:		
	Fabric Grades:														COL	C	E
	COM	6	7	8	9	10	11	12	13	14							

One-Section Connector Bench

461-1B	\$1416	\$1416	\$1431	\$1457	\$1535	\$1586	\$1645	\$1686	\$1758	\$1859	\$1638	\$2636	\$2815
COM/yds = 2¼, COL/sq ft = 53													

Two-Section Connector Bench

461-2B	\$2176	\$2176	\$2201	\$2244	\$2374	\$2459	\$2557	\$2624	\$2745	\$2913	\$2345	\$4036	\$4342
COM/yds = 3¾, COL/sq ft = 105													

Three-Section Connector Bench

461-3B	\$2997	\$3037	\$3074	\$3136	\$3328	\$3451	\$3594	\$3695	\$3872	\$4118	\$3144	\$5532	\$5959
COM/yds = 5½, COL/sq ft = 145													

Ganging Kit

460-GANGPKG	\$ 47
--------------------	-------

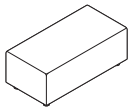

Overall: 44"D 22"W 16½"H

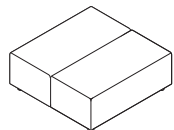

Overall: 44"D 44"W 16½"H

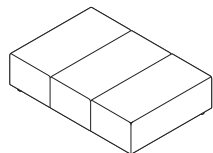

Overall: 44"D 66"W 16½"H

Await Lounge System Connector Tables

DESIGN E00S

SIN 711.16

Tip: Await connector tables are not recommended to be used in end-of-run applications.

Tip: Await connector tables are not made for ganging to Await mobile ottoman.

Standard Includes	Required to Specify
<ul style="list-style-type: none"> Need help? Product details, see <i>Coalesse Seating and Outdoor Specification Guide</i> Connector table frame: panels are black, white, or gray Top: High-Pressure Laminate top with matching 3 mm edge band Glass top (tablet): <ul style="list-style-type: none"> - 1/2" thick - Radiused edges Ganging plate: 1/4" thick ganging plates attach to the bottom of units to the seating unit plates 	<ol style="list-style-type: none"> Style number Laminate top and tablets, if selected: <ul style="list-style-type: none"> 2746 Black 2730 Arctic White 290N North Sea Glass color number for top, if selected <ul style="list-style-type: none"> ▶ See <i>Coalesse Surface Materials Reference Guide</i>.

Related Products
<ul style="list-style-type: none"> Occasional tables ▶ Page 226 Lounge seating ▶ Page 47

Specification Information

Style Number	Prices								
	Laminate Top:			Glass Tablet:					
	No Tablet	Tablet	Power/Data	Clear Green/Clear Green Frosted Glass Tablet	Clear Green/Frosted Tablet and Power/Data	Absolute Clear/Clear Frosted Glass Tablet	Absolute Clear/Clear Frosted Tablet and Power/Data	Colored Glass Tablet	Colored Tablet and Power/Data
460-SE22	\$662	\$1520	N.A.	\$1580	N.A.	\$1603	N.A.	\$1768	N.A.
460-SE22PD	N.A.	N.A.	\$1807	N.A.	\$1914	N.A.	\$1935	N.A.	\$2099

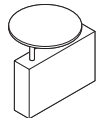

Overall: 20"D 4 1/2"W 15 3/4"H
With Tablet: 15 3/4" Dia. and 25 3/8"H

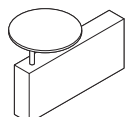

Overall: 28"D 4 1/2"W 15 3/4"H
With Tablet: 15 3/4" Dia. and 25 3/8"H

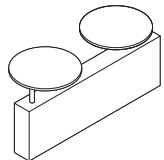

Overall: 42"D 4 1/2"W 25 3/8"H
With Tablets: 15 3/4" Dia. and 25 3/8"H

460-SE30	\$757	\$1615	N.A.	\$1675	N.A.	\$1703	N.A.	\$1863	N.A.
460-SE30PD	N.A.	N.A.	\$1908	N.A.	\$2015	N.A.	\$2036	N.A.	\$2200
460-SE44	\$931	\$2647	N.A.	\$2692	N.A.	\$2738	N.A.	\$3062	N.A.
460-SE44PD	N.A.	N.A.	\$2929	N.A.	\$3070	N.A.	\$3115	N.A.	\$3445

Await Ganging Diagrams by Model (Underside View)

DESIGN E00S

SIN 711.16

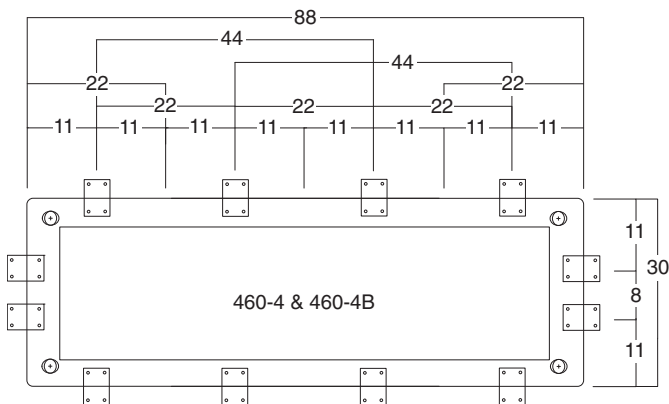
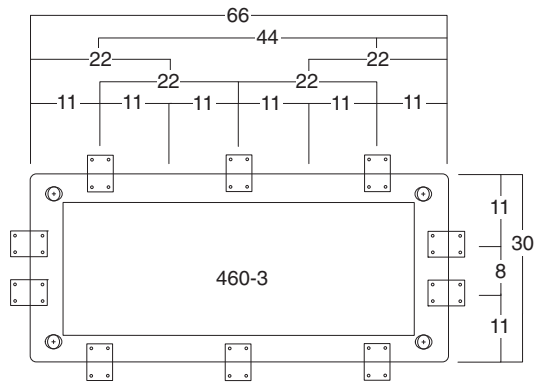
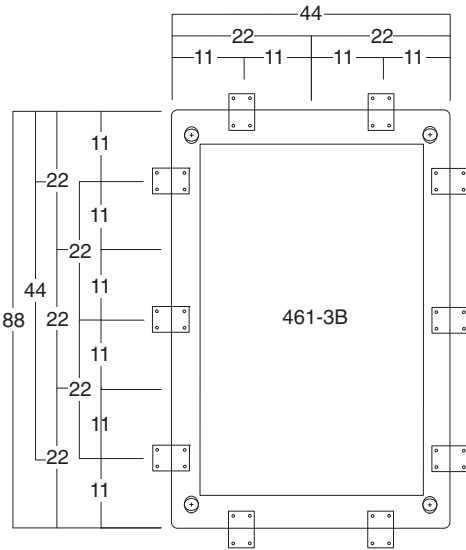
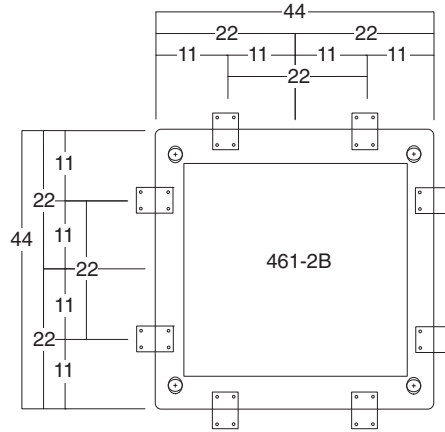
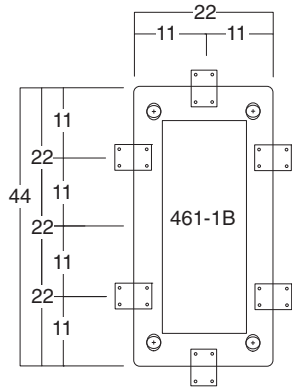

Await Multi-Fabric Diagram

SIN 711.16

TO: _____

FROM: _____

DATE: _____

FAX...888.413.5161

A Seat (upholstery selections default for entire unit if B is not selected):

B Back: _____

\$121 list per contrasting fabric specified. List price based on highest fabric grade usage.

Specify Model below:

460-3K

460-4K

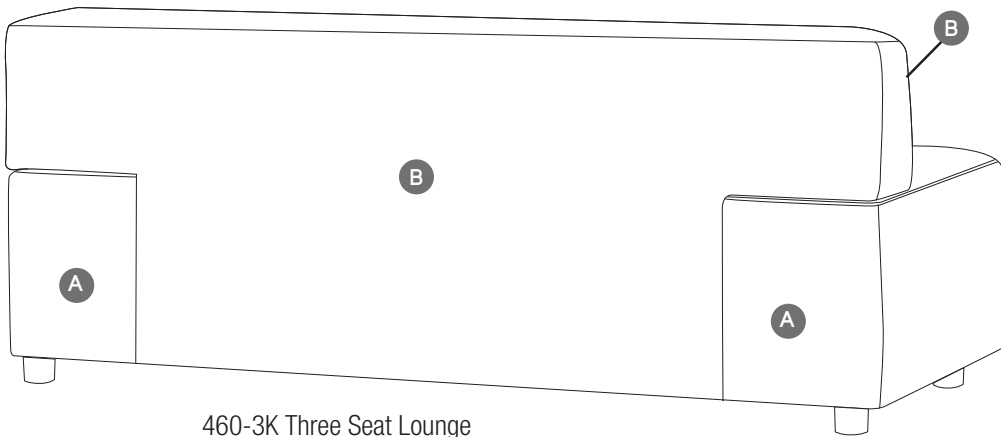
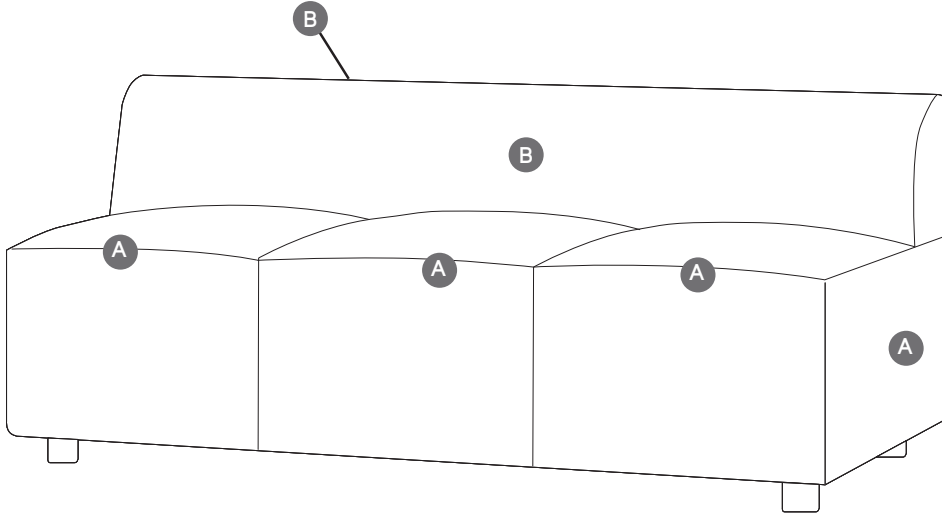

460-3K Three Seat Lounge

Bix Lounge System Lounge Chairs

DESIGN METRO DESIGN GROUP

SIN 711.18

Tip: Fabric for the seat and back is specified separate from the back screen, if selected. For a monochromatic look, specify the same fabric for both the seat and back and back screen.

Tip: Fabrics and leathers will appear loose with comfort wrinkles when upholstered.

Tip: When specifying fabric in different price grades, the highest price grade prevails.

Tip: The COM yards and COL square footage listed on this page reflect the requirements for a single fabric that are based on non-directional 54"W material applied railroaded. For multi-fabric COM requirements, please refer to Multi-Fabric Yardage.
▶ Page 65

Standard Includes	Required to Specify
▶ Need help? Product details, see <i>Coalesse Seating and Outdoor Specification Guide</i>	1 Style number 2 Number of fabrics if contrasting fabric style number is selected 3 Fabric or leather color number for seat, back, and arms, if selected 4 Paint color number for legs and glides 5 Fabric color number for back screen, if selected 6 Options, if selected (see below) ▶ See <i>Surface Materials</i> , page 260.
<ul style="list-style-type: none"> • Seat, back, and arms, if selected: fabric or leather • Legs: paint • Adjustable glides: paint to match legs • Back screen, if selected: fabric 	

Options	Price	Required to Specify
Surface Materials <ul style="list-style-type: none"> • Contrasting fabric 	+\$121 per fabric	Add suffix K to the style number and select fabric color number.
Acrylic backer <ul style="list-style-type: none"> • Lounge chair • Lounge chair with arms • Lounge chair with back screen 	+\$ 35 +\$ 47 +\$ 57	Specify with acrylic backer. Specify with acrylic backer. Specify with acrylic backer. ▶ See <i>Surface Materials</i> , page 260.
Seat Height <ul style="list-style-type: none"> • 18" seat height 	+\$233	Specify with 18" seat height.
Related Products <ul style="list-style-type: none"> • Sectional seating • Bench • Podium • Occasional tables • Work booth tables • Side table 		▶ Page 54 ▶ Page 60 ▶ Page 62 ▶ Page 70 ▶ Page 71 ▶ Page 72

Specification Information

Style Number	Base Prices														Leather Grades:		
	Fabric Grades:														COL	C	E
	COM	6	7	8	9	10	11	12	13	14							

Lounge Chair

BL26XX	\$1744	\$1744	\$1763	\$1795	\$1890	\$1952	\$2024	\$2073	\$2163	\$2286	\$1905	\$2841	\$3011
COM/yds = 2¾, COL/sq ft = 55													

Lounge Chair with Arms

BL26AA	\$2440	\$2440	\$2465	\$2508	\$2638	\$2723	\$2821	\$2888	\$3009	\$3177	\$2668	\$3695	\$3900
COM/yds = 3¾, COL/sq ft = 73													

Lounge Chair with Back Screen

BLB26XX	\$2516	\$2520	\$2551	\$2602	\$2759	\$2860	\$2977	\$3059	\$3204	\$3405	\$2731	\$4134	\$4408
Chair: COM/yds = 2¾, COL/sq ft = 55													
Screen: COM/yds = 1¾													

Back cushion



Seat

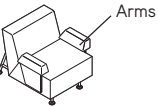

Arms

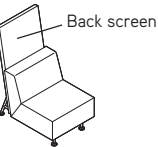

Back screen

Bix Lounge System Sled Lounge Chairs

DESIGN METRO DESIGN GROUP

SIN 711.18

Tip: The COM yards and COL square footage listed on this page reflect the requirements for a single fabric that are based on non-directional 54"W material applied railroaded. For multi-fabric COM requirements, please refer to Multi-Fabric Yardage.
▶ Page 65

Tip: When specifying fabric in different price grades, the highest price grade prevails.

Standard Includes	Required to Specify
<p>▶ Need help? Product details, see <i>Coalesse Seating and Outdoor Specification Guide</i></p> <ul style="list-style-type: none"> • Seat, back, and arms, if selected: fabric or leather • Base and tablet support, if selected: paint • Glides • Tablet surface: bronco onyx vinyl 	<ol style="list-style-type: none"> 1 Style number 2 Number of fabrics if contrasting fabric style number is selected 3 Fabric or leather color number for seat, back, and arms, if selected 4 Paint color number for base and tablet, if selected 5 Options, if selected (see below) <p>▶ See <i>Surface Materials</i>, page 260.</p>

Options	Price	Required to Specify
<p>Surface Materials</p> <ul style="list-style-type: none"> • Contrasting fabric 	+\$121 per fabric	Add suffix K to the style number and select fabric color number.
<p>Acrylic backer</p> <ul style="list-style-type: none"> • Lounge chair and lounge chair with tablet arm • Lounge chair with arms 	<p>+\$ 35</p> <p>+\$ 47</p>	<p>Specify with acrylic backer.</p> <p>Specify with acrylic backer. ▶ See <i>Surface Materials</i>, page 260.</p>
<p>Related Products</p> <ul style="list-style-type: none"> • Bench • Podium • Occasional tables • Side table 		<p>▶ Page 60</p> <p>▶ Page 62</p> <p>▶ Page 70</p> <p>▶ Page 72</p>

Specification Information															
Style Number	Base Prices												Leather Grades:		
	Fabric Grades:												COL	C	E
COM	6	7	8	9	10	11	12	13	14						

Sled Lounge Chair

BLD26XX	\$1558	\$1558	\$1577	\$1609	\$1704	\$1766	\$1838	\$1887	\$1977	\$2100	\$1647	\$2655	\$2825
COM/yds = 2¾, COL/sq ft = 55													

Sled Lounge Chair with Arms

BLD26AA	\$2254	\$2254	\$2279	\$2322	\$2452	\$2537	\$2635	\$2702	\$2823	\$2991	\$2370	\$3509	\$3714
COM/yds = 3¾, COL/sq ft = 73													

Sled Lounge Chair with Left-Hand Facing Tablet Arm

BLD26TX	\$1882	\$1882	\$1901	\$1933	\$2028	\$2090	\$2162	\$2211	\$2301	\$2424	\$2003	\$2979	\$3149
COM/yds = 2¾, COL/sq ft = 55													

Sled Lounge Chair with Right-Hand Facing Tablet Arm

BLD26XT	\$1882	\$1882	\$1901	\$1933	\$2028	\$2090	\$2162	\$2211	\$2301	\$2424	\$2003	\$2979	\$3149
COM/yds = 2¾, COL/sq ft = 55													

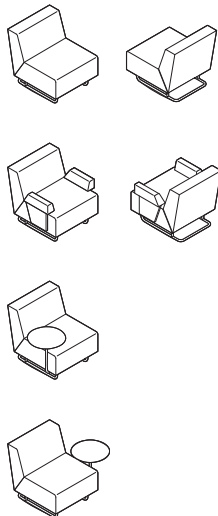

Bix Lounge System Sectional Seating

DESIGN METRO DESIGN GROUP

SIN 711.18

Tip: Fabric for the seat and back is specified separate from the back screen, if selected. For a monochromatic look, specify the same fabric for both the seat and back, and back screen.

Tip: The COM yards and COL square footage listed on these pages reflect the requirements for a single fabric that are based on non-directional 54"W material applied railroaded. For multi-fabric COM requirements, please refer to Multi-Fabric Yardage.
▶ Page 65

Tip: When specifying fabric in different price groups, the highest price group prevails.

Tip: Fabrics and leathers will appear loose with comfort wrinkles when upholstered.

Tip: 30"W corner sections are available with two seat fabric direction options – railroaded or cut-right. Illustrations assume a striped patterned fabric.
▶ Page 66

Standard Includes	Required to Specify
<ul style="list-style-type: none"> ▶ Need help? Product details, see <i>Coalesse Seating and Outdoor Specification Guide</i> • Seat, back, and arms, if selected: fabric or leather • Legs: paint • Adjustable glides: paint to match legs • Back screen, if selected: fabric 	<ol style="list-style-type: none"> 1 Style number 2 Number of fabrics if contrasting fabric style number is selected 3 Fabric or leather color number for seat, back, and arms, if selected 4 Paint color number for legs and glides 5 Fabric color number for back screen, if selected 6 Options, if selected (see below) <p>▶ See <i>Surface Materials</i>, page 260.</p>

Options	Price	Required to Specify
Surface Materials <ul style="list-style-type: none"> • Contrasting fabric 	+\$121 per fabric	Add suffix K to the style number and select fabric color number.
Acrylic backer <ul style="list-style-type: none"> • 30"W sections • 30"W sections with back screen • 48"W sections • 48"W sections with back screen • 54"W sections • 72"W sections • 54"W and 72"W sections with back screen 	+\$ 47 +\$ 69 +\$ 55 +\$ 85 +\$ 85 +\$ 74 +\$128	Specify with acrylic backer. Specify with acrylic backer. Specify with acrylic backer. Specify with acrylic backer. Specify with acrylic backer. Specify with acrylic backer. Specify with acrylic backer. ▶ See <i>Surface Materials</i> , page 260.
Seat Height <ul style="list-style-type: none"> • 18" seat height 	+\$233	Specify with 18" seat height.
Related Products <ul style="list-style-type: none"> • Bench • Podium • Bridge tables • Occasional tables • Work booth tables • Side table 		▶ Page 60 ▶ Page 62 ▶ Page 68 ▶ Page 70 ▶ Page 71 ▶ Page 72

Specification Information

Style Number	Base Prices														Leather Grades:		
	Fabric Grades:														COL	C	E
COM	6	7	8	9	10	11	12	13	14								

30"W Corner Section–Left Section with Seat Fabric Railroaded

BSC30LA	\$2500	\$2504	\$2535	\$2586	\$2743	\$2844	\$2961	\$3043	\$3188	\$3389	\$2711	\$3733	\$3938
----------------	--------	--------	--------	--------	--------	--------	--------	--------	--------	--------	--------	--------	--------

COM/yds = 4½, COL/sq ft = 90

▶ Specification Information, continued on next page

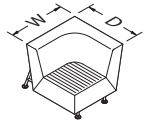

Bix Lounge System Sectional Seating

DESIGN METRO DESIGN GROUP

SIN 711.18

► Specification Information, continued from previous page

Specification Information

Style Number	Base Prices										Leather Grades:		
	Fabric Grades:										COL	C	E
	COM	6	7	8	9	10	11	12	13	14			

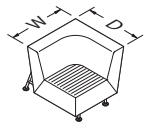

30"W Corner Section–Left Section with Seat Fabric Cut-Right

BSC30LB	\$2500	\$2504	\$2535	\$2586	\$2743	\$2844	\$2961	\$3043	\$3188	\$3389	\$2711	\$3733	\$3938
----------------	--------	--------	--------	--------	--------	--------	--------	--------	--------	--------	--------	--------	--------

COM/yds = 4½, COL/sq ft = 90

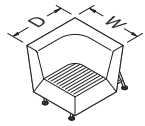

30"W Corner Section–Right Section with Seat Fabric Railroaded

BSC30RA	\$2500	\$2504	\$2535	\$2586	\$2743	\$2844	\$2961	\$3043	\$3188	\$3389	\$2711	\$3733	\$3938
----------------	--------	--------	--------	--------	--------	--------	--------	--------	--------	--------	--------	--------	--------

COM/yds = 4½, COL/sq ft = 90

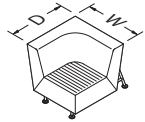

30"W Corner Section–Right Section with Seat Fabric Cut-Right

BSC30RB	\$2500	\$2504	\$2535	\$2586	\$2743	\$2844	\$2961	\$3043	\$3188	\$3389	\$2711	\$3733	\$3938
----------------	--------	--------	--------	--------	--------	--------	--------	--------	--------	--------	--------	--------	--------

COM/yds = 4½, COL/sq ft = 90

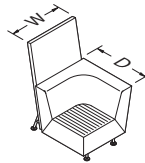

30"W Corner Section with Back Screen–Left Section with Seat Fabric Railroaded

BSCB30LA	\$3279	\$3354	\$3397	\$3471	\$3698	\$3844	\$4014	\$4132	\$4341	\$4632	\$3598	\$5285	\$5627
-----------------	--------	--------	--------	--------	--------	--------	--------	--------	--------	--------	--------	--------	--------

Chair: COM/yds = 4½, COL/sq ft = 90
Screen: COM/yds = 2

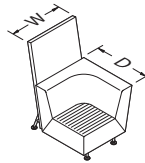

30"W Corner Section with Back Screen–Left Section with Seat Fabric Cut-Right

BSCB30LB	\$3279	\$3354	\$3397	\$3471	\$3698	\$3844	\$4014	\$4132	\$4341	\$4632	\$3598	\$5285	\$5627
-----------------	--------	--------	--------	--------	--------	--------	--------	--------	--------	--------	--------	--------	--------

Chair: COM/yds = 4½, COL/sq ft = 90
Screen: COM/yds = 2

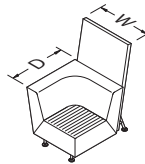

30"W Corner Section with Back Screen–Right Section with Seat Fabric Railroaded

BSCB30RA	\$3279	\$3354	\$3397	\$3471	\$3698	\$3844	\$4014	\$4132	\$4341	\$4632	\$3598	\$5285	\$5627
-----------------	--------	--------	--------	--------	--------	--------	--------	--------	--------	--------	--------	--------	--------

Chair: COM/yds = 4½, COL/sq ft = 90
Screen: COM/yds = 2

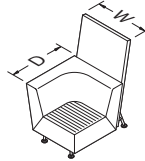

30"W Corner Section with Back Screen–Right Section with Seat Fabric Cut-Right

BSCB30RB	\$3279	\$3354	\$3397	\$3471	\$3698	\$3844	\$4014	\$4132	\$4341	\$4632	\$3598	\$5285	\$5627
-----------------	--------	--------	--------	--------	--------	--------	--------	--------	--------	--------	--------	--------	--------

Chair: COM/yds = 4½, COL/sq ft = 90
Screen: COM/yds = 2

► Specification Information, continued on next page

Bix Lounge System Sectional Seating *continued*

DESIGN METRO DESIGN GROUP

SIN 711.18

Tip: Extended corner sections are standard with a railroaded seat and back fabric direction.
 ▶Page 66

Tip: Fabrics and leathers will appear loose with comfort wrinkles when upholstered.

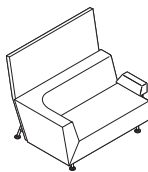
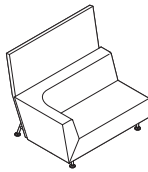
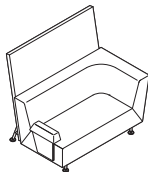
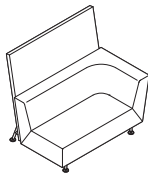
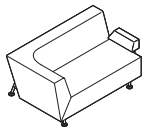
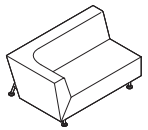
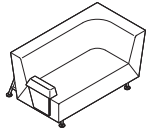
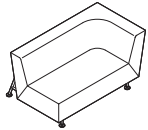

►Specification Information, continued from previous page

Specification Information

Style Number	Base Prices														Leather Grades:		
	Fabric Grades:														COL	C	E
	COM	6	7	8	9	10	11	12	13	14							

54"W Extended Corner Section–Left Section

BSE54LX	\$3428	\$3520	\$3567	\$3647	\$3891	\$4048	\$4230	\$4357	\$4583	\$4897	\$3769	\$5241	\$5547
COM/yds = 7, COL/sq ft = 140													

54"W Extended Corner Section–Left Section with Arm

BSE54LA	\$3759	\$3868	\$3919	\$4005	\$4266	\$4434	\$4630	\$4766	\$5007	\$5343	\$4144	\$5765	\$6107
COM/yds = 7½, COL/sq ft = 149													

54"W Extended Corner Section–Right Section

BSE54RX	\$3428	\$3520	\$3567	\$3647	\$3891	\$4048	\$4230	\$4357	\$4583	\$4897	\$3769	\$5241	\$5547
COM/yds = 7, COL/sq ft = 140													

54"W Extended Corner Section–Right Section with Arm

BSE54RA	\$3759	\$3868	\$3919	\$4005	\$4266	\$4434	\$4630	\$4766	\$5007	\$5343	\$4144	\$5765	\$6107
COM/yds = 7½, COL/sq ft = 149													

54"W Extended Corner Section–Left Section with Back Screen

BSEB54LX	\$4400	\$4632	\$4706	\$4832	\$5216	\$5463	\$5750	\$5949	\$6303	\$6796	\$4873	\$7469	\$7998
Chair: COM/yds = 7, COL/sq ft = 140													
Screen: COM/yds = 4													

54"W Extended Corner Section–Left Section with Back Screen and Arm

BSEB54LA	\$4729	\$4979	\$5057	\$5188	\$5589	\$5847	\$6146	\$6355	\$6725	\$7241	\$5245	\$8184	\$8782
Chair: COM/yds = 7½, COL/sq ft = 149													
Screen: COM/yds = 4													

54"W Extended Corner Section–Right Section with Back Screen

BSEB54RX	\$4400	\$4632	\$4706	\$4832	\$5216	\$5463	\$5750	\$5949	\$6303	\$6796	\$4873	\$7469	\$7998
Chair: COM/yds = 7, COL/sq ft = 140													
Screen: COM/yds = 4													

54"W Extended Corner Section–Right Section with Back Screen and Arm

BSEB54RA	\$4729	\$4979	\$5057	\$5188	\$5589	\$5847	\$6146	\$6355	\$6725	\$7241	\$5245	\$8184	\$8782
Chair: COM/yds = 7½, COL/sq ft = 149													
Screen: COM/yds = 4													

►Specification Information, continued on next page

Bix Lounge System Sectional Seating

DESIGN METRO DESIGN GROUP

SIN 711.18

Tip: Straight sections are standard with a railroaded seat and back fabric direction.

▶ Page 66

▶ Specification Information, continued from previous page

Specification Information

Style Number	Base Prices										Leather Grades:		
	Fabric Grades:										COL	C	E
	COM	6	7	8	9	10	11	12	13	14			

48"W Straight Section

BSS48XX	\$2582	\$2586	\$2617	\$2668	\$2825	\$2926	\$3043	\$3125	\$3270	\$3471	\$2805	\$4105	\$4360
----------------	--------	--------	--------	--------	--------	--------	--------	--------	--------	--------	--------	--------	--------

COM/yds = 4½, COL/sq ft = 90

48"W Straight Section with Left Arm

BSS48AX	\$2913	\$2934	\$2968	\$3026	\$3200	\$3311	\$3443	\$3533	\$3694	\$3918	\$3181	\$4531	\$4805
----------------	--------	--------	--------	--------	--------	--------	--------	--------	--------	--------	--------	--------	--------

COM/yds = 5, COL/sq ft = 99

48"W Straight Section with Right Arm

BSS48XA	\$2913	\$2934	\$2968	\$3026	\$3200	\$3311	\$3443	\$3533	\$3694	\$3918	\$3181	\$4531	\$4805
----------------	--------	--------	--------	--------	--------	--------	--------	--------	--------	--------	--------	--------	--------

COM/yds = 5, COL/sq ft = 99

48"W Straight Section with Two Arms

BSS48AA	\$3243	\$3283	\$3320	\$3382	\$3574	\$3697	\$3840	\$3941	\$4118	\$4364	\$3555	\$5056	\$5362
----------------	--------	--------	--------	--------	--------	--------	--------	--------	--------	--------	--------	--------	--------

COM/yds = 5½, COL/sq ft = 108

48"W Straight Section with Back Screen

BSSB48XX	\$3482	\$3591	\$3642	\$3728	\$3989	\$4157	\$4353	\$4489	\$4730	\$5066	\$3831	\$6165	\$6624
-----------------	--------	--------	--------	--------	--------	--------	--------	--------	--------	--------	--------	--------	--------

Chair: COM/yds = 4½, COL/sq ft = 90
Screen: COM/yds = 3

48"W Straight Section with Back Screen and Left Arm

BSSB48AX	\$3812	\$3939	\$3993	\$4084	\$4363	\$4543	\$4752	\$4896	\$5155	\$5512	\$4205	\$6592	\$7068
-----------------	--------	--------	--------	--------	--------	--------	--------	--------	--------	--------	--------	--------	--------

Chair: COM/yds = 5, COL/sq ft = 99
Screen: COM/yds = 3

48"W Straight Section with Back Screen and Right Arm

BSSB48XA	\$3812	\$3939	\$3993	\$4084	\$4363	\$4543	\$4752	\$4896	\$5155	\$5512	\$4205	\$6592	\$7068
-----------------	--------	--------	--------	--------	--------	--------	--------	--------	--------	--------	--------	--------	--------

Chair: COM/yds = 5, COL/sq ft = 99
Screen: COM/yds = 3

▶ Specification Information, continued on next page

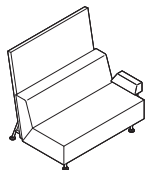
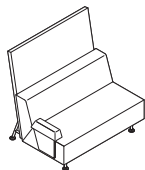
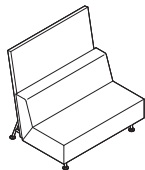
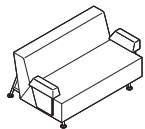
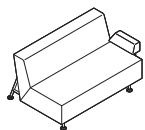
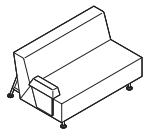
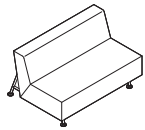

Lounge Seating

Bix Lounge System Sectional Seating *continued*

DESIGN METRO DESIGN GROUP

SIN 711.18

Tip: Straight sections are standard with a railroaded seat and back fabric direction.

▶ Page 66

Tip: Fabrics and leathers will appear loose with comfort wrinkles when upholstered.

▶ Specification Information, continued from previous page

Specification Information

Style Number	Base Prices														Leather Grades:		
	Fabric Grades:														COL	C	E
	COM	6	7	8	9	10	11	12	13	14							

72"W Straight Section

BSS72XX	\$3603	\$3678	\$3721	\$3795	\$4022	\$4168	\$4338	\$4456	\$4665	\$5609	\$3966	\$5609	\$5951
----------------	--------	--------	--------	--------	--------	--------	--------	--------	--------	--------	--------	--------	--------

COM/yds = 6½, COL/sq ft = 130

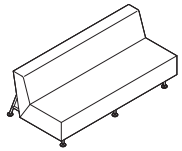

72"W Straight Section with Left Arm

BSS72AX	\$3931	\$4023	\$4070	\$4150	\$4394	\$4551	\$4733	\$4860	\$5086	\$5400	\$4343	\$6130	\$6506
----------------	--------	--------	--------	--------	--------	--------	--------	--------	--------	--------	--------	--------	--------

COM/yds = 7, COL/sq ft = 139

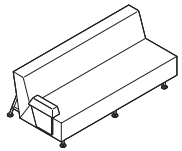

72"W Straight Section with Right Arm

BSS72XA	\$3931	\$4023	\$4070	\$4150	\$4394	\$4551	\$4733	\$4860	\$5086	\$5400	\$4343	\$6130	\$6506
----------------	--------	--------	--------	--------	--------	--------	--------	--------	--------	--------	--------	--------	--------

COM/yds = 7, COL/sq ft = 139

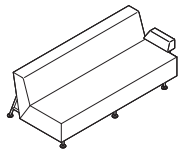

72"W Straight Section with Two Arms

BSS72AA	\$4263	\$4372	\$4423	\$4509	\$4770	\$4938	\$5134	\$5270	\$5511	\$6657	\$4717	\$6657	\$7064
----------------	--------	--------	--------	--------	--------	--------	--------	--------	--------	--------	--------	--------	--------

COM/yds = 7½, COL/sq ft = 148

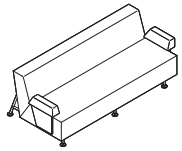

72"W Straight Section with Back Screen

BSSB72XX	\$4803	\$5035	\$5109	\$5235	\$5619	\$5866	\$6153	\$6352	\$6706	\$7199	\$5332	\$8548	\$9196
-----------------	--------	--------	--------	--------	--------	--------	--------	--------	--------	--------	--------	--------	--------

Chair: COM/yds = 6½, COL/sq ft = 130
Screen: COM/yds = 4½

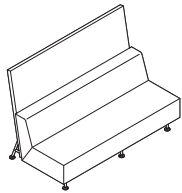

72"W Straight Section with Back Screen and Left Arm

BSSB72AX	\$5130	\$5380	\$5458	\$5589	\$5990	\$6248	\$6547	\$6756	\$7126	\$7642	\$5704	\$9068	\$9750
-----------------	--------	--------	--------	--------	--------	--------	--------	--------	--------	--------	--------	--------	--------

Chair: COM/yds = 7, COL/sq ft = 139
Screen: COM/yds = 4½

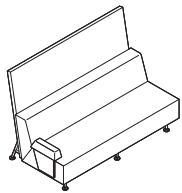

72"W Straight Section with Back Screen and Right Arm

BSSB72XA	\$5130	\$5380	\$5458	\$5589	\$5990	\$6248	\$6547	\$6756	\$7126	\$7642	\$5704	\$9068	\$9750
-----------------	--------	--------	--------	--------	--------	--------	--------	--------	--------	--------	--------	--------	--------

Chair: COM/yds = 7, COL/sq ft = 139
Screen: COM/yds = 4½

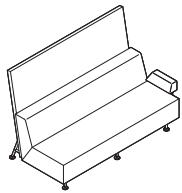

Bix Multi-Fabric Diagram

DESIGN METRO DESIGN GROUP

SIN 711.18

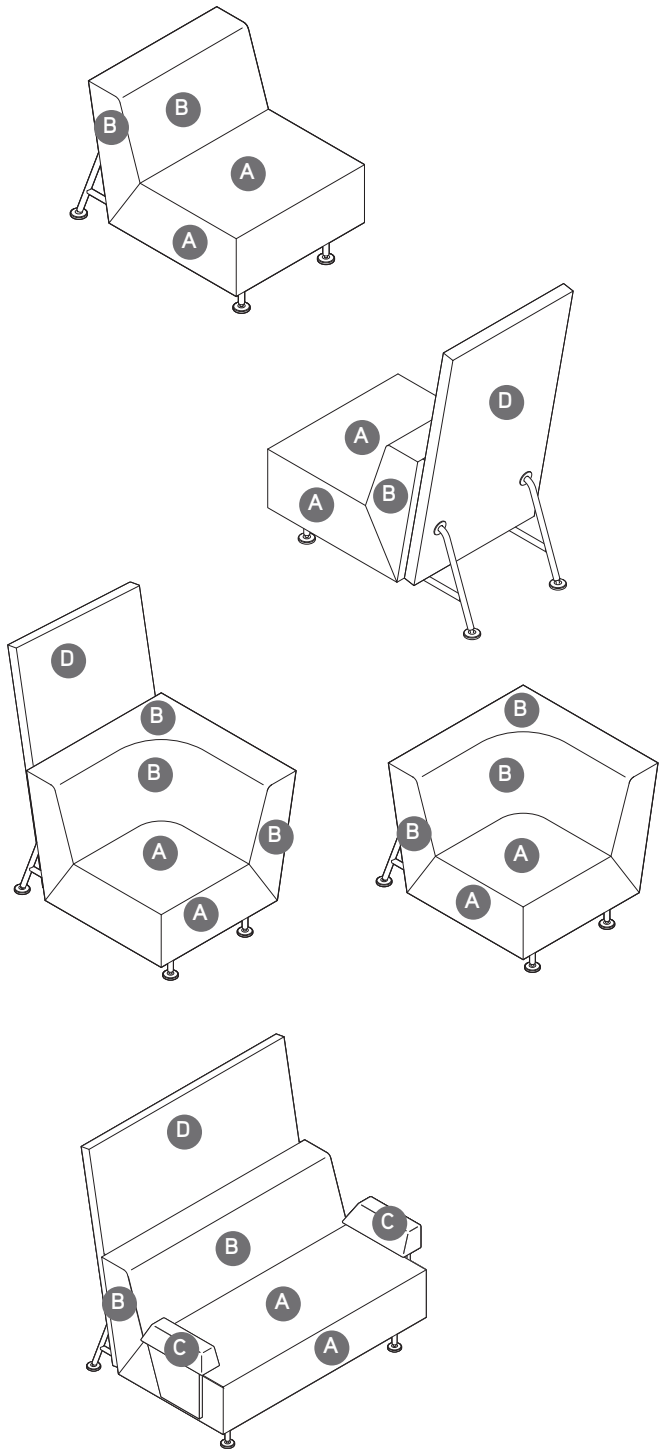

TO: _____

FROM: _____

DATE: _____

FAX...888.413.5161

A Seat (upholstery selections default for entire unit if B is not selected): _____

B Back: _____

C Arms (if applicable): _____

D Backscreen (if applicable): _____

**Back screen defined separately when ordered.*

**\$121 list per contrasting fabric specified. List price based on highest fabric grade usage.*

Bix Lounge System Benches

DESIGN METRO DESIGN GROUP

SIN 711.18

Tip: Fabrics and leathers will appear loose with comfort wrinkles when upholstered.

Tip: The COM yards and COL square footage listed on this page reflect the requirements for a single fabric that are based on non-directional 54"W material applied railroaded.

Standard Includes		Required to Specify
<ul style="list-style-type: none"> ▶ Need help? Product details, see <i>Coalesse Seating and Outdoor Specification Guide</i> 	<ul style="list-style-type: none"> • Seat: fabric or leather • Legs and open storage interior, if selected: paint • Adjustable glides: paint to match legs 	<ol style="list-style-type: none"> 1 Style number 2 Fabric or leather color number for seat 3 Paint color number for legs, glides, and open storage interior, if selected 4 Options, if selected (see below) <p>▶ See <i>Surface Materials</i>, page 260.</p>

Options	Price	Required to Specify
Surface Materials <ul style="list-style-type: none"> • Acrylic backer • 48"W benches • 72"W benches 	<ul style="list-style-type: none"> +\$ 23 +\$ 30 	<p>Specify with acrylic backer. Specify with acrylic backer. ▶ See <i>Surface Materials</i>, page 260.</p>
Seat Height <ul style="list-style-type: none"> • 18" seat height 	<ul style="list-style-type: none"> +\$233 	<p>Specify with 18" seat height.</p>
Related Products <ul style="list-style-type: none"> • Lounge chairs • Sectional seating • Podium • Side table 		<ul style="list-style-type: none"> ▶ Page 52 ▶ Page 54 ▶ Page 62 ▶ Page 72

Specification Information

Style Number	Base Prices											Leather Grades:		
	Fabric Grades:											COL	C	E
	COM	6	7	8	9	10	11	12	13	14				

48"W Bench

BB48	\$1564	\$1564	\$1579	\$1605	\$1683	\$1734	\$1793	\$1834	\$1906	\$2007	\$1730	\$2582	\$2736
COM/yds = 2 1/4, COL/sq ft = 41													

72"W Bench

BB72	\$1892	\$1892	\$1912	\$1946	\$2050	\$2118	\$2196	\$2250	\$2347	\$2481	\$2075	\$3173	\$3378
COM/yds = 3, COL/sq ft = 54													

48"W Bench with Open Storage

BBS48	\$1804	\$1804	\$1819	\$1845	\$1923	\$1974	\$2033	\$2074	\$2146	\$2247	\$2004	\$2822	\$2976
COM/yds = 2 1/4, COL/sq ft = 41													

72"W Bench with Open Storage

BBS72	\$2132	\$2132	\$2152	\$2186	\$2290	\$2358	\$2436	\$2490	\$2587	\$2721	\$2348	\$3413	\$3618
COM/yds = 3, COL/sq ft = 54													

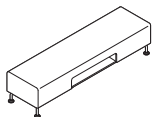
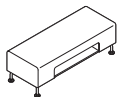
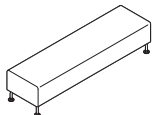
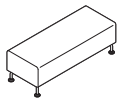

Coalesse

Bix Lounge System Benches

DESIGN METRO DESIGN GROUP

SIN 711.18

Bix Lounge System Podiums

DESIGN METRO DESIGN GROUP

SIN 711.18

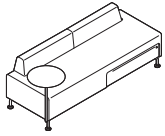

Tip: The COM yards and COL square footage listed on this page reflect the requirements for a single fabric that are based on non-directional 54"W material applied railroaded. For multi-fabric COM requirements, please refer to Multi-Fabric Yardage and Square Footage Requirements.

► Page 65

Tip: When specifying fabric in different price groups, the highest price group prevails.

Tip: Wood veneer storage drawers are available in high sheen finishes only.

Standard Includes		Required to Specify	
<p>► Need help? Product details, see <i>Coalesse Seating and Outdoor Specification Guide</i></p>	<ul style="list-style-type: none"> • Seat and bolster: fabric or leather • Legs, tablet support, drawer pull, and projection screen frame, if selected: paint • Tablet surface: bronco onyx vinyl • Drawer front: laminate • Face-mounted lock, keyed random: black only • Projection screen, if selected: sand color mesh • Adjustable glides: paint to match legs 	<ol style="list-style-type: none"> 1 Style number 2 Number of fabrics if contrasting fabric style number is selected 3 Fabric or leather color number for seat and bolster 4 Paint color number for legs, glides, tablet support, drawer pull, and projection screen frame, if selected 5 Laminate color number for drawer front 6 Options, if selected (see below) 	<p>► See <i>Surface Materials</i>, page 260.</p>
Options	Price	Required to Specify	
<p>Surface Materials</p> <ul style="list-style-type: none"> • Contrasting fabric 	<p>+\$121 per fabric</p>	<p>Add suffix K to the style number and select fabric color number.</p>	
<p>Acrylic backer</p>			
<ul style="list-style-type: none"> • Backer 	<p>+\$ 65</p>	<p>Specify with <i>acrylic backer</i>. ► See <i>Surface Materials</i>, page 260.</p>	
<p>Storage drawer front</p>			
<ul style="list-style-type: none"> • Wood veneer Grade 1 	<p>+\$ 34</p>	<p>Specify with <i>wood drawer front</i> and select wood veneer grade 1 color number.</p>	
<ul style="list-style-type: none"> • Wood veneer Grade 2 	<p>+\$ 53</p>	<p>Specify with <i>wood drawer front</i> and select wood veneer grade 2 color number.</p>	
<ul style="list-style-type: none"> • Grade 2 laminate drawer front 	<p>No cost</p>	<p>► Specify laminate color number.</p>	
<p>Wood</p>			
<ul style="list-style-type: none"> • Custom wood finish 		<p>► Page 272</p>	
<p>Seat Height</p>	<ul style="list-style-type: none"> • 18" seat height 	<p>+\$233</p>	<p>Specify with <i>18" seat height</i>.</p>
<p>Related Products</p>	<ul style="list-style-type: none"> • Lounge chairs • Sectional seating • Bench • Side table 		<ul style="list-style-type: none"> ► Page 52 ► Page 54 ► Page 60 ► Page 72

Bix Lounge System Podiums

DESIGN METRO DESIGN GROUP

SIN 711.18

Specification Information

Style Number	Base Prices											Leather Grades:		
	Fabric Grades:											COL	C	E
	COM	6	7	8	9	10	11	12	13	14				

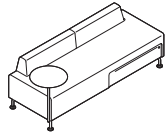

Podium with Left Tablet

BP72TX	\$4173	\$4230	\$4270	\$4339	\$4548	\$4682	\$4839	\$4948	\$5141	\$5410	\$4619	\$6567	\$6974
COM/yds = 6, COL/sq ft = 108													

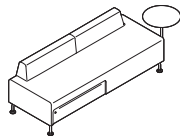

Podium with Right Tablet

BP72XT	\$4173	\$4230	\$4270	\$4339	\$4548	\$4682	\$4839	\$4948	\$5141	\$5410	\$4619	\$6567	\$6974
COM/yds = 6, COL/sq ft = 108													

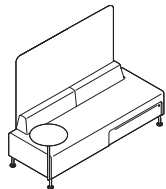

Podium with Projection Screen and Left Tablet

BPP72TX	\$5071	\$5128	\$5168	\$5237	\$5446	\$5580	\$5737	\$5846	\$6039	\$6308	\$5642	\$7465	\$7872
COM/yds = 6, COL/sq ft = 108													

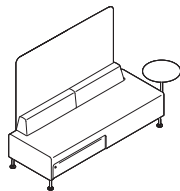

Podium with Projection Screen and Right Tablet

BPP72XT	\$5071	\$5128	\$5168	\$5237	\$5446	\$5580	\$5737	\$5846	\$6039	\$6308	\$5642	\$7465	\$7872
COM/yds = 6, COL/sq ft = 108													

Bix Multi-Fabric Diagram

DESIGN METRO DESIGN GROUP

SIN 711.18

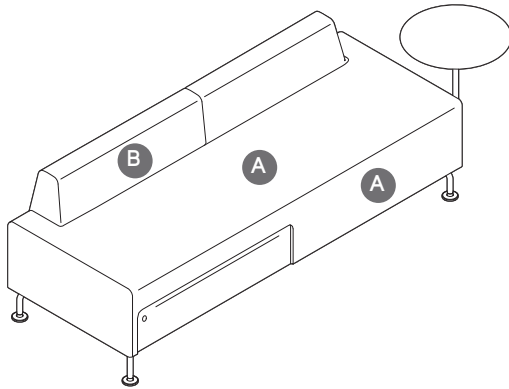

TO: _____

FROM: _____

DATE: _____

FAX....888.413.5161

A Seat (upholstery selections default for entire unit if B is not selected): _____

B Back: _____

** \$121 list per contrasting fabric specified. List price based on highest fabric grade usage.*

Bix Multi-Fabric Yardage

DESIGN METRO DESIGN GROUP

SIN 711.18

Multi-Fabric Yardage

DESCRIPTION	STYLE NUMBER	COM YDS*			
		SEAT	BACK	ARM(S)	BACK SCREEN
Lounge chair	BL26XX	1¾	1¾	N.A.	N.A.
Lounge chair with arms	BL26AA	1¾	1¾	1	N.A.
Lounge chair with back screen	BLB26XX	1¾	1¾	N.A.	1¾
Sled lounge chair	BLD26XX	1¾	1¾	N.A.	N.A.
Sled lounge chair with arms	BLD26AA	1¾	1¾	1	N.A.
Sled lounge chair with left-hand tablet arm	BLD26TX	1¾	1¾	N.A.	N.A.
Sled lounge chair with right-hand tablet arm	BLD26XT	1¾	1¾	N.A.	N.A.
30"W corner section-left section with seat fabric railroaded	BSC30LA	2	2½	N.A.	N.A.
30"W corner section-left section with seat fabric cut-right	BSC30LB	2	2½	N.A.	N.A.
30"W corner section-right section with seat fabric railroaded	BSC30RA	2	2½	N.A.	N.A.
30"W corner section-right section with seat fabric cut-right	BSC30RB	2	2½	N.A.	N.A.
30"W corner section with back screen-left section with seat fabric railroaded	BSCB30LA	2	2½	N.A.	2
30"W corner section with back screen-left section with seat fabric cut-right	BSCB30LB	2	2½	N.A.	2
30"W corner section with back screen-right section with seat fabric railroaded	BSCB30RA	2	2½	N.A.	2
30"W corner section with back screen-right section with seat fabric cut-right	BSCB30RB	2	2½	N.A.	2
54"W extended corner section-left section	BSE54LX	2½	3	N.A.	N.A.
54"W extended corner section-left section with arm	BSE54LA	2½	3	½	N.A.
54"W extended corner section-right section	BSE54RX	2½	3	N.A.	N.A.
54"W extended corner section-right section with arm	BSE54RA	2½	3	½	N.A.
54"W extended corner section-left section with back screen	BSEB54LX	2½	3	N.A.	4
54"W extended corner section-left section with back screen and arm	BSEB54LA	2½	3	½	4
54"W extended corner section-right section with back screen	BSEB54RX	2½	3	N.A.	4
54"W extended corner section-right section with back screen and arm	BSEB54RA	2½	3	½	4
48"W straight section	BSS48XX	2½	2½	N.A.	N.A.
48"W straight section with left arm	BSS48AX	2½	2½	½	N.A.
48"W straight section with right arm	BSS48XA	2½	2½	½	N.A.
48"W straight section with two arms	BSS48AA	2½	2½	1	N.A.
48"W straight section with back screen	BSSB48XX	2½	2½	N.A.	3
48"W straight section with back screen and left arm	BSSB48AX	2½	2½	½	3
48"W straight section with back screen and right arm	BSSB48XA	2½	2½	½	3
72"W straight section	BSS72XX	4½	4½	N.A.	N.A.
72"W straight section with left arm	BSS72AX	4½	4½	½	N.A.
72"W straight section with right arm	BSS72XA	4½	4½	½	N.A.
72"W straight section with two arms	BSS72AA	4½	4½	1	N.A.
72"W straight section with back screen	BSSB72XX	4½	4½	N.A.	5
72"W straight section with back screen and left arm	BSSB72AX	4½	4½	½	5
72"W straight section with back screen and right arm	BSSB72XA	4½	4½	½	5

*Fabric yardage is based on non-directional/solid fabrics. use conversion chart on the following page for repeat/printed fabric yardage.

Bix Multi-Fabric Yardage *continued*

DESIGN METRO DESIGN GROUP

SIN 711.18

Multi-Fabric Yardage

DESCRIPTION	STYLE NUMBER	COM YDS*			
		SEAT CUSHION	BACK CUSHION	ARM(S)	BACK SCREEN
Podium with left tablet	BP72TX	3½	2½	N.A.	N.A.
Podium with right tablet	BP72XT	3½	2½	N.A.	N.A.
Podium with projection screen and left tablet	BPP72TX	3½	2½	N.A.	N.A.
Podium with projection screen and right tablet	BPP72XT	3½	2½	N.A.	N.A.

*Fabric yardage is based on non-directional/solid fabrics. Use conversion chart below for repeat/printed fabric yardage.

Non-standard fabric requirements

Yardage requirements shown are based on non-directional 54"W material applied railroaded. Coalesse will apply fabric railroaded unless instructed otherwise on the dealer's purchase order. The following conversion chart should be used to determine yardage requirements when COM has a repeat of 2' or more. Please contact Coalesse Customer Service for a yardage quotation if the fabric is less than 54" wide, has a repeat of more than 24", or if the fabric must be cut-right.

CONVERSION CHART

PRODUCT	REPEAT		
	2' -8"	9" -14"	15" -24"
Bix	15%	30%	75%

Yardage quotations will also be provided for order of 10 or more pieces.

Pattern matching on Bix

Due to Coalesse's high standards for pattern matching, we reserve the right to apply the following upcharges for extra labor incurred by a pattern or material that poses such challenges.

Customers will be informed if an upcharge will be applied to their order during the approval process. Should Coalesse receive an order without prior approval, it will be held as pending until the customer accepts such charges. The upcharge will be applied per item where applicable.

Cutting direction guidelines

Cutting direction is based on the fabric width and the way the fabric is cut from the roll and applied to Coalesse products. There are two cutting directions: railroaded or cut-right.

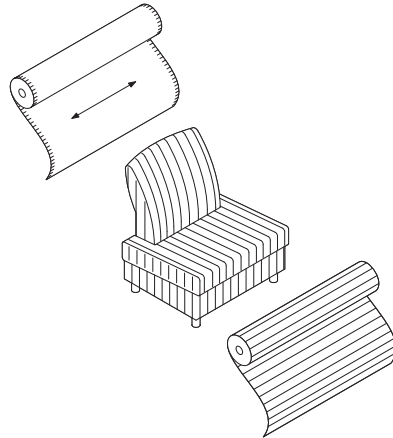

Horizontal or railroaded (across roll, warp horizontal) means fabric is cut across the roll; selvages are on the top and bottom.

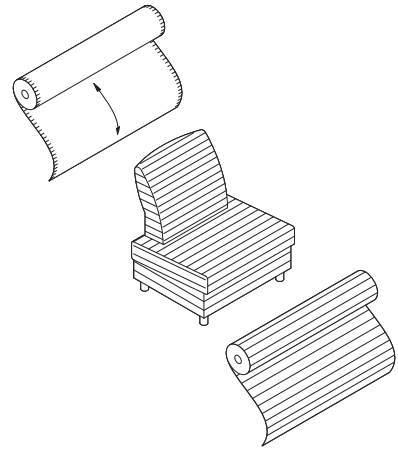

Vertical or cut-right (down roll, warp vertical) means fabric is cut in the same direction it is woven; selvages are on the left and right sides.

Coalesse reserves the right to railroad or apply fabric according to weave unless instructions specify otherwise. Fabrics are railroaded when possible to avoid seams in large upholstered areas and/or single cushion units. If a fabric is questionable, a cutting of adequate size showing full repeat (if any) should be sent to Coalesse for a fabric requirement quotation.

Coalesse

Bix Multi-Fabric Yardage

DESIGN METRO DESIGN GROUP

SIN 711.18

Bix Lounge System Bridge Tables

DESIGN METRO DESIGN GROUP

SIN 711.18

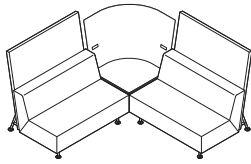

► Need help?
Product details, see *Coalesse Seating and Outdoor Specification Guide*

Standard Includes

- Top:
 - Laminate top (Grade 1 laminates) with matching plastic edge
 - Laminate top (Grade 1 Steelcase) with contrasting plastic edge
 - Wood top with matching flat wood edge
- Frame, tilted display surface for rectangular tables, and support leg for corner tables, if selected: paint
- Grommet, if selected: black plastic only
- Screens, if selected: translucent material only
- Wire management clips: black plastic only
- Attachment hardware

Required to Specify

- 1 Style number
- 2 Laminate or wood color number for top
► See *Hardwood and Veneer Matrix*, page 274
- 3 Plastic edge color number for top with Grade 1 Steelcase or Grade 2 laminate, if selected
- 4 Paint color number for frame, tilted display surface for rectangular tables, and support leg for corner tables, if selected
- 5 Options, if selected (see below)
► See *Surface Materials*, page 260.

Tip: 20" table height must be used in conjunction with 18" seat height in the sectional seating.

Options

Price

Required to Specify

Cable Management	• PDV module: black plastic	+\$382	Specify with <i>PDV module</i> .
Corner Bridge Table Height	• 20" table height	+\$233	Specify with <i>20" table height</i> .
Related Products	• Sectional seating		► Page 54

Specification Information

Dimensions			Style Number	Base Prices			
D	W	H		Lam 1	Lam 2	Wood 1	Wood 2
Rectangular Bridge Table							
26"	22"	18"	BTB2226	\$910	\$ 957	\$1127	\$1244

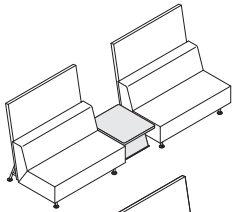

Rectangular Bridge Table with Grommet

26"	22"	18"	BTB2226U	\$967	\$1017	\$1184	\$1301
-----	-----	-----	----------	-------	--------	--------	--------

► Specification Information, continued on next page

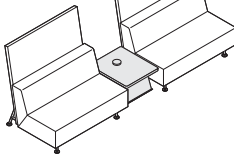

Edge Profiles

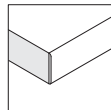

Plastic edge

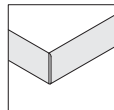

Wood edge

Bix Lounge System Bridge Tables

DESIGN METRO DESIGN GROUP

SIN 711.18

► Specification Information, continued from previous page

Specification Information

Dimensions			Style Number	Base Prices			
D	W	H		Lam 1	Lam 2	Wood 1	Wood 2

Rectangular Bridge Table with Screen

26"	22"	46"	BTBS2226	\$1375	\$1445	\$1592	\$1709
-----	-----	-----	----------	--------	--------	--------	--------

Rectangular Bridge Table with Grommet and Screen

26"	22"	46"	BTBS2226U	\$1433	\$1506	\$1650	\$1767
-----	-----	-----	-----------	--------	--------	--------	--------

Corner Bridge Table

26"	26"	18"	BTB2626	\$1031	\$1083	\$1276	\$1393
-----	-----	-----	---------	--------	--------	--------	--------

Corner Bridge Table with Grommet

26"	26"	18"	BTB2626U	\$1089	\$1145	\$1334	\$1451
-----	-----	-----	----------	--------	--------	--------	--------

Corner Bridge Table with Screen

26"	22"	18"	BTB2226	\$ 910	\$ 957	\$1127	\$1244
26"	26"	46"	BTBS2626	\$1639	\$1722	\$1884	\$2001

Corner Bridge Table with Grommet and Screen

26"	26"	46"	BTBS2626U	\$1695	\$1783	\$1940	\$2057
-----	-----	-----	-----------	--------	--------	--------	--------

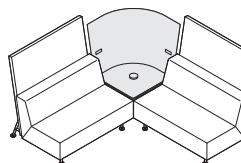
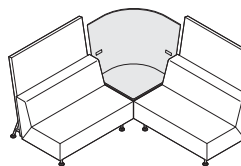
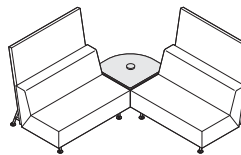
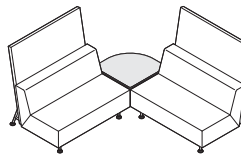
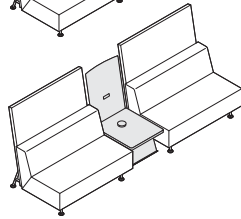
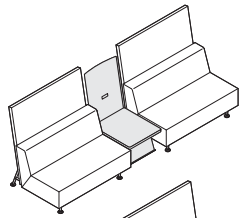

Lounge Seating

Bix 18"H Occasional Tables

DESIGN METRO DESIGN GROUP

SIN 711.18

Standard Includes

► Need help?
Product details, see *Coalesse Seating and Outdoor Specification Guide*

- Top:
 - Laminate top (Grade 1 laminates) with matching plastic edge
 - Laminate top (Grade 1 Steelcase) with contrasting plastic edge
 - Wood top with matching flat wood edge
- Base: textured paints only
- Grommet, if selected: black plastic only

Required to Specify

- 1 Style number
- 2 Laminate or wood color number for top
► See *Hardwood and Veneer Matrix*, page 274
- 3 Plastic edge color number for top with Grade 1 Steelcase or Grade 2 laminate, if selected
- 4 Textured paint color number for base
- 5 Options, if selected (see below)
► See *Surface Materials*, page 260.

Options

Cable Management

- PDV module: black plastic

Price
+\$382 each

Required to Specify

Specify with PDV module.

Related Products

- Lounge seating
- Sectional seating

► Page 52
► Page 54

Tip: One or two power, data, and voice modules are available on rectangular occasional tables.

Specification Information

Dimensions				Style Number	Base Prices			
D	W	H	Diameter		Lam 1	Lam 2	Wood 1	Wood 2

Round Occasional Tables

N.A.	N.A.	18"	20"	BTC20001	\$1054	\$1107	\$1167	\$1221
N.A.	N.A.	18"	28"	BTC28001	\$1098	\$1154	\$1220	\$1337

Round Occasional Table with Grommet

N.A.	N.A.	18"	28"	BTC28001U	\$1170	\$1229	\$1292	\$1409
------	------	-----	-----	-----------	--------	--------	--------	--------

Square Occasional Table

24"	24"	18"	N.A.	BTC24241	\$1082	\$1137	\$1201	\$1275
-----	-----	-----	------	----------	--------	--------	--------	--------

Square Occasional Table with Grommet

24"	24"	18"	N.A.	BTC24241U	\$1155	\$1214	\$1274	\$1348
-----	-----	-----	------	-----------	--------	--------	--------	--------

Rectangular Table

24"	48"	18"	N.A.	BTC24481	\$1752	\$1842	\$1937	\$2087
24"	72"	18"	N.A.	BTC24721	\$1795	\$1887	\$2001	\$2222

Rectangular Occasional Tables with Grommets

24"	48"	18"	N.A.	BTC24481U	\$1895	\$1991	\$2080	\$2230
24"	72"	18"	N.A.	BTC24721U	\$1939	\$2038	\$2145	\$2366

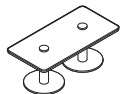
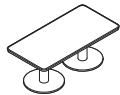

Edge Profiles

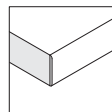

Plastic edge

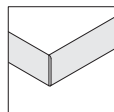

Wood edge

Bix 27"H Work-Booth Tables

DESIGN METRO DESIGN GROUP

SIN 711.18

Tip: One or two power, data, and voice modules are available on rectangular occasional tables.

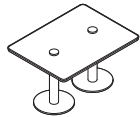
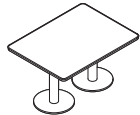

Standard Includes

► Need help?
Product details, see *Coalesse Seating and Outdoor Specification Guide*

- Top:
 - Laminate top (Grade 1 laminates) with matching plastic edge
 - Laminate top (Grade 1 Steelcase) with contrasting plastic edge
 - Wood top with matching flat wood edge
- Base: textured paints only
- Grommet, if selected: black plastic only

Required to Specify

- 1 Style number
- 2 Laminate or wood color number for top
► See *Hardwood and Veneer Matrix*, page 274
- 3 Plastic edge color number for top with Grade 1 Steelcase or Grade 2 laminate, if selected
- 4 Textured paint color number for base
- 5 Options, if selected (see below)
► See *Surface Materials*, page 260

Options

Cable Management

- PDV module: black plastic

Price

+\$382 each

Required to Specify

Specify with PDV module.

Related Products

- Lounge seating
- Sectional seating

► Page 52
► Page 54

Specification Information

Dimensions				Style Number	Base Prices			
D	W	H	Diameter		Lam 1	Lam 2	Wood 1	Wood 2

Round Work-Booth Tables

N.A.	N.A.	27"	20"	BTW20003	\$1082	\$1137	\$1195	\$1249
N.A.	N.A.	27"	28"	BTW28003	\$1126	\$1183	\$1248	\$1365

Round Work-Booth Table with Grommet

N.A.	N.A.	27"	28"	BTW28003U	\$1197	\$1257	\$1319	\$1436
------	------	-----	-----	-----------	--------	--------	--------	--------

Rectangular Work-Booth Tables

36"	48"	27"	N.A.	BTW36483	\$2059	\$2166	\$2295	\$2517
36"	72"	27"	N.A.	BTW36723	\$2279	\$2396	\$2515	\$2850

Rectangular Work-Booth Tables with Grommets

36"	48"	27"	N.A.	BTW36483U	\$2202	\$2315	\$2438	\$2660
36"	72"	27"	N.A.	BTW36723U	\$2421	\$2545	\$2657	\$2992

Edge Profiles

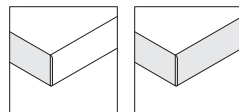

Plastic edge

Wood edge

Bix Side Table—Vinyl Version

DESIGN METRO DESIGN GROUP

SIN 711.18



Standard Includes

- Base: paint
- Table surface and base cover: bronco onyx vinyl

Required to Specify

- 1 Style number
- 2 Paint color number for base
- ▶ See *Surface Materials*, page 260.

Related Products

- Lounge chairs ▶ Page 52
- Sectional seating ▶ Page 54
- Podium ▶ Page 62

Specification Information

Dimensions		Style	Price
Diameter	H	Number	
16"	23"	BTS1700	\$525

Coalesse

Bix Side Table—Vinyl Version

DESIGN METRO DESIGN GROUP

SIN 711.18

Bob Lounge Chairs by Walter Knoll

DESIGN PEARSON LLOYD

SIN 711.18

Tip: For Customer's Own Material or Leather, see necessary requirements, important processing instructions, and ordering information.
 ▶ Page 260.

Tip: Fabrics and leathers will appear loose with comfort wrinkles when upholstered.

Standard Includes		Required to Specify	
▶ Need help? Product details, see <i>Coalesse Seating and Outdoor Specification Guide</i>	<ul style="list-style-type: none"> • Base: 8040 Aluminum Matte Polished or grade 1 paint • Swivel base for lounge chairs, if selected • Upholstery for chair: fabric or leather • Glides 	<ol style="list-style-type: none"> 1 Style number 2 Paint or metal color for base 3 Number of fabrics if contrasting fabric style number is selected 4 Fabric or leather color number for upholstery 5 Options, if selected (see below) ▶ See <i>Surface Materials</i> , page 260.	
Options		Price	Required to Specify
Surface Materials	<ul style="list-style-type: none"> • Contrasting fabric 	+\$121 per fabric	Add suffix K to the style number and select fabric color number.
	Fire code seating		
	<ul style="list-style-type: none"> • Fire code seating 	+\$237	Specify with <i>fire code seating</i> . ▶ See <i>Fire Code Seating</i> , page 264.
	Acrylic backer		
	<ul style="list-style-type: none"> • Lounge chair • Lounge chair with headrest • Ottoman 	+\$ 30 +\$ 34 +\$ 10	Specify with <i>acrylic backer</i> . Specify with <i>acrylic backer</i> . Specify with <i>acrylic backer</i> . ▶ See <i>Surface Materials</i> , page 260.
Base	Lounge chair with standard swivel mechanism		
	<ul style="list-style-type: none"> • Aluminum matte polished 	No cost	Specify with <i>standard swivel</i> and select aluminum matte polished.
	<ul style="list-style-type: none"> • Grade 1 paint 	No cost	Specify with <i>standard swivel</i> and select paint color number.
	<ul style="list-style-type: none"> • Grade 3 paint 	+\$ 75	Specify with <i>standard swivel</i> and select paint color number.
	Lounge chair with return swivel mechanism		
	<ul style="list-style-type: none"> • Aluminum matte polished 	+\$260	Specify with <i>return swivel</i> and select aluminum matte polished.
Glides	<ul style="list-style-type: none"> • Felted glides 	+\$ 16	Specify with <i>felted glides</i> .

Specification Information													
Style Number	Base Prices											Leather Grades:	
	Fabric Grades:											COL	C
COM	6	7	8	9	10	11	12	13	14				

Lounge Chair

216	\$2396	\$2396	\$2416	\$2450	\$2554	\$2622	\$2700	\$2754	\$2851	\$2985	\$2580	\$3856	\$4088
-----	--------	--------	--------	--------	--------	--------	--------	--------	--------	--------	--------	--------	--------

COM/yds = 3, COL/sq ft = 72



Overall: 34¼"D 35"W 31¾"H
 Inside: 21¾"D 20"W 17¼"H
 Seat: 17"H
 Arm: 21¾"H

Lounge Chair with Headrest

221	\$2839	\$2839	\$2863	\$2903	\$3025	\$3103	\$3195	\$3258	\$3371	\$3527	\$3006	\$4501	\$4772
-----	--------	--------	--------	--------	--------	--------	--------	--------	--------	--------	--------	--------	--------

COM/yds = 3½, COL/sq ft = 77



Overall: 34¼"D 35"W 41¼"H
 Inside: 21¾"D 20"W 27½"H
 Seat: 17"H
 Arm: 21¾"H

▶ Specification Information, continued on next page

Coalesse

Bob Lounge Chairs by Walter Knoll

DESIGN PEARSON LLOYD

SIN 711.18

► Specification Information, continued from previous page

Specification Information

Style Number	Base Prices										Leather Grades:		
	Fabric Grades:										COL	C	E
	COM	6	7	8	9	10	11	12	13	14			

Ottoman

221-H	\$881	\$875	\$882	\$893	\$928	\$951	\$976	\$995	\$1027	\$1072	\$1130	\$1520	\$1596
COM/yds = 1, COL/sq ft = 22													



Overall: 18½"D 19¾"W 15¼"H

Lounge Seating

Circa Lounge System Upholstered Individual Lounge Units

DESIGN ALISON SPEAR, AIA

SIN 711.17

Tip: Fabrics and leathers will appear loose with comfort wrinkles when upholstered.

Tip: For contrasting fabric, pricing is based on highest grade textile specified.

Tip: For Customer's Own Material or Leather, see necessary requirements, important processing instructions, and ordering information
▶Page 262

Tip: Benches are flat and 1-seat and 2-seat lounges are angled; therefore, seat angles will not be aligned when placed next to each other. A table is recommended between the units to minimize the difference.

Standard Includes		Required to Specify
▶ Need help? Product details, see <i>Coalesse Seating and Outdoor Specification Guide</i>	<ul style="list-style-type: none"> • Frame: unibody construction of hardwood plywood utilizing box joinery • Upholstery: multiple densities of polyurethane foam fixed seat and back with top stitch on seams • Legs: <ul style="list-style-type: none"> - Tapered leg, if selected: solid maple or walnut - Cylinder leg, if selected: solid oak 	<ol style="list-style-type: none"> 1 Style number 2 Number of fabrics if contrasting fabric style number is selected 3 Fabric or leather color number for upholstery on seat and back 4 Wood leg type 5 Wood color number for legs 6 Options, if selected (see below) ▶ See <i>Surface Materials</i> , page 260.

Options	Price	Required to Specify	
Surface Materials	<ul style="list-style-type: none"> • Contrasting fabric 	+\$121 per fabric	Add suffix K to the style number and select fabric color number.
	Acrylic backer		
	<ul style="list-style-type: none"> • 30° outside facing wedge 1-seat lounge 	+\$ 32	Specify with acrylic backer.
	<ul style="list-style-type: none"> • 30° inside facing wedge seat 1-seat lounge 	+\$ 34	Specify with acrylic backer.
	<ul style="list-style-type: none"> • 60° outside and inside wedge 2-seat lounge 	+\$ 59	Specify with acrylic backer.
	<ul style="list-style-type: none"> • 60° benches 	+\$ 40	Specify with acrylic backer.
	<ul style="list-style-type: none"> • Straight 1-seat lounge 	+\$ 23	Specify with acrylic backer.
	<ul style="list-style-type: none"> • Straight 2-seat lounge 	+\$ 47	Specify with acrylic backer.
	<ul style="list-style-type: none"> • Straight bench 	+\$ 30	Specify with acrylic backer. ▶ See <i>Surface Materials</i> , page 260.
Shared Leg Application	<ul style="list-style-type: none"> • Cylinder wood legs • Modern metal legs 	-\$190 -\$190	Specify with cylinder wood legs. Specify with modern metal legs.
Metal Legs	Tapered legs		
	<ul style="list-style-type: none"> • Grade 1 paint 	+\$138 per leg	Specify with tapered metal legs and select paint color number. ▶ See <i>Surface Materials</i> , page 260.
	<ul style="list-style-type: none"> • Grade 3 paint 	+\$158 per leg	Specify with tapered metal legs and select paint color number. ▶ See <i>Surface Materials</i> , page 260.
	Modern legs		
	<ul style="list-style-type: none"> • Grade 1 paint 	+\$138 per leg	Specify with modern metal legs and select paint color number. ▶ See <i>Surface Materials</i> , page 260.
	<ul style="list-style-type: none"> • Grade 3 paint 	+\$158 per leg	Specify with modern metal legs and select paint color number. ▶ See <i>Surface Materials</i> , page 260.

Specification Information

Style Number	Base Prices														Leather Grades:		
	Fabric Grades:														COL	C	E
	COM	6	7	8	9	10	11	12	13	14							

30° Outside Facing Wedge 1-Seat Lounge

451-3730FO	\$1419	\$1419	\$1441	\$1478	\$1591	\$1665	\$1749	\$1808	\$1913	\$2058	\$1640	\$3230	\$3522
COM/yds = 3¼, COL/sq ft = 72													

▶ Specification Information, continued on next page

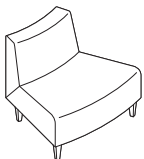

Overall: 28"D 36¾"W 29½"H
 Inside: 20"D 36¾"W 12¼"H
 Seat: 17¼"H
 Angle Degree: 30°

Circa Lounge System Upholstered Individual Lounge Units

DESIGN ALISON SPEAR, AIA

SIN 711.17

► Specification Information, continued from previous page

Specification Information

Style Number	Base Prices										Leather Grades:		
	Fabric Grades:										COL	C	E
	COM	6	7	8	9	10	11	12	13	14			

30° Inside Facing Wedge 1-Seat Lounge

451-3730FI	\$1419	\$1419	\$1441	\$1478	\$1591	\$1665	\$1749	\$1808	\$1913	\$2058	\$1640	\$3230	\$3522
COM/yds = 3¼, COL/sq ft = 72													

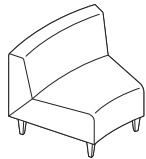

Overall: 28"D 36¾"W 29½"H
 Inside: 20"D 36¾"W 12¼"H
 Seat: 17¼"H
 Angle Degree: 30°

60° Outside Wedge 2-Seat Lounge

451-7460FO	\$2255	\$2330	\$2373	\$2447	\$2674	\$2820	\$2990	\$3108	\$3317	\$3608	\$2425	\$5665	\$6247
COM/yds = 4½, COL/sq ft = 99													

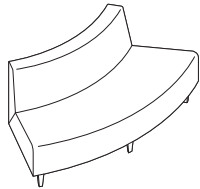

Overall: 28"D 71"W 29½"H
 Inside: 20"D 71"W 12¼"H
 Seat: 17¼"H
 Angle Degree: 60°

60° Inside Wedge 2-Seat Lounge

451-7460FI	\$2255	\$2330	\$2373	\$2447	\$2674	\$2820	\$2990	\$3108	\$3317	\$3608	\$2425	\$5665	\$6247
COM/yds = 4¾, COL/sq ft = 105													

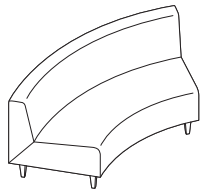

Overall: 28"D 71"W 29½"H
 Inside: 20"D 71"W 12¼"H
 Seat: 17¼"H
 Angle Degree: 60°

60° Outside Wedge Bench

451-B7460FO	\$1787	\$1787	\$1807	\$1841	\$1945	\$2013	\$2091	\$2145	\$2242	\$2376	\$2010	\$3477	\$3749
COM/yds = 3, COL/sq ft = 66													

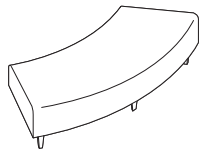

Overall: 28"D 71"W 17¼"H
 Seat: 17¼"H
 Angle Degree: 60°

60° Inside Wedge Bench

451-B7460FI	\$1787	\$1787	\$1807	\$1841	\$1945	\$2013	\$2091	\$2145	\$2242	\$2376	\$2010	\$3477	\$3749
COM/yds = 3, COL/sq ft = 66													

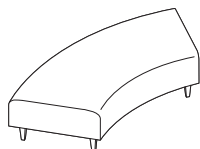

Overall: 28"D 71"W 17¼"H
 Seat: 17¼"H
 Angle Degree: 60°

► Specification Information, continued on next page

Lounge Seating

Circa Lounge System Upholstered Individual Lounge Units *continued*

DESIGN ALISON SPEAR, AIA

SIN 711.17

► Specification Information, continued from previous page

Specification Information

Style Number	Base Prices											Leather Grades:		
	Fabric Grades:											COL	C	E
	COM	6	7	8	9	10	11	12	13	14				

Straight 1-Seat Lounge

451-2500	\$1274	\$1274	\$1291	\$1319	\$1406	\$1463	\$1527	\$1573	\$1653	\$1765	\$1515	\$2726	\$2949
COM/yds = 2½, COL/sq ft = 55													

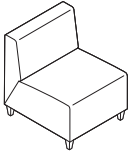

Overall: 28"D 25"W 29½"H
 Inside: 20"D 25"W 12¼"H
 Seat: 17¼"H
 Angle Degree: 0°

Straight 2-Seat Lounge

451-5000	\$1829	\$1850	\$1884	\$1942	\$2116	\$2227	\$2359	\$2449	\$2610	\$2834	\$2004	\$4480	\$4927
COM/yds = 4, COL/sq ft = 83													

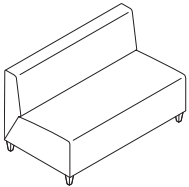

Overall: 28"D 50"W 29½"H
 Inside: 20"D 50"W 12¼"H
 Seat: 17¼"H
 Angle Degree: 0°

Straight Bench

451-B5000	\$1627	\$1627	\$1647	\$1681	\$1785	\$1853	\$1931	\$1985	\$2082	\$2216	\$1845	\$3322	\$3582
COM/yds = 3, COL/sq ft = 66													

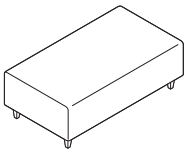

Overall: 28"D 50"W 17¼"H
 Seat: 17¼"H
 Angle Degree: 0°

Tip: Please submit sketch for modular application. One package is required per two chairs.

Ganging Kit

451-GANGPKG	\$ 39	N.A.	N.A.	N.A.	N.A.	N.A.	N.A.	N.A.	N.A.	N.A.	N.A.	N.A.	N.A.
-------------	-------	------	------	------	------	------	------	------	------	------	------	------	------

Coalesse

Circa Lounge System Upholstered Individual Lounge Units

DESIGN ALISON SPEAR, AIA

SIN 711.17

Circa Lounge System Upholstered Modular Arm Rests—Straight, 15°, 30°, and Ottoman

DESIGN ALISON SPEAR, AIA

SIN 711.17

Tip: Fabrics and leathers will appear loose with comfort wrinkles when upholstered.

Tip: Cylinder wood and modern metal legs cannot be in shared position with armrests. The legs will always be on the lounge side.

Tip: For Customer's Own Material or Leather, see necessary requirements, important processing instructions, and ordering information
▶ Page 262

Standard Includes		Required to Specify
▶ Need help? Product details, see <i>Coalesse Seating and Outdoor Specification Guide</i>	<ul style="list-style-type: none"> • Frame: hardwood panels • Upholstery: multiple densities of polyurethane • Top stitch on seams • Legs: <ul style="list-style-type: none"> - Tapered leg, if selected: solid maple or walnut - Cylinder leg, if selected: solid oak 	1 Style number 2 Fabric or leather color number for arm rests 3 Wood leg type 4 Wood color number for legs 5 Options, if selected (see below) ▶ See <i>Surface Materials</i> , page 260.

Options	Price	Required to Specify
Surface Materials	<ul style="list-style-type: none"> • Contrasting fabric on ottoman +\$121 	Add suffix K to the style number and select fabric color number.
	Acrylic backer	
	<ul style="list-style-type: none"> • Straight armrests and 15° armrests +\$ 19 • 30° armrests and ottoman +\$ 32 	Specify with <i>acrylic backer</i> . ▶ See <i>Surface Materials</i> , page 260. Specify with <i>acrylic backer</i> . ▶ See <i>Surface Materials</i> , page 260.
Metal Legs	Tapered legs	
	<ul style="list-style-type: none"> • Grade 1 paint +\$138 per leg • Grade 3 paint +\$158 per leg 	Specify with <i>tapered metal legs</i> and select paint color number. ▶ See <i>Surface Materials</i> , page 260. Specify with <i>tapered metal legs</i> and select paint color number. ▶ See <i>Surface Materials</i> , page 260.
	Modern legs	
	<ul style="list-style-type: none"> • Grade 1 paint +\$138 per leg • Grade 3 paint +\$158 per leg 	Specify with <i>modern metal legs</i> and select paint color number. ▶ See <i>Surface Materials</i> , page 260. Specify with <i>modern metal legs</i> and select paint color number. ▶ See <i>Surface Materials</i> , page 260.

Specification Information												
Style Number	Base Prices											Leather Grades:
	Fabric Grades:	6	7	8	9	10	11	12	13	14	COL	C

Straight Armrest—Intermediate without Legs

451-A1800G	\$785	\$785	\$800	\$826	\$ 904	\$ 955	\$1014	\$1055	\$1127	\$1228	\$ 996	\$1941	\$2114
COM/yds = 2¼, COL/sq ft = 50													

Straight Armrest—End of Run with Two Legs

451-A1800ER	\$911	\$911	\$926	\$952	\$1030	\$1081	\$1140	\$1181	\$1253	\$1354	\$1122	\$2067	\$2240
COM/yds = 2¼, COL/sq ft = 50													

15° Inside Armrest—Intermediate without Legs

451-A1815FIG	\$777	\$777	\$790	\$813	\$ 882	\$ 927	\$ 980	\$1016	\$1080	\$1169	\$ 996	\$1830	\$1982
COM/yds = 2, COL/sq ft = 44													

15° Inside Armrest—End of Run with Two Legs

451-A1815FIER	\$954	\$954	\$967	\$990	\$1059	\$1104	\$1157	\$1193	\$1257	\$1346	\$1173	\$2007	\$2159
COM/yds = 2, COL/sq ft = 44													

▶ Specification Information, continued on next page



Overall: 28"D 18½"W 17"H

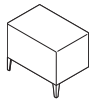

Overall: 28"D 18½"W 23½"H
Tip: Specify left or right facing.



Overall: 28¾"D 18½"W 23½"H



Overall: 28¾"D 18½"W 23½"H
Tip: Specify left or right facing.

Circa Lounge System Upholstered Modular Arm Rests—Straight, 15°, 30°, and Ottoman

DESIGN ALISON SPEAR, AIA

SIN 711.17

► Specification Information, continued from previous page

Specification Information

Style Number	Base Prices											Leather Grades:		
	Fabric Grades:											COL	C	E
	COM	6	7	8	9	10	11	12	13	14				

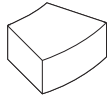

Overall: 29½"D 36¾"W 17"H

30° Inside Arm Rest—Intermediate without Legs

451-A3730FIG	\$1111	\$1111	\$1131	\$1165	\$1269	\$1337	\$1415	\$1469	\$1566	\$1700	\$1295	\$2571	\$2803
--------------	--------	--------	--------	--------	--------	--------	--------	--------	--------	--------	--------	--------	--------

COM/yds = 3, COL/sq ft = 66

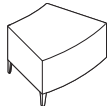

Overall: 29½"D 36¾"W 23½"H
Tip: Specify left or right facing.

30° Inside Arm Rest—End of Run with Two Legs

451-A3730FIER	\$1246	\$1246	\$1266	\$1300	\$1404	\$1472	\$1550	\$1604	\$1701	\$1835	\$1430	\$2706	\$2938
---------------	--------	--------	--------	--------	--------	--------	--------	--------	--------	--------	--------	--------	--------

COM/yds = 3, COL/sq ft = 66



Overall: 28¾"D 18½"W 17"H

15° Outside Armrest—Intermediate without Legs

451-A1815FOG	\$ 777	\$ 777	\$ 790	\$ 813	\$ 882	\$ 927	\$ 980	\$1016	\$1080	\$1169	\$ 996	\$1830	\$1982
--------------	--------	--------	--------	--------	--------	--------	--------	--------	--------	--------	--------	--------	--------

COM/yds = 2, COL/sq ft = 44



Overall: 28¾"D 18½"W 23½"H
Tip: Specify left or right facing.

15° Outside Armrest—End of Run with Two Legs

451-A1815FOER	\$ 954	\$ 954	\$ 967	\$ 990	\$1059	\$1104	\$1157	\$1193	\$1257	\$1346	\$1173	\$2007	\$2159
---------------	--------	--------	--------	--------	--------	--------	--------	--------	--------	--------	--------	--------	--------

COM/yds = 2, COL/sq ft = 44

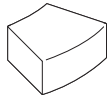

Overall: 29½"D 36¾"W 17"H

30° Outside Arm Rest—Intermediate without Legs

451-A3730FOG	\$1111	\$1111	\$1131	\$1165	\$1269	\$1337	\$1415	\$1469	\$1566	\$1700	\$1295	\$2571	\$2803
--------------	--------	--------	--------	--------	--------	--------	--------	--------	--------	--------	--------	--------	--------

COM/yds = 3, COL/sq ft = 66

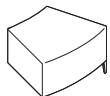

Overall: 29½"D 36¾"W 23½"H
Tip: Specify left or right facing.

30° Outside Arm Rest—End of Run with Two Legs

451-A3730FOER	\$1246	\$1246	\$1266	\$1300	\$1404	\$1472	\$1550	\$1604	\$1701	\$1835	\$1430	\$2706	\$2938
---------------	--------	--------	--------	--------	--------	--------	--------	--------	--------	--------	--------	--------	--------

COM/yds = 3, COL/sq ft = 66

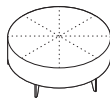

Overall: 42"Dia. 17"H

Round Ottoman with Five Legs

451-B42RD	\$1764	\$1764	\$1786	\$1823	\$1936	\$2010	\$2094	\$2153	\$2258	\$2403	\$1940	\$3329	\$3577
-----------	--------	--------	--------	--------	--------	--------	--------	--------	--------	--------	--------	--------	--------

COM/yds = 3¼, COL/sq ft = 72

Tip: Please submit sketch for modular application. One kit is required per two chairs.

Ganging Kit

451-GANGPKG	\$ 39	N.A.	N.A.	N.A.	N.A.	N.A.	N.A.	N.A.	N.A.	N.A.	N.A.	N.A.	N.A.
-------------	-------	------	------	------	------	------	------	------	------	------	------	------	------

Lounge Seating

Circa Lounge System Modular Tables

DESIGN ALISON SPEAR, AIA

SIN 711.17

Standard Includes	Required to Specify
<ul style="list-style-type: none"> ▶ Need help? Product details, see <i>Coalesse Seating and Outdoor Specification Guide</i> • Table: hardwood veneer • Legs: <ul style="list-style-type: none"> - Tapered leg, if selected: solid maple or walnut - Cylinder leg, if selected: solid oak • Brackets and hardware, if ganging or end-of-run tables selected 	<ol style="list-style-type: none"> 1 Style number 2 Wood color number for table 3 Wood leg type 4 Wood color number for legs 5 Options, if selected (see below) <p>▶ See <i>Surface Materials</i>, page 260.</p>

Options	Price	Required to Specify
Surface Materials <ul style="list-style-type: none"> • Table • Laminate with self edge 	Prices below and at right	Specify with <i>laminate</i> and select laminate color number. ▶ See <i>Surface Materials</i> , page 260.
Metal Legs <ul style="list-style-type: none"> • Tapered legs • Grade 1 paint 	+\$138 per leg	Specify with <i>tapered metal legs</i> and select paint color number. ▶ See <i>Surface Materials</i> , page 260.
<ul style="list-style-type: none"> • Modern legs • Grade 1 paint 	+\$138 per leg	Specify with <i>modern metal legs</i> and select paint color number. ▶ See <i>Surface Materials</i> , page 260.

Specification Information

Style Number	Base Prices	
	Laminate	Wood Veneer

15° Low Wedge Table, Ganging

45-T1815LG	\$1106	\$1292
------------	--------	--------

15° Low Wedge Table, End-of-Run, Two Legs

45-T1815LER	\$1175	\$1464
-------------	--------	--------

15° Low Wedge Table, Freestanding, Four Legs

45-T1815L	\$1244	\$1642
-----------	--------	--------

15° High Wedge Table, Ganging

45-T1815HG	\$1389	\$1781
------------	--------	--------

▶ Specification Information, continued on next page

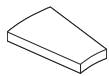

Overall: 28"D 18½"W 8½"H
Angle Degree: 15°

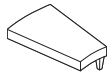

Overall: 28"D 18½"W 8½"H
Angle Degree: 15°

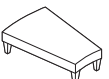

Overall: 28"D 18½"W 8½"H
Angle Degree: 15°

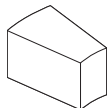

Overall: 28"D 18½"W 22½"H
Angle Degree: 15°

Circa Lounge System Modular Tables

DESIGN ALISON SPEAR, AIA

SIN 711.17

► Specification Information, continued from previous page

Specification Information

Style Number	Base Prices	
	Laminate	Wood Veneer

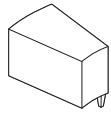

Overall: 28"D 18½"W 22½"H
Angle Degree: 15°

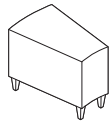

Overall: 28"D 18½"W 22½"H
Angle Degree: 15°

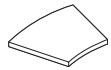

Overall: 29"D 36⅝"W 2"H
(8½" from floor once assembled)

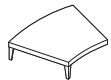

Overall: 29"D 36⅝"W 8½"H

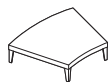

Overall: 29½"D 36⅝"W 8½"H

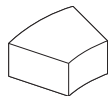

Overall: 29"D 36⅝"W 16"H

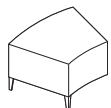

Overall: 29"D 36⅝"W 22½"H

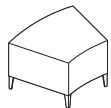

Overall: 29"D 36⅞"W 22½"H

15° High Wedge Table, End-of-Run, Two Legs

45-T1815HER	\$1459	\$1948
-------------	--------	--------

15° High Wedge Table, Freestanding, Four Legs

45-T1815H	\$1528	\$2125
-----------	--------	--------

30° Low Wedge Table, Ganging

45-T3730LG	\$1391	\$1582
------------	--------	--------

30° Low Wedge Table, End-of-Run, Two Legs

45-T3730LER	\$1460	\$1769
-------------	--------	--------

30° Low Wedge Table, Freestanding, Four Legs

45-T3730L	\$1528	\$1962
-----------	--------	--------

30° High Wedge Table, Ganging

45-T3730HG	\$1948	\$2253
------------	--------	--------

30° High Wedge Table, End-of-Run, Two Legs

45-T3730HER	\$2017	\$2436
-------------	--------	--------

30° High Wedge Table, Freestanding, Four Legs

45-T3730H	\$2086	\$2630
-----------	--------	--------

► Specification Information, continued on next page

Circa Lounge System Modular Tables *continued*

DESIGN ALISON SPEAR, AIA

SIN 711.17

► Specification Information, continued from previous page

Specification Information

Style Number	Base Prices	
	Laminate	Wood Veneer

Straight Low Table, Ganging

45-T1300LG	\$1107	\$1261
------------	--------	--------

Straight Low Table, End-of-Run, Two Legs

45-T1300LER	\$1175	\$1464
-------------	--------	--------

Straight Low Table, Freestanding, Four Legs

45-T1300L	\$1253	\$1642
-----------	--------	--------

Straight High Table, Ganging

45-T1300HG	\$1752	\$2159
------------	--------	--------

Straight High Table, End-of-Run, Two Legs

45-T1300HER	\$1820	\$2366
-------------	--------	--------

► Specification Information, continued on next page

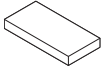

Overall: 27½"D 13½"W 8½"H
Angle Degree: 0°

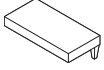

Overall: 27½"D 13½"W 8½"H
Angle Degree: 0°

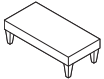

Overall: 27½"D 13½"W 8½"H
Angle Degree: 0°

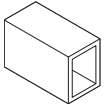

Overall: 27½"D 13½"W 22½"H
Angle Degree: 0°

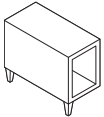

Overall: 27½"D 13½"W 22½"H
Angle Degree: 0°

Circa Lounge System Modular Tables

DESIGN ALISON SPEAR, AIA

SIN 711.17

► Specification Information, continued from previous page

Specification Information

Style Number	Base Prices	
	Laminate	Wood Veneer

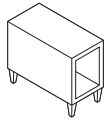

Overall: 27½"D 13½"W 22½"H
Angle Degree: 0°

Straight High Table, Freestanding, Four Legs

45-T1300H	\$1890	\$2506
-----------	--------	--------



Overall: 13¾"D 27½"W 22¼"H
(8½" from floor once assembled)
Tip: Model 45-T28HER has only a single width tapered leg, no corner.

30° End-of-Run, One Leg

45-T28HER	\$1514	\$1909
-----------	--------	--------

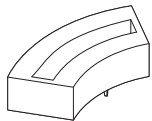

Overall: 33¼"D 70¾"W 22½"H

60° Planter Table, Ganging, Two Legs

45-T7460HPG	\$4660	\$5005
-------------	--------	--------

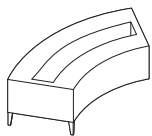

Overall: 33¼"D 70¾"W 22½"H

60° Planter Table, End-of-Run, Three Legs

45-T7460HPER	\$4733	\$5052
--------------	--------	--------

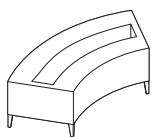

Overall: 33¼"D 70¾"W 22½"H

60° Planter Table, Freestanding, Five Legs

45-T7460HP	\$4802	\$5235
------------	--------	--------

Options for Creating 90° Applications:

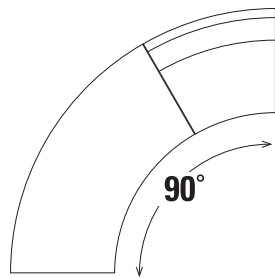

- (1) 30° Outside or Inside Facing Wedge Seat
- (1) 60° Wedge Bench

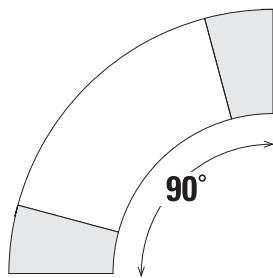

- (2) 15° Wedge Tables
- (1) 60° Wedge Bench

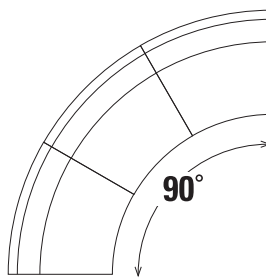

- (3) 30° Outside or Inside Facing Wedge Seats

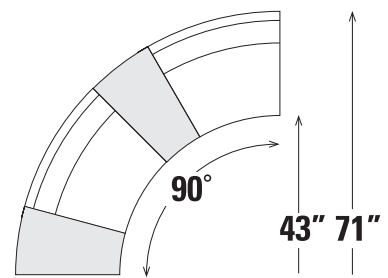

- (2) 30° Outside or Inside Facing Wedge Seats
- (2) 15° Wedge Tables

Circa Lounge System Freestanding Round Table

DESIGN ALISON SPEAR, AIA

SIN 711.17

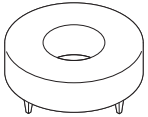

Overall: 42" dia. 15¾"H

Tip: Tapered wood and metal legs have a thin, blade aesthetic.

Tip: The round plate that houses the power/data module is powder coated to complement the power/data module finish. For the black anodized aluminum module, the round plate will be painted in 4710 Low Gloss Black. For the silver anodized aluminum module, the round plate will be painted 4799 Platinum.

Standard Includes	Required to Specify
-------------------	---------------------

- | | |
|---|---|
| <ul style="list-style-type: none"> ▶ Need help? Product details, see <i>Coalesse Seating and Outdoor Specification Guide</i> | <ul style="list-style-type: none"> • Table: laminate • Legs: <ul style="list-style-type: none"> - Tapered leg, if selected: solid maple or walnut - Cylinder leg, if selected: solid oak |
|---|---|

- | |
|---|
| <ol style="list-style-type: none"> 1 Style number 2 Wood color number for table 3 Wood leg type 4 Wood color number for legs 5 Options, if selected (see below) <p>▶ See <i>Surface Materials</i>, page 260.</p> |
|---|

Surface Materials	Options	Price	Required to Specify
-------------------	---------	-------	---------------------

Surface Materials	Table		
	<ul style="list-style-type: none"> • Wood veneer 	Price below	Specify with <i>wood veneer</i> and select wood color number. ▶ See <i>Surface Materials</i> , page 260.
	<ul style="list-style-type: none"> • Sunburst wood veneer 	Price below	Specify with <i>sunburst wood veneer</i> and select wood color number. ▶ See <i>Surface Materials</i> , page 260.

Metal Legs	Tapered legs		
	<ul style="list-style-type: none"> • Grade 1 paint 	+\$138 per leg	Specify with <i>tapered metal legs</i> and select paint color number. ▶ See <i>Surface Materials</i> , page 260.

Metal Legs	Modern legs		
	<ul style="list-style-type: none"> • Grade 1 paint 	+\$138 per leg	Specify with <i>modern metal legs</i> and select paint color number. ▶ See <i>Surface Materials</i> , page 260.

Glass Insert	<ul style="list-style-type: none"> • Green tinted glass insert ¾" thick with white enamel bottom square edge detail 	+\$254	Specify with <i>glass insert</i> .
---------------------	--	--------	------------------------------------

Power/Data Module	<ul style="list-style-type: none"> • Two power/two data ports black anodized aluminum or silver anodized aluminum 	+\$377	Specify finish color number.
--------------------------	--	--------	------------------------------

Specification Information			
Style Number	Base Prices		
	Laminate	Wood Veneer	Sunburst Wood Veneer

--	--	--	--

Round Table, Freestanding, Four Legs

45-T42RD	\$2633	\$3551	\$3835
----------	--------	--------	--------

Circa Lounge System Multi-Fabric Diagram

DESIGN ALISON SPEAR, AIA

SIN 711.17

Applies to all Circa models including: Straight 1-Seat Lounge, Wedge, and Straight 2-Seat Lounge

TO: _____

FROM: _____

DATE: _____

FAX...888.413.5161

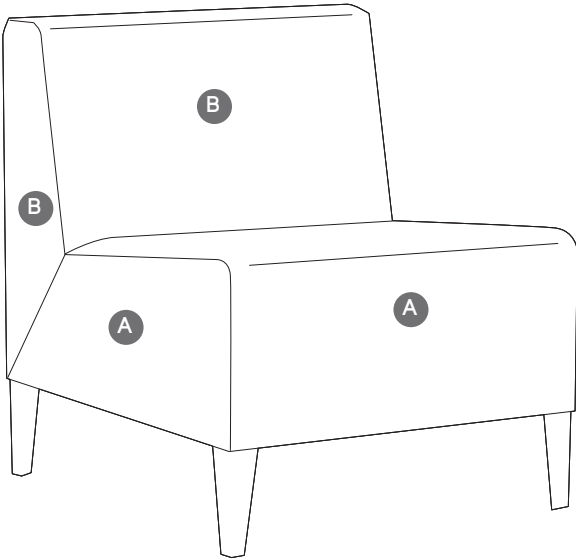

A Upholstery Selection (default for entire unit if B is not selected):

B Back: _____

**\$121 list per contrasting fabric specified. List price based on highest fabric grade usage.*

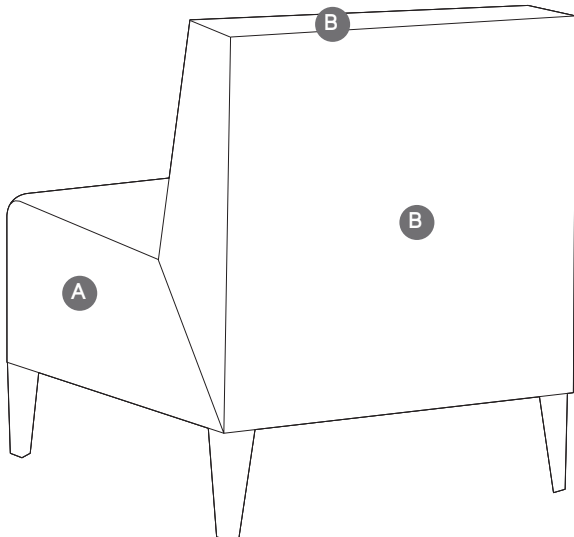

Specify model below:

- 451-7460FOK Outside Facing
- 451-7460FIK Inside Facing
- 451-5000K
- 451-2500K
- 451-3730FOK Outside Facing
- 451-3730FIK Inside Facing

Coupe

DESIGN DENNIE PIMENTAL / JOHN DUFFY

SIN 711.16

Tip: Fabrics and leathers will appear loose with comfort wrinkles when upholstered.

Tip: Recommended leathers are Elmosoft Grade C and Elmorustical Grade E.

Tip: Special color match, consult Customer Service.

Tip: Pricing based on highest grade textile specified.

Tip: For Customer's Own Material or Leather, see necessary requirements, important processing instructions, and ordering information.

▶ Page 262

Standard Includes	Required to Specify
<p>▶ Need help? Product details, see <i>Coalesse Seating and Outdoor Specification Guide</i></p> <ul style="list-style-type: none"> • Frame: unibody construction of hardwood plywood utilizing box joinery • Legs: solid beech • Glides: non-adjustable • Upholstery: multiple densities of laminated polyurethane foam and polyester fiber on seat and back with top stitch sewing detail 	<ol style="list-style-type: none"> 1 Style number 2 Number of fabrics if contrasting fabric style number is selected 3 Wood color number for legs ▶ See <i>Hardwood and Veneer Matrix</i>, page 274 4 Fabric or leather color number for upholstery on seat and back 5 Options, if selected (see below) ▶ See <i>Surface Materials</i>, page 260.

Options	Price	Required to Specify
<p>Surface Materials</p> <ul style="list-style-type: none"> • Contrasting fabric <hr/> <p>Acrylic backer</p> <ul style="list-style-type: none"> • Lounge chair • 2-seat lounge • 3-seat lounge • Ottoman 	<p>+\$121 per fabric</p> <hr/> <p>+\$ 40 +\$ 53 +\$ 65 +\$ 17</p>	<p>Add suffix K to the style number and select fabric color number.</p> <hr/> <p>Specify with acrylic backer. Specify with acrylic backer. Specify with acrylic backer. Specify with acrylic backer. ▶ See <i>Surface Materials</i>, page 260.</p>
<p>Legs</p> <ul style="list-style-type: none"> • Brushed aluminum • Powder coat <hr/> <ul style="list-style-type: none"> • Acrylic: clear 	<p>+\$166 +\$131</p> <hr/> <p>+\$232</p>	<p>Specify with brushed aluminum legs. Specify with powder coat legs and select color: 4138 Graphite Gloss 4140 Arctic White Gloss 4142 Platinum Gloss 4144 Black Gloss 4148 Midnight Brown Gloss Specify with acrylic legs.</p>
<p>Casters</p> <ul style="list-style-type: none"> • Ottoman casters 	<p>+\$146</p>	<p>Specify with casters.</p>

Specification Information

Style Number	Base Prices										Leather Grades:		
	COM	6	7	8	9	10	11	12	13	14	COL	C	E

Lounge Chair

470	\$1530	\$1530	\$1558	\$1607	\$1754	\$1850	\$1961	\$2038	\$2174	\$2365	\$1698	\$3673	\$4031
-----	--------	--------	--------	--------	--------	--------	--------	--------	--------	--------	--------	--------	--------

COM/yds = 4¼, COL/sq ft = 94

▶ Specification Information, continued on next page

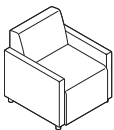

Overall: 28"D 26½"W 30"H
 Inside: 20"D 22"W 13"H
 Seat: 17"H
 Arm: 22"H

Coupe

DESIGN DENNIE PIMENTAL / JOHN DUFFY

SIN 711.16

► Specification Information, continued from previous page

Specification Information

Style Number	Base Prices										Leather Grades:		
	Fabric Grades:										COL	C	E
	COM	6	7	8	9	10	11	12	13	14			

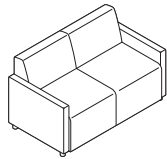

Overall: 28"D 52½"W 30"H
 Inside: 20"D 48"W 13"H
 Seat: 17"H
 Arm: 22"H

2-Seat Lounge

470-2	\$2276	\$2324	\$2363	\$2428	\$2628	\$2758	\$2908	\$3012	\$3197	\$3455	\$2440	\$5323	\$5512
-------	--------	--------	--------	--------	--------	--------	--------	--------	--------	--------	--------	--------	--------

COM/yds = 5¾, COL/sq ft = 127

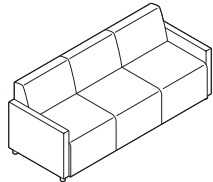

Overall: 28"D 72"W 30"H
 Inside: 20"D 67½"W 13"H
 Seat: 17"H
 Arm: 22"H

3-Seat Lounge

470-3	\$2625	\$2717	\$2764	\$2844	\$3088	\$3245	\$3427	\$3554	\$3780	\$4094	\$2781	\$6078	\$6667
-------	--------	--------	--------	--------	--------	--------	--------	--------	--------	--------	--------	--------	--------

COM/yds = 7, COL/sq ft = 154



Overall: 20"D 25"W 18"H

Ottoman

470-H	\$ 724	\$ 724	\$ 737	\$ 760	\$ 829	\$ 874	\$ 927	\$ 963	\$1027	\$1116	\$ 961	\$1867	\$2038
-------	--------	--------	--------	--------	--------	--------	--------	--------	--------	--------	--------	--------	--------

COM/yds = 2, COL/sq ft = 44

Coupe Grande/Mobile

DESIGN DENNIE PIMENTAL / JOHN DUFFY

SIN 711.16

Tip: Fabrics and leathers will appear loose with comfort wrinkles when upholstered.

Tip: Recommended leathers are Elmosoft Grade C and Elmorustical Grade E.

Tip: Special color match, consult Customer Service.

Tip: For Customer's Own Material or Leather, see necessary requirements, important processing instructions, and ordering information.
▶ Page 262

Tip: Pricing based on highest grade textile specified.

Standard Includes		Required to Specify
▶ Need help? Product details, see <i>Coalesse Seating and Outdoor Specification Guide</i>	<ul style="list-style-type: none"> • Frame: unibody construction of hardwood plywood utilizing box joinery • Legs: solid beech • Glides: non-adjustable • Upholstery: multiple densities of laminated polyurethane foam and polyester fiber on seat and back with top stitch sewing detail • On 476M model: <ul style="list-style-type: none"> - Casters: swivel hard - Locking and non-locking wheels Tablet: <ul style="list-style-type: none"> - Laminate - 13½" diameter 	1 Style number 2 Number of fabrics if contrasting fabric style number is selected 3 Wood color number for legs ▶ See <i>Hardwood and Veneer Matrix</i> , page 274 4 Fabric or leather color number for seat and back 5 Laminate color number for 476M tablet, if selected 6 Options, if selected (see below) ▶ See <i>Surface Materials</i> , page 260.

Options	Price	Required to Specify
Surface Materials	<ul style="list-style-type: none"> • Contrasting fabric +\$121 per fabric 	Add suffix K to the style number and select fabric color number.
Acrylic backer		Specify with acrylic backer.
<ul style="list-style-type: none"> • Lounge chair +\$ 47 • 2-seat lounge +\$ 62 • 3-seat lounge +\$ 74 		Specify with acrylic backer. ▶ See <i>Surface Materials</i> , page 260.
Casters (476M only)	<ul style="list-style-type: none"> • Soft casters No cost • Brushed aluminum +\$166 • Powder coat +\$131 	Specify with soft casters. Specify with brushed aluminum legs. Specify with powder coat legs and select color: 4138 Graphite Gloss 4140 Arctic White Gloss 4142 Platinum Gloss 4144 Black Gloss 4148 Midnight Brown Gloss Specify with acrylic legs.
Legs	<ul style="list-style-type: none"> • Acrylic: clear +\$232 	
Tablet (476M only)	<ul style="list-style-type: none"> • Anodized aluminum +\$226 • Wood +\$125 • Omit tablet -\$165 	Specify with anodized aluminum tablet. Specify with wood tablet and select wood color number. Specify with remove tablet.

Specification Information

Style Number	Base Prices														Leather Grades:		
	Fabric Grades:														COL	C	E
	COM	6	7	8	9	10	11	12	13	14							

Lounge Chair																	
476	\$1746	\$1767	\$1801	\$1859	\$2033	\$2144	\$2276	\$2366	\$2527	\$2751	\$1902	\$4243	\$4664				

COM/yds = 5, COL/sq ft = 110
▶ Specification Information, continued on next page

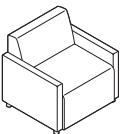

Overall: 28"D 31"W 30"H
 Inside: 20"D 25"W 13"H
 Seat: 17"H
 Arm: 22"H

Coupe Grande/Mobile

DESIGN DENNIE PIMENTAL / JOHN DUFFY

SIN 711.16

► Specification Information, continued from previous page

Specification Information

Style Number	Base Prices										Leather Grades:		
	Fabric Grades:										COL	C	E
	COM	6	7	8	9	10	11	12	13	14			

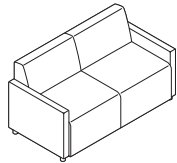

Overall: 28"D 61½"W 30"H
 Inside: 20"D 55½"W 13"H
 Seat: 17"H
 Arm: 22"H

2-Seat Lounge

476-2	\$3166	\$3223	\$3263	\$3332	\$3541	\$3675	\$3832	\$3941	\$4134	\$4403	\$3320	\$6139	\$6643
-------	--------	--------	--------	--------	--------	--------	--------	--------	--------	--------	--------	--------	--------

COM/yds = 6, COL/sq ft = 132

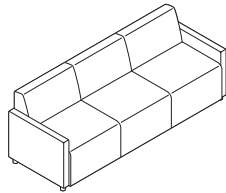

Overall: 28"D 80"W 30"H
 Inside: 20"D 74"W 13"H
 Seat: 17"H
 Arm: 22"H

3-Seat Lounge

476-3	\$3592	\$3684	\$3731	\$3811	\$4055	\$4212	\$4394	\$4521	\$4747	\$5061	\$3746	\$7044	\$7634
-------	--------	--------	--------	--------	--------	--------	--------	--------	--------	--------	--------	--------	--------

COM/yds = 7, COL/sq ft = 154

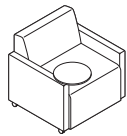

Overall: 28"D 31"W 30"H
 Inside: 20"D 25"W 13"H
 Seat: 17"H
 Arm: 22"H

Mobile Chair

476M	\$2349	\$2370	\$2404	\$2462	\$2636	\$2747	\$2879	\$2969	\$3130	\$3354	\$2505	\$4838	\$5262
------	--------	--------	--------	--------	--------	--------	--------	--------	--------	--------	--------	--------	--------

COM/yds = 5, COL/sq ft = 110

Coupe Wood Lounge Chairs

DESIGN DENNIE PIMENTAL / JOHN DUFFY

SIN 711.16

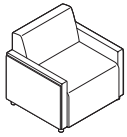

Overall: 29"D 28"W 30"H
 Inside: 20"D 22"W 13"H
 Seat: 17"H
 Arm: 22"H

Tip: Fabrics and leathers will appear loose with comfort wrinkles when upholstered.

Tip: Recommended leathers are Elmosoft Grade C and Elmorustical Grade E.

Tip: Special color match, consult Customer Service.

Tip: For Customer's Own Material or Leather, see necessary requirements, important processing instructions, and ordering information.

► Page 262

Standard Includes		Required to Specify
<ul style="list-style-type: none"> ► Need help? Product details, see <i>Coalesse Seating and Outdoor Specification Guide</i> 	<ul style="list-style-type: none"> • Frame: unibody construction of hardwood plywood utilizing box joinery • Side panels and legs: solid wood • Glides: non-adjustable • Upholstery: multiple densities of laminated polyurethane foam and polyester fiber on seat and back with top stitch sewing detail 	<ol style="list-style-type: none"> 1 Style number 2 Number of fabrics if contrasting fabric style number is selected 3 Wood finish number for legs and side panels ► See <i>Hardwood and Veneer Matrix</i>, page 274 4 Fabric or leather color number for upholstery on seat and back 5 Options, if selected (see below) ► See <i>Surface Materials</i>, page 260.

	Options	Price	Required to Specify
Surface Materials	• Contrasting fabric	+\$121 per fabric	Add suffix K to the style number and select fabric color number.
	Acrylic backer • Chair	+\$ 40	Specify with acrylic backer. ► See <i>Surface Materials</i> , page 260.
Legs	<ul style="list-style-type: none"> • Brushed aluminum • Powder coat 	+\$166 +\$131	Specify with brushed aluminum legs. Specify with powder coat legs and select color: 4138 Graphite Gloss 4140 Arctic White Gloss 4142 Platinum Gloss 4144 Black Gloss 4148 Midnight Brown Gloss Specify with acrylic legs.
	• Acrylic: clear	+\$232	

Specification Information

Style Number	Base Prices										Leather Grades:		
	Fabric Grades:										COL	C	E
	COM	6	7	8	9	10	11	12	13	14			
473MAPLE	\$3746	\$3746	\$3774	\$3823	\$3970	\$4066	\$4177	\$4254	\$4390	\$4581	\$3906	\$5880	\$6239
473WALNUT	\$3835	\$3835	\$3863	\$3912	\$4059	\$4155	\$4266	\$4343	\$4479	\$4670	\$3993	\$5976	\$6336

COM/yds = 4¼, COL/sq ft = 94

Coalesse

Joel Lounge by Walter Knoll

DESIGN EOOS

SIN 711.16



Overall: 29"D 30 1/4"W 27 1/2"H
 Seat: 16 1/4"H
 Arm: 26 1/4"H
 Inside: 21 1/2"D x 16 1/2" - 23"W x 11"H

Tip: Fabrics and leathers will appear loose with comfort wrinkles when upholstered.

Tip: For Customer's Own Material or Leather, see necessary requirements, important processing instructions, and ordering information.

► Page 262

Standard Includes	Required to Specify
► Need help? Product details, see <i>Coalesse Seating and Outdoor Specification Guide</i>	1 Style number 2 Number of fabrics if contrasting fabric style number is selected 3 Fabric or leather color number for upholstery 4 Options, if selected (see below) ► See <i>Surface Materials</i> , page 260.
<ul style="list-style-type: none"> Base frame: steel with molded rigid foam Seat frame: plywood with molded foam Base: chrome plated steel Auto swivel return mechanism 	

Options	Price	Required to Specify
Surface Materials <ul style="list-style-type: none"> Contrasting fabric 	+\$121 per fabric	Add suffix K to the style number and select fabric color number.
<ul style="list-style-type: none"> Fire code seating 	+\$237	Specify with <i>fire code seating</i> . ► See <i>Fire Code Seating</i> , page 264.
Acrylic backer <ul style="list-style-type: none"> Backer 	+\$ 34	Specify with <i>acrylic backer</i> . ► See <i>Surface Materials</i> , page 260.

Specification Information

Style Number	Base Prices											Leather Grades:		
	Fabric Grades:											COL	C	E
	COM	6	7	8	9	10	11	12	13	14				
COWK100	\$2039	\$2039	\$2063	\$2103	\$2225	\$2303	\$2395	\$2458	\$2571	\$2727	\$2197	\$3717	\$3894	

COM/yds = 3 1/2, COL/sq ft = 77

Lounge Seating

Coalesse

Joel Lounge Multi-Fabric Diagram

DESIGN E00S

SIN 711.16

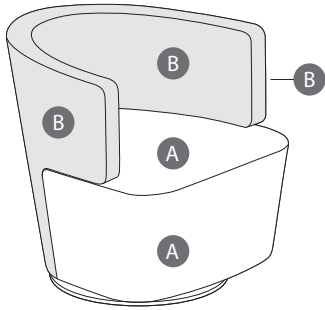

TO: _____

FROM: _____

DATE: _____

FAX...888.413.5161

A Seat (upholstery selections default for entire unit if B is not selected): _____

B Back: _____

** \$121 list upcharge for each contrasting textile pricing based on highest grade textile specified.*

Ripple Benches

DESIGN LAURINDA SPEAR,FAIA

SIN 711.16

Tip: Fabrics and leathers will appear loose with comfort wrinkles when upholstered.

Tip: Pricing based on highest grade textile specified.

Tip: Due to the design and construction techniques of Ripple lounge, only certain textiles can be successfully applied, therefore COM fabrics must be submitted to Coalesse for approval prior to order acceptance. Solid patterns with no repeat are recommended.

Tip: Recommended leathers are Elmosoft Grade C and Elmorustical Grade E.

Tip: Special color match, consult Customer Service.

Tip: For Customer's Own Material or Leather, see necessary requirements, important processing instructions, and ordering information.
▶ Page 262

Tip: 96" is a three-seat lounge.

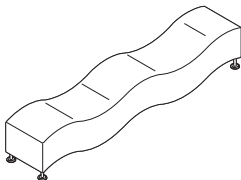

Overall: 19¼"D 97"W 19¼"H
Dip: 14"H

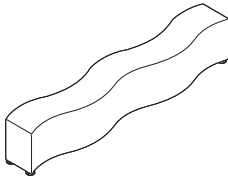

Overall: 19¼"D 97"W 19¼"H
Seat Surface: 19"H

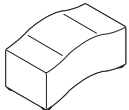

Overall: 19"D 35¾"W 19¼"H

Standard Includes		Required to Specify
▶ Need help? Product details, see <i>Coalesse Seating and Outdoor Specification Guide</i>	<ul style="list-style-type: none"> • Frame: unibody construction with finger jointed plywood • Upholstery: multiple densities of laminated polyurethane foam • Glides: height adjustable with stainless steel finish leveling polyurethane glides • Double needle stitch seams 	<ol style="list-style-type: none"> 1 Style number 2 Number of fabrics if contrasting fabric style number is selected 3 Fabric or leather color number for upholstery on bench 4 Options, if selected (see below) ▶ See <i>Surface Materials</i> , page 260.

Options	Price	Required to Specify
Surface Materials	<ul style="list-style-type: none"> • Contrasting fabric +\$121 per fabric 	Add suffix K to the style number and select fabric color number.
	Acrylic backer <ul style="list-style-type: none"> • Wave and flat seats +\$ 69 • Little Ripple wave and flat seats +\$ 30 	Specify with acrylic backer. Specify with acrylic backer. ▶ See <i>Surface Materials</i> , page 260.

Specification Information													
Style Number	Base Prices											Leather Grades:	
	Fabric Grades:											COL	C
COM	6	7	8	9	10	11	12	13	14				

Upholstered Wave Seat													
490-B96VRT	\$2139	\$2248	\$2299	\$2385	\$2646	\$2814	\$3010	\$3146	\$3387	\$3723	\$2319	\$5554	\$6136
COM/yds = 7½, COL/sq ft = 143													

Upholstered Flat Seat													
490-B96HRZ	\$2139	\$2248	\$2299	\$2385	\$2646	\$2814	\$3010	\$3146	\$3387	\$3723	\$2319	\$5554	\$6136
COM/yds = 7½, COL/sq ft = 143													

Little Ripple Wave Seat													
490-B35VRT	\$ 902	\$ 902	\$ 917	\$ 943	\$1021	\$1072	\$1131	\$1172	\$1244	\$1345	\$1147	\$2233	\$2430
COM/yds = 2¼, COL/sq ft = 50													

Sidewalk Lounge/Mobile

DESIGN STUDIO B

SIN 711.16

Tip: Fabrics and leathers will appear loose with comfort wrinkles when upholstered.

Tip: Coordinating Sidewalk tables, ottomans, and benches are available.

► Pages 102 and 241

Tip: Recommended leathers are Elmosoft Grade C and Elmorustical Grade E.

Tip: Special color match, consult Customer Service.

Tip: Multi-fabric diagram available.

► Page 98

Tip: For Customer's Own Material or Leather, see necessary requirements, important processing instructions, and ordering information.

► Page 262

Tip: Specify tablet from facing position.

Tip: Tablet can be installed on mobile models only.

Tip: Cup holder must be specified with tablet.

Tip: Extra pivoter allows tablet to be moved side to side.

Standard Includes		Required to Specify	
► Need help? Product details, see <i>Coalesse Seating and Outdoor Specification Guide</i>	<ul style="list-style-type: none"> • Frame: unibody construction with finger jointed plywood • Upholstery: multiple densities of polyurethane foam and polyester fiber on seat, back, and arms. • Lounge: <ul style="list-style-type: none"> - Legs: silver powder coat steel legs with "go" glide • Mobile: <ul style="list-style-type: none"> - 13½" diameter tablet: laminate - Legs: Silver powder coat steel legs with casters - Casters: four non-locking 	<ol style="list-style-type: none"> 1 Style number 2 Number of fabrics if contrasting fabric style number is selected 3 Fabric or leather color number for upholstery on seat, back, and arms 4 Options, if selected (see below) 	► See <i>Surface Materials</i> , page 260.

Options	Price	Required to Specify	
Surface Materials	<ul style="list-style-type: none"> • Contrasting fabric 	+\$121 per fabric	Add suffix K to the style number and select fabric color number.
	Acrylic backer		
	<ul style="list-style-type: none"> • Lounge chair • Lounge two-seat chair • Arm bolster 	+\$ 38 +\$ 51 +\$ 8	Specify with acrylic backer. Specify with acrylic backer. Specify with acrylic backer. ► See <i>Surface Materials</i> , page 260.
Tablet on Mobile Models only	<ul style="list-style-type: none"> • Wood • Anodized aluminum 	+\$137 +\$226	Specify with wood and select wood color. Specify with anodized aluminum.
Tablet Position	<ul style="list-style-type: none"> • Left-side facing • Right-side facing 	No cost No cost	Specify with left-side facing. Specify with right-side facing.
Cup Holder	<ul style="list-style-type: none"> • Cup holder 	+\$ 50	Specify with cup holder.
Tablet Side Storage	<ul style="list-style-type: none"> • Tablet side storage 	+\$ 75	Specify with tablet side storage.
Extra Pivoter	<ul style="list-style-type: none"> • Extra pivoter 	+\$183	Specify with extra pivoter.
Omit Tablet	<ul style="list-style-type: none"> • Omit tablet 	-\$158	Specify with omit tablet.
Glides	Lounge <ul style="list-style-type: none"> • "No go" ½" polyethylene glide 	No cost	Specify with "no go".
	Mobile <ul style="list-style-type: none"> • Go glides 	No cost	Specify with go glides.
Castors	<ul style="list-style-type: none"> • Locking castors 	No cost	Specify with locking castors.
Related Products	<ul style="list-style-type: none"> • Ottomans/benches • Sidewalk tables 		► Page 102 ► Page 241

Specification Information

Style Number	Base Prices										Leather Grades:		
	Fabric Grades:										COL	C	E
COM	6	7	8	9	10	11	12	13	14				

Low-Back Lounge Chair

444	\$1543	\$1543	\$1570	\$1616	\$1756	\$1846	\$1949	\$2022	\$2151	\$2331	\$1743	\$3817	\$4158
-----	--------	--------	--------	--------	--------	--------	--------	--------	--------	--------	--------	--------	--------

COM/yds = 4, COL/sq ft = 88

► Specification Information, continued on next page

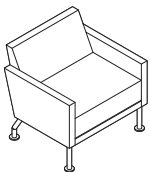

Overall: 27"D 30½"W 29"H
 Inside: 19"D 26"W 17"H
 Seat: 17½"H
 Arm: 23"H

Sidewalk Lounge/Mobile

DESIGN STUDIO B

SIN 711.16

► Specification Information, continued from previous page

Specification Information

Style Number	Base Prices										Leather Grades:		
	Fabric Grades:										COL	C	E
	COM	6	7	8	9	10	11	12	13	14			

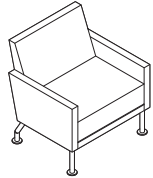

Overall: 27"D 30½"W 32"H
 Inside: 19"D 26"W 20"H
 Seat: 17½"H
 Arm: 23"H

High-Back Lounge Chair

446	\$1702	\$1706	\$1737	\$1788	\$1945	\$2046	\$2163	\$2245	\$2390	\$2591	\$1897	\$4113	\$4459
-----	--------	--------	--------	--------	--------	--------	--------	--------	--------	--------	--------	--------	--------

COM/yds = 4½, COL/sq ft = 99

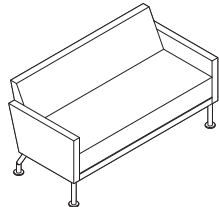

Overall: 27"D 56½"W 29"H
 Inside: 19"D 52"W 17"H
 Seat: 17½"H
 Arm: 23"H

2-Seat Lounge

444-2	\$2402	\$2442	\$2479	\$2541	\$2733	\$2856	\$2999	\$3100	\$3277	\$3523	\$2597	\$5470	\$5854
-------	--------	--------	--------	--------	--------	--------	--------	--------	--------	--------	--------	--------	--------

COM/yds = 5½, COL/sq ft = 121

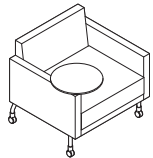

Overall: 27"D 30½"W 29"H
 Inside: 19"D 26"W 17"H
 Seat: 17½"H
 Arm: 22½"H

Low-Back Mobile Lounge Chair with Tablet

444M	\$2095	\$2095	\$2122	\$2168	\$2308	\$2398	\$2501	\$2574	\$2703	\$2883	\$2289	\$4363	\$4746
------	--------	--------	--------	--------	--------	--------	--------	--------	--------	--------	--------	--------	--------

COM/yds = 4, COL/sq ft = 88

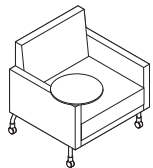

Overall: 27"D 30½"W 32"H
 Inside: 19"D 26"W 20"H
 Seat: 17½"H
 Arm: 22½"H

High-Back Mobile Lounge Chair with Tablet

446M	\$2258	\$2262	\$2293	\$2344	\$2501	\$2602	\$2719	\$2801	\$2946	\$3147	\$2444	\$4785	\$5208
------	--------	--------	--------	--------	--------	--------	--------	--------	--------	--------	--------	--------	--------

COM/yds = 4½, COL/sq ft = 99



Overall: 17½"H 5¾" Dia

Arm Bolster

440-B	\$ 281	\$ 286	\$ 294	\$ 307	\$ 339	\$ 391	\$ 430	\$ 439	\$ 457	\$ 475	\$ 575	\$ 873	\$1172
-------	--------	--------	--------	--------	--------	--------	--------	--------	--------	--------	--------	--------	--------

COM/yds = 1, COL/sq ft = 18

Sidewalk Multi-Fabric Diagram

DESIGN STUDIO B

SIN 711.16

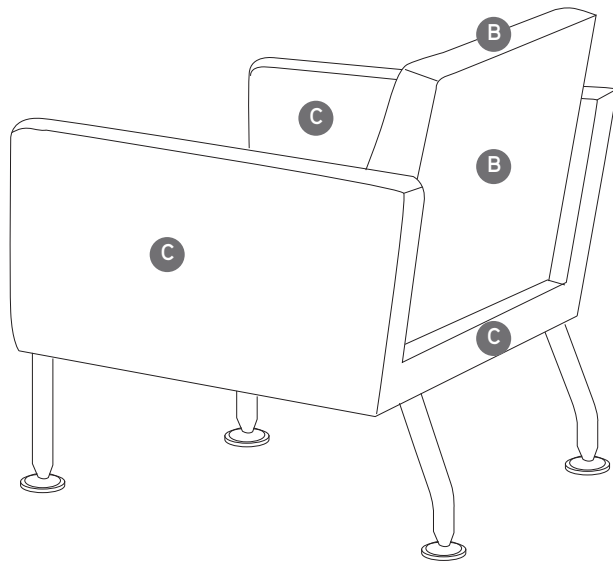
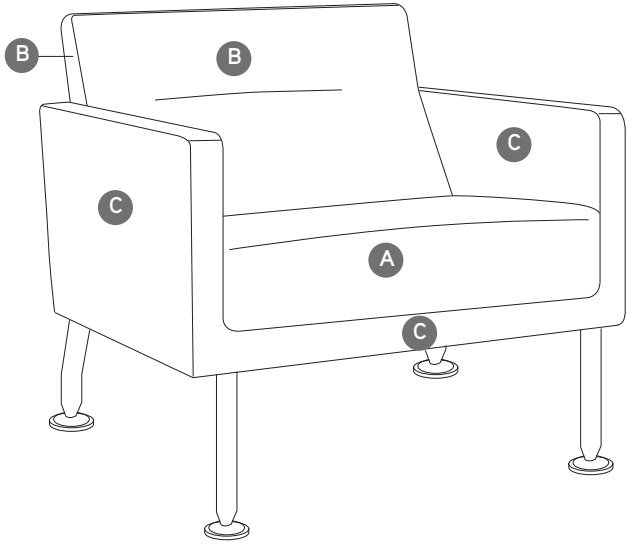

TO: _____

FROM: _____

DATE: _____

FAX....888.413.5161

A Upholstery Selection (default for entire unit if B is not selected):

B Back: _____

C Arms: _____

Total list price upcharge for contrasting fabrics: \$ _____

**\$121 list per contrasting fabric specified. List price based on highest fabric grade usage.*

Specify Model below:

- 444K Sidewalk Low-Back Lounge Chair or Mobile
- 446K Sidewalk High-Back Lounge Chair or Mobile
- 444-2K Sidewalk 2-Seat Lounge

Coalesse

Sidewalk Multi-Fabric Diagram

DESIGN STUDIO B

SIN 711.16

Lounge Seating

Sidewalk Collaborative

DESIGN STUDIO B

SIN 711.16

Tip: Fabrics and leathers will appear loose with comfort wrinkles when upholstered.

Tip: Recommended leathers are Elmosoft Grade C and Elmorustical Grade E.

Tip: Special color match, consult Customer Service.

Tip: For Customer's Own Material or Leather, see necessary requirements, important processing instructions, and ordering information.
▶ Page 262

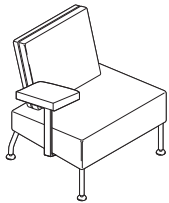

Tip: Overall width dimensions with arm options: 430: 35"W 430-2: 49"W. Overall inside width dimensions with arm options: 430: 19 1/2"W 430-2: 49"W.

▶ See Sidewalk multi-fabric diagram,
▶ Page 103

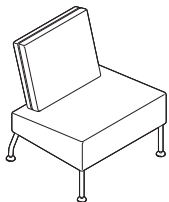

Overall: 27"D 27"W 30 1/2"H
Inside: 17"D 27"W 18"H
Seat: 17"H
Arm: 21"H

Standard Includes		Required to Specify	
▶ Need help? Product details, see <i>Coalesse Seating and Outdoor Specification Guide</i>	<ul style="list-style-type: none"> • Frame: unibody construction with finger jointed plywood • Upholstery: multiple densities of polyurethane foam and polyester fiber on seat and back • Legs: silver powder coat steel with "go" glides 	<ol style="list-style-type: none"> 1 Style number 2 Number of fabrics if contrasting fabric style number is selected 3 Fabric or leather color number for upholstery on seat and back 4 Options, if selected (see below) 	▶ See <i>Surface Materials</i> , page 260.

Options	Price	Required to Specify	
Surface Materials	<ul style="list-style-type: none"> • Contrasting fabric +\$121 per fabric 	Add suffix K to the style number and select fabric color number.	
Acrylic backer	<ul style="list-style-type: none"> • Lounge chair +\$ 23 • 2-seat chair +\$ 40 • 17"D x 17"W and 17"D x 20"W ottomans +\$ 12 • 20"D x 26"W ottoman +\$ 17 	Specify with <i>acrylic backer</i> . Specify with <i>acrylic backer</i> . Specify with <i>acrylic backer</i> . ▶ See <i>Surface Materials</i> , page 260.	
Attachment Straps	<ul style="list-style-type: none"> • Attachment straps available on 430 model +\$ 65 • Attachment straps available on 430-2 model +\$130 	Specify with <i>attachment straps</i> .	
Arms	<ul style="list-style-type: none"> • Arms on 430 and 430-2 +\$ 45 per arm 3/4 yard or 14 sq. ft. required for COM/COL	Specify with <i>arms</i> .	
Glides	<ul style="list-style-type: none"> • "No go" 1/2" polyethylene glides No cost 	Specify with "no go" <i>glides</i> .	

Specification Information

Style Number	Base Prices														Leather Grades:		
	Fabric Grades:														COL	C	E
	6	7	8	9	10	11	12	13	14								

Lounge Chair

430	\$1446	\$1446	\$1465	\$1497	\$1592	\$1654	\$1726	\$1775	\$1865	\$1988	\$1690	\$2957	\$3286
-----	--------	--------	--------	--------	--------	--------	--------	--------	--------	--------	--------	--------	--------

COM/yds = 2 3/4, COL/sq ft = 77

▶ Specification Information, continued on next page

► Specification Information, continued from previous page

Specification Information

Style Number	Base Prices											Leather Grades:		
	Fabric Grades:											COL	C	E
	COM	6	7	8	9	10	11	12	13	14				

2-Seat Lounge

430-2	\$2149	\$2149	\$2177	\$2226	\$2373	\$2469	\$2580	\$2657	\$2793	\$2984	\$2348	\$4251	\$4623
-------	--------	--------	--------	--------	--------	--------	--------	--------	--------	--------	--------	--------	--------

COM/yds = 4¼, COL/sq ft = 115

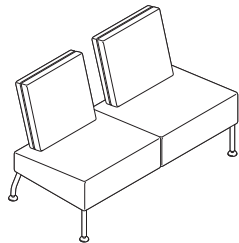

Overall: 27"D 49"W 30½"H
 Inside: 17"D 49"W 18"H
 Seat: 17"H
 Arm: 21"H

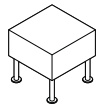

Overall: 17"D 17"W 17"H

Ottoman

430-H1717	\$ 878	\$ 878	\$ 889	\$ 906	\$ 958	\$ 992	\$1031	\$1059	\$1107	\$1173	\$1175	\$1528	\$1783
-----------	--------	--------	--------	--------	--------	--------	--------	--------	--------	--------	--------	--------	--------

COM/yds = 1½, COL/sq ft = 22½

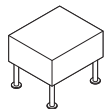

Overall: 17"D 20"W 17"H

430-H1720	\$ 878	\$ 878	\$ 889	\$ 906	\$ 958	\$ 992	\$1031	\$1059	\$1107	\$1173	\$1175	\$1528	\$1783
-----------	--------	--------	--------	--------	--------	--------	--------	--------	--------	--------	--------	--------	--------

COM/yds = 1½, COL/sq ft = 24

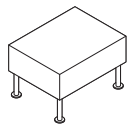

Overall: 20"D 26"W 17"H

430-H2026	\$1054	\$1054	\$1067	\$1090	\$1159	\$1204	\$1257	\$1293	\$1357	\$1446	\$1317	\$1882	\$2144
-----------	--------	--------	--------	--------	--------	--------	--------	--------	--------	--------	--------	--------	--------

COM/yds = 2, COL/sq ft = 36

Sidewalk Ottoman/Benches

DESIGN STUDIO B

SIN 711.16

Tip: Fabrics and leathers will appear loose with comfort wrinkles when upholstered.

Tip: Recommended leathers are Elmosoft Grade C and Elmorustical Grade E.

Tip: Special color match, consult Customer Service.

Tip: For Customer's Own Material or Leather, see necessary requirements, important processing instructions, and ordering information.
 ▶Page 262

Standard Includes		Required to Specify	
▶Need help? Product details, see <i>Coalesse Seating and Outdoor Specification Guide</i>	<ul style="list-style-type: none"> • Frame: unibody construction with finger jointed plywood. • Upholstery: multiple densities of polyurethane foam and polyester fiber on ottoman/benches • Legs: silver powder coat steel with "go" glides 	1 Style number 2 Fabric or leather color number for upholstery on ottoman/benches 3 Options, if selected (see below) ▶See <i>Surface Materials</i> , page 260.	
Options		Required to Specify	
Surface Materials	Acrylic backer <ul style="list-style-type: none"> • 17"D x 24"W bench +\$12 • 17"D x 36"W bench +\$17 • 17"D x 48"W bench +\$23 • Ottoman +\$30 	Specify with <i>acrylic backer</i> . Specify with <i>acrylic backer</i> . Specify with <i>acrylic backer</i> . Specify with <i>acrylic backer</i> . ▶See <i>Surface Materials</i> , page 260.	
Glides	<ul style="list-style-type: none"> • "No go" 1/2" polyethylene glides 	No cost	Specify with "no go" glides.

Specification Information

Style Number	Base Prices											Leather Grades:		
	Fabric Grades:	6	7	8	9	10	11	12	13	14	COL	C	E	

Benches

430-B1724	\$ 952	\$ 952	\$ 963	\$ 980	\$1032	\$1066	\$1105	\$1133	\$1181	\$1247	\$1247	\$1657	\$1899
------------------	--------	--------	--------	--------	--------	--------	--------	--------	--------	--------	--------	--------	--------

COM/yds = 1½, COL/sq ft = 27

430-B1736	\$1121	\$1121	\$1134	\$1157	\$1226	\$1271	\$1324	\$1360	\$1424	\$1513	\$1392	\$1958	\$2231
------------------	--------	--------	--------	--------	--------	--------	--------	--------	--------	--------	--------	--------	--------

COM/yds = 2, COL/sq ft = 36

430-B1748	\$1293	\$1293	\$1310	\$1338	\$1425	\$1482	\$1546	\$1592	\$1672	\$1784	\$1539	\$2261	\$2534
------------------	--------	--------	--------	--------	--------	--------	--------	--------	--------	--------	--------	--------	--------

COM/yds = 2½, COL/sq ft = 45

Ottoman

430-H3636	\$1308	\$1308	\$1327	\$1359	\$1454	\$1516	\$1588	\$1637	\$1727	\$1850	\$1546	\$2975	\$3279
------------------	--------	--------	--------	--------	--------	--------	--------	--------	--------	--------	--------	--------	--------

COM/yds = 2¾, COL/sq ft = 61

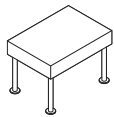

Overall: 17"D 24"W 17"H

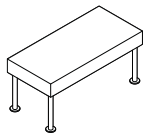

Overall: 17"D 36"W 17"H

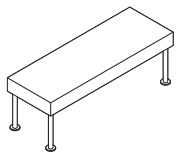

Overall: 17"D 48"W 17"H

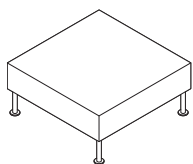

Overall: 36"D 36"W 17"H

Sidewalk Collaborative Multi-Fabric Diagram

DESIGN STUDIO B

SIN 711.16

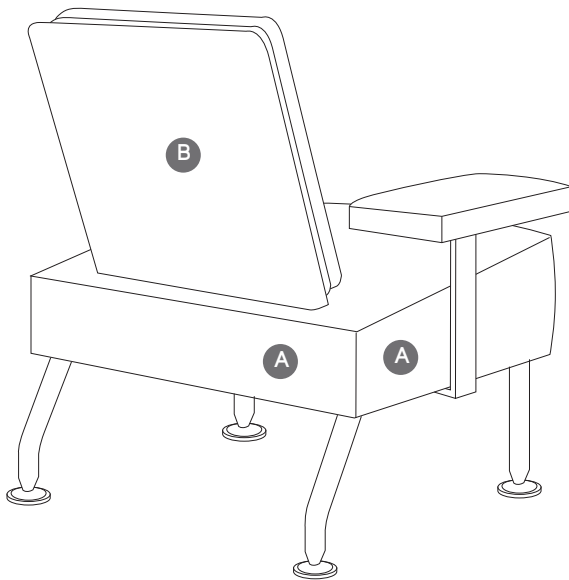
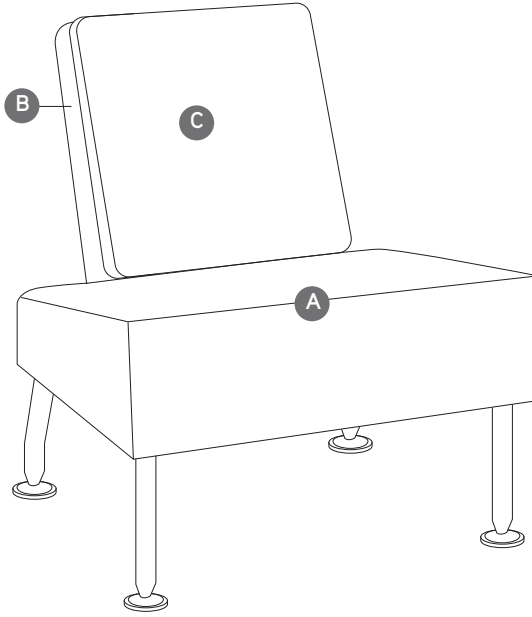

TO: _____

FROM: _____

DATE: _____

FAX....888.413.5161

A Upholstery Selection (default for entire unit if B is not selected): _____

B Back: _____

C Back Cushion: _____

Total list price upcharge for contrasting fabrics: \$ _____

**\$121 list per contrasting fabric specified. List price based on highest fabric grade usage.*

Swathmore Wood Leg

DESIGN MICHAEL SHIELDS

SIN 711.16

Tip: Fabrics and leathers will appear loose with comfort wrinkles when upholstered.

Tip: All cushions are attached.

Tip: Recommended leathers are Elmosoft Grade C and Elmorustical Grade E.

Tip: Special color match, consult Customer Service.

Tip: When contrasting fabric and non-contrasting welt are selected, the welt will match base frame.

Tip: For Customer's Own Material or Leather, see necessary requirements, important processing instructions, and ordering information.
▶Page 262

Standard Includes		Required to Specify	
▶Need help? Product details, see <i>Coalesse Seating and Outdoor Specification Guide</i>	<ul style="list-style-type: none"> • Frame: unibody construction with finger jointed plywood. • Upholstery: multiple densities of polyurethane foam and polyester fiber on seat, back, and arm cushions • Legs: solid maple • Glides: 1½" dia. non-adjustable metal 	<ol style="list-style-type: none"> 1 Style number 2 Number of fabrics if contrasting fabric style number is selected 3 Fabric or leather color number for upholstery on seat, back, and arms 4 Wood color number for legs 	<ul style="list-style-type: none"> ▶See <i>Hardwood and Veneer Matrix</i>, page 274 5 Options, if selected (see below) ▶See <i>Surface Materials</i>, page 260.
Options		Price	Required to Specify
Surface Materials	• Contrasting fabric	+\$121 per fabric	Add suffix K to the style number and select fabric color number. Specify <i>with contrasting welt</i> and select fabric color number.
	• Contrasting welt	+\$137	
	Acrylic backer		Specify <i>with acrylic backer</i> . Specify <i>with acrylic backer</i> . Specify <i>with acrylic backer</i> . ▶ See <i>Surface Materials</i> , page 260.
	• Lounge chair	+\$ 38	
	• 2-seat lounge	+\$ 51	
	• 3-seat lounge	+\$ 78	
Arm Caps	• Wood arm caps	+\$215	Add suffix WA to the style number.

Specification Information

Style Number	Base Prices											Leather Grades:		
	Fabric Grades:											COL	C	E
	COM	6	7	8	9	10	11	12	13	14				

Lounge Chair with Wood Legs

240	\$1490	\$1507	\$1570	\$1631	\$1761	\$1832	\$1883	\$1981	\$2034	\$2274	\$1690	\$3095	\$3510
-----	--------	--------	--------	--------	--------	--------	--------	--------	--------	--------	--------	--------	--------

COM/yds = 4, COL/sq ft = 88

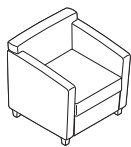

Overall: 27½"D 27"W 28½"H
Inside: 19"D 20"W 14"H
Seat: 17"H
Arm: 25"H

Two-Seat Lounge with Wood Legs

240-2	\$2525	\$2506	\$2586	\$2692	\$2839	\$3035	\$3217	\$3277	\$3362	\$3777	\$2711	\$4506	\$5022
-------	--------	--------	--------	--------	--------	--------	--------	--------	--------	--------	--------	--------	--------

COM/yds = 5½, COL/sq ft = 121

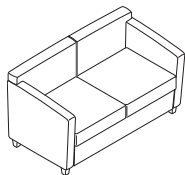

Overall: 27½"D 51"W 29"H
Inside: 19"D 44"W 14"H
Seat: 17"H
Arm: 25"H

Three-Seat Lounge with Wood Legs

240-3	\$3159	\$3193	\$3297	\$3437	\$3630	\$3865	\$4106	\$4158	\$4267	\$4796	\$3339	\$5754	\$6326
-------	--------	--------	--------	--------	--------	--------	--------	--------	--------	--------	--------	--------	--------

COM/yds = 7, COL/sq ft = 154

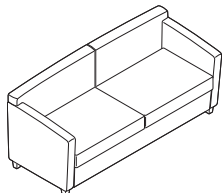

Overall: 27½"D 67"W 29½"H
Inside: 19"D 60"W 14"H
Seat: 17"H
Arm: 25"H

Swathmore Louver

DESIGN MICHAEL SHIELDS

SIN 711.16

Tip: Fabrics and leathers will appear loose with comfort wrinkles when upholstered.

Tip: All cushions are attached.

Tip: Recommended leathers are Elmosoft Grade C and Elmorustical Grade E.

Tip: Special color match, consult Customer Service.

Tip: When contrasting fabric and non-contrasting welt are selected, the welt will match base frame.

Tip: For Customer's Own Material or Leather, see necessary requirements, important processing instructions, and ordering information.
▶ Page 262

Standard Includes		Required to Specify	
▶ Need help? Product details, see <i>Coalesse Seating and Outdoor Specification Guide</i>	<ul style="list-style-type: none"> • Frame: unibody construction with finger jointed plywood. • Upholstery: multiple densities of polyurethane foam and polyester fiber on seat, back, and arm cushions • Base/legs: solid maple • Glides: 1½" dia. non-adjustable metal 	<ol style="list-style-type: none"> 1 Style number 2 Number of fabrics if contrasting fabric style number is selected 3 Fabric or leather color number for upholstery on seat, back, and arms 4 Wood color number for base 	<ul style="list-style-type: none"> ▶ See <i>Hardwood and Veneer Matrix</i>, page 274 5 Options, if selected (see below) ▶ See <i>Surface Materials</i>, page 260.
Options		Price	Required to Specify
Surface Materials	• Contrasting fabric	+\$121 per fabric	Add suffix K to the style number and select fabric color number. Specify <i>with contrasting welt</i> and select fabric color number.
	• Contrasting welt	+\$137	
	Acrylic backer		Specify <i>with acrylic backer</i> . Specify <i>with acrylic backer</i> . Specify <i>with acrylic backer</i> . ▶ See <i>Surface Materials</i> , page 260.
	• Lounge chair	+\$ 38	
	• 2-seat lounge	+\$ 51	
	• 3-seat lounge	+\$ 78	
Arm Caps	• Wood arm caps	+\$215	Add suffix WA to the style number.

Specification Information

Style Number	Base Prices										Leather Grades:		
	Fabric Grades:										COL	C	E
	COM	6	7	8	9	10	11	12	13	14			

Lounge Chair with Wood Louver Base

241	\$2094	\$2071	\$2142	\$2222	\$2338	\$2495	\$2638	\$2691	\$2763	\$3104	\$2288	\$3648	\$4084
-----	--------	--------	--------	--------	--------	--------	--------	--------	--------	--------	--------	--------	--------

COM/yds = 4, COL/sq ft = 88

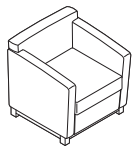

Overall: 27½"D 27"W 28½"H
Inside: 19"D 20"W 14"H
Seat: 17"H
Arm: 25"H

2-Seat Lounge with Wood Louver Base

241-2	\$3128	\$3078	\$3178	\$3279	\$3442	\$3653	\$3853	\$3906	\$4038	\$4555	\$3314	\$5253	\$5829
-------	--------	--------	--------	--------	--------	--------	--------	--------	--------	--------	--------	--------	--------

COM/yds = 5½, COL/sq ft = 121

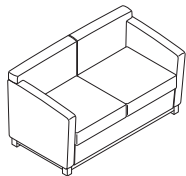

Overall: 27½"D 51"W 29"H
Inside: 19"D 44"W 14"H
Seat: 17"H
Arm: 25"H

3-Seat Lounge with Wood Louver Base

241-3	\$4031	\$4006	\$4189	\$4334	\$4607	\$4868	\$5141	\$5201	\$5358	\$6034	\$4212	\$6914	\$7509
-------	--------	--------	--------	--------	--------	--------	--------	--------	--------	--------	--------	--------	--------

COM/yds = 7, COL/sq ft = 154

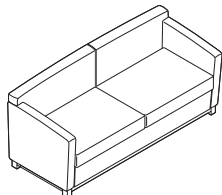

Overall: 27½"D 67"W 29½"H
Inside: 19"D 60"W 14"H
Seat: 17"H
Arm: 25"H

Swathmore Grande Wood Leg

DESIGN MICHAEL SHIELDS

SIN 711.16

Tip: Fabrics and leathers will appear loose with comfort wrinkles when upholstered.

Tip: All cushions are attached.

Tip: Recommended leathers are Elmosoft Grade C and Elmorustical Grade E.

Tip: Special color match, consult Customer Service.

Tip: When contrasting fabric and non-contrasting welt are selected, the welt will match base frame.

Tip: Arm caps can only be specified if contrasting fabric is selected.

Tip: Tablet not available on wood arm cap models.

Tip: Tablet worksurface is 21⁵/₈" x 11⁵/₈".

Standard Includes		Required to Specify
<ul style="list-style-type: none"> ▶ Need help? Product details, see <i>Coalesse Seating and Outdoor Specification Guide</i> 	<ul style="list-style-type: none"> • Frame: unibody construction with finger jointed plywood • Upholstery: multiple densities of polyurethane foam and polyester fiber on seat, back, and arm cushions • Legs: solid maple • Glides: 1¹/₈" dia. non-adjustable metal 	<ol style="list-style-type: none"> 1 Style number 2 Number of fabrics if contrasting fabric style number is selected 3 Fabric or leather color number for upholstery on seat, back, and arms 4 Wood color number for legs <p>▶ See <i>Hardwood and Veneer Matrix</i>, page 274</p> <ol style="list-style-type: none"> 5 Options, if selected (see below) <p>▶ See <i>Surface Materials</i>, page 260.</p>

Options	Price	Required to Specify
Surface Materials	<ul style="list-style-type: none"> • Contrasting fabric +\$121 per fabric • Contrasting welt +\$137 	Add suffix K to the style number and select fabric color number. Specify <i>with contrasting welt</i> and select fabric color number.
Acrylic backer	<ul style="list-style-type: none"> • Lounge chair +\$ 47 • 3-seat lounge +\$ 78 	Specify <i>with acrylic backer</i> . Specify <i>with acrylic backer</i> . ▶ See <i>Surface Materials</i> , page 260.
Arm Caps	<ul style="list-style-type: none"> • Wood arm caps +\$215 	Add suffix WA to the style number.
Tablet (243 only)	<ul style="list-style-type: none"> • Laminate tablet +\$335 • Wood tablet +\$568 	Specify <i>with laminate tablet</i> . Specify <i>with wood tablet</i> .

Specification Information													
Style Number	Base Prices												
	Fabric Grades:										Leather Grades:		
	COM	6	7	8	9	10	11	12	13	14	COL	C	E

Grande Lounge Chair with Wood Legs

243	\$1961	\$1970	\$2043	\$2129	\$2322	\$2480	\$2636	\$2733	\$2786	\$3112	\$2142	\$3639	\$4086
-----	--------	--------	--------	--------	--------	--------	--------	--------	--------	--------	--------	--------	--------

COM/yds = 5, COL/sq ft = 110

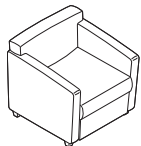

Overall: 30"D 30"W 29¹/₂"H
Inside: 20"D 21³/₄"W 15"H
Seat: 16³/₄"H
Arm: 24"H

Tip: For Customer's Own Material or Leather, see necessary requirements, important processing instructions, and ordering information.

▶ Page 262

Grande 3-Seat Lounge with Wood Legs

243-3	\$3580	\$3647	\$3771	\$3923	\$4136	\$4417	\$4684	\$4742	\$4856	\$5454	\$3768	\$6585	\$7212
-------	--------	--------	--------	--------	--------	--------	--------	--------	--------	--------	--------	--------	--------

COM/yds = 8, COL/sq ft = 176

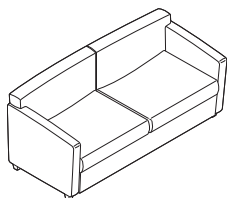

Overall: 30"D 70"W 30¹/₂"H
Inside: 20"D 61³/₄"W 15"H
Seat: 16³/₄"H
Arm: 24"H

Swathmore Grande Louver

DESIGN MICHAEL SHIELDS

SIN 711.16

Tip: Fabrics and leathers will appear loose with comfort wrinkles when upholstered.

Tip: All cushions are attached.

Tip: Recommended leathers are Elmosoft Grade C and Elmorustical Grade E.

Tip: Special color match, consult Customer Service.

Tip: When contrasting fabric and non-contrasting welt are selected, the welt will match base frame.

Tip: For Customer's Own Material or Leather, see necessary requirements, important processing instructions, and ordering information.
▶ Page 262

Standard Includes		Required to Specify
▶ Need help? Product details, see <i>Coalesse Seating and Outdoor Specification Guide</i>	<ul style="list-style-type: none"> • Frame: unibody construction with finger jointed plywood • Upholstery: multiple densities of polyurethane foam and polyester fiber on seat, back, and arm cushions • Legs: solid maple • Glides: 1½" dia. non-adjustable metal 	<ol style="list-style-type: none"> 1 Style number 2 Number of fabrics if contrasting fabric style number is selected 3 Fabric or leather color number for upholstery on seat, back, and arms 4 Wood color number for frame and legs <p>▶ See <i>Hardwood and Veneer Matrix</i>, page 274</p> <p>5 Options, if selected (see below)</p> <p>▶ See <i>Surface Materials</i>, page 260.</p>

Options	Price	Required to Specify
Surface Materials	<ul style="list-style-type: none"> • Contrasting fabric +\$121 per fabric • Contrasting welt +\$137 	Add suffix K to the style number and select fabric color number. Specify <i>with contrasting welt</i> and select fabric color number.
Acrylic backer	<ul style="list-style-type: none"> • Lounge chair +\$ 47 • 2-seat lounge +\$ 62 • 3-seat lounge +\$ 78 	Specify <i>with acrylic backer</i> . Specify <i>with acrylic backer</i> . Specify <i>with acrylic backer</i> . ▶ See <i>Surface Materials</i> , page 260.
Arm Caps	<ul style="list-style-type: none"> • Wood arm caps +\$215 	Add suffix WA to the style number.

Specification Information													
Style Number	Base Prices											Leather Grades:	
	Fabric Grades:											COL	C
	COM	6	7	8	9	10	11	12	13	14			

Grande Lounge Chair with Wood Louver

244	\$2643	\$2635	\$2693	\$2794	\$2933	\$3097	\$3271	\$3331	\$3433	\$3866	\$2831	\$4451	\$4915
-----	--------	--------	--------	--------	--------	--------	--------	--------	--------	--------	--------	--------	--------

COM/yds = 5, COL/sq ft = 110

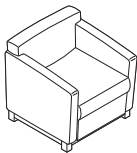

Overall: 30"D 30"W 29½"H
Inside: 20"D 21¾"W 15"H
Seat: 16¾"H
Arm: 24"H

Grande 2-Seat Lounge with Wood Louver

244-2	\$3724	\$3705	\$3806	\$3935	\$4125	\$4352	\$4592	\$4646	\$4805	\$5424	\$3917	\$6207	\$6830
-------	--------	--------	--------	--------	--------	--------	--------	--------	--------	--------	--------	--------	--------

COM/yds = 6½, COL/sq ft = 143

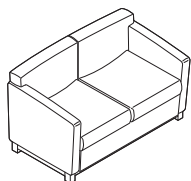

Overall: 30"D 54"W 30"H
Inside: 20"D 45¾"W 15"H
Seat: 16¾"H
Arm: 24"H

Grande 3-Seat Lounge with Wood Louver

244-3	\$4293	\$4291	\$4491	\$4660	\$4986	\$5285	\$5579	\$5664	\$5813	\$6538	\$4481	\$7623	\$8280
-------	--------	--------	--------	--------	--------	--------	--------	--------	--------	--------	--------	--------	--------

COM/yds = 8, COL/sq ft = 176

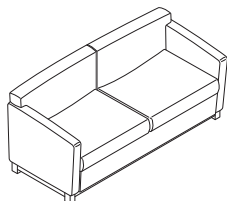

Overall: 30"D 70"W 30½"H
Inside: 20"D 61¾"W 15"H
Seat: 16¾"H
Arm: 24"H

Swathmore Grande Mobile

DESIGN MICHAEL SHIELDS

SIN 711.16

Tip: Fabrics and leathers will appear loose with comfort wrinkles when upholstered.

Tip: Soft casters are not available.

Tip: Wilsonart standard laminate colors.

►Page 276

Tip: Recommended leathers are Elmosoft Grade C and Elmorustical Grade E.

Tip: Special color match, consult Customer Service.

Tip: When contrasting fabric and non-contrasting welt are selected, the welt will match base frame.

Tip: For Customer's Own Material or Leather, see necessary requirements, important processing instructions, and ordering information.

►Page 262

Tip: Tablet worksurface is 21⁵/₈" x 11⁵/₈".

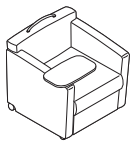

Overall: 30"D 30"W 29½"H
Inside: 20"D 21¾"W 15"H
Seat: 16¾"H
Arm: 24"H

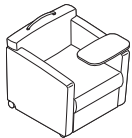

Overall: 30"D 30"W 29½"H
Inside: 20"D 21¾"W 15"H
Seat: 16¾"H
Arm: 24"H

Standard Includes

- Need help? Product details, see *Coalesse Seating and Outdoor Specification Guide*
- Frame: unibody construction with finger jointed plywood
- Hard casters: rear locking
- Steel push handle: black
- Pivoting worksurface tablet: laminate

Required to Specify

- 1 Style number
 - 2 Number of fabrics if contrasting fabric style number is selected
 - 3 Fabric or leather color number for upholstery on seat, back, and arms
 - 4 Laminate color for tablet
 - 5 Options, if selected (see below)
- See *Surface Materials*, page 260.

Options

Options	Price	Required to Specify
Surface Materials		
• Contrasting fabric	+\$121 per fabric	Add suffix K to the style number and select fabric color number. Specify <i>with contrasting welt</i> and select fabric color number.
• Contrasting welt	+\$137	
Acrylic backer		
• Backer	+\$ 47	Specify <i>with acrylic backer</i> . ► See <i>Surface Materials</i> , page 260.
Tablet		
• Omit tablet	-\$245	Specify <i>with omit tablet</i> .
• Wood tablet	+\$283	Specify <i>with wood tablet</i> .
Omit Push Handle		
• Omit push handle	-\$ 31	Specify <i>with omit push handle</i> .

Specification Information

Style Number	Base Prices														Leather Grades:		
	Fabric Grades:														COL	C	E
COM	6	7	8	9	10	11	12	13	14								

Grande Mobile Lounge Chair with Tablet Left Facing

243MTL	\$2493	\$2490	\$2554	\$2660	\$2878	\$3054	\$3238	\$3330	\$3417	\$3832	\$2679	\$4392	\$4871
---------------	--------	--------	--------	--------	--------	--------	--------	--------	--------	--------	--------	--------	--------

COM/yds = 5, COL/sq ft = 110

Grande Mobile Lounge Chair with Tablet Right Facing

243MTR	\$2493	\$2490	\$2554	\$2660	\$2878	\$3054	\$3238	\$3330	\$3417	\$3832	\$2679	\$4392	\$4871
---------------	--------	--------	--------	--------	--------	--------	--------	--------	--------	--------	--------	--------	--------

COM/yds = 5, COL/sq ft = 110

Swathmore/Grande Lounge Seating Multi-Fabric Diagram

SIN 711.16

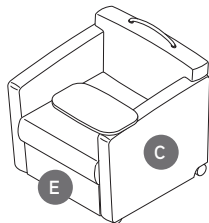
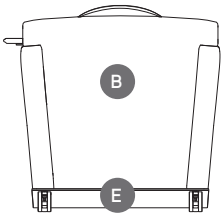
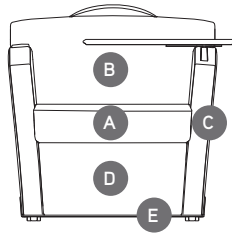
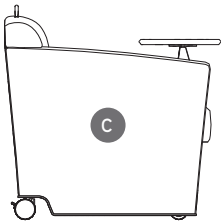
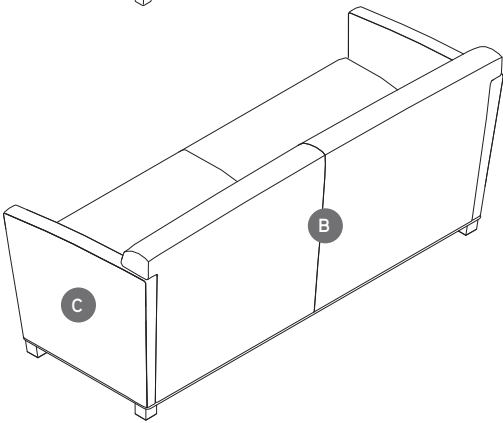
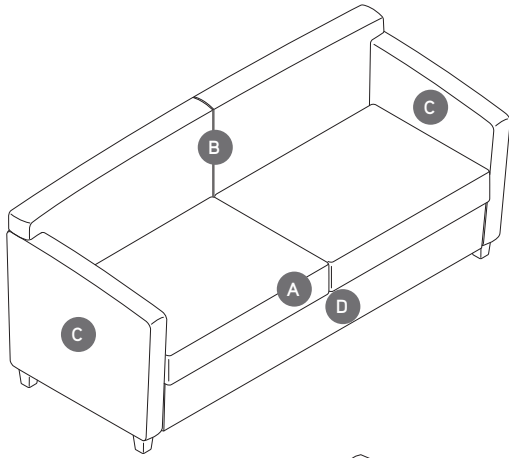

TO: _____

FROM: _____

DATE: _____

FAX...888.413.5161

- A** Seat (upholstery selections default for entire unit if B is not selected): _____
- B** Back: _____
- C** Arms: _____
- D** Base Frame: _____
- E** Welt: _____

Contrasting fabric charges will apply. List price based on highest grade textile specified. \$121 list upcharge for each contrasting textile pricing based on highest grade textile specified.

*Contrasting welt offered as a separate option. \$137 upcharge.

Tip: When contrasting fabric and non-contrasting welt are selected, the welt will match base frame.

Specify model below:

- 240 Lounge Chair with Wood Legs
- 240-2 2-Seat Lounge with Wood Legs
- 240-3 3-Seat Lounge with Wood Legs
- 241 Lounge Chair with Wood Louver Base
- 241-2 2-Seat Lounge with Wood Louver Base
- 241-3 3-Seat Lounge with Wood Louver Base
- 243 Grande Lounge Chair with Wood Legs
- 243-3 Grande 3-Seat Lounge with Wood Legs
- 244 Grande Lounge Chair with Wood Louver Base
- 244-2 Grande 2-Seat Lounge with Wood Louver Base
- 244-3 Grande 3-Seat Lounge with Wood Louver Base
- 243MTL Grande Mobile Lounge Chair with Tablet Left Facing
- 243MTR Grande Mobile Lounge Chair with Tablet Right Facing

Topo Lounge and Lounge Jr.

DESIGN METRO DESIGN GROUP

SIN 711.16

Tip: For Customer's Own Material or Leather, see necessary requirements, important processing instructions, and ordering information.
 ▶ Page 262

Tip: When specifying fabric in different price grades, the highest price grade prevails.

Tip: Fabrics and leathers will appear loose with comfort wrinkles when upholstered.

Tip: The COM yards and COL square footage listed on this page reflect the requirements for a single fabric that are based on non-directional 54"W material applied railroaded. For multi-fabric COM requirements, please refer to multi-fabric yardage.

Standard Includes		Required to Specify
▶ Need help? Product details, see <i>Coalesse Seating and Outdoor Specification Guide</i>	<ul style="list-style-type: none"> Lounge - seat, inside back, outside back and base frame: fabric or leather Lounge Jr. - seat and base frame: fabric or leather Four-arm swivel base: paint Adjustable glides: silver only 	1 Style number 2 Number of fabrics if contrasting fabric style number is selected 3 Fabric or leather color number for seat, inside back, outside back, and base frame, if selected 4 Paint color number for base 5 Options, if selected (see below) ▶ See <i>Surface Materials</i> , page 260.

Options	Price	Required to Specify
Surface Materials	<ul style="list-style-type: none"> Contrasting fabric +\$121 per fabric 	Add suffix K to the style number and select fabric color number.
Contrasting upholstery on lounge Jr.		
<ul style="list-style-type: none"> Contrasting fabric on base frame 	+\$121	Specify fabric color number for base frame. ▶ See <i>Topo multi-fabric diagram and yardage request form</i> , page 112.
Acrylic backer		
<ul style="list-style-type: none"> Lounge Lounge Jr. 	+\$ 30 +\$ 15	Specify with acrylic backer. Specify with acrylic backer. ▶ See <i>Surface Materials</i> , page 260.

Specification Information

Style Number	Base Prices														Leather Grades:		
	Fabric Grades:														COL	C	E
	COM	6	7	8	9	10	11	12	13	14							

Lounge Chair

PL2431	\$1585	\$1585	\$1602	\$1630	\$1717	\$1774	\$1838	\$1884	\$1964	\$2076	\$1713	\$2690	\$2860
COM/yds = 2½, COL/sq ft = 50													

Lounge Jr.

PLJ2417	\$1131	\$1125	\$1132	\$1143	\$1178	\$1201	\$1226	\$1245	\$1277	\$1322	\$1222	\$1704	\$1772
COM/yds = 1, COL/sq ft = 20													



Topo Mobile Lounge and Mobile Lounge Jr.

DESIGN METRO DESIGN GROUP

SIN 711.16

Tip: For Customer's Own Material or Leather, see necessary requirements, important processing instructions, and ordering information.
 ▶Page 262

Tip: When specifying fabric in different price grades, the highest price grade prevails.

Tip: Fabrics and leathers will appear loose with comfort wrinkles when upholstered.

Tip: The COM yards and COL square footage listed on this page reflect the requirements for a single fabric that are based on non-directional 54"W material applied railroaded. For multi-fabric COM requirements, please refer to multi-fabric yardage.

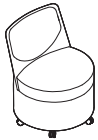

Standard Includes		Required to Specify
▶Need help? Product details, see <i>Coalesse Seating and Outdoor Specification Guide</i>	<ul style="list-style-type: none"> • Mobile lounge - seat, inside back, outside back and base frame: fabric or leather • Mobile lounge Jr. - seat and base frame: fabric or leather • Non-locking casters: black plastic 	1 Style number 2 Number of fabrics if contrasting fabric style number is selected 3 Fabric or leather color number for seat, inside back, outside back, and base frame, if selected 4 Options, if selected (see below) ▶See <i>Surface Materials</i> , page 260.

Options	Price	Required to Specify
Surface Materials	<ul style="list-style-type: none"> • Contrasting fabric +\$121 per fabric 	Add suffix K to the style number and select fabric color number.
	Contrasting upholstery on lounge Jr.	
	<ul style="list-style-type: none"> • Contrasting fabric on base frame +\$121 	Specify fabric color number for base frame. ▶ See <i>Topo multi-fabric diagram and yardage request form</i> , page 112.
	Acrylic backer	
	<ul style="list-style-type: none"> • Backer +\$ 32 	Specify with <i>acrylic backer</i> . ▶ See <i>Surface Materials</i> , page 260.

Specification Information

Style Number	Base Prices											Leather Grades:		
	Fabric Grades:											COL	C	E
	COM	6	7	8	9	10	11	12	13	14				

Mobile Lounge Chair

PLM2431	\$1603	\$1603	\$1623	\$1657	\$1761	\$1829	\$1907	\$1961	\$2058	\$2192	\$1803	\$2884	\$3089
COM/yds = 3, COL/sq ft = 60													

Mobile Lounge Jr.

PLMJ2417	\$1196	\$1196	\$1216	\$1250	\$1354	\$1422	\$1500	\$1554	\$1651	\$1785	\$1354	\$2477	\$2682
COM/yds = 3, COL/sq ft = 60													

Topo Multi-Fabric Diagram

DESIGN METRO DESIGN GROUP

SIN 711.16

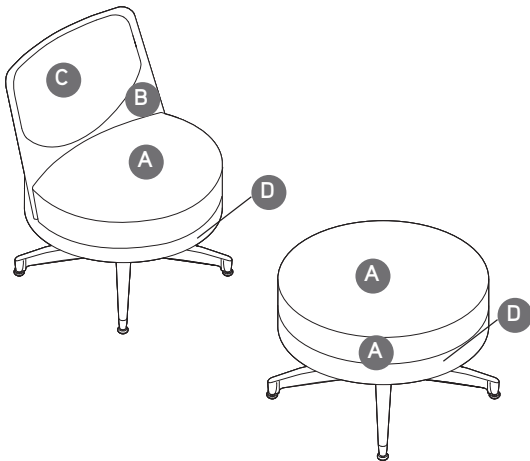
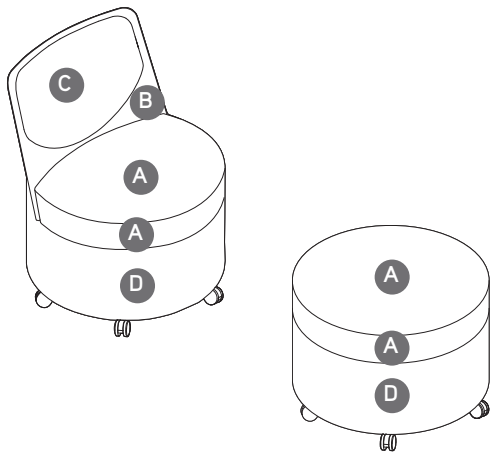

TO: _____

FROM: _____

DATE: _____

FAX....888.413.5161

Topo Lounge

- A** Seat (upholstery selections default for entire unit if B is not selected): _____
- B** Back: _____
- C** Back Cushion: _____
- D** Base Frame: _____

Topo Jr. Lounge

- A** Seat: _____
- B** Base Frame: _____

** \$121 list per contrasting fabric specified. List price based on highest fabric grade usage.*

Topo Multi-Fabric Yardage

DESIGN METRO DESIGN GROUP

SIN 711.16

Multi-Fabric Yardage

DESCRIPTION	STYLE NUMBER	COM YDS*			
		SEAT CUSHION	BACK CUSHION	ARM(S)	BACK SCREEN
Lounge	PL2431	2¼	1	1	2¼
Lounge Jr.	PLJ2417	2½	N.A.	N.A.	2½
Mobile lounge	PLM2431	2½	1	1	2½
Mobile lounge Jr.	PLMJ2417	2½	N.A.	N.A.	2½

*Fabric yardage is based on non-directional/solid fabrics. Use conversion chart below for repeat/printed fabric yardage.

Non-standard fabric requirements

Yardage requirements shown are based on non-directional 54"W material applied railroaded. Coalesse will apply fabric railroaded unless instructed otherwise on the dealer's purchase order. The following conversion chart should be used to determine yardage requirements when COM has a repeat of 2" or more. Please contact Coalesse Customer Service for a yardage quotation if the fabric is less than 54" wide, has a repeat of more than 24", or if the fabric must be cut-right.

CONVERSION CHART

PRODUCT	REPEAT		
	2" - 8"	9" - 14"	15" - 24"
All other products	15%	25%	35%

Yardage quotations will also be provided for order of 10 or more pieces.

Cutting direction guidelines

Cutting direction is based on the fabric width and the way the fabric is cut from the roll and applied to Coalesse products. There are two cutting directions: railroaded or cut-right.

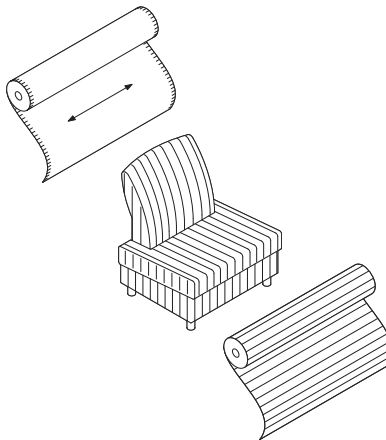

Horizontal or railroaded (across roll, warp horizontal) means fabric is cut across the roll; selvages are on the top and bottom.

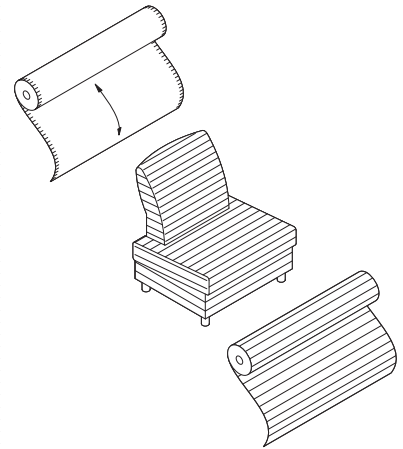

Vertical or cut-right (down roll, warp vertical) means fabric is cut in the same direction it is woven; selvages are on the left and right sides.

Coalesse reserves the right to railroad or apply fabric according to weave unless instructions specify otherwise. Fabrics are railroaded when possible to avoid seams in large upholstered areas and/or single cushion units. If a fabric is questionable, a cutting of adequate size showing full repeat (if any) should be sent to Coalesse for a fabric requirement quotation.

Davos by Viccarbe

DESIGN JEFFREY BERNETT

SIN 711.16

Tip: For Customer's Own Material or Leather, see necessary requirements, important processing instructions, and ordering information.
 ▶ Page 262

Tip: Fabrics and leathers will appear loose with comfort wrinkles when upholstered.

Tip: K suffix must be specified for leather underside.

Tip: Models with fabric underside include black denim section to allow for proper air flow. If this aesthetic is not desired, select contrasting option with leather underside.

Standard Includes		Required to Specify
▶ Need help? Product details, see <i>Coalesse Seating and Outdoor Specification Guide</i>	<ul style="list-style-type: none"> Upholstery for chair or bench: fabric or leather Glides: non-adjustable metal 	1 Style number 2 Number of fabrics if contrasting fabric style number is selected 3 Fabric or leather color number for upholstery 4 Options, if selected (see below) ▶ See <i>Surface Materials</i> , page 260.

Options	Price	Required to Specify
Surface Materials	• Contrasting fabric	+ \$121 per fabric
	Acrylic backer	
	• Chair	+ \$ 55
	• Large bench	+ \$ 34
	• Medium bench	+ \$ 25
	• Small bench	+ \$ 15
		Add suffix K to the style number and select fabric color number. Specify with <i>acrylic backer</i> . Specify with <i>acrylic backer</i> . Specify with <i>acrylic backer</i> . Specify with <i>acrylic backer</i> . ▶ See <i>Surface Materials</i> , page 260.

Specification Information													
Style Number	Base Prices											Leather Grades:	
	Fabric Grades:											COL	C
	COM	6	7	8	9	10	11	12	13	14			

Lounge Chair

CODAV	\$2278	\$2299	\$2333	\$2391	\$2565	\$2676	\$2808	\$2898	\$3059	\$3283	\$2405	\$4166	\$4466
COM/yds = 5, COL/sq ft = 110													

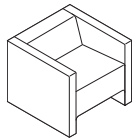

Overall: 30"D 30"W 25½"H
 Seat: 19"D 24"W 16½"H

Large Bench

CODAV60	\$1874	\$1874	\$1896	\$1933	\$2046	\$2120	\$2204	\$2263	\$2368	\$2513	\$2041	\$3059	\$3227
COM/yds = 3¼, COL/sq ft = 71½													

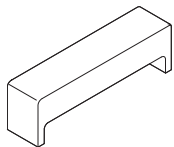

Overall: 13¼"D 59½"W 17½"H

Medium Bench

CODAV38	\$1345	\$1345	\$1362	\$1390	\$1477	\$1534	\$1598	\$1644	\$1724	\$1836	\$1538	\$2448	\$2599
COM/yds = 2½, COL/sq ft = 55													

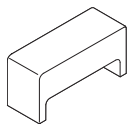

Overall: 13¼"D 38"W 17½"H

Small Bench

CODAV16	\$ 815	\$ 815	\$ 826	\$ 846	\$ 907	\$ 947	\$ 992	\$1024	\$1080	\$1159	\$1034	\$1734	\$1867
COM/yds = 1¾, COL/sq ft = 39													



Overall: 13¼"D 18½"W 17½"H

Coalesse

Davos by Viccarbe

DESIGN JEFFREY BERNETT

SIN 711.16

Lounge Seating

Hosu

DESIGN PATRICIA URQUIOLA

SIN 711.16

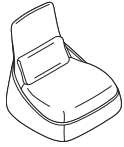

Tip: Fabrics and leathers will appear loose with comfort wrinkles when upholstered.

Tip: Recommended leathers are Elmosoft Grade C and Elmorustical Grade E.

Tip: Frame design allows back to flex to support occupants back shape.

Tip: Due to the design and construction techniques of the Hosu lounge only certain textiles can be successfully applied, therefore all COM fabrics must be submitted to Coalesse for approval prior to order acceptance.

Tip: Hexa fabrics (fabric group 10) were specifically designed by Patricia Urquiola for Hosu lounge seating.

► See *Coalesse Surface Materials Reference Guide* for complete listing of Hexa fabrics.

Standard Includes	Required to Specify
<p>► Need help? Product details, see <i>Coalesse Seating and Outdoor Specification Guide</i></p> <ul style="list-style-type: none"> • Frame: plywood tab construction • Multiple densities of polyurethane foam and polyester fiber • Seat and back: fabric or leather • Wrap: made from ABS plastic • Footrest on fabric chair, if selected: Fusion fabric or leather • Footrest on leather chair, if selected: Fashion fabric or leather to match seat and back • Glides: non-adjustable • Pull tab on ottoman, if selected: Nylon strap • Grommet for wire pass-through on models COURQLO and COURQLOK, if selected • Pillow: fabric or leather 	<ol style="list-style-type: none"> 1 Style number 2 Number of fabrics if contrasting fabric style number is selected 3 Fabric or leather color number for upholstery on seat, back, and pillow 4 Fusion color number for footrest, if selected: CL60 Caviar CL61 Portobello CL62 Graphite CL63 Java 5 Color number for pull tab with ottoman, if selected: CL40 Red CL41 Blue CL42 Black 6 Options, if selected (see below) ► See <i>Surface Materials</i>, page 260.

Options	Price	Required to Specify
<p>Surface Materials</p> <p>Pillow for lounge chair and lounge chair with ottoman</p> <ul style="list-style-type: none"> • Fabric groups 6-10 No cost • Fabric group 11 +\$149 • Fabric group 12 +\$168 • Fabric group 13 +\$203 • Fabric group 14 +\$252 • Fabric group C +\$355 • Fabric group E +\$427 • Customer's Own Material (COM) +\$ 41 • Customer's Own Leather (COL) +\$281 		<p>Specify fabric color number. Specify fabric color number. Specify fabric color number. Specify fabric color number. Specify fabric color number. Specify fabric color number. Specify fabric color number. ► See <i>Surface Materials</i>, page 260. ► See <i>Surface Materials</i>, page 260.</p>
<p>Pillows for two-seat lounge</p> <ul style="list-style-type: none"> • Fabric groups 6-10 No cost • Fabric group 11 +\$260 • Fabric group 12 +\$294 • Fabric group 13 +\$356 • Fabric group 14 +\$441 • Fabric group C +\$628 • Fabric group E +\$759 • Customer's Own Material (COM) +\$ 41 • Customer's Own Leather (COL) +\$281 		<p>Specify fabric color number. Specify fabric color number. Specify fabric color number. Specify fabric color number. Specify fabric color number. Specify fabric color number. Specify fabric color number. ► See <i>Surface Materials</i>, page 260. ► See <i>Surface Materials</i>, page 260.</p>
<ul style="list-style-type: none"> • Contrasting fabric 	+\$121 per fabric	Add suffix K to the style number and select fabric color number.
<p>Acrylic backer</p> <ul style="list-style-type: none"> • Lounge chair +\$ 40 • Lounge chair with ottoman +\$ 55 • 2-seat lounge +\$ 74 		<p>Specify with acrylic backer. Specify with acrylic backer. Specify with acrylic backer. ► See <i>Surface Materials</i>, page 260.</p>

Hosu

DESIGN PATRICIA URQUIOLA

SIN 711.16

Specification Information

Style Number	Base Prices										Leather Grades:		
	Fabric Grades:										COL	C	E
	COM	6	7	8	9	10	11	12	13	14			

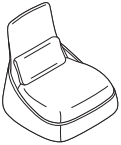

Overall: 35³/₈"D 34³/₈"W 35"H
 Inside: 24"D 31"W 14"H
 Pillow: 3"D 20⁹/₁₆"W 10¹/₈"H

Lounge Chair with Lumbar Pillow

Style Number	COM	6	7	8	9	10	11	12	13	14	COL	C	E
COURQL	\$2339	\$2370	\$2404	\$2465	\$2647	\$2765	\$2903	\$2998	\$3167	\$3402	\$2466	\$3815	\$3987

Lounge: COM/yds = 4¹/₄, COL/sq ft = 94
 Pillow: COM/yds = 1, COL/sq ft = 22

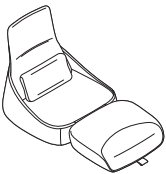

Overall: 35³/₈"D 34³/₈"W 35"H
 Overall extended: 57"L
 Inside: 24"D 31"W 14"H
 Inside extended: 48"L
 Pillow: 3"D 20⁹/₁₆"W 10¹/₈"H
 Ottoman: 24"D 31"W 8¹/₂"H

Lounge Chair with Ottoman and Lumbar Pillow

Style Number	COM	6	7	8	9	10	11	12	13	14	COL	C	E
COURQLO	\$2777	\$2860	\$2906	\$2983	\$3218	\$3369	\$3546	\$3667	\$3886	\$4187	\$2904	\$4807	\$5038

Lounge: COM/yds = 5³/₄, COL/sq ft = 126
 Pillow: COM/yds = 1, COL/sq ft = 22



Overall: 35³/₈"D 64¹/₈"W 35"H
 Inside: 24"D 57¹/₈"W 14"H
 Pillows: 3"D 24"W 10¹/₈"H

2-Seat Lounge with Two Lumbar Pillows

Style Number	COM	6	7	8	9	10	11	12	13	14	COL	C	E
COURQS	\$3650	\$3794	\$3852	\$3949	\$4245	\$4436	\$4657	\$4812	\$5086	\$5466	\$3777	\$5975	\$6237

Lounge: COM/yds = 6³/₄, COL/sq ft = 143
 Pillows: COM/yds = 1³/₄, COL/sq ft = 39

Millbrae Lounge

DESIGN COALESSE DESIGN GROUP

SIN 711.16

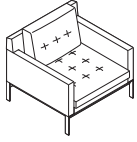

Tip: Fabrics and leathers will appear loose with comfort wrinkles when upholstered.

Tip: For Customer's Own Material or Leather, see necessary requirements, important processing instructions, and ordering information.

► Page 262

Standard Includes		Required to Specify	
<p>► Need help? Product details, see <i>Coalesse Seating and Outdoor Specification Guide</i></p> <ul style="list-style-type: none"> • Frame: constructed with finger jointed plywood • Multiple densities of polyurethane foams and polyester fiber on seat and back: fabric or leather • The lifestyle collection has tufted pattern accents and separate back cushions with double needle top stitch: fabric or leather • The contract collection has quilted pattern accents with double needle top stitch: fabric or leather • Steel base: paint • Ganging kit with attachment hardware, if selected 		<ol style="list-style-type: none"> 1 Style number 2 Fabric or leather color number for seat, back, and arms 3 Paint color number for base 4 Options, if selected (see below) <p>► See <i>Surface Materials</i>, page 260.</p>	
Surface Materials	Options	Price	Required to Specify
	<ul style="list-style-type: none"> • Contrasting fabric 	+\$ 121 per fabric	<p>Add suffix K to the style number and select fabric color number.</p> <p>► See <i>Surface Materials</i>, page 260</p>
Acrylic backer lifestyle chairs			
	<ul style="list-style-type: none"> • Lounge chair • 2-seat lounge • 3-seat lounge 	<ul style="list-style-type: none"> +\$ 57 +\$ 95 +\$ 131 	<p>Specify with acrylic backer.</p> <p>Specify with acrylic backer.</p> <p>Specify with acrylic backer.</p>
Acrylic backer contract chairs			
	<ul style="list-style-type: none"> • Lounge chair armless • Lounge chair with arms • Lounge chair left or right arm facing • 2-seat lounge armless • 2-seat lounge with arms • 2-seat lounge left or right arm facing • 3-seat lounge armless • 3-seat lounge with arms • 3-seat lounge left or right arm facing • Four-seat lounge armless • Four-seat lounge with arms • Four-seat lounge left or right arm facing • Bench • 2-seat bench • 3-seat bench • Four-seat bench 	<ul style="list-style-type: none"> +\$ 23 +\$ 38 +\$ 32 +\$ 38 +\$ 51 +\$ 45 +\$ 51 +\$ 65 +\$ 57 +\$ 65 +\$ 78 +\$ 71 +\$ 15 +\$ 23 +\$ 32 +\$ 38 	<p>Specify with acrylic backer.</p> <p>Specify with acrylic backer.</p> <p>Specify with acrylic backer.</p> <p>Specify with acrylic backer.</p> <p>Specify with acrylic backer.</p> <p>Specify with acrylic backer.</p> <p>Specify with acrylic backer.</p> <p>Specify with acrylic backer.</p> <p>Specify with acrylic backer.</p> <p>Specify with acrylic backer.</p> <p>Specify with acrylic backer.</p> <p>Specify with acrylic backer.</p> <p>Specify with acrylic backer.</p> <p>Specify with acrylic backer.</p> <p>Specify with acrylic backer.</p> <p>Specify with acrylic backer.</p>
Bolsters			
	<ul style="list-style-type: none"> • Square or round bolster pillows 	+\$ 8	<p>Specify with acrylic backer.</p> <p>► See <i>Surface Materials</i>, page 260.</p>
Base			
	<ul style="list-style-type: none"> • Lux Coating 	+\$ 105	Specify Lux Coating color number.
Plated metal			
	<ul style="list-style-type: none"> • Lounge chair • 2-seat lounge • 3-seat lounge • Four-seat lounge • One-seat bench • 2-seat bench • 3-seat bench • Four-seat bench 	<ul style="list-style-type: none"> +\$ 796 +\$ 902 +\$1326 +\$1438 +\$ 796 +\$ 902 +\$1326 +\$1438 	<p>Specify with 9238 Brushed Nickel base.</p> <p>Specify with 9238 Brushed Nickel base.</p> <p>Specify with 9238 Brushed Nickel base.</p> <p>Specify with 9238 Brushed Nickel base.</p> <p>Specify with 9238 Brushed Nickel base.</p> <p>Specify with 9238 Brushed Nickel base.</p> <p>Specify with 9238 Brushed Nickel base.</p> <p>Specify with 9238 Brushed Nickel base.</p>
Bolster/Pillow Attachment Rings	<ul style="list-style-type: none"> • Attachment rings for bolster/pillow attach to lounge attachment straps 	+\$ 65	Specify with attachment rings.
Lounge Attachment Straps	<ul style="list-style-type: none"> • Attachment straps for lounge attach to bolster/pillow attachment rings 	No cost	Specify with attachment straps for left and right sides.
Related Products	<ul style="list-style-type: none"> • Occasional tables 		► See <i>GSA Volume 5b Specification Guide</i> .

Tip: Attachment straps are standard on back cushions of Lifestyle lounge.

Millbrae Lounge

DESIGN COALESSE DESIGN GROUP

SIN 711.16

Specification Information

Style Number	Base Prices										Leather Grades:		
	Fabric Grades:										COL	C	E
	COM	6	7	8	9	10	11	12	13	14			

Lifestyle Lounge Seating

Lounge

COMSL1	\$2502	\$2533	\$2567	\$2628	\$2810	\$2928	\$3066	\$3161	\$3330	\$3565	\$2629	\$4376	\$4592
--------	--------	--------	--------	--------	--------	--------	--------	--------	--------	--------	--------	--------	--------

COM/yds = 5¼, COL/sq ft = 115

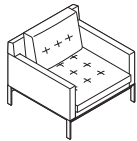

Overall: 35"D 35"W 28¾"H
Overall inside: 29"D 29"W 17"H
Inside to pillow: 22"D 29"W 17"H

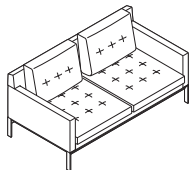

Overall: 35"D 64"W 28¾"H
Overall inside: 29"D 58"W 17"H
Inside to pillow: 22"D 58"W 17"H

2-Seat Lounge

COMSL2	\$3708	\$3844	\$3899	\$3994	\$4281	\$4466	\$4682	\$4831	\$5097	\$5467	\$3835	\$6748	\$7086
--------	--------	--------	--------	--------	--------	--------	--------	--------	--------	--------	--------	--------	--------

COM/yds = 8¼, COL/sq ft = 181

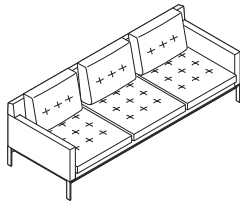

Overall: 35"D 92½"W 28¾"H
Overall inside: 29"D 87"W 17"H
Inside to pillow: 22"D 87"W 17"H

3-Seat Lounge

COMSL3	\$4596	\$4811	\$4882	\$5002	\$5368	\$5603	\$5877	\$6068	\$6406	\$6875	\$4723	\$8518	\$8948
--------	--------	--------	--------	--------	--------	--------	--------	--------	--------	--------	--------	--------	--------

COM/yds = 10½, COL/sq ft = 231

Contract Lounge Chairs

Without Arms

COMFL1	\$2128	\$2128	\$2147	\$2179	\$2274	\$2336	\$2408	\$2457	\$2547	\$2670	\$2313	\$3003	\$3106
--------	--------	--------	--------	--------	--------	--------	--------	--------	--------	--------	--------	--------	--------

COM/yds = 2¾, COL/sq ft = 60

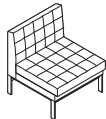

Overall: 30"D 26"W 31"H
Inside seat height: 22"D 17"H

With Arms

COMFLA1	\$2425	\$2425	\$2452	\$2498	\$2638	\$2728	\$2831	\$2904	\$3033	\$3213	\$2566	\$3838	\$4002
---------	--------	--------	--------	--------	--------	--------	--------	--------	--------	--------	--------	--------	--------

COM/yds = 4, COL/sq ft = 88

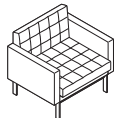

Overall: 30"D 32"W 31"H
Inside: 22"D 26½"W 17"H

With Left Arm Facing

COMFLLA1	\$2272	\$2272	\$2294	\$2331	\$2444	\$2518	\$2602	\$2661	\$2766	\$2911	\$2439	\$3428	\$3562
----------	--------	--------	--------	--------	--------	--------	--------	--------	--------	--------	--------	--------	--------

COM/yds = 3¼, COL/sq ft = 72



Overall: 30"D 29"W 31"H
Inside: 22"D 26½"W 17"H

With Right Arm Facing

COMFLRA1	\$2272	\$2272	\$2294	\$2331	\$2444	\$2518	\$2602	\$2661	\$2766	\$2911	\$2439	\$3428	\$3562
----------	--------	--------	--------	--------	--------	--------	--------	--------	--------	--------	--------	--------	--------

COM/yds = 3¼, COL/sq ft = 72

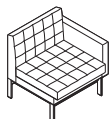

Overall: 30"D 29"W 31"H
Inside: 22"D 26½"W 17"H

► Specification Information, continued on next page

Millbrae Lounge *continued*

DESIGN COALESSE DESIGN GROUP

SIN 711.16

► Specification Information, continued from previous page

Specification Information

Style Number	Base Prices										Leather Grades:		
	Fabric Grades:										COL	C	E
	COM	6	7	8	9	10	11	12	13	14			

Contract 2-Seat Lounges

Without Arms

COMFL2	\$3391	\$3395	\$3426	\$3477	\$3634	\$3735	\$3852	\$3934	\$4079	\$4280	\$3518	\$4790	\$4954
--------	--------	--------	--------	--------	--------	--------	--------	--------	--------	--------	--------	--------	--------

COM/yds = 4½, COL/sq ft = 99

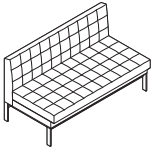

Overall: 30"D 52"W 31"H
Inside seat height: 22"D 17"H

With Arms

COMFLA2	\$3644	\$3692	\$3731	\$3796	\$3996	\$4126	\$4276	\$4380	\$4565	\$4823	\$3771	\$5625	\$5851
---------	--------	--------	--------	--------	--------	--------	--------	--------	--------	--------	--------	--------	--------

COM/yds = 5¾, COL/sq ft = 126

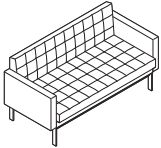

Overall: 30"D 58"W 31"H
Inside: 22"D 52½"W 17"H

With Left Arm Facing

COMFLLA2	\$3518	\$3539	\$3573	\$3631	\$3805	\$3916	\$4048	\$4138	\$4299	\$4523	\$3645	\$5200	\$5392
----------	--------	--------	--------	--------	--------	--------	--------	--------	--------	--------	--------	--------	--------

COM/yds = 5, COL/sq ft = 110

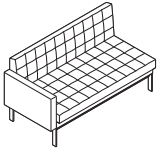

Overall: 30"D 55"W 31"H
Inside: 22"D 52¾"W 17"H

With Right Arm Facing

COMFLRA2	\$3518	\$3539	\$3573	\$3631	\$3805	\$3916	\$4048	\$4138	\$4299	\$4523	\$3645	\$5200	\$5392
----------	--------	--------	--------	--------	--------	--------	--------	--------	--------	--------	--------	--------	--------

COM/yds = 5, COL/sq ft = 110

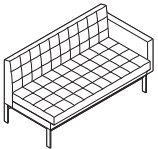

Overall: 30"D 55"W 31"H
Inside: 22"D 52¾"W 17"H

► Specification Information, continued on next page

Millbrae Lounge

DESIGN COALESSE DESIGN GROUP

SIN 711.16

► Specification Information, continued from previous page

Specification Information

Style Number	Base Prices														Leather Grades:		
	Fabric Grades:														COL	C	E
	COM	6	7	8	9	10	11	12	13	14							

Contract 3-Seat Lounges

Without Arms

COMFL3	\$4215	\$4272	\$4312	\$4381	\$4590	\$4724	\$4881	\$4990	\$5183	\$5452	\$4342	\$6196	\$6422
---------------	--------	--------	--------	--------	--------	--------	--------	--------	--------	--------	--------	--------	--------

COM/yds = 6, COL/sq ft = 132

With Arms

COMFLA3	\$4469	\$4578	\$4629	\$4715	\$4976	\$5144	\$5340	\$5476	\$5717	\$6053	\$4596	\$7033	\$7320
----------------	--------	--------	--------	--------	--------	--------	--------	--------	--------	--------	--------	--------	--------

COM/yds = 7½, COL/sq ft = 159

With Left Arm Facing

COMFLLA3	\$4342	\$4425	\$4471	\$4548	\$4783	\$4934	\$5111	\$5232	\$5451	\$5752	\$4469	\$6623	\$6880
-----------------	--------	--------	--------	--------	--------	--------	--------	--------	--------	--------	--------	--------	--------

COM/yds = 6¾, COL/sq ft = 148

With Right Arm Facing

COMFLRA3	\$4342	\$4425	\$4471	\$4548	\$4783	\$4934	\$5111	\$5232	\$5451	\$5752	\$4469	\$6623	\$6880
-----------------	--------	--------	--------	--------	--------	--------	--------	--------	--------	--------	--------	--------	--------

COM/yds = 6¾, COL/sq ft = 148

► Specification Information, continued on next page

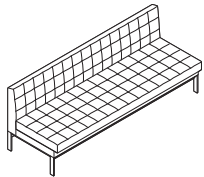

Overall: 30"D 78"W 31"H
Inside seat height: 22"D 17"H

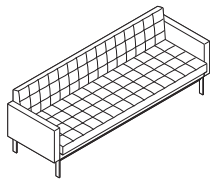

Overall: 30"D 84"W 31"H
Inside: 22"D 78½"W 17"H

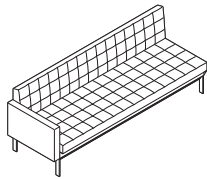

Overall: 30"D 81"W 31"H
Inside: 22"D 78¾"W 17"H

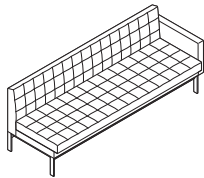

Overall: 30"D 81"W 31"H
Inside: 22"D 78¾"W 17"H

Lounge Seating

Millbrae Lounge *continued*

DESIGN COALESSE DESIGN GROUP

SIN 711.16

► Specification Information, continued from previous page

Specification Information

Style Number	Base Prices											Leather Grades:		
	Fabric Grades:											COL	C	E
	COM	6	7	8	9	10	11	12	13	14				

Contract Four-Seat Lounges

Without Arms

COMFL4	\$4469	\$4588	\$4640	\$4728	\$4998	\$5172	\$5374	\$5514	\$5764	\$6112	\$4596	\$7033	\$7320
COM/yds = 7¾, COL/sq ft = 170													

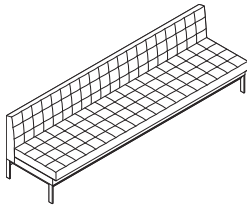

Overall: 30"D 104"W 31"H
Inside seat height: 22"D 17"H

With Arms

COMFLA4	\$4723	\$4877	\$4935	\$5035	\$5340	\$5537	\$5765	\$5923	\$6205	\$6597	\$4850	\$7870	\$8218
COM/yds = 8¾, COL/sq ft = 192													

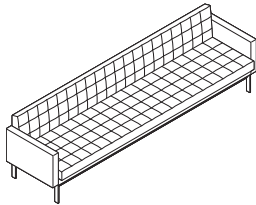

Overall: 30"D 110"W 31"H
Inside: 22"D 104½"W 17"H

With Left Arm Facing

COMFLLA4	\$4596	\$4732	\$4787	\$4882	\$5196	\$5354	\$5570	\$5719	\$5985	\$6355	\$4723	\$7441	\$7759
COM/yds = 8¼, COL/sq ft = 181													

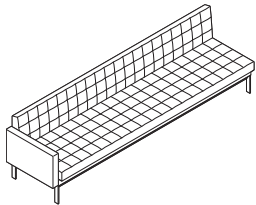

Overall: 30"D 107"W 31"H
Inside: 22"D 104¾"W 17"H

With Right Arm Facing

COMFLRA4	\$4596	\$4732	\$4787	\$4882	\$5196	\$5354	\$5570	\$5719	\$5985	\$6355	\$4723	\$7441	\$7759
COM/yds = 8¼, COL/sq ft = 181													

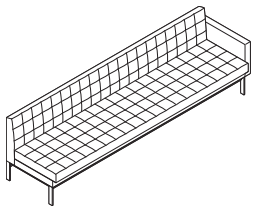

Overall: 30"D 107"W 31"H
Inside: 22"D 104¾"W 17"H

► Specification Information, continued on next page

Millbrae Lounge

DESIGN COALESSE DESIGN GROUP

SIN 711.16

► Specification Information, continued from previous page

Specification Information

Style Number	Base Prices											Leather Grades:		
	Fabric Grades:											COL	C	E
	COM	6	7	8	9	10	11	12	13	14				

Contract Lounge Benches

One-Seat Bench

COMFLB1	\$1712	\$1712	\$1723	\$1743	\$1804	\$1844	\$1889	\$1921	\$1977	\$2056	\$1931	\$2339	\$2411
---------	--------	--------	--------	--------	--------	--------	--------	--------	--------	--------	--------	--------	--------

COM/yds = 1¾, COL/sq ft = 39

2-Seat Bench

COMFLB2	\$2381	\$2381	\$2400	\$2432	\$2527	\$2589	\$2661	\$2710	\$2800	\$2923	\$2566	\$3256	\$3359
---------	--------	--------	--------	--------	--------	--------	--------	--------	--------	--------	--------	--------	--------

COM/yds = 2¾, COL/sq ft = 60

3-Seat Bench

COMFLB3	\$2780	\$2780	\$2802	\$2839	\$2952	\$3026	\$3110	\$3169	\$3274	\$3419	\$2947	\$3936	\$4070
---------	--------	--------	--------	--------	--------	--------	--------	--------	--------	--------	--------	--------	--------

COM/yds = 3¼, COL/sq ft = 72

Four-Seat Bench

COMFLB4	\$3073	\$3077	\$3108	\$3159	\$3316	\$3417	\$3534	\$3616	\$3761	\$3962	\$3200	\$4472	\$4636
---------	--------	--------	--------	--------	--------	--------	--------	--------	--------	--------	--------	--------	--------

COM/yds = 4½, COL/sq ft = 93

Contract Lounge Round Arm Bolster

COMLPRND	\$ 308	\$ 294	\$ 299	\$ 307	\$ 333	\$ 350	\$ 370	\$ 383	\$ 407	\$ 441	\$ 548	\$ 566	\$ 598
----------	--------	--------	--------	--------	--------	--------	--------	--------	--------	--------	--------	--------	--------

COM/yds = ¾, COL/sq ft = 17

Contract Lounge Square Arm Bolster

COMLPSQR	\$ 308	\$ 302	\$ 309	\$ 320	\$ 355	\$ 378	\$ 403	\$ 422	\$ 454	\$ 499	\$ 548	\$ 654	\$ 696
----------	--------	--------	--------	--------	--------	--------	--------	--------	--------	--------	--------	--------	--------

COM/yds = 1, COL/sq ft = 22

Contract Lounge Ganging Kit

COMF1	\$ 70	N.A.	N.A.	N.A.	N.A.	N.A.	N.A.	N.A.	N.A.	N.A.	N.A.	N.A.	N.A.
-------	-------	------	------	------	------	------	------	------	------	------	------	------	------

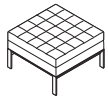

Overall: 26"D 26"W 16½"H

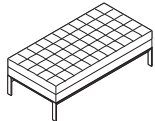

Overall: 26"D 52"W 16½"H

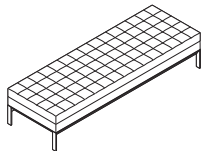

Overall: 26"D 78"W 16½"H

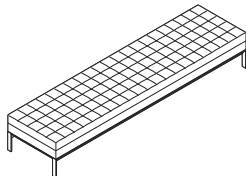

Overall: 26"D 104"W 16½"H



Overall: 18½"D 7"W 7"H



Overall: 18½"D 7"W 7"H

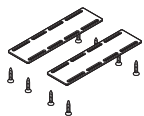

Lounge Seating

Lagunitas Lounge System 1-Seat Lounges

DESIGN TOAN NGUYEN

SIN 711.16

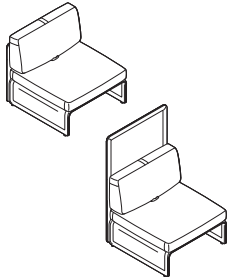

Standard Includes	Required to Specify
<p>► Need help? Product details, see <i>Coalesse Seating and Outdoor Specification Guide</i>.</p> <ul style="list-style-type: none"> • Screen: grade 1 knit • Seat deck: grade 1 knit to match screen • Non-contrasting seat cushion, articulating back cushion and pulls, back corner cushion, and end arm cushions: fabric or leather • Bracket: paint • Six adjustable glides • Ships assembled 	<ol style="list-style-type: none"> 1 Style number 2 Knit color number for screen 3 Fabric or leather color number for non-contrasting seat cushion, articulating back cushion and pulls, and end arm cushions, if selected 4 Paint color number for bracket: 4141 Platinum Matte 4710 Low Gloss Black 5 Options, if selected (see below) <p>► See <i>Coalesse Surface Materials Reference Guide</i>.</p>

Options	Price	Required to Specify
<p>Surface Materials</p> <p>Fabric screen</p> <ul style="list-style-type: none"> • 1-seat lounge with low-back screen +\$184 • 1-seat lounge with low-back screen and two side screens +\$341 • 1-seat lounge with high-back screen +\$210 • 1-seat lounge with high-back screen and two side screens +\$419 <hr/> <ul style="list-style-type: none"> • Contrasting fabric for screen +\$121 • Contrasting fabric for cushion +\$121 <hr/> <ul style="list-style-type: none"> • Contrasting fabric for top and bottom articulating back pulls +\$121 <hr/> <ul style="list-style-type: none"> • Fabric upcharges Prices at right <hr/> <p>Knit screen</p> <ul style="list-style-type: none"> • Grade 1 knit screen No cost • Grade 2 knit screen <ul style="list-style-type: none"> – 1-seat lounge with low-back screen +\$185 – 1-seat lounge with low-back screen and two side screens +\$395 – 1-seat lounge with high-back screen +\$210 – 1-seat lounge with high-back screen and two side screens +\$473 <hr/> <p>Acrylic backer</p> <ul style="list-style-type: none"> • 1-seat lounge with low-back screen +\$ 34 • 1-seat lounge with low-back screen and two side screens +\$ 70 • 1-seat lounge with high-back screen +\$ 56 • 1-seat lounge with high-back screen and two side screens +\$ 92 <hr/> <ul style="list-style-type: none"> • COM +\$154 <hr/> <ul style="list-style-type: none"> • COL +\$281 		<p>Specify with <i>screen type fabric</i>. Specify with <i>screen type fabric</i>.</p> <p>Specify with <i>screen type fabric</i>. Specify with <i>screen type fabric</i>.</p> <p>Specify with <i>contrasting fabric</i> and select fabric or leather color number. Specify with <i>contrasting fabric</i> and select fabric or leather color number.</p> <p>Specify with <i>contrasting fabric</i> and select fabric or leather color number.</p> <p>Specify fabric color number.</p> <p>Specify with <i>screen type knit</i> and select knit color number.</p> <p>Specify with <i>screen type knit</i> and select knit color number. Specify with <i>screen type knit</i> and select knit color number. Specify with <i>screen type knit</i> and select knit color number.</p> <p>Specify with <i>acrylic backer</i>. Specify with <i>acrylic backer</i>. Specify with <i>acrylic backer</i>. Specify with <i>acrylic backer</i>.</p> <p>► See <i>Coalesse Surface Materials Reference Guide</i>.</p> <p>Specify with <i>COM</i> and select fabric color number. ► See <i>Coalesse Surface Materials Reference Guide</i>.</p> <p>Specify with <i>COL</i> and select leather color number. ► See <i>Coalesse Surface Materials Reference Guide</i>.</p>

► Options, continued on next page

Tip: If contrasting screen is selected, it is required to specify whether seat deck finish will match inner screen or outer screen.

Tip: Contrasting fabric for articulating back pulls upcharge is applied one time per style number.

Tip: When contrasting fabric for articulating back pulls is selected, only one contrasting fabric can be specified and will apply to all pulls.

Tip: For Customer's Own Material or Leather, see necessary requirements, important processing instructions and ordering information.

► See *Coalesse Surface Materials Reference Guide*.

Tip: For any portion of the product that requires a COM, the additional upcharge is a one time charge per product.

Tip: For any portion of the product that requires a COL, the additional upcharge is a one time charge per product.

Lagunitas Lounge System 1-Seat Lounges

DESIGN TOAN NGUYEN

SIN 711.16

Tip: For each USB port specified, there is one USB per port.

► Options, continued from previous page

	Options	Price	Required to Specify
Power/USB Configuration	• One power module: two power in 4710 Low Gloss Black paint	+\$314	Specify with one power module, with two power.
	• One power module: one USB/ one power in 4710 Low Gloss Black paint	+\$417	Specify with one power module, with one power/one USB.

- Related Products**
- Bench
 - Chaise
 - Lagunitas tables
 - Lounge booth connector screen and alignment connector

- Page 150
- Pages 142–146
- See *GSA Volume 5b Specification Guide*.
- Page 152

► Specification Information, on next page

Lagunitas Lounge System 1-Seat Lounges *continued*

DESIGN TOAN NGUYEN

SIN 711.16

► Options, on previous page

Specification Information

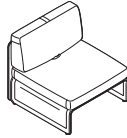

One articulating back
Overall: 32¾"W x 34"D x 32¾"H
Inside (Lounge): 32¾"W x 22½"D
Inside (Task): 32¾"W x 17¾"D
Seat: 16"H

Style Number Base Price

1-Seat Lounge with Low-Back Screen

COLAGLL11 \$1986

Fabric Upcharges

	Fabric Grades:										Leather Grades:	
	6	7	8	9	10	11	12	13	14	C	E	
Articulating Back Pulls (if top and bottom contrasting pulls are selected)	+\$ 20	+\$ 24	+\$ 30	+\$ 50	+\$ 62	+\$ 77	+\$ 87	+\$105	+\$ 131	+\$189	+\$222	
Seat Cushion	+\$ 86	+\$103	+\$130	+\$216	+\$271	+\$335	+\$379	+\$458	+\$ 569	+\$821	+\$965	
Back Cushion	+\$ 86	+\$103	+\$130	+\$216	+\$271	+\$335	+\$379	+\$458	+\$ 569	+\$821	+\$965	
Inside Screen	+\$ 104	+\$126	+\$160	+\$264	+\$332	+\$409	+\$466	+\$563	+\$ 697	N.A.	N.A.	
Outside Screen	+\$ 152	+\$182	+\$233	+\$383	+\$482	+\$593	+\$674	+\$813	+\$1007	N.A.	N.A.	

Tip: Articulating back pull fabric upcharges only apply when contrasting pulls are selected.

One Articulating Back: Seat Deck: 2.6 yards, Inside Screen: 1.4 yards, Outside Screen: 1.6 yards, Seat Cushion: 2.2 yards, 48.4 sq ft, Back Cushion: 2.2 yards, 48.4 sq ft, Contrasting Pulls on Articulating Back Cushion: 0.5 yards, 1.1 sq ft

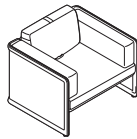

One articulating back and end arm cushions
Overall: 49¼"W x 34"D x 32¾"H
Seat: 16"H

Style Number Base Price

1-Seat Lounge with Low-Back Screen and Two Side Screens

COLAGLL13 \$3137

Fabric Upcharges

	Fabric Grades:										Leather Grades:	
	6	7	8	9	10	11	12	13	14	C	E	
Articulating Back Pulls (if top and bottom contrasting pulls are selected)	+\$ 20	+\$ 24	+\$ 30	+\$ 50	+\$ 62	+\$ 77	+\$ 87	+\$ 105	+\$ 131	+\$ 189	+\$ 222	
Seat Cushion	+\$ 101	+\$121	+\$155	+\$255	+\$321	+\$ 396	+\$ 449	+\$ 542	+\$ 671	+\$ 970	+\$1140	
Back Cushion	+\$ 215	+\$256	+\$327	+\$540	+\$678	+\$ 837	+\$ 949	+\$1146	+\$1421	+\$2052	+\$2412	
Inside Screen	+\$ 209	+\$249	+\$317	+\$525	+\$659	+\$ 814	+\$ 923	+\$1115	+\$1382	N.A.	N.A.	
Outside Screen	+\$ 277	+\$329	+\$420	+\$693	+\$869	+\$1074	+\$1216	+\$1469	+\$1820	N.A.	N.A.	

Tip: Articulating back pull fabric upcharges only apply when contrasting pulls are selected.

One Articulating Back and End Arm Cushions: Arm: 0, Seat Deck: 1.8 yards, Inside Screen: 4.4 yards, Outside Screen: 5.1 yards, Seat Cushion: 2.6 yards, 57.2 sq ft, Back Cushion: 5.5 yards, 121 sq ft, Contrasting Pulls on Articulating Back Cushion: 0.5 yards, 1.1 sq ft

► Specification Information, continued on next page

Lagunitas Lounge System 1-Seat Lounges

DESIGN TOAN NGUYEN

SIN 711.16

► Specification Information, continued from previous page

Specification Information

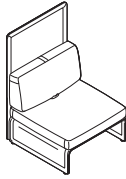

One articulating back
Overall: 32¾"W x 34"D x 50"H
Inside (Lounge): 32¾"W x 22½"D
Inside (Task): 32¾"W x 17¾"D
Seat: 16"H

Style Number Base Price

1-Seat Lounge with High-Back Screen

COLAGLH11 \$2300

Fabric Upcharges

	Fabric Grades:										Leather Grades:	
	6	7	8	9	10	11	12	13	14	C	E	
Articulating Back Pulls (if top and bottom contrasting pulls are selected)	+\$ 20	+\$ 24	+\$ 30	+\$ 50	+\$ 62	+\$ 77	+\$ 87	+\$105	+\$ 131	+\$189	+\$222	
Seat Cushion	+\$ 86	+\$103	+\$130	+\$216	+\$271	+\$335	+\$379	+\$458	+\$ 569	+\$821	+\$965	
Back Cushion	+\$ 86	+\$103	+\$130	+\$216	+\$271	+\$335	+\$379	+\$458	+\$ 569	+\$821	+\$965	
Inside Screen	+\$ 104	+\$126	+\$160	+\$264	+\$332	+\$411	+\$466	+\$563	+\$ 697	N.A.	N.A.	
Outside Screen	+\$ 152	+\$182	+\$233	+\$383	+\$482	+\$594	+\$674	+\$813	+\$1007	N.A.	N.A.	

Tip: Articulating back pulls fabric upcharges only apply when contrasting pulls are selected.

One Articulating Back: Seat Deck: 2.6 yards, Inside Screen: 1.4 yards, Outside Screen: 1.6 yards, Seat Cushion: 2.2 yards, 48.4 sq ft, Back Cushion: 2.2 yards, 48.4 sq ft, Contrasting Pulls on Articulating Back Cushion: 0.5 yards, 1.1 sq ft

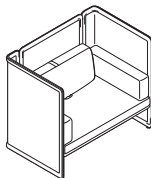

One articulating back and end arm cushions
Overall: 49¼"W x 34"D x 50"H
Seat: 16"H

Style Number Base Price

1-Seat Lounge with High-Back Screen and Two Side Screens

COLAGLH13 \$4182

Fabric Upcharges

	Fabric Grades:										Leather Grades:	
	6	7	8	9	10	11	12	13	14	C	E	
Articulating Back Pulls (if top and bottom contrasting pulls are selected)	+\$ 20	+\$ 24	+\$ 30	+\$ 50	+\$ 62	+\$ 77	+\$ 87	+\$ 105	+\$ 131	+\$ 189	+\$ 222	
Seat Cushion	+\$ 101	+\$121	+\$155	+\$255	+\$321	+\$ 396	+\$ 449	+\$ 542	+\$ 671	+\$ 970	+\$1140	
Back Cushion	+\$ 215	+\$256	+\$327	+\$540	+\$678	+\$ 837	+\$ 949	+\$1146	+\$1421	+\$2052	+\$2412	
Inside Screen	+\$ 209	+\$249	+\$317	+\$525	+\$659	+\$ 814	+\$ 923	+\$1115	+\$1382	N.A.	N.A.	
Outside Screen	+\$ 277	+\$329	+\$420	+\$693	+\$869	+\$1074	+\$1216	+\$1469	+\$1820	N.A.	N.A.	

Tip: Articulating back pulls fabric upcharges only apply when contrasting pulls are selected.

One Articulating Back and End Arm Cushions: Arm: 0, Seat Deck: 1.8 yards, Inside Screen: 4.4 yards, Outside Screen: 5.1 yards, Seat Cushion: 2.6 yards, 57.2 sq ft, Back Cushion: 5.5 yards, 121 sq ft, Contrasting Pulls on Articulating Back Cushion: 0.5 yards, 1.1 sq ft

Lagunitas Lounge System 2-Seat Lounges

DESIGN TOAN NGUYEN

SIN 711.16

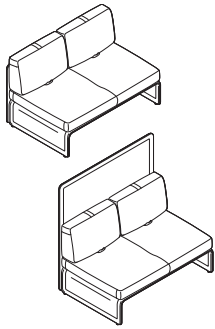

	Standard Includes	Required to Specify
<p>► Need help? Product details, see <i>Coalesse Seating and Outdoor Specification Guide</i>.</p>	<ul style="list-style-type: none"> • Screen: grade 1 knit • Seat deck: grade 1 knit to match screen • Non-contrasting seat cushion, articulating back cushion and pulls, back corner cushion, and end arm cushions: fabric or leather • Bracket: paint • Six adjustable glides • Ships assembled 	<ol style="list-style-type: none"> 1 Style number 2 Handedness (see below under Required Selections) 3 Knit color number for screen 4 Fabric or leather color number for non-contrasting seat cushion, articulating back cushion and pulls, back corner cushion, and end arm cushions, if selected 5 Paint color number for bracket: 4141 Platinum Matte 4710 Low Gloss Black 6 Options, if selected (see below) <p>► See <i>Coalesse Surface Materials Reference Guide</i>.</p>

	Required Sections	Price	Required to Specify
Handedness	• Left-hand, 2-seat lounges only (seated position)	No cost	Specify with <i>left-hand configuration</i> .
	• Right-hand, 2-seat lounges only (seated position)	No cost	Specify with <i>right-hand configuration</i> .

	Options	Price	Required to Specify
Surface Materials	Fabric screen		
	• 2-seat lounge with low-back screen	+\$157	Specify with <i>screen type fabric</i> .
	• 2-seat lounge with low-back screen and one side screen	+\$236	Specify with <i>screen type fabric</i> .
	• 2-seat lounge with low-back screen and two side screens	+\$314	Specify with <i>screen type fabric</i> .
	• 2-seat lounge with high-back screen	+\$184	Specify with <i>screen type fabric</i> .
	• 2-seat lounge with high-back screen and one side screen	+\$288	Specify with <i>screen type fabric</i> .
	• 2-seat lounge with high-back screen and two side screens	+\$393	Specify with <i>screen type fabric</i> .
	• Contrasting fabric for screen	+\$121	Specify with <i>contrasting fabric</i> and select fabric or leather color number.
	• Contrasting fabric for cushion	+\$121	Specify with <i>contrasting fabric</i> and select fabric or leather color number.
	• Contrasting fabric for top and bottom articulating back pulls	+\$121	Specify with <i>contrasting fabric</i> and select fabric or leather color number.
	• Fabric upcharges	Prices at right	Specify fabric color number.
	Knit screen		
	• Grade 1 knit screen	No cost	Specify with <i>screen type knit</i> and select knit color number.
• Grade 2 knit screen			
– 2-seat lounge with low-back screen	+\$237	Specify with <i>screen type knit</i> and select knit color number.	
– 2-seat lounge with low-back screen and one side screen	+\$368	Specify with <i>screen type knit</i> and select knit color number.	
– 2-seat lounge with low-back screen and two side screens	+\$500	Specify with <i>screen type knit</i> and select knit color number.	
– 2-seat lounge with high-back screen	+\$264	Specify with <i>screen type knit</i> and select knit color number.	
– 2-seat lounge with high-back screen and one side screen	+\$422	Specify with <i>screen type knit</i> and select knit color number.	
– 2-seat lounge with high-back screen and two side screens	+\$579	Specify with <i>screen type knit</i> and select knit color number.	

► Options, continued on next page

Tip: If contrasting screen is selected, it is required to specify whether seat deck finish will match inner screen or outer screen.

Tip: Contrasting fabric for articulating back pulls upcharge is applied one time per style number.

Tip: When contrasting fabric for articulating back pulls is selected, only one contrasting fabric can be specified and will apply to all pulls.

Lagunitas Lounge System 2-Seat Lounges

DESIGN TOAN NGUYEN

SIN 711.16

► Options, continued from previous page

	Options	Price	Required to Specify
Surface Materials, continued	Acrylic backer		
	• 2-seat lounge with low-back screen	+\$ 54	Specify with acrylic backer.
	• 2-seat lounge with low-back screen and one side screen	+\$ 83	Specify with acrylic backer.
	• 2-seat lounge with low-back screen and two side screens	+\$112	Specify with acrylic backer.
	• 2-seat lounge with high-back screen	+\$ 83	Specify with acrylic backer.
	• 2-seat lounge with low-back screen and one side screen	+\$126	Specify with acrylic backer.
	• 2-seat lounge with high-back screen and two side screens	+\$169	Specify with acrylic backer. ► See Coalesse Surface Materials Reference Guide.
	• COM	+\$154	Specify with COM and select fabric color number. ► See Coalesse Surface Materials Reference Guide.
	• COL	+\$281	Specify with COL and select leather color number. ► See Coalesse Surface Materials Reference Guide.
Power/USB Configuration	• One power module: two power in 4710 Low Gloss Black paint	+\$314	Specify with one power module, with two power.
	• One power module: one USB/one power in 4710 Low Gloss Black paint	+\$417	Specify with one power module, with one power/one USB.
	• Two power modules: two power each in 4710 Low Gloss Black paint	+\$628	Specify with two power modules, with two power.
	• Two power modules: one USB/one power each in 4710 Low Gloss Black paint	+\$834	Specify with two power modules, with one power/one USB.
Related Products	• Bench		► Page 150
	• Chaise		► Pages 142-146
	• Lagunitas tables		► See GSA Volume 5b Specification Guide.
	• Lounge booth connector screen and alignment connector		► Page 152

Tip: For Customer's Own Material or Leather, see necessary requirements, important processing instructions and ordering information.
► See Coalesse Surface Materials Reference Guide.

Tip: For any portion of the product that requires a COM, the additional upcharge is a one time charge per product.

Tip: For any portion of the product that requires a COL, the additional upcharge is a one time charge per product.

Tip: For each USB port specified, there is one USB per port.

► Specification Information, on next page

Lagunitas Lounge System 2-Seat Lounges *continued*

DESIGN TOAN NGUYEN

SIN 711.16

► Options, on previous page

Specification Information

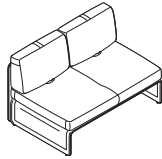

Two articulating backs
Overall: 51¼"W x 34"D x 32¾"H
Inside (Lounge): 51¼"W x 22½"D
Inside (Task): 51¼"W x 17¾"D
Seat: 16"H

Style Number Base Price

2-Seat Lounge with Low-Back Screen

COLAGLL21 \$2981

Fabric Upcharges

	Fabric Grades:									Leather Grades:	
	6	7	8	9	10	11	12	13	14	C	E
Articulating Back Pulls (if top and bottom contrasting pulls are selected)	+\$ 20	+\$ 24	+\$ 30	+\$ 50	+\$ 62	+\$ 77	+\$ 87	+\$ 105	+\$ 131	+\$ 189	+\$ 222
Seat Cushion	+\$ 101	+\$121	+\$155	+\$255	+\$321	+\$396	+\$449	+\$ 542	+\$ 671	+\$ 970	+\$1140
Back Cushion	+\$ 145	+\$172	+\$219	+\$364	+\$456	+\$563	+\$638	+\$ 771	+\$ 955	+\$1381	+\$1623
Inside Screen	+\$ 157	+\$186	+\$238	+\$393	+\$493	+\$609	+\$689	+\$ 833	+\$1033	N.A.	N.A.
Outside Screen	+\$ 201	+\$239	+\$302	+\$501	+\$629	+\$777	+\$880	+\$1063	+\$1318	N.A.	N.A.

Tip: Articulating back pull fabric upcharges only apply when contrasting pulls are selected.

Two Articulating Backs: Seat Deck: 3.4 yards, Inside Screen: 2 yards, Outside Screen: 2.2 yards, Seat Cushion: 2.6 yards, 57.2 sq ft, Back Cushion: 3.7 yards, 81.4 sq ft, Contrasting Pulls on Articulating Back Cushions: 0.5 yards, 2.2 sq ft

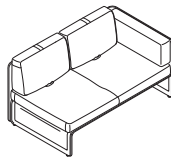

Two articulating backs
Overall: 59¾"W x 34"D x 32¾"H
Seat: 16"H

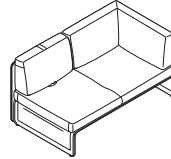

One articulating back and one corner cushion
Overall: 59¾"W x 34"D x 32¾"H
Seat: 16"H

Style Number Base Price

2-Seat Lounge with Low-Back Screen and One Side Screen

COLAGLL22 \$3556

Fabric Upcharges

	Fabric Grades:									Leather Grades:	
	6	7	8	9	10	11	12	13	14	C	E
Articulating Back Pulls (if top and bottom contrasting pulls are selected)	+\$ 20	+\$ 24	+\$ 30	+\$ 50	+\$ 62	+\$ 77	+\$ 87	+\$ 105	+\$ 131	+\$ 189	+\$ 222
Seat Cushion	+\$ 101	+\$121	+\$155	+\$255	+\$321	+\$396	+\$ 449	+\$ 542	+\$ 671	+\$ 970	+\$1140
Back Cushion	+\$ 183	+\$219	+\$279	+\$461	+\$579	+\$715	+\$ 811	+\$ 979	+\$1214	+\$1754	+\$2061
Inside Screen	+\$ 193	+\$230	+\$294	+\$485	+\$610	+\$754	+\$ 854	+\$1031	+\$1278	N.A.	N.A.
Outside Screen	+\$ 250	+\$297	+\$377	+\$624	+\$783	+\$967	+\$1095	+\$1323	+\$1640	N.A.	N.A.

Tip: Articulating back pull fabric upcharges only apply when contrasting pulls are selected.

Two Articulating Backs: Arm: 0, Seat Deck: 2.7 yards, Inside Screen: 3.5 yards, Outside Screen: 3.9 yards, Seat Cushion: 2.6 yards, 57.2 sq ft, Back Cushion: 4.7 yards, 103.4 sq ft, Contrasting Pulls on Articulating Back Cushions: 0.5 yards, 2.2 sq ft

One Articulating Back and One Corner Cushion: Arm: 0, Seat Deck: 2.7 yards, Inside Screen: 3.5 yards, Outside Screen: 3.9 yards, Seat Cushion: 2.6 yards, 57.2 sq ft, Back Cushion: 4.7 yards, 103.4 sq ft, Contrasting Pulls on Articulating Back Cushion: 0.5 yards, 1.1 sq ft

► Specification Information, continued on next page

Lagunitas Lounge System 2-Seat Lounges

DESIGN TOAN NGUYEN

SIN 711.16

► Specification Information, continued from previous page

Specification Information

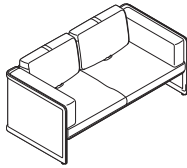

Two articulating backs
Overall: 67¾"W x 34"D x 32¾"H
Seat: 16"H

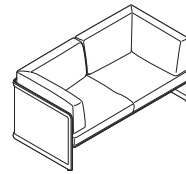

Two corner cushions
Overall: 67¾"W x 34"D x 32¾"H
Seat: 16"H

Style Number Base Price

2-Seat Lounge with Low-Back Screen and Two Side Screens

COLAGLL23 \$4131

Fabric Upcharges

	Fabric Grades:										Leather Grades:	
	6	7	8	9	10	11	12	13	14	C	E	
Articulating Back Pulls (if top and bottom contrasting pulls are selected)	+\$ 20	+\$ 24	+\$ 30	+\$ 50	+\$ 62	+\$ 77	+\$ 87	+\$ 105	+\$ 131	+\$ 189	+\$ 222	
Seat Cushion	+\$ 114	+\$135	+\$172	+\$285	+\$358	+\$ 442	+\$ 500	+\$ 604	+\$ 749	+\$1082	+\$1271	
Back Cushion	+\$ 270	+\$322	+\$410	+\$678	+\$850	+\$1051	+\$1190	+\$1437	+\$1781	+\$2575	+\$3026	
Inside Screen	+\$ 241	+\$287	+\$365	+\$604	+\$758	+\$ 936	+\$1060	+\$1281	+\$1588	N.A.	N.A.	
Outside Screen	+\$ 311	+\$371	+\$472	+\$781	+\$980	+\$1210	+\$1372	+\$1657	+\$2053	N.A.	N.A.	

Tip: Articulating back pull fabric upcharges only apply when contrasting pulls are selected.

Two Articulating Backs: Arm: 0, Seat Deck: 1.6 yards, Inside Screen: 4.9 yards, Outside Screen: 5.6 yards, Seat Cushion: 2.9 yards, 63.8 sq ft, Back Cushion: 6.9 yards, 151.8 sq ft, Contrasting Pulls on Articulating Back Cushions: 0.5 yards, 2.2 sq ft

Two Corner Cushions: Arm: 0, Seat Deck: 1.6 yards, Inside Screen: 4.9 yards, Outside Screen: 5.6 yards, Seat Cushion: 2.9 yards, 63.8 sq ft, Back Cushion: 6.9 yards, 151.8 sq ft

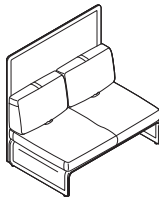

Two articulating backs
Overall: 51¼"W x 34"D x 50"H
Inside (Lounge): 51¼"W x 22½"D
Inside (Task): 51¼"W x 17¾"D
Seat: 16"H

Style Number Base Price

2-Seat Lounge with High-Back Screen

COLAGLH21 \$3608

Fabric Upcharges

	Fabric Grades:										Leather Grades:	
	6	7	8	9	10	11	12	13	14	C	E	
Articulating Back Pulls (if top and bottom contrasting pulls are selected)	+\$ 20	+\$ 24	+\$ 30	+\$ 50	+\$ 62	+\$ 77	+\$ 87	+\$ 105	+\$ 131	+\$ 189	+\$ 222	
Seat Cushion	+\$ 101	+\$121	+\$155	+\$255	+\$321	+\$396	+\$449	+\$ 542	+\$ 671	+\$ 970	+\$1140	
Back Cushion	+\$ 145	+\$172	+\$219	+\$364	+\$456	+\$563	+\$638	+\$ 771	+\$ 955	+\$1381	+\$1623	
Inside Screen	+\$ 157	+\$186	+\$238	+\$393	+\$493	+\$609	+\$689	+\$ 833	+\$1033	N.A.	N.A.	
Outside Screen	+\$ 201	+\$239	+\$302	+\$501	+\$629	+\$777	+\$880	+\$1063	+\$1318	N.A.	N.A.	

Tip: Articulating back pull fabric upcharges only apply when contrasting pulls are selected.

Two Articulating Backs: Seat Deck: 3.4 yards, Inside Screen: 2 yards, Outside Screen: 2.2 yards, Seat Cushion: 2.6 yards, 57.2 sq ft, Back Cushion: 3.7 yards, 81.4 sq ft, Contrasting Pulls on Articulating Back Cushions: 0.5 yards, 2.2 sq ft

► Specification Information, continued on next page

Lounge Seating

Lagunitas Lounge System 2-Seat Lounges *continued*

DESIGN TOAN NGUYEN

SIN 711.16

► Specification Information, continued from previous page

Specification Information

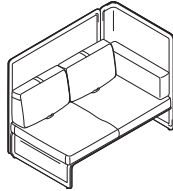

Two articulating backs
Overall: 59³/₈"W x 34"D x 50"H
Seat: 16"H

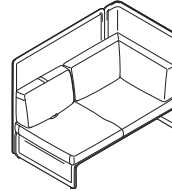

One articulating back and one corner cushion
Overall: 59³/₈"W x 34"D x 50"H
Seat: 16"H

Style Number Base Price

2-Seat Lounge with High-Back Screen and One Side Screen

COLAGLH22 \$4549

Fabric Upcharges

	Fabric Grades:										Leather Grades:	
	6	7	8	9	10	11	12	13	14	C	E	
Articulating Back Pulls (if top and bottom contrasting pulls are selected)	+\$ 20	+\$ 24	+\$ 30	+\$ 50	+\$ 62	+\$ 77	+\$ 87	+\$ 105	+\$ 131	+\$ 189	+\$ 222	
Seat Cushion	+\$ 101	+\$121	+\$155	+\$255	+\$321	+\$396	+\$ 449	+\$ 542	+\$ 671	+\$ 970	+\$1140	
Back Cushion	+\$ 183	+\$219	+\$279	+\$461	+\$579	+\$715	+\$ 811	+\$ 979	+\$1214	+\$1754	+\$2061	
Inside Screen	+\$ 193	+\$230	+\$294	+\$485	+\$610	+\$754	+\$ 854	+\$1031	+\$1278	N.A.	N.A.	
Outside Screen	+\$250	+\$297	+\$377	+\$624	+\$783	+\$967	+\$1095	+\$1323	+\$1640	N.A.	N.A.	

Tip: Articulating back pull fabric upcharges only apply when contrasting pulls are selected.

Three Articulating Backs: Arm: 0, Seat Deck: 2.7 yards, Inside Screen: 3.5 yards, Outside Screen: 3.9 yards, Seat Cushion: 2.6 yards, 57.2 sq ft, Back Cushion: 4.7 yards, 103.4 sq ft, Contrasting Pulls on Articulating Back Cushions: 0.5 yards, 2.2 sq ft
One Articulating Back and One Corner Cushion: Arm: 0, Seat Deck: 2.7 yards, Inside Screen: 3.5 yards, Outside Screen: 3.9 yards, Seat Cushion: 2.6 yards, 57.2 sq ft, Back Cushion: 4.7 yards, 103.4 sq ft, Contrasting Pulls on Articulating Back Cushion: 0.5 yards, 1.1 sq ft

► Specification Information, continued on next page

Lagunitas Lounge System 2-Seat Lounges

DESIGN TOAN NGUYEN

SIN 711.16

► Specification Information, continued from previous page

Specification Information

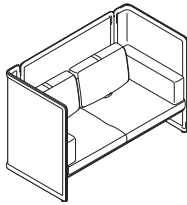

Two articulating backs
Overall: 67³/₄"W x 34"D x 50"H
Seat: 16"H

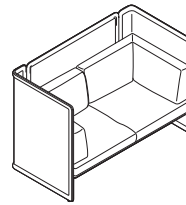

Two corner cushions
Overall: 67³/₄"W x 34"D x 50"H
Seat: 16"H

Style Number Base Price

2-Seat Lounge with High-Back Screen and Two Side Screens

COLAGLH23 \$5490

Fabric Upcharges

	Fabric Grades:									Leather Grades:	
	6	7	8	9	10	11	12	13	14	C	E
Articulating Back Pulls (if top and bottom contrasting pulls are selected)	+\$ 20	+\$ 24	+\$ 30	+\$ 50	+\$ 62	+\$ 77	+\$ 87	+\$ 105	+\$ 131	+\$ 189	+\$ 222
Seat Cushion	+\$ 114	+\$135	+\$172	+\$285	+\$358	+\$442	+\$ 500	+\$ 604	+\$ 749	+\$1082	+\$1271
Back Cushion	+\$ 270	+\$322	+\$410	+\$678	+\$850	+\$1051	+\$1190	+\$1437	+\$1781	+\$2575	+\$3026
Inside Screen	+\$ 241	+\$287	+\$365	+\$604	+\$758	+\$936	+\$1060	+\$1281	+\$1588	N.A.	N.A.
Outside Screen	+\$ 311	+\$371	+\$472	+\$781	+\$980	+\$1210	+\$1372	+\$1657	+\$2053	N.A.	N.A.

Tip: Articulating back pull fabric upcharges only apply when contrasting pulls are selected.

Two Articulating Backs: Arm: 0, Seat Deck: 1.6 yards, Inside Screen: 4.9 yards, Outside Screen: 5.6 yards, Seat Cushion: 2.9 yards, 63.8 sq ft, Back Cushion: 6.9 yards, 151.8 sq ft, Contrasting Pulls on Articulating Back Cushions: 0.5 yards, 2.2 sq ft

Two Corner Cushions: Arm: 0, Seat Deck: 1.6 yards, Inside Screen: 4.9 yards, Outside Screen: 5.6 yards, Seat Cushion: 2.9 yards, 63.8 sq ft, Back Cushion: 6.9 yards, 151.8 sq ft

Lagunitas Lounge System 3-Seat Lounges

DESIGN TOAN NGUYEN

SIN 711.16

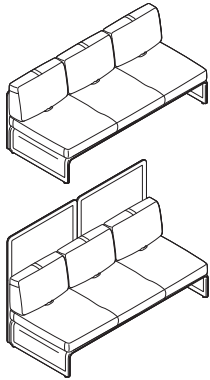

Standard Includes		Required to Specify
<ul style="list-style-type: none"> ▶ Need help? Product details, see <i>Coalesse Seating and Outdoor Specification Guide</i>. 	<ul style="list-style-type: none"> • Screen: grade 1 knit • Seat deck: grade 1 knit to match screen • Non-contrasting seat cushion, articulating back cushion and pulls, back corner cushion, and end arm cushions: fabric or leather • Bracket: paint • Eight adjustable glides • Ships assembled 	<ol style="list-style-type: none"> 1 Style number 2 Handedness (see below under Required Selections) 3 Knit color number for screen 4 Fabric or leather color number for non-contrasting seat cushion, articulating back cushion and pulls, back corner cushion, and end arm cushions, if selected 5 Paint color number for bracket: <ul style="list-style-type: none"> 4141 Platinum Matte 4710 Low Gloss Black 6 Options, if selected (see below) <p>▶ See <i>Coalesse Surface Materials Reference Guide</i>.</p>

	Required Sections	Price	Required to Specify
Handedness	• Left-hand, 3-seat lounges only (seated position)	No cost	Specify <i>left-hand configuration</i> .
	• Right-hand, 3-seat lounges only (seated position)	No cost	Specify <i>right-hand configuration</i> .

	Options	Price	Required to Specify
Surface Materials	Fabric screen		
	• 3-seat lounge with low-back screen	+\$236	Specify with screen type fabric.
	• 3-seat lounge with low-back screen and one side screen	+\$314	Specify with screen type fabric.
	• 3-seat lounge with low-back screen and two side screens	+\$393	Specify with screen type fabric.
	• 3-seat lounge with high-back screen	+\$236	Specify with screen type fabric.
	• 3-seat lounge with high-back screen and one side screen	+\$341	Specify with screen type fabric.
	• 3-seat lounge with high-back screen and two side screens	+\$445	Specify with screen type fabric.
	• Contrasting fabric for screen	+\$121	Specify <i>with contrasting fabric</i> and select fabric or leather color number.
	• Contrasting fabric for cushion	+\$121	Specify <i>with contrasting fabric</i> and select fabric or leather color number.
	• Contrasting fabric for top and bottom articulating back pulls	+\$121	Specify <i>with contrasting fabric</i> and select fabric or leather color number.
	• Fabric upcharges	Prices at right	Specify fabric color number.
	Knit screen		
	• Grade 1 knit screen	No cost	Specify <i>with screen type knit</i> and select knit color number.
	• Grade 2 knit screen		
	– 3-seat lounge with low-back screen	+\$289	Specify <i>with screen type knit</i> and select knit color number.
	– 3-seat lounge with low-back screen and one side screen	+\$447	Specify <i>with screen type knit</i> and select knit color number.
	– 3-seat lounge with low-back screen and two side screens	+\$604	Specify <i>with screen type knit</i> and select knit color number.
	– 3-seat lounge with high-back screen	+\$314	Specify <i>with screen type knit</i> and select knit color number.
	– 3-seat lounge with high-back screen and one side screen	+\$499	Specify <i>with screen type knit</i> and select knit color number.
	– 3-seat lounge with high-back screen and two side screens	+\$682	Specify <i>with screen type knit</i> and select knit color number.

Tip: If contrasting screen is selected, it is required to specify whether seat deck finish will match inner screen or outer screen.

Tip: Contrasting fabric for articulating back pulls upcharge is applied one time per style number.

Tip: When contrasting fabric for articulating back pulls is selected, only one contrasting fabric can be specified and will apply to all pulls.

▶ Options, continued on next page

Lagunitas Lounge System 3-Seat Lounges

DESIGN TOAN NGUYEN

SIN 711.16

► Options, continued from previous page

	Options	Price	Required to Specify
Surface Materials, continued	Acrylic backer		
	• 3-seat lounge with low-back screen	+\$ 73	Specify with acrylic backer.
	• 3-seat lounge with low-back screen and one side screen	+\$110	Specify with acrylic backer.
	• 3-seat lounge with low-back screen and two side screens	+\$ 148	Specify with acrylic backer.
	• 3-seat lounge with high-back screen	+\$126	Specify with acrylic backer.
	• 3-seat lounge with high-back screen and one side screen	+\$163	Specify with acrylic backer.
	• 3-seat lounge with high-back screen and two side screens	+\$201	Specify with acrylic backer. ► See Coalesse Surface Materials Reference Guide.
	• COM	+\$154	Specify with COM and select fabric color number. ► See Coalesse Surface Materials Reference Guide.
	• COL	+\$281	Specify with COL and select leather color number. ► See Coalesse Surface Materials Reference Guide
	Power/USB Configuration	• One power module: two power in 4710 Low Gloss Black paint	+\$314
• One power module: one USB/one power in 4710 Low Gloss Black paint		+\$417	Specify with one power module, with one power/one USB.
• Two power modules: two power each in 4710 Low Gloss Black paint		+\$628	Specify with two power modules, with two power.
• Two power modules: one USB/one power each in 4710 Low Gloss Black paint		+\$834	Specify with two power modules, with one power/one USB.
Related Products	• Bench		► Page 150
	• Chaise		► Pages 142–146
	• Lagunitas tables		► See GSA Volume 5b Specification Guide.
	• Lounge booth connector screen and alignment connector		► Page 152

► Specification Information, on next page

Tip: For Customer's Own Material or Leather, see necessary requirements, important processing instructions and ordering information.
► See Coalesse Surface Materials Reference Guide.

Tip: For any portion of the product that requires a COM, the additional upcharge is a one time charge per product.

Tip: For any portion of the product that requires a COL, the additional upcharge is a one time charge per product.

Tip: For each USB port specified, there is one USB per port.

Lagunitas Lounge System 3-Seat Lounges *continued*

DESIGN TOAN NGUYEN

SIN 711.16

► Options, on previous page

Specification Information

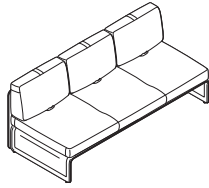

Three articulating backs
Overall: 76¾"W x 34"D x 32¾"H
Inside (Lounge): 76¾"W x 22½"D
Inside (Task): 76¾"W x 17¾"D
Seat: 16"H

Style Number Base Price

3-Seat Lounge with Low-Back Screen

COLAGLL31 \$4079

Fabric Upcharges

	Fabric Grades:										Leather Grades:	
	6	7	8	9	10	11	12	13	14	C	E	
Articulating Back Pulls (if top and bottom contrasting pulls are selected)	+\$ 20	+\$ 24	+\$ 30	+\$ 50	+\$ 62	+\$ 77	+\$ 87	+\$ 105	+\$ 131	+\$ 189	+\$ 222	
Seat Cushion	+\$ 140	+\$168	+\$213	+\$353	+\$444	+\$ 548	+\$ 621	+\$ 750	+\$ 930	+\$1344	+\$1580	
Back Cushion	+\$ 215	+\$256	+\$327	+\$540	+\$678	+\$ 837	+\$ 949	+\$1146	+\$1421	+\$2052	+\$2412	
Inside Screen	+\$ 205	+\$246	+\$313	+\$515	+\$646	+\$ 800	+\$ 904	+\$1094	+\$1356	N.A.	N.A.	
Outside Screen	+\$ 260	+\$310	+\$396	+\$654	+\$819	+\$1013	+\$1147	+\$1385	+\$1718	N.A.	N.A.	

Tip: Articulating back pull fabric upcharges only apply when contrasting pulls are selected.

Three Articulating Backs: Seat Deck: 3.6 yards, Inside Screen: 3.2 yards, Outside Screen: 3.7 yards, Seat Cushion: 3.6 yards, 79.2 sq ft, Back Cushion: 5.5 yards, 121 sq ft, Contrasting Pulls on Articulating Back Cushions: 0.5 yards, 3.3 sq ft

► Specification Information, continued on next page

Lagunitas Lounge System 3-Seat Lounges

DESIGN TOAN NGUYEN

SIN 711.16

► Specification Information, continued from previous page

Specification Information

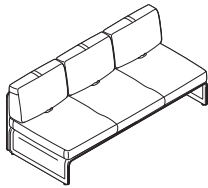

Three articulating backs
Overall: 85"W x 34"D x 32³/₈"H
Seat: 16"H

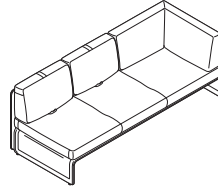

Two articulating backs and one corner cushion
Overall: 85"W x 34"D x 32³/₈"H
Seat: 16"H

Style Number Base Price

3-Seat Lounge with Low-Back Screen and One Side Screen

COLAGLL32 \$4654

Fabric Upcharges

	Fabric Grades:										Leather Grades:	
	6	7	8	9	10	11	12	13	14	C	E	
Articulating Back Pulls (if top and bottom contrasting pulls are selected)	+\$ 20	+\$ 24	+\$ 30	+\$ 50	+\$ 62	+\$ 77	+\$ 87	+\$ 105	+\$ 131	+\$ 189	+\$ 222	
Seat Cushion	+\$133	+\$159	+\$202	+\$334	+\$ 419	+\$ 518	+\$586	+\$ 708	+\$ 878	+\$1269	+\$1490	
Back Cushion	+\$133	+\$159	+\$202	+\$334	+\$ 419	+\$ 518	+\$586	+\$ 708	+\$ 878	+\$1269	+\$1490	
Inside Screen	+\$254	+\$303	+\$385	+\$638	+\$ 801	+\$ 990	+\$1121	+\$1354	+\$1679	N.A.	N.A.	
Outside Screen	+\$320	+\$382	+\$486	+\$805	+\$1011	+\$1249	+\$1415	+\$1709	+\$2117	N.A.	N.A.	

Tip: Articulating back pull fabric upcharges only apply when contrasting pulls are selected.

Three Articulating Backs: Arm: 0, Seat Deck: 2.3 yards, Inside Screen: 4.6 yards, Outside Screen: 5.4 yards, Seat Cushion: 3.4 yards, 74.8 sq ft, Back Cushion: 6.5 yards, 143 sq ft, Contrasting Pulls on Articulating Back Cushions: 0.5 yards, 3.3 sq ft

Two Articulating Backs and One Corner Cushion: Arm: 0, Seat Deck: 2.3 yards, Inside Screen: 4.6 yards, Outside Screen: 5.4 yards, Seat Cushion: 3.4 yards, 74.8 sq ft, Back Cushion: 6.5 yards, 143 sq ft, Contrasting Pulls on Articulating Back Cushions: 0.5 yards, 2.2 sq ft

► Specification Information, continued on next page

Lagunitas Lounge System 3-Seat Lounges *continued*

DESIGN TOAN NGUYEN

SIN 711.16

► Specification Information, continued from previous page

Specification Information

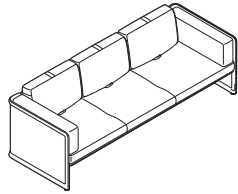

Three articulating backs
Overall: 93¼"W x 34"D x 32¾"H
Seat: 16"H

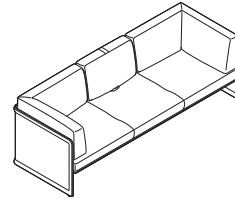

One articulating back and two corner cushions
Overall: 93¼"W x 34"D x 32¾"H
Seat: 16"H

Style Number Base Price

3-Seat Lounge with Low-Back Screen and Two Side Screens

COLAGLL33 \$5229

Fabric Upcharges

	Fabric Grades:										Leather Grades:	
	6	7	8	9	10	11	12	13	14	C	E	
Articulating Back Pulls (if top and bottom contrasting pulls are selected)	+\$ 20	+\$ 24	+\$ 30	+\$ 50	+\$ 62	+\$ 77	+\$ 87	+\$ 105	+\$ 131	+\$ 189	+\$ 222	
Seat Cushion	+\$ 140	+\$168	+\$213	+\$353	+\$ 444	+\$548	+\$ 621	+\$ 750	+\$ 930	+\$1344	+\$1580	
Back Cushion	+\$ 340	+\$406	+\$516	+\$854	+\$1072	+\$1325	+\$1501	+\$1812	+\$2247	+\$3246	+\$3815	
Inside Screen	+\$ 292	+\$348	+\$443	+\$731	+\$ 917	+\$1134	+\$1284	+\$1552	+\$1923	N.A.	N.A.	
Outside Screen	+\$ 376	+\$445	+\$568	+\$937	+\$1178	+\$1454	+\$1648	+\$1990	+\$2467	N.A.	N.A.	

Tip: Articulating back pull fabric upcharges only apply when contrasting pulls are selected.

Three Articulating Backs: Arm: 0, Seat Deck: 2 yards, Inside Screen: 6.1 yards, Outside Screen: 7.1 yards, Seat Cushion: 3.6 yards, 79.2 sq ft, Back Cushion: 8.7 yards, 191.4 sq ft, Contrasting Pulls on Articulating Back Cushions: 0.5 yards, 3.3 sq ft

One Articulating Back and Two Corner Cushions: Arm: 0, Seat Deck: 2 yards, Inside Screen: 6.1 yards, Outside Screen: 7.1 yards, Seat Cushion: 3.6 yards, 79.2 sq ft, Back Cushion: 8.7 yards, 191.4 sq ft, Contrasting Pulls on Articulating Back Cushion: 0.5 yards, 1.1 sq ft

► Specification Information, continued on next page

Lagunitas Lounge System 3-Seat Lounges

DESIGN TOAN NGUYEN

SIN 711.16

► Specification Information, continued from previous page

Specification Information

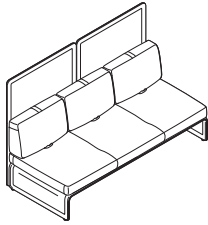

Three articulating backs
Overall: 76⁷/₈"W x 34"D x 50"H
Inside (Lounge): 76⁷/₈"W x 22¹/₂"D
Inside (Task): 76⁷/₈"W x 17³/₄"D
Seat: 16"H

Style Number Base Price

3-Seat Lounge with High-Back Screen

COLAGLH31 \$4916

Fabric Upcharges

	Fabric Grades:										Leather Grades:	
	6	7	8	9	10	11	12	13	14	C	E	
Articulating Back Pulls (if top and bottom contrasting pulls are selected)	+\$ 20	+\$ 24	+\$ 30	+\$ 50	+\$ 62	+\$ 77	+\$ 87	+\$ 105	+\$ 131	+\$ 89	+\$ 222	
Seat Cushion	+\$ 140	+\$168	+\$213	+\$353	+\$444	+\$ 548	+\$ 621	+\$ 750	+\$ 930	+\$1344	+\$1580	
Back Cushion	+\$ 215	+\$256	+\$327	+\$540	+\$678	+\$ 837	+\$ 949	+\$1146	+\$1421	+\$2052	+\$2412	
Inside Screen	+\$ 205	+\$246	+\$313	+\$515	+\$646	+\$ 800	+\$ 904	+\$1094	+\$1356	N.A.	N.A.	
Outside Screen	+\$ 260	+\$310	+\$396	+\$654	+\$819	+\$1013	+\$1147	+\$1385	+\$1718	N.A.	N.A.	

Tip: Articulating back pull fabric upcharges only apply when contrasting pulls are selected.

Three Articulating Backs: Seat Deck: 3.6 yards, Inside Screen: 3.2 yards, Outside Screen: 3.7 yards, Seat Cushion: 3.6 yards, 79.2 sq ft, Back Cushion: 5.5 yards, 121 sq ft, Contrasting Pulls on Articulating Back Cushions: 0.5 yards, 3.3 sq ft

► Specification Information, continued on next page

Lagunitas Lounge System 3-Seat Lounges *continued*

DESIGN TOAN NGUYEN

SIN 711.16

► Specification Information, continued from previous page

Specification Information

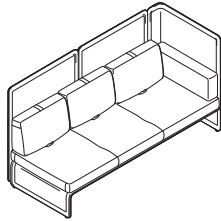

Three articulating backs
Overall: 85"W x 34½"D x 50"H
Seat: 16"H

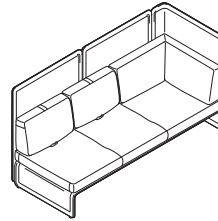

Two articulating backs with one corner cushion
Overall: 85"W x 34½"D x 50"H
Seat: 16"H

Style Number Base Price

3-Seat Lounge with High-Back Screen and One Side Screen

COLAGLH32 \$5856

Fabric Upcharges

	Fabric Grades:										Leather Grades:	
	6	7	8	9	10	11	12	13	14	C	E	
Articulating Back Pulls (if top and bottom contrasting pulls are selected)	+\$ 20	+\$ 24	+\$ 30	+\$ 50	+\$ 62	+\$ 77	+\$ 87	+\$ 105	+\$ 131	+\$ 189	+\$ 222	
Seat Cushion	+\$ 133	+\$159	+\$202	+\$334	+\$ 419	+\$ 518	+\$ 586	+\$ 708	+\$ 878	+\$1269	+\$1490	
Back Cushion	+\$ 254	+\$303	+\$385	+\$638	+\$ 801	+\$ 990	+\$1121	+\$1354	+\$1679	+\$2425	+\$2851	
Inside Screen	+\$ 249	+\$298	+\$380	+\$628	+\$ 788	+\$ 975	+\$1103	+\$1333	+\$1653	N.A.	N.A.	
Outside Screen	+\$ 320	+\$382	+\$486	+\$805	+\$1011	+\$1249	+\$1415	+\$1709	+\$2117	N.A.	N.A.	

Tip: Articulating back pull fabric upcharges only apply when contrasting pulls are selected.

Three Articulating Backs: Arm: 0, Seat Deck: 2.3 yards, Inside Screen: 4.6 yards, Outside Screen: 5.4 yards, Seat Cushion: 3.4 yards, 74.8 sq ft, Back Cushion: 6.5 yards, 143 sq ft, Contrasting Pulls on Articulating Back Cushions: 0.5 yards, 3.3 sq ft
Two Articulating Backs with One Corner Cushion: Arm: 0, Seat Deck: 2.3 yards, Inside Screen: 4.6 yards, Outside Screen: 5.4 yards, Seat Cushion: 3.4 yards, 74.8 sq ft, Back Cushion: 6.5 yards, 143 sq ft, Contrasting Pulls on Articulating Back Cushions: 0.5 yards, 2.2 sq ft

► Specification Information, continued on next page

Lagunitas Lounge System 3-Seat Lounges

DESIGN TOAN NGUYEN

SIN 711.16

► Specification Information, continued from previous page

Specification Information

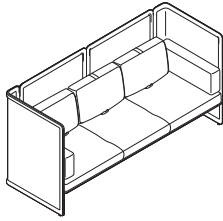

Three articulating backs
Overall: 93³/₈"W x 34"D x 50"H
Seat: 16"H

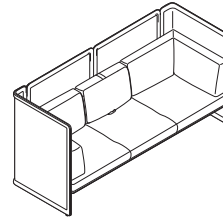

One articulating back and two corner cushions
Overall: 93³/₈"W x 34"D x 32³/₈"H
Seat: 16"H

Style Number Base Price

3-Seat Lounge with High-Back Screen and Two Side Screens

COLAGLH33 \$6797

Fabric Upcharges

	Fabric Grades:										Leather Grades:	
	6	7	8	9	10	11	12	13	14	C	E	
Articulating Back Pulls (if top and bottom contrasting pulls are selected)	+\$ 20	+\$ 24	+\$ 30	+\$ 50	+\$ 62	+\$ 77	+\$ 87	+\$ 105	+\$ 131	+\$ 189	+\$ 222	
Seat Cushion	+\$ 140	+\$168	+\$213	+\$353	+\$ 444	+\$ 548	+\$ 621	+\$ 750	+\$ 930	+\$1344	+\$1580	
Back Cushion	+\$ 340	+\$406	+\$516	+\$854	+\$1072	+\$1325	+\$1501	+\$1812	+\$2247	+\$3246	+\$3815	
Inside Screen	+\$ 292	+\$348	+\$443	+\$731	+\$ 917	+\$1134	+\$1284	+\$1552	+\$1923	N.A.	N.A.	
Outside Screen	+\$ 376	+\$445	+\$568	+\$937	+\$1178	+\$1454	+\$1648	+\$1990	+\$2467	N.A.	N.A.	

Tip: Articulating back pull fabric upcharges only apply when contrasting pulls are selected.

Three Articulating Backs: Arm: 0, Seat Deck: 2 yards, Inside Screen: 6.1 yards, Outside Screen: 7.1 yards, Seat Cushion: 3.6 yards, 79.2 sq ft, Back Cushion: 8.7 yards, 191.4 sq ft, Contrasting Pulls on Articulating Back Cushions: 0.5 yards, 3.3 sq ft

One Articulating Back and Two Corner Cushions: Arm: 0, Seat Deck: 2 yards, Inside Screen: 6.1 yards, Outside Screen: 7.1 yards, Seat Cushion: 3.6 yards, 79.2 sq ft, Back Cushion: 8.7 yards, 191.4 sq ft, Contrasting Pulls on Articulating Back Cushion: 0.5 yards, 1.1 sq ft

Lounge Seating

Lagunitas Lounge System 2-Seat Chaises

DESIGN TOAN NGUYEN

SIN 711.16

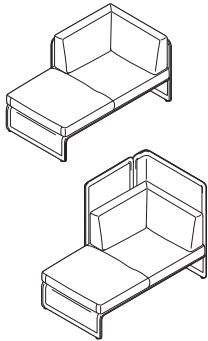

► Need help?
Product details, see *Coalesse Seating and Outdoor Specification Guide*

Standard Includes

- Screen: grade 1 knit
- Seat deck: grade 1 knit to match screen
- Non-contrasting seat cushion, articulating back cushion and pulls, back corner cushion, and end arm cushion, if selected: fabric or leather
- Bracket: paint
- Six adjustable glides
- Ships assembled

Required to Specify

- 1 Style number
 - 2 Handedness (see below under Required Selections)
 - 3 Knit color number for screen
 - 4 Fabric or leather color number for non-contrasting seat cushion, articulating back cushion and pull, back corner cushion, and end arm cushion, if selected
 - 5 Paint color number for bracket:
4141 Platinum Matte
4710 Low Gloss Black
 - 6 Options, if selected (see below)
- See *Surface Materials*, page 260

	Required Selections	Price	Required to Specify
Handedness	• Left-hand, 2-seat chaises only (seated position)	No cost	Specify with <i>left-hand configuration</i> .
	• Right-hand, 2-seat chaises only (seated position)	No cost	Specify with <i>right-hand configuration</i> .

	Options	Price	Required to Specify
Surface Materials	Fabric screen		
	• 2-seat chaise with one low-back screen and one right- or one left-hand screen	+\$236	Specify with <i>screen type fabric</i> .
	• 2-seat chaise with one high-back screen and one right- or one left-hand screen	+\$288	Specify with <i>screen type fabric</i> .
	• Contrasting fabric for screen	+\$121	Specify with <i>contrasting fabric</i> and select fabric or leather color number.
	• Contrasting fabric for cushion	+\$121	Specify with <i>contrasting fabric</i> and select fabric or leather color number.
	• Contrasting fabric for articulating back pulls	+\$121	Specify with <i>contrasting fabric</i> and select fabric or leather color number. ► See <i>Surface Materials</i> , page 260
	• Fabric upcharges	Prices at right	Specify fabric color number.
	Knit screen		
	• Grade 1 knit screen	No cost	Specify with <i>screen type knit</i> and select knit color number.
	• Grade 2 knit screen		
– 2-seat chaise with one low-back screen and one right- or one left-hand screen	+\$368	Specify with <i>screen type knit</i> and select knit color number.	
– 2-seat chaise with one high-back screen and one right- or one left-hand screen	+\$422	Specify with <i>screen type knit</i> and select knit color number.	
Acrylic backer			
• 2-seat chaise with one low-back screen and one right- or one left-hand screen	+\$ 70	Specify with acrylic backer.	
• 2-seat chaise with one high-back screen and one right- or one left-hand screen	+\$104	Specify with acrylic backer. ► See <i>Surface Materials</i> , page 260	
• COM	+\$154	Specify with COM and select fabric color number. ► See <i>Surface Materials</i> , page 262	
• COL	+\$281	Specify with COL and select leather color number. ► See <i>Surface Materials</i> , page 262	

► Options, continued on next page

Tip: If contrasting screen is selected, it is required to specify whether seat deck finish will match inner screen or outer screen.

Tip: Contrasting fabric for articulating back pull upcharge is applied one time per style number.

Tip: For Customer's Own Material or Leather, see necessary requirements, important processing instructions and ordering information.
► See *Coalesse Surface Materials Reference Guide*.

Tip: For any portion of the product that requires a COM, the additional upcharge is a one time charge per product.

Tip: For any portion of the product that requires a COL, the additional upcharge is a one time charge per product.

Tip: Must combine seat deck and list screen pricing choice (knit grade 1, knit grade 2, or fabric) from either non-contrasting or contrasting pricing list with seat and back cushion list pricing (fabric and leather) from either non-contrasting or contrasting pricing list to obtain completed list price.

Lagunitas Lounge System 2-Seat Chaises

DESIGN TOAN NGUYEN

SIN 711.16

Tip: For each USB port specified, there is one USB per port.

► Options, continued from previous page

Options	Price	Required to Specify
Power/USB Configuration		
• One power module: two power in 4710 Black paint	+\$314	Specify with one power module, with two power.
• One power module: one USB/one power in 4710 Black paint	+\$417	Specify with one power module, with one power/one USB.
• Two power modules: two power each in 4710 Black paint	+\$628	Specify with two power modules, with two power.
• Two power modules: one USB/one power each in 4710 Black paint	+\$834	Specify with two power modules, with one power/one USB.

Related Products	<ul style="list-style-type: none"> Lagunitas tables Lounge Bench 	<ul style="list-style-type: none"> ► See GSA Volume 5b Specification Guide. ► Pages 124-134 ► Page 150
-------------------------	---	---

Specification Information

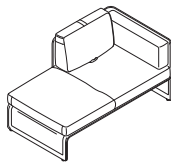

One articulating back
Overall: 59³/₈"W x 34"D x 32³/₈"H
Seat: 16"H

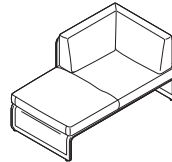

One corner cushion
Overall: 59³/₈"W x 34"D x 32³/₈"H
Seat: 16"H

Style Number	Base Price
--------------	------------

2-Seat Chaise with Low-Back Screen and One Side Screen

COLAGCL2 \$2981

Fabric Upcharges

	Fabric Grades:										Leather Grades:	
	6	7	8	9	10	11	12	13	14	C	E	
Articulating Back Pulls (if contrasting pull selected)	+\$ 20	+\$ 24	+\$ 30	+\$ 50	+\$ 62	+\$ 77	+\$ 87	+\$ 105	+\$ 131	+\$ 189	+\$ 222	
Seat Cushion	+\$ 117	+\$139	+\$176	+\$293	+\$368	+\$455	+\$515	+\$ 622	+\$ 771	+\$1113	+\$1309	
Back Cushion	+\$ 114	+\$135	+\$172	+\$285	+\$358	+\$442	+\$500	+\$ 604	+\$ 749	+\$1082	+\$1271	
Inside Screen	+\$ 164	+\$193	+\$247	+\$406	+\$512	+\$632	+\$715	+\$ 864	+\$1072	N.A.	N.A.	
Outside Screen	+\$ 218	+\$260	+\$330	+\$546	+\$684	+\$845	+\$957	+\$1156	+\$1434	N.A.	N.A.	

One Articulating Back: Arm: 0, Seat Deck: 2.7 yards, Inside Screen: 2.7 yards, Outside Screen: 3.2 yards, Seat Cushion: 3 yards, 66 sq ft, Back Cushion: 2.9 yards, 63.8 sq ft

One Corner Cushion: Arm: 0, Seat Deck: 2.7 yards, Inside Screen: 2.7 yards, Outside Screen: 3.2 yards, Seat Cushion: 3 yards, 66 sq ft, Back Cushion: 2.9 yards, 63.8 sq ft

► Specification Information, continued on next page

Tip: Handedness is determined while in the seated position. Illustration above shows left-hand chaise.

Tip: Articulating back pull fabric upcharges only apply when contrasting pull is selected.

Lagunitas Lounge System 2-Seat Chaises *continued*

DESIGN TOAN NGUYEN

SIN 711.16

► Specification Information, continued from previous page

Specification Information

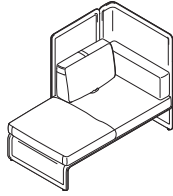

One articulating back
Overall: 59³/₈"W x 34"D x 50"H
Seat: 16"H

Tip: Handedness is determined while in the seated position. Illustration above shows left-hand chaise.

Style Number	Base Price
--------------	------------

2-Seat Chaise with High-Back Screen and One Side Screen

COLAGCH2 \$3660

Fabric Upcharges

	Fabric Grades:										Leather Grades:	
	6	7	8	9	10	11	12	13	14	C	E	
Articulating Back Pulls (if contrasting pull selected)	+\$ 20	+\$ 24	+\$ 30	+\$ 50	+\$ 62	+\$ 77	+\$ 87	+\$ 105	+\$ 131	+\$ 189	+\$ 222	
Seat Cushion	+\$ 117	+\$139	+\$176	+\$293	+\$368	+\$455	+\$515	+\$ 622	+\$ 771	+\$1113	+\$1309	
Back Cushion	+\$ 114	+\$135	+\$172	+\$285	+\$358	+\$442	+\$500	+\$ 604	+\$ 749	+\$1082	+\$1271	
Inside Screen	+\$ 164	+\$193	+\$247	+\$406	+\$512	+\$632	+\$715	+\$ 864	+\$1072	N.A.	N.A.	
Outside Screen	+\$ 218	+\$260	+\$330	+\$546	+\$684	+\$845	+\$957	+\$1156	+\$1434	N.A.	N.A.	

Tip: Articulating back pull fabric upcharges only apply when contrasting pull is selected.

One Articulating Back: Arm: 0, Seat Deck: 2.7 yards, Inside Screen: 2.7 yards, Outside Screen: 3.2 yards, Seat Cushion: 3 yards, 66 sq ft, Back Cushion: 2.9 yards, 63.8 sq ft

One Corner Cushion: Arm: 0, Seat Deck: 2.7 yards, Inside Screen: 2.7 yards, Outside Screen: 3.2 yards, Seat Cushion: 3 yards, 66 sq ft, Back Cushion: 2.9 yards, 63.8 sq ft

Coalesse

Lagunitas Lounge System 2-Seat Chaises

DESIGN TOAN NGUYEN

SIN 711.16

Lagunitas Lounge System 3-Seat Chaises

DESIGN TOAN NGUYEN

SIN 711.16

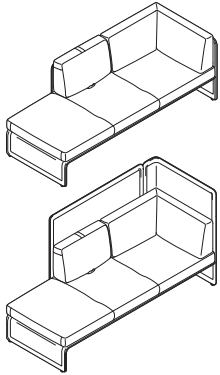

► Need help?
Product details, see *Coalesse Seating and Outdoor Specification Guide*

Standard Includes

- Screen: grade 1 knit
- Seat deck: grade 1 knit to match screen
- Non-contrasting seat cushion, articulating back cushion and pulls, back corner cushion, and end arm cushion, if selected: fabric or leather
- Bracket: paint
- Six adjustable glides
- Ships assembled

Required to Specify

- 1 Style number
 - 2 Handedness (see below under Required Selections)
 - 3 Knit color number for screen
 - 4 Fabric or leather color number for non-contrasting seat cushion, articulating back cushion and pull, back corner cushion, and end arm cushion, if selected
 - 5 Paint color number for bracket:
4141 Platinum Matte
4710 Low Gloss Black
 - 6 Options, if selected (see below)
- See *Surface Materials*, page 260

	Required Selections	Price	Required to Specify
Handedness	• Left-hand, 3-seat chaises only (seated position)	No cost	Specify with <i>left-hand configuration</i> .
	• Right-hand, 3-seat chaises only (seated position)	No cost	Specify with <i>right-hand configuration</i> .

	Options	Price	Required to Specify
Surface Materials	Fabric screen		
	• 3-seat chaise with one low-back screen and one right- or one left-hand screen	+\$314	Specify with <i>screen type fabric</i> .
	• 3-seat chaise with one high-back screen and one right- or one left-hand screen	+\$341	Specify with <i>screen type fabric</i> .
	• Contrasting fabric for screen	+\$121	Specify with <i>contrasting fabric</i> and select fabric or leather color number.
	• Contrasting fabric for cushion	+\$121	Specify with <i>contrasting fabric</i> and select fabric or leather color number.
	• Contrasting fabric for articulating back pulls	+\$121	Specify with <i>contrasting fabric</i> and select fabric or leather color number. ► See <i>Surface Materials</i> , page 260
	• Fabric upcharges	Prices at right	Specify fabric color number.
	Knit screen		
	• Grade 1 knit screen	No cost	Specify with <i>screen type knit</i> and select knit color number.
	• Grade 2 knit screen		
– 3-seat chaise with one low-back screen and one right- or one left-hand screen	+\$447	Specify with <i>screen type knit</i> and select knit color number.	
– 3-seat chaise with one high-back screen and one right- or one left-hand screen	+\$499	Specify with <i>screen type knit</i> and select knit color number.	
Acrylic backer			
• 3-seat chaise with one low-back screen and one right- or one left-hand screen	+\$ 91	Specify with acrylic backer.	
• 3-seat chaise with one high-back screen and one right- or one left-hand screen	+\$145	Specify with acrylic backer. ► See <i>Surface Materials</i> , page 260	
• COM	+\$154	Specify with COM and select fabric color number. ► See <i>Surface Materials</i> , page 262	
• COL	+\$281	Specify with COL and select leather color number. ► See <i>Surface Materials</i> , page 262	

► Options, continued on next page

Tip: If contrasting screen is selected, it is required to specify whether seat deck finish will match inner screen or outer screen.

Tip: Contrasting fabric for articulating back pull upcharge is applied one time per style number.

Tip: For Customer's Own Material or Leather, see necessary requirements, important processing instructions and ordering information.
► See *Coalesse Surface Materials Reference Guide*.

Tip: For any portion of the product that requires a COM, the additional upcharge is a one time charge per product.

Tip: For any portion of the product that requires a COL, the additional upcharge is a one time charge per product.

Tip: Must combine seat deck and list screen pricing choice (knit grade 1, knit grade 2, or fabric) from either non-contrasting or contrasting pricing list with seat and back cushion list pricing (fabric and leather) from either non-contrasting or contrasting pricing list to obtain completed list price.

Lagunitas Lounge System 3-Seat Chaises

DESIGN TOAN NGUYEN

SIN 711.16

Tip: For each USB port specified, there is one USB per port.

► Options, continued from previous page

Options	Price	Required to Specify
Power/USB Configuration		
• One power module: two power in 4710 Black paint	+\$314	Specify with one power module, with two power.
• One power module: one USB/one power in 4710 Black paint	+\$417	Specify with one power module, with one power/one USB.
• Two power modules: two power each in 4710 Black paint	+\$628	Specify with two power modules, with two power.
• Two power modules: one USB/one power each in 4710 Black paint	+\$834	Specify with two power modules, with one power/one USB.

Related Products	<ul style="list-style-type: none"> Lagunitas tables Lounge Bench 	<ul style="list-style-type: none"> ► See GSA Volume 5b Specification Guide. ► Pages 124-134 ► Page 150
-------------------------	---	---

Specification Information

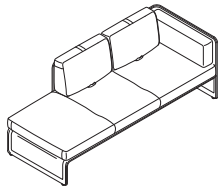

Two articulating backs
Overall: 85"W x 34"D x 32³/₈"H
Seat: 16"H

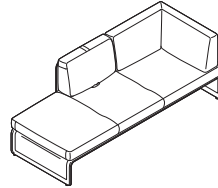

One articulating back and one corner cushion
Overall: 85"W x 34"D x 32³/₈"H
Seat: 16"H

Style Number	Base Price
--------------	------------

3-Seat Chaise with Low-Back Screen and One Side Screen

COLAGCL3 \$3922

Fabric Upcharges

	Fabric Grades:										Leather Grades:	
	6	7	8	9	10	11	12	13	14	C	E	
Articulating Back Pulls (if contrasting pull selected)	+\$ 20	+\$ 24	+\$ 30	+\$ 50	+\$ 62	+\$ 77	+\$ 87	+\$ 105	+\$ 131	+\$ 189	+\$ 222	
Seat Cushion	+\$ 160	+\$191	+\$243	+\$401	+\$503	+\$ 621	+\$ 703	+\$ 850	+\$1054	+\$1522	+\$1789	
Back Cushion	+\$ 183	+\$219	+\$279	+\$461	+\$579	+\$ 715	+\$ 811	+\$ 979	+\$1214	+\$1754	+\$2061	
Inside Screen	+\$ 206	+\$247	+\$314	+\$519	+\$653	+\$ 807	+\$ 914	+\$1104	+\$1369	N.A.	N.A.	
Outside Screen	+\$ 263	+\$313	+\$398	+\$658	+\$826	+\$1020	+\$1156	+\$1396	+\$1730	N.A.	N.A.	

Two Articulating Backs: Arm: 0, Seat Deck: 3.7 yards, Inside Screen: 3.5 yards, Outside Screen: 3.9 yards, Seat Cushion: 4.1 yards, 90.2 sq ft, Back Cushion: 4.7 yards, 103.4 sq ft

One Articulating Back and One Corner Cushion: Arm: 0, Seat Deck: 3.7 yards, Inside Screen: 3.5 yards, Outside Screen: 3.9 yards, Seat Cushion: 4.1 yards, 90.2 sq ft, Back Cushion: 4.7 yards, 103.4 sq ft

► Specification Information, continued on next page

Tip: Handedness is determined while in the seated position. Illustration above shows left-hand chaise.

Tip: Articulating back pull fabric upcharges only apply when contrasting pull is selected.

Lagunitas Lounge System 3-Seat Chaises *continued*

DESIGN TOAN NGUYEN

SIN 711.16

► Specification Information, continued from previous page

Specification Information

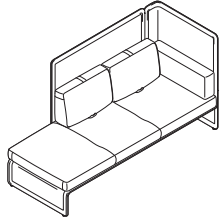

Two articulating backs
Overall: 85"W x 34"D x 50"H
Seat: 16"H

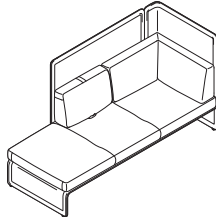

One articulating back and one corner cushion
Overall: 85"W x 34"D x 50"H
Seat: 16"H

Tip: Handedness is determined while in the seated position. Illustration above shows left-hand chaise.

Style Number	Base Price
--------------	------------

3-Seat Chaise with High-Back Screen and One Side Screen

COLAGCH3	\$4601
----------	--------

Fabric Upcharges

	Fabric Grades:								Leather Grades:		
	6	7	8	9	10	11	12	13	14	C	E
Articulating Back Pulls (if contrasting pull selected)	+\$ 20	+\$ 24	+\$ 30	+\$ 50	+\$ 62	+\$ 77	+\$ 87	+\$ 105	+\$ 131	+\$ 189	+\$ 222
Seat Cushion	+\$ 160	+\$191	+\$243	+\$401	+\$503	+\$ 621	+\$ 703	+\$ 850	+\$1054	+\$1522	+\$1789
Back Cushion	+\$ 183	+\$219	+\$279	+\$461	+\$579	+\$ 715	+\$ 811	+\$ 979	+\$1214	+\$1754	+\$2061
Inside Screen	+\$ 206	+\$247	+\$314	+\$519	+\$653	+\$ 807	+\$ 914	+\$1104	+\$1369	N.A.	N.A.
Outside Screen	+\$ 263	+\$313	+\$398	+\$658	+\$826	+\$1020	+\$1156	+\$1396	+\$1730	N.A.	N.A.

Tip: Articulating back pull fabric upcharges only apply when contrasting pull is selected.

Two Articulating Backs: Arm: 0, Seat Deck: 3.7 yards, Inside Screen: 3.5 yards, Outside Screen: 3.9 yards, Seat Cushion: 4.1 yards, 90.2 sq ft, Back Cushion: 4.7 yards, 103.4 sq ft

One Articulating Back and One Corner Cushion: Arm: 0, Seat Deck: 3.7 yards, Inside Screen: 3.5 yards, Outside Screen: 3.9 yards, Seat Cushion: 4.1 yards, 90.2 sq ft, Back Cushion: 4.7 yards, 103.4 sq ft

Coalesse

Lagunitas Lounge System 3-Seat Chaises

DESIGN TOAN NGUYEN

SIN 711.16

Lagunitas Lounge System Benches

DESIGN TOAN NGUYEN

SIN 711.16

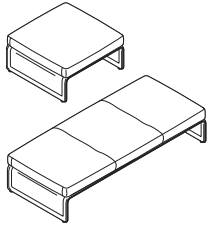

Standard Includes		Required to Specify
<ul style="list-style-type: none"> ▶ Need help? Product details, see <i>Coalesse Seating and Outdoor Specification Guide</i> 	<ul style="list-style-type: none"> • Seat deck: grade 1 knit • Seat cushion: fabric or leather • Four adjustable glides • Ships assembled 	<ol style="list-style-type: none"> 1 Style number 2 Knit or fabric color number for seat deck 3 Fabric or leather color number for seat cushion 4 Options, if selected (see below) <ul style="list-style-type: none"> ▶ See <i>Surface Materials</i>, page 260

Options	Price	Required to Specify
Surface Materials <ul style="list-style-type: none"> • Acrylic backer <ul style="list-style-type: none"> • 1-seat bench cushion +\$ 16 • 2-seat bench cushion +\$ 22 • 3-seat bench cushion +\$ 28 		Specify with acrylic backer. Specify with acrylic backer. Specify with acrylic backer. ▶ See <i>Surface Materials</i> , page 260
<ul style="list-style-type: none"> • Fabric seat deck 	Prices at right	Specify with fabric seat deck and select fabric color number.
Knit seat deck <ul style="list-style-type: none"> • Grade 1 knit seat deck 	No cost	Specify with screen type knit and select fabric color number.
<ul style="list-style-type: none"> • Grade 2 knit seat deck <ul style="list-style-type: none"> – 1-seat bench +\$ 79 – 2-seat bench +\$106 – 3-seat bench +\$131 		Specify with screen type knit and select fabric color number. Specify with screen type knit and select fabric color number. Specify with screen type knit and select fabric color number.
<ul style="list-style-type: none"> • COM 	+\$154	Specify with COM and select fabric color number. ▶ See <i>Surface Materials</i> , page 262
<ul style="list-style-type: none"> • COL 	+\$281	Specify with COL and select leather color number. ▶ See <i>Surface Materials</i> , page 262

Tip: For Customer's Own Material or Leather, see necessary requirements, important processing instructions and ordering information.
▶ See *Coalesse Surface Materials Reference Guide*.

Tip: For any portion of the product that requires a COM, the additional upcharge is a one time charge per product.

Tip: For any portion of the product that requires a COL, the additional upcharge is a one time charge per product.

Tip: Must combine seat deck and list screen pricing choice (knit grade 1, knit grade 2, or fabric) from either non-contrasting or contrasting pricing list with seat and back cushion list pricing (fabric and leather) from either non-contrasting or contrasting pricing list to obtain completed list price.

Power/USB Configuration <ul style="list-style-type: none"> • 1-seat benches <ul style="list-style-type: none"> • One power module: two power in 4710 Black paint +\$314 • One power module: one USB/one power in 4710 Black paint +\$417 • 2- and 3-seat benches <ul style="list-style-type: none"> • Two power modules: two power each in 4710 Black paint +\$628 • Two power modules: one USB/one power each in 4710 Black paint +\$834 		Specify with one power module, with two power. Specify with one power module, with one power/one USB. Specify with two power modules, with two power. Specify with two power modules, with one power/one USB.
Related Products <ul style="list-style-type: none"> • Lagunitas tables • Lounge • Chaise 		▶ See <i>GSA Volume 5b Specification Guide</i> . ▶ Pages 124-134 ▶ Pages 142-146

Lagunitas Lounge System Benches

DESIGN TOAN NGUYEN

SIN 711.16

Specification Information

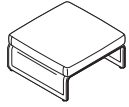

Overall: 32¾"W x 32¾"D x 16"H
Seat Deck: 2.8 yards
Seat Cushion: 2.6 yards, 57.2 sq ft

Style Number **Base Price**

1-Seat Bench

COLAGB1 \$1045

Fabric Upcharges

	Fabric Grades:								Leather Grades:		
	6	7	8	9	10	11	12	13	14	C	E
Seat Deck	+\$153	+\$181	+\$232	+\$382	+\$480	+\$593	+\$672	+\$812	+\$1008	N.A.	N.A.
Seat Cushion	+\$101	+\$121	+\$155	+\$255	+\$321	+\$396	+\$449	+\$542	+\$ 671	+\$ 970	+\$1140

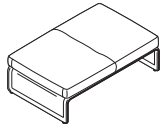

Overall: 51¼"W x 32¾"D x 16"H
Seat Deck: 3.1 yards
Seat Cushion: 3.2 yards, 70.4 sq ft

2-Seat Bench

COLAGB2 \$1465

Fabric Upcharges

	Fabric Grades:								Leather Grades:		
	6	7	8	9	10	11	12	13	14	C	E
Seat Deck	+\$164	+\$196	+\$249	+\$412	+\$518	+\$640	+\$724	+\$875	+\$1084	N.A.	N.A.
Seat Cushion	+\$125	+\$150	+\$191	+\$314	+\$394	+\$488	+\$551	+\$667	+\$ 827	+\$1193	+\$1403

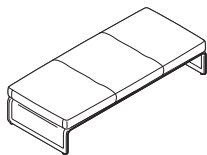

Overall: 76⅞"W x 32¾"D x 16"
Seat Deck: 3.5 yards
Seat Cushion: 4 yards, 88 sq ft

3-Seat Bench

COLAGB3 \$1882

Fabric Upcharges

	Fabric Grades:								Leather Grades:		
	6	7	8	9	10	11	12	13	14	C	E
Seat Deck	+\$179	+\$214	+\$274	+\$452	+\$566	+\$701	+\$793	+\$958	+\$1188	N.A.	N.A.
Seat Cushion	+\$157	+\$187	+\$238	+\$393	+\$493	+\$610	+\$690	+\$833	+\$1033	+\$1493	+\$1755

Lagunitas Lounge System Accessories

DESIGN TOAN NGUYEN

SIN 711.16

Lounge Booth Connector Screen



Screen: 38½"W x 50"H

Tip: Lounge booth connector screen joins two high screen lounges, enclosing one side of booth.

Standard Includes	Required to Specify
<ul style="list-style-type: none"> ▶ Need help? Product details, see <i>Coalesse Seating and Outdoor Specification Guide</i> • Screen: grade 1 knit • Two bottom brackets: 4710 Low Gloss Black or 4141 Platinum Matte Paint • Two screen ganging alignment clips 	<ul style="list-style-type: none"> 1 Style number 2 Knit color number for screen 3 Paint color number for bracket 4 Options, if selected (see below) ▶ See <i>Surface Materials</i>, page 260

Options	Price	Required to Specify
Surface Materials	Knit screen	
• Grade 1 knit screen	No cost	Specify with <i>screen type knit</i> and select knit color number.
• Grade 2 knit screen	+\$ 87	Specify with <i>screen type knit</i> and select knit color number.
• Fabric screen	+\$220	Specify with <i>screen type fabric</i> .
• Contrasting fabric	+\$121	Specify with <i>contrasting fabric</i> and select fabric color number.
• Fabric upcharges	Prices below	Specify fabric color number.
• COM	+\$154	Specify with <i>COM</i> and select fabric color number. ▶ See <i>Coalesse Surface Materials Reference Guide</i>

Specification Information

Style Number	Base Price
COLAGLBS	\$ 712

Fabric Upcharges

	Fabric Grades:								
	6	7	8	9	10	11	12	13	14
Inside Screen	+\$104	+\$126	+\$160	+\$264	+\$332	+\$409	+\$466	+\$563	+\$ 697
Outside Screen	+\$152	+\$182	+\$233	+\$383	+\$482	+\$594	+\$674	+\$813	+\$1007

Booth Connector Screen: Inside Screen: 1.4 yards, Outside Screen: 1.6 yards

Lagunitas Lounge System Accessories

DESIGN TOAN NGUYEN

SIN 711.16

Alignment Connector

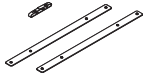

	Standard Includes	Required to Specify
▶ Need help? Product details, see <i>Coalesse Seating and Outdoor Specification Guide</i>	<ul style="list-style-type: none">• Screen and seat deck connector package: pin, bracket, and hardware• Ships ready to assemble	Style number

Related Products	
<ul style="list-style-type: none">• Lounge• Chaise	<ul style="list-style-type: none">▶ Pages 142▶ Pages 142

Specification Information	
Style Number	Price
COLAGCI	\$42

Lounge Seating

Lagunitas Focus Nook

SIN 711.16

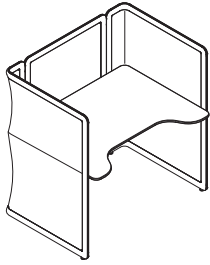

Tip: If a contrasting screen is specified, the fabric must be chosen from the same fabric family.

Tip: Grommets and power devices are specifiable on either the right or left side.

Tip: Power package must be specified when power and lighting grommet is specified.

Tip: Power simplex receptacles are tamper resistant.

Tip: When power module or power package in 4242 Milk Matte is specified, the 8' infeed cord will be white. When any other finish is specified, the infeed cord will be black.

Tip: Power/USB configuration upcharges are in addition to the power module or power package upcharge.

Standard Includes	Required to Specify
-------------------	---------------------

► Need help?
Product details, see *Coalesse Seating and Outdoor Specification Guide*

- Screen: grade 1 knit
- Worksurface:
 - Grade 1 laminate with 3 mm flat plastic edge
- Brackets: 4710 Black Low Gloss Black paint
- Six adjustable glides
- Ships ready to assemble

- 1 Style number
 - 2 Knit color number for screen
 - 3 Laminate color number for table top
 - 4 Plastic edge color number for laminate top, if selected
 - 5 Options, if selected (see below)
- See *Surface Materials*, page 260.

Options	Price	Required to Specify
---------	-------	---------------------

Surface Materials	Fabric screen		
	• Fabric screen	+\$419	Specify with screen type fabric.
	• Contrasting fabric for screen	+\$121	Specify with contrasting fabric and select fabric color number.
	• Fabric upcharges	Prices at right	Specify fabric color number.
	Knit screen		
	• Grade 1 knit screen	No cost	Specify with screen type knit and select knit color number.
	• Grade 2 knit screen	+\$473	Specify with screen type knit and select knit color number.
	• COM	+\$154	Specify with COM and select fabric color number. ► See <i>Surface Materials</i> , page 260.
	Worksurface		
	• Grade 2 laminate	Prices at right	Specify with Grade 2 laminate and select laminate color number.
• Grade 1 wood veneer	Prices at right	Specify with Grade 1 wood veneer and select wood color number.	
• Grade 2 wood veneer	Prices at right	Specify with Grade 2 wood veneer and select wood color number.	
• Stain-to-Match	No cost	Specify with <i>Stain-to-Match</i> . ► See <i>Surface Materials</i> , page 260.	
2" Light Grommet	• 2" light grommet	+\$ 25	Specify with 2" grommet and select color number.
Power/USB Configuration	Power options (with three magnetic wire management brackets)		
	• Power module	+\$261	Specify with power module and select color number.
	• Power package (contains power module and below surface convenience plug for on-surface light)	+\$443	Specify with power package and select color number.
Power/USB configurations	• Two TR simplex receptacles	No cost	Specify with two power.
	• One TR simplex receptacle and two USB A charging ports	+\$103	Specify with one power, two USB A.
	• One TR simplex receptacle, one USB A charging port, and one USB C charging port	+\$103	Specify with one power, one USB A, one USB C.
	• Cable management tray	+\$135	Specify with tray and select color number.
Cable Management Tray			
Related Products	• Lagunitas lounge seating		► Page 124
	• Lagunitas work and occasional tables		► See <i>GSA Volume 5b Specification Guide</i> .

Lagunitas Focus Nook

SIN 711.16

Specification Information

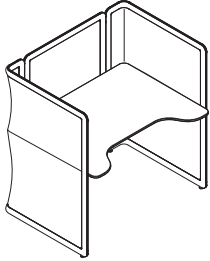

Knit Screen

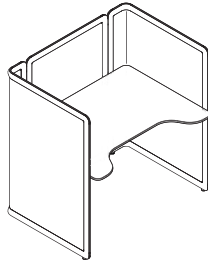

Fabric Screen

Style Number	Dimensions			Base Prices			
				Flat Vinyl Edge on Laminate Top		Flat Wood Edge on Wood Top	
	W	D	H	Grade 1	Grade 2	Grade 1	Grade 2
COLAGFN	49 1/4"	37"	50"	\$2870	\$3008	\$3937	\$4179

Fabric Upcharges

	Fabric Grades:								
	6	7	8	9	10	11	12	13	14
Inside Screen	+\$209	+\$249	+\$317	+\$525	+\$659	+\$ 814	+\$ 923	+\$1115	+\$1382
Outside Screen	+\$277	+\$329	+\$420	+\$693	+\$869	+\$1074	+\$1216	+\$1469	+\$1820

Inside screen: 4.4 yds, Outside screen: 5.1 yds

Passerelle Lounge

DESIGN STUDIO B

SIN 711.16

Tip: Fabrics and leathers will appear loose with comfort wrinkles when upholstered.

Tip: Recommended leathers are Elmosoft Grade C and Elmorustical Grade E.

Tip: Special color match, consult Customer Service.

Tip: For Customer's Own Material or Leather, see necessary requirements, important processing instructions, and ordering information
 ▶ See *Coalesse Surface Materials Reference Guide*.

Standard Includes		Required to Specify
▶ Need help? Product details, see <i>Coalesse Seating and Outdoor Specification Guide</i>	<ul style="list-style-type: none"> • Frame: unibody construction with finger jointed plywood • Upholstery: multiple densities of polyurethane foam and polyester fiber on seat, back, and arms • Legs: solid maple with non-adjustable glides 	1 Style number 2 Number of fabrics if contrasting fabric style number is selected 3 Fabric or leather color number for upholstery on seat, back, and arms 4 Wood color number for legs 5 Options, if selected (see below) ▶ See <i>Surface Materials</i> , page 260

Options	Price	Required to Specify
Surface Materials <ul style="list-style-type: none"> • Contrasting fabric 	+\$121 per fabric	Add suffix K to the style number and select fabric color number.
Acrylic backer <ul style="list-style-type: none"> • Lounge chair • 2-seat lounge • 3-seat lounge • Arm bolster 	+\$ 34 +\$ 45 +\$ 55 +\$ 8	Specify with acrylic backer. Specify with acrylic backer. Specify with acrylic backer. Specify with acrylic backer. ▶ See <i>Surface Materials</i> , page 260
Bolster/Pillow Attachment Rings <ul style="list-style-type: none"> • Attachment rings for bolster/pillow attach to lounge attachment straps 	+\$ 65	Specify with attachment rings.
Lounge Attachment Straps <ul style="list-style-type: none"> • Attachment straps for lounge attach to bolster/pillow attachment rings 	No cost	Specify with attachment straps for left and right sides.
Related Products <ul style="list-style-type: none"> • Passerelle tables 		▶ See <i>GSA Volume 5b Specification Guide</i> .

Specification Information

Style Number	Base Prices														Leather Grades:		
	Fabric Grades:														COL	C	E
	COM	6	7	8	9	10	11	12	13	14							

Lounge Chair

440-WB	\$1639	\$1661	\$1701	\$1740	\$1813	\$1883	\$2065	\$2190	\$2228	\$2457	\$1834	\$3981	\$4347
COM/yds = 4, COL/sq ft = 88													

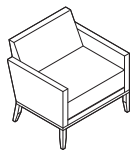

Overall: 27"D 30½"W 29"H
 Inside: 19"D 26"W 17"H
 Seat: 17½"H
 Arm: 23"H

2-Seat Lounge

440-2WB	\$2947	\$3029	\$3098	\$3144	\$3250	\$3334	\$3588	\$3771	\$3803	\$4222	\$3147	\$6132	\$6537
COM/yds = 5½, COL/sq ft = 121													

▶ Specification Information, continued on next page

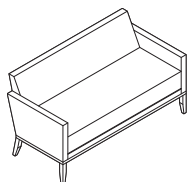

Overall: 27"D 56½"W 29"H
 Inside: 19"D 52"W 17"H
 Seat: 17½"H
 Arm: 23"H

Passerelle Lounge

DESIGN STUDIO B

SIN 711.16

► Specification Information, continued from previous page

Specification Information

Style Number	Base Prices										Leather Grades:		
	Fabric Grades:										COL	C	E
	COM	6	7	8	9	10	11	12	13	14			

3-Seat Lounge

440-3WB	\$3275	\$3408	\$3492	\$3549	\$3681	\$3785	\$4106	\$4308	\$4368	\$4842	\$3470	\$7174	\$7615
COM/yds = 6 ³ / ₄ , COL/sq ft = 149													

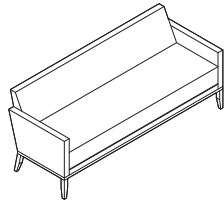

Overall: 27"D 72³/₄"W 29"H
 Inside: 19"D 68"W 17"H
 Seat: 17¹/₂"H

Arm: 23"H



Overall: 17¹/₂"W 5³/₄"Dia

Arm Bolster

440-B	\$ 281	\$ 286	\$ 294	\$ 307	\$ 339	\$ 391	\$ 430	\$ 439	\$ 457	\$ 475	\$ 575	\$ 873	\$1172
COM/yds = 1, COL/sq ft = 18													

Passerelle Ottoman

DESIGN STUDIO B

SIN 711.16

Tip: Fabrics and leathers will appear loose with comfort wrinkles when upholstered.

Tip: Recommended leathers are Elmosoft Grade C and Elmorustical Grade E.

Tip: Special color match, consult Customer Service.

Tip: For Customer's Own Material or Leather, see necessary requirements, important processing instructions, and ordering information
 ▶ See *Coalesse Surface Materials Reference Guide*.

Standard Includes		Required to Specify
▶ Need help? Product details, see <i>Coalesse Seating and Outdoor Specification Guide</i>	<ul style="list-style-type: none"> • Frame: unibody construction with finger jointed plywood • Upholstery: multiple densities of polyurethane foam and polyester fiber • Legs: solid maple with non-adjustable glides 	1 Style number 2 Fabric or leather color number for upholstery 3 Wood color number for legs 4 Options, if selected (see below) ▶ See <i>Surface Materials</i> , page 260

Options	Price	Required to Specify
Surface Materials	Acrylic backer	
	• 17"D x 17"W ottoman	Specify with acrylic backer.
	• 20"D x 26"W ottoman	Specify with acrylic backer.
	• 36"D x 36"W ottoman	Specify with acrylic backer. ▶ See <i>Surface Materials</i> , page 260

Specification Information													
Style Number	Base Prices											Leather Grades:	
	Fabric Grades:											COL	C
COM	6	7	8	9	10	11	12	13	14				

Ottoman

440-H1717WB	\$ 976	\$ 982	\$ 996	\$1021	\$1046	\$1068	\$1137	\$1185	\$1197	\$1333	\$1264	\$2047	\$2313
COM/yds = 1½, COL/sq ft = 33													

440-H2026WB	\$1159	\$1165	\$1192	\$1204	\$1255	\$1290	\$1372	\$1445	\$1450	\$1613	\$1427	\$2481	\$2768
COM/yds = 2, COL/sq ft = 44													

440-H3636WB	\$1517	\$1526	\$1559	\$1583	\$1638	\$1683	\$1807	\$1899	\$1921	\$2132	\$1756	\$3240	\$3556
COM/yds = 2¾, COL/sq ft = 61													



Overall: 17"D 17"W 17"H

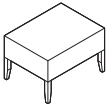

Overall: 20"D 26"W 17"H

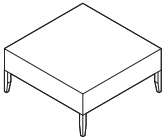

Overall: 36"D 36"W 17"H

Passerelle Benches

DESIGN STUDIO B

SIN 711.16

Tip: Fabrics and leathers will appear loose with comfort wrinkles when upholstered.

Tip: For plain upholstery option or contrasting textiles, contact Customer Service.

Tip: Recommended leathers are Elmosoft Grade C and Elmorustical Grade E.

Tip: Special color match, consult Customer Service.

Tip: For Customer's Own Material or Leather, see necessary requirements, important processing instructions, and ordering information
 ▶ See *Coalesse Surface Materials Reference Guide*.

Standard Includes		Required to Specify
▶ Need help? Product details, see <i>Coalesse Seating and Outdoor Specification Guide</i>	<ul style="list-style-type: none"> • Frame: solid maple • Upholstery: multiple densities of polyurethane foam • Legs: solid maple with non-adjustable glides • Button detail: tufted and double needled 	1 Style number 2 Fabric or leather color number for upholstery on bench 3 Wood color number for legs 4 Options, if selected (see below) ▶ See <i>Surface Materials</i> , page 260

Options	Price	Required to Specify
Surface Materials Acrylic backer		
• 20"D x 60"W bench	+\$25	Specify with acrylic backer.
• 40"D x 40"W bench	+\$34	Specify with acrylic backer.
• 30"D x 60"W bench	+\$38	Specify with acrylic backer. ▶ See <i>Surface Materials</i> , page 260

Specification Information													
Style Number	Base Prices											Leather Grades:	
	Fabric Grades:											COL	C
COM	6	7	8	9	10	11	12	13	14				

Bench

440-B3060WB	\$1998	\$2009	\$2067	\$2098	\$2173	\$2230	\$2366	\$2483	\$2532	\$2810	\$2212	\$4371	\$4761
COM/yds = 4, COL/sq ft = 88													

440-B4040WB	\$1940	\$1949	\$1983	\$2023	\$2088	\$2146	\$2257	\$2369	\$2409	\$2680	\$2174	\$4055	\$4389
COM/yds = 3½, COL/sq ft = 77													

440-B2060WB	\$1740	\$1748	\$1790	\$1806	\$1859	\$1912	\$1982	\$2076	\$2114	\$2359	\$1998	\$3476	\$3748
COM/yds = 2¾, COL/sq ft = 61													

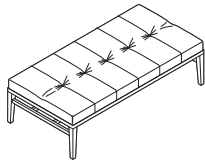

Overall: 30"D 60"W 17"H

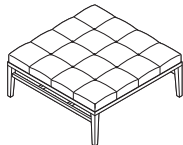

Overall: 40"D 40"W 17"H

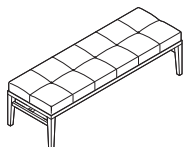

Overall: 20"D 60"W 17"H

Switch

DESIGN E00S

SIN 711.16

Tip: Fabrics and leathers will appear loose with comfort wrinkles when upholstered.

Tip: Due to seat conversion arms are 4 1/2"W. Lowered arm has weight limit of 100 lb.

Tip: Recommended leathers are Elmosoft Grade C and Elmorustical Grade E.

Tip: Loose cushions standard.

Tip: Arm bolsters must be specified separately.

Tip: Special color match, consult Customer Service.

Tip: For Customer's Own Material or Leather, see necessary requirements, important processing instructions, and ordering information
 ► See Coalesse Surface Materials Reference Guide.

Tip: 391-4 two seat with extensions, when extended: Both arms = 96"W overall One arm = 84"W overall Arms not extended = 71"W overall (closed).

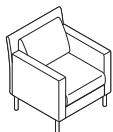

Overall: 29 1/2"D 28"W 32 1/2"H
Inside: 19"D 20"W 17"H
Seat: 17 1/2"H
Arm: 26"H

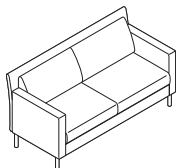

Overall: 24 1/2"D 62"W 33"H
Inside: 19"D 54 1/2"W 33"H
Seat: 19 1/2"H
Arm: 26 1/4"H

Standard Includes		Required to Specify
► Need help? Product details, see Coalesse Seating and Outdoor Specification Guide	<ul style="list-style-type: none"> Selected solid hardwood and wood veneer frame Two seat with extension: tubular steel frame with solid hardwood arms <ul style="list-style-type: none"> - Arms are 4.5" wide Upholstery: multiple densities of polyurethane foam and polyester fiber on seat back and arms Legs: matte chrome finish on steel Arm bolster, if selected: fabric or leather 	<ol style="list-style-type: none"> Style number Number of fabrics if contrasting fabric style number is selected Fabric or leather color number for upholstery on seat, back, and arms, or arm bolsters, if selected Options, if selected (see below) ► See Surface Materials, page 260

Options	Price	Required to Specify	
Surface Materials	<ul style="list-style-type: none"> Contrasting fabric 	+\$121 per fabric	
Acrylic backer			
<ul style="list-style-type: none"> Lounge chair 2-seat lounge 3-seat lounge 2-seat lounge with extensions Arm bolster 		<ul style="list-style-type: none"> +\$ 40 +\$ 74 +\$ 78 +\$ 93 +\$ 8 	
Attachment Straps	<ul style="list-style-type: none"> 391 391-2 391-3 391-4 Bolster 	<ul style="list-style-type: none"> +\$126 +\$252 +\$378 +\$252 +\$ 65 	<ul style="list-style-type: none"> Specify with acrylic backer. Specify with acrylic backer. Specify with acrylic backer. Specify with acrylic backer. Specify with acrylic backer. ► See Surface Materials, page 260
Related Products	<ul style="list-style-type: none"> Switch tables 		► See GSA Volume 5b Specification Guide.

Style Number	Base Prices														Leather Grades:		
	Fabric Grades:														COL	C	E
	COM	6	7	8	9	10	11	12	13	14							

Lounge Chair														
391	\$2518	\$2522	\$2553	\$2604	\$2761	\$2862	\$2979	\$3061	\$3206	\$3407	\$2694	\$5281	\$5974	
COM/yds = 4 1/2, COL/sq ft = 99														

2-Seat Lounge														
391-2	\$3855	\$3964	\$4015	\$4101	\$4362	\$4530	\$4726	\$4862	\$5103	\$5439	\$4032	\$8243	\$9244	
COM/yds = 7 1/2, COL/sq ft = 165														

► Specification Information, continued on next page

Switch

DESIGN EOOS

SIN 711.16

► Specification Information, continued from previous page

Specification Information

Style Number	Base Prices										Leather Grades:		
	Fabric Grades:										COL	C	E
	COM	6	7	8	9	10	11	12	13	14			

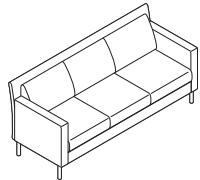

Overall: 30½"D 73"W 33"H
 Inside: 20"D 66"W 33"H
 Seat: 20"D 18½"H
 Arm: 26¼"H

3-Seat Lounge

391-3	\$5064	\$5191	\$5245	\$5336	\$5615	\$5795	\$6004	\$6148	\$6407	\$6764	\$5241	\$10,878	\$12,137
--------------	--------	--------	--------	--------	--------	--------	--------	--------	--------	--------	--------	----------	----------

COM/yds = 8, COL/sq ft = 176

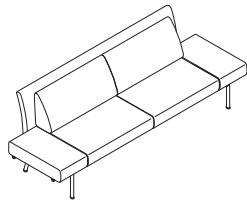

Lounge overall: 35"D 70½"W 33"H
 Overall extended: 35"D 95½"W 33"H
 Seat: 23"D 16½"W
 Arm: 29"D 26½"W
 One arm up: 77"H

2-Seat Lounge with Extensions

391-4	\$5364	\$5527	\$5587	\$5690	\$6003	\$6205	\$6440	\$6603	\$6893	\$7296	\$5541	\$11,998	\$13,405
--------------	--------	--------	--------	--------	--------	--------	--------	--------	--------	--------	--------	----------	----------

COM/yds = 9, COL/sq ft = 198



Overall: 17½"D 5¾"Dia

Arm Bolster

391-B	\$ 251	\$ 245	\$ 252	\$ 263	\$ 298	\$ 321	\$ 346	\$ 365	\$ 397	\$ 442	\$ 546	\$ 817	\$ 1087
--------------	--------	--------	--------	--------	--------	--------	--------	--------	--------	--------	--------	--------	---------

COM/yds = 1, COL/sq ft = 18

SW_1 Lounge Seating

DESIGN SCOTT WILSON & MINIMAL

SIN 711.18



Tip: For Customer's Own Material or Leather, see necessary requirements, important processing instructions, and ordering information
 ▶ See page 262

Standard Includes		Required to Specify
▶ Need help? Product details, see <i>Coalesse Seating and Outdoor Specification Guide</i>	<ul style="list-style-type: none"> • Seat: fabric or leather • Back: knit • Base: 8040 Aluminum Matte Polished • Frame: steel tube • Glides: aluminum with non marring plastic insert • Swivel return mechanism • Ottoman, if selected: fabric or leather 	1 Style number 2 Fabric or leather color number for seat or ottoman, if selected 3 Knit color number for back 4 Options, if selected (see below) ▶ See <i>Surface Materials</i> , page 260

Options	Price	Required to Specify
Surface Materials	<ul style="list-style-type: none"> • Contrasting fabric +\$121 	Specify with <i>contrasting fabric</i> and select fabric color number.
	Fire code seating	
	<ul style="list-style-type: none"> • Chairs and ottoman +\$237 	Specify with <i>fire code seating</i> .
	Acrylic backer	
	<ul style="list-style-type: none"> • Chairs +\$ 30 • Ottoman +\$ 12 	Specify with <i>acrylic backer</i> . Specify with <i>acrylic backer</i> . ▶ See <i>Surface Materials</i> , page 260
	Lumbar pillow for lounge chairs	
	<ul style="list-style-type: none"> • Fabric group 6 +\$ 27 • Fabric group 7 +\$ 32 • Fabric group 8 +\$ 40 • Fabric group 9 +\$ 66 • Fabric group 10 +\$ 83 • Fabric group 11 +\$103 • Fabric group 12 +\$116 • Fabric group 13 +\$140 • Fabric group 14 +\$174 • Leather group C +\$257 • Leather group E +\$264 • Customer's Own Material (COM) +\$ 41 	Specify fabric color number. Specify fabric color number. Specify fabric color number. Specify fabric color number. Specify fabric color number. Specify fabric color number. Specify fabric color number. Specify fabric color number. Specify fabric color number. Specify fabric color number. Specify leather color number. Specify leather color number. Specify fabric color number. ▶ See <i>Surface Materials</i> , page 262 Specify leather color number. ▶ See <i>Surface Materials</i> , page 262
	<ul style="list-style-type: none"> • Customer's Own Leather (COL) +\$281 	
Lumbar Pillow	<ul style="list-style-type: none"> • No pillow No cost • Pillow +\$230 	Specify with <i>no pillow</i> . Specify with <i>pillow</i> .
Swivel Mechanism	<ul style="list-style-type: none"> • Swivel-only mechanism (omit return feature) No cost 	Specify with <i>swivel-only mechanism</i> .
Tablet	<ul style="list-style-type: none"> • No tablet No cost • Right tablet (seated position) +\$687 • Left tablet (seated position) +\$687 	Specify with <i>no tablet</i> . Specify with <i>right tablet</i> and select 6000 Black or 6052 Milk finish. Specify with <i>left tablet</i> and select 6000 Black or 6052 Milk finish.

Tip: Paint on lounge tablet arm support will complement 8040 Aluminum Matte polished base.



Top of Cushion to Bottom of Tablet: 8 1/2"H

Tip: Handedness is determined while in the seated position.

Related Products	<ul style="list-style-type: none"> • Collaborative and conference tables • Occasional tables • Collaboration seating 	▶ See <i>GSA Volume 5b Specification Guide</i> . ▶ See <i>GSA Volume 5b Specification Guide</i> . ▶ Page 217
-------------------------	---	--

SW_1 Lounge Seating

DESIGN SCOTT WILSON & MINIMAL

SIN 711.18

Specification Information

Style Number	Base Prices											Leather Grades:		
	Fabric Grades:											COL	C	E
	COM	6	7	8	9	10	11	12	13	14				



Overall: 28 1/4"D 32 1/4"W 36 3/4"H
 Seat: 16"H
 Arm: 23"H

Low-Back Collaborative Lounge Chair

Style Number	Seat	COM	6	7	8	9	10	11	12	13	14	COL	C	E
COW613		\$2149	\$2149	\$2155	\$2165	\$2196	\$2217	\$2240	\$2256	\$2285	\$2326	\$2201	\$2438	\$2472
	Upper back	\$2191	\$2191	\$2205	\$2229	\$2302	\$2349	\$2404	\$2442	\$2510	\$2603	\$2314	\$2866	\$2946

COM/yds = 3, COL/sq ft = 60
 Pillow COM/yds = 1 1/4, COL/sq ft = 27 1/2



Overall: 30"D 32 1/4"W 41 3/4"H
 Seat: 16"H
 Arm: 23"H

High-Back Collaborative Lounge Chair

Style Number	Seat	COM	6	7	8	9	10	11	12	13	14	COL	C	E
COW713		\$2501	\$2501	\$2507	\$2517	\$2548	\$2569	\$2592	\$2608	\$2637	\$2678	\$2553	\$2790	\$2824
	Upper back	\$2543	\$2543	\$2557	\$2581	\$2654	\$2701	\$2756	\$2794	\$2862	\$2955	\$2666	\$3218	\$3298

COM/yds = 3, COL/sq ft = 60
 Pillow COM/yds = 1 1/4, COL/sq ft = 27 1/2



Overall: 20"D 23"W 14"H

Ottoman

Style Number	COM	6	7	8	9	10	11	12	13	14	COL	C	E	
COW210		\$1115	\$1109	\$1116	\$1127	\$1162	\$1185	\$1210	\$1229	\$1261	\$1306	\$1355	\$1461	\$1503

COM/yds = 1, COL/sq ft = 22

SW_1 Multi-Fabric Diagram

DESIGN STUDIO B

SIN 711.18

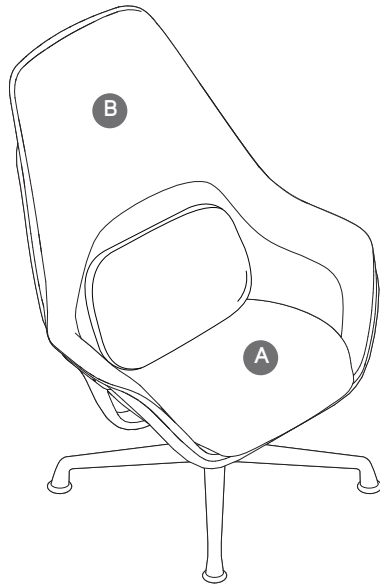

TO: _____

FROM: _____

DATE: _____

FAX...888.413.5161

A Seat: _____

B Arms/Back: _____

Contrasting fabric charges will apply. List price based on highest grade textile specified.

\$121 list upcharge for each contrasting textile pricing based on highest grade textile specified.

Specify Model below:

COW613 Low-Back Collaborative Lounge Chair

COW713 High-Back Collaborative Lounge Chair

Coalesse

SW_1 Multi-Fabric Diagram

DESIGN STUDIO B

SIN 711.18

Together Bench by Walter Knoll

DESIGN E00S

SIN 711.16

Tip: Fabrics and leathers will appear loose with comfort wrinkles when upholstered.

Tip: For Customer's Own Material or Leather, see necessary requirements, important processing instructions, and ordering information
 ▶ See *Coalesse Surface Materials Reference Guide*.

Standard Includes	Required to Specify
▶ Need help? Product details, see <i>Coalesse Seating and Outdoor Specification Guide</i>	1 Style number 2 Number of fabrics if contrasting fabric style number is selected 3 Fabric or leather color number for upholstery 4 Options, if selected (see below) ▶ See <i>Surface Materials</i> , page 260

Options	Price	Required to Specify
Surface Materials <ul style="list-style-type: none"> Contrasting fabric 	+\$121 per fabric	Add suffix K to the style number and select fabric color number.
Acrylic backer <ul style="list-style-type: none"> 69¾"W straight bench without back 96½"W straight bench without back 26¾"D x 69¾"W benches 26¾"D x 96½"W benches 69¾"D x 96½"W benches 96½"D x 96½"W and 69¾"D x 123¼"W benches 96½"D x 123¼"W bench 	+\$ 36 +\$ 40 +\$ 49 +\$ 59 +\$ 95 +\$108 +\$118	Specify with <i>acrylic backer</i> . Specify with <i>acrylic backer</i> . Specify with <i>acrylic backer</i> . Specify with <i>acrylic backer</i> . Specify with <i>acrylic backer</i> . Specify with <i>acrylic backer</i> . ▶ See <i>Surface Materials</i> , page 260
Back Offset <ul style="list-style-type: none"> Back offset 	No cost	Specify with <i>back offset</i> .

Style Number	Base Prices												Leather Grades:		
	Fabric Grades:												COL	C	E
	COM	6	7	8	9	10	11	12	13	14					

Left Corner with Back, 8" Offset

COT09669L8	\$7943	\$8131	\$8197	\$8309	\$8648	\$8867	\$9122	\$ 9298	\$ 9612	\$10,049	\$8070	\$12,162	\$12,892
COM/yds = 9¾, COL/sq ft = 215													

COT09669L8	\$8558	\$8782	\$8854	\$8977	\$9351	\$9593	\$9873	\$10,068	\$10,414	\$10,896	\$8685	\$13,203	\$14,009
COM/yds = 10¾, COL/sq ft = 237													

▶ Specification Information, continued on next page

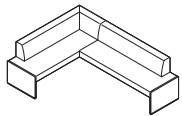

Overall: 70½"D 96½"W 31"H
 Seat: 19"D 18½"H

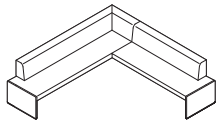

Overall: 97¼"D 96½"W 31"H
 Seat: 19"D 18½"H

Together Bench by Walter Knoll

DESIGN EOOS

SIN 711.16

► Specification Information, continued from previous page

Specification Information

Style Number	Base Prices											Leather Grades:		
	Fabric Grades:											COL	C	E
	COM	6	7	8	9	10	11	12	13	14				

Left Corner with Back, 8" Offset, continued

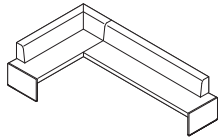

Overall: 70½"D 123¼"W 31"H
Seat: 19"D 18½"H

COTO12369L8	\$8800	\$9042	\$9116	\$9246	\$ 9637	\$ 9890	\$10,184	\$10,387	\$10,750	\$11,254	\$8927	\$13,657	\$14,500
--------------------	--------	--------	--------	--------	---------	---------	----------	----------	----------	----------	--------	----------	----------

COM/yds = 11¼, COL/sq ft = 248

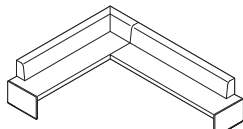

Overall: 97¼"D 123¼"W 31"H
Seat: 19"D 18½"H

COTO12396L8	\$9243	\$9529	\$9613	\$9755	\$10,191	\$10,472	\$10,798	\$11,024	\$11,427	\$11,987	\$9370	\$14,524	\$15,444
--------------------	--------	--------	--------	--------	----------	----------	----------	----------	----------	----------	--------	----------	----------

COM/yds = 12½, COL/sq ft = 270

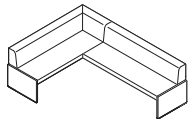

Overall: 70½"D 96½"W 31"H
Seat: 19"D 18½"H

COTO9669L15	\$8110	\$8316	\$8385	\$8502	\$ 8859	\$ 9090	\$ 9357	\$ 9543	\$ 9873	\$10,332	\$8237	\$12,542	\$13,310
--------------------	--------	--------	--------	--------	---------	---------	---------	---------	---------	----------	--------	----------	----------

COM/yds = 10¼, COL/sq ft = 226

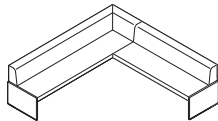

Overall: 97¼"D 96½"W 31"H
Seat: 19"D 18½"H

COTO9696L15	\$8726	\$8968	\$9042	\$9172	\$ 9563	\$ 9816	\$10,110	\$10,313	\$10,676	\$11,180	\$8853	\$13,583	\$14,426
--------------------	--------	--------	--------	--------	---------	---------	----------	----------	----------	----------	--------	----------	----------

COM/yds = 11¼, COL/sq ft = 248

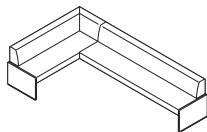

Overall: 70½"D 123¼"W 31"H
Seat: 19"D 18½"H

COTO12369L15	\$8966	\$9225	\$9304	\$9438	\$ 9847	\$10,112	\$10,418	\$10,630	\$11,010	\$11,535	\$9093	\$14,036	\$14,917
---------------------	--------	--------	--------	--------	---------	----------	----------	----------	----------	----------	--------	----------	----------

COM/yds = 11¾, COL/sq ft = 259

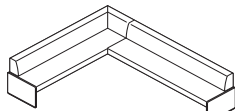

Overall: 97¼"D 123¼"W 31"H
Seat: 19"D 18½"H

COTO12396L15	\$9408	\$9702	\$9788	\$9934	\$10,377	\$10,664	\$10,997	\$11,227	\$11,638	\$12,209	\$9535	\$14,902	\$15,858
---------------------	--------	--------	--------	--------	----------	----------	----------	----------	----------	----------	--------	----------	----------

COM/yds = 12¾, COL/sq ft = 281

► Specification Information, continued on next page

Together Bench by Walter Knoll *continued*

DESIGN E00S

SIN 711.16

Tip: For Customer's Own Material or Leather, see necessary requirements, important processing instructions, and ordering information
 ▶ See Coalesse Surface Materials Reference Guide.

Tip: Fabrics and leathers will appear loose with comfort wrinkles when upholstered.

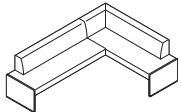

Overall: 70½"D 96½"W 31"H
 Seat: 19"D 18½"H

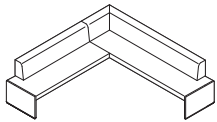

Overall: 97¼"D 96½"W 31"H
 Seat: 19"D 18½"H

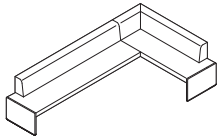

Overall: 70½"D 123¼"W 31"H
 Seat: 19"D 18½"H

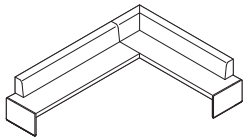

Overall: 97¼"D 123¼"W 31"H
 Seat: 19"D 18½"H

▶ Specification Information, continued from previous page

Specification Information

Style Number	Base Prices														Leather Grades:		
	Fabric Grades:														COL	C	E
	COM	6	7	8	9	10	11	12	13	14							

Right Corner with Back, 8" Offset

COT09669R8 \$7943 \$8131 \$8197 \$8309 \$ 8648 \$ 8867 \$ 9122 \$ 9298 \$ 9612 \$10,049 \$8070 \$12,162 \$12,892
 COM/yds = 9¾, COL/sq ft = 215

COT09696R8 \$8558 \$8782 \$8854 \$8977 \$ 9351 \$ 9593 \$ 9873 \$10,068 \$10,414 \$10,896 \$8685 \$13,203 \$14,009
 COM/yds = 10¾, COL/sq ft = 237

COT012369R8 \$8800 \$9042 \$9116 \$9246 \$ 9637 \$ 9890 \$10,184 \$10,387 \$10,750 \$11,254 \$8927 \$13,657 \$14,500
 COM/yds = 11¼, COL/sq ft = 248

COT012396R8 \$9243 \$9529 \$9613 \$9755 \$10,191 \$10,472 \$10,798 \$11,024 \$11,427 \$11,987 \$9370 \$14,524 \$15,444
 COM/yds = 12½, COL/sq ft = 270

▶ Specification Information, continued on next page

Together Bench by Walter Knoll

DESIGN EOOS

SIN 711.16

► Specification Information, continued from previous page

Specification Information

Style Number	Base Prices										Leather Grades:		
	Fabric Grades:										COL	C	E
	COM	6	7	8	9	10	11	12	13	14			

Right Corner with Back, 1 1/2" Offset

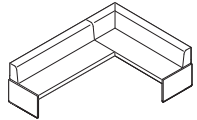

Overall: 70 1/2"D 96 1/2"W 31"H
Seat: 19"D 18 1/2"H

COT09669R15	\$8110	\$8316	\$8385	\$8502	\$ 8859	\$ 9090	\$ 9357	\$ 9543	\$ 9873	\$10,332	\$8237	\$12,542	\$13,310
COM/yds = 10 1/4, COL/sq ft = 226													

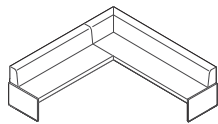

Overall: 97 1/4"D 96 1/2"W 31"H
Seat: 19"D 18 1/2"H

COT09696R15	\$8726	\$8968	\$9042	\$9172	\$ 9563	\$ 9816	\$10,110	\$10,313	\$10,676	\$11,180	\$8853	\$13,583	\$14,426
COM/yds = 11 1/4, COL/sq ft = 248													

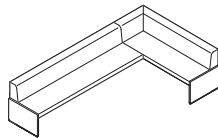

Overall: 70 1/2"D 123 3/4"W 31"H
Seat: 19"D 18 1/2"H

COT012369R15	\$8966	\$9225	\$9304	\$9438	\$ 9847	\$10,112	\$10,418	\$10,630	\$11,010	\$11,535	\$9093	\$14,036	\$14,917
COM/yds = 11 3/4, COL/sq ft = 259													

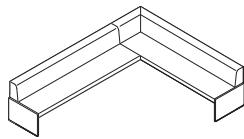

Overall: 97 1/4"D 123 3/4"W 31"H
Seat: 19"D 18 1/2"H

COT012396R15	\$9408	\$9702	\$9788	\$9934	\$10,377	\$10,664	\$10,997	\$11,227	\$11,638	\$12,209	\$9535	\$14,902	\$15,858
COM/yds = 12 3/4, COL/sq ft = 281													

► Specification Information, continued on next page

Together Bench by Walter Knoll *continued*

DESIGN E00S

SIN 711.16

Tip: For Customer's Own Material or Leather, see necessary requirements, important processing instructions, and ordering information

► See *Coalesse Surface Materials Reference Guide*.

Tip: Fabrics and leathers will appear loose with comfort wrinkles when upholstered.

► Specification Information, continued from previous page

Specification Information

Style Number	Base Prices											Leather Grades:		
	Fabric Grades:											COL	C	E
	COM	6	7	8	9	10	11	12	13	14				

Straight with Back, 8" Offset

COTO69WB8	\$3933	\$3946	\$3978	\$4032	\$4197	\$4305	\$4428	\$4514	\$4668	\$4880	\$4060	\$6026	\$6384
COM/yds = 4¾, COL/sq ft = 105													

COTO96WB8	\$4498	\$4563	\$4605	\$4677	\$4894	\$5035	\$5198	\$5312	\$5513	\$5792	\$4625	\$7230	\$7698
COM/yds = 6¼, COL/sq ft = 138													

Straight with Back, 1½" Offset

COTO69WB15	\$4098	\$4119	\$4153	\$4211	\$4385	\$4496	\$4628	\$4718	\$4879	\$5103	\$4225	\$6297	\$6673
COM/yds = 5, COL/sq ft = 110													

COTO96WB15	\$4664	\$4739	\$4782	\$4856	\$5083	\$5229	\$5399	\$5517	\$5726	\$6017	\$4791	\$7501	\$7989
COM/yds = 6½, COL/sq ft = 143													

► Specification Information, continued on next page

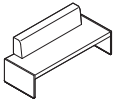

Overall: 26¾"D 69¾"W 31"H
Seat: 19"D 18½"H

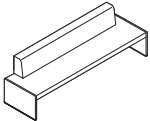

Overall: 26¾"D 96½"W 31"H
Seat: 19"D 18½"H

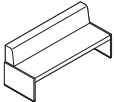

Overall: 26¾"D 69¾"W 31"H
Seat: 19"D 18½"H

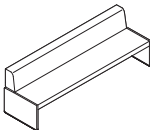

Overall: 26¾"D 96½"W 31"H
Seat: 19"D 18½"H

Coalesse

Together Bench by Walter Knoll

DESIGN EOOS

SIN 711.16

► Specification Information, continued from previous page

Specification Information

Style Number	Base Prices											Leather Grades:		
	Fabric Grades:											COL	C	E
	COM	6	7	8	9	10	11	12	13	14				

Straight without Back

COT069	\$2831	\$2831	\$2858	\$2904	\$3044	\$3134	\$3237	\$3310	\$3439	\$3619	\$2972	\$4619	\$4919
COM/yds = 4, COL/sq ft = 88													

COT096	\$3229	\$3242	\$3274	\$3328	\$3493	\$3601	\$3724	\$3810	\$3964	\$4176	\$3356	\$5322	\$5680
COM/yds = 4 ³ / ₄ , COL/sq ft = 105													

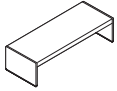

Overall: 26³/₄"D 69³/₄"W 18¹/₂"H
Seat: 18¹/₂"H

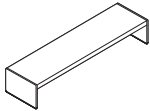

Overall: 26³/₄"D 96¹/₂"W 18¹/₂"H
Seat: 18¹/₂"H

Lounge Seating

Visalia Lounge

DESIGN COALESSE DESIGN GROUP

SIN 711.16

Specification Information

Lounge Chair

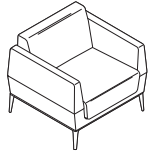

Overall: 29"D 31¾"W 28"H
 Seat height: 16¼"H
 Arm height to the floor: 23"H
 Inside: 19"D 23"W 16¼"H

Style Number Upholstery

2-Seat Lounge

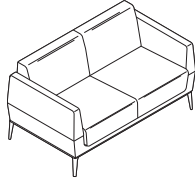

Overall: 29"D 53¾"W 28"H
 Seat height: 16¼"H
 Arm height to the floor: 23"H
 Inside: 19"D 45"W 16¼"H

Base Prices

Fabric Grades:

COM 6 7 8 9 10 11 12 13 14

Bench

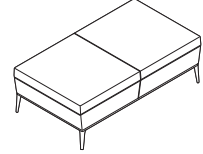

Overall: 29"D 52"W 16¼"H

Leather Grades:
 COL C E

Lounge Chair with Single Fabric

COJHL100	\$2290	\$2290	\$2315	\$2358	\$2488	\$2573	\$2671	\$2738	\$2859	\$3027	\$2439	\$3428	\$3562
	COM/yds = 3¾, COL/sq ft = 83												

Lounge Chair with Accent Upholstery

COJHLC100	Standard Upholstery	\$2354	\$2354	\$2374	\$2408	\$2512	\$2580	\$2658	\$2712	\$2809	\$2943	\$2461	\$3413	\$3536
	COM/yds = 3, COL/sq ft = 66													
	Accent Upholstery	+\$ 6	No cost	+\$ 7	+\$ 18	+\$ 53	+\$ 76	+\$101	+\$120	+\$152	+\$197	+\$246	+\$352	+\$394
	COM/yds = 1, COL/sq ft = 22													

2-Seat Lounge with Single Fabric

COJHL200	\$3518	\$3539	\$3573	\$3631	\$3805	\$3916	\$4048	\$4138	\$4299	\$4523	\$3645	\$5112	\$5295
	COM/yds = 5, COL/sq ft = 110												

2-Seat Lounge with Accent Upholstery

COJHLC200	Standard Upholstery	\$3617	\$3621	\$3652	\$3703	\$3860	\$3961	\$4078	\$4160	\$4305	\$4506	\$3744	\$5197	\$5381
	COM/yds = 4½, COL/sq ft = 99													
	Accent Upholstery	No cost	No cost	+\$ 8	+\$ 23	+\$ 66	+\$ 94	+\$127	+\$150	+\$190	+\$246	+\$237	+\$445	+\$497
	COM/yds = 1¼, COL/sq ft = 27													

3-Seat Lounge with Single Fabric

COJHL300	\$4025	\$4082	\$4122	\$4191	\$4400	\$4534	\$4691	\$4800	\$4993	\$5262	\$4152	\$6112	\$6348
	COM/yds = 6, COL/sq ft = 132												

3-Seat Lounge with Accent Upholstery

COJHLC300	Standard Upholstery	\$4142	\$4182	\$4219	\$4281	\$4473	\$4596	\$4739	\$4840	\$5017	\$5263	\$4269	\$6133	\$6360
	COM/yds = 5½, COL/sq ft = 121													
	Accent Upholstery	No cost	No cost	+\$ 11	+\$ 31	+\$ 92	+\$132	+\$177	+\$209	+\$265	+\$344	+\$219	+\$616	+\$687
	COM/yds = 1¾, COL/sq ft = 39													

► Specification Information, continued on next page

Visalia Lounge *continued*

DESIGN COALESSE DESIGN GROUP

SIN 711.16

► Specification Information, continued from previous page

Specification Information

Lounge Chair

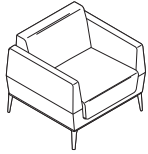

Overall: 29"D 31¾"W 28"H
 Seat height: 16¼"H
 Arm height to the floor: 23"H
 Inside: 19"D 23"W 16¼"H

2-Seat Lounge

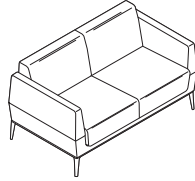

Overall: 29"D 53¾"W 28"H
 Seat height: 16¼"H
 Arm height to the floor: 23"H
 Inside: 19"D 45"W 16¼"H

3-Seat Lounge

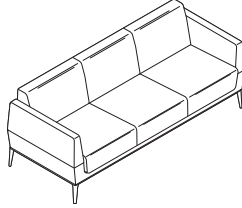

Overall: 29"D 73¾"W 28"H
 Seat height: 16¼"H
 Arm height to the floor: 23"H
 Inside: 19"D 65"W 16¼"H

Ottoman

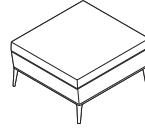

Overall: 29"D 30"W 16¼"H

Bench

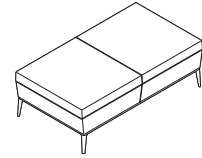

Overall: 29"D 52"W 16¼"H

Style Number	Upholstery	Base Prices										Leather Grades:		
		Fabric Grades:										COL	C	E
		COM	6	7	8	9	10	11	12	13	14			

Ottoman with Single Fabric

COJHB100		\$1221	\$1221	\$1236	\$1262	\$1340	\$1391	\$1450	\$1491	\$1563	\$1664	\$1423	\$1917	\$2000
COM/yds = 2, COL/sq ft = 44														

Ottoman with Accent Upholstery

COJHBC100	Standard Upholstery	\$1273	\$1267	\$1274	\$1285	\$1320	\$1343	\$1368	\$1387	\$1419	\$1464	\$1513	\$1619	\$1661
COM/yds = 1, COL/sq ft = 22														
	Accent Upholstery	+\$ 6	No cost	+\$ 7	+\$ 18	+\$ 53	+\$ 76	+\$101	+\$120	+\$152	+\$197	+\$246	+\$352	+\$394
COM/yds = 1, COL/sq ft = 22														

2-Seat Bench with Single Fabric

COJHB200		\$1782	\$1782	\$1807	\$1850	\$1980	\$2065	\$2163	\$2230	\$2351	\$2519	\$1931	\$2727	\$2840
COM/yds = 3, COL/sq ft = 50														

2-Seat Bench with Accent Upholstery

COJHBC200	Standard Upholstery	\$1811	\$1811	\$1822	\$1842	\$1903	\$1943	\$1988	\$2020	\$2076	\$2155	\$2030	\$2428	\$2499
COM/yds = 1¾, COL/sq ft = 39														
	Accent Upholstery	No cost	No cost	+\$ 8	+\$ 23	+\$ 66	+\$ 94	+\$127	+\$150	+\$190	+\$246	+\$237	+\$445	+\$497
COM/yds = 1, COL/sq ft = 22														

Guest/Side/Stack Seating

Bindu Chairs (SIN 711.18)	176
Bob Chair (SIN 711.18)	177
Capa Chairs (SIN 711.19)	178
Enea Stacker Chairs (SIN 711.19)	180
Enea Bar Stools (SIN 711.18)	184
Enea Café Post Stools (SIN 711.18)	188
Enea Lottus Chairs (SIN 711.19)	192
Enea Lottus Sled Stools (SIN 71.205)	196
Enea Lottus Post Stools (SIN 711.18)	198
Kathryn Chairs (SIN 711.18)	200
Last Minute Stools (SIN 711.18)	202
Lox Stools (SIN 711.18)	203
Switch (SIN 711.18)	204
Montara650 (SIN 711.18)	208
Montara650 Rocker (SIN 711.18)	214
Wrapp Chairs (SIN 711.18)	216

Bindu Chairs

DESIGN BRIAN KANE

SIN 711.18

Tip: Fabrics and leathers will appear loose with comfort wrinkles when upholstered.

Tip: Craft in upholstery cautions the use of stripes and patterns on Bindu. Please use fabric database when specifying.

Tip: For Customer's Own Material or Leather, see necessary requirements, important processing instructions, and ordering information
 ▶ See Coalesse Surface Materials Reference Guide.

Tip: For fabric with large pattern and specific pattern location is desired, contact Customer Service.



Overall: 25"D 24½"W 33¾"H
Inside: 18¾"D 18½"-19½"W 15"H
Seat: 17¾"H
Arm: 26¼"H



Overall: 25"D 24½"W 37¾"H
Inside: 18¾"D 18½"-19½"W 21"H
Seat: 17¾"H
Arm: 26¼"H

Standard Includes

- ▶ Need help? Product details, see *Coalesse Seating and Outdoor Specification Guide*
- Bent plywood frame
- Chair: fabric
- Molded polypropylene foam
- Frame: 4144 Black Gloss
- Glides: black, non-marring

Required to Specify

- 1 Style number
 - 2 Fabric or leather color number for upholstery
 - 3 Options, if selected (see below)
- ▶ See *Surface Materials*, page 260

Options

Surface Materials	Options	Price	Required to Specify
	Acrylic backer		
	• Backer	+\$ 30	Specify with acrylic backer. ▶ See <i>Surface Materials</i> , page 260
Base	• 9207 polished trivalent chrome	+\$151	Specify with 9207 polished trivalent chrome.

Specification Information

Style Number	Base Prices											Leather Grades:		
	Fabric Grades:											COL	C	E
COM	6	7	8	9	10	11	12	13	14					

Low-Back Chair

CO200G	\$1244	\$1244	\$1264	\$1298	\$1402	\$1470	\$1548	\$1602	\$1699	\$1833	\$1419	\$2642	\$2866
--------	--------	--------	--------	--------	--------	--------	--------	--------	--------	--------	--------	--------	--------

COM/yds = 3, COL/sq ft = 66

Mid-Back Chair

CO300G	\$1428	\$1428	\$1448	\$1482	\$1586	\$1654	\$1732	\$1786	\$1883	\$2017	\$1603	\$2826	\$3050
--------	--------	--------	--------	--------	--------	--------	--------	--------	--------	--------	--------	--------	--------

COM/yds = 3, COL/sq ft = 66

Bob Chair by Walter Knoll

DESIGN PEARSON LLOYD

SIN 711.18

Tip: For Customer's Own Material or Leather, see necessary requirements, important processing instructions, and ordering information.
 ▶ Page 262

Tip: Fabrics and leathers will appear loose with comfort wrinkles when upholstered.

Standard Includes		Required to Specify			
▶ Need help? Product details, see <i>Coalesse Seating and Outdoor Specification Guide</i>	<ul style="list-style-type: none"> • Base: 8040 aluminum matte polished • Upholstery for chair: fabric or leather • Glides 	<ol style="list-style-type: none"> 1 Style number 2 Number of fabrics if contrasting fabric style number is selected 3 Fabric or leather color number for upholstery 4 Options, if selected (see below) ▶ See <i>Surface Materials</i> , page 260.			
Options		Price		Required to Specify	
Surface Materials	• Contrasting fabric	+\$121 per fabric		Add suffix K to the style number and select fabric color number.	
	• Fire code seating	+\$237		Specify with fire code seating. ▶ See <i>Fire Code Seating</i> , page 264.	
	Acrylic backer				
	• Guest chair	+\$ 23		Specify with acrylic backer.	
	• Ottoman	+\$ 10		Specify with acrylic backer. ▶ See <i>Surface Materials</i> , page 260.	
Glides	• Felted glides	+\$ 16		Specify with felted glides.	
Related Products	• Bob tables	▶ See <i>GSA Volume 5b Specification Guide</i> .			

Specification Information

Style Number	Base Prices														Leather Grades:		
	Fabric Grades:														COL	C	E
	COM	6	7	8	9	10	11	12	13	14							

Guest Chair

231	\$1961	\$1961	\$1974	\$1997	\$2066	\$2111	\$2164	\$2200	\$2264	\$2353	\$2180	\$3014	\$3167
COM/yds = 2, COL/sq ft = 44													

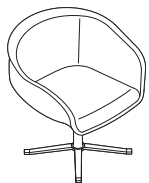

Overall: 25¼"D 27¼"W 29¾"H
 Inside: 18"D 18"W 12½"H
 Seat: 18½"H
 Arm: 26½"H



Overall: 18½"D 19¾"W 15¼"H

Ottoman

221-H	\$ 881	\$ 875	\$ 882	\$ 893	\$ 928	\$ 951	\$ 976	\$ 995	\$1027	\$1072	\$1130	\$1520	\$1596
COM/yds = 1, COL/sq ft = 22													

Guest/Side/Stack Seating

Capa Chairs

DESIGN E00S

SIN 711.19



Overall: 24¾"D 23¾"W 31½"H
 Inside: 18"D 16½"W 15"H
 Seat: 18"H
 Arm: 28"H

Tip: Fabrics and leathers will appear loose with comfort wrinkles when upholstered.

Tip: Frame design allows back to flex to match occupant's back shape.

Tip: Due to the design and construction techniques of the Capa Chair only certain textiles can be successfully applied, therefore all COM fabrics must be submitted to Coalesse for approval prior to order acceptance.

Tip: Recommended leathers are Elmosoft Grade C and Elmorustical Grade E.

Tip: Special color match, consult Customer Service.

Tip: For Customer's Own Material or Leather, see necessary requirements, important processing instructions, and ordering information
 ▶ See Coalesse Surface Materials Reference Guide.

Tip: Chair stacks five high with stacking dolly and three high on floor.

Standard Includes		Required to Specify
▶ Need help? Product details, see <i>Coalesse Seating and Outdoor Specification Guide</i>	<ul style="list-style-type: none"> • Frame: hardwood plywood, steel tubing and bar stock • Arms: solid steel rod and bar stock • Upholstery: arms, back, and seat foam are molded around the frame components • Legs: matte chrome (M) or polished chrome (PC) leg finish 	1 Style number 2 Number of fabrics if contrasting fabric style number is selected 3 Fabric or leather color number for upholstery 4 Options, if selected (see below) ▶ See <i>Coalesse Surface Materials Reference Guide</i> .

Options	Price	Required to Specify
Surface Materials	<ul style="list-style-type: none"> • Contrasting fabric +\$121 per fabric 	Add suffix K to the style number and select fabric color number.
Acrylic backer	<ul style="list-style-type: none"> • Backer +\$ 17 	Specify with acrylic backer. ▶ See <i>Coalesse Surface Materials Reference Guide</i> .

Specification Information														
Style Number	Base Prices												Leather Grades:	
	Fabric Grades:												COL	C
	COM	6	7	8	9	10	11	12	13	14				

Chairs

1810M	\$1141	\$1141	\$1154	\$1177	\$1246	\$1291	\$1344	\$1380	\$1444	\$1533	\$1412	\$2424	\$2610
1810PC	\$1170	\$1170	\$1183	\$1206	\$1275	\$1320	\$1373	\$1409	\$1473	\$1562	\$1441	\$2458	\$2639

COM/yds = 2, COL/sq ft = 44

Stacking Dolly

9014S	\$ 768	N.A.	N.A.	N.A.	N.A.	N.A.	N.A.	N.A.	N.A.	N.A.	N.A.	N.A.	N.A.
-------	--------	------	------	------	------	------	------	------	------	------	------	------	------

Coalesse

Capa Chairs

DESIGN E00S

SIN 711.19

Enea Stacker Chairs With Arms

DESIGN JACOB LLUSCA

SIN 711.19

Tip: Due to the design and construction techniques of the Enea Chair only certain textiles can be successfully applied, therefore all COM fabrics must be submitted to Coalesse for approval prior to order acceptance.

Tip: Fabrics and leathers will appear loose with comfort wrinkles when upholstered.

Tip: For Customer's Own Material or Leather, see necessary requirements, important processing instructions, and ordering information.

► Page 262

Tip: Contrasting fabric option available on model 3501 only.

Tip: Need sketch for ganging.

Tip: Tablet is 11"D x 9"W.

Tip: Arm chairs stack nine high. Arm chair with tablet stacks six high.

Standard Includes

- Need help? Product details, see *Coalesse Seating and Outdoor Specification Guide*
- Frame: constructed of steel tubing
- Seat and back: molded nylon, wood, or upholstery (wood is laminated layers of hard maple veneer)

Required to Specify

- 1 Style number
 - 2 Fabric or leather color number for upholstery, if selected
 - 3 Plastic or wood finish color number for seat and back, if selected
 - 4 Base/frame finish: black gloss, white gloss, or silver metallic
 - 5 Options, if selected (see below)
- See *Surface Materials*, page 260.

Options

Options	Price	Required to Specify
Surface Materials	• Contrasting fabric	+\$121 per fabric
	Acrylic backer	
	• Chair with upholstered seat and back	+\$ 17
	• Chair with upholstered seat and wood back	+\$ 8
Ganging	• Ganging	+\$ 66
Tablet	• Black powder coat	+\$343
Related Products	• Café and conference tables	► Page 230 and 231

Specification Information

Style Number	Base Prices											Leather Grades:		
	Fabric Grades:											COL	C	E
	COM	6	7	8	9	10	11	12	13	14				

Wood Seat and Back Stacker Chair

3500	\$949	N.A.	N.A.	N.A.	N.A.	N.A.	N.A.	N.A.	N.A.	N.A.	N.A.	N.A.	N.A.
------	-------	------	------	------	------	------	------	------	------	------	------	------	------



Overall: 22½"D 22½"W 33¼"H
 Inside: 18"D 18"W 15¼"H
 Seat: 18"H
 Arm: 26¾"H

Upholstered Seat and Back Chair

3501	\$888	\$888	\$899	\$916	\$968	\$1002	\$1041	\$1069	\$1117	\$1183	\$1154	\$1365	\$1498
------	-------	-------	-------	-------	-------	--------	--------	--------	--------	--------	--------	--------	--------

COM/yds = 1, COL/sq ft = 22

► Specification Information, continued on next page



Overall: 22½"D 22½"W 33¼"H
 Inside: 18"D 18"W 15¼"H
 Seat: 18"H
 Arm: 26¾"H

Enea Stacker Chairs With Arms

DESIGN JACOB LLUSCA

SIN 711.19

► Specification Information, continued from previous page

Specification Information

Style Number	Base Prices											Leather Grades:		
	Fabric Grades:											COL	C	E
	COM	6	7	8	9	10	11	12	13	14				

Upholstered Seat and Wood Back Chair

3502	\$952	\$938	\$943	\$951	\$977	\$994	\$1014	\$1027	\$1051	\$1085	\$1229	\$1325	\$1398
------	-------	-------	-------	-------	-------	-------	--------	--------	--------	--------	--------	--------	--------

COM/yds = 3/4, COL/sq ft = 17



Overall: 22½"D 22½"W 33¼"H
 Inside: 18"D 18"W 15¼"H
 Seat: 18"H
 Arm: 26¾"H

Polypropylene Seat and Back Chair

3503	\$548	N.A.	N.A.	N.A.	N.A.	N.A.	N.A.	N.A.	N.A.	N.A.	N.A.	N.A.	N.A.
------	-------	------	------	------	------	------	------	------	------	------	------	------	------



Overall: 22½"D 22½"W 33¼"H
 Inside: 18"D 18"W 15¼"H
 Seat: 18"H
 Arm: 26¾"H

Stacking Dolly

9014S	\$768	N.A.	N.A.	N.A.	N.A.	N.A.	N.A.	N.A.	N.A.	N.A.	N.A.	N.A.	N.A.
-------	-------	------	------	------	------	------	------	------	------	------	------	------	------

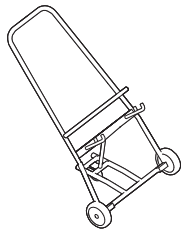

Overall: 34"D 26"W 34"H

Guest/ Side/Stack Seating

Enea Stacker Chairs Without Arms

DESIGN JACOB LLUSCA

SIN 711.19

Tip: Due to the design and construction techniques of the Enea Chair only certain textiles can be successfully applied, therefore all COM fabrics must be submitted to Coalesse for approval prior to order acceptance.

Tip: Pricing based on highest grade textiles specified.

Tip: Armless chairs stack nine high.

Tip: Fabrics and leathers will appear loose with comfort wrinkles when upholstered.

Tip: For Customer's Own Material or Leather, see necessary requirements, important processing instructions, and ordering information.
▶ Page 262

Tip: Contrasting fabric option available on model 3501S only.

Tip: No tablet or ganging available on armless models.



Overall: 22½"D 18"W 33¼"H
Inside: 18"D 18"W 15¼"H
Seat: 18"H



Overall: 22½"D 18"W 33¼"H
Inside: 18"D 18"W 15¼"H
Seat: 18"H

Standard Includes

- ▶ Need help? Product details, see *Coalesse Seating and Outdoor Specification Guide*
- Frame: steel tubing
- Seat and back: molded nylon, wood, or upholstery (wood is laminated layers of hard maple veneer)

Required to Specify

- 1 Style number
 - 2 Fabric or leather color number for upholstery, if selected
 - 3 Plastic or wood finish color number for seat and back, if selected
 - 4 Base/frame finish: black gloss, white gloss, or silver metallic
 - 5 Options, if selected (see below)
- ▶ See *Surface Materials*, page 260.

Options

Options	Price	Required to Specify
Surface Materials	• Contrasting fabric	+ \$121 per fabric
	Acrylic backer	
	• Chair with upholstered seat and back	+ \$ 17
	• Chair with upholstered seat and wood back	+ \$ 8
Related Products	• Café and conference tables	▶ Pages 230 and 232

Specification Information

Style Number	Base Prices											Leather Grades:		
	Fabric Grades:											COL	C	E
	COM	6	7	8	9	10	11	12	13	14				

Wood Seat and Back Chair

3500S	\$836	N.A.	N.A.	N.A.	N.A.	N.A.	N.A.	N.A.	N.A.	N.A.	N.A.	N.A.	N.A.
-------	-------	------	------	------	------	------	------	------	------	------	------	------	------

Upholstered Seat and Back Chair

3501S	\$774	\$774	\$782	\$797	\$840	\$868	\$901	\$924	\$964	\$1020	\$1040	\$1263	\$1387
-------	-------	-------	-------	-------	-------	-------	-------	-------	-------	--------	--------	--------	--------

COM/yds = 1, COL/sq ft = 22

▶ Specification Information, continued on next page

Enea Stacker Chairs Without Arms

DESIGN JACOB LLUSCA

SIN 711.19

► Specification Information, continued from previous page

Specification Information

Style Number	Base Prices											Leather Grades:		
	Fabric Grades:											COL	C	E
	COM	6	7	8	9	10	11	12	13	14				

Upholstered Seat and Wood Back Chair

3502S	\$839	\$825	\$830	\$838	\$864	\$881	\$901	\$914	\$938	\$972	\$1122	\$1206	\$1285
-------	-------	-------	-------	-------	-------	-------	-------	-------	-------	-------	--------	--------	--------

COM/yds = 3/4, COL/sq ft = 17



Overall: 22½"D 18"W 33¼"H
 Inside: 18"D 18"W 15¼"H
 Seat: 18"H

Polypropylene Seat and Back Chair

3503S	\$509	N.A.	N.A.	N.A.	N.A.	N.A.	N.A.	N.A.	N.A.	N.A.	N.A.	N.A.	N.A.
-------	-------	------	------	------	------	------	------	------	------	------	------	------	------



Overall: 22½"D 18"W 33¼"H
 Inside: 18"D 18"W 15¼"H
 Seat: 18"H

Stacking Dolly

9014S	\$768	N.A.	N.A.	N.A.	N.A.	N.A.	N.A.	N.A.	N.A.	N.A.	N.A.	N.A.	N.A.
-------	-------	------	------	------	------	------	------	------	------	------	------	------	------

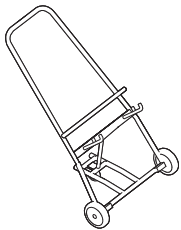

Overall: 34"D 26"W 34"H

Guest/ Side/Stack Seating

Enea Bar Stools Bar-Height with Arms

DESIGN JACOB LLUSCA

SIN 711.18

Tip: Due to the design and construction techniques of the Enea Barstool only certain textiles can be successfully applied, therefore all COM fabrics must be submitted to Coalesse for approval prior to order acceptance.

Tip: Pricing based on highest grade textile specified.

Tip: Fabrics and leathers will appear loose with comfort wrinkles when upholstered.

Tip: For Customer's Own Material or Leather, see necessary requirements, important processing instructions, and ordering information.
▶ Page 262

Tip: Contrasting fabric option available on model 3511 only.

Standard Includes

- ▶ Need help? Product details, see *Coalesse Seating and Outdoor Specification Guide*
- Constructed of steel tubing with cast aluminum arms
- Seat and back: polypropylene, wood, or upholstery (wood is laminated layers of hard maple veneer)
- Footrest with leg stretchers: chrome-plated

Required to Specify

- 1 Style number
 - 2 Number of fabrics if contrasting fabric style number is selected
 - 3 Fabric or leather color number for upholstery, if selected
 - 4 Plastic or wood finish color number for seat and back, if selected
 - 5 Base/frame finish: black gloss, white gloss, or silver metallic
 - 6 Options, if selected (see below)
- ▶ See *Surface Materials*, page 260.

Options

Options	Price	Required to Specify
Surface Materials		
• Contrasting fabric	+\$121 per fabric	Add suffix K to the style number and select fabric color number.
Acrylic backer		
• Chair with upholstered seat and back	+\$ 12	Specify with <i>acrylic backer</i> .
• Chair with upholstered seat and wood back	+\$ 6	Specify with <i>acrylic backer</i> . ▶ See <i>Surface Materials</i> , page 260.
Related Products	• Café and conference tables	▶ Pages 230 and 232

Specification Information

Style Number	Base Prices										Leather Grades:		
	COM	6	7	8	9	10	11	12	13	14	COL	C	E

Wood Seat and Back

3510	\$1031	N.A.	N.A.	N.A.	N.A.	N.A.	N.A.	N.A.	N.A.	N.A.	N.A.	N.A.	N.A.
------	--------	------	------	------	------	------	------	------	------	------	------	------	------

Upholstered Seat and Back

3511	\$ 970	\$970	\$981	\$998	\$1050	\$1084	\$1123	\$1151	\$1199	\$1265	\$1249	\$1473	\$1610
------	--------	-------	-------	-------	--------	--------	--------	--------	--------	--------	--------	--------	--------

COM/yds = 1, COL/sq ft = 22
 ▶ Specification Information, continued on next page

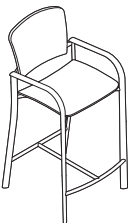

Overall: 24¾"D 22¼"W 45½"H
Inside: 18½"D 17¾"W 15¼"H
Seat: 30½"H
Arm: 39¼"H

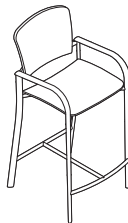

Overall: 24¾"D 22¼"W 45½"H
Inside: 18½"D 17¾"W 15¼"H
Seat: 30½"H
Arm: 39¼"H

Enea Bar Stools Bar-Height with Arms

DESIGN JACOB LLUSCA

SIN 711.18

► Specification Information, continued from previous page

Specification Information

Style Number	Base Prices										Leather Grades:		
	Fabric Grades:										14	COL	C
	COM	6	7	8	9	10	11	12	13				

Upholstered Seat and Wood Back

3512	\$1041	\$1027	\$1032	\$1040	\$1066	\$1083	\$1103	\$1116	\$1140	\$1174	\$1326	\$1435	\$1514
------	--------	--------	--------	--------	--------	--------	--------	--------	--------	--------	--------	--------	--------

COM/yds = ¾, COL/sq ft = 17

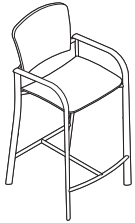

Overall: 24¾"D 22¼"W 45½"H
 Inside: 18½"D 17¾"W 15¼"H
 Seat: 30½"H
 Arm: 39¼"H

Polypropylene Seat and Back

3513	\$ 707	N.A.	N.A.	N.A.	N.A.	N.A.	N.A.	N.A.	N.A.	N.A.	N.A.	N.A.	N.A.
------	--------	------	------	------	------	------	------	------	------	------	------	------	------

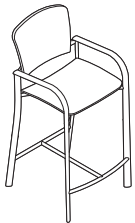

Overall: 24¾"D 22¼"W 45½"H
 Inside: 18½"D 17¾"W 15¼"H
 Seat: 30½"H
 Arm: 39¼"H

Guest/ Side/Stack Seating

Enea Bar Stools Bar-Height without Arms

DESIGN JACOB LLUSCA

SIN 711.18

Tip: Due to the design and construction techniques of the Enea Barstool only certain textiles can be successfully applied, therefore all COM fabrics must be submitted to Coalesse for approval prior to order acceptance.

Tip: Pricing based on highest grade textile specified.

Tip: For Customer's Own Material or Leather, see necessary requirements, important processing instructions, and ordering information.
▶ Page 262

Tip: Fabrics and leathers will appear loose with comfort wrinkles when upholstered.

Tip: Contrasting fabric option available on model 3511S only.

Standard Includes

- ▶ Need help? Product details, see *Coalesse Seating and Outdoor Specification Guide*
- Base/frame: steel tubing and base with non-skid strip
- Seat and back: molded polypropylene, wood, or upholstery (wood is laminated layers of hard maple veneer)
- Footrest: polished aluminum
- Upholstered seat / back: Laminations of multiple density polyurethane foam and polyester fiber

Required to Specify

- 1 Style number
 - 2 Number of fabrics if contrasting fabric style number is selected
 - 3 Fabric or leather color number for upholstery, if selected
 - 4 Plastic or wood finish color number for seat and back, if selected
 - 5 Base/frame finish: black gloss, white gloss, or silver metallic
 - 6 Options, if selected (see below)
- ▶ See *Surface Materials*, page 260.

Options

Options	Price	Required to Specify
Surface Materials		
• Contrasting fabric	+\$121 per fabric	Add suffix K to the style number and select fabric color number.
Acrylic backer		
• Chair with upholstered seat and back	+\$ 12	Specify with <i>acrylic backer</i> .
• Chair with upholstered seat and wood back	+\$ 6	Specify with <i>acrylic backer</i> . ▶ See <i>Surface Materials</i> , page 260.

Related Products • Café and conference tables ▶ Pages 230 and 232

Specification Information

Style Number	Base Prices											Leather Grades:		
	Fabric Grades:											COL	C	E
	COM	6	7	8	9	10	11	12	13	14				

Wood Seat and Back

3510S	\$1000	N.A.	N.A.	N.A.	N.A.	N.A.	N.A.	N.A.	N.A.	N.A.	N.A.	N.A.	N.A.
-------	--------	------	------	------	------	------	------	------	------	------	------	------	------

Upholstered Seat and Back

3511S	\$ 893	\$893	\$904	\$921	\$973	\$1007	\$1046	\$1074	\$1122	\$1188	\$1177	\$1402	\$1540
-------	--------	-------	-------	-------	-------	--------	--------	--------	--------	--------	--------	--------	--------

COM/yds = 1, COL/sq ft = 22
▶ Specification Information, continued on next page

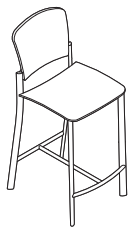

Overall: 25"D 18½"W 45¾"H
Inside: 18½"D 17¾"W 15¼"H
Seat: 30½"H

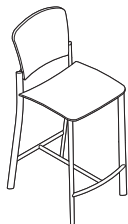

Overall: 25"D 18½"W 45¾"H
Inside: 18½"D 17¾"W 15¼"H
Seat: 30½"H

Enea Bar Stools Bar-Height without Arms

DESIGN JACOB LLUSCA

SIN 711.18

► Specification Information, continued from previous page

Specification Information

Style Number	Base Prices											Leather Grades:		
	Fabric Grades:											COL	C	E
	COM	6	7	8	9	10	11	12	13	14				

Upholstered Seat and Wood Back

3512S	\$959	\$945	\$950	\$958	\$984	\$1001	\$1021	\$1034	\$1058	\$1092	\$1249	\$1347	\$1424
-------	-------	-------	-------	-------	-------	--------	--------	--------	--------	--------	--------	--------	--------

COM/yds = 3/4, COL/sq ft = 17

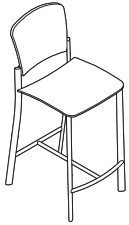

Overall: 25"D 18½"W 45¾"H
 Inside: 18½"D 17¾"W 15¼"H
 Seat: 30½"H

Polypropylene Seat and Back

3513S	\$613	N.A.	N.A.	N.A.	N.A.	N.A.	N.A.	N.A.	N.A.	N.A.	N.A.	N.A.	N.A.
-------	-------	------	------	------	------	------	------	------	------	------	------	------	------

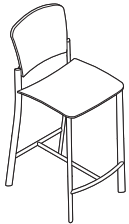

Overall: 25"D 18½"W 45¾"H
 Inside: 18½"D 17¾"W 15¼"H
 Seat: 30½"H

Guest/ Side/Stack Seating

Enea Café Post Stools Café with Back

DESIGN JACOB LLUSCA

SIN 711.18

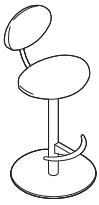

Tip: For Customer's Own Material or Leather, see necessary requirements, important processing instructions, and ordering information.

► Page 262

Tip: Fabrics and leathers will appear loose with comfort wrinkles when upholstered.

Standard Includes	Required to Specify
-------------------	---------------------

- | | | |
|---|--|--|
| <ul style="list-style-type: none"> ► Need help? Product details, see <i>Coalesse Seating and Outdoor Specification Guide</i> | <ul style="list-style-type: none"> • Base/frame: steel tubing and base with non-skid strip • Seat and back: molded polypropylene, wood, or upholstery (wood is laminated layers of hard maple veneer) • Footrest: polished aluminum • Upholstered seat/back: Laminations of multiple density polyurethane foam and polyester fiber | <ol style="list-style-type: none"> 1 Style number 2 Number of fabrics if contrasting fabric style number is selected 3 Fabric or leather color number for upholstery, if selected 4 Plastic or wood finish color number for seat and back, if selected 5 Base/frame finish: black gloss, white gloss, or silver metallic 6 Options, if selected (see below) <p>► See <i>Surface Materials</i>, page 260.</p> |
|---|--|--|

Options	Price	Required to Specify
---------	-------	---------------------

Surface Materials	<ul style="list-style-type: none"> • Contrasting fabric +\$121 per fabric 	Add suffix K to the style number and select fabric color number.
	<p>Acrylic backer</p> <ul style="list-style-type: none"> • Stool with upholstered seat and back +\$ 6 • Backer for stool with upholstered seat and wood back +\$ 4 	<p>Specify with acrylic backer.</p> <p>Specify with acrylic backer.</p> <p>► See <i>Surface Materials</i>, page 260.</p>
Related Products	<ul style="list-style-type: none"> • Café and conference tables 	► Pages 230 and 232

Enea Café Post Stools Café with Back

DESIGN JACOB LLUSCA

SIN 711.18

Specification Information

Style Number	Base Prices														Leather Grades:			Wood	Poly-Propylene
	Fabric Grades:														COL	C	E		
	COM	6	7	8	9	10	11	12	13	14									

Café Counter-Height Stools, 19" Base

Upholstered Seat and Back

H351-SB2719	\$1084	\$1070	\$1075	\$1083	\$1109	\$1126	\$1146	\$1159	\$1183	\$1217	\$1342	\$1569	\$1622	N.A.	N.A.
-------------	--------	--------	--------	--------	--------	--------	--------	--------	--------	--------	--------	--------	--------	------	------

COM/yds = 3/4, COL/sq ft = 13 1/2

Upholstered Seat with Wood Back

H352-SB2719	\$1143	\$1121	\$1125	\$1132	\$1150	\$1162	\$1177	\$1187	\$1205	\$1229	\$1401	\$1555	\$1591	N.A.	N.A.
-------------	--------	--------	--------	--------	--------	--------	--------	--------	--------	--------	--------	--------	--------	------	------

COM/yds = 5/9, COL/sq ft = 10

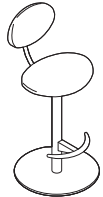

Overall: 19"D 19"W 38 1/4"H
 Inside: 14 1/4"D 17"W 12 5/8"H
 Seat: 25 5/8"H



Overall: 19"D 19"W 42 1/4"H
 Inside: 14 1/4"D 17"W 12 5/8"H
 Seat: 29 5/8"H

Café Bar-Height Stools, 19" Base

Upholstered Seat and Back

H351-SB3119	\$1090	\$1076	\$1081	\$1089	\$1115	\$1132	\$1152	\$1165	\$1189	\$1223	\$1348	\$1575	\$1628	N.A.	N.A.
-------------	--------	--------	--------	--------	--------	--------	--------	--------	--------	--------	--------	--------	--------	------	------

COM/yds = 3/4, COL/sq ft = 13 1/2

Upholstered Seat with Wood Back

H352-SB3119	\$1149	\$1127	\$1131	\$1138	\$1156	\$1168	\$1183	\$1193	\$1211	\$1235	\$1407	\$1561	\$1603	N.A.	N.A.
-------------	--------	--------	--------	--------	--------	--------	--------	--------	--------	--------	--------	--------	--------	------	------

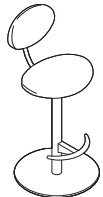

Overall: 19"D 19"W 38 1/4"H
 Inside: 14 1/4"D 17"W 12 5/8"H
 Seat: 25 5/8"H

Café Counter-Height Stools, 19" Base

Wood Seat and Back

H350-SB2719	N.A.	N.A.	N.A.	N.A.	N.A.	N.A.	N.A.	N.A.	N.A.	N.A.	N.A.	N.A.	N.A.	\$1167	N.A.
-------------	------	------	------	------	------	------	------	------	------	------	------	------	------	--------	------

Polypropylene Seat and Back

H353-SB2719	N.A.	N.A.	N.A.	N.A.	N.A.	N.A.	N.A.	N.A.	N.A.	N.A.	N.A.	N.A.	N.A.	N.A.	\$877
-------------	------	------	------	------	------	------	------	------	------	------	------	------	------	------	-------



Overall: 19"D 19"W 42 1/4"H
 Inside: 14 1/4"D 17"W 12 5/8"H
 Seat: 29 5/8"H

Café Bar-Height Stools, 19" Base

Wood Seat and Back

H350-SB3119	N.A.	N.A.	N.A.	N.A.	N.A.	N.A.	N.A.	N.A.	N.A.	N.A.	N.A.	N.A.	N.A.	\$1176	N.A.
-------------	------	------	------	------	------	------	------	------	------	------	------	------	------	--------	------

Polypropylene Seat and Back

H353-SB3119	N.A.	N.A.	N.A.	N.A.	N.A.	N.A.	N.A.	N.A.	N.A.	N.A.	N.A.	N.A.	N.A.	N.A.	\$884
-------------	------	------	------	------	------	------	------	------	------	------	------	------	------	------	-------

Guest/ Side/Stack Seating

Enea Café Post Stools

DESIGN JACOB LLUSCA

SIN 711.18

Tip: Due to the design and construction techniques of the Enea Barstool only certain textiles can be successfully applied, therefore all COM fabrics must be submitted to Coalesse for approval prior to order acceptance.

Tip: Recommended leathers are Elmosoft Grade C and Elmorustical Grade E.

Tip: Special color match, consult Customer Service.

Tip: For Customer's Own Material or Leather, see necessary requirements, important processing instructions, and ordering information.
 ▶ Page 262

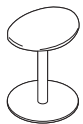

Overall: 14½"D 17"W 19¼"H
 Seat: 17⅝"H



Overall: 14½"D 17"W 27¼"H
 Seat: 25⅝"H

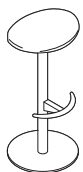

Overall: 14½"D 17"W 31¼"H
 Seat: 29⅝"H

Standard Includes

- ▶ Need help? Product details, see *Coalesse Seating and Outdoor Specification Guide*
- Base/frame: steel tubing and base with non-skid strip
- Seat: molded polypropylene, wood, or upholstery (wood is laminated layers of hard maple veneer)
- Footrest: polished aluminum
- Upholstered seat/back: Laminations of multiple density polyurethane foam and polyester fiber

Required to Specify

- 1 Style number
 - 2 Plastic or wood finish color number for seat
 - 3 Fabric or leather color number for upholstery
 - 4 Base/frame finish: black gloss, white gloss, or silver metallic
 - 5 Options, if selected (see below)
- ▶ See *Surface Materials*, page 260.

Options

Surface Material	Options	Price	Required to Specify
	Acrylic backer	+\$4	
	• Backer		Specify with acrylic backer. ▶ See <i>Surface Materials</i> , page 260.

Related Products	Options	Required to Specify
	• Café and conference tables	▶ Pages 230 and 232

Specification Information

Style Number	Base Prices												Leather Grades:			
	Fabric Grades:												COL	C	E	
	COM	6	7	8	9	10	11	12	13	14						

Low Stool with Upholstered Seat

H352-S19	\$847	\$825	\$829	\$836	\$854	\$866	\$881	\$891	\$909	\$ 933	\$991	\$1176	\$1218
COM/yds = ⅝, COL/sq ft = 10													

Café Counter-Height Stool with Upholstered Seat

H352-S27	\$882	\$860	\$864	\$871	\$889	\$901	\$916	\$926	\$944	\$ 968	\$1033	\$1217	\$1253
COM/yds = ⅝, COL/sq ft = 10													

Café Bar-Height Stool with Upholstered Seat

H352-S31	\$921	\$899	\$903	\$910	\$928	\$940	\$955	\$965	\$983	\$1007	\$1065	\$1250	\$1292
COM/yds = ⅝, COL/sq ft = 10													

▶ Specification Information, continued on next page

Enea Café Post Stools

DESIGN JACOB LLUSCA

SIN 711.18

► Specification Information, continued from previous page

Specification Information

Style Number	Base Prices														Leather Grades:			Wood	Poly-Propylene
	Fabric Grades:														COL	C	E		
	COM	6	7	8	9	10	11	12	13	14									

Low Stool

Wood Seat

H350-S19	N.A.	N.A.	N.A.	N.A.	N.A.	N.A.	N.A.	N.A.	N.A.	N.A.	N.A.	N.A.	N.A.	N.A.	\$768	N.A.
----------	------	------	------	------	------	------	------	------	------	------	------	------	------	------	-------	------

Polypropylene Seat

H353-S19	N.A.	N.A.	N.A.	N.A.	N.A.	N.A.	N.A.	N.A.	N.A.	N.A.	N.A.	N.A.	N.A.	N.A.	N.A.	\$603
----------	------	------	------	------	------	------	------	------	------	------	------	------	------	------	------	-------

Café Counter-Height Stool

Wood Seat

H350-S27	N.A.	N.A.	N.A.	N.A.	N.A.	N.A.	N.A.	N.A.	N.A.	N.A.	N.A.	N.A.	N.A.	N.A.	\$806	N.A.
----------	------	------	------	------	------	------	------	------	------	------	------	------	------	------	-------	------

Polypropylene Seat

H353-S27	N.A.	N.A.	N.A.	N.A.	N.A.	N.A.	N.A.	N.A.	N.A.	N.A.	N.A.	N.A.	N.A.	N.A.	N.A.	\$669
----------	------	------	------	------	------	------	------	------	------	------	------	------	------	------	------	-------

Café Bar-Height Stool

Wood Seat

H350-S31	N.A.	N.A.	N.A.	N.A.	N.A.	N.A.	N.A.	N.A.	N.A.	N.A.	N.A.	N.A.	N.A.	N.A.	\$841	N.A.
----------	------	------	------	------	------	------	------	------	------	------	------	------	------	------	-------	------

Polypropylene Seat

H353-S31	N.A.	N.A.	N.A.	N.A.	N.A.	N.A.	N.A.	N.A.	N.A.	N.A.	N.A.	N.A.	N.A.	N.A.	N.A.	\$729
----------	------	------	------	------	------	------	------	------	------	------	------	------	------	------	------	-------

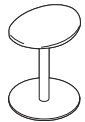

Overall: 14½"D 17"W 19¼"H
Seat: 17½"H



Overall: 14½"D 17"W 27¼"H
Seat: 25½"H

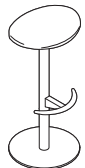

Overall: 14½"D 17"W 31¼"H
Seat: 29½"H

Guest/Side/Stack Seating

Enea Lottus Chairs Armless

DESIGN LIEVORE ALTHERR MOLINA

SIN 711.19

Tip: For Customer's Own Material or Leather, see necessary requirements, important processing instructions, and ordering information.
 ▶Page 262

Standard Includes		Required to Specify
▶Need help? Product details, see <i>Coalesse Seating and Outdoor Specification Guide</i>	<ul style="list-style-type: none"> • Base and frame constructed of steel tubing • Seat and back: polypropylene • Insert, if selected: polypropylene or upholstery 	1 Style number 2 Plastic color number for seat and back 3 Fabric or leather color number for upholstery insert, if selected 4 Paint color number for base and frame 5 Options, if selected (see below) ▶See <i>Surface Materials</i> , page 260.

Options	Price	Required to Specify
Surface Acrylic backer • Chair with upholstered insert	+\$6	Specify with acrylic backer. ▶See <i>Surface Materials</i> , page 260.
Felt Glides • Glides	No cost	Specify with felt glides.
Related Products • Café and conference tables		▶Pages 230 and 236

Specification Information

Style Number	Base Prices													Leather Grades:			Polypropylene
	Fabric Grades:													COL	C	E	
COM	6	7	8	9	10	11	12	13	14								

Tip: Lottus chair with no insert stacks 10 high on floor. Lottus chair with polypropylene or upholstered insert stacks four high on floor. Lottus chairs stack six high with dolly.



Overall: 20¾"D 20¾"W 30½"H
 Seat: 18"H

Armless Chair with No Insert

COEL100	\$358	N.A.	N.A.	N.A.	N.A.	N.A.	N.A.	N.A.	N.A.	N.A.	N.A.	N.A.	N.A.	N.A.
---------	-------	------	------	------	------	------	------	------	------	------	------	------	------	------



Overall: 20¾"D 20¾"W 30½"H
 Seat: 18"H

Armless Chair with Polypropylene Insert

COEL100INSERT	N.A.	N.A.	N.A.	N.A.	N.A.	N.A.	N.A.	N.A.	N.A.	N.A.	N.A.	N.A.	N.A.	N.A.	\$400
---------------	------	------	------	------	------	------	------	------	------	------	------	------	------	------	-------



Overall: 20¾"D 20¾"W 30½"H
 Seat: 18"H

Armless Chair with Upholstered Insert

COEL100UPH	\$536	\$522	\$527	\$535	\$561	\$578	\$598	\$611	\$635	\$669	\$762	\$774	\$804	N.A.
------------	-------	-------	-------	-------	-------	-------	-------	-------	-------	-------	-------	-------	-------	------

COM/yds = ¾, COL/sq ft = 15

▶Specification Information, continued on next page

Coalesse

Enea Lottus Chairs Armless

DESIGN LIEVORE ALTHERR MOLINA

SIN 711.19

► Specification Information, continued from previous page

Specification Information

Style Number	Price
-----------------	-------

Stacking Dolly

COELDOLLY	\$753
-----------	-------

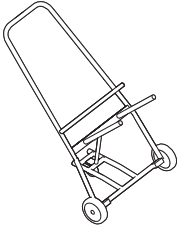

Overall: 27"D 25"W 46"H

Tip: Dolly can be used with any Enea Lottus chair.

Tip: Armless chairs, cantilever arm chairs, and loop arm chairs stack six high on dolly.

Guest/Side/Stack
Seating

Enea Lottus Chairs Cantilever Arm

DESIGN LIEVORE ALTHERR MOLINA

SIN 711.19

Tip: Cantilever arm can hook on table to provide storing option.

Tip: Cantilever arm stacks six high.

Tip: Can specify arm cap in any plastic color for Lottus.

Tip: For Customer's Own Material or Leather, see necessary requirements, important processing instructions, and ordering information.
▶Page 262

Standard Includes		Required to Specify
-------------------	--	---------------------

▶Need help? Product details, see <i>Coalesse Seating and Outdoor Specification Guide</i>	<ul style="list-style-type: none"> • Base and frame constructed of steel tubing • Seat and back: polypropylene • Arm cap: polypropylene • Insert, if selected: polypropylene or upholstery 	<ol style="list-style-type: none"> 1 Style number 2 Plastic color number for seat, back, and arm cap 3 Fabric or leather color number for upholstery insert, if selected 4 Paint color number for base and frame 5 Options, if selected (see below) ▶See <i>Surface Materials</i> , page 260.
---	--	--

Options	Price	Required to Specify
---------	-------	---------------------

Surface Materials	Acrylic backer <ul style="list-style-type: none"> • Chair with upholstered insert 	+\$6 Specify with <i>acrylic backer</i> . ▶See <i>Surface Materials</i> , page 260.
Felt Glides	<ul style="list-style-type: none"> • Glides 	No cost Specify with <i>felt glides</i> .
Related Products	<ul style="list-style-type: none"> • Café and conference tables 	▶Pages 230 and 236

Specification Information

Style Number	Base Prices														Leather Grades:			Polypropylene
	Fabric Grades:														COL	C	E	
	COM	6	7	8	9	10	11	12	13	14								

Cantilever Arm Chair with No Insert

COEL200	\$442	N.A.	N.A.	N.A.	N.A.	N.A.	N.A.	N.A.	N.A.	N.A.	N.A.	N.A.	N.A.	N.A.	N.A.	N.A.	N.A.
---------	-------	------	------	------	------	------	------	------	------	------	------	------	------	------	------	------	------



Overall: 20¾"D 23¾"W 30½"H
Seat: 18"H
Arm: 26"H

Cantilever Arm Chair with Polypropylene Insert

COEL200INSERT	N.A.	N.A.	N.A.	N.A.	N.A.	N.A.	N.A.	N.A.	N.A.	N.A.	N.A.	N.A.	N.A.	N.A.	N.A.	N.A.	\$483
---------------	------	------	------	------	------	------	------	------	------	------	------	------	------	------	------	------	-------



Overall: 20¾"D 23¾"W 30½"H
Seat: 18"H
Arm: 26"H

Cantilever Arm Chair with Upholstered Insert

COEL200UPH	\$617	\$603	\$608	\$616	\$642	\$659	\$679	\$692	\$716	\$750	\$843	\$855	\$885	N.A.
------------	-------	-------	-------	-------	-------	-------	-------	-------	-------	-------	-------	-------	-------	------

COM/yds = ¾, COL/sq ft = 15



Overall: 20¾"D 23¾"W 30½"H
Seat: 18"H
Arm: 26"H

Enea Lottus Chairs Aluminum Loop Arm

DESIGN LIEVORE ALTHERR MOLINA

SIN 711.19

Tip: Arm chair stacks six high.

Tip: For Customer's Own Material or Leather, see necessary requirements, important processing instructions, and ordering information.

▶ Page 262

Standard Includes		Required to Specify
▶ Need help? Product details, see <i>Coalesse Seating and Outdoor Specification Guide</i>	<ul style="list-style-type: none"> • Base and frame constructed of steel tubing • Seat and back: polypropylene • Arm: aluminum • Insert, if selected: polypropylene or upholstery 	<ol style="list-style-type: none"> 1 Style number 2 Plastic color number for seat, back, and arm cap 3 Fabric or leather color number for upholstery insert, if selected 4 Paint color number for base and frame 5 Options, if selected (see below) ▶ See <i>Surface Materials</i> , page 260.

Options	Price	Required to Specify
Surface Materials • Acrylic backer • Chair with upholstered insert	+\$6	Specify with acrylic backer. ▶ See <i>Surface Materials</i> , page 260.
Felt Glides • Glides	No cost	Specify with felt glides.
Related Products • Café and conference tables		▶ Pages 230 and 236

Specification Information														
Style Number	Base Prices													
	Fabric Grades:										Leather Grades:		Poly-propylene	
	COM	6	7	8	9	10	11	12	13	14	COL	C	E	

Aluminum Loop Arm Chair with No Insert

COEL300	\$477	N.A.	N.A.	N.A.	N.A.	N.A.	N.A.	N.A.	N.A.	N.A.	N.A.	N.A.	N.A.	N.A.
---------	-------	------	------	------	------	------	------	------	------	------	------	------	------	------



Overall: 20³/₄"D 22"W 30¹/₂"H
Seat: 18"H
Arm: 26"H

Aluminum Loop Arm Chair with Polypropylene Insert

COEL300INSERT	N.A.	N.A.	N.A.	N.A.	N.A.	N.A.	N.A.	N.A.	N.A.	N.A.	N.A.	N.A.	N.A.	N.A.	\$518
---------------	------	------	------	------	------	------	------	------	------	------	------	------	------	------	-------



Overall: 20³/₄"D 22"W 30¹/₂"H
Seat: 18"H
Arm: 26"H

Aluminum Loop Arm Chair with Upholstered Insert

COEL300UPH	\$653	\$639	\$644	\$652	\$678	\$695	\$715	\$728	\$752	\$786	\$893	\$891	\$921	N.A.
------------	-------	-------	-------	-------	-------	-------	-------	-------	-------	-------	-------	-------	-------	------

COM/yds = ³/₄, COL/sq ft = 15



Guest/ Side/Stack Seating

Enea Lottus Sled Stools Sled Base

DESIGN LIEVORE ALTHERR MOLINA

SIN 71.205

Tip: For Customer's Own Material or Leather, see necessary requirements, important processing instructions, and ordering information.
 ▶Page 262

Standard Includes	Required to Specify
▶ Need help? Product details, see <i>Coalesse Seating and Outdoor Specification Guide</i>	1 Style number 2 Plastic color number for seat and back 3 Fabric or leather color number for upholstery insert, if selected 4 Paint color number for base and frame 5 Options, if selected (see below) ▶ See <i>Surface Materials</i> , page 260.

Options	Price	Required to Specify
Surface Materials Base <ul style="list-style-type: none"> Grade 1 paint Grade 3 paint 	No cost +\$75	Specify paint color number. Specify paint color number.
Acrylic backer <ul style="list-style-type: none"> Chair with upholstered insert 	+\$ 6	Specify with acrylic backer. ▶ See <i>Surface Materials</i> , page 260.
Related Products <ul style="list-style-type: none"> Café and conference tables 		▶ Pages 230 and 236

Specification Information

Style Number	Base Prices													
	Fabric Grades:										Leather Grades:			Poly-propylene
	COM	6	7	8	9	10	11	12	13	14	COL	C	E	

Sled-Base Counter-Height Stool with No Insert

COEL500	\$523	N.A.	N.A.	N.A.	N.A.	N.A.	N.A.	N.A.	N.A.	N.A.	N.A.	N.A.	N.A.	N.A.
---------	-------	------	------	------	------	------	------	------	------	------	------	------	------	------



Overall: 18"D 18 1/4"W 34 1/2"H
 Seat: 26 1/4"H

Sled-Base Counter-Height Stool with Polypropylene Insert

COEL500INSERT	N.A.	N.A.	N.A.	N.A.	N.A.	N.A.	N.A.	N.A.	N.A.	N.A.	N.A.	N.A.	N.A.	\$554
---------------	------	------	------	------	------	------	------	------	------	------	------	------	------	-------



Overall: 18"D 18 1/4"W 34 1/2"H
 Seat: 26 1/4"H

Sled Base Counter-Height Stool with Upholstered Insert

COEL500UPH	\$688	\$674	\$679	\$687	\$713	\$730	\$750	\$763	\$787	\$821	\$928	\$926	\$956	N.A.
------------	-------	-------	-------	-------	-------	-------	-------	-------	-------	-------	-------	-------	-------	------

COM/yds = 3/4, COL/sq ft = 15

▶ Specification Information, continued on next page



Overall: 18"D 18 1/4"W 34 1/2"H
 Seat: 26 1/4"H

Enea Lottus Sled Stools Sled Base

DESIGN LIEVORE ALTHERR MOLINA

SIN 71.205

► Specification Information, continued from previous page

Specification Information

Style Number	Base Prices													
	Fabric Grades:													Leather Grades:
	COM	6	7	8	9	10	11	12	13	14	COL	C	E	

Sled Base Bar-Height Stool with No Insert

COEL400	\$576	N.A.	N.A.	N.A.	N.A.	N.A.	N.A.	N.A.	N.A.	N.A.	N.A.	N.A.	N.A.	N.A.	N.A.
---------	-------	------	------	------	------	------	------	------	------	------	------	------	------	------	------



Overall: 18"D 18¼"W 38½"H
Seat: 30"H

Sled Base Bar-Height Stool with Polypropylene Insert

COEL400INSERT	N.A.	N.A.	N.A.	N.A.	N.A.	N.A.	N.A.	N.A.	N.A.	N.A.	N.A.	N.A.	N.A.	N.A.	\$607
---------------	------	------	------	------	------	------	------	------	------	------	------	------	------	------	-------



Overall: 18"D 18¼"W 38½"H
Seat: 30"H

Sled Base Bar-Height Stool with Upholstered Insert

COEL400UPH	\$741	\$727	\$732	\$740	\$766	\$783	\$803	\$816	\$840	\$874	\$981	\$979	\$1009	N.A.
------------	-------	-------	-------	-------	-------	-------	-------	-------	-------	-------	-------	-------	--------	------

COM/yds = ¾, COL/sq ft = 15



Overall: 18"D 18¼"W 38½"H
Seat: 30"H

Guest/ Side/Stack Seating

Enea Lottus Post Stools Post Base

DESIGN LIEVORE ALTHERR MOLINA

SIN 711.18

Tip: Post stool seat swivels.

Tip: For Customer's Own Material or Leather, see necessary requirements, important processing instructions, and ordering information.

▶Page 262

Standard Includes	Required to Specify
-------------------	---------------------

▶Need help? Product details, see <i>Coalesse Seating and Outdoor Specification Guide</i>	<ul style="list-style-type: none"> • Base and frame constructed of painted steel tubing • Seat and back: polypropylene • Insert, if selected: polypropylene or upholstery • Foot ring: paint to match the base and frame
	1 Style number 2 Plastic color number for seat and back 3 Fabric or leather color number for upholstery insert, if selected 4 Paint color number for base and frame 5 Options, if selected (see below) ▶See <i>Surface Materials</i> , page 260.

Options	Price	Required to Specify
---------	-------	---------------------

Surface Materials	Base <ul style="list-style-type: none"> • Grade 1 paint • Grade 3 paint 	No cost +\$105	Specify paint color number. Specify paint color number.
	Acrylic backer <ul style="list-style-type: none"> • Chair with upholstered insert 	+\$ 6	Specify with acrylic backer. ▶ See <i>Surface Materials</i> , page 260.
	<ul style="list-style-type: none"> • Polished trivalent chrome ring 	+\$ 62	Specify with trivalent chrome ring.

Related Products	<ul style="list-style-type: none"> • Café and conference tables 	▶ Pages 230 and 236
-------------------------	--	---------------------

Specification Information

Style Number	Base Prices														Leather Grades:			Polypropylene
	Fabric Grades:																	
	COM	6	7	8	9	10	11	12	13	14	COL	C	E					

Post Base Counter-Height Stool with No Insert

COEL700	\$1012	N.A.	N.A.	N.A.	N.A.	N.A.	N.A.	N.A.	N.A.	N.A.	N.A.	N.A.	N.A.	N.A.	N.A.
---------	--------	------	------	------	------	------	------	------	------	------	------	------	------	------	------

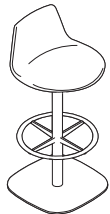

Overall: 19¾"D 19¾"W 34½"H
 Seat: 26¼"H

Post Base Counter-Height Stool with Polypropylene Insert

COEL700INSERT	N.A.	N.A.	N.A.	N.A.	N.A.	N.A.	N.A.	N.A.	N.A.	N.A.	N.A.	N.A.	N.A.	N.A.	N.A.	\$1041
---------------	------	------	------	------	------	------	------	------	------	------	------	------	------	------	------	--------

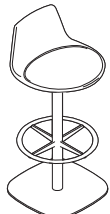

Overall: 19¾"D 19¾"W 34½"H
 Seat: 26¼"H

Post Base Counter-Height Stool with Upholstered Insert

COEL700UPH	\$1176	\$1162	\$1167	\$1175	\$1201	\$1218	\$1238	\$1251	\$1275	\$1309	\$1416	\$1414	\$1444	N.A.
------------	--------	--------	--------	--------	--------	--------	--------	--------	--------	--------	--------	--------	--------	------

COM/yds = ¾, COL/sq ft = 15

▶ Specification Information, continued on next page

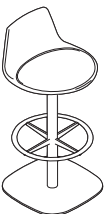

Overall: 19¾"D 19¾"W 34½"H
 Seat: 26¼"H

Enea Lottus Post Stools Post Base

DESIGN LIEVORE ALTHERR MOLINA

SIN 711.18

► Specification Information, continued from previous page

Specification Information

Style Number	Base Prices													
	Fabric Grades:													Leather Grades:
	COM	6	7	8	9	10	11	12	13	14	COL	C	E	

Post Base Bar-Height Stool with No Insert

COEL600	\$1023	N.A.	N.A.	N.A.	N.A.	N.A.	N.A.	N.A.	N.A.	N.A.	N.A.	N.A.	N.A.	N.A.	N.A.
---------	--------	------	------	------	------	------	------	------	------	------	------	------	------	------	------

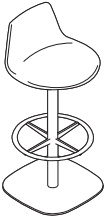

Overall: 19¾"D 19¾"W 38½"H
Seat: 30"H

Post Base Bar-Height Stool with Polypropylene Insert

COEL600INSERT	N.A.	N.A.	N.A.	N.A.	N.A.	N.A.	N.A.	N.A.	N.A.	N.A.	N.A.	N.A.	N.A.	N.A.	\$1054
---------------	------	------	------	------	------	------	------	------	------	------	------	------	------	------	--------

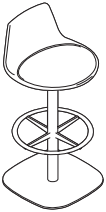

Overall: 19¾"D 19¾"W 38½"H
Seat: 30"H

Post Base Bar-Height Stool with Upholstered Insert

COEL600UPH	\$1189	\$1175	\$1180	\$1188	\$1214	\$1231	\$1251	\$1264	\$1288	\$1322	\$1429	\$1427	\$1457	N.A.
------------	--------	--------	--------	--------	--------	--------	--------	--------	--------	--------	--------	--------	--------	------

COM/yds = ¾, COL/sq ft = 15

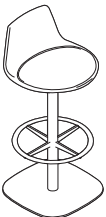

Overall: 19¾"D 19¾"W 38½"H
Seat: 30"H

Guest/ Side/Stack Seating

Kathryn Chairs

DESIGN STUDIO B

SIN 711.18

Tip: Fabrics and leathers will appear loose with comfort wrinkles when upholstered.

Tip: Recommended leathers are Elmosoft Grade C and Elmorustical Grade E.

Tip: Special color match, consult Customer Service.

Tip: For Customer's Own Material or Leather, see necessary requirements, important processing instructions, and ordering information.

▶Page 262

Standard Includes		Required to Specify
▶Need help? Product details, see <i>Coalesse Seating and Outdoor Specification Guide</i>	<ul style="list-style-type: none"> • Frame: European beech hardwood • Mortise and tenon joinery • Upholstery: multiple densities of laminated polyurethane foam and polyester fiber • Glides: non-adjustable 	1 Style number 2 Number of fabrics if contrasting fabric style number is selected 3 Fabric or leather color number for upholstery 4 Wood color number for frame ▶See <i>Hardwood and Veneer Matrix</i> , page 274 5 Options, if selected (see below) ▶See <i>Surface Materials</i> , page 260.

Options	Price	Required to Specify
Surface Materials		
• Contrasting fabric	+\$121 per fabric	Add suffix K to the style number and select fabric color number. Specify with <i>contrasting welt</i> and select fabric color number.
• Contrasting welt	+\$137	
Acrylic backer		
• Chair with open back	+\$ 8	Specify with <i>acrylic backer</i> . Specify with <i>acrylic backer</i> . ▶See <i>Surface Materials</i> , page 260.
• Chair with upholstery	+\$ 12	

Specification Information													
Style Number	Base Prices											Leather Grades:	
	Fabric Grades:											COL	C
	COM	6	7	8	9	10	11	12	13	14			

Wood with Open Back Chair

2540-1	\$ 997	\$ 991	\$1002	\$1008	\$1022	\$1035	\$1074	\$1102	\$1138	\$1212	\$1257	\$1541	\$1609
--------	--------	--------	--------	--------	--------	--------	--------	--------	--------	--------	--------	--------	--------

COM/yds = 1, COL/sq ft = 18

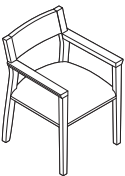

Overall: 22¾"D 22¾"W 32"H
 Inside: 19"D 18½"W 14"H
 Seat: 18"H
 Arm: 26"H

Wood/Upholstered with Panel Back Chair

2542-1	\$1040	\$1043	\$1057	\$1070	\$1088	\$1109	\$1167	\$1232	\$1259	\$1321	\$1292	\$1742	\$1848
--------	--------	--------	--------	--------	--------	--------	--------	--------	--------	--------	--------	--------	--------

COM/yds = 1½, COL/sq ft = 27

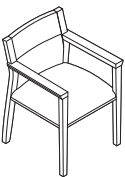

Overall: 22¾"D 22¾"W 32"H
 Inside: 19"D 18½"W 14"H
 Seat: 18"H
 Arm: 26"H

Fully Upholstered Back

2547-1	\$1172	\$1175	\$1194	\$1202	\$1220	\$1241	\$1299	\$1338	\$1400	\$1468	\$1424	\$1874	\$1980
--------	--------	--------	--------	--------	--------	--------	--------	--------	--------	--------	--------	--------	--------

COM/yds = 1½, COL/sq ft = 27

▶Specification Information, continued on next page

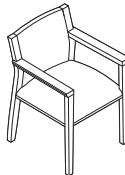

Overall: 22¾"D 22¾"W 32"H
 Inside: 19"D 18½"W 14"H
 Seat: 18"H
 Arm: 26"H

Kathryn Chairs

DESIGN STUDIO B

SIN 711.18

► Specification Information, continued from previous page

Specification Information

Style Number	Base Prices											Leather Grades:		
	Fabric Grades:											COL	C	E
	COM	6	7	8	9	10	11	12	13	14				

Fully Upholstered Back with Ribbed Upholstery

2547-1RIBD	\$1209	\$1212	\$1231	\$1239	\$1257	\$1278	\$1336	\$1375	\$1437	\$1505	\$1461	\$1911	\$2017
------------	--------	--------	--------	--------	--------	--------	--------	--------	--------	--------	--------	--------	--------

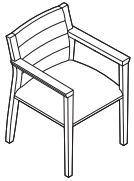

Guest/Side/Stack Seating

Last Minute Stools by Viccarbe

DESIGN PATRICIA URQUILOA

SIN 711.18

Tip: Fabrics and leathers will appear loose with comfort wrinkles when upholstered.

Tip: For Customer's Own Material or Leather, see necessary requirements, important processing instructions, and ordering information.

▶ Page 262

Standard Includes		Required to Specify
▶ Need help? Product details, see <i>Coalesse Seating and Outdoor Specification Guide</i>	<ul style="list-style-type: none"> Upholstery for stool: fabric or leather Frame: polished trivalent chrome 	1 Style number 2 Fabric or leather color number for upholstery 3 Options, if selected (see below) ▶ See <i>Surface Materials</i> , page 260.

Options	Price	Required to Specify
Surface Materials Acrylic backer • Backer	+\$6	Specify with acrylic backer. ▶ See <i>Surface Materials</i> , page 260.

Specification Information

Style Number	Base Prices											Leather Grades:		
	Fabric Grades:											COL	C	E
	COM	6	7	8	9	10	11	12	13	14				

Medium Stool

COLMS25	\$1153	\$1139	\$1144	\$1152	\$1178	\$1195	\$1215	\$1228	\$1252	\$1286	\$1393	\$1658	\$1714
---------	--------	--------	--------	--------	--------	--------	--------	--------	--------	--------	--------	--------	--------

COM/yds = 3/4, COL/sq ft = 17

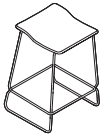

Overall: 17"D 17 1/4"W 26 1/2"H
Seat: 23 3/8"H

High Stool

COLMS30	\$1203	\$1189	\$1194	\$1202	\$1228	\$1245	\$1265	\$1278	\$1302	\$1336	\$1443	\$1708	\$1764
---------	--------	--------	--------	--------	--------	--------	--------	--------	--------	--------	--------	--------	--------

COM/yds = 3/4, COL/sq ft = 17



Overall: 17"D 17 1/4"W 31 1/2"H
Seat: 29 3/4"H

Lox Stools

DESIGN PEARSONLLOYD

SIN 711.18

Tip: Due to the design and construction techniques of the Lox stools only certain textiles can be successfully applied, therefore all COM fabrics must be submitted to Coalesse for approval prior to order acceptance.

Tip: For Customer's Own Material or Leather, see necessary requirements, important processing instructions, and ordering information.
▶ Page 262

Tip: In high-traffic applications, scuff marks on footrest may be visible in white gloss.



Overall: 17"D 17"W 28"-32"H
Seat: 26"-30"H



Overall: 17"D 17"W 31"-34"H
Seat: 29"-33"H

Standard Includes		Required to Specify
▶ Need help? Product details, see <i>Coalesse Seating and Outdoor Specification Guide</i>	<ul style="list-style-type: none"> • Shell and ribbon-shaped footrest: plastic • Base: 9251 Brushed Chrome • Seat: upholstered foam • Swivel mechanism • Height-adjustable button under seat • Felt glides 	1 Style number 2 Plastic color number for shell: 6347 Black Gloss 6348 White Gloss 3 Fabric or leather color number for upholstery 4 Options, if selected (see below) ▶ See <i>Surface Materials</i> , page 260.

Options	Price	Required to Specify
Surface Materials Acrylic backer • Backer	+ \$6	Specify with acrylic backer. ▶ See <i>Surface Materials</i> , page 260.

Specification Information

Style Number	Base Prices														Leather Grades:		
	Fabric Grades:														COL	C	E
COM	6	7	8	9	10	11	12	13	14								

Counter-Height Stool

COLX200	\$1297	\$1283	\$1288	\$1296	\$1322	\$1339	\$1359	\$1372	\$1396	\$1430	\$1537	\$1486	\$1510
COM/yds = 3/4, COL/sq ft = 13													

Bar-Height Stool

COLX210	\$1353	\$1339	\$1344	\$1352	\$1378	\$1395	\$1415	\$1428	\$1452	\$1486	\$1593	\$1542	\$1566
COM/yds = 3/4, COL/sq ft = 13													

Switch Guest

DESIGN E00S

SIN 711.18

Tip: Fabrics and leathers will appear loose with comfort wrinkles when upholstered.

Tip: Recommended leathers are Elmosoft Grade C and Elmorustical Grade E.

Tip: Special color match, consult Customer Service.

Tip: For Customer's Own Material or Leather, see necessary requirements, important processing instructions, and ordering information.
▶Page 262

Tip: Pricing based on highest grade textile specified.

Tip: Steel springs allow back to flex to match occupant's back shape.

Tip: Upholstered arm caps fit firmly on arms in coordinating textiles, COM yardage required 1/4 yards, COL square feet required 4 1/2 (1519 and 1529 only).

Tip: Glide on sled base chair has a felt pad made for hard floors. Movement on carpet is more difficult.

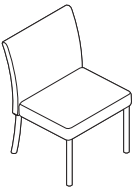

Overall: 22 1/2"D 21 1/2"W 33 1/2"H
Inside: 18 1/2"D 19 1/4"W 15 1/2"H
Seat: 18 1/2"H

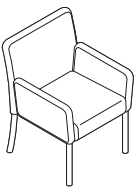

Overall: 22 1/2"D 25 3/4"W 33 1/2"H
Inside: 18 1/2"D 19"W 15 1/2"H
Seat: 18 1/2"H
Arm: 26 1/2"H

Standard Includes

- ▶Need help? Product details, see *Coalesse Seating and Outdoor Specification Guide*
- Frame: constructed of steel tubing and bar stock
- Arms: solid steel rod and bar stock
- Upholstery: Back and seat are molded foam and fiber
- Legs: matte chrome (M) or polished chrome (PC) leg finish

Required to Specify

- 1 Style number
 - 2 Number of fabrics if contrasting fabric style number is selected
 - 3 Fabric or leather color number for upholstery on seat
 - 4 Options, if selected (see below)
- ▶See *Surface Materials*, page 260

Options

Surface Materials	Options	Price	Required to Specify
	• Contrasting fabric	+\$121 per fabric	Add suffix K to the style number and select fabric color number.
	Acrylic backer		
	• Armless chair and lowback sledbase	+\$ 17	Specify with acrylic backer.
	• Highback sledbase	+\$ 19	Specify with acrylic backer.
	• Arm chair	+\$ 25	Specify with acrylic backer. ▶See <i>Surface Materials</i> , page 260

Specification Information

Style Number	Base Prices											Leather Grades:		
	Fabric Grades:											COL	C	E
	COM	6	7	8	9	10	11	12	13	14				

Armless Chairs

1500M	\$1189	\$1189	\$1200	\$1217	\$1269	\$1303	\$1342	\$1370	\$1418	\$1484	\$1463	\$2183	\$2313
1500PC	\$1233	\$1233	\$1244	\$1261	\$1313	\$1347	\$1386	\$1414	\$1462	\$1528	\$1507	\$2227	\$2358

COM/yds = 1 1/2, COL/sq ft = 27

Arm Chairs

1510M	\$1361	\$1361	\$1378	\$1406	\$1493	\$1550	\$1614	\$1660	\$1740	\$1852	\$1604	\$2832	\$3052
1510PC	\$1410	\$1410	\$1427	\$1455	\$1542	\$1599	\$1663	\$1709	\$1789	\$1901	\$1653	\$2868	\$3101

COM/yds = 2 1/2, COL/sq ft = 45

▶Specification Information, continued on next page

Switch Guest

DESIGN EOOS

SIN 711.18

► Specification Information, continued from previous page

Specification Information

Style Number	Base Prices											Leather Grades:		
	Fabric Grades:											COL	C	E
	COM	6	7	8	9	10	11	12	13	14				

Low-Back Sled Base Chairs

1519M	\$1393	\$1393	\$1406	\$1429	\$1498	\$1543	\$1596	\$1632	\$1696	\$1785	\$1653	\$2618	\$2802
1519PC	\$1423	\$1423	\$1436	\$1459	\$1528	\$1573	\$1626	\$1662	\$1726	\$1815	\$1683	\$2649	\$2832

COM/yds = 2, COL/sq ft = 36

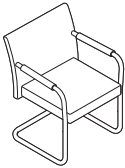

Overall: 23½"D 23¼"W 34¼"H
 Inside: 18"D 17¾"W 15½"H
 Seat: 18½"H
 Arm: 26½"H

High-Back Sled Base Chairs

1529M	\$1537	\$1537	\$1552	\$1578	\$1656	\$1707	\$1766	\$1807	\$1879	\$1980	\$1794	\$2890	\$3088
1529PC	\$1581	\$1581	\$1596	\$1622	\$1700	\$1751	\$1810	\$1851	\$1923	\$2024	\$1828	\$2929	\$3126

COM/yds = 2¼, COL/sq ft = 41

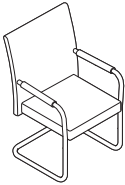

Overall: 23½"D 24"W 38½"H
 Inside: 17¾"D 17¾"W 15½"H
 Seat: 18½"H
 Arm: 26½"H

Guest/ Side/Stack Seating

Switch Stools without Arms

DESIGN E00S

SIN 711.18

Tip: Fabrics and leathers will appear loose with comfort wrinkles when upholstered.

Tip: Recommended leathers are Elmosoft Grade C and Elmorustical Grade E.

Tip: Special color match, consult Customer Service.

Tip: Pricing based on highest grade textile specified.

Tip: For Customer's Own Material or Leather, see necessary requirements, important processing instructions, and ordering information.

► Page 262

Standard Includes

- Need help? Product details, see *Coalesse Seating and Outdoor Specification Guide*
- Frame: Constructed of steel tubing and bar stock
- Upholstery: back foam are molded around the frame components.
- Seat foam is molded with "comfort pockets"
- Legs: matte chrome (M) or polished chrome (PC) leg finish

Required to Specify

- 1 Style number
 - 2 Number of fabrics if contrasting fabric style number is selected
 - 3 Fabric or leather color number for upholstery
 - 4 Options, if selected (see below)
- See *Surface Materials*, page 260.

Options

Options	Price	Required to Specify
Surface Materials	• Contrasting fabric	+\$121 per fabric
	Acrylic backer	
	• Backer	+\$ 10

Related Products		Required to Specify
• Guest seating		► Page 204
• Occasional tables		► See <i>GSA Volume 5b Specification Guide</i> .

Specification Information

Style Number	Base Prices											Leather Grades:		
	Fabric Grades:											COL	C	E
COM	6	7	8	9	10	11	12	13	14					

Counter-Height Stools

1404M	\$1291	\$1291	\$1299	\$1314	\$1357	\$1385	\$1418	\$1441	\$1481	\$1537	\$1578	\$2161	\$2273
1404PC	\$1317	\$1317	\$1325	\$1340	\$1383	\$1411	\$1444	\$1467	\$1507	\$1563	\$1604	\$2187	\$2306

COM/yds = 1¼, COL/sq ft = 23

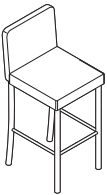

Overall: 19"D 16"W 38"H
 Inside: 15"D 15"W 11¾"H
 Seat: 27¾"H

Bar-Height Stools

1405M	\$1329	\$1329	\$1337	\$1352	\$1395	\$1423	\$1456	\$1479	\$1519	\$1575	\$1611	\$2199	\$2311
1405PC	\$1366	\$1366	\$1374	\$1389	\$1432	\$1460	\$1493	\$1516	\$1556	\$1612	\$1653	\$2236	\$2348

COM/yds = 1¼, COL/sq ft = 23

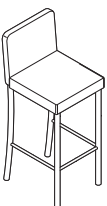

Overall: 19¾"D 16"W 41½"H
 Inside: 15"D 15"W 11¾"H
 Seat: 31¼"H

Coalesse

Switch Stools without Arms

DESIGN E00S

SIN 711.18

Montara650 Chairs

DESIGN LIEVORE ALTHERR MOLINA

SIN 711.18



Tip: Chairs stack six high.

Tip: Leathers will appear loose with comfort wrinkles when upholstered.

Tip: For Customer's Own Material or Leather, see necessary requirements, important processing instructions, and ordering information.

► Page 262

Standard Includes	Required to Specify
-------------------	---------------------

<ul style="list-style-type: none"> ► Need help? Product details, see <i>Coalesse Seating and Outdoor Specification Guide</i> 	<ul style="list-style-type: none"> • Seat and back: upholstery, if selected • Shell: wood shell, wood shell with upholstered seat, ¾ upholstery with wood shell, if selected: wood veneer grade 1 • Base: paint • Glides 	<ol style="list-style-type: none"> 1 Style number 2 Upholstery version (see below under Required Selections) 3 Contrasting fabric on ¾ or fully upholstered, if selected (see below under Required Selections) 4 Fabric and/or leather color number for seat and/or back, if selected 5 Wood finish on shell, if selected 6 Base type (see below under Required Selections) 7 Paint color number for base 8 Options, if selected (see below) <p>► See <i>Surface Materials</i>, page 260</p>
--	--	--

Required Selections	Price	Required to Specify
---------------------	-------	---------------------

Upholstery Version	<ul style="list-style-type: none"> • Wood shell • Wood shell with upholstered seat • Wood shell with ¾ upholstery • Fully upholstered 	Prices at right Prices at right Prices at right Prices at right	Specify with <i>wood seat and back</i> . Specify with <i>upholstered seat, wood back</i> . Specify with <i>¾ upholstered</i> . Specify with <i>upholstered seat and back</i> .
Contrasting Fabric on ¾ and Fully Upholstered	<ul style="list-style-type: none"> • Non contrasting fabric • Contrasting fabric 	No cost +\$ 121	Specify with <i>non contrasting fabric</i> . Specify with <i>contrasting fabric</i> .
Base Type	<ul style="list-style-type: none"> • 4-leg • Sled base • Sled base with cantilever arms • 4-leg base with loop arms 	No cost +\$ 51 +\$100 +\$120	Specify with <i>4-leg</i> . Specify with <i>sled base</i> . Specify with <i>sled cantilever arm</i> . Specify with <i>4-leg loop arm</i> .

Options	Price	Required to Specify
---------	-------	---------------------

Surface Materials	Base, armless <ul style="list-style-type: none"> • Polished trivalent chrome base • Grade 3 paint 	+\$ 51 +\$ 75	Specify with <i>polished trivalent chrome</i> . Specify paint color number.
	Base, with arms <ul style="list-style-type: none"> • Polished trivalent chrome base Shell • Grade 3 paint 	+\$170 +\$ 75	Specify with <i>polished trivalent chrome</i> . Specify paint color number.
	Wood shell <ul style="list-style-type: none"> • Grade 1 wood veneer • Grade 2 wood veneer 	No cost +\$ 62	Specify with <i>VP01 Oak Light, VP03 Black Oak, or VP05 White Oak</i> . Specify with <i>VP02 Smoked Oak or VP04 Grey Oak</i> .
	Acrylic backer <ul style="list-style-type: none"> • Seat • Seat and back 	+\$ 8 +\$ 17	Specify with <i>acrylic backer</i> . Specify with <i>acrylic backer</i> .

Related Products	<ul style="list-style-type: none"> • Tables • Stools 	► See <i>GSA Volume 5b Specification Guide</i> . ► Pages 212
-------------------------	--	---

Montara650 Chairs

DESIGN LIEVORE ALTHERR MOLINA

SIN 711.18

Specification Information



4-leg, armless
Overall: 20½"W x 20½"D x 31"H
Seat: 17½"H



4-leg with loop arms
Overall: 24"W x 20½"D x 31"H
Seat: 17½"H
Arms: 25¼"H



Sled base, armless
Overall: 20½"W x 20½"D x 31"H
Seat: 17½"H



Sled base with cantilever arms
Overall: 22"W x 20½"D x 31"H
Seat: 17½"H
Arms: 25"H

Style
Number

Base Price

Wood Shell Chair

COSFZCH	Seat	\$538
---------	------	-------

Style
Number

Base Prices

Fabric Grades:

COM	6	7	8	9	10	11	12	13	14	Leather Grades:		
										COL	C	E

Wood Shell Chair with Upholstered Seat

COSFZCH	Seat	\$682	\$660	\$664	\$670	\$689	\$ 701	\$ 715	\$ 725	\$ 742	\$ 767	\$ 899	\$ 802	\$ 836
---------	------	-------	-------	-------	-------	-------	--------	--------	--------	--------	--------	--------	--------	--------

Wood Shell Chair with ¾ Upholstery

COSFZCH	Seat	\$784	\$762	\$766	\$772	\$791	\$ 803	\$ 817	\$ 827	\$ 844	\$ 869	\$1001	\$ 904	\$ 938
	Back	+\$ 41	+\$19	+\$23	+\$29	+\$48	+\$ 60	+\$ 74	+\$ 84	+\$101	+\$126	+\$ 83	+\$ 161	+\$195

Fully Upholstered Chair

COSFZCH	Seat	\$707	\$685	\$689	\$695	\$ 714	\$ 726	\$ 740	\$ 750	\$ 767	\$ 792	\$ 924	\$ 827	\$ 861
	Back	+\$ 41	+\$38	+\$45	+\$57	+\$95	+\$120	+\$149	+\$168	+\$203	+\$252	+\$ 83	+\$355	+\$427

Guest/ Side/Stack Seating

Montara650 Lounge Chair

DESIGN LIEVORE ALTHERR MOLINA

SIN 711.18



Tip: Leathers will appear loose with comfort wrinkles when upholstered.

Tip: For Customer's Own Material or Leather, see necessary requirements, important processing instructions, and ordering information.

► See *Coalesse Surface Materials Reference Guide* and online fabric database at <http://fabric.coalesse.com>.

Standard Includes	Required to Specify
-------------------	---------------------

<p>► Need help? Product details, see <i>Coalesse Seating and Outdoor Specification Guide</i></p> <ul style="list-style-type: none"> • Seat and back upholstery, if selected • Shell: wood shell with ³/₄ upholstery or wood shell with upholstered seat, if selected: wood veneer grade 1 • Sled base: grade 1 paint • Glides 	<ol style="list-style-type: none"> 1 Style number 2 Upholstery version (see below under Required Selections) 3 Contrasting fabric on ³/₄ upholstered or fully upholstered, if selected (see below under Required Selections) 4 Fabric and/or leather color number for seat and/or back, if selected 5 Wood finish on shell, if selected 6 Paint color number for base 7 Options, if selected (see below) <p>► See <i>Coalesse Surface Materials Reference Guide</i>.</p>
---	---

Required Selections	Price	Required to Specify
---------------------	-------	---------------------

<p>Upholstery Version</p> <ul style="list-style-type: none"> • Wood shell with ³/₄ upholstery • Wood shell with upholstered seat • Fully upholstered 	<p>Prices at right Prices at right Prices at right</p>	<p>Specify with ³/₄ upholstered. Specify with upholstered seat and wood back. Specify with <i>upholstered seat and back</i>.</p>
<p>Contrasting Fabric on Fully Upholstered</p> <ul style="list-style-type: none"> • Non contrasting fabric • Contrasting fabric 	<p>No cost +\$121</p>	<p>Specify with <i>non contrasting fabric</i>. Specify with <i>contrasting fabric</i>.</p>

Options	Price	Required to Specify
---------	-------	---------------------

<p>Surface Materials</p> <p>Base</p> <ul style="list-style-type: none"> • Grade 3 paint • Polished trivalent chrome base <p>Shell</p> <ul style="list-style-type: none"> • Grade 1 wood veneer • Grade 2 wood veneer <p>Acrylic backer</p> <ul style="list-style-type: none"> • Seat • Seat and back 	<p>+\$ 75 +\$ 77</p> <p>No cost +\$ 62</p> <p>+\$ 8 +\$ 17</p>	<p>Specify paint color number. Specify with <i>polished trivalent chrome</i>.</p> <p>Specify with <i>VP01 Oak Light, VP03 Black Oak, or VP05 White Oak</i>. Specify with <i>VP02 Smoked Oak or VP04 Grey Oak</i>.</p> <p>Specify with <i>acrylic backer</i>. Specify with <i>acrylic backer</i>.</p>
--	--	--

<p>Related Products</p> <ul style="list-style-type: none"> • Guest seating • Stools • Café tables • Occasional tables 	<p>► See <i>Coalesse Seating and Outdoor Specification Guide</i>.</p> <p>► See <i>Coalesse Seating and Outdoor Specification Guide</i>.</p> <p>► See <i>Coalesse Tables, Storage, and Accessories Specification Guide</i>.</p> <p>► See <i>Coalesse Tables, Storage, and Accessories Specification Guide</i>.</p>
--	---

Coalesse

Montara650 Lounge Chair

DESIGN LIEVORE ALTHERR MOLINA

SIN 711.18



Overall: 25½"D x 29"W x 21¼"H
Seat: 16"

Overall: 25½"D x 29"W x 21¼"H
Seat: 16"

Overall: 25½"D x 29"W x 21¼"H
Seat: 16"

Specification Information

Style Number	Base Prices													
	Fabric Grades:											Leather Grades:		
	COM	6	7	8	9	10	11	12	13	14	COL	C	E	

Wood Shell Lounge Chair with Upholstered Seat

COSFZLC	Seat	\$ 916	\$ 913	\$ 920	\$ 933	\$ 971	\$ 995	\$1023	\$1043	\$1078	\$1126	\$1127	\$1068	\$1108
COM/yds = 1, COL/sq ft = 9														

Wood Shell Lounge Chair with ¾ Upholstered Back

COSFZLC	Seat	\$1016	\$1013	\$1020	\$1033	\$1071	\$1095	\$1123	\$1143	\$1178	\$1226	\$1227	\$1168	\$1208
	Back	+\$ 41	+\$ 29	+\$ 34	+\$ 43	+\$ 72	+\$ 90	+\$111	+\$126	+\$152	+\$188	+\$ 81	+\$386	+\$465
COM/yds = 1, COL/sq ft = 17														

Fully Upholstered Lounge Chair

COSFZLC	Seat	\$ 941	\$ 938	\$ 945	\$ 958	\$ 996	\$1020	\$1048	\$1068	\$1103	\$1151	\$1152	\$1093	\$1133
	Back	+\$ 41	+\$ 57	+\$ 68	+\$ 87	+\$143	+\$180	+\$222	+\$252	+\$304	+\$377	+\$ 81	+\$482	+\$582
COM/yds = 2½, COL/sq ft = 32														

Guest/ Side/Stack Seating

Montara650 Stools

DESIGN LIEVORE ALTHERR MOLINA

SIN 711.18

Tip: Leathers will appear loose with comfort wrinkles when upholstered.

Tip: For Customer's Own Material or Leather, see necessary requirements, important processing instructions, and ordering information.

▶ Page 262



Stool at bar height
Overall: 18¾"W x 19½"D x 39½"H
Seat: 30"H

COM yardage:
Seat: ¾ yards
Fully uph. back: 1¼ yards

COL yardage:
Seat: 7 yards
Fully uph. back: 18 yards

Standard Includes	Required to Specify
<ul style="list-style-type: none"> ▶ Need help? Product details, see <i>Coalesse Seating and Outdoor Specification Guide</i> • Seat and back upholstery, if selected • Shell: wood shell or wood shell with upholstered seat, if selected: wood veneer grade 1 • Sled base: grade 1 paint • Glides 	<ol style="list-style-type: none"> 1 Style number 2 Application (see below under Required Selections) 3 Upholstery version (see below under Required Selections) 4 Contrasting fabric on fully upholstered, if selected (see below under Required Selections) 5 Fabric and/or leather color number for seat and/or back, if selected 6 Wood finish on shell, if selected 7 Paint color number for base 8 Options, if selected (see below) <p>▶ See <i>Surface Materials</i>, page 260.</p>

	Required Selections	Price	Required to Specify
Application	<ul style="list-style-type: none"> • Counter height • Bar height 	No cost +\$ 51	Specify with counter height. Specify with bar height.
Upholstery Version	<ul style="list-style-type: none"> • Wood shell • Wood shell with upholstered seat • Fully upholstered 	Price below Prices at right Prices at right	Specify with wood seat and back. Specify with upholstered seat and wood back. Specify with upholstered seat and back.
Contrasting Fabric on Fully Upholstered	<ul style="list-style-type: none"> • Non contrasting fabric • Contrasting fabric 	No cost +\$121	Specify with non contrasting fabric. Specify with contrasting fabric.

	Options	Price	Required to Specify
Surface Materials	Base		
	<ul style="list-style-type: none"> • Grade 3 paint • Polished trivalent chrome base 	+\$ 75 +\$ 77	Specify paint color number. Specify with polished trivalent chrome.
	Shell		
	<ul style="list-style-type: none"> • Grade 1 wood veneer • Grade 2 wood veneer 	No cost +\$ 62	Specify with VP01 Oak Light, VP03 Black Oak, or VP05 White Oak. Specify with VP02 Smoked Oak or VP04 Grey Oak.
	Acrylic backer		
	<ul style="list-style-type: none"> • Seat • Seat and back 	+\$ 8 +\$ 17	Specify with acrylic backer. Specify with acrylic backer.

Related Products

- Tables
- Chairs
- Café tables
- Occasional tables

▶ See *GSA Volume 5b Specification Guide*.
 ▶ Page 208
 ▶ See *GSA Volume 5b Specification Guide*.
 ▶ See *GSA Volume 5b Specification Guide*.

Specification Information

Style Number	Base Price
--------------	------------

Wood Shell Stool

COSFZST \$743

▶ Specification Information, continued on next page



Overall: 18½"W x 19½"D x 35½"H
Seat: 26"H

Coalesse

Montara650 Stools

DESIGN LIEVORE ALTHERR MOLINA

SIN 711.18

► Specification Information, continued from previous page

Specification Information

Style Number	Base Prices											Leather Grades:		
	Fabric Grades:											COL	C	E
	COM	6	7	8	9	10	11	12	13	14				

Wood Shell Stool with Upholstered Seat

COSFZST	Seat	\$887	\$865	\$869	\$875	\$894	\$906	\$920	\$930	\$947	\$972	\$1104	\$1044	\$1085
---------	------	-------	-------	-------	-------	-------	-------	-------	-------	-------	-------	--------	--------	--------



Overall: 18½"W x 19½"D x 35½"H
Seat: 26"H

Overall: 18½"W x 19½"D x 35½"H
Seat: 26"H

Fully Upholstered Stool

COSFZST	Seat	\$912	\$890	\$894	\$900	\$919	\$931	\$945	\$955	\$972	\$997	\$1129	\$1069	\$1110
	Back	+\$41	+\$38	+\$45	+\$57	+\$95	+\$120	+\$149	+\$168	+\$203	+\$252	+\$299	+\$355	+\$427

Guest/Side/Stack Seating

Montara650 Rocker

DESIGN LIEVORE ALTHERR MOLINA

SIN 711.18



Tip: Leathers will appear loose with comfort wrinkles when upholstered.

Tip: For Customer's Own Material or Leather, see necessary requirements, important processing instructions, and ordering information.

▶ See page 260.



With arms

Standard Includes	Required to Specify
-------------------	---------------------

<p>▶ Need help? Product details, see <i>Coalesse Seating and Outdoor Specification Guide</i></p> <ul style="list-style-type: none"> • Seat and back upholstery, if selected • Shell: wood shell with ³/₄ upholstery or wood shell with upholstered seat, if selected: wood veneer grade 1 • Base: paint • Runners: solid oak in clear finish 	<ol style="list-style-type: none"> 1 Style number 2 Upholstery version (see below under Required Selections) 3 Contrasting fabric on ³/₄ upholstered or fully upholstered, if selected (see below under Required Selections) 4 Fabric and/or leather color number for seat and/or back, if selected 5 Wood finish on shell, if selected 6 Paint color number for base 7 Options, if selected (see below) <p>▶ See <i>Surface Materials</i>, page 260.</p>
--	--

Required Selections	Price	Required to Specify
---------------------	-------	---------------------

<p>Upholstery Version</p> <ul style="list-style-type: none"> • Wood shell with ³/₄ upholstery • Wood shell with upholstered seat • Fully upholstered 	<p>Prices at right Prices at right Prices at right</p>	<p>Specify with ³/₄ upholstered. Specify with upholstered seat and wood back. Specify with upholstered seat and back.</p>
<p>Contrasting Fabric on ³/₄ and Fully Upholstered</p> <ul style="list-style-type: none"> • Non contrasting fabric • Contrasting fabric 	<p>No cost +\$121</p>	<p>Specify with non contrasting fabric. Specify with contrasting fabric.</p>
<p>Arm Type</p> <ul style="list-style-type: none"> • Armless • With arms 	<p>No cost +\$100</p>	<p>Specify with no arms. Specify with arms.</p>

Options	Price	Required to Specify
---------	-------	---------------------

<p>Surface Materials</p> <p>Base, armless</p> <ul style="list-style-type: none"> • Polished trivalent chrome base • Lux Coatings 	<p>+\$ 77 +\$ 75</p>	<p>Specify with polished trivalent chrome. Specify Lux Coatings color number.</p>
<p>Base, with arms</p> <ul style="list-style-type: none"> • Polished trivalent chrome base • Lux Coatings 	<p>+\$ 170 +\$ 75</p>	<p>Specify with polished trivalent chrome. Specify Lux Coatings color number.</p>
<p>Wood shell</p> <ul style="list-style-type: none"> • Grade 1 wood veneer • Grade 2 wood veneer 	<p>No cost +\$ 62</p>	<p>Specify with VP01 Oak Light, VP03 Black Oak, or VP05 White Oak. Specify with VP02 Smoked Oak or VP04 Grey Oak.</p>
<p>Acrylic backer</p> <ul style="list-style-type: none"> • Seat • Seat and back 	<p>+\$ 8 +\$ 17</p>	<p>Specify with acrylic backer. Specify with acrylic backer.</p>
<p>Related Products</p> <ul style="list-style-type: none"> • Guest seating • Stools • Café tables • Occasional tables 		<p>▶ Page 208 ▶ Page 212 ▶ See <i>GSA Volume 5b Specification Guide</i>. ▶ See <i>GSA Volume 5b Specification Guide</i>.</p>

Coalesse

Montara650 Rocker

DESIGN LIEVORE ALTHERR MOLINA

SIN 711.18



Overall: 29"D x 28½"W x 30"H
Seat: 16"

Overall: 29"D x 28½"W x 30"H
Seat: 16"

Overall: 29"D x 28½"W x 30"H
Seat: 16"

Specification Information

Style Number	Base Prices												Leather Grades:		
	Fabric Grades:												COL	C	E
	COM	6	7	8	9	10	11	12	13	14					

Wood Shell Rocker with Upholstered Seat

COSFZRC	Seat	\$1429	\$1426	\$1433	\$1446	\$1484	\$1508	\$1536	\$1556	\$1591	\$1639	\$1640	\$1581	\$1621
COM/yds = 1, COL/sq ft = 9														

Wood Shell Rocker with ¾ Upholstered Back

COSFZRC	Seat	\$1529	\$1526	\$1533	\$1546	\$1584	\$1608	\$1636	\$1656	\$1691	\$1739	\$1740	\$1681	\$1721
	Back	+\$ 41	+\$ 29	+\$ 34	+\$ 43	+\$ 72	+\$ 90	+\$111	+\$126	+\$152	+\$188	+\$ 81	+\$386	+\$465
COM/yds = 1, COL/sq ft = 17														

Fully Upholstered Rocker

COSFZRC	Seat	\$1454	\$1451	\$1458	\$1471	\$1509	\$1533	\$1561	\$1581	\$1616	\$1664	\$1665	\$1606	\$1646
	Back	+\$ 41	+\$ 57	+\$ 68	+\$ 87	+\$143	+\$180	+\$222	+\$252	+\$304	+\$377	+\$ 81	+\$482	+\$582
COM/yds = 2½, COL/sq ft = 32														

Guest/ Side/Stack Seating

Wrapp Chairs by Viccarbe

DESIGN MARK KRUSIN

SIN 711.18

Tip: Fabrics and leathers will appear loose with comfort wrinkles when upholstered.

Tip: Stacking is not recommended as the frame will dent the foam on the seat on which it is being stacked.

Tip: For Customer's Own Material or Leather, see necessary requirements, important processing instructions, and ordering information
 ▶ See *Coalesse Surface Materials Reference Guide*.

Standard Includes		Required to Specify
▶ Need help? Product details, see <i>Coalesse Seating and Outdoor Specification Guide</i>	<ul style="list-style-type: none"> Upholstery for chair: fabric or leather Frame: polished trivalent chrome 	1 Style number 2 Number of fabrics if contrasting fabric style number is selected 3 Fabric or leather color number for upholstery 4 Options, if selected (see below) ▶ See <i>Coalesse Surface Materials Reference Guide</i> .

Options	Price	Required to Specify
Surface Materials	<ul style="list-style-type: none"> Contrasting fabric 	+\$121 per fabric
	<ul style="list-style-type: none"> Acrylic backer Backer 	+\$ 12
		Add suffix K to the style number and select fabric color number. Specify with <i>acrylic backer</i> . ▶ See <i>Coalesse Surface Materials Reference Guide</i> .

Specification Information													
Style Number	Base Prices												
	Fabric Grades:												
	COM	6	7	8	9	10	11	12	13	14	Leather Grades:		
											COL	C	E

Four-Leg Chair

COWRP4LEG	\$1251	\$1251	\$1262	\$1279	\$1331	\$1365	\$1404	\$1432	\$1480	\$1546	\$1480	\$2064	\$2176
COM/yds = 1½, COL/sq ft = 33													



Overall: 21"D 25¼"W 29½"H
 Inside: 16"D 19½"W 17½"H
 Seat: 17½"H

Sled-Base Chair

COWRPSLD	\$1296	\$1296	\$1307	\$1324	\$1376	\$1410	\$1449	\$1477	\$1525	\$1591	\$1525	\$2109	\$2221
COM/yds = 1½, COL/sq ft = 33													

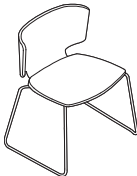

Overall: 20¼"D 24½"W 28¾"H
 Inside: 16"D 19½"W 17½"H
 Seat: 17½"H

Collaboration Seating

Bindu Conference Seating (SIN 711.18)	218
Chord Conference Seating (SIN 711.18)	220
SW_1 Conference Seating (SIN 711.18)	222

Bindu Conference Seating

DESIGN BRIAN KANE

SIN 711.18

Tip: Fabrics and leathers will appear loose with comfort wrinkles when upholstered.

Tip: For Customer's Own Material or Leather, see necessary requirements, important processing instructions, and ordering information.
▶ Page 262

Tip: Craft in upholstery cautions the use of stripes and patterns on Bindu. Please use fabric database when specifying.

Tip: For fabric with a large pattern and a specific pattern location is desired, contact Customer Service.

Standard Includes		Required to Specify
▶ Need help? Product details, see <i>Coalesse Seating and Outdoor Specification Guide</i>	<ul style="list-style-type: none"> Bent plywood frame Chair: fabric Molded polypropylene foam Base: 6205 Black Resin Dual wheel hard casters, conference Back tilt lock 	1 Style number 2 Fabric or leather color number for upholstery 3 Options, if selected (see below) ▶ See <i>Surface Materials</i> , page 260.

Options	Price	Required to Specify
Surface Materials	<ul style="list-style-type: none"> Acrylic backer +\$ 30 Mid-back chair +\$ 32 High-back chair 	Specify with acrylic backer. Specify with acrylic backer. ▶ See <i>Surface Materials</i> , page 260.
Base	<ul style="list-style-type: none"> 8046 Polished Aluminum (available on CO300 & CO400) +\$151 	Specify with 8046 Polished Aluminum.
Casters	<ul style="list-style-type: none"> Soft casters +\$ 24 	Specify with soft casters.

Specification Information													
Style Number	Base Prices											Leather Grades:	
	Fabric Grades:											COL	C
	COM	6	7	8	9	10	11	12	13	14			

Mid-Back Conference Chair

CO300	\$1488	\$1488	\$1508	\$1542	\$1646	\$1714	\$1792	\$1846	\$1943	\$2077	\$1663	\$2886	\$3110
COM/yds = 3, COL/sq ft = 66													



Overall: 25"D 25"W 35½"-40¼"H
 Inside: 18¾"D 18½"-19½"W 21"H
 Seat: 16"-20½"H
 Arm: 24¼"-29"H

High-Back Conference Chair

CO400	\$1736	\$1736	\$1758	\$1795	\$1908	\$1982	\$2066	\$2125	\$2230	\$2375	\$1903	\$3231	\$3475
COM/yds = 3.25, COL/sq ft = 72													



Overall: 25"D 25"W 45½"-50¼"H
 Inside: 18¾"D 18½"-19½"W 31"H
 Seat: 16"-20½"H
 Arm: 24¼"-29"H

Coalesse

Bindu Conference Seating

DESIGN BRIAN KANE

SIN 711.18

Chord Conference Seating

DESIGN MICHAEL SHIELDS

SIN 711.18

Tip: Fabrics and leathers will appear loose with comfort wrinkles when upholstered.

Tip: For Customer's Own Material or Leather, see necessary requirements, important processing instructions, and ordering information.
 ▶Page 262

Tip: Arm is cast from 100% recycled material then hand buffed to a mirror finish. Arm caps are molded in black.

Tip: List price based on highest fabric grade usage.

Tip: Contrasting option available only on 798-P and 796-P.

Standard Includes		Required to Specify
<ul style="list-style-type: none"> ▶Need help? Product details, see <i>Coalesse Seating and Outdoor Specification Guide</i> 	<ul style="list-style-type: none"> • Frame: hardwood plywood assembled into unibody structures utilizing interlocking finger joinery • Cushioning: <ul style="list-style-type: none"> - back: multiple laminations of high-density polyurethane foam over an elastic sheet suspension system for lumbar support - seat: closed cell, contour molded urethane foam • Upholstery: <ul style="list-style-type: none"> - seams are double needle stitched with seam binding for extended durability - unique wrap around welt detail and is cut from the same fabric as specified on chair • Arms: resilient self-skinned urethane molded around carbon steel armature, black or aluminum arm with urethane cap, if selected • Chair controls: tilt-swivel with tilt tension, pneumatic height adjustment, and tilt lockout • Bases: five star black resin • Casters: black hooded dual wheel 	<ol style="list-style-type: none"> 1 Style number 2 Number of fabrics if contrasting fabric style number is selected 3 Fabric or leather color number for upholstery on seat and back 4 Options, if selected (see below) ▶See <i>Surface Materials</i> , page 260.

Options	Price	Required to Specify
Surface Materials <ul style="list-style-type: none"> • Welt detail <ul style="list-style-type: none"> • Contrasting fabric welt +\$ 64 • Contrasting leather welt +\$ 93 		Specify with <i>contrasting fabric welt</i> and select fabric color number. Specify with <i>contrasting leather welt</i> and select fabric color number.
Contrasting fabric <ul style="list-style-type: none"> • Contrasting fabric +\$121 per fabric 		Add suffix K to the style number and select fabric color number.
Acrylic backer <ul style="list-style-type: none"> • Conference, midback, and high back large chairs +\$ 19 • High back large chair +\$ 23 • Midback with pillow chairs +\$ 30 • High back with pillow chairs +\$ 32 		Specify with <i>acrylic backer</i> . Specify with <i>acrylic backer</i> . Specify with <i>acrylic backer</i> . ▶ See <i>Surface Materials</i> , page 260.
Base <ul style="list-style-type: none"> • Polished aluminum with black, hooded dual wheel casters +\$ 64 		Specify with <i>polished aluminum base</i> .
Casters <ul style="list-style-type: none"> • Soft wheel casters +\$ 49 		Specify with <i>soft casters</i> .
Control <ul style="list-style-type: none"> • Knee-tilt with pneumatic height adjustment and tilt lockout +\$157 		Specify with <i>knee-tilt</i> .

Specification Information

Style Number	Base Prices												Leather Grades:			
	Fabric Grades:												COL	C	E	
	COM	6	7	8	9	10	11	12	13	14						

Conference Narrow/Narrow with Urethane Arms																
795	\$1137	\$1135	\$1156	\$1177	\$1200	\$1230	\$1306	\$1364	\$1431	\$1563	\$1374	\$2106	\$2245			
COM/yds = 2, COL/sq ft = 36																

Conference Narrow/Narrow with Aluminum Arms																
795AU	\$1512	\$1510	\$1531	\$1552	\$1575	\$1605	\$1681	\$1739	\$1806	\$1938	\$1749	\$2481	\$2620			
▶ Specification Information, continued on next page																



Overall: 26½"D 26½"W 36"-39"H
 Inside: 18"D 20"W 18½"H
 Seat: 18½"-21½"H
 Arm: 25¾"-28¾"H

Chord Conference Seating

DESIGN MICHAEL SHIELDS

SIN 711.18

► Specification Information, continued from previous page

Specification Information

Style Number	Base Prices										Leather Grades:		
	Fabric Grades:										COL	C	E
	COM	6	7	8	9	10	11	12	13	14			



Overall: 26½"D 26½"W 37½"-40½"H
 Inside: 19"D 21½"W 21½"H
 Seat: 21½"H
 Arm: 25¾"-28¾"H

Mid Back with Urethane Arms

796	\$1273	\$1266	\$1287	\$1304	\$1329	\$1363	\$1442	\$1493	\$1567	\$1717	\$1510	\$2242	\$2374
-----	--------	--------	--------	--------	--------	--------	--------	--------	--------	--------	--------	--------	--------

COM/yds = 2, COL/sq ft = 36

Mid Back with Aluminum Arms

796AU	\$1648	\$1641	\$1662	\$1679	\$1704	\$1738	\$1817	\$1868	\$1942	\$2092	\$1885	\$2617	\$2749
-------	--------	--------	--------	--------	--------	--------	--------	--------	--------	--------	--------	--------	--------



Overall: 26½"D 26½"W 37½"-40½"H
 Inside: 18½"D 21½"W 19"H
 Seat: 19"-22"H
 Arm: 25¾"-28¾"H

Mid Back/Pillow Upholstery with Urethane Arms

796-P	\$1575	\$1570	\$1595	\$1618	\$1670	\$1708	\$1831	\$1910	\$2015	\$2193	\$1776	\$2900	\$3105
-------	--------	--------	--------	--------	--------	--------	--------	--------	--------	--------	--------	--------	--------

COM/yds = 3, COL/sq ft = 54

Mid Back/Pillow Upholstery with Aluminum Arms

796-PAU	\$1950	\$1945	\$1970	\$1993	\$2045	\$2083	\$2206	\$2285	\$2390	\$2568	\$2151	\$3275	\$3480
---------	--------	--------	--------	--------	--------	--------	--------	--------	--------	--------	--------	--------	--------

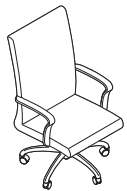

Overall: 26½"D 26½"W 24½"H
 Inside: 18"D 20"W 18½"H
 Seat: 18½"-21½"H
 Arm: 25¾"-28¾"H

High Back Narrow/Narrow with Urethane Arms

797	\$1578	\$1576	\$1602	\$1618	\$1641	\$1668	\$1747	\$1805	\$1872	\$2071	\$1815	\$2387	\$2523
-----	--------	--------	--------	--------	--------	--------	--------	--------	--------	--------	--------	--------	--------

COM/yds = 2, COL/sq ft = 36

High Back Narrow/Narrow with Aluminum Arms

797AU	\$1953	\$1951	\$1977	\$1993	\$2016	\$2043	\$2122	\$2180	\$2247	\$2446	\$2190	\$2762	\$2898
-------	--------	--------	--------	--------	--------	--------	--------	--------	--------	--------	--------	--------	--------



Overall: 26½"D 26½"W 46"-49"H
 Inside: 19"D 21½"W 18½"H
 Seat: 18½"-21½"H
 Arm: 25¾"-28¾"H

High Back/Large Scale with Urethane Arms

798	\$1599	\$1589	\$1610	\$1631	\$1654	\$1681	\$1760	\$1818	\$1885	\$2087	\$1835	\$2394	\$2531
-----	--------	--------	--------	--------	--------	--------	--------	--------	--------	--------	--------	--------	--------

COM/yds = 2, COL/sq ft = 44

High Back/Large Scale with Aluminum Arms

798AU	\$1974	\$1964	\$1985	\$2006	\$2029	\$2056	\$2135	\$2193	\$2260	\$2462	\$2210	\$2769	\$2906
-------	--------	--------	--------	--------	--------	--------	--------	--------	--------	--------	--------	--------	--------



Overall: 26½"D 26½"W 46"-49"H
 Inside: 19"D 21½"W 19"H
 Seat: 19"-22"H
 Arm: 26¾"H-28¾"H

High Back/Large Scale with Pillow Upholstery with Urethane Arms

798-P	\$1712	\$1700	\$1727	\$1755	\$1807	\$1845	\$1962	\$2047	\$2152	\$2350	\$1913	\$3031	\$3235
-------	--------	--------	--------	--------	--------	--------	--------	--------	--------	--------	--------	--------	--------

COM/yds = 3, COL/sq ft = 66

High Back/Large Scale with Pillow Upholstery with Aluminum Arms

798-PAU	\$2087	\$2075	\$2102	\$2130	\$2182	\$2220	\$2337	\$2422	\$2527	\$2725	\$2288	\$3406	\$3610
---------	--------	--------	--------	--------	--------	--------	--------	--------	--------	--------	--------	--------	--------

SW_1 Conference Seating

DESIGN SCOTT WILSON & MINIMAL

SIN 711.18

Tip: For Customer's Own Material or Leather, see necessary requirements, important processing instructions, and ordering information.
 ▶ Page 262

Standard Includes		Required to Specify
<ul style="list-style-type: none"> ▶ Need help? Product details, see <i>Coalesse Seating and Outdoor Specification Guide</i> 	<ul style="list-style-type: none"> • Seat: fabric or leather • Back: knit • Base: 8040 Aluminum Matte Polished • Frame: steel tube • Glides on conference chair with 4-star base, if selected: aluminum with non marring plastic insert • Casters on conference chair with 5-star base, if selected: dual wheel hard casters, black only • Swivel return mechanism on conference chair with 4-star base, if selected • Swivel mechanism on conference chair with 5-star base, if selected 	<ol style="list-style-type: none"> 1 Style number 2 Upholstery color number for seat 3 Knit color number for back 4 Options, if selected (see below) ▶ See <i>Surface Materials</i> , page 260

Options	Price	Required to Specify
Surface Materials <ul style="list-style-type: none"> • Contrasting fabric 	+\$ 121	Specify with <i>contrasting fabric</i> and select fabric color number.
Fire code seating <ul style="list-style-type: none"> • Fire code seating 	+\$237	Specify with <i>fire code seating</i> .
Acrylic backer <ul style="list-style-type: none"> • Backer 	+\$ 30	Specify with <i>acrylic backer</i> . ▶ See <i>Surface Materials</i> , page 260
Mechanism <ul style="list-style-type: none"> • Full swivel (omit swivel-return feature) 	No cost	Specify with <i>swivel-only mechanism</i> .
Casters <ul style="list-style-type: none"> • Black soft casters • Hard black casters with polished aluminum body • Soft black casters with polished aluminum body 	+\$ 23 +\$ 69 +\$ 92	Specify with <i>soft casters</i> . Specify with <i>hard polished aluminum casters</i> . Specify with <i>soft polished aluminum casters</i> .
Related Products <ul style="list-style-type: none"> • Collaborative and conference tables • Occasional tables • Lounge seating 		▶ See <i>GSA Volume 5b Specification Guide</i> . ▶ See <i>GSA Volume 5b Specification Guide</i> . ▶ Page 162

Specification Information														
Style Number	Base Prices												Leather Grades:	
	Fabric Grades:												COL	C
	COM	6	7	8	9	10	11	12	13	14				

Conference Chair with 4-Star Base

COW413	Seat	\$1914	\$1914	\$1920	\$1930	\$1961	\$1982	\$2005	\$2021	\$2050	\$2091	\$1966	\$2203	\$2237
	Upper back	+\$ 74	+\$ 74	+\$ 88	+\$112	+\$185	+\$232	+\$287	+\$325	+\$393	+\$486	+\$197	+\$749	+\$829
COM/yds = 3, COL/sq ft = 60														

Conference Chair with 5-Star Base

COW415	Seat	\$1914	\$1914	\$1920	\$1930	\$1961	\$1982	\$2005	\$2021	\$2050	\$2091	\$1966	\$2203	\$2237
	Upper back	+\$ 74	+\$ 74	+\$ 88	+\$112	+\$185	+\$232	+\$287	+\$325	+\$393	+\$486	+\$197	+\$749	+\$829



Overall: 25¼"D 28"W 31½"H
 Seat: 18"H
 Arm: 25¼"H



Overall: 25¼"D 28"W 29½"H-33"H
 Seat: 16¼"H-19¾"H
 Arm: 23½"H-27"H

SW_1 Conference Seating Multi-Fabric Diagram

DESIGN SCOTT WILSON & MINIMAL

SIN 711.18

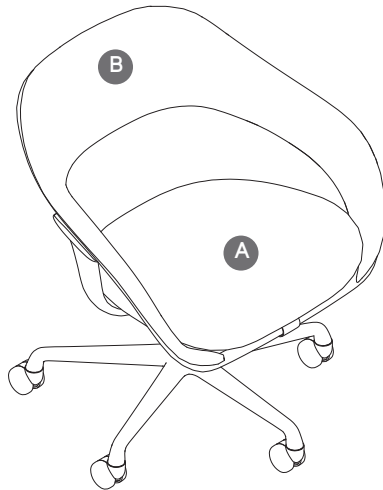

TO: _____

FROM: _____

DATE: _____

FAX....888.413.5161

A Seat: _____

B Arms/Back: _____

Contrasting fabric charges will apply. List price based on highest grade textile specified.

\$121 list upcharge for each contrasting textile pricing based on highest grade textile specified.

Specify Model below:

COW413 Conference Chair with 4-Star Base

COW415 Conference Chair with 5-Star Base

Occasional Tables

Await (SIN 711.11)	226
Bix (SIN 711.18)	227
Enea Tables with Single Base (SIN 711.11)	230
Enea Tables with Twin Base (SIN 711.11)	232
Enea Lottus (SIN 711.11)	235
Sebastopol Occasional Tables (SIN 711.11)	240
Sidewalk (SIN 711.8)	241
Trees (SIN 711.11)	242

Await Occasional Tables

DESIGN E00S

SIN 711.11

Standard Includes		Required to Specify
<ul style="list-style-type: none"> ▶ Need help? Product details, see <i>Coalesse Tables, Storage, and Accessories Specification Guide</i> 	<ul style="list-style-type: none"> • Freestanding table frame: 4142 Platinum Gloss • Top: High-Pressure Laminate top with matching 3 mm edge band • Glass top: <ul style="list-style-type: none"> - 1/2" thick - Radiused edges 	<ol style="list-style-type: none"> 1 Style number 2 Laminate top and tablets, if selected: <ul style="list-style-type: none"> 2730 Arctic White 2746 Black 290N North Sea 3 Glass color number for top, if selected <p>▶ See <i>Coalesse Surface Materials Reference Guide</i>.</p>

Related Products	
<ul style="list-style-type: none"> • Lounge seating • Connector benches 	<ul style="list-style-type: none"> ▶ Page 52 ▶ Page 48

Specification Information					
Style Number	Prices				
	Top Surface:				
	Laminate	Absolute Clear Green Glass	Absolute Clear Glass	Acid Etched 6511	Absolute Colored Glass

Round, Low, Freestanding Table

46-T1	\$1074	\$1284	\$1308	\$1308	\$1480
-------	--------	--------	--------	--------	--------

Round, High, Freestanding Table

46-T2	\$1403	\$1613	\$1637	\$1637	\$1809
-------	--------	--------	--------	--------	--------

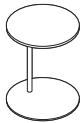

Overall: 15 3/4" Dia. 19"H



Overall: 15 3/4" Dia. 25"H

Bix Side Table—Vinyl Version

DESIGN METRO DESIGN GROUP

SIN 711.18



Standard Includes

- Base: paint
- Table surface and base cover: bronco onyx vinyl

Required to Specify

- 1 Style number
- 2 Paint color number for base
- ▶ See *Surface Materials*, page 259.

Related Products

- Lounge chairs
- Sectional seating
- Podium

- ▶ Page 52
- ▶ Page 54
- ▶ Page 62

Specification Information

Dimensions		Style Number	Price
Diameter	H		
16"	23"	BTS1700	\$525

Bix 18"H Occasional Tables

DESIGN METRO DESIGN GROUP

SIN 711.18

Standard Includes	Required to Specify
<ul style="list-style-type: none"> • Top: <ul style="list-style-type: none"> - Laminate top (Grade 1 laminates) with matching plastic edge - Laminate top (Grade 1 Steelcase) with contrasting plastic edge - Wood top with matching flat wood edge • Base: textured paints only • Grommet, if selected: black plastic only 	1 Style number 2 Laminate or wood color number for top ▶ See Hardwood and Veneer Matrix, page 274 3 Plastic edge color number for top with Grade 1 Steelcase or Grade 2 laminate, if selected 4 Textured paint color number for base 5 Options, if selected (see below) ▶ See <i>Surface Materials</i> , page 259.

Options	Price	Required to Specify
Surface Materials <ul style="list-style-type: none"> • Wood • Custom wood finish 		▶ Page 272
Cable Management <ul style="list-style-type: none"> • PDV module: black plastic 	+\$382 each	Specify with <i>PDV module</i> .
Related Products <ul style="list-style-type: none"> • Lounge chair • Sectional seating 		▶ Page 52 ▶ Page 54

Tip: One or two power, data, and voice modules are available on rectangular occasional tables.

Specification Information

Dimensions				Style Number	Base Prices			
D	W	H	Diameter		Lam 1	Lam 2	Wood 1	Wood 2

Round Occasional Tables

N.A.	N.A.	18"	20"	BTC20001	\$1054	\$1107	\$1167	\$1221
N.A.	N.A.	18"	28"	BTC28001	\$1098	\$1154	\$1220	\$1337

Round Occasional Table with Grommet

N.A.	N.A.	18"	28"	BTC28001U	\$1170	\$1229	\$1292	\$1409
------	------	-----	-----	-----------	--------	--------	--------	--------

Square Occasional Table

24"	24"	18"	N.A.	BTC24241	\$1082	\$1137	\$1201	\$1275
-----	-----	-----	------	----------	--------	--------	--------	--------

Square Occasional Table with Grommet

24"	24"	18"	N.A.	BTC24241U	\$1155	\$1214	\$1274	\$1348
-----	-----	-----	------	-----------	--------	--------	--------	--------

Rectangular Tables

24"	48"	18"	N.A.	BTC24481	\$1752	\$1842	\$1937	\$2087
24"	72"	18"	N.A.	BTC24721	\$1795	\$1887	\$2001	\$2222

Rectangular Occasional Tables with Grommets

24"	48"	18"	N.A.	BTC24481U	\$1895	\$1991	\$2080	\$2230
24"	72"	18"	N.A.	BTC24721U	\$1939	\$2038	\$2145	\$2366

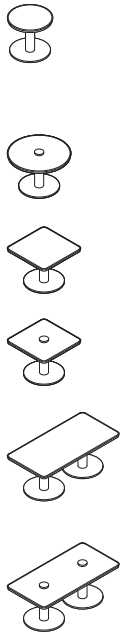

Edge Profiles

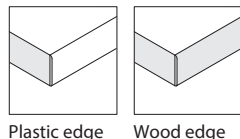

Coalesse

Bix 18"H Occasional Tables

DESIGN METRO DESIGN GROUP

SIN 711.18

Enea Tables

Single Base

DESIGN JOSEP LLUSCA

SIN 711.11

Tip: Shipped knocked down.

Tip: Disc bases are 24" diameter.

Tip: White laminate tops may exhibit slightly visible black specks inherent to the top manufacturing process.

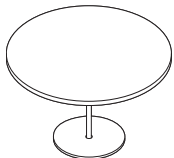
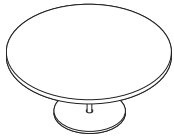
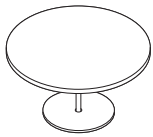

Standard Includes

- Laminate top: 3/4" thick with T-mold edge band
- Wood top: 3/4" thick with maple edge and maple veneer
- Base/frame: steel tubing and base: paint
- Glides: non-skid

Required to Specify

- 1 Style number
- 2 Laminate or wood top color number
▶ See Hardwood and Veneer Matrix, page 274
- 3 Plastic color for edge band of laminate top, if selected:
6D10 Silver Metallic
6D11 Black
6D12 White
- 4 Base/frame finish:
4016 White Gloss
4017 Black Gloss
4018 Silver Metallic
▶ See *Surface Materials*, page 260.

Specification Information

Dimensions		Style Number	Prices		
Diameter	H		Top Surface:		
				Laminate	Wood

Occasional Tables

36"	18"	H35-T3618L	\$ 966	N.A.
36"	18"	H35-T3618W	N.A.	\$1337

42"	18"	H35-T4218L	\$1163	N.A.
42"	18"	H35-T4218W	N.A.	\$1911

Conference Tables

30"	30"	H35-T3030L	\$1137	N.A.
30"	30"	H35-T3030W	N.A.	\$1771

36"	30"	H35-T3630L	\$1197	N.A.
36"	30"	H35-T3630W	N.A.	\$1971

42"	30"	H35-T4230L	\$1377	N.A.
42"	30"	H35-T4230W	N.A.	\$2129

▶ Specification Information, continued on next page

Enea Tables

Single Base

DESIGN JOSEP LLUSCA

SIN 711.11

► Specification Information, continued from previous page

Specification Information

Dimensions		Style	Prices	
Diameter	H	Number	Top Surface:	
			Laminate	Wood

Café/Counter Height Tables

24"	36"	H35-T2436L	\$1098	N.A.
24"	36"	H35-T2436W	N.A.	\$1786
30"	36"	H35-T3036L	\$1200	N.A.
30"	36"	H35-T3036W	N.A.	\$1998
36"	36"	H35-T3636L	\$1243	N.A.
36"	36"	H35-T3636W	N.A.	\$2176
42"	36"	H35-T4236L	\$1435	N.A.
42"	36"	H35-T4236W	N.A.	\$2903

Café/Bar Height Tables

24"	42"	H35-T2442L	\$1131	N.A.
24"	42"	H35-T2442W	N.A.	\$1833
30"	42"	H35-T3042L	\$1212	N.A.
30"	42"	H35-T3042W	N.A.	\$2051
36"	42"	H35-T3642L	\$1251	N.A.
36"	42"	H35-T3642W	N.A.	\$2229

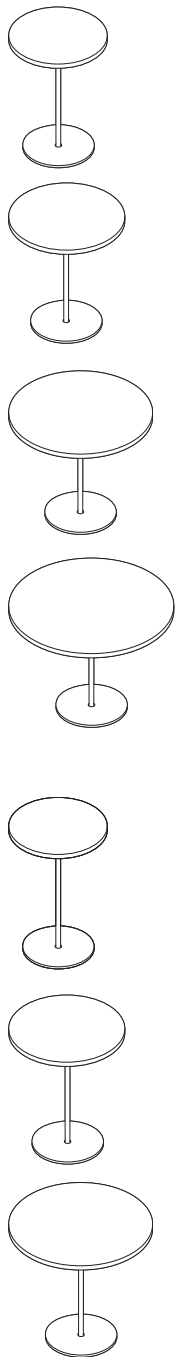

Enea Tables Twin Base

DESIGN JOSEP LLUSCA

SIN 711.11

Tip: Shipped knocked down.

Tip: Due to weight of steel bases, please lift or move tables by bases only (do not lift by tops) with at least two people.

Tip: White laminate tops may exhibit slightly visible black specks inherent to the top manufacturing process.

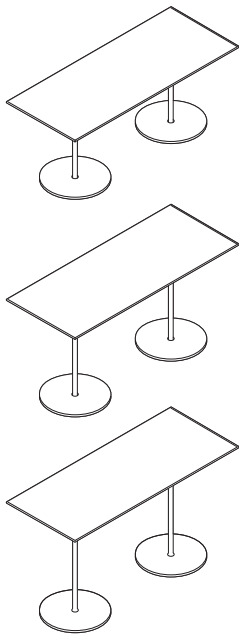

Standard Includes	Required to Specify
-------------------	---------------------

<ul style="list-style-type: none"> Base/frame: steel tubing and base: paint Glides: non-skid Disc bases are 24" diameter Laminate top: 3/4" thick with T-mold edge band Wood top: 3/4" thick with maple edge and maple veneer 	<ol style="list-style-type: none"> 1 Style number 2 Laminate or wood top color number ▶ See Hardwood and Veneer Matrix, page 274 3 Plastic color for edge band of laminate top, if selected: 6D10 Silver Metallic 6D11 Black 6D12 White 4 Base/frame finish: 4016 White Gloss 4017 Black Gloss 4018 Silver Metallic 5 Options, if selected (see below) ▶ See Surface Materials, page 260.
--	--

Options	Price	Required to Specify
---------	-------	---------------------

Interport Power/Data Module	<ul style="list-style-type: none"> Mho power/data module (available in clear anodized aluminum) 	+\$336 Specify with Mho power/data module.
------------------------------------	--	---

Specification Information					
---------------------------	--	--	--	--	--

Dimensions			Style	Base Prices	
D	W	H	Number	Top Surface:	
				Laminate	Wood

Rectangular Tables

30"	72"	30"	H35-T307230GL	\$2823	N.A.
30"	72"	30"	H35-T307230GW	N.A.	\$3987
30"	72"	36"	H35-T307236GL	\$2962	N.A.
30"	72"	36"	H35-T307236GW	N.A.	\$4121
30"	72"	42"	H35-T307242GL	\$3272	N.A.
30"	72"	42"	H35-T307242GW	N.A.	\$4266

▶ Specification Information, continued on next page

Enea Tables

Twin Base

DESIGN JOSEP LLUSCA

SIN 711.11

► Specification Information, continued from previous page

Specification Information

Dimensions			Style Number	Base Prices	
D	W	H		Top Surface:	
				Laminate	Wood

Oval Tables

30"	72"	30"	H35-T307230VL	\$2817	N.A.
30"	72"	30"	H35-T307230VW	N.A.	\$4106

30"	72"	36"	H35-T307236VL	\$2839	N.A.
30"	72"	36"	H35-T307236VW	N.A.	\$4232

30"	72"	42"	H35-T307242VL	\$3101	N.A.
30"	72"	42"	H35-T307242VW	N.A.	\$4345

Conference/Racetrack Tables

30"	72"	30"	H35-T307230KL	\$2844	N.A.
30"	72"	30"	H35-T307230KW	N.A.	\$4152

Counter/Racetrack Tables

30"	72"	36"	H35-T307236KL	\$2968	N.A.
30"	72"	36"	H35-T307236KW	N.A.	\$4258

Café/Racetrack Tables

30"	72"	42"	H35-T307242KL	\$3142	N.A.
30"	72"	42"	H35-T307242KW	N.A.	\$4403

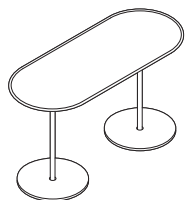
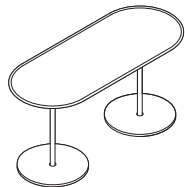
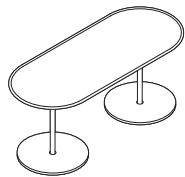
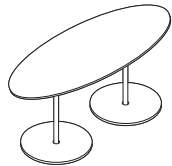

Enea Tables Mho Power Module for Enea Twin Base Tables

SIN 711.11

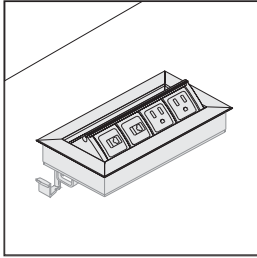
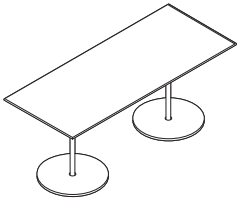

Available Models: **Options:** Available on wood, laminate and finesse covered tops only. Available in centered positions only. Mho not available on Coalesse and CoalesseSpaces.models. Check grid for model availability.

Enea			
Enea			
	H35-T307230GL	Yes	No
	H35-T307230GW	Yes	No
	H35-T307236GL	Yes	No
	H35-T307236GW	Yes	No
	H35-T307242GL	Yes	No
	H35-T307242GW	Yes	No
	H35-T307230VL	Yes	No
	H35-T307230VW	Yes	No
	H35-T307236VL	Yes	No
	H35-T307236VW	Yes	No
	H35-T307242VL	Yes	No
	H35-T307242VW	Yes	No
	H35-T307230KL	Yes	No
	H35-T307230KW	Yes	No
	H35-T307236KL	Yes	No
	H35-T307236KW	Yes	No
	H35-T307242KL	Yes	No
	H35-T307242KW	Yes	No

Color:
Anodized Aluminum

Enea Lottus Occasional Tables

DESIGN LIEVORE ALTHERR MOLINA

SIN 711.11

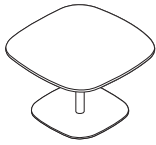

Standard Includes

- Top: laminate or wood veneer with 1/2" thick phenolic core
- Base and frame: steel tubing and base
- Glides: non-skid

Required to Specify

- 1 Style number
- 2 Laminate or wood veneer color number for top
▶ See Veneer Matrix, page 275
- 3 Base/frame finish:
4016 White Gloss
4017 Black Gloss
4217 Brown
4218 Platinum Silver
▶ See *Surface Materials*, page 260.

Specification Information

Dimensions			Style Number	Prices		
D	W	H		Top Surface:		
				Laminate	Wood 1	Wood 2
30"	30"	18"	COEL1830	\$1271	\$1424	\$1538
36"	36"	18"	COEL1836	\$1476	\$1659	\$1798
42"	42"	18"	COEL1842	\$1799	\$1968	\$2128

Enea Lottus Conference Tables

DESIGN LIEVORE ALTHERR MOLINA

SIN 711.11



Standard Includes

- Top: laminate or wood veneer with 1/2" thick phenolic core
- Base and frame: steel tubing and base
- Glides: non-skid

Required to Specify

- 1 Style number
- 2 Laminate or wood veneer color number for top
 - ▶ See Veneer Matrix, page 275
- 3 Base/frame finish:
 - 4016 White Gloss
 - 4017 Black Gloss
 - 4217 Brown
 - 4218 Platinum Silver
 - ▶ See *Surface Materials*, page 260.

Specification Information

Dimensions			Style Number	Prices		
D	W	H		Top Surface:		
				Laminate	Wood 1	Wood 2
30"	30"	30"	COEL3030	\$1327	\$1480	\$1598
36"	36"	30"	COEL3036	\$1531	\$1698	\$1826
42"	42"	30"	COEL3042	\$1850	\$2023	\$2186

Enea Lottus Café Counter Height Tables

DESIGN LIEVORE ALTHERR MOLINA

SIN 711.11

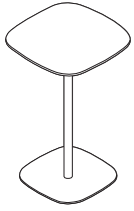

Standard Includes

- Top: laminate or wood veneer with 1/2" thick phenolic core
- Base and frame: steel tubing and base
- Glides: non-skid

Required to Specify

- 1 Style number
- 2 Laminate or wood veneer color number for top
▶ See Veneer Matrix, page 275
- 3 Base/frame finish:
4016 White Gloss
4017 Black Gloss
4217 Brown
4218 Platinum Silver
▶ See *Surface Materials*, page 260.

Specification Information

Dimensions			Style Number	Prices		
D	W	H		Top Surface:		
				Laminate	Wood 1	Wood 2
24"	24"	36"	COEL3624	\$1100	\$1195	\$1292
30"	30"	36"	COEL3630	\$1362	\$1518	\$1641
36"	36"	36"	COEL3636	\$1569	\$1752	\$1898
42"	42"	36"	COEL3642	\$1884	\$2057	\$2223

Enea Lottus Café Bar Height Tables

DESIGN LIEVORE ALTHERR MOLINA

SIN 711.11

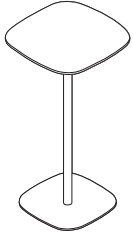

Standard Includes **Required to Specify**

- Top: laminate or wood veneer with 1/2" thick phenolic core
- Base and frame: steel tubing and base
- Glides: non-skid

- 1 Style number
 - 2 Laminate or wood veneer color number for top
 - ▶ See Veneer Matrix, page 275
 - 3 Base/frame finish:
 - 4016 White Gloss
 - 4017 Black Gloss
 - 4217 Brown
 - 4218 Platinum Silver
- ▶ See *Surface Materials*, page 260.

Specification Information

Dimensions			Style Number	Prices		
D	W	H		Top Surface:		
				Laminate	Wood 1	Wood 2
24"	24"	42"	COEL4224	\$1131	\$1230	\$1331
30"	30"	42"	COEL4230	\$1395	\$1548	\$1672
36"	36"	42"	COEL4236	\$1598	\$1777	\$1921
42"	42"	42"	COEL4242	\$1981	\$2154	\$2328

Enea Lottus Rectangular Tables

DESIGN LIEVORE ALTHERR MOLINA

SIN 711.11

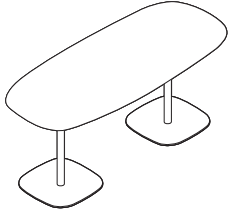

Standard Includes

- Top: laminate or wood veneer with 1/2" thick phenolic core
- Base and frame: steel tubing and base
- Glides: non-skid

Required to Specify

- 1 Style number
- 2 Laminate or wood veneer color number for top
▶ See Veneer Matrix, page 275
- 3 Base/frame finish:
4016 White Gloss
4017 Black Gloss
4217 Brown
4218 Platinum Silver
▶ See *Surface Materials*, page 260.

Specification Information

Dimensions			Style Number	Prices		
D	W	H		Top Surface:		
				Laminate	Wood 1	Wood 2
30"	72"	30"	COEL303072	\$2987	\$3367	\$3641
30"	72"	36"	COEL363072	\$3053	\$3433	\$3711
30"	72"	42"	COEL423072	\$3118	\$3498	\$3782

Sebastopol Occasional Tables

DESIGN EMILIA BORGTHORSDDOTTIR

SIN 711.11

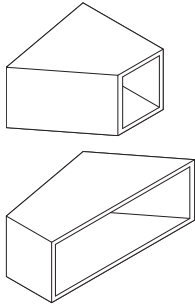

Tip: Optional grommet to accept PowerPod can be specified in milk white or black plastic.

Tip: If a grommet is specified with a PowerPod and the table is over a floor core, the floor core outlet cannot be flush to the floor, because the plug end will not allow the PowerPod to sit in the grommet. If the floor core is flush to the floor and the grommet and PowerPod are required, the table either cannot be set over the floor core, or a special plinth base will be required. Consult your specials representative for additional information on the plinth base.

Standard Includes	Required to Specify
-------------------	---------------------

- | | |
|---|--|
| <ul style="list-style-type: none"> ▶ Need help? Product details, see <i>Coalesse Seating and Outdoor Specification Guide</i> | <ul style="list-style-type: none"> • Exterior surface: veneer grade 1, oak, or walnut • Interior surface: glossy laminate • Glides: concealed adjustable glide with non-marking nylon pad |
|---|--|

- | |
|---|
| <ol style="list-style-type: none"> 1 Style number 2 Exterior surface wood finish number 3 Interior surface glossy laminate: <ul style="list-style-type: none"> 2001 Smoky White 2002 Studio Gray 2003 Wrought Iron 2004 Black Pearl 2005 Liberty Red 4 Options, if selected (see below) ▶ See <i>Coalesse Surface Materials Reference Guide</i> . |
|---|

Options	Price	Required to Specify
---------	-------	---------------------

- | | | |
|---|--------|---|
| Grommet <ul style="list-style-type: none"> • Grommet to accept PowerPod | +\$113 | Specify <i>with grommet</i> and select finish color number either in milk white or black plastic. |
|---|--------|---|

Specification Information

Dimensions			Style Number	Base Prices	
D	W	H		Top Surface:	
				Wood Grade 1	Wood Grade 2

16" High Tables

23"	27"	16"	COEB2723L	\$1243	\$1344
18"	41"	16"	COEB4118L	\$1472	\$1591

22" High Tables

23"	27"	22"	COEB2723H	\$1357	\$1468
18"	41"	22"	COEB4118H	\$1585	\$1713

Sidewalk Occasional Tables

DESIGN STUDIO B

SIN 711.8

Standard Includes	Required to Specify
-------------------	---------------------

- | | |
|---|---|
| <ul style="list-style-type: none"> • Frames constructed of finger jointed select hard maple, reinforced with wood substrate • Legs: silver powder coat steel with "go" glides • Tops: <ul style="list-style-type: none"> - Laminate: 1/2" thick - Wood: 1/2" thick veneered tops and quarter cut book-matched hard maple veneer - Glass: 3/16" thick glass sandblasted with white on back surface - Ships ready to assemble | <ul style="list-style-type: none"> 1 Style number 2 Laminate color number for top, if selected 3 Wood color number for frame <ul style="list-style-type: none"> ▶ See Hardwood and Veneer Matrix, page 274 ▶ See High-Pressure Laminate Matrix, page 278 4 Options, if selected (see below) <ul style="list-style-type: none"> ▶ See <i>Surface Materials</i>, page 260. |
|---|---|

Options	Price	Required to Specify
---------	-------	---------------------

- | | | |
|--|---------|------------------------------|
| Glides <ul style="list-style-type: none"> • "No go" 1/2" polyethylene glides | No cost | Specify with "no go" glides. |
|--|---------|------------------------------|

Specification Information

Dimensions			Style Number	Prices		
D	W	H		Top Surface:		
				Laminate	Wood	Glass
17"	17"	17"	43-T171717	\$1540	\$1540	\$1808
22"	22"	22"	43-T222222	\$1808	\$1808	\$2069

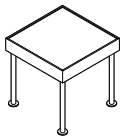
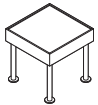

Trees Occasional Tables

DESIGN NORMAN DIEKMAN

SIN 711.11

Tip: Tops come in the same wood and finish but with smooth surface.

Standard Includes		Required to Specify
<ul style="list-style-type: none"> ▶ Need help? Product details, see <i>Coalesse Tables, Storage, and Accessories Specification Guide</i> 	<ul style="list-style-type: none"> • Embossed wood is created under high pressure to add dimensionality and texture on all sides of the table - Interior frame is constructed from a combination of engineered lumber and hardwood veneers - Embossed hardwood veneer is applied to all vertical and slanted surfaces - Embossed wood in Natural EWNT 	1 Style number 2 Options, if selected (see below)

Options	Price	Required to Specify
Surface Materials <ul style="list-style-type: none"> • Bevel high embossed wood (Model 70-C-TPM) available in medium brown EWMB • Bevel medium embossed wood (Model 70-D-TPM) available in medium brown EWMB 	+\$71 +\$71	Specify with <i>medium brown</i> . Specify with <i>medium brown</i> .

Specification Information

Dimensions			Style	Base
D	W	H	Number	Price

Bevel High-Embossed Wood Table

15½"	14"	23"	70-C-TPM	\$2384
------	-----	-----	----------	--------

Bevel Medium-Embossed Wood Table

15½"	14"	19¾"	70-D-TPM	\$2322
------	-----	------	----------	--------

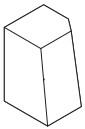

Outdoor



Emu Advanced Collection

Emu Heaven (SIN 71.207)	244
Emu Ivy (SIN 71.207)	250
Emu Re-Trouvé (SIN 71.207)	254
Emu Round (SIN 71.207)	256

Emu Advanced Collection Emu Heaven – Seating

DESIGN JEAN-MARIE MASSAUD

SIN 71.207

Tip: All chairs can stack four high.

Tip: COM outdoor fabric must be an approved outdoor fabric.

Tip: The following powder coat paint finishes are available with an upcharge, as shown at right: 4251 Emu Indian Brown, 4257 Antique Iron, 7272 Blue, 7273 Green, 7294 Emu Grey/Green, 7296 Emu Taupe, 7297 Emu Corten, 7298 Emu Copper, and 7391 Emu Poppy.

Standard Includes	Required to Specify
-------------------	---------------------

<p>► Need help? Product details, see <i>Coalesse Seating and Outdoor Specification Guide</i></p> <ul style="list-style-type: none"> • Frame: hand crafted woven steel mesh • Finish: outdoor grade powder coat paint • Glides: nylon • Cushions: fabric 	<ol style="list-style-type: none"> 1 Style number 2 Powder coat color for frame: 4256 Aluminum 7234 Emu Black 7271 Emu White 3 Fabric color number for upholstery on cushions, if selected 4 Options, if selected (see below) ► See <i>Surface Materials</i>, page 260.
---	---

Options	Price	Required to Specify
---------	-------	---------------------

<p>Surface Materials</p> <ul style="list-style-type: none"> • Acrylic backer • Outdoor cushions • Pouf and pillow cushions • Indoor chair back cushions • Indoor chair cushions • Indoor lounge back cushions • Other Emu paint (cost per pack) • Pouf table base • Chair • Arm chair • Lounge chair 	<p>+\$ 6</p> <p>+\$ 6</p> <p>+\$ 10</p> <p>+\$ 12</p> <p>+\$ 23</p> <p>+\$125</p> <p>+\$150</p> <p>+\$150</p> <p>+\$200</p>	<p>Specify with acrylic backer. Specify with acrylic backer. ► See <i>Surface Materials</i>, page 260.</p> <p>Specify with acrylic backer. Specify with acrylic backer.</p> <p>Specify paint color number. Specify paint color number. Specify paint color number. Specify paint color number.</p>
--	---	---

Specification Information				
---------------------------	--	--	--	--

Dimensions	Style	Quantity	Base	
D W H	Number		Price	

Chairs

23¼"	24½"	31"	CO2485	2	\$1090
------	------	-----	--------	---	--------



Seat height: 17¾"
Seat depth: 16⅞"

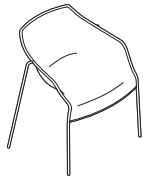

Seat height: 17¾"
Seat depth: 16⅞"
Arm height: 26¾"

Arm Chairs

24"	27¼"	31"	CO2486	2	\$1250
-----	------	-----	--------	---	--------

Lounge Chairs

30¾"	37"	27¼"	CO2487	2	\$2095
------	-----	------	--------	---	--------

► Specification Information, continued on next page

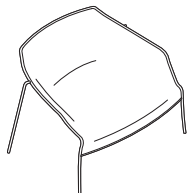

Seat height: 13¾"
Seat depth: 18½"
Arm height: 20½"

Emu Advanced Collection Emu Heaven – Seating

DESIGN JEAN-MARIE MASSAUD

SIN 71.207

Tip: All cushions come in quantity of one.

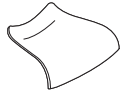

20¾"D x 14½"W x 19"W x ¾"H



20¾"D x 23¾"W x ¾"H



Overall: ¾"D x 22"W x 15½"H

Tip: If a back cushion is specified, a seat cushion must also be specified. The back cushion is not functional without the seat cushion.

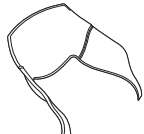

Overall: ¾"D x 28"W x 17½"H



Overall: ¾"D x 34"W x 25"H

Tip: If a back cushion is specified, a seat cushion must also be specified. The back cushion is not functional without the seat cushion.

► Specification Information, continued from previous page

Specification Information

Style Number	Base Prices										Leather Grades:		
	Fabric Grades:										COL	C	E
	COM	6	7	8	9	10	11	12	13	14			

Chair Cushions

Outdoor Cushion

CO2485C	\$273	\$259	N.A.	N.A.	\$298	N.A.	N.A.	N.A.	N.A.	N.A.	N.A.	N.A.	N.A.
---------	-------	-------	------	------	-------	------	------	------	------	------	------	------	------

Indoor Cushion

CO2485B	\$273	\$259	\$264	\$272	\$298	\$315	\$335	\$348	\$372	\$406	\$393	\$ 616	\$ 664
---------	-------	-------	-------	-------	-------	-------	-------	-------	-------	-------	-------	--------	--------

COM/yds = ¾, COL/sq ft = 14

Arm Chair Cushions

Outdoor Cushion

CO2486C	\$279	\$273	N.A.	N.A.	\$326	N.A.	N.A.	N.A.	N.A.	N.A.	N.A.	N.A.	N.A.
---------	-------	-------	------	------	-------	------	------	------	------	------	------	------	------

Indoor Cushion

CO2486B	\$279	\$273	\$280	\$291	\$326	\$349	\$374	\$393	\$425	\$470	\$399	\$ 699	\$ 761
---------	-------	-------	-------	-------	-------	-------	-------	-------	-------	-------	-------	--------	--------

COM/yds = 1, COL/sq ft = 18

Chair Back Cushions

Outdoor Cushion

CO2480C	\$345	\$345	N.A.	N.A.	\$411	N.A.	N.A.	N.A.	N.A.	N.A.	N.A.	N.A.	N.A.
---------	-------	-------	------	------	-------	------	------	------	------	------	------	------	------

Indoor Cushion

CO2480B	\$345	\$345	\$353	\$368	\$411	\$439	\$472	\$495	\$535	\$591	\$462	\$ 947	\$1041
---------	-------	-------	-------	-------	-------	-------	-------	-------	-------	-------	-------	--------	--------

COM/yds = 1¼, COL/sq ft = 28

Arm Chair Back Cushions

Outdoor Cushion

CO2481C	\$358	\$358	N.A.	N.A.	\$438	N.A.	N.A.	N.A.	N.A.	N.A.	N.A.	N.A.	N.A.
---------	-------	-------	------	------	-------	------	------	------	------	------	------	------	------

Indoor Cushion

CO2481B	\$358	\$358	\$369	\$386	\$438	\$472	\$511	\$539	\$587	\$653	\$467	\$1057	\$1170
---------	-------	-------	-------	-------	-------	-------	-------	-------	-------	-------	-------	--------	--------

COM/yds = 1½, COL/sq ft = 33

Lounge Cushions

Outdoor Cushion

CO2487C	\$364	\$364	N.A.	N.A.	\$444	N.A.	N.A.	N.A.	N.A.	N.A.	N.A.	N.A.	N.A.
---------	-------	-------	------	------	-------	------	------	------	------	------	------	------	------

Indoor Cushion

CO2487B	\$364	\$364	\$375	\$392	\$444	\$478	\$517	\$545	\$593	\$659	\$473	\$1063	\$1176
---------	-------	-------	-------	-------	-------	-------	-------	-------	-------	-------	-------	--------	--------

COM/yds = 1½, COL/sq ft = 33

► Specification Information, continued on next page

Emu Advanced Collection Emu Heaven – Seating *continued*

DESIGN JEAN-MARIE MASSAUD

SIN 71.207

► Specification Information, continued from previous page

Specification Information

Style Number	Base Prices											Leather Grades:		
	Fabric Grades:											COL	C	E
	COM	6	7	8	9	10	11	12	13	14				

Lounge Back Cushions

Outdoor Cushion

CO2489C	\$475	\$475	N.A.	N.A.	\$607	N.A.	N.A.	N.A.	N.A.	N.A.	N.A.	N.A.	N.A.
---------	-------	-------	------	------	-------	------	------	------	------	------	------	------	------

Indoor Cushion

CO2489B	\$475	\$475	\$492	\$520	\$607	\$664	\$728	\$774	\$854	\$966	\$548	\$1564	\$1750
---------	-------	-------	-------	-------	-------	-------	-------	-------	-------	-------	-------	--------	--------

COM/yds = 2½, COL/sq ft = 55

Lounge Pillows

Outdoor Pillow

CO2488C	\$206	\$192	N.A.	N.A.	\$231	N.A.	N.A.	N.A.	N.A.	N.A.	N.A.	N.A.	N.A.
---------	-------	-------	------	------	-------	------	------	------	------	------	------	------	------

Indoor Pillow

CO2488B	\$206	\$192	\$197	\$205	\$231	\$248	\$268	\$281	\$305	\$339	\$326	\$ 598	\$ 654
---------	-------	-------	-------	-------	-------	-------	-------	-------	-------	-------	-------	--------	--------

COM/yds = ¾, COL/sq ft = 17

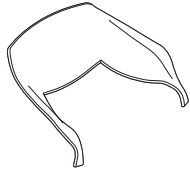

Overall: ¾"D x 34"W x 17½"H



Overall: 4¼"D x 17¼"W x 10½"H

Tip: Lounge pillow is for use with Heaven and Round Lounge chairs.

Specification Information

Dimensions	Style	Quantity	Base
Dia.	Number		Price

Pouf/Side Table Base

17¾"	18½"	CO2495	1	\$470
------	------	--------	---	-------

Glass Top for use with Pouf

17¾"	CO2495V	1	\$219
------	---------	---	-------



Tip: CO2495 pouf must be ordered with glass or cushion top, specified separately.

Tip: Cushions come in quantity of one.

Specification Information

Style Number	Base Prices											Leather Grades:		
	Fabric Grades:											COL	C	E
	COM	6	7	8	9	10	11	12	13	14				

Pouf Cushions

Outdoor Cushion

CO2495C	\$200	\$186	N.A.	N.A.	\$225	N.A.	N.A.	N.A.	N.A.	N.A.	N.A.	N.A.	N.A.
---------	-------	-------	------	------	-------	------	------	------	------	------	------	------	------

Indoor Cushion

CO2495B	\$200	\$186	\$191	\$199	\$225	\$242	\$262	\$275	\$299	\$333	\$320	\$592	\$648
---------	-------	-------	-------	-------	-------	-------	-------	-------	-------	-------	-------	-------	-------

COM/yds = ¾, COL/sq ft = 14



18"Dia. x 2"H

Emu Advanced Collection Emu Heaven – Seating

DESIGN JEAN-MARIE MASSAUD

SIN 71.207

Vases

Standard Includes	Required to Specify
<p>► Need help? Product details, see <i>Coalesse Seating and Outdoor Specification Guide</i></p> <ul style="list-style-type: none"> • Vase: handcrafted woven steel mesh • Finish: 7271 Emu White outdoor grade powder coat paint • Planter insert: white plastic 	<p>Style number</p>

Specification Information

Dimensions		Style Number	Price
Dia.	H		

Low Vase

23½"	40½"	CO2498	\$1522
------	------	--------	--------

High Vase

26¾"	64¼"	CO2497	\$2145
------	------	--------	--------

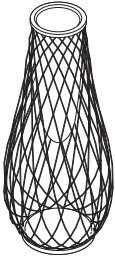

Planter insert dimensions:
Low: 36"H x 13½"Dia
High: 33"H x 13½"Dia

Outdoor

Emu Advanced Collection Emu Heaven – Tables

DESIGN JEAN-MARIE MASSAUD

SIN 71.207

Tip: Tables require glass top, specified separately.

Tip: The following powder coat paint finishes are available with an upcharge, as shown at right: 4251 Emu Indian Brown, 4257 Antique Iron, 7272 Blue, 7273 Green, 7294 Emu Grey/Green, 7296 Emu Taupe, 7297 Emu Corten, 7298 Emu Copper, and 7391 Emu Poppy.

Standard Includes		Required to Specify
<ul style="list-style-type: none"> ▶ Need help? Product details, see <i>Coalesse Seating and Outdoor Specification Guide</i> 	<ul style="list-style-type: none"> • Frame: interwoven steel rods • Finish: outdoor grade powder coat paint • Glides: nylon • Top: tempered glass 	<ol style="list-style-type: none"> 1 Style number 2 Powder coat color for base: 4256 Aluminum, 7271 Emu White 3 Glass top color number for glass top 4 Options, if selected (see below) <p>▶ See <i>Surface Materials</i>, page 260.</p>

Options	Price	Required to Specify
Other Emu paint <ul style="list-style-type: none"> • Round table bases • Low table base 	+\$200 +\$200	Specify paint color number. Specify paint color number.

Specification Information

Dimensions	Style	Base	
Dia.	H	Number	Price

Round Table Bases

For use with 31½" CO2493V Glass Top

31½"	29½"	CO2493	\$1029
------	------	--------	--------



Top of base: 27½" Diameter
Bottom of base: 17¾" Diameter

For use with 47¼" CO2494V Glass Top

47¼"	43⅓"	CO2494	\$2123
------	------	--------	--------

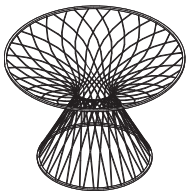

Top of base: 43⅓" Diameter
Bottom of base: 27½" Diameter

Low Table Base

43⅓"	15¼"	CO2496	\$1595
------	------	--------	--------

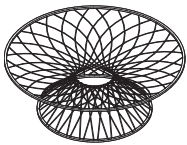

Top of base: 43⅓" Diameter
Bottom of base: 27½" Diameter

Glass Tops

For use with 27½" CO2493 Round Table Base

31½"	¼"	CO2493V	\$ 397
------	----	---------	--------



For use with 43⅓" CO2494 Round or CO2496 Low Table Base

47¼"	¼"	CO2494V	\$ 602
------	----	---------	--------



Coalesse

Emu Advanced Collection

Emu Heaven – Tables

DESIGN JEAN-MARIE MASSAUD

SIN 71.207

Outdoor

Emu Advanced Collection Emu Ivy – Seating

DESIGN PAOLA NAVONE

SIN 71.207

Tip: COM outdoor fabric must be an approved outdoor fabric.

Tip: Cushions must be specified separately.

Tip: The following powder coat paint finishes are available with an upcharge, as shown at right: 4251 Emu Indian Brown, 4256 Aluminum, 4257 Antique Iron, 7234 Black, 7272 Blue, 7273 Green, 7294 Emu Grey/Green, 7296 Emu Taupe, 7297 Emu Corten, 7298 Emu Copper, and 7391 Emu Poppy.

Standard Includes

- ▶ Need help? Product details, see *Coalesse Seating and Outdoor Specification Guide*
- Frame: steel mesh and rod
- Finish: 7271 Emu White outdoor grade powder coat paint
- Glides: nylon
- Cushions: fabric

Required to Specify

- 1 Style number
 - 2 Fabric color number for upholstery on cushions, if selected
 - 3 Options, if selected (see below)
- ▶ See *Surface Materials*, page 260.

Options

Surface Materials	Options	Price
	Acrylic backer	
	• Indoor lounge cushions	+\$ 8
	Other Emu paint (cost per pack)	
	• Pouf	+\$125
	• Lounge chair	+\$300
	• Lounge	+\$500

Required to Specify

- Specify with *acrylic backer*.
▶ See *Surface Materials*, page 260.
- Specify paint color number.
Specify paint color number.
Specify paint color number.
▶ See *Coalesse Surface Materials Reference Guide*.

Specification Information

Dimensions			Style	Quantity	Base
D	W	H	Number		Price

Lounge Chair

35½"	43¼"	26"	C02585	1	\$2684
------	------	-----	--------	---	--------

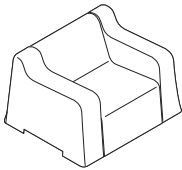

Seat height: 14½"
Seat depth: 21¼"
Arm height: 22½"

Lounge

35½"	75½"	26"	C02586	1	\$4251
------	------	-----	--------	---	--------

▶ Specification Information, continued on next page

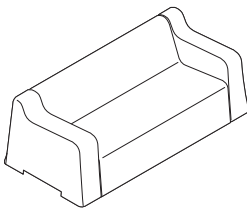

Seat height: 14½"
Seat depth: 21¼"
Arm height: 22½"

Emu Advanced Collection Emu Ivy – Seating

DESIGN PAOLA NAVONE

SIN 71.207

► Specification Information, continued from previous page

Specification Information

Dimensions			Style Number	Quantity	Base Price
D	W	H			
Pouf					
20¾"	Dia.	15¾"	CO2595	1	\$941



Tip: Pouf has solid sheet metal top with a photovoltaic panel filled with five LED lights. LED lights collect and store solar energy to illuminate the under structure at night.

Tip: Cushions come in quantity of one.

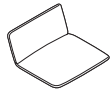

21"D x 24¼"W x 12½"H

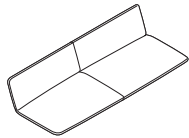

21"D x 56"W x 12½"H

Tip: Lounge cushion is two pieces.

Specification Information

Style Number	Base Prices											Leather Grades:		
	Fabric Grades:											COL	C	E
COM	6	7	8	9	10	11	12	13	14					

Lounge Chair Cushions

Outdoor Cushion

CO2585C	\$ 487	\$ 487	N.A.	N.A.	\$ 579	N.A.	N.A.	N.A.	N.A.	N.A.	N.A.	N.A.	N.A.
---------	--------	--------	------	------	--------	------	------	------	------	------	------	------	------

Indoor Cushion

CO2585B	\$ 487	\$ 487	\$ 498	\$ 518	\$ 579	\$ 619	\$ 664	\$ 696	\$ 752	\$ 831	\$ 586	\$1390	\$1539
COM/yds = 1¾, COL/sq ft = 32													

Lounge Cushions

Outdoor Cushion

CO2586C	\$1027	\$1027	N.A.	N.A.	\$1173	N.A.	N.A.	N.A.	N.A.	N.A.	N.A.	N.A.	N.A.
---------	--------	--------	------	------	--------	------	------	------	------	------	------	------	------

Indoor Cushion

CO2586B	\$1027	\$1027	\$1046	\$1078	\$1173	\$1235	\$1307	\$1356	\$1446	\$1569	\$1092	\$3171	\$3546
COM/yds = 2¾, COL/sq ft = 50													

Emu Advanced Collection Emu Ivy – Table

DESIGN PAOLA NAVONE

SIN 71.207

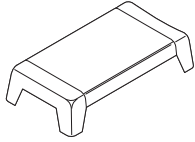

Tip: If selected, tiles ship unattached on the low, rectangular table to allow for customization. Please note, tiles are white when the bug design is selected and tiles are blue when the fish design is selected. Six of the thirty-two tiles have either the bug or fish design, depending on what is specified.

Tip: The following powder coat paint finishes are available with an upcharge, as shown at right: 4251 Emu Indian Brown, 4256 Aluminum, 4257 Antique Iron, 7234 Black, 7272 Blue, 7273 Green, 7294 Emu Grey/Green, 7296 Emu Taupe, 7297 Emu Corten, 7298 Emu Copper, and 7391 Emu Poppy.

Standard Includes	Required to Specify
-------------------	---------------------

- | | |
|---|--|
| <ul style="list-style-type: none"> ▶ Need help? Product details, see <i>Coalesse Seating and Outdoor Specification Guide</i> | <ul style="list-style-type: none"> • Top: Low, rectangular table, formed steel mesh • Legs: formed steel mesh • Glides: nylon • Finish: 7271 Emu White outdoor grade powder coat paint |
| | <ul style="list-style-type: none"> 1 Style number 2 Options, if selected (see below) |

Options	Price	Required to Specify
---------	-------	---------------------

Surface Materials	Tiles for low, rectangular table <ul style="list-style-type: none"> • Blue fish tile +\$845 • White bug tile +\$845 	Specify <i>with fish tile</i> . Specify <i>with bug tile</i> .
	Other Emu paint <ul style="list-style-type: none"> • Low, rectangular table +\$300 	Specify paint color number.

Specification Information				
---------------------------	--	--	--	--

Dimensions			Style	Base
D	W	H	Number	Price

Low, Rectangular Table

29¼"	53¼"	11¾"	C02589	\$1652
------	------	------	--------	--------

Coalesse

Emu Advanced Collection

Emu Ivy – Tables

DESIGN PAOLA NAVONE

SIN 71.207

Outdoor

Emu Advanced Collection Emu Re-Trouvé – Seating

DESIGN PATRICIA URQUIOLA

SIN 71.207

Tip: COM outdoor fabric must be an approved outdoor fabric.

Tip: Cushions must be specified separately.

Tip: The following powder coat paint finishes are available with an upcharge, as shown at right: 4251 Emu Indian Brown, 4256 Aluminum, 4257 Antique Iron, 7234 Black, 7272 Blue, 7273 Green, 7294 Emu Grey/Green, 7296 Emu Taupe, 7297 Emu Corten, 7298 Emu Copper, and 7391 Emu Poppy.

Standard Includes		Required to Specify
► Need help? Product details, see <i>Coalesse Seating and Outdoor Specification Guide</i>	<ul style="list-style-type: none"> • Frame: hot-dipped steel rod, hand welded • Finish: 7271 Emu White outdoor grade powder coat paint • Seat: steel tube and ironed sheet metal • Glides: PVC • Cushions: fabric 	1 Style number 2 Fabric color number for upholstery on cushions, if selected 3 Options, if selected (see below) ► See <i>Surface Materials</i> , page 260.

Options	Price	Required to Specify
Surface Materials		
Acrylic backer		
• Indoor chair seat and pouf cushions only	+\$ 8	Specify with acrylic backer
• Chair seat and back indoor cushions only	+\$ 12	Specify with acrylic backer. ► See <i>Surface Materials</i> , page 260.
Other Emu paint		
• Mid-back chair	+\$150	Specify paint color number.
• High-back chair	+\$150	Specify paint color number.
• Pouf	+\$150	Specify paint color number.

Specification Information

Dimensions	Style	Base
D W H	Number	Price

Mid-Back Chair

23½"	26"	30¾"	CO2565MB	\$1156
------	-----	------	----------	--------



Seat height: 17¾"

High-Back Chair

24"	30"	41¼"	CO2566HB	\$1366
-----	-----	------	----------	--------



Seat height: 17¾"

Pouf

17¾" dia.	17¾"	CO2575	\$ 748
-----------	------	--------	--------



Tip: Cushions fit all chairs. Pouf requires seat cushion only.

Tip: Cushions come in quantity of one.

Specification Information

Style Number	Base Prices												Leather Grades:		
	Fabric Grades:												COL	C	E
COM	6	7	8	9	10	11	12	13	14						

Chair Seat and Pouf Cushions

Outdoor Cushion													
CO2575C	\$241	\$235	N.A.	N.A.	\$288	N.A.	N.A.	N.A.	N.A.	N.A.	N.A.	N.A.	N.A.
Indoor Cushion													
CO2575B	\$241	\$235	\$242	\$253	\$288	\$311	\$336	\$355	\$387	\$432	\$361	\$739	\$814
COM/yds = 1, COL/sq ft = 18													

► Specification Information, continued on next page

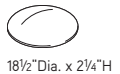

18½"Dia. x 2¼"H

Emu Advanced Collection Emu Re-Trouvé – Seating

DESIGN PATRICIA URQUIOLA

SIN 71.207

► Specification Information, continued from previous page

Specification Information

Style Number	Base Prices										Leather Grades:		
	Fabric Grades:										COL	C	E
COM	6	7	8	9	10	11	12	13	14				



20"D x 20½"W x 10"H

Chair Seat and Back Cushions

Outdoor Cushion

CO2566C	\$434	\$434	N.A.	N.A.	\$500	N.A.	N.A.	N.A.	N.A.	N.A.	N.A.	N.A.	N.A.
----------------	-------	-------	------	------	-------	------	------	------	------	------	------	------	------

Indoor Cushion

CO2566B	\$434	\$434	\$442	\$457	\$500	\$528	\$561	\$584	\$624	\$680	\$551	\$1248	\$1379
----------------	-------	-------	-------	-------	-------	-------	-------	-------	-------	-------	-------	--------	--------

COM/yds = 1¼, COL/sq ft = 27

Vase Frames and Vase Insert

Tip: The following powder coat paint finishes are available with an upcharge, as shown at right: 4251 Emu Indian Brown, 4256 Aluminum, 4257 Antique Iron, 7234 Black, 7272 Blue, 7273 Green, 7294 Emu Grey/Green, 7296 Emu Taupe, 7297 Emu Corten, 7298 Emu Copper, and 7391 Emu Poppy.

Standard Includes	Required to Specify
-------------------	---------------------

- | | |
|---|--|
| <ul style="list-style-type: none"> Frame: hot-dipped steel rod, hand welded Finish: 7271 Emu White outdoor grade powder coat paint Vase insert, if selected: white ceramic | <ul style="list-style-type: none"> 1 Style number 2 Options, if selected (see below) |
|---|--|

Options	Price	Required to Specify
---------	-------	---------------------

- | | | |
|--|--|--|
| <ul style="list-style-type: none"> Other Emu paint Low vase frame High vase frame | <ul style="list-style-type: none"> +\$200 +\$200 | <ul style="list-style-type: none"> Specify paint color number. Specify paint color number. |
|--|--|--|

Specification Information

Dimensions	Style	Base
Dia. H	Number	Price

Low Vase Frame

25½"	28"	CO2578	\$1486
------	-----	--------	--------

High Vase Frame

28¼"	41¼"	CO2577	\$1851
------	------	--------	--------

Vase Insert

24½"	14½"	CO2580	\$ 467
------	------	--------	--------



Outdoor

Emu Advanced Collection Emu Round – Seating

DESIGN CHRISTOPHE PILLET

SIN 71.207

Tip: Stool and lounge stacks four high. Chair stacks eight high.

Tip: The following powder coat paint finishes are available with an upcharge, as shown at right: 4256 Aluminum, 7272 Blue, 7273 Green, 7294 Emu Grey/Green, 7296 Emu Taupe, 7297 Emu Corten, 7298 Emu Copper, and 7391 Emu Poppy.

Standard Includes Required to Specify

- | | | |
|--|---|---|
| <p>► Need help? Product details, see <i>Coalesse Seating and Outdoor Specification Guide</i></p> | <ul style="list-style-type: none"> • Frame: metal mesh seat, crafted using a deep drawing technique, welded to a tubular steel frame • Finish: outdoor grade powder coat paint • Glides: nylon | <ol style="list-style-type: none"> 1 Style number 2 Powder coat color for frame: 4251 Emu Indian Brown, 4257 Antique Iron, 7234 Emu Black, 7271 Emu White 3 Options, if selected (see below) |
|--|---|---|

Options Price Required to Specify

Surface Materials	Options	Price	Required to Specify
	Acrylic backer		
	• Indoor stool cushions only	+\$ 10	Specify with acrylic backer.
	• Indoor chair cushions only	+\$ 12	Specify with acrylic backer.
	• Indoor lounge cushions only	+\$ 23	Specify with acrylic backer.
	• Indoor pillow cushions only	+\$ 6	Specify with acrylic backer.
	Other Emu paint (cost per pack)		► See <i>Surface Materials</i> , page 260.
	• Stool	+\$150	Specify paint color number.
	• Armless chair	+\$200	Specify paint color number.
	• Arm chair	+\$200	Specify paint color number.
	• Lounge	+\$200	Specify paint color number.

Specification Information

Dimensions	Style	Quantity	Base
D W H	Number		Price

Stools

20½"	22¾"	39¼"	CO2467	2	\$1115
------	------	------	--------	---	--------

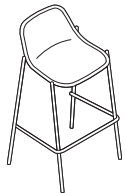

Seat height: 28"



Seat height: 17¾"

Armless Chairs

23¼"	24¾"	32"	CO2465	4	\$1426
------	------	-----	--------	---	--------

Arm Chairs

23¼"	24¾"	32"	CO2466	4	\$1562
------	------	-----	--------	---	--------



Seat height: 17¾"
Arm height: 26"

Lounges

34¼"	36¼"	33"	CO2469	2	\$1521
------	------	-----	--------	---	--------

► Specification Information, continued on next page

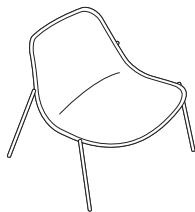

Seat height: 15"
Seat depth: 22½"

Emu Advanced Collection Emu Round – Seating

DESIGN CHRISTOPHE PILLET

SIN 71.207

Tip: All cushions come in quantity of one.

Tip: Cushions are one piece with a slit to allow for water drainage.



Overall: 3/4"D x 22"W x 28"H



Overall: 3/4"D x 18"W x 22 1/2"H

Tip: Chair cushion for use on chair and arm chair.

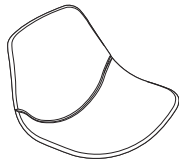

Overall: 3/4"D x 34"W x 40"H



Overall: 4 1/4"D x 17 1/4"W x 10 1/2"H

Tip: Lounge pillow is for use with Heaven and Round Lounge chairs.

► Specification Information, continued from previous page

Specification Information

Style Number	Base Prices										Leather Grades:		
	Fabric Grades:										COL	C	E
	COM	6	7	8	9	10	11	12	13	14			

Stool Cushions

Outdoor Cushion

CO2467C	\$328	\$328	N.A.	N.A.	\$394	N.A.	N.A.	N.A.	N.A.	N.A.	N.A.	N.A.	N.A.
---------	-------	-------	------	------	-------	------	------	------	------	------	------	------	------

Indoor Cushion

CO2467B	\$328	\$328	\$336	\$351	\$394	\$422	\$455	\$478	\$518	\$574	\$445	\$ 930	\$1024
---------	-------	-------	-------	-------	-------	-------	-------	-------	-------	-------	-------	--------	--------

COM/yds = 1 1/4, COL/sq ft = 28

Chair Cushions

Outdoor Cushion

CO2465C	\$341	\$341	N.A.	N.A.	\$421	N.A.	N.A.	N.A.	N.A.	N.A.	N.A.	N.A.	N.A.
---------	-------	-------	------	------	-------	------	------	------	------	------	------	------	------

Indoor Cushion

CO2465B	\$341	\$341	\$352	\$369	\$421	\$455	\$494	\$522	\$570	\$636	\$450	\$1040	\$1153
---------	-------	-------	-------	-------	-------	-------	-------	-------	-------	-------	-------	--------	--------

COM/yds = 1 1/2, COL/sq ft = 33

Lounge Cushions and Pillows

Outdoor Cushion

CO2469C	\$471	\$471	N.A.	N.A.	\$603	N.A.	N.A.	N.A.	N.A.	N.A.	N.A.	N.A.	N.A.
---------	-------	-------	------	------	-------	------	------	------	------	------	------	------	------

Indoor Cushion

CO2469B	\$471	\$471	\$488	\$516	\$603	\$660	\$724	\$770	\$850	\$962	\$544	\$1560	\$1746
---------	-------	-------	-------	-------	-------	-------	-------	-------	-------	-------	-------	--------	--------

COM/yds = 2 1/2, COL/sq ft = 55

Outdoor Pillow

CO2488C	\$206	\$192	N.A.	N.A.	\$231	N.A.	N.A.	N.A.	N.A.	N.A.	N.A.	N.A.	N.A.
---------	-------	-------	------	------	-------	------	------	------	------	------	------	------	------

Indoor Pillow

CO2488B	\$206	\$192	\$197	\$205	\$231	\$248	\$268	\$281	\$305	\$339	\$326	\$ 598	\$ 654
---------	-------	-------	-------	-------	-------	-------	-------	-------	-------	-------	-------	--------	--------

COM/yds = 3/4, COL/sq ft = 17

Emu Advanced Collection Emu Round – Tables

DESIGN CHRISTOPHE PILLET

SIN 71.207

Tip: The following powder coat paint finishes are available with an upcharge, as shown at right: 4256 Aluminum, 7272 Blue, 7273 Green, 7294 Emu Grey/Green, 7296 Emu Taupe, 7297 Emu Corten, 7298 Emu Copper, and 7391 Emu Poppy.

Standard Includes	Required to Specify
-------------------	---------------------

- | | | |
|--|--|--|
| <p>► Need help? Product details, see <i>Coalesse Seating and Outdoor Specification Guide</i></p> | <ul style="list-style-type: none"> • Frame: table top and base are sheet metal with tubular steel mountings • Finish: outdoor grade powder coat paint • Glides: nylon | <ol style="list-style-type: none"> 1 Style number 2 Powder coat color for frame: <ul style="list-style-type: none"> 4251 Emu Indian Brown 4257 Antique Iron 7234 Emu Black 7271 Emu White 3 Options, if selected (see below) |
|--|--|--|

Options	Price	Required to Specify
---------	-------	---------------------

- | | | |
|--|--|---|
| <p>Other Emu paint</p> <ul style="list-style-type: none"> • Square tables • Round table • Counter table • Side table • Rectangle table | <ul style="list-style-type: none"> +\$125 +\$125 +\$125 +\$125 +\$150 | <ul style="list-style-type: none"> Specify paint color number. Specify paint color number. Specify paint color number. Specify paint color number. Specify paint color number. |
|--|--|---|

Specification Information					
---------------------------	--	--	--	--	--

Dimensions	Style	Base
D W H	Number	Price

Square Tables

23½"	23½"	29½"	CO2472	\$ 586
27½"	27½"	29½"	CO2471	\$ 691
31½"	31½"	29½"	CO2473	\$ 734

Round Table

35½" dia.	29½"	CO2470	\$ 783
-----------	------	--------	--------

Rectangle Table

31½"	47½"	29½"	CO2474	\$1143
------	------	------	--------	--------

Counter Table

23½"	23½"	41¼"	CO2475	\$ 707
------	------	------	--------	--------

Side Table

31½"	31½"	16½"	CO2477	\$ 508
------	------	------	--------	--------

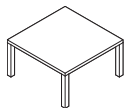
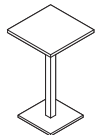
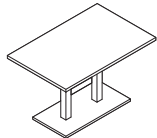
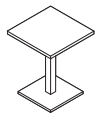

Surface Materials

► For more detailed Coalesse surface material information, see the *Coalesse Surface Materials Reference Guide* or consult your Steelcase dealer.

Surface Materials-Upholstery	260
Customer's Own Material	262
Flammability Information	264
Upholstery Matrix	265
Surface Materials-Leather/Faux	268
Cut Yardage Net Price List	270
Leather and Faux Leather Matrix	271
Surface Materials-Wood	272
Hardwood Matrix	274
Veneer Matrix	275
Surface Materials-Laminate	276
High-Pressure Laminate Matrix	278
Laminate Edge Band Matrix	282
Surface Materials-Glass	284
Glass Matrix	285
Surface Materials-Metal/Paint	286
Metal/Paint Matrix	288
Emu Advanced Collection Paint Matrix	292
Surface Materials-Miscellaneous	293
Ordering	294
Care and Maintenance	296

Surface Materials - Upholstery

Upholstery

All Coalesse textiles are priced by grades. Some Coalesse fabrics can be treated for flame retardancy, contact Customer Service. All Coalesse products are handcrafted making each unique. Certain fabrics and leathers will appear loose and may differ from like products due to comfort wrinkles when upholstered.

A contrasting welt is available on some products. Consult Customer Service for yardage or square feet requirements and prices. All stripes will be applied vertically unless customer specifies otherwise. Loose cushions on Coalesse products are not fully upholstered (not reversible).

Designtex, Maharam, Steelcase, and select Luna fabrics are graded in our pricing. Simply order Coalesse products with Designtex, Maharam, Steelcase, and select Luna specified. Designtex, Maharam, Steelcase, and select Luna fabrics are graded in on Coalesse products; however, Coalesse does not stock fabrics and can only respond based on Designtex, Maharam, Steelcase, and select Luna fabrics lead times. For current grades, refer to Coalesse website: www.Coalesse.com.

Special Fabric Applications

Backing

- Backing information is found on each product page. Select this option when ordering your product to have backing applied. Price varies by product according to yardage it requires.

Tip: Prices subject to change without notice and an additional 2 week lead time will apply for 54" wide fabrics. Wider fabrics will require 4 week additional lead time. Check fabric database to determine if backing is required at www.Coalesse.com.

Seating Upholstery

Coalesse fabrics are priced by grades from 6 through 14 and leathers C and E. Fabrics and leathers may be purchased separately as cut yardage, see page 360. All products are handcrafted, making each unique. Certain fabrics and leathers will appear loose and may differ from like products due to wrinkles when upholstered. A contrasting welt is available on some products. Consult Customer Service for yardage or square feet requirements for pricing.

All stripes will be applied vertically unless customer specifies otherwise. Loose cushions on Coalesse products are not fully upholstered (not reversible). Any graded-in or COM textile should be reviewed with supplier to verify availability. In some cases a textile supplier may require minimums that exceed your furniture order requirements. In these situations, you will be contacted with an option to select a different textile or continue with your original textile selection as a COM-DTP. If you choose to continue with your textile selection as COM-DTP to allow you to order the minimum required, please ship only the textile needed to Coalesse for your furniture order.

Emu Upholstery

Applies to: Emu Advanced Collection Outdura Collection

Fabric Grade 6

5G30	Natural White
5G31	Kona
5G32	Sandstone
5G33	Cadet Grey
5G34	Stone
5G35	China Red
5G36	Cardinal Red
5G37	Solid Aquamarine
5G38	Canary
5G39	Pesto
5G41	Island Blue

SW_1 Knit

Applies to: SW_1 Collection

5KG0	Stone
5KG1	Grey
5KG2	Brown
5KG3	Black
5KG4	Ivory
5KG5	Coal
5KG6	Garnet
5KG7	Golden
5KG8	Royal

Lagunitas Knit

Applies to: Lagunitas focus nook and lounge system

Grade 1

5K50	Stone
5K51	Grey
5K54	Black
5K58	Ivory
5K59	Coal

Grade 2

5K52	Cement
5K53	Brown
5K55	Garnet
5K56	Golden
5K57	Royal
5K60	Glacier
5K61	Cadet
5K62	Grass
5K63	Forest
5K64	Amber
5K65	Terracotta
5K66	Crimson
5K67	Berry
5K68	Violet
5K69	Khaki

Hexa Upholstery

Applies to: Hosu

Fabric Grade 10

CL50	Dark Grey
CL51	Light Grey
CL52	Blue
CL53	Green
CL54	Red
CL55	Yellow

Fusion Upholstery

Applies to: Hosu lounge and Lagunitas personal table

Fabric Grade 11

CL60	Caviar
CL61	Portobello
CL62	Graphite
CL63	Java
CL64	Steam*

* Not available on Hosu

Surface Materials - Steelcase Upholstery

Steelcase Upholstery

Coalesse offers a select palette of Steelcase fabrics as standard. This provides the convenience of an integrated finish offering and ease of specification. See the Steelcase Standard Fabric Matrix for availability by product line. For a visual reference, please refer to the Steelcase Finish Library.

Grade 6

Cogent: Connect

- 5S15 Coconut
- 5S16 Turmeric/Honey
- 5S17 Tangerine
- 5S18 Scarlet
- 5S19 Concord
- 5S20 Maya Blue
- 5S21 Blue Jay
- 5S23 Wasabi
- 5S24 Nickel
- 5S25 Graphite
- 5S26 Licorice
- 5S27 Malt
- 5S28 Root Beer
- 5S93 Blueprint
- 5S94 Lizard/Jungle
- 5S95 Sailor
- 5S96 Quicksilver
- 5S98 Canary
- 5S99 Lipstick/Merlot
- 5SD0 Royal Blue

Jacks

- 5B61 Taupe
- 5B62 Camel
- 5B64 Pewter
- 5B70 Midnight

Seating Vinyl

- 5801 Topaz
- 5805 Foggy Night
- 5809 Black
- 5810 Forest
- 5812 Navy
- 5813 Currant
- 5814 Leaf
- 5815 Seaside
- 5817 Pebble
- 5818 Spice
- 5819 Thistle
- 5820 Coffee
- 5822 Iris

Spyder

- 5B01 Foggy Night
- 5B04 Peri

Nitelights

- 5F58 Hazelnut
- 5F61 Earth
- 5F62 Shore
- 5F63 Moss
- 5F65 Regal Blue
- 5F66 Stone
- 5F67 Moon

Link

- 5A20 Burgundy
- 5A23 Green
- 5A24 Blue
- 5A25 Navy
- 5A26 Purple
- 5A27 Black
- 5A28 Ocean
- 5A30 Chamois

Grade 7

Stand In

- 5621 Sleet
- 5622 Lunar
- 5623 Cyclone
- 5624 Eclipse
- 5625 Powder
- 5626 Chardonnay
- 5627 Graham
- 5628 Sediment
- 5629 Allspice
- 5630 Apple
- 5631 Lava
- 5632 Cayenne
- 5633 Plantain
- 5634 Parsley
- 5635 Scallion
- 5636 Atlantis
- 5691 Orca
- 5740 Burlap
- 5741 Porter
- 5742 Tusk
- 5743 Putty
- 5744 Blueberry
- 5745 Charteuse
- 5746 Mango
- 5747 Sedona
- 5748 Juniper
- 5749 Peanut

Cogent: Trails

- 5S29 Bronzite
- 5S85 Agate
- 5S86 Lapis
- 5S87 Malachite
- 5S88 Quartz
- 5S90 Tiger Eye
- 5S91 Travertine
- 5S92 Topaz

New Black

- 5J08 Jack
- 5J09 James
- 5J12 Harley

Imperma

- TM01 Toffee
- TM02 Pigeon
- TM03 Fossil
- TM04 Poppyseed
- TM05 Auburn
- TM06 Cumin
- TM07 Marble
- TM08 Cliff
- TM09 Tarragon
- TM10 Pesto
- TM11 Wave
- TM12 Niagara
- TM13 Tuscan
- TM14 Peppercorn

Grade 8

Billiard Multi-Use by Designtex

- 5H10 Bone
- 5H11 Poppy
- 5H12 Tangelo
- 5H13 Citron
- 5H14 Avocado
- 5H15 Hunter
- 5H16 Indigo
- 5H17 Mallard
- 5H18 Teak
- 5H19 Cumulus
- 5H20 Pewter
- 5H21 Gunmetal
- 5H22 Ink

Texel

- TM20 Angora
- TM21 Grist
- TM22 Galaxy
- TM23 Terracotta
- TM24 Nude
- TM25 Field
- TM26 Haze

Grade 9

Remix

- RE01 Rust
- RE02 Pumpkin
- RE03 Pebble
- RE04 Dark Chocolate
- RE05 Beige
- RE06 Linen Beige
- RE07 Hazelnut
- RE08 Concrete
- RE09 Sky Blue
- RE10 Blue Jean
- RE11 Ivy Green
- RE12 Primavera Yellow
- RE13 Night Blue

Bo Peep

- 5G66 Pita
- 5G67 Bone
- 5G68 Safari
- 5G69 Brown Sugar
- 5G70 Chocolate
- 5G71 Candlelight
- 5G72 Honey Mustard
- 5G73 Marmalade
- 5G74 Picnic
- 5G75 Pinot
- 5G76 Bloom
- 5G77 Grapevine
- 5G78 Firefly
- 5G79 Artichoke
- 5G80 Serpent
- 5G81 Carolina
- 5G82 Blue Bonnet
- 5G83 Nautical
- 5G84 Gravel
- 5G85 Sharkskin
- 5G86 Kohl

Customer's Own Material

CUSTOMER'S OWN MATERIAL

Coalesse is pleased to cooperate with COM/COL selections. Prior to order placement for exact yardage requirements, a sample cutting of actual COM/COL must be submitted to Coalesse for approval only if fabric approval is not found in Coalesse fabric database. Identify the name and number of units on which the fabric/leather is to be applied. If COM has a repeat the sample should be large enough to show the entire repeat. Coalesse will not accept nor use any painted leathers. A painted leather is described as any suede or leather which is not aniline dyed with the same color throughout the thickness of the hide.

Even after preliminary approval, Coalesse reserves the right to reject COM/COL if necessary when the quality is not satisfactory for the item it is intended to be used on. Once COM/COL is accepted Coalesse assumes no responsibility for its overall appearance, flammability, normal durability, colorfastness, or any other quality, after upholstered on a Coalesse product.

COALESSE STANDARD TO BUY PROGRAM

The Customer's Own Material (COM) Program offers the opportunity for customers to select fabrics that are not offered through the standard Coalesse surface materials program for use on our products. Through the COM program, Coalesse will test your materials for application on Coalesse products. Once approved, you can place your order. Coalesse will facilitate the entire ordering process and give you a production schedule. Coalesse will order the COM fabric directly from the textile manufacturer. For up-to-date information regarding fabric test results for all COM fabrics and details regarding yardage requirements for most Seating lines, visit the fabric database at www.coalesse.com.

CUSTOMERS TO BUY SCHEDULING POLICY/COM/COL POLICY

COM/COL must be received at manufacturing location no later than 20 working days prior to the order scheduled delivery date. If COM/COL is not received in this time frame, scheduling will move the order's delivery date out to the best available ship date. Customer Service will notify the dealer via e-mail of the order's new scheduled delivery date. Project size order shipment may be affected due to size of order. If the COM/COL is received and the COM/COL requires backing, scheduling will move order out to best available ship date. Backing charges will apply. If COM/COL is received defective or short yardage/sq. ft., the replacement COM/COL order must be received within 3 days to maintain scheduled delivery date on order. It is the responsibility of the dealer to advise Coalesse on what to do with defective materials. In addition, customers may request Coalesse to order for COM/COL materials.

SQUARE FOOTAGE/ YARDAGE REQUIREMENTS

COM and COL price includes application of Customer's Own Material or Leather to frames. All COM and COL should be shipped freight prepaid to designated manufacturing location. Labels will be provided by your Customer Service representative to ensure clear textile identification.

Please have customers send COM/COL and add TAG: COM/ COL.

COM and COL must be identified as follows to prevent order delays:

1. Name and address (Should match purchase order)
2. Your furniture purchase order number/sales order
3. Style number to which fabric is to be applied
4. Supplier name and fabric name, number, and color

COL hides must be rolled for shipment to manufacturing location in a neat manner, avoiding creases and excessive roll marks. All leathers will be rejected if sent in a folded manner.

To determine COL square footage, see COL requirements for each product. Square footage requirements are based on an average hide size of 45-50 square feet of clean, usable leather. If the COL has a smaller average hide size, please consult Customer Service for quotation. Please note, leather is a natural product and all square footage requirements are estimations. The shape of the COL hides supplied and the usable, clean square footage may make it necessary for us to request more leather after COL is received.

Yardage requirements shown are based on 54" width plain material. If fabric design requires vertical/top out, Customer Service should be consulted for additional yards required. If fabric is under 54", refer to fabric database at www.coalesse.com.

EXCESS COM/COL POLICY

All excess COM/COL will be disposed of after order is completed unless prior arrangements have been made with Coalesse Customer Service. Fedex account number and address to ship to must be referenced. Excess WILL NOT be returned with shipment of furniture.

Customer's Own Material

Cutting Direction Guidelines

Cutting direction is based on the fabric width and the way the fabric is cut from the roll and applied to Coalesse products. There are two cutting directions: railroaded or horizontal.

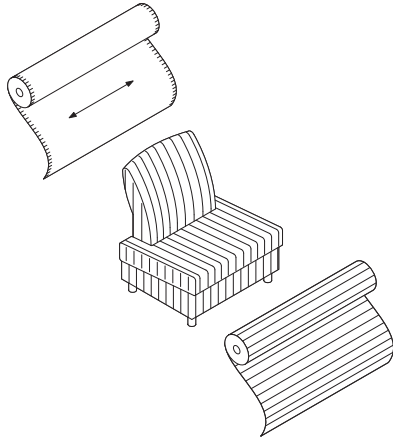

Horizontal or railroaded (across roll, warp horizontal) means fabric is cut across the roll; selvages are on the top and bottom.

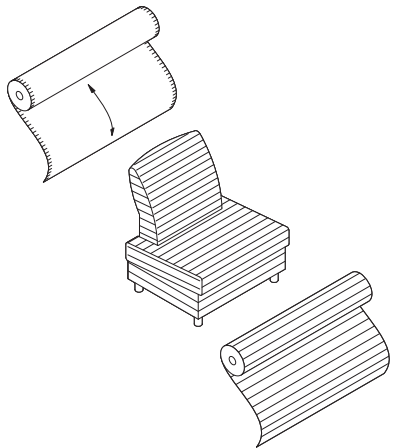

Vertical or top out (down roll, warp vertical) means fabric is cut in the same direction it is woven; selvages are on the left and right sides.

Flammability Information

California Technical Bulletin 133

Definition: California Technical Bulletin 133 (CAL 133) is a flammability test procedure for seating furniture specified in public occupancies. Specifications, test procedures and requirements pertaining to flammability regulations are changing rapidly. Coalesse will make every effort to keep our information and services pertaining to flammability specifications up-to-date.

Coalesse reserves the right to make deletions and additions and cannot guarantee fabric manufacturer materials nor its specifications will not change. A new evaluation will be necessary if materials are altered by manufacturer. This approval information on our website is subject to change without notice. Coalesse is not responsible for textile manufacturer's changes. Contact fabric manufacturer for availability.

For fabrics not pre-approved, please submit the fabric supplier name, fabric name, style number, content, weight, Coalesse product number, and fabric name to be applied to Customer Service at 1.800.627.6770 or fax to 888.413.5161. Our Customer Service representative will contact you within 48 hours of your request with information on the fabric's CAL 133 compliance. Actual fabric sample may be required. **If not approved, a burn test may be required at a fee. Contact Customer Service for a quote.**

UFAC – All upholstered seating is constructed to conform to UFAC (Upholstered Furniture Action Council) specifications. This is comparable to NFPA 260. All Coalesse fabrics and leathers meet UFAC specifications and NFPA 260 requirements.

California Bureau of Home Furnishings Technical Bulletin 117

All Coalesse upholstered seating, fabrics, and leathers meet California Technical Bulletin 117. All products manufactured after May 1, 1993 have CAL 117 label attached.

California Bureau of Home Furnishings Technical Bulletin 133

On March 1, 1992 Technical Bulletin 133 (TB 133), a fire test for seating furniture in public buildings, became law in California. On and after March 1, 1992 all seating furniture sold in California for use in the public buildings specified in the regulations, must be in compliance with the requirements of TB 133, and each product must be labeled stating that the furniture meets TB 133. If a building is fully sprinklered, compliance with TB 133 becomes discretionary, however, even in sprinklered buildings all furniture must meet the minimum fire standards of the bureau's Technical Bulletin 117.

California Technical Bulletin 133 requires special construction procedures and is based on fabric and product design. For applicable CAL 133 upcharge, refer to up-charge, refer to individual product pages in the specification guide or the fabric database at www.coalesse.com.

Pre-Approved Fabrics – www.coalesse.com If a model or fabric is not listed, consult Customer Service for details at 800.627.6770.

***Note** – California Technical Bulletin 133 is a unit test and requires specific product testing of unit for certification. If certification is required the test of a unit constructed exactly as the unit(s) to be specified in the installation, the cost of the test unit plus the cost of testing (\$500 net per test) must be added to obtain certification. Coalesse is not responsible for any charges for COM/COL purchased prior to evaluation if unit fails. Textile and unit cannot be returned.

Please consult Customer Service at 1.800.627.6770 or Fax 888.413.5161 for suggested fabrics/leathers, upcharges and minimums required for meeting California Technical Bulletin 133.

General Information

-Specifications, test procedures and requirements pertaining to flammability regulations are changing rapidly. Coalesse will make every effort to keep our information and services pertaining to flame specifications up-to-date. However, we do reserve the right to alter the products, fabrics/leathers or upcharges associated with any of the above or any other flame specifications.

When COM or COL is specified for use on Coalesse seating that is to meet the New York Port Authority Code, the COM or COL must be treated to meet this code prior to receipt by Coalesse. Coalesse is not responsible for the flammability treatment or certification of any COM or COL. All upcharges indicated are to be added to list prices. ▶ See specific product pages for CAL 133 approval, option, and pricing.

Upholstery Matrix

Note: Coalesse reserves the right to reject fabrics when necessary if the quality or construction is not satisfactory for intended use. For most up to date information on fabric usage, please check the fabric database on www.coalesse.com.

Legend

- = Not available
- = Available
- = Available but requires backer
- ⊙ = Available but requires contrasting fabric
- = Available but requires backer and contrasting fabric
- ▶ See specification pages for details.

	Chance Grade 12	Connoisseur 3 Grade 13	Conservation Grade 10	Divina Melange Grade 14/2CH	Frolic Grade 14	Hallingdal Grade 14/2CH	Link Grade 6	Pigment Grade 13	React Grade 10	Remix Grade 12	Restore Grade 10	Rocket Grade 9	Salon Grade 9	Samba Grade 12	Sequence Grade 12	Souvenir Grade 10	Square Grade 12	Steady Grade 11	Steelcut Grade 13	Sustain Grade 10	Swayed All Over Grade COM	Tempera Grade 14	Whimsy Grade 11
Bindu	■	□	•	□	■	□	■	□	•	■	•	□	•	■	•	•	•	•	■	■	■	□	•
Bix	■	□	⊙	□	■	□	■	□	□	■	□	□	□	■	■	•	⊙	•	■	■	■	□	⊙
Chord	■	□	■	□	■	□	■	□	■	■	■	□	□	■	■	•	■	•	■	■	■	□	■
Circa	■	□	•	□	■	□	■	□	•	■	•	□	•	■	•	•	•	•	■	■	■	□	•
Coupe	■	□	■	□	■	□	■	□	■	■	■	□	□	■	■	■	■	•	■	■	■	□	■
Enea	■	□	■	□	■	□	■	□	■	■	■	□	□	■	■	■	■	•	■	■	■	□	■
Kathryn	■	□	■	□	■	□	■	□	■	■	■	□	□	■	■	■	■	•	■	■	■	□	■
Ripple	■	□	•	□	■	□	■	□	•	■	•	□	•	■	•	•	•	•	■	■	■	□	•
Swathmore	■	□	■	□	■	□	■	□	■	■	■	□	□	■	■	■	■	•	■	■	■	□	■
Swathmore Grande	■	□	■	□	■	□	■	□	■	■	■	□	□	■	■	■	■	•	■	■	■	□	■

Disclaimer: Coalesse is pleased to provide this information. However, even after preliminary approval, Coalesse reserves the right to reject fabrics/leathers when necessary if the quality or construction is not satisfactory for the item it is intended for use on. Coalesse reserves the right to evaluate data daily and make any necessary changes or improvements to the information provided. Textile recommendations do not imply a warranty for the textiles. The textile manufacturer provides all warranties for textiles. All trademarks and trade names are the property of the different manufacturers. All pricing quotes for product should be obtained from your local Sales Representative or a Coalesse Customer Service Representative. Recommendations such as latex backing, Gore SP and CAL 133 will require additional cost and may require additional lead-time. All specifications are subject to change without notice.

Steelcase Upholstery Matrix

Note: Coalesse reserves the right to reject fabrics when necessary if the quality or construction is not satisfactory for intended use. For most up to date information on fabric usage please check the fabric database on www.coalesse.com.

Legend

- = Not available
- = Available
- ▶ See specification pages in the *Coalesse Specification Guides* for details.

	Steelcase Fabrics													
	Cogent: Connect Grade 06	Jacks Grade 06	Seating Vinyl Grade 06	Spyder Grade 06	Nitelights Grade 06	Link Grade 06	Stand In Grade 07	Cogent: Trails Grade 07	New Black Grade 07	Imperma Grade 07	Billiard Multi-Use by Designtex Grade 08	Texel Grade 08	Remix Grade 09	Bo Peep Grade 10
Await	•	■	■	■	■	■	■	■	■	■	■	■	■	■
Bindu	■	■	■	■	■	■	■	■	■	■	■	■	■	■
Bix Cushions	■	■	■	■	■	■	■	■	■	■	■	■	■	■
Bix Screen	■	■	•	■	•	■	■	■	■	■	■	■	■	■
Bob	■	■	■	■	■	■	■	■	■	■	■	■	■	■
Capa	■	■	■	■	■	■	■	■	■	■	■	■	■	■
Chord	■	■	■	■	■	■	■	■	■	■	■	■	■	■
Circa	•	■	■	■	■	■	■	■	■	■	■	■	■	■
Coupe	■	■	■	■	■	■	■	■	■	■	■	■	■	■
Davos	■	■	■	■	■	■	■	■	■	■	■	■	■	■
Elbow Chair CH20	•	•	•	•	•	•	•	•	•	•	•	•	•	•
Emu Outdoor Cushion	•	•	•	•	•	•	•	•	•	•	•	•	•	•
Emu Indoor Cushion	■	■	■	■	■	■	■	■	■	■	■	■	■	■
Emu Terramare	•	•	•	•	•	•	•	•	•	•	•	•	•	•
Enea	■	■	■	■	■	■	■	■	■	■	■	■	■	■
Enea Lottus	■	■	■	■	■	■	■	■	■	■	■	■	■	■
Exponents, Benches	■	■	■	■	■	■	■	■	■	■	■	■	■	■
Hosu	■	■	■	■	■	■	■	■	■	■	■	■	■	■
Joel	■	■	■	■	■	■	■	■	■	■	■	■	■	■
Kathryn	■	■	■	■	■	■	■	■	■	■	■	■	■	■
Last Minute	■	■	■	■	■	■	■	■	■	■	■	■	■	■
Lounge Seating CH100 Series	•	•	•	•	•	•	•	•	•	•	•	•	•	•
Millbrae Contract	■	■	■	■	■	■	■	■	■	■	■	■	■	■
Millbrae Lifestyle	•	■	■	■	■	■	■	■	■	■	•	■	•	■

▶ Continued on next page

The above Steelcase fabrics are available as standard without a backer on select Coalesse product lines. For those product lines that are noted as unavailable, it may be specifiable with a backer as a Graded-In fabric. Additional Steelcase fabrics are available through the Graded-In program. Please consult the Coalesse Fabric Database for availability. Disclaimer: Coalesse is pleased to provide this information. However, even after preliminary approval, Coalesse reserves the right to reject fabrics/leathers when necessary if the quality or construction is not satisfactory for the item it is intended for use on. Coalesse reserves the right to evaluate data daily and make any necessary changes or improvements to the information provided. Textile recommendations do not imply a warranty for the textiles. The textile manufacturer provides all warranties for textiles. All trademarks and trade names are the property of the different manufacturers. All pricing quotes for product should be obtained from your local Sales Representative or a Coalesse Customer Service Representative. Recommendations such as backing and CAL 133 will require additional cost and may require additional lead-time. All specifications are subject to change without notice.

Steelcase Upholstery Matrix

Note: Coalesse reserves the right to reject fabrics when necessary if the quality or construction is not satisfactory for intended use. For most up to date information on fabric usage please check the fabric database on www.coalesse.com.

▶ Continued, from previous page

Legend

- = Not available
- = Available
- ▶ See specification pages in the *Coalesse Specification Guides* for details.

	Steelcase Fabrics													
	Cogent: Connect Grade 06	Jacks Grade 06	Seating Vinyl Grade 06	Spyder Grade 06	Nitelights Grade 06	Link Grade 06	Stand In Grade 07	Cogent: Trails Grade 07	New Black Grade 07	Imperma Grade 07	Billiard Multi-Use by DesignTex Grade 08	Texel Grade 08	Remix Grade 09	Bo Peep Grade 10
Lagunitas Cushion	■	■	■	■	■	■	■	■	■	■	■	■	■	■
Lox	•	■	■	■	■	■	■	■	■	■	•	■	•	■
Montara650	■	■	■	■	■	■	■	■	■	■	■	■	■	■
Passerelle	■	■	■	■	■	■	■	■	■	■	■	■	■	■
Ripple	•	■	■	■	■	■	■	■	■	■	■	■	■	■
Sidewalk	■	■	■	■	■	■	■	■	■	■	■	■	■	■
SW_1	■	■	■	■	■	■	•	•	■	■	■	■	■	■
Swathmore	■	■	■	■	■	■	■	■	■	■	■	■	■	■
Swathmore Grande	■	■	■	■	■	■	■	■	■	■	■	■	■	■
Switch	■	■	■	■	■	■	■	■	■	■	■	■	■	■
Together	■	■	■	■	■	■	■	■	■	■	■	■	■	■
Topo Lounge	■	■	■	■	■	■	■	■	■	■	■	■	■	■
Topo Mobile Lounge	■	■	■	■	■	■	■	■	■	■	■	■	■	■
Visalia	■	■	■	■	■	■	■	■	■	■	■	■	■	■
Wrapp	•	■	■	■	■	■	■	■	■	■	•	■	•	■

The above Steelcase fabrics are available as standard without a backer on select Coalesse product lines. For those product lines that are noted as unavailable, it may be specifiable with a backer as a Graded-In fabric. Additional Steelcase fabrics are available through the Graded-In program. Please consult the Coalesse Fabric Database for availability. Disclaimer: Coalesse is pleased to provide this information. However, even after preliminary approval, Coalesse reserves the right to reject fabrics/leathers when necessary if the quality or construction is not satisfactory for the item it is intended for use on. Coalesse reserves the right to evaluate data daily and make any necessary changes or improvements to the information provided. Textile recommendations do not imply a warranty for the textiles. The textile manufacturer provides all warranties for textiles. All trademarks and trade names are the property of the different manufacturers. All pricing quotes for product should be obtained from your local Sales Representative or a Coalesse Customer Service Representative. Recommendations such as backing and CAL 133 will require additional cost and may require additional lead-time. All specifications are subject to change without notice.

Surface Materials - Leather/Faux

Leather

ELMOSOFT, ELMORUSTICAL LEATHER CARE

Only the finest hides are used for Elmo leather. Expect some color variations from hide to hide due to the aniline state of the product. Color fading may occur if leather is exposed to direct or intense light. Care is required to allow this product to achieve the rich natural patina that beautiful natural leather develops. The hallmarks of this leather include some naturally occurring markings, such as healed scars, insect bites, stretch marks, and fat wrinkles. Elmorustical's leather treatment is very natural with little protection from spills or body oils. This rich leather will exhibit stains and oils through normal use. Coalesse is not responsible for discoloration, spotting, or staining on this leather.

Special Color Match Leather

Coalesse can provide a special color match in its leather to any supplier's leather color, paint color, carpet color, wall-paper color, etc. Sample to match must be submitted to Coalesse with purchase order. Sample for approval can be supplied if requested.

Note: Minimum order 2,500 sq. ft.

Special Fabric Applications

Backing

- Backing information is found on each product page. Select this option when ordering your product to have backing applied. Price varies by product according to yardage it requires.

Tip: Prices subject to change without notice and an additional 2 week lead time will apply for 54" wide fabrics. Wider fabrics will require 4 week additional lead time.

Elmo Leather

Coalesse uses leathers that are provided by Elmo of Sweden. Elmosoft is a full grain, aniline dyed, semi-aniline finish. With Elmosoft leather, now recyclable and chromium-free, you have the opportunity to bid on green projects when requested. Elmosoft leathers are never corrected, buffed, or altered in any way. Coalesse purchases only original full grain leathers. The quality of this genuine leather can be felt in the hand immediately. Other leathers are often stiff because of the amount of pigment needed to cover the imperfections of an inferior hide. Using leather of low quality affects the overall quality of the furniture it is upholstered on. You can feel confident in leather purchased from Coalesse.

Elmosoft

Grade C

Elmosoft

- L110 Maritime Blue
- L111 Midnight Blue
- L112 Ebony
- L113 Gunmetal
- L114 Mica
- L115 Dove Grey
- L116 Plum Pleasure
- L122 Truffle
- L128 Red Birch
- L132 Violet
- L133 Espresso
- L134 Ruby
- L135 Scarlet
- L138 Bourbon
- L139 Cinder
- L140 Garnet
- L143 Pecan
- L144 Chamois
- L146 Russet
- L147 Saddle
- L151 White
- L709 Sugar
- L711 Parchment
- L712 Buff
- L716 Khaki
- L717 Cameo
- L721 Rock
- L722 Desert
- L723 Storm
- L725 Teal
- L727 Egyptian Blue
- L728 Bright Blue
- L730 Hunter
- L736 Lemon
- L737 Sunshine
- L738 Drama
- L740 Dazzle
- L743 Forest Green
- L744 Turtle
- L745 Grass
- L746 Envy
- L747 Cigar
- L748 Light Chocolate
- L749 Beaver
- L750 Bluffstone
- L751 Sienna
- L752 Oxblood
- L753 Dough
- L754 Acorn
- L755 Peanut Butter
- L756 Quinoa
- L757 Dark Sand
- L758 Mustard
- L759 Amber Orange
- L760 Bengal
- L761 Periwinkle
- L762 Canvas
- L763 Macadamia
- L764 True Blue
- L765 Storm Blue
- L766 Powder Blue
- L767 Blush
- L768 Tropical
- L769 Mauve
- L770 Cadet
- L771 Powder Mint
- L772 Timberwolf
- L773 Chalice
- L774 Oil
- L775 Coyote

Elmorustical Leather and Elmotique

Elmorustical and Elmotique is a full top grain, aniline dyed leather.

Elmorustical has a grain which varies in structure and offers outstanding comfort. It is an aniline leather with all the distinct features of the natural hide.

Elmotique is a thinner aniline leather with a batique-effect and displays all the features possessed by the original hide.

Only the finest hides are used for Elmorustical and Elmotique leathers. Expect some color variations from hide to hide due to the aniline state of the product. Color fading may occur if leather is exposed to direct or intense light. Care is required to allow this product to achieve the rich natural patina that beautiful leather develops. The hallmarks of this leather include some naturally occurring markings such as healed scars, insect bites, stretch marks, and fat wrinkles. Elmorustical and Elmotique's leather treatment is very natural with little protection from spills or body oils. This rich leather will exhibit stains and oils through normal use. Coalesse is not responsible for discoloration, spotting, or staining on this leather.

Grade E

Elmorustical

- L318 Loam
- L319 Ebony
- L321 Beige
- L323 Buff
- L325 Camel
- L326 Charbrown
- L330 Flame
- L332 Honey
- L334 Mist Green
- L337 Russet
- L338 Rust
- L363 Tendril
- L364 Fog
- L365 Sunflower
- L366 Terra Cotta
- L367 Cadet
- L368 Marine
- L369 Mallard
- L370 Smoke
- L371 Merlot
- LD54 Twilight

Elmotique

- L310 Sage Brush
- L311 Flaxen
- L312 Earth
- L313 Clay
- L314 Blue Mountain
- L315 Juniper

Faux Leather

Coalesse offers a variety of faux leathers. Not all faux leathers are available on all products, check seating matrix to determine availability. **►Page 271**

Grade 10

Brisa
(For a visual palette, please refer to the Steelcase Finish Library)

- BR01 Black Onyx
- BR04 Truffle
- BR06 Ash
- BR07 Sage
- BR08 Celery
- BR09 Sterling Blue
- BR10 Night Navy
- BR11 Cambridge Blue
- BR12 Abyss
- BR13 Canyon
- BR14 Pompeia
- BR15 Salsa
- BR16 Cinnabar
- BR17 Aztec
- BR18 New Sand
- BR19 Cream
- BR20 White
- BR21 Moccasin
- BR22 Buckskin
- BR23 Praire
- BR24 Mineral
- BR25 Skyway
- BR26 Iron
- BR27 Stormy
- BR28 Esmeralda
- BR29 Seaweed
- BR30 Bone
- BR31 Caramel
- BR32 Bridle
- BR33 Moon

Surface Materials - Leather/Faux

<p>Grade 11</p> <p>Destiny</p> <p>DY01 Black</p> <p>DY02 Raisin</p> <p>DY03 Blueberry</p> <p>DY04 Chestnut</p> <p>DY05 Cedar</p> <p>DY06 Black Rose</p> <p>DY07 Wine</p> <p>DY09 Dune</p> <p>DY10 Truffle</p> <p>DY11 Oak</p> <p>DY12 Newport</p> <p>DY13 Evergreen</p> <p>DY14 Storm</p> <p>DY15 Juniper</p> <p>DY16 Olive</p> <p>DY17 Mocha</p> <p>DY18 Ash</p> <p>DY21 Butter</p> <p>DY23 Deep Red</p> <p>DY24 Eggshell</p> <p>DY26 Parchment</p> <p>DY27 Periwinkle</p> <p>DY30 Royal Purple</p> <p>DY31 Saddle</p> <p>DY32 Cactus Green</p> <p>DY33 Cypress</p> <p>DY34 Mink</p> <p>DY35 Football</p> <p>DY36 Root</p> <p>Finesse</p> <p>AM00 White Cloud</p> <p>AM01 Gelato</p> <p>AM02 Winter White</p> <p>AM04 Mushroom</p> <p>AM06 Charbrown</p> <p>AM08 Iceberg</p> <p>AM09 Gravel</p> <p>AM10 Colonial Blue</p> <p>AM24 Rye</p> <p>AM25 Barley</p> <p>AM26 Stucco</p> <p>AM27 Beaver</p> <p>AM28 Otter</p> <p>AM65 Bordeaux</p> <p>AM66 Navy</p> <p>AM67 Cinder</p> <p>AM80 Cameo</p> <p>AM81 Oyster Grey</p> <p>AM83 Taupe</p> <p>AM85 Chestnut</p> <p>AM87 Indigo</p> <p>AM88 Bone</p> <p>AM89 Jet Black</p> <p>AM92 Burgundy</p> <p>AM93 Hunter Green</p> <p>AM98 Oxford Brown</p> <p>Ovation</p> <p>O500 Dark Brown</p> <p>O501 Light Grey</p> <p>O502 Sage</p> <p>O503 Indigo</p> <p>O504 Lilac</p> <p>O505 Terra</p> <p>O506 Moss</p> <p>O507 Teal</p> <p>O508 Stone</p> <p>O509 Cappuccino</p>	<p>Panache</p> <p>P800 Ebony</p> <p>P801 Cactus</p> <p>P802 Sherwood</p> <p>P803 Teal Blue</p> <p>P804 Sweet Sage</p> <p>P805 Coffee</p> <p>P806 True Taupe</p> <p>P807 Cashew</p> <p>P808 Acorn</p> <p>P809 Redwood</p> <p>P810 Exotic Orchid</p> <p>P811 Maize</p> <p>P812 Chartreuse</p> <p>P813 Regal Blue</p> <p>Prestige</p> <p>AFA1 Onyx</p> <p>AFB2 Soft White</p> <p>AFC3 Saxe Blue</p> <p>AFD3 Buff</p> <p>AFDG Antique White</p> <p>AFE1 Sandstone</p> <p>AFH1 Pecan</p> <p>AFH2 Buttercreme</p> <p>AFI1 Havana</p> <p>AFI2 Brick</p> <p>AFK1 Parchment</p> <p>AFL8 French Grey</p> <p>AFP1 Willow</p> <p>AFP2 Boxwood Green</p> <p>AFPA Tree Moss</p> <p>AFPC Celadon</p> <p>AFS3 Wild Plum</p>	<p>Grade 12</p> <p>Elegance</p> <p>EL01 Ivory</p> <p>EL02 Cream</p> <p>EL03 Char</p> <p>EL04 Saddle</p> <p>EL05 Dune</p> <p>EL06 Camel</p> <p>EL07 Sage</p> <p>EL08 Gray</p> <p>EL09 Walnut</p> <p>EL10 Burgundy</p> <p>EL11 Green</p> <p>EL12 Navy</p> <p>EL13 Black</p>	<p>Grade 13</p> <p>Destiny Perforated</p> <p>DP01 Black</p> <p>DP02 Raisin</p> <p>DP03 Blueberry</p> <p>DP04 Chestnut</p> <p>DP05 Cedar</p> <p>DP06 Black Rose</p> <p>DP07 Wine</p> <p>DP09 Dune</p> <p>DP10 Truffle</p> <p>DP11 Oak</p> <p>DP12 Newport</p> <p>DP13 Evergreen</p> <p>DP14 Storm</p> <p>DP15 Juniper</p> <p>DP16 Olive</p> <p>DP17 Mocha</p> <p>DP21 Butter</p> <p>DP23 Deep Red</p> <p>DP24 Eggshell</p> <p>DP26 Parchment</p> <p>DP27 Periwinkle</p> <p>DP30 Royal Purple</p> <p>DP31 Saddle</p> <p>DP32 Cactus Green</p> <p>DP33 Cypress</p> <p>DP34 Mink</p> <p>DP35 Football</p> <p>DP36 Root</p> <p>Finesse Perforated</p> <p>AP00 White Cloud</p> <p>AP01 Gelato</p> <p>AP02 Winter White</p> <p>AP04 Mushroom</p> <p>AP06 Charbrown</p> <p>AP08 Iceberg</p> <p>AP09 Gravel</p> <p>AP10 Colonial Blue</p> <p>AP24 Rye</p> <p>AP25 Barley</p> <p>AP26 Stucco</p> <p>AP27 Beaver</p> <p>AP28 Otter</p> <p>AP65 Bordeaux</p> <p>AP66 Navy</p> <p>AP67 Cinder</p> <p>AP80 Cameo</p> <p>AP81 Oyster Grey</p> <p>AP83 Taupe</p> <p>AP85 Chestnut</p> <p>AP87 Indigo</p> <p>AP88 Bone</p> <p>AP89 Jet Black</p> <p>AP92 Burgundy</p> <p>AP93 Hunter Green</p> <p>AP98 Oxford Brown</p>	<p>Panache Perforated</p> <p>PR00 Ebony</p> <p>PR01 Cactus</p> <p>PR02 Sherwood</p> <p>PR03 Teal Blue</p> <p>PR04 Sweet Sage</p> <p>PR05 Coffee</p> <p>PR06 True Taupe</p> <p>PR07 Cashew</p> <p>PR08 Acorn</p> <p>PR09 Redwood</p> <p>PR10 Exotic Orchid</p> <p>PR11 Maize</p> <p>PR12 Chartreuse</p> <p>PR13 Regal Blue</p> <p>Prestige Perforated</p> <p>APA1 Onyx</p> <p>APB2 Soft White</p> <p>APC3 Saxe Blue</p> <p>APD3 Buff</p> <p>APDG Antique White</p> <p>APE1 Sandstone</p> <p>APH1 Pecan</p> <p>APH2 Buttercream</p> <p>API1 Havana</p> <p>API2 Brick</p> <p>APK1 Parchment</p> <p>APL8 French Grey</p> <p>APP1 Willow</p> <p>APP2 Boxwood Green</p> <p>APPA Tree Moss</p> <p>APPC Celadon</p> <p>APSP3 Wild Plum</p>
--	---	---	---	--

Cut Yardage Net Price List

FABRIC NAME	Under 60 Yards	60 Yards & Over
Elegance®	\$86.00/yd.	\$82.00/yd.
Finesse®	\$52.00/yd.	\$51.00/yd.
Finesse® Perforated (min. 5 yds)	\$63.00/yd.	\$62.00/yd.
Prestige®	\$57.00/yd.	\$54.00/yd.
Prestige® Perforated (min. 5 yds)	\$68.00/yd.	\$65.00/yd.
Destiny®	\$58.00/yd.	\$56.00/yd.
Destiny® Perforated (min. 5 yds)	\$69.00/yd.	\$66.00/yd.
Ovation	\$58.00/yd.	\$54.00/yd.
Panache	\$58.00/yd.	\$56.00/yd.

LEATHER NAME	Under 500 sq. ft.	500-1000 sq. ft.	Over 1000 sq. ft.
Elmosoft	\$9.00/sq. ft.	\$8.00/sq. ft.	\$7.50/sq. ft.
Elmorustical*	\$11.00/sq. ft.	\$9.00/sq. ft.	\$8.50/sq. ft.

ORDERING INFORMATION

- Minimum Order Requirements
 - Fabric: 1 yd. - 1/8 yd. increments.
 - Leather: 1 full hide (avg. sq. ft./hide - 50).
 - All orders will be filled in full hides only.
 - Overage will be invoiced accordingly.
- Special match leather: 2,500 sq. ft. minimum (Check delivery date)
- The embossing techniques used on Novasuede Perforated to achieve these looks involve very high temperatures. Color and shade may vary slightly based on the fiber density being embossed.
- Cancelled textile orders are subject to a 30% restocking fee. Order must be cancelled 5 days before ship date.
- Due to the natural processes of dyeing, sanding and embossing necessary to achieve these special looks, actual production may vary slightly in appearance from the swatches shown.

COALESSE TEXTILE WARRANTY

Coalesse textile merchandise is produced in accordance with Coalesse high standards. Coalesse does not guarantee, warrant or accept any responsibility whatsoever by reason of its fabrics or leathers fading, wearing, cracking, shrinking, stretching, tearing, seam slippage, alteration in color due to any finish treatment (flameproofing, stain repellent, etc.) or discoloration from liquid contact. Printed textiles are not warranted against irregularity in register. Coalesse is not responsible for dye lot differences or discrepancies in widths of fabrics. Coalesse does not guarantee, warrant or represent an exact color match to cuttings, tabs, memos or sample cards. Coalesse does not warrant exact matching of color or grain of leather. Leather hides may contain certain natural marks, scars, scratches, wrinkles and shade variations within hides, etc., considered by leather tanneries and Coalesse to be inherent characteristics part of the natural beauty of leather and the size or location of such markings cannot be controlled. In any event, upon inspection, Coalesse's responsibility shall be limited to either replacement of merchandise or refund of purchase price at Coalesse's option. The foregoing constitutes the sole and exclusive remedy of the customer. Coalesse is not responsible for the application or installation of our products. In no event shall Coalesse be responsible for any consequential damages or any charges, costs, expenses, or obligations other than as expressly herein set forth. Coalesse makes no other warranties, expressed or implied, as to any product sold by Coalesse. All other warranties (including any warranty of merchantability or fitness for any particular purpose) are hereby excluded.

Leather and Faux Leather Matrix

Note: Coalesse reserves the right to reject fabrics when necessary if the quality or construction is not satisfactory for intended use. For most up to date information on fabric usage, please check the fabric database on www.coalesse.com.

Legend

- = Not available
- = Available
- ☐ = Must be ordered as COM or COL
- ▣ = Available but will puddle
- ▶ See specification pages for details.

	Elmosoft Grade C	Elmoique Grade E	Elmorustical Grade E	Loke Leather	Brisa Grade 10	Destiny Grade 11	Destiny Perforated Grade 13	Prestige Grade 11	Prestige Perforated Grade 13	Finesse Grade 11	Finesse Perforated Grade 13	Elegance Grade 12	Panache Grade 11	Panache Perforated Grade 13	Ovation Grade 11
Await	■	•	■	☐	■	■	■	■	■	■	■	■	■	■	■
Bindu	■	•	■	☐	■	■	■	■	■	■	■	■	■	■	■
Bix	■	•	■	•	■	■	•	■	•	■	•	■	■	•	■
Bob	■	•	■	•	■	■	•	■	•	■	•	■	■	■	■
Capa	■	•	■	☐	■	■	■	■	■	■	■	■	■	■	■
Chord	■	•	■	☐	■	■	■	■	■	■	■	■	■	■	■
Circa	■	•	■	☐	■	■	■	■	■	■	■	■	■	■	■
Coupe	■	•	■	☐	■	■	■	■	■	■	■	■	■	■	■
Davos	■	•	■	•	■	■	•	■	•	■	•	■	■	•	■
Emu Indoor Cushion	■	■	■	•	■	■	■	■	■	■	■	■	■	•	■
Enea	■	•	■	☐	■	■	■	■	■	■	■	■	■	■	■
Enea Lottus	■	■	■	•	■	■	•	■	•	■	•	■	■	•	■
Exponents (Benches)	■	•	■	•	■	■	•	■	•	■	•	■	■	•	■
Joel	■	•	■	•	■	■	•	■	•	■	•	■	■	•	■
Kathryn	■	■	■	☐	■	■	■	■	■	■	■	■	■	■	■
Lagunitas	■	•	■	•	■	■	■	■	■	■	■	■	■	■	■
Lox	■	■	■	•	■	■	•	■	•	■	•	■	■	•	■
Millbrae Contract	■	•	■	☐	■	■	■	■	■	■	■	■	■	■	■
Millbrae Lifestyle	■	■	■	☐	■	■	■	■	■	■	■	■	■	■	■
Montara650	■	•	■	•	■	■	•	■	•	■	•	■	■	•	■
Passerelle	■	•	■	☐	■	■	■	■	■	■	■	■	■	■	■
Ripple	■	•	■	☐	■	■	■	■	■	■	■	■	■	■	■
SW_1	■	•	■	•	■	■	•	■	•	■	•	■	■	•	■
Swathmore	■	•	■	☐	■	■	■	■	■	■	■	■	■	■	■
Swathmore Grande	■	•	■	☐	■	■	■	■	■	■	■	■	■	■	■
Switch	■	•	■	☐	■	■	■	■	■	■	■	■	■	■	■
Together	▣	•	▣	•	▣	▣	•	▣	•	▣	•	▣	▣	•	■
Topo	■	•	■	•	■	■	•	■	•	■	•	■	■	•	■
Visalia	■	•	■	☐	■	■	■	■	■	■	■	■	■	■	■
Wrapp	■	•	■	•	■	■	■	■	■	■	■	■	■	■	■

Disclaimer: Coalesse is pleased to provide this information. However, even after preliminary approval, Coalesse reserves the right to reject fabrics/leathers when necessary if the quality or construction is not satisfactory for the item it is intended for use on. Coalesse reserves the right to evaluate data daily and make any necessary changes or improvements to the information provided. Textile recommendations do not imply a warranty for the textiles. The textile manufacturer provides all warranties for textiles. All trademarks and trade names are the property of the different manufacturers. All pricing quotes for product should be obtained from your local Sales Representative or a Coalesse Customer Service Representative. Recommendations such as latex backing, Gore SP and CAL 133 will require additional cost and may require additional lead-time. All specifications are subject to change without notice.

Surface Materials - Wood

Wood

Standard Wood Finishes

Coalesse's primary wood finish, Clarity, is a water-borne UV topcoat, which protects the environment while providing exceptional durability and resistance to water and chemical stains. Contoured products, such as wood guest chairs and occasional tables, are finished with post-catalyzed vinyl, which provides similar properties and matches the sheen and color of Clarity. Due to natural variations in wood, finished products may vary from samples in color, texture, and grain.

Wood will develop a deep, rich patina over time as the wood ages. Mineral streaks, gum pockets, and pin knots are some of the unique characteristics that are visible in veneers and solids.

All wood products will darken with age and exposure to ultraviolet light. This is especially apparent with cherry and maple veneer.

When storing your wood furniture, please follow the following guidelines:

- Do not store products in trailers
- Store products in areas that simulate office temperatures (60°F to 90°F)
- Store products in areas that maintain constant, office-like humidity levels
- Keep product away from light. Cover products to make sure they are not exposed to light.

Samples contact Customer Service at 1.800.627.6770

Steelcase Wood Finishes

Coalesse will match current Steelcase wood finishes at no upcharge. Finish matches are for color only and do not match the Steelcase finish in sheen. Samples will be provided upon request from Customer Service at 1.800.627.6770 and will be produced within 10 working days.

Stain-To-Match Wood Finish on cherry, maple, walnut, or oak

Coalesse will Stain-To-Match any wood finish at no upcharge. Samples submitted for matching must be at least 12" x 12" in surface dimension. Customers must specify cherry, maple, oak, or walnut species. Coalesse will produce a strike-off within 5 working days following acknowledgement of the order. Coalesse will not schedule the order for production until the strike-off has been approved and received by Coalesse.

Tip: For a visual palette, please refer to the Steelcase Finish Library.

Painted MDF

The painted medium density fiberboard (MDF) is utilizing molding grade MDF, therefore, the 45 lb density is consistent throughout the entire thickness of the board. This allows for a smooth edge when painted. Three coats of water reducible finish is applied to the board in a milk or black. The painted MDF has durability and care properties like a wood veneer, thus, must be treated as such.

Veneer Specifications

Cherry

- American Black Cherry
- Flat cut, plain sliced/book matched
- Quarter cut/book matched
- Narrow cathedrals, mild grain, minimal pitch
- 5-10" wide leaves of 1/42" thick veneer, balanced on panel
- No gaps between leaves
- PB (particle board) core
- Low sheen 15 or high sheen 35

Maple

- Eastern Hard White Maple
- Flat cut, plain sliced/slip matched
- Quarter cut/book matched
- Narrow cathedrals, mild grain, minimal pitch
- 5-10" wide leaves of 1/42" thick veneer, balanced on panel
- No gaps between leaves
- PB (particle board) core
- Low sheen 15 or high sheen 35

Oak

- White Oak
- Rift cut
- Slip match
- Mild grain
- 4-8" wide leaves of 1/42" thick veneer, balanced on panel
- No gaps between leaves
- PB (particle board) core
- Low sheen 15 or high sheen 35

Walnut

- American Black Walnut
- Flat cut, plain sliced/book matched
- Quarter cut/book matched
- Narrow cathedrals, mild grain
- 5-10" wide leaves of 1/42" thick veneer, balanced on panel
- No gaps between leaves
- PB (particle board) core
- Low sheen 15 or high sheen 35

Exclusive (by product)

Teak

- Quarter cut/book match
- 15 sheen

Ash (Grey)

- Quarter cut/book match
- 15 sheen

Flat-cut – High Sheen

Grade 1

- V10C FC/HS Natural Cherry
- V11C FC/HS Clear Cherry
- V12C FC/HS Medium Amber Cherry
- V13C FC/HS Dark Cherry
- V10M FC/HS Clear Maple
- V11M FC/HS Natural Beech on Maple
- V12M FC/HS Medium Maple
- V10W FC/HS Natural Walnut
- V11W FC/HS Clear Walnut
- V12W FC/HS Medium Walnut
- V13W FC/HS Black Walnut
- V14W FC/HS Dark Walnut

Flat-cut – Low Sheen

Grade 1

- V1AC FC/LS Natural Cherry
- V1BC FC/LS Clear Cherry
- V1CC FC/LS Medium Amber Cherry
- V1DC FC/LS Dark Cherry
- V1AM FC/LS Clear Maple
- V1BM FC/LS Natural Beech on Maple
- V1CM FC/LS Medium Maple
- V1AW FC/LS Natural Walnut
- V1BW FC/LS Clear Walnut
- V1CW FC/LS Medium Walnut
- V1EW FC/LS Dark Walnut

Rift-cut – High Sheen

Grade 1

- V30K RC/HS Natural Oak
- V31K RC/HS Desert Oak
- V32K RC/HS Medium Brown Oak
- V33K RC/HS Medium Gray Oak
- V34K RC/HS Black Brown Oak

Rift-cut – Low Sheen

Grade 1

- V3AK RC/LS Natural Oak
- V3BK RC/LS Desert Oak
- V3CK RC/LS Medium Brown Oak
- V3DK RC/LS Medium Gray Oak
- V3EK RC/LS Black Brown Oak

Quarter-cut – High Sheen

Grade 2

- V20C QC/HS Natural Cherry
- V21C QC/HS Clear Cherry
- V22C QC/HS Medium Amber Cherry
- V23C QC/HS Dark Cherry
- V20M QC/HS Clear Maple
- V21M QC/HS Natural Beech on Maple
- V22M QC/HS Medium Maple
- V20W QC/HS Natural Walnut
- V21W QC/HS Clear Walnut
- V22W QC/HS Medium Walnut
- V23W QC/HS Black Walnut
- V24W QC/HS Dark Walnut

FC=Flat Cut
 RC=Rift Cut
 QC=Quarter Cut
 WL=Wedge Lay-up
 HS=High Sheen
 LS=Low Sheen

Surface Materials - Wood

Quarter-cut – Low Sheen

Grade 2

V2AA	QC/LS Ash Natural FSC
V2AC	QC/LS Natural Cherry
V2BC	QC/LS Clear Cherry
V2CC	QC/LS Medium Amber Cherry
V2DC	QC/LS Dark Cherry
V2AM	QC/LS Clear Maple
V2BM	QC/LS Natural Beech on Maple
V2CM	QC/LS Medium Maple
V2AW	QC/LS Natural Walnut
V2BW	QC/LS Clear Walnut
V2CW	QC/LS Medium Walnut
V2EW	QC/LS Dark Walnut
V2AT	QC/LS Teak Natural Raw FSC

Wedge Lay-up* – Flat cut – High Sheen

Grade 1

W10C	WC/FC/HS Natural (Raw) Cherry
W11C	WC/FC/HS Clear Cherry
W12C	WC/FC/HS Medium Amber Cherry
W13C	WC/FC/HS Dark Cherry
W10M	WC/FC/HS Clear Maple
W11M	WC/FC/HS Natural Beech on Maple
W12M	WC/FC/HS Medium Maple
W10W	WC/FC/HS Natural (Raw) Walnut
W11W	WC/FC/HS Clear Walnut
W12W	WC/FC/HS Medium Walnut
W13W	WC/FC/HS Black Walnut
W14W	WC/FC/HS Dark Walnut

Wedge Lay-up* – Flat cut – Low Sheen

Grade 1

W1AC	WC/FC/LS Natural (Raw) Cherry
W1BC	WC/FC/LS Clear Cherry
W1CC	WC/FC/LS Medium Amber Cherry
W1DC	WC/FC/LS Dark Cherry
W1AM	WC/FC/LS Clear Maple
W1BM	WC/FC/LS Natural Beech on Maple
W1CM	WC/FC/LS Medium Maple
W1AW	WC/FC/LS Natural (Raw) Walnut
W1BW	WC/FC/LS Clear Walnut
W1CW	WC/FC/LS Medium Walnut
W1EW	WC/FC/LS Dark Walnut

Wedge Lay-up* – Rift cut – High Sheen

Grade 1

W30K	WC/RC/HS Natural (Raw) Oak
W31K	WC/RC/HS Desert Oak
W32K	WC/RC/HS Medium Brown Oak
W33K	WC/RC/HS Medium Gray Oak
W34K	WC/RC/HS Black Brown Oak

Wedge Lay-up* – Rift cut – Low Sheen

Grade 1

W3AK	WC/RC/LS Natural (Raw) Oak
W3BK	WC/RC/LS Desert Oak
W3CK	WC/RC/LS Medium Brown Oak
W3DK	WC/RC/LS Medium Gray Oak
W3EK	WC/RC/LS Black Brown Oak

FC=Flat Cut
RC=Rift Cut
QC=Quarter Cut
WL=Wedge Lay-up
HS=High Sheen
LS=Low Sheen
OP=Open Pore

Wedge Lay-up* – Quarter cut – High Sheen

Grade 2

W20C	WC/QC/HS Natural (Raw) Cherry
W21C	WC/QC/HS Clear Cherry
W22C	WC/QC/HS Medium Amber Cherry
W23C	WC/QC/HS Dark Cherry
W20M	WC/QC/HS Clear Maple
W21M	WC/QC/HS Natural Beech on Maple
W22M	WC/QC/HS Medium Maple
W20W	WC/QC/HS Natural (Raw) Walnut
W21W	WC/QC/HS Clear Walnut
W22W	WC/QC/HS Medium Walnut
W23W	WC/QC/HS Black Walnut
W24W	WC/QC/HS Dark Walnut

Wedge Lay-up* – Quarter cut – Low Sheen

Grade 2

W2AC	WC/QC/LS Natural (Raw) Cherry
W2BC	WC/QC/LS Clear Cherry
W2CC	WC/QC/LS Medium Amber Cherry
W2DC	WC/QC/LS Dark Cherry
W2AM	WC/QC/LS Clear Maple
W2BM	WC/QC/LS Natural Beech on Maple
W2CM	WC/QC/LS Medium Maple
W2AW	WC/QC/LS Natural (Raw) Walnut
W2BW	WC/QC/LS Clear Walnut
W2CW	WC/QC/LS Medium Walnut
W2EW	WC/QC/LS Dark Walnut

*Available on select tables, refer to pricing pages for availability.

Steelcase Veneers, Open Pore Only

Cherry, Flat Cut

Grade 1

3402	FC/OP Clear Cherry
3412	FC/OP Natural Cherry
3422	FC/OP Medium Cherry

Maple, Flat Cut

Grade 1

3522	FC/OP Clear Maple
3572	FC/OP Amber on Maple
3582	FC/OP Winter on Maple
3592	FC/OP Blonde on Maple

Maple, Quarter Cut

Grade 1

3222	QC/OP Clear Maple
3272	QC/OP Amber on Maple
3292	QC/OP Blonde on Maple

Walnut, Flat Cut

Grade 1

3062	FC/OP Graphite Walnut
3702	FC/OP Clear Walnut
3712	FC/OP Natural Walnut
3722	FC/OP Dark Mahogany on Walnut
3752	FC/OP Medium Walnut
3762	FC/OP Dark Walnut
3772	FC/OP Medium Mahogany on Walnut

Walnut, Quarter Cut

Grade 1

3302	QC/OP Clear Walnut
3312	QC/OP Natural Walnut
3322	QC/OP Dark Mahogany on Walnut
3352	QC/OP Medium Walnut
3362	QC/OP Dark Walnut
3372	QC/OP Medium Mahogany on Walnut
3382	QC/OP Graphite Walnut

Oak, Rift Cut

Grade 1

3602	RC/OP Desert Oak
3612	RC/OP Warm Oak
3692	RC/OP Espresso Oak

Natural Veneer

Grade 1

32A2	QC/OP Blanch Maple
33A2	QC/OP Thunder Walnut
3342	FC/OP Black Walnut
35A2	FC/OP Blanch Maple
36A2	RC/OP Volcanic Oak
37A2	FC/OP Thunder Walnut

Grade 2

3082	FC/OP Washed Walnut
3392	QC/OP Black Walnut

Planked Veneer

3P41	OP Planked Cherry
3P51	OP Planked Maple
3P61	OP Planked Oak
3P71	OP Planked Walnut

Painted MDF

Applies to: Exponents

V145	Milk
V197	Black

Hardwood Matrix

For Collaboration Chair Bases, Guest Chairs, Occasional Tables, and Lounge Chairs

Legend

- = Not available
- = Available
- ▣ = Stain color only on maple
- ▤ = Stain color only on beach
- ▶ See specification pages for details.

	Maple Flat Cut – High Sheen	Maple Flat Cut – Low Sheen	Maple Quarter Cut – High Sheen	Maple Quarter Cut – Low Sheen	Cherry Flat Cut – High Sheen	Cherry Flat Cut – Low Sheen	Cherry Quarter Cut – High Sheen	Cherry Quarter Cut – Low Sheen	Oak Rift Cut – High Sheen	Oak Rift Cut – Low Sheen	Walnut Flat Cut – High Sheen	Walnut Flat Cut – Low Sheen	Walnut Quarter Cut – High Sheen	Walnut Quarter Cut – Low Sheen	Teak Quarter Cut – High Sheen	Teak Quarter Cut – Low Sheen	Grey Ash – High Sheen	Grey Ash – Low Sheen	Exclusive Finishes for Trees	Carl Hansen Exclusive Wood Finishes
Seating																				
Circa	■	■	•	•	▣	▣	•	•	▣	▣	■	■	•	•	•	•	•	•	•	•
Coupe	■	■	•	•	▣	▣	•	•	▣	▣	■	■	•	•	•	•	•	•	•	•
Detour Tablet	■	■	•	•	▣	▣	•	•	▣	▣	▣	▣	•	•	•	•	•	•	•	•
Enea	■	■	•	•	▣	▣	•	•	▣	▣	▣	▣	•	•	•	•	•	•	•	•
Kathryn	▣	▣	•	•	▣	▣	•	•	▣	▣	▣	▣	•	•	•	•	•	•	•	•
Passerelle	■	■	•	•	▣	▣	•	•	▣	▣	▣	▣	•	•	•	•	•	•	•	•
Swathmore	■	■	•	•	▣	▣	•	•	▣	▣	▣	▣	•	•	•	•	•	•	•	•
Swathmore Grande	■	■	•	•	▣	▣	•	•	▣	▣	▣	▣	•	•	•	•	•	•	•	•
Occasional Tables																				
Bix Tables	■	■	•	•	■	■	•	•	■	■	■	■	•	•	•	•	•	•	•	•
Circa	■	■	•	•	▣	▣	•	•	▣	▣	■	■	•	•	•	•	•	•	•	•
Diekman	■	■	•	•	▣	▣	•	•	▣	▣	▣	▣	•	•	•	•	•	•	•	•
Enea	■	■	•	•	▣	▣	•	•	▣	▣	▣	▣	•	•	•	•	•	•	•	•
Passerelle	■	■	•	•	▣	▣	•	•	▣	▣	▣	▣	•	•	•	•	•	•	•	•
Sidewalk	■	■	•	•	▣	▣	•	•	▣	▣	▣	▣	•	•	•	•	•	•	•	•
Trees	•	•	•	•	•	•	•	•	•	•	•	•	•	•	•	•	•	•	■	•

Surface Materials - Laminate

Laminate

Coalesse's graded laminate program includes our standard laminates, Steelcase High-Pressure Laminates, and standard High-Pressure Laminates from Nevamar, Wilsonart, Formica, and Pionite.

Coalesse Standard Laminate

Grade 1

Coalesse High-Pressure Laminates are priced as Grade 1.

High-Pressure Laminates listed below are not available on all products, check laminate matrix for availability.

2730	Arctic White
2746	Black
2826	White Nebula
2829	Poppysseed
2830	Charcoal
2884	Milk
2886	Maple
2887	Amber Cherry
2890	Folkstone BMW
2891	Ingot
2892	Ash
2894	Natural Cork
2895	Natural Walnut
2896	Dark Cork
2897	Desert Oak
2898	Satin Stainless

Steelcase Standard Laminate

Grade 1

Steelcase High-Pressure Laminates are priced as Grade 1. All Steelcase High-Pressure Laminates may be specified on Coalesse products with exception (must be ordered as Special): Awaiting tables, Enea tables, Enea Lottus tables, and Sidewalk tables. The use of Steelcase High-Pressure Laminate may be subject to extended lead times.

Tip: For a visual palette, please refer to the Steelcase Finish Library.

Fiber Laminate

2850	Vanadium Fiber
2851	Rhyme Fiber
2852	Tungsten Fiber
2854	Vellum Fiber
2859	Novell Fiber
2860	Granite Fiber
2861	Coconut Fiber
2862	Stucco Fiber

Micro Laminate

2920	Marl Micro
2921	Gypsum Micro
2922	Clay Micro
2923	Shadow Micro

Patina Laminate

2870	Blonde Bronze Patina
2871	Balckened Bronze Patina
2873	Instant Iron Patina

Solid Laminate

2722	Cream
2730	Arctic White
2746	Black
2759	Warm White
2811	Mist
2883	Seagull
2884	Milk
2885	Dune
2HMG	Merle

Speckle Laminate

2820	Coffee Speckle
2822	Woodrose Speckle
2823	Driftwood Speckle
2824	Smoke Speckle
2825	Vanadium Speckle

Woodgrain Laminate

2406	Clear Cherry
2409	Clear Maple
2410	Graphite Walnut
2412	Natural Cherry
2422	Medium Cherry
2511	Winter on Maple
2538	Clear Walnut
2539	Warm Oak
2592	Blonde on Maple
2714	Natural Walnut
2772	Medium Mahogany on Walnut
2HAK	Clear Oak
2HAN	Ash Noce
2HAT	Acacia
2HAW	Ash Wenge
2HBN	Bisque Noce
2HBW	Bisque Wenge
2HCN	Clay Noce
2HCW	Clay Wenge
2HSN	Storm Noce
2HSW	Storm Wenge

turnstone Laminate Collection

A selection of laminates and edgebands are available on some Coalesse brand products. This collection is stocked and available with standard lead times and supported like standard laminates to help make ordering easy.

Tip: For a visual palette, please refer to the Steelcase Finish Library.

2535	Virginia Walnut
2536	Blackwood
2612	Marbled Maple
2614	Chocolate Walnut
2615	Marbled Cherry

Steelcase Select Surfaces Laminate

Grade 2

Textured Woodgrain Laminate

2TH2	Fawn Cypress
2TH3	Weathered Char
2TH4	Saddle Oak
2TH5	Veranda Teak
2TH6	Persian Cherry
2TH7	Walnut Heights

Tip: Because these finishes are part of Steelcase Select Surfaces, they may have additional lead times.

Textured Industrial Laminate

2UH1	Reclaimed Aggregate
2UH2	Reclaimed Gravel
2UH4	Cement*
2UH6	Sheetrock

Tip: Because these finishes are part of Steelcase Select Surfaces, they may have additional lead times.

*2UH4 Cement is only available on select table sizes.

Open Line Laminates

Customers can select laminates that are not offered as standard from select suppliers. Standard grade High-Pressure Laminates can be specified in Grade 1 (290A) or Grade 2 (290B) as indicated below (subject to availability). Grade 2 laminates will have extended lead time. Select from any Coalesse or Steelcase standard edge band finishes.

Contact Customer Service at 1.800.627.6770 to verify that your laminate selection falls within the categories noted below.

Directional patterns and woodgrains may be used on freestanding systems products, but will not be patterned matched.

Some standard High-Pressure Laminates, may not be available in the appropriate size to produce large products.

Wilsonart (Grade 1)
Standards (matte finish)
*Exceptions: High definition which must be quoted as a special.
Marker board which is grade 2.*

Nevamar (Grade 2)
Solids (textured finish)
Patterns (textured finish)

Formica (Grade 2)
Color portfolio (matte finish)
Patterns (matte finish)
Formations (matte finish)

Pionite (Grade 2)
Decorative surfaces (suede finish)

Non-Standard Laminates

Coalesse can supply additional laminates for an upcharge. Contact your Coalesse sales consultant for a custom quotation. Custom upcharges will vary based upon the cost of the material specified and additional labor required to manufacture the products. Some non-standard laminates will not be available in the appropriate size to produce large Coalesse products. A sample of the laminate may be requested for approval. Some non-standard laminates may be subject to extended lead times.

Coalesse does not use the following types of laminate materials on Topo:

- Formica solid surfacing – Surell Solids, Surell Granites
- Nevamar – Fountainhead
- Dupont – Corian
- Metal Laminates – textured, brushed or polished

Coalesse

Surface Materials - Laminate

High-Pressure Laminate Matrix

Legend

- = Not available
- = Available
- ▶ See specification pages for details.

Seating

Await	■	■	•	•	•	•	•	•	•	•	•	•	•	•	•	•	■
Bix Podium Drawer Front	■	■	■	■	■	■	■	■	■	■	■	■	■	■	■	■	•
Coupe	■	■	•	•	•	■	•	•	■	■	■	■	■	■	■	■	•
Sidewalk Tablet	■	■	•	•	•	■	•	•	■	■	■	■	■	■	■	■	•
Swathmore Grande	■	■	•	•	•	■	•	•	■	■	■	■	■	■	■	■	•

Occasional Tables

Await	■	■	•	•	•	•	•	•	•	•	•	•	•	•	•	•	■
Bix Tables	■	■	■	■	■	■	■	■	■	■	■	■	■	■	■	■	•
Bob Tables	■	■	■	■	■	■	■	■	■	■	■	■	■	■	■	■	•
Circa Tables	■	■	■	■	■	■	■	■	■	■	■	■	■	■	■	■	•
Enea	■	■	■	■	■	■	■	■	■	■	■	■	■	■	■	■	•
Enea Lottus	■	■	■	■	■	■	■	■	■	■	■	■	■	■	■	■	•
Lagunitas Tables	■	■	■	■	■	■	■	■	■	■	■	■	■	■	■	■	•
Lagunitas Focus Nook	■	■	■	■	■	■	■	■	■	■	■	■	■	■	■	■	•
Montara650	■	■	■	■	■	■	■	■	■	■	■	■	■	■	■	■	•
Sidewalk	■	■	■	■	■	■	■	■	■	■	■	■	■	■	■	■	•
SW_1	■	■	■	■	■	■	■	■	■	■	■	■	■	■	■	■	•

Tables and Casegoods

Au Lait	■	■	■	■	■	■	■	■	■	■	■	■	■	■	■	■	•
Ballet	■	■	■	■	■	■	■	■	■	■	■	■	■	■	■	■	•
E-Table 2 Top	■	■	■	■	■	■	■	■	■	■	■	■	■	■	■	■	•
E-Table 2 Laminate Base	■	■	•	•	•	■	•	•	■	■	■	■	■	■	■	■	•
Enea	■	■	■	■	■	■	■	■	■	■	■	■	■	■	■	■	•
Enea Lottus	■	■	■	■	■	■	■	■	■	■	■	■	■	■	■	■	•
Host Collection	■	■	■	■	■	■	■	■	■	■	■	■	■	■	■	■	•
Montara650	■	■	■	■	■	■	■	■	■	■	■	■	■	■	■	■	•
Reunion Collection	■	■	■	■	■	■	■	■	■	■	■	■	■	■	■	■	•
SW_1	■	■	■	■	■	■	■	■	■	■	■	■	■	■	■	■	•
Train	■	■	■	■	■	■	■	■	■	■	■	■	■	■	■	■	•

Standard Coalesse High-Pressure Laminate																	Standard Steelcase High-Pressure Laminate																
2730 Arctic White	2746 Black	2826 White Nebula	2829 Poppyseed	2830 Charcoal	2884 Milk	2886 Maple	2887 Amber Cherry	2890 Folkstone	2891 Ingot	2892 Ash	2894 Natural Cork	2895 Natural Walnut	2896 Dark Cork	2897 Desert Oak	2898 Satin Stainless	290N North Sea	2406 Clear Cherry	2409 Clear Maple	2410 Graphite Walnut	2412 Natural Cherry	2422 Medium Cherry	2503 Brushed Silver	2511 Winter on Maple	2535 Virginia Walnut	2536 Blackwood	2538 Clear Walnut							
Seating																	Seating																
Occasional Tables																	Occasional Tables																
Tables and Casegoods																	Tables and Casegoods																

High-Pressure Laminate Matrix *continued*

Legend

- = Not available
- = Available
- ▶ See specification pages for details.

	2HBW Bisque Wenge	2HCN Clay Noce	2HCW Clay Wenge	2HMG Merle	2HSN Storm Noce	2HSW Storm Wenge	Select Surfaces Steelcase High-Pressure Laminate*									
							2TH2 Fawn Cypress	2TH3 Weathered Char	2TH4 Saddle Oak	2TH5 Veranda Teak	2TH6 Persian Cherry	2TH7 Walnut Heights	2UH1 Reclaimed Aggregate	2UH2 Reclaimed Gravel	2UH4 Cement	2UH6 Sheetrock
Seating																
Await	•	•	•	•	•	•	•	•	•	•	•	•	•	•	•	•
Bix Podium Drawer Front	■	■	■	■	■	■	■	■	■	■	■	■	■	■	■	■
Coupe	•	•	•	•	•	•	•	•	•	•	•	•	•	•	•	•
Sidewalk Tablet	•	•	•	■	•	•	■	■	■	■	■	■	■	■	■	■
Swathmore Grande	•	•	•	•	•	•	•	•	•	•	•	•	•	•	•	•
Occasional Tables																
Await	•	•	•	•	•	•	•	•	•	•	•	•	•	•	•	•
Bix Tables	■	■	■	■	■	■	■	■	■	■	■	■	■	■	■	■
Bob Tables	■	■	■	■	■	■	■	■	■	■	■	■	■	■	■	■
Circa Tables	■	■	■	■	■	■	■	■	■	■	■	■	■	■	■	■
Enea	■	■	■	■	■	■	■	■	■	■	■	■	■	■	■	■
Enea Lottus	■	■	■	■	■	■	•	•	•	•	•	•	•	•	•	•
Lagunitas Tables	■	■	■	■	■	■	■	■	■	■	■	■	■	■	■	■
Lagunitas Focus Nook	■	■	■	■	■	■	■	■	■	■	■	■	■	■	■	■
Montara650	■	■	■	■	■	■	■	■	■	■	■	■	■	■	■	■
Sidewalk	■	■	■	■	■	■	■	■	■	■	■	■	■	■	■	■
SW_1	■	■	■	■	■	■	■	■	■	■	■	■	■	■	■	■
Tables and Casegoods																
Au Lait	■	■	■	■	■	■	■	■	■	■	■	■	■	■	■	■
Ballet	■	■	■	■	■	■	■	■	■	■	■	■	■	■	■	■
Bob	■	■	■	■	■	■	■	■	■	■	■	■	■	■	■	■
E-Table 2 Top	■	■	■	■	■	■	■	■	■	■	■	■	■	•	■	■
E-Table 2 Laminate Base	■	•	•	•	•	•	•	•	•	•	•	•	•	•	•	•
Enea	■	■	■	■	■	■	■	■	■	■	■	■	■	■	■	■
Enea Lottus	■	■	■	■	■	■	•	•	•	•	•	•	•	•	•	•
Host Collection	■	■	■	■	■	■	■	■	■	■	■	■	■	■	•	■
Montara650	■	■	■	■	■	■	■	■	■	■	■	■	■	■	■	■
Reunion Collection	■	■	■	■	■	■	■	■	■	■	■	■	■	■	■	■
SW_1	■	■	■	■	■	■	■	■	■	■	■	■	■	■	■	■
Train	■	■	■	■	■	■	■	■	■	■	■	■	■	■	■	■

* Because these finishes are part of Steelcase Select Surfaces, they may have additional lead times.

High-Pressure Laminate Matrix

Surface Materials - Glass

Glass

Not all glass selections are available on every product. Refer to glass matrix for availability by product.

Back-Painted Glass

6720	Sand
6721	Pewter
6722	Mojave
6723	Terra
6724	Jade
6725	Ocean
ACM	Absolute Clear with Moonlight
ACS	Absolute Clear with Sage
ACP	Absolute Clear with Poppy
ACG	Absolute Clear with Goldenrod
ACB	Absolute Clear with Black
ACC	Absolute Clear with Crystal Spring

Glass

6511	Acid Etched
AC	Absolute Clear
ACF	Absolute Clear Frosted
CG	Clear Green
CGF	Clear Green Laminated/Frosted Appearance

Exclusive to Emu products:

6547	Transparent
6548	Smoke Grey

Surface Materials - Metal/Paint

Metal/Paint

Coalesse powder coats all painted metal components for an exceptionally durable, environmentally responsible finish — eliminating VOC's (volatile organic compounds) from being released into the environment. Electrostatically charged powder coat material is applied to an exacting thickness and then temperature baked, resulting in a smooth, flawless finish that is abrasion and impact resistant. The following Coalesse metal finishes are available:

Paint

Coalesse Standard Paint—Neutrals

Grade 1

Standard Coat Paint

- 4138 Graphite Gloss
- 4140 Arctic White Gloss
- 4141 Platinum Matte
- 4142 Platinum Gloss
- 4144 Black Gloss (formerly anthracite gloss)
- 4145 Milk Gloss
- 4146 Champagne Matte
- 4147 Champagne Gloss
- 4148 Midnight Brown Gloss
- 4180 Graphite Matte
- 4193 Midnight Brown Matte
- 4242 Milk Matte
- 4710 Low Gloss Black
- 7196 Midnight Brown Textured
- 7197 Anthracite Textured

Coalesse Standard Paint—Colors

Grade 1

- 4065 Blue Ink Textured
- 4066 Ocean Textured
- 4067 Ice Textured
- 4068 Olive Textured
- 4069 Honey Textured
- 4070 Currant Textured
- 4071 Saffron Textured

Steelcase Select Surfaces Paint

Accent Paints

Grade 3

Allow customers to add trend-driven color to painted surfaces. We evolve this collection often, to ensure that fresh new colors are always available.

- 1ATB Cloud
- 1ATG Rose Quartz
- 1ATH Olivine
- 1ATJ Seasalt
- 1ATK Citrine
- 4AQB Wasabi
- 4AQ9 Scarlet
- 4AV3 Blue Jay
- 4AV4 Baltic
- 4AX0 Flash
- 4AX1 Citron
- 4AY2 Chili
- 4AZ5 Marlin
- 4BH7 Canary
- 4BQ7 Fuchsia
- 4CZ1 Aubergine
- 4CZ2 Peacock
- 4CZ3 Jungle
- 4CZ4 Merlot
- 4CZ5 Honey
- 4CZ6 Lagoon
- 4CZ7 Saffron
- 4CZ8 Light Peacock
- 4EE9 Electric Indigo

Lux Coatings

Grade 3

Introduces a softer, more human-centered aesthetic to the workplace. These powder coat paints provide tasteful accent for your spaces.

- 4B20 Obsidian
- 4B22 Matte Brass
- 4B23 Burnished Bronze
- 4B24 Night Bronze
- 4B25 Matte Copper
- 4B26 Smoked Mica
- 4B27 Blue Steel
- 4B28 Silver Lilac
- 4B29 Cast Iron
- 4B30 Bright Gold

Applies to: Emu Advanced Collection*

- 4251 Emu Indian Brown
 - 4256 Aluminum
 - 4257 Antique Iron
 - 7234 Emu Black
 - 7271 Emu White
 - 7272 Blue
 - 7273 Green
 - 7294 Emu Grey/Green
 - 7296 Emu Taupe
 - 7297 Emu Corten
 - 7298 Emu Copper
 - 7391 Emu Poppy
- *Not all colors available on all products as standard, consult Emu advanced paint matrix.

Applies to: Enea

- 4018 Silver Metallic
- 4016 White Gloss
- 4017 Black Gloss

Applies to: Enea Lottus

- 4062 Anthracite Grey Textured
 - 4063 Cool Grey Textured
 - 4064 Sand Textured
 - 4216 Red*
 - 4217 Brown
 - 4218 Platinum Silver
 - 7207 Black Textured
 - 7241 Arctic White Textured
- *Not available on Enea Lottus tables.

Applies to: Exponents (Base, Accent Ribbon, Handle, and Grommet)

- 4135 Black Matte
- 4141 Platinum Matte

Applies to: Exponents mobile displays (Base, Handle, and Inner Frame)

- 4135 Black Matte
- 4145 Milk Gloss

Metal

Anodized Aluminum

- Applies to: Rod or disc pulls
- 5200 Satin Aluminum

Brushed Aluminum

- Applies to: Lox stool
- 9251 Brushed Aluminum

Polished Aluminum

- Applies to: Lox chair, Potrero415, and Bindu conference bases
- 8046 Polished Aluminum

Applies to: Bob and SW_1

- 8040 Aluminum Matte Polished

Chrome

- 9201 Chrome
- 9207 Polished trivalent chrome
- 9208 Etched trivalent chrome

Brushed Nickel

- Applies to: Millbrae seating and tables
- 9238 Brushed Nickel

Coalesce

Surface Materials - Metal/Paint

Metal/Paint Matrix

Legend

- = Not available
- = Available
- ▶ See specification pages for details.

Seating

Bindu Conference
Bindu Guest
Bix
Bob
Capa
Chord
Circa
Coupe
Enea
Enea Lottus
Lagunitas
Last Minute
Lox Stool
Millbrae
Montara650
SW_1
Switch
Topo Lounge
Visalia
Wrapp

Occasional Tables

Bix (vinyl version)
Bob
Circa
Enea
Enea Lottus
Lagunitas
Lagunitas Focus Nook
Millbrae
Montara650
Switch
SW_1

Coalesse Standard Paint—Neutrals										Coalesse Standard Paint—Colors										Product Line Exclusives								
4135 Black Matte	4138 Graphite Gloss	4140 Arctic White Gloss	4141 Platinum Matte	4142 Platinum Gloss	4144 Black Gloss	4145 Milk Gloss	4146 Champagne Matte	4147 Champagne Gloss	4148 Midnight Brown Gloss	4180 Graphite Matte	4193 Midnight Brown Matte	4242 Milk Matte	4710 Low Gloss Black	7196 Midnight Brown Textured	7197 Anthracite Textured	4065 Blue Ink Textured	4066 Ocean Textured	4067 Ice Textured	4068 Olive Textured	4069 Honey Textured	4070 Currant Textured	4071 Saffron Textured	LessThanFive	LessThanFive Essential	Enea Exclusive Finishes	Enea Café Wood Exclusive Finishes	Enea Lottus Exclusive Finishes	
Bindu Conference	•	•	•	•	•	•	•	•	•	•	•	•	•	•	•	•	•	•	•	•	•	•	•	•	•	•	•	•
Bindu Guest	•	•	•	•	•	•	•	•	•	•	•	•	•	•	•	•	•	•	•	•	•	•	•	•	•	•	•	•
Bix	•	■	■	■	■	■	■	■	■	■	■	■	■	■	■	•	•	•	•	•	•	•	•	•	•	•	•	•
Bob	•	■	•	■	■	■	■	■	■	■	■	■	■	■	■	•	•	•	•	•	•	•	•	•	•	•	•	•
Capa	•	•	•	•	•	•	•	•	•	•	•	•	•	•	•	•	•	•	•	•	•	•	•	•	•	•	•	•
Chord	•	•	•	•	•	•	•	•	•	•	•	•	•	•	•	•	•	•	•	•	•	•	•	•	•	•	•	•
Circa	•	■	■	■	■	■	■	■	■	■	■	■	■	■	■	•	•	•	•	•	•	•	•	•	•	•	•	•
Coupe	•	■	■	•	■	■	•	•	■	•	•	•	•	•	•	•	•	•	•	•	•	•	•	•	•	•	•	•
Enea	•	•	•	•	•	•	•	•	•	•	•	•	•	•	•	•	•	•	•	•	•	•	•	•	■	•	•	•
Enea Lottus	•	•	■	•	■	■	■	■	■	•	•	•	•	•	•	■	■	■	■	■	■	■	■	•	•	•	■	•
Lagunitas	•	•	•	■	•	•	•	•	•	•	•	•	•	■	•	•	•	•	•	•	•	•	•	•	•	•	•	•
Last Minute	•	•	•	•	•	•	•	•	•	•	•	•	•	•	•	•	•	•	•	•	•	•	•	•	•	•	•	•
Lox Stool	•	•	•	•	•	•	•	•	•	•	•	•	•	•	•	•	•	•	•	•	•	•	•	•	•	•	•	•
Millbrae	•	■	•	■	•	■	■	•	•	■	■	■	■	■	■	■	■	■	■	■	■	■	■	•	•	•	•	•
Montara650	•	■	•	■	•	■	■	•	•	■	■	■	■	■	■	■	■	■	■	■	■	■	■	•	•	•	•	•
SW_1	•	•	•	•	•	•	•	•	•	•	•	•	•	•	•	•	•	•	•	•	•	•	•	•	•	•	•	•
Switch	•	•	•	•	•	•	•	•	•	•	•	•	•	•	•	•	•	•	•	•	•	•	•	•	•	•	•	•
Topo Lounge	•	■	■	■	■	■	■	■	■	■	■	■	■	■	■	•	•	•	•	•	•	•	•	•	•	•	•	•
Visalia	•	■	•	■	•	■	■	•	•	■	■	■	■	■	■	■	■	■	■	■	■	■	■	•	•	•	•	•
Wrapp	•	•	•	•	•	•	•	•	•	•	•	•	•	•	•	•	•	•	•	•	•	•	•	•	•	•	•	•
Bix (vinyl version)	•	■	■	■	■	■	■	■	■	■	■	■	■	■	■	•	•	•	•	•	•	•	•	•	•	•	•	•
Bob	•	■	•	■	■	■	■	■	■	■	■	■	■	■	■	•	•	•	•	•	•	•	•	•	•	•	•	•
Circa	•	■	■	■	■	■	■	■	■	■	■	■	■	■	■	•	•	•	•	•	•	•	•	•	•	•	•	•
Enea	•	•	•	•	•	•	•	•	•	•	•	•	•	•	•	•	•	•	•	•	•	•	•	•	■	•	•	•
Enea Lottus	•	•	■	•	■	■	■	■	■	•	•	•	•	•	•	■	■	■	■	■	■	■	■	•	•	•	■	•
Lagunitas	•	■	■	■	■	■	■	■	■	■	■	■	■	■	■	■	■	■	■	■	■	■	■	•	•	•	•	•
Lagunitas Focus Nook	•	■	■	■	■	■	■	■	■	■	■	■	■	■	■	■	■	■	■	■	■	■	■	•	•	•	•	•
Millbrae	•	■	•	■	•	■	■	•	•	■	■	■	■	■	■	■	■	■	■	■	■	■	■	•	•	•	•	•
Montara650	•	■	•	■	•	■	■	•	•	■	■	■	■	■	■	■	■	■	■	■	■	■	■	•	•	•	•	•
Switch	•	•	•	•	•	•	•	•	•	•	•	•	•	•	•	•	•	•	•	•	•	•	•	•	•	•	•	•
SW_1	•	•	•	•	•	•	•	•	•	•	•	•	•	•	•	•	•	•	•	•	•	•	•	•	•	•	•	•

Emu Advanced Collection Paint Matrix

Legend

- = Not available
- = Available
- ▶ See specification pages for details.

	4251 Emu Indian Brown	4256 Aluminum	4257 Antique Iron	7234 Emu Black	7271 Emu White	7272 Blue	7273 Green	7294 Emu Grey/Green	7296 Emu Taupe	7297 Emu Corten	7298 Emu Copper	7391 Emu Poppy
Heaven Seating, Tables, and Pouf	•	■	•	■	■	•	•	•	•	•	•	•
Heaven Vases	•	•	•	•	■	•	•	•	•	•	•	•
Ivy Collection	•	•	•	•	■	•	•	•	•	•	•	•
Pattern Collection	•	•	•	■	■	■	■	•	•	•	•	■
Retrouvé Collection	•	•	•	•	■	•	•	•	•	•	•	•
Round Collection	■	•	■	■	■	•	•	•	•	•	•	•

Tip: Select product lines allow for other Emu paint finishes (those shown as not available on the matrix) as an available option. Consult the Coalesse Seating and Outdoor Specification Guide for details.

Surface Materials - Miscellaneous

Convex Vinyl Edge Band

- Applies to:
- Au Lait (includes cast urethane) and E-Table:
- | | |
|------|------------|
| 6000 | Black |
| 6607 | Woodrose |
| 6609 | Smoke |
| 6655 | Warm White |

Cast Urethane Edge

- Applies to:
- Au Lait
- | | |
|------|------------|
| 6000 | Black |
| 6607 | Woodrose |
| 6609 | Smoke |
| 6655 | Warm White |

Plastic

- Applies to:
- Enea
- | | |
|------|-----------------|
| 003 | White |
| 0013 | Sunset Orange |
| 0014 | Clover Green |
| 0015 | Sand |
| 0016 | Walnut Brown |
| 0017 | Cool Grey |
| 0400 | Black |
| 0405 | Periwinkle |
| 0406 | Alabaster |
| 0409 | Red |
| 0414 | Anthracite Grey |
| 0421 | Blue |

- Applies to:
- Enea Lottus
- | | |
|------|-----------------|
| 003 | White |
| 0013 | Sunset Orange |
| 0014 | Clover Green |
| 0015 | Sand |
| 0016 | Walnut Brown |
| 0017 | Cool Grey |
| 0400 | Black |
| 0409 | Red |
| 0414 | Anthracite Grey |
| 0421 | Blue |
| 0422 | Blue Ink |
| 0423 | Ocean |
| 0424 | Ice |
| 0425 | Olive |
| 0426 | Honey |
| 0427 | Currant |
| 0428 | Saffron |

Tip: Not all colors available on all products. Consult the Enea plastic matrix for product line availability.

- Applies to:
- Exponents mobile cart, moby, and mobile display casters
- | | |
|------|--------------|
| 6000 | Black |
| 6009 | Arctic White |

- Applies to:
- Lox stools
- | | |
|------|-------------|
| 6347 | Black Gloss |
| 6348 | White Gloss |

- Applies to:
- SW_1 tablets, grommet, barrier, wire manager, sub-structure, lounge tablet, Sebastopol grommet
- | | |
|------|-------|
| 6000 | Black |
| 6052 | Milk |

- Applies to:
- Grommet, spheres, flex-gangers, Mini-Port, Interport, casters, horizontal wire manager, and vertical wire manager
- Black plastic

- Applies to:
- Lagunitas focus nook
- | | |
|------|----------|
| 6000 | Black |
| 6052 | Milk |
| 6D03 | Graphite |

TAP Power Module Door Finishes

Brushed Anodized Aluminum

- Applies to:
- Host
- | | |
|------|--------|
| 8043 | Silver |
| 8044 | Black |

Utility Bay

- Applies to:
- E-Table 2
- | | |
|------|---------------|
| 4137 | Matte Black |
| 4745 | Nickel Mica |
| 4746 | Silver Mica |
| 4747 | Charcoal Mica |

Glass Doors

- Applies to:
- Host credenzas
 - Frosted glass

Locks

- Applies to:
- Denizen and Exponents
- | | |
|------|--------------|
| 9211 | Nickel |
| 9250 | Ember Chrome |

Interior and Plinth

- Applies to:
- Host credenzas
- Black Melamine

Solid

- Applies to:
- Exponents and SW_1 tables
- | | |
|------|---------------|
| 2801 | Glacier White |
|------|---------------|

Grommet

- Applies to:
- Exponents
- | | |
|------|----------------|
| 4135 | Black Matte |
| 4141 | Platinum Black |

Power, Voice Data Modules

- Applies to:
- Exponents
- | | |
|------|--------------------|
| 4140 | Arctic White Gloss |
| 4141 | Black Gloss |

Glossy Laminate

- Applies to:
- Sebastopol
- | | |
|------|---------------------|
| 2001 | Smoky White Glossy |
| 2002 | Studio Grey Glossy |
| 2003 | Wrought Iron Glossy |
| 2004 | Black Pearl Glossy |
| 2005 | Liberty Red Glossy |

Ordering

How to Order

Coalesse furniture is available through authorized dealers and retailers. Select products are available for order from our web site. The authorized dealer can help you with everything from surface material selection and order placement, to specialized services, such as space planning and design, delivery and installation. Best of all, they are part of your local community, providing expert advice with a thorough understanding of local needs. For more information and a listing of dealers and retailers, visit www.coalesse.com or call 1.800.627.6770.

Coalesse reserves the right to limit distribution of any or all models.

Credit, Prices, and Terms

Credit may be established upon acceptance of satisfactory references. For payment terms, contact Coalesse's Credit Department. Coalesse may cancel or change credit terms at its discretion and may request advance payment at any time.

The order confirmation will be deemed by the customer and by Coalesse, as the final expression of agreement and will be deemed the exclusive statement of terms. The order confirmation supersedes all prior writings and may not be modified or rescinded, except by a revised Coalesse order confirmation signed by the customer. No changes are binding on Coalesse until delivery of the order confirmation.

Any storage charges and applicable sales taxes are in addition to the prices shown for merchandise. Inside delivery, uncartoning and installation are customer's responsibility unless separately quoted. All list pricing shown includes freight prepaid to one destination for delivery in the 48 contiguous United States. Hawaii and Alaska are not included. We reserve the right to increase prices without notice due to increases in labor and material costs. If timely payment is not made, customer is liable for reasonable collection costs, including attorney's fees.

Shipping and Storage

Coalesse reserves the right to select carrier and packaging method. Partial shipments may be delivered. Coalesse is not liable for delays or delivery failure due to strikes, lockouts, labor, or transportation difficulties, failure or delay of supply sources, accidents, fire, acts of God, or any other cause of like or unlike nature beyond Coalesse's control. Coalesse may transfer merchandise to storage if not accepted when shipment scheduled. Transfer and storage charges will be the customer's expense. Coalesse's invoice is payable upon transfer. If transfer is made prior to confirmed shipping date, storage expenses will be borne by customer.

Shipping charges MAY be calculated per order. Lead-times vary by product. Coalesse reserves the right to select carrier. Partial shipments may be delivered. Coalesse will make every effort to provide current and accurate lead-time information, however, Coalesse is not liable for delays or delivery failure due to strikes, lockouts, labor, or transportation difficulties, failure or delay of supply sources, accidents, fire, acts of God, or any other cause of like or unlike nature beyond Coalesse's control.

Freight is included on domestically manufactured products within the 48 contiguous states of the United States and standard freight service of Carl Hansen & Søn and Emu.

Claims

Merchandise shipped from Coalesse is thoroughly inspected and properly packed before leaving the factory. Responsibility of its safe delivery is assumed by the carrier at the time of shipment. Customer must match the freight delivered with the bill of lading. Customer must examine packaging material upon delivery and note any damage on the carrier bill of lading. If there is damage to the packaging material, inspect the furniture immediately. If concealed damage is found, contact the carrier within 10 days of delivery date. Save all packaging materials until after inspection.

Freight damage and claims must be reported by the purchaser to the carrier. Coalesse is not responsible for freight claims. Claims for loss or damage must not be deducted from our invoice, nor payment withheld awaiting adjustment of such claims. Do not return any merchandise to Coalesse without a Return Authorization number. By following these procedures carefully, Coalesse guarantees our full support of your claims to protect you against loss or damages. All claims against Coalesse for defects, errors or shortages must be made by customer in writing within ten (10) days after delivery. Failure to make claims within ten (10) days constitutes acceptance of merchandise and waives claims. Cutting of textiles deems acceptance of yardage and waives all defects, errors, and shortages. Coalesse is not liable for subsequent damages.

Special/Custom Products

Coalesse prides itself on being responsive to our customer's needs. Contact our Customer Service team at 1.800.627.6770 to discuss a special opportunity. Due to product modifications and engineering time, special orders may not be cancelled. Charges will apply.

FOR MORE INFORMATION (on ordering our products) Please contact Coalesse Customer Service at: 1.800.627.6770.

Order Cancellations/Changes

All order change/cancellation requests must be submitted using the Coalesse order change/cancellation request form. Late changes could jeopardize the committed delivery of an order.

Rapid10 program, no change or cancellations allowed.

Coalesse Products:

- No charges will be assessed for change or cancellation 14 or more calendar days prior to the manufacturing completion date (excludes holidays and/or large quantity project size orders). For import products, charges may apply.

- No manufacturing changes are allowed 0-13 calendar days prior to the manufacturing completion date. Simple changes including shipping address changes are subject to approval but will be accommodated when possible.

- No cancellations or product changes will be accepted for quick ship or special/custom product orders including special laminates. A cancellation fee will be applicable for any custom product and/or change may jeopardize lead time.

- If COM/COL has been received at time of change or cancellation, it is the dealer's responsibility to advise disposition or return of materials. Coalesse will not store materials after 30 days.

Additional Charges

- Changes or cancellations that involve any of the following may be subject to a charge earlier and/or greater than shown above: Special engineering product, CSM, pre-ordered components, materials with extended lead times (e.g., veneers, special paint, etc.) or large quantities of standard materials.

- Use our Order Change/Cancellation Request Form for all order changes. It is Coalesse responsibility to accurately process change order requests. It is the dealer's responsibility to verify that we have accurately interpreted your change requests by checking the acknowledgement after the change has been made. If you do not use the web-based change order form process and an error occurs during our translation which cannot be corrected prior to ship, all costs will be shared on a 50/50 basis. Changing ship dates or adding product to your order is subject to the availability of manufacturing capacity.

- Cartoning changes and shipping address changes are subject to approval and to a change charge. Please consult your Customer Service for specific information pertaining to your order.

Reserved Fabric Policy

Prior to order receipt, reserving textiles (COM/COL, Maharam, Designtex, and select Luna Graded-In) is the responsibility of the dealer. Coalesse cannot reserve textiles based on projected orders. Coalesse cannot guarantee Maharam or Designtex fabric availability. If dealer reserves Maharam or Designtex textiles, Coalesse will require the reserve number and zip code for locating purposes when ordering.

Schedule Enhancements

Coalesse will entertain schedule enhancements on a case-by-case basis; however, please understand that we must receive complete information such as installation date, opening date, etc., to make informed scheduling decisions.

No order move-ups or move-outs are allowed on any order that falls within the 15-working day period of its manufacturing completion date. If it is within the 15-working day period, Coalesse will invoice at shipment but may offer storage options at a charge for manufactured product.

Ordering

Surface Materials

ELMO SOFT, ELMORUSTICAL LEATHER CARE

Only the finest hides are used for Elmo leather. Expect some color variations from hide to hide due to the aniline state of the product. Color fading may occur if leather is exposed to direct or intense light. Care is required to allow this product to achieve the rich natural patina that beautiful natural leather develops. The hallmarks of this leather include some naturally occurring markings, such as healed scars, insect bites, stretch marks, and fat wrinkles. Elmorustical's leather treatment is very natural with little protection from spills or body oils. This rich leather will exhibit stains and oils through normal use. Coalesse is not responsible for discoloration, spotting, or staining on this leather.

Special Color Match Leather

Coalesse can provide a special color match in its leather to any supplier's leather color, paint color, carpet color, wall-paper color, etc. Sample to match must be submitted to Coalesse with purchase order. Sample for approval can be supplied if requested.

Note: Minimum order 2,500 sq. ft.

Special Fabric Applications

(available on GradedIn or Coalesse to purchase orders)

Teflon protection

- Minimum charge:
- 1-30 yards \$125 list
 - 31+ yards \$2.50 list/per yard

Latex backing

- 1-50 yards \$260 list minimum charge
- 50+ yards \$8.00 list/per yard

Tip: Prices subject to change without notice and an additional 2 week lead time will apply for 54" wide fabrics. Wider fabrics will require 4 week additional lead time. Multiple rolls will incur additional charges per roll.

Upholstery

All Coalesse textiles are priced by grades. Some Coalesse fabrics can be treated for flame retardancy, contact Customer Service. All Coalesse products are handcrafted making each unique. Certain fabrics and leathers will appear loose and may differ from like products due to comfort wrinkles when upholstered.

A contrasting welt is available on some products. Consult Customer Service for yardage or square feet requirements and prices. All stripes will be applied vertically unless customer specifies otherwise. Loose cushions on Coalesse products are not fully upholstered (not reversible).

Designtex, Maharam, and select Luna fabrics are graded in our pricing. Simply order Coalesse products with Designtex, Maharam, and select Luna specified. Designtex and Maharam fabrics are graded in on Coalesse products; however, Coalesse does not stock fabrics and can only respond based on Designtex and Maharam lead times. For current grades, refer to Coalesse website: www.Coalesse.com.

Pre-approved CAL 133 Textiles Designtex and Maharam textiles have been graded into our pricing; however, not all textiles are recommended on all seating. For current grade and approval information, please visit our website and click on FABRICEVALUATIONS to obtain grade pricing for a specific pattern.

Wood and Finish Specifications

Solid hardwood is a renewable natural resource, and each section of a tree is unique. The color and grain pattern will vary emphasizing the natural beauty of each product built. Wood is a natural material and will accept stain differently. Coalesse cannot guarantee finished products to be an exact match to finish samples due to the natural characteristics of wood. Light finishes will exhibit some mineral streaks and dark graining due to the natural wood.

The finish used by Coalesse on hardwood frames and occasional tables is pre-catalyzed lacquer which can be easily repaired in the field if damage occurs. Veneer is sanded prior to finish application, and sanded between coats. The lacquer top coat is then polished after final application with wool wax. 4 to 6 layers of finish are applied during the process. The CH process varies from our internal processes.

Coalesse Tables and Casegoods

Coalesse's primary wood finish, Clarity, is a water-borne UV topcoat, which protects the environment while providing exceptional durability and resistance to water and chemical stains. contoured products, such as wood guest chairs & occasional tables, are finished with post-catalyzed vinyl, which provides similar properties and matches the sheen and color of Clarity, due to natural variations in wood, finished products may vary from samples in color, texture, and grain.

Stain-To-Match Program

Coalesse will offer a stain to match program at no additional upcharge for all products with wood finish options.

Customer must supply Coalesse Customer Service with sample to be matched. (internal note - CSR's will have samples of bare wood to compare and define species when applicable that will be used to accomplish the closest stain to match).

Coalesse high sheen will be standard unless specified by customer.

Sheen to match is available as part of the stain/sheen to match program at no upcharge.

Species to match is considered a special and requires to special request to Coalesse Customer Service. Species to match may require an upcharge.

Care and Maintenance

Chrome

Use commercial cleanser and polish, according to manufacturer's directions.

Fabric

Under normal use, clean with soft cloth dampened with water. For spots and spills, we recommend professional cleaning. For COM, refer to the specific cleaning instructions recommended by the fabric supplier.

Emu Outdoor Fabric:

Remove loose dirt with soft bristle brush or hose down with cold water. Clean with mixture of water and mild soap. Rub in mixture with soft brush and allow to thoroughly soak into fabric. Rinse thoroughly with cold water and air dry. Never use water over 100 degrees Fahrenheit. Do not machine dry. For light cleaning, avoid using detergents.

For stubborn stains use mixture of one gallon cold water, 1/2 cup bleach and 1/4 cup mild soap for one hour.

Detergents can be used without harm, though they may remove some of the water and stain resistant properties in the fabric.

SW_1 Knit:

Clean with warm water and soap. Wet sponge and wipe fabric. Household cleaners such as Windex™ may be used. Do NOT use cleaners containing bleach.

Laminate and solid phenolic

should be cleaned with soap and water. For stubborn stains, use a non-abrasive household cleaner.

SW_1 Tablet

surfaces clean with soft cloth dampened with water and soap, if needed. The use of general purpose cleaners are acceptable but must be void of citric content that has z-butoxyethanol in the formulation listing.

Cleaning Laminate

Markerboard Surface

Use dry erase markers only. Remove dry-erase markings with a markerboard eraser or soft cloth as often as possible. Change erasers, as they become dirty. Dirty erasers will leave ink residue on the surface.

For daily cleaning, or as needed, use a dry erase cleaner, or a non-abrasive household cleaner, such as glass cleaner. This may be done with a soft cloth or sponge. Dry the surface with a soft cloth prior to writing. All markings should be removed weekly.

Caution:

- Do not use permanent markers on markerboard surfaces. In the event a permanent marker is used, removal of markings may be attempted by using dry erase cleaner, or by writing over the marking with a dry erase marker and erasing with a markerboard eraser or soft cloth.
- Do not use abrasive cleaners or solvent type cleaning solutions, such as Ketones (Acetone, MEK, etc.) lacquer thinner, nail polish remover, etc. because they may remove the finish from the markerboard surface.

Cleaning CeramicSteel

Markerboard Surface

- Care and maintenance applies to both a³ CeramicSteel and e³ CeramicSteel.
- Wipe board with a clean cloth moistened by a liquid markerboard cleaner or a solution of 50% water and 50% isopropyl alcohol.
- Rinse with clear water.
- Wipe dry with a clean cloth. If your board is used daily, the cleaning should be performed at least 2-3 times a week.

More thorough cleaning may be required if writing is left on the board for more than two days.

Markers

Use any high-quality dry erase marker.

CAUTION! The use of Low Odor markers may cause ghosting to occur. If Low Odor markers have been used, the surface can be completely cleaned by following the cleaning instructions above. Remember to discard eraser if used with Low Odor markers.

Removing Permanent Marker

Option 1:

- Write over the top of the permanent marker ink with a dry-erase marker
- Simply erase

Option 2:

- Moisten a clean, dry cloth with isopropyl alcohol
- Wipe the board in a circular motion to loosen marker residue
- Rinse with clear water
- Dry the board with a clean cloth
- Repeat these steps as necessary

Installer's Instructions for Initial Cleaning at Time of Installation

NOTE: These initial cleaning instructions are shipped with every board.

- For initial cleaning, wipe your board with a clean cloth moistened by a mild, alcohol-based cleaner.
- Rinse with clear water. This step is simple, but very important.
- Wipe dry with a clean cloth.

Leather

Under normal use, regular dusting and vacuum cleaning are all that is necessary. For spots and spills, wipe excess liquid immediately. If necessary, use lukewarm water cleaning the entire area where spot occurred and air dry. For stubborn spots or stains, use a solution of mild non-detergent soap and air dry. For butter, oil, or grease, wipe excess with dry cloth and then leave alone. The spot will dissipate into the leather. Do not apply water.

Faux Leather

Under normal use, clean with soft cloth dampened with water. For spots and stains, use the recommended mixture of Woolite and water. Rinse with clean water and air dry.

Granite/Glass

Under normal use, clean with Windex and soft cotton cloth.

Powder coat finishes on chairs and table bases

should be cleaned with a liquid detergent and water. Remove stubborn stains with liquid cleanser, such as Formula 409.

Emu Outdoor Paint:

Store in an enclosed and dry area during winter to avoid condensation. Before winter and regularly every quarter, clean the metal surfaces with a cloth dipped in water or detergent and protect them with vasoline oil or car polish. Do not use ethyl alcohol or detergents that contain even in small quantities acetone, trichloroethylene, or ammonia (or solvents in general). When storing tables, do not stack them or put the table tops in direct contact with each other. Handle the seats with care when stacking them to avoid damaging the varnished surfaces.

Polished Aluminum finishes

on table bases should be cleaned with a commercial powder, liquid, or paste metal cleaner and polish. Follow the manufacturer's directions.

Veneers and painted MDF

should be cleaned regularly with mild soap and water and dried with a soft cloth. *Tip: Never use ammonia-based cleaners or wax on wood surfaces.*

Veneers should be cleaned regularly with mild soap and water and dried with a soft cloth.

Tip: Never use ammonia-based cleaners or wax on wood surfaces.

Protecting Wood Surfaces

Use desk pads and coasters to help protect the finish against dents, scratches, moisture and hot and cold liquids. Do not use desk pads that have plastic backing. Use felt or leather pads on the bottoms of office equipments and accessories.

Periodically move desk accessories and other objects kept on the worksurface to ensure even aging.

Lift objects when you move them, instead of pulling or pushing them across the surface, to avoid scratching the surface. Avoid leaving vinyl binders on worksurface for long periods.

If you use a protective glass top, insert felt pads between the glass and the worksurface to create an air space and allow the wood to breathe.

Keep your furniture away from direct sunlight. Avoid extreme temperatures and humidity. Maintain temperatures between 60 and 80 degrees Fahrenheit and humidity levels between 30 and 50 percent.

Cleaning Wood Surfaces

Keep a supply of soft, clean, absorbent cloths handy for wiping up spills and regular dusting.

To dust, wipe with a slightly damp, soft cloth, using another soft cloth to dry. Always wipe the surface in the direction of the woodgrain.

Use a quality cleaner or flax soap formulated especially for use on wood surfaces. Do not use oils or ammonia. Dilute the cleaner as directed by the manufacturer. Dampen but do not saturate a soft cloth with the diluted cleaning solution. Wipe the surface in the direction of the woodgrain to remove dirt and fingerprints. Wipe the surface clean with a soft, dry cloth.

Care and Maintenance

Vinyl

Under normal use, clean with soft cloth dampened with mild soap solution. For stubborn stains and spills, a sponge or soft brush may be used with mild non-abrasive cleaner.

Transolid/Corian:

Clean regularly with mild soap and water. Dry with a soft cloth.

Tables should be inspected and maintained regularly by tightening screws and bolts, inspecting casters and glides for damage, and inspecting all moving parts for damage and wear.

Resources



Lock and Keying	300
Style Number Index	302

Resources Lock and Keying

All locking products are standard with factory-installed, keyed-random locks. Specific and random keying are available as field-installed options.

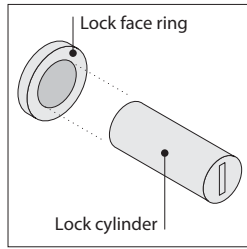

Locks consist of a factory- or field-installed lock cylinder and a factory-installed lock face ring.

One type of lock is available—the standard keying system (TA series).



Factory-Installed Keying

Factory-installed locks are always key random (standard). Key random means that the locks will be assigned arbitrarily at the factory with key numbers ranging from TA100 to TA149. All locks within a unit will be keyed alike.

Tip: Random keying can mean that different furniture units will have the same key number. If you must have all locks keyed differently, you should specify field-installed, key specific lock cylinders.

▶ See below.

Key Random

-  TA110
-  TA124
-  TA110

Field-Installed Keying

Field-installed locks are only available on products that include factory-installed lock mechanisms.

Specify "plug" when specifying furniture, and the product will ship without the lock cylinder.

Front-removable lock cylinders must be specified separately. You must also order a special lock tool to install or remove lock cylinders in the field.

Tip: Lock tools are reusable. You do not need to order additional lock tools with every furniture order.

Lock cylinders will be shipped separately so that you can install the locks when you are ready.

Two keying choices are available for field installation—random (standard) and specific.

Key random means that the locks will be assigned arbitrarily at the factory with key numbers ranging from TA100 to TA149.

Tip: Random keying can mean that different furniture units will have the same key number. If you must have all locks keyed differently, you should specify key specific lock cylinders.

Key specific means that you can specify any key number from TA100 to TA149. This option can be used to key all the furniture units in a workstation or department the same.

Tip: Designate the quantity per key number in your specification.

▶ See example at right.



Example of a typical lock cylinder specification is shown below:

10	LOCK9211TA TA100
5	LOCK9211TA TA146
15	LOCK9211TA TA131



30 Total

1 4678137SR standard lock tool

Key Random

-  TA110
-  TA124
-  TA110

Key Specific

-  TA115
-  TA115
-  TA115

Resources

Lock and Keying

Style Number Index

Style Number	Page	Description	Style Number	Page	Description
1404M	206	Switch Counter-Height Stool	391-B	161	Switch Arm Bolster
1404PC	206	Switch Counter-Height Stool	43-T171717	241	Sidewalk Occasional Table
1405M	206	Switch Bar-Height Stool	43-T222222	241	Sidewalk Occasional Table
1405PC	206	Switch Bar-Height Stool	430	100	Sidewalk Collaborative Chair
1500M	204	Switch Guest Armless Chair	430-2	101	Sidewalk Collaborative Two-Seat
1500PC	204	Switch Guest Armless Chair	430-B1724	102	Sidewalk Bench
1510M	204	Switch Guest Arm Chair	430-B1736	102	Sidewalk Bench
1510PC	204	Switch Guest Arm Chair	430-B1748	102	Sidewalk Bench
1519M	205	Switch Guest Lowback Sledbase	430-H1717	101	Sidewalk Collaborative Ottoman
1519PC	205	Switch Guest Lowback Sledbase	430-H1720	101	Sidewalk Collaborative Ottoman
1529M	205	Switch Guest Highback Sledbase	430-H2026	101	Sidewalk Collaborative Ottoman
1529PC	205	Switch Guest Highback Sledbase	430-H3636	102	Sidewalk Ottoman
1810M	178	Capa Chair	440-2WB	156	Passerelle Two-Seat Lounge
1810PC	178	Capa Chair	440-3WB	157	Passerelle Three-Seat Lounge
216	74	Bob Lounge Swivel Chair	440-B	97, 157	Passerelle Arm Bolster
221	74	Bob Lounge Chair w/Headrest	440-B2060WB	159	Passerelle Bench
221-H	75, 177	Bob Ottoman	440-B3060WB	159	Passerelle Bench
231	177	Bob Guest Chair	440-B4040WB	159	Passerelle Bench
240	104	Swathmore Chair Wood Leg	440-H1717WB	158	Passerelle Ottoman
240-2	104	Swathmore 2 St Lounge Wood Leg	440-H2026WB	158	Passerelle Ottoman
240-3	104	Swathmore 3 St Lounge Wood Leg	440-H3636WB	158	Passerelle Ottoman
241	105	Swathmore Chair Wood Base	440-WB	156	Passerelle Chair
241-2	105	Swathmore 2 St Lounge Wood Base	444	96	Sidewalk Lowback Chair
241-3	105	Swathmore 3 St Lounge Wood Base	444-2	97	Sidewalk Two-Seat
243	106	Swathmore Grande Chair Wd Leg	444M	97	Sidewalk Lowback Chair w/Tablet
243-3	106	Swathmore Grande 3 St Wd Leg	446	97	Sidewalk Highback Chair
243MTL	108	Swathmore Grande Mobile	446M	97	Sidewalk Mobile Highback Chair w/Tablet
243MTR	108	Swathmore Grande Mobile	45-T1300H	85	Circa Freestanding Table
244	107	Swathmore Grande Wd Base	45-T1300HER	84	Circa Ganging Table
244-2	107	Swathmore Grande 2 St Wd Base	45-T1300HG	84	Circa Ganging Table
244-3	107	Swathmore Grande 3 St Wd Base	45-T1300L	84	Circa Freestanding Table
2540-1	200	Kathryn Wood with Open Back	45-T1300LER	84	Circa Ganging Table
2542-1	200	Kathryn Wood/Uph with Panel Back	45-T1300LG	84	Circa Ganging Table
2547-1	200	Kathryn Fully Uphol Back	45-T1815H	83	Circa Freestanding Table
2547-1RIBD	201	Kathryn Fully Uphol Back w/Ribbed uph	45-T1815HER	83	Circa Ganging Table
3500	180	Enea Arm Chair	45-T1815HG	82	Circa Ganging Table
3500S	182	Enea Armless	45-T1815L	82	Circa Freestanding Table
3501	180	Enea Arm Chair	45-T1815LER	82	Circa Ganging Table
3501S	182	Enea Armless	45-T1815LG	82	Circa Ganging Table
3502	181	Enea Arm Chair	45-T28HER	85	Circa Ganging Table
3502S	183	Enea Armless	45-T3730H	83	Circa Freestanding Table
3503	181	Enea Arm Chair	45-T3730HER	83	Circa Ganging Table
3503S	183	Enea Armless	45-T3730HG	83	Circa Ganging Table
3510	184	Enea Bar-Height Stool w/Arms	45-T3730L	83	Circa Freestanding Table
3510S	186	Enea Armless Bar-Height Stool	45-T3730LER	83	Circa Ganging Table
3511	184	Enea Bar-Height Stool w/Arms	45-T3730LG	83	Circa Ganging Table
3511S	186	Enea Armless Bar-Height Stool	45-T42RD	86	Circa Freestanding Table
3512	185	Enea Bar-Height Stool w/Arms	45-T7460HP	85	Circa Freestanding Table
3512S	187	Enea Armless Bar-Height Stool	45-T7460HPER	85	Circa Ganging Table
3513	185	Enea Bar-Height Stool w/Arms	45-T7460HPG	85	Circa Ganging Table
3513S	187	Enea Armless Bar-Height Stool	451-2500	78	Circa Straight Seat Chair
391	160	Switch Chair	451-3730FI	77	Circa 30° Inside Wedge Armless Seat
391-2	160	Switch Two-Seat	451-3730FO	76	Circa 30° Outside Wedge Seat
391-3	161	Switch Three-Seat	451-5000	78	Circa Straight Loveseat
391-4	161	Switch Two-Seat w/Extensions	451-7460FI	77	Circa 60° Inside Wedge Loveseat

Style Number Index

Style Number	Page	Description	Style Number	Page	Description
451-7460FO	77	Circa 60° Outside Wedge Loveseat	798	221	Chord High-Back Chair
451-A1800ER	80	Circa Straight Armrest	798-P	221	Chord High-Back Chair
451-A1800G	80	Circa Straight Armrest	798-PAU	221	Chord Midback Chair
451-A1815FIER	80	Circa 15° Inside Armrest	798AU	221	Chord Midback Chair
451-A1815FIG	80	Circa 15° Inside Armrest	9014S	178, 181, 183	Stacking Dolly
451-A1815FOER	81	Circa 15° Outside Armrest	BB48	60	Bix Bench
451-A1815FOG	81	Circa 15° Outside Armrest	BB72	60	Bix Bench
451-A3730FIER	81	Circa 30° Inside Armrest	BBS48	60	Bix Bench
451-A3730FIG	81	Circa 30° Inside Armrest	BBS72	60	Bix Bench
451-A3730FOER	81	Circa 30° Outside Armrest	BL26AA	52	Bix Lounge Chair with Arms
451-A3730FOG	81	Circa 30° Outside Armrest	BL26XX	52	Bix Lounge Chair
451-B42RD	81	Circa Round Ottoman	BLB26XX	52	Bix Lounge Chair with Screen
451-B5000	78	Circa Straight Bench	BLD26AA	53	Bix Sled Lounge with Arms
451-B7460FI	77	Circa 60° Inside Wedge Bench	BLD26TX	53	Bix Sled Lounge Tablet Arm
451-B7460FO	77	Circa 60° Outside Wedge Bench	BLD26XT	53	Bix Sled Lounge Tablet Arm
451-GANGPKG	78, 81	Circa Ganging Kit	BLD26XX	53	Bix Sled Lounge
46-T1	226	Await Freestanding Table	BP72TX	63	Bix Podium
46-T2	226	Await Freestanding Table	BP72XT	63	Bix Podium
460-3	47	Await Modular Three-Seat Lounge	BPP72TX	63	Bix Podium
460-4	47	Await Modular Four-Seat Lounge	BPP72XT	63	Bix Podium
460-4B	47	Await Modular Four-Seat Bench	BSC30LA	54	Bix Sectional Seating
460-GANGPKG	48	Ganging Kit	BSC30LB	55	Bix Sectional Seating
460-H	47	Await Modular Ottoman	BSC30RA	55	Bix Sectional Seating
460-SE22	49	Await Lounge Table	BSC30RB	55	Bix Sectional Seating
460-SE22PD	49	Await Lounge Table	BSCB30LA	55	Bix Sectional Seating
460-SE30	49	Await Lounge Table	BSCB30LB	55	Bix Sectional Seating
460-SE30PD	49	Await Lounge Table	BSCB30RA	55	Bix Sectional Seating
460-SE44	49	Await Lounge Table	BSCB30RB	55	Bix Sectional Seating
460-SE44PD	49	Await Lounge Table	BSE54LA	56	Bix Sectional Seating
461-1B	48	Await Connector Bench	BSE54LX	56	Bix Sectional Seating
461-2B	48	Await Connector Bench	BSE54RA	56	Bix Sectional Seating
461-3B	48	Await Connector Bench	BSE54RX	56	Bix Sectional Seating
470	88	Coupe Lounge Chair	BSEB54LA	56	Bix Sectional Seating
470-2	89	Coupe Two-Seat Lounge	BSEB54LX	56	Bix Sectional Seating
470-3	89	Coupe Three-Seat Lounge	BSEB54RA	56	Bix Sectional Seating
470-H	89	Coupe Ottoman	BSEB54RX	56	Bix Sectional Seating
473MAPLE	92	Coupe Wood Lounge Chair	BSS48AA	57	Bix Sectional Seating
473WALNUT	92	Coupe Wood Lounge Chair	BSS48AX	57	Bix Sectional Seating
476	90	Coupe Grande Chair	BSS48XA	57	Bix Sectional Seating
476-2	91	Coupe Grande Two-Seat Lounge	BSS48XX	57	Bix Sectional Seating
476-3	91	Coupe Grande Three-Seat Lounge	BSS72AA	58	Bix Sectional Seating
476M	91	Coupe Grande Chair	BSS72AX	58	Bix Sectional Seating
490-B35VRT	95	Little Ripple Wave Bench	BSS72XA	58	Bix Sectional Seating
490-B96HRZ	95	Ripple Flat Seat Bench	BSS72XX	58	Bix Sectional seating
490-B96VRT	95	Ripple Wave Bench	BSSB48AX	57	Bix Sectional Seating
70-C-TPM	242	Tree Bevel High-Embossed Wood	BSSB48XA	57	Bix Sectional Seating
70-D-TPM	242	Tree Bevel Medium-Embossed Wood	BSSB48XX	57	Bix Sectional Seating
795	220	Chord Conference Chair	BSSB72AX	58	Bix Sectional Seating
795AU	220	Chord Conference Chair	BSSB72XA	58	Bix Sectional Seating
796	221	Chord Midback Chair	BSSB72XX	58	Bix Sectional Seating
796-P	221	Chord Midback Chair	BTB2226	68-69	Bix Bridge Table
796-PAU	221	Chord Midback Chair	BTB2226U	68	Bix Bridge Table
796AU	221	Chord Midback Chair	BTB2626	69	Bix Bridge Table
797	221	Chord High Back Chair	BTB2626U	69	Bix Bridge Table
797AU	221	Chord Midback Chair	BTBS2226	69	Bix Bridge Table

Style Number Index *continued*

Style Number	Page	Description	Style Number	Page	Description
BTBS2226U	69	Bix Bridge Table	CO2493	248	Emu Heaven Round Table
BTBS2626	69	Bix Bridge Table	CO2493V	248	Emu Heaven Glass Top
BTBS2626U	69	Bix Bridge Table	CO2494	248	Emu Heaven Round Table
BTC20001	70, 228	Bix Occasional Table	CO2494V	248	Emu Heaven Glass Top
BTC24241	70, 228	Bix Occasional Table	CO2495	246	Emu Heaven Pouf
BTC24241U	70, 228	Bix Occasional Table	CO2495B	246	Emu Heaven Indoor Cushion
BTC24481	70, 228	Bix Occasional Table	CO2495C	246	Emu Heaven Outdoor Cushion
BTC24481U	70, 228	Bix Occasional Table	CO2495V	246	Emu Heaven Glass Top
BTC24721	70, 228	Bix Occasional Table	CO2496	248	Emu Heaven Side Table
BTC24721U	70, 228	Bix Occasional Table	CO2497	247	Emu Heaven High Vase
BTC28001	70, 228	Bix Occasional Table	CO2498	247	Emu Heaven Low Vase
BTC28001U	70, 228	Bix Occasional Table	CO2565MB	254	Emu Re-Trouvé Midback Chair
BTS1700	72, 227	Bix Side Table	CO2566B	255	Emu Re-Trouvé Indoor Cushion
BTW20003	71	Bix Work-Booth Table	CO2566C	255	Emu Re-Trouvé Outdoor Cushion
BTW28003	71	Bix Work-Booth Table	CO2566HB	254	Emu Re-Trouvé Highback Chair
BTW28003U	71	Bix Work-Booth Table	CO2575	254	Emu Re-Trouvé Pouf
BTW36483	71	Bix Work-Booth Table	CO2575B	254	Emu Re-Trouvé Indoor Cushion
BTW36483U	71	Bix Work-Booth Table	CO2575C	254	Emu Re-Trouvé Outdoor Cushion
BTW36723	71	Bix Work-Booth Table	CO2577	255	Emu Re-Trouvé High Vase Frame
BTW36723U	71	Bix Work-Booth Table	CO2578	255	Emu Re-Trouvé Low Vase Frame
CO200G	176	Bindu-Low Back Guest/Side Chair	CO2580	255	Emu Re-Trouvé Vase Insert
CO2465	256	Emu Round Chair	CO2585	250	Emu Ivy Arm Chair
CO2465B	257	Emu Round Stool Cushion	CO2585B	251	Emu Ivy Indoor Cushion
CO2465C	257	Emu Round Chair Cushion	CO2585C	251	Emu Ivy Outdoor Cushion
CO2466	256	Emu Round Arm Chair	CO2586	250	Emu Ivy Lounge
CO2467	256	Emu Round Stool	CO2586B	251	Emu Ivy Lounge Cushion
CO2467B	257	Emu Round Stool Cushion	CO2586C	251	Emu Ivy Lounge Cushion
CO2467C	257	Emu Round Stool Cushion	CO2589	252	Emu Ivy Rectangle Side Table
CO2469	256	Emu Round Lounge	CO2595	251	Emu Ivy Pouf
CO2469B	257	Emu Round Lounge Cushion	CO300	218	Bindu-Mid Back Executive Chair
CO2469C	257	Emu Round Lounge Cushion	CO300G	176	Bindu-Mid Back Guest/Side Chair
CO2470	258	Emu Round Table	CO400	218	Bindu Mid-Back High Back Executive Chair
CO2471	258	Emu Square Table	CODAV	114	Davos Chair
CO2472	258	Emu Square Table	CODAV16	114	Davos Small Bench
CO2473	258	Emu Square Table	CODAV38	114	Davos Medium Bench
CO2474	258	Emu Rectangle Table	CODAV60	114	Davos Large Bench
CO2475	258	Emu Counter Table	COEB2723H	240	Sebastopol 22" High Table
CO2477	258	Emu Side Table	COEB2723L	240	Sebastopol 16" High Table
CO2480B	245	Emu Heaven Chair Back Cushion	COEB4118H	240	Sebastopol 22" High Table
CO2480C	245	Emu Heaven Chair Back Cushion	COEB4118L	240	Sebastopol 16" High Table
CO2481B	245	Emu Heaven Arm Chair Back Cushion	COEL100	192	Enea Lottus Armless Chair
CO2481C	245	Emu Heaven Arm Chair Back Cushion	COEL100INSERT	192	Enea Lottus Armless Chair
CO2485	244	Emu Heaven Chair	COEL100UPH	192	Enea Lottus Armless Chair
CO2485B	245	Emu Heaven Indoor Cushion	COEL1830	235	Enea Lottus Occasional Table
CO2485C	245	Emu Heaven Outdoor Cushion	COEL1836	235	Enea Lottus Occasional Table
CO2486	244	Emu Heaven Arm Chair	COEL1842	235	Enea Lottus Occasional Table
CO2486B	245	Emu Heaven Indoor Cushion	COEL200	194	Enea Lottus Cantilever Arm Chair
CO2486C	245	Emu Heaven Outdoor Cushion	COEL200INSERT	194	Enea Lottus Cantilever Arm Chair
CO2487	244	Emu Heaven Lounge Chair	COEL200UPH	194	Enea Lottus Cantilever Arm Chair
CO2487B	245	Emu Heaven Lounge Cushion	COEL300	195	Enea Lottus Aluminum Loop Arm Chair
CO2487C	245	Emu Heaven Lounge Cushion	COEL300INSERT	195	Enea Lottus Aluminum Loop Arm Chair
CO2488B	246, 257	Emu Heaven Lounge Pillow	COEL300UPH	195	Enea Lottus Aluminum Loop Arm Chair
CO2488C	246, 257	Emu Heaven Lounge Pillow	COEL3030	236	Enea Lottus Conference Table
CO2489B	246	Emu Heaven Lounge Back Cushion	COEL303072	239	Enea Lottus Rectangular Table
CO2489C	246	Emu Heaven Lounge Back Cushion	COEL3036	236	Enea Lottus Conference Table

Style Number Index

Style Number	Page	Description	Style Number	Page	Description
COEL3042	236	Enea Lottus Conference Table	COLAGLL22	130	Lagunitas 2-Seat Lnge w/ LB Scrn, 1 Side Scrn
COEL3624	237	Enea Lottus Café Counter-Height Table	COLAGLL23	131	Lagunitas 2-Seat Lnge w/ LB Scrn, 2 Side Scrns
COEL3630	237	Enea Lottus Café Counter-Height Table	COLAGLL31	136	Lagunitas 3-Seat Lnge w/ Low-Bk Scrn
COEL363072	239	Enea Lottus Rectangular Table	COLAGLL32	137	Lagunitas 3-Seat Lnge w/ LB Scrn, 1 Side Scrn
COEL3636	237	Enea Lottus Café Counter-Height Table	COLAGLL33	138	Lagunitas 3-Seat Lnge w/ LB Scrn, 2 Side Scrns
COEL3642	237	Enea Lottus Café Counter-Height Table	COLMS25	202	Last Minute Stool
COEL400	197	Enea Lottus Sled-Base Stool	COLMS30	202	Last Minute Stool
COEL400INSERT	197	Enea Lottus Sled-Base Stool	COLX200	203	Lox Stool
COEL400UPH	197	Enea Lottus Sled-Base Stool	COLX210	203	Lox Stool
COEL4224	238	Enea Lottus Café Bar-Height Table	COMF1	123	Millbrae Ganging Kit
COEL4230	238	Enea Lottus Café Bar-Height Table	COMFL1	119	Millbrae Lounge
COEL423072	239	Enea Lottus Rectangular Table	COMFL2	120	Millbrae Lounge
COEL4236	238	Enea Lottus Café Bar-Height Table	COMFL3	121	Millbrae 3-Seat Lounge
COEL4242	238	Enea Lottus Café Bar-Height Table	COMFL4	122	Millbrae 4-Seat Lounge
COEL500	196	Enea Lottus Sled-Base Stool	COMFLA1	119	Millbrae Lounge
COEL500INSERT	196	Enea Lottus Sled-Base Stool	COMFLA2	120	Millbrae 2-Seat Lounge
COEL500UPH	196	Enea Lottus Sled-Base Stool	COMFLA3	121	Millbrae 3-Seat Lounge
COEL600	199	Enea Lottus Post-Base Stool	COMFLA4	122	Millbrae 4-Seat Lounge
COEL600INSERT	199	Enea Lottus Post-Base Stool	COMFLB1	123	Millbrae 1-Seat Bench
COEL600UPH	199	Enea Lottus Post-Base Stool	COMFLB2	123	Millbrae 2-Seat Bench
COEL700	198	Enea Lottus Post-Base Stool	COMFLB3	123	Millbrae 3-Seat Bench
COEL700INSERT	198	Enea Lottus Post-Base Stool	COMFLB4	123	Millbrae 4-Seat Bench
COEL700UPH	198	Enea Lottus Post-Base Stool	COMFLLA1	119	Millbrae Lounge
COELDOLLY	193	Enea Lottus Stacking Dolly	COMFLLA2	120	Millbrae 2-Seat Lounge
COJHB100	174	Visalia Lounge	COMFLLA3	121	Millbrae 3-Seat Lounge
COJHB200	174	Visalia Lounge	COMFLLA4	122	Millbrae 4-Seat Lounge
COJHBC100	174	Visalia Lounge	COMFLRA1	119	Millbrae Lounge
COJHBC200	174	Visalia Lounge	COMFLRA2	120	Millbrae 2-Seat Lounge
COJHL100	173	Visalia Lounge	COMFLRA3	121	Millbrae 3-Seat Lounge
COJHL200	173	Visalia Lounge	COMFLRA4	122	Millbrae 4-Seat Lounge
COJHL300	173	Visalia Lounge	COMLPRND	123	Millbrae Round Arm Bolster
COJHLC100	173	Visalia Lounge	COMLPSQR	123	Millbrae Square Arm Bolster
COJHLC200	173	Visalia Lounge	COMSL1	119	Millbrae Lounge
COJHLC300	173	Visalia Lounge	COMSL2	119	Millbrae 2-Seat
COLAGB1	151	Lagunitas 1-Seat Bench	COMSL3	119	Millbrae 3-Seat
COLAGB2	151	Lagunitas 2-Seat Bench	COSFZCH	209	Montara650 Chair
COLAGB3	151	Lagunitas 3-Seat Bench	COSFZLC	211	Montara650 Lounge
COLAGCH2	144	Lagunitas 2-Seat Chaise	COSFZRC	215	Montara650 Rocker
COLAGCH3	148	Lagunitas 3-Seat Chaise	COSFZST	212-213	Montara650 Stools
COLAGCI	153	Alignment Connector	COTO12369L15	167	Together Bench
COLAGCL2	143	Lagunitas 2-Seat Chaise	COTO12369L8	167	Together Bench
COLAGCL3	147	Lagunitas 3-Seat Chaise	COTO12369R15	169	Together Bench
COLAGFN	155	Lagunitas Focus Nook	COTO12369R8	168	Together Bench
COLAGLBS	152	Lounge Booth Screen	COTO12396L15	167	Together Bench
COLAGLH11	127	Lagunitas 1-Seat Lnge w/ High-Bk Scrn	COTO12396L8	167	Together Bench
COLAGLH13	127	Lagunitas 1-Seat Lnge w/ HB Scrn, 2 Side Scrns	COTO12396R15	169	Together Bench
COLAGLH21	131	Lagunitas 2-Seat Lnge w/ High-Bk Scrn	COTO12396R8	168	Together Bench
COLAGLH22	132	Lagunitas 2-Seat Lnge w/ HB Scrn, 1 Side Scrn	COTO69	171	Together Bench
COLAGLH23	133	Lagunitas 2-Seat Lnge w/ HB Scrn, 2 Side Scrns	COTO69WB15	170	Together Bench
COLAGLH31	139	Lagunitas 3-Seat Lnge w/ High-Bk Scrn	COTO69WB8	170	Together Bench
COLAGLH32	140	Lagunitas 3-Seat Lnge w/ HB Scrn, 1 Side Scrn	COTO96	171	Together Bench
COLAGLH33	141	Lagunitas 3-Seat Lnge w/ HB Scrn, 2 Side Scrns	COTO9669L15	167	Together Bench
COLAGLL11	126	Lagunitas 1-Seat Lnge w/ Low-Bk Scrn	COTO9669L8	166	Together Bench
COLAGLL13	126	Lagunitas 1-Seat Lnge w/ LB Scrn, 2 Side Scrns	COTO9669R15	169	Together Bench
COLAGLL21	130	Lagunitas 2-Seat Lnge w/ Low-Bk Scrn	COTO9669R8	168	Together Bench

Style Number Index *continued*

Style Number	Page	Description	Style Number	Page	Description
COTO9696L15	167	Together Bench	H35-T4230L	230	Enea Table Single Base
COTO9696L8	166	Together Bench	H35-T4230W	230	Enea Table Single Base
COTO9696R15	169	Together Bench	H35-T4236L	231	Enea Table Single Base
COTO9696R8	168	Together Bench	H35-T4236W	231	Enea Table Single Base
COTO96WB15	170	Together Bench	H350-S19	191	Enea Café Low Stool
COTO96WB8	170	Together Bench	H350-S27	191	Enea Café Counter-Height Stool
COURQL	117	Hosu Lounge w/Attached Lumbar	H350-S31	191	Enea Café Bar-Height Stool
COURQLO	117	Hosu Lounge w/Otto and Attached Lumbar	H350-SB2719	189	Enea Café Stool with Back
COURQS	117	Hosu 2-Seat Lounge	H350-SB3119	189	Enea Café Stool with Back
COW210	163	SW_1 Ottoman	H351-SB2719	189	Enea Café Stool with Back
COW413	222	SW_1 Conference Chair	H351-SB3119	189	Enea Café Stool with Back
COW415	222	SW_1 Conference Chair	H352-S19	190	Enea Café Low Stool
COW613	163	SW_1 Low-Back Collaborative Lounge Chair	H352-S27	190	Enea Café Counter-Height Stool
COW713	163	SW_1 High-Back Collaborative Lounge Chair	H352-S31	190	Enea Café Bar-Height Stool
COWK100	93	Joel Lounge	H352-SB2719	189	Enea Café Stool with Back
COWRP4LEG	216	Wrapp Chair, 4 Leg	H352-SB3119	189	Enea Café Stool with Back
COWRPSLD	216	Wrapp Chair, Sled-Base	H353-S19	191	Enea Café Low Stool
H35-T2436L	231	Enea Table Single Base	H353-S27	191	Enea Café Counter-Height Stool
H35-T2436W	231	Enea Table Single Base	H353-S31	191	Enea Café Bar-Height Stool
H35-T2442L	231	Enea Table Single Base	H353-SB2719	189	Enea Café Stool with Back
H35-T2442W	231	Enea Table Single Base	H353-SB3119	189	Enea Café Stool with Back
H35-T3030L	230	Enea Table Single Base	PL2431	110	Topo Lounge
H35-T3030W	230	Enea Table Single Base	PLJ2417	110	Topo Lounge
H35-T3036L	231	Enea Table Single Base	PLM2431	111	Topo Mobile
H35-T3036W	231	Enea Table Single Base	PLMJ2417	111	Topo Mobile Jr.
H35-T3042L	231	Enea Table Single Base			
H35-T3042W	231	Enea Table Single Base			
H35-T307230GL	232	Enea Table Twin Base			
H35-T307230GW	232	Enea Table Twin Base			
H35-T307230KL	233	Enea Table Twin Base			
H35-T307230KW	233	Enea Table Twin Base			
H35-T307230VL	233	Enea Table Twin Base			
H35-T307230VW	233	Enea Table Twin Base			
H35-T307236GL	232	Enea Table Twin Base			
H35-T307236GW	232	Enea Table Twin Base			
H35-T307236KL	233	Enea Table Twin Base			
H35-T307236KW	233	Enea Table Twin Base			
H35-T307236VL	233	Enea Table Twin Base			
H35-T307236VW	233	Enea Table Twin Base			
H35-T307242GL	232	Enea Table Twin Base			
H35-T307242GW	232	Enea Table Twin Base			
H35-T307242KL	233	Enea Table Twin Base			
H35-T307242KW	233	Enea Table Twin Base			
H35-T307242VL	233	Enea Table Twin Base			
H35-T307242VW	233	Enea Table Twin Base			
H35-T3618L	230	Enea Table Single Base			
H35-T3618W	230	Enea Table Single Base			
H35-T3630L	230	Enea Table Single Base			
H35-T3630W	230	Enea Table Single Base			
H35-T3636L	231	Enea Table Single Base			
H35-T3636W	231	Enea Table Single Base			
H35-T3642L	231	Enea Table Single Base			
H35-T3642W	231	Enea Table Single Base			
H35-T4218L	230	Enea Table Single Base			
H35-T4218W	230	Enea Table Single Base			

Style Number Index

Trademark List

- The following are registered trademarks for products of Steelcase Inc. or one of its related corporate entities: 4 o'clock, 900 Series, à la carte, Airtouch, Ally, Amia, Answer, Archipelago, Avenir, Ballet, Bix, Brayton International, Cachet, Canopy, Canto, Chancellor, Coalesse, Confidante, Context, Convene, CopyCam, Criterion, Crushed Can, Currency, dash, Designtex, Details, Detour, Drive, Elective Elements, Ellipse, Ember Chrome, Emerge, E-Table 2, FYI, Garland, Gentry, Ginkgo Biloba, Groupwork, Ideo, Jacket, Jenny, Jersey, Kart, Kick, LaCosta, Leap, Let's B, LiveBack, Max-Stacker, media:scape, Metro, Migrations, Mitra, Montage, Nurture, Oriana, Parade, Pathways, PCT, Permiso, Player, Portal, Power Pincher, Progeny, Protégé, R2, Rally, Relevant, Reply, Rizzi Arc, Sensor, Series 9000, Siento, Sieste, Sine, Softcare, Springboard, Steelcase, Steelcase Design Partnership, Stella, Stow Davis, Swathmore, Sylvi, TeamWork, Technique, Texpress, Think, Thunder, Topo, Train, turnstone, Underline, Unison, Vecta, Viridian, Walden, Wernld, and X-Stack.
- The following registered trademarks are under license from AWI Licensing Company, Dover, DE: SoundScapes, DuraBrite, BioBlock, and Armstrong.
- The following registered trademarks are under license from Byrne Electrical, Rockford, MI: Interport, Mini-Port, Axil Z, and Ellora.
- The following is a registered trademark of DuPont, Wilmington, DE: Corian.
- The following is a registered trademark of Genlyte Thomas Company, Louisville, KY: Lightolier.
- The following is a registered trademark of Hilti Corporation, FL-9494 Schaan, Principality of Liechtenstein: Hilti.
- The following is a registered trademark of Leviton Manufacturing Company, Little Neck, NY: Decora.
- The following is a registered trademark of Mechanical Plastics Corp, Elmsford, NY: Toggler.
- The following is a registered trademark of Microsoft Corporation, Redmond, WA: Microsoft.
- The following is a registered trademark of Panduit Corporation, Lockport, IL: Panduit.
- The following is a registered trademark of Trav (Press), Cuneo, Italy: Assisa.
- The following is a registered trademark of Virtual Ink, Boston, MA: mimioActive.
- The following registered trademarks are under license from Wilkhahn Furniture Products: Avera, Senzo, Versal, and Wilkhahn FS.

- The following is a registered trademark of Wilsonart International, Temple, TX: Chemsurf.
- The following is a registered trademark of Wiremold, West Hartford, CT: Wiremold.
- The following is a registered trademark of EMU Group S.P.A., Perugia, Italy: Emu.
- The following is a registered trademark of Security People, Inc.: Digilock.
- The following are trademarks for products of Steelcase Inc. or one of its related corporate entities: Access, Active/Passive Shelf, Ainsley, Akira, Alcove, Alerion, Alight, Amaris, American Elect, American Tradition, ap40, Arbor, Arriva, Asana, Ascot, Aspekt, Astor, Await, Bassline, B-Free, Bira, Bivi, Bixby, Bottomline, Brody, Brook, Buoy, Burton, c:scape, Calla, Calm, Camber, Campfire, Capa, Cappuccino, Cesar, Chester, Chord, Circa, Clarendon, Classic Rectangular, Clipper, cobì, Collaboration, Community, Company, Convey, Cortex, Coupe, Crea, Crew, Cura, Cypress, Davenport, Dearborn, Deck, Déjà, Denizen, Denska, Derby, Divisio, Donovan, Dune, Duo, Echo, Edge, Elsna, Empath, Empress, Enea, ēno, EnSync, Enviro, Escapade, Exchange, Exponents, Field, Flat Top, FlexFrame, Flip Top, Flute, Folio, FrameOne, FreeFlow, Frontier, Galliei, Gesture, Ginger, Ginkgo, Go Wall, Grip, Groove, Hatchback, Hawthorne, Hitch, Host Collection, Hosu, Huddleboard, i2i, Impact, Indy, InfoLink, IOS, I-Solve, Jack, Jarrah, Jetty, Juice, Kami, Kast, Kathryn, Lagunitas, Lark, L'Attitude, LearnLab, Leela, LessThanFive, Lincoln, Linden, LiveSeat, Loria, Lyric, Malibu, Malibu Too, Mansfield, Marathon, Martini, Mason, Masque, Migration, Millbrae, Mineral, Mingle, Mystic, Mystic Metal, Mystic Wood, Montara650, Montreal, Move, Nadia, Neighbor, nesso, Nickel, Nikko, Nod, Node, Norfolk, Ology, Ontrak, Oom, Opus, Orchid, Outlook Collection, Ovation, Paloma, Paperflo, Parliament, Pasio, Passerelle, Patriarch, Payback, Peek, Pile File, Pisa, Pool, Potrero415, PUCK, QiVi, Quba, Rave, Reed, Regard, Relay, Reunion, Ripple, Riser, Roam, Rocco, Rocky, RoomWizard, Runner, Satellite, Sawyer, ScapeSeries, Senti, Sentinel, Senza, Sequoia, Session, ShareLink, Shield, Shortcut, Sidewalk, SILQ, Skylar, Slumber, Smoke, Snug, Soft Leaf, Sonata, Sorrel, SOTO, Southside, Stationkits, Steelcase Series, Stiletto, Surprise!, Surround, Switch, Symphony, Sync, TagWizard, Tava, TeamStudio, TeamTheater, Tenaro, Terrazzo, Theorem, Thread, Topaz, Touchdown, Tour, Tower Too, Trees, Trillium, Trolley, tX2, U-Free, Umami, Underscore, Uno, V.I.A., Verb, Verge, Verlay, Victor2, Visalia, Waldorf, Woodruff, Workspring, and X-tenz.
- The following is a trademark of Microsoft Corporation, Redmond, WA: Windows.
- The following is a trademark of Rodman Industries, Inc., Oconomowoc, WI: ResinCore1.
- The following is a trademark of Ultrafabrics, LLC, Elmsford, NY: Ultraleather.

- The following trademarks are under license from Wilkhahn Furniture products: Cana, Linus, Logon, Picto, Range, Stitz, Thema, Timetable, and Tubis.
 - The following trademark is used under license from Cradle to Cradle Products Innovation Institute, Oakland, CA: Cradle to Cradle Certified.
 - The following trademarks are under license from Walter Knoll: Andoo, Bob, Lazlo, Lox, Ribbon, and Together.
 - The following trademarks are under license from PP Möbler: Bar and Flag Halyard.
 - The following trademarks are under license from Viccarbe: Davos, Holy Day, Last Minute, RS, Sistema, and Wrapp.
 - The following trademarks are under license from Carl Hansen: Elbow, Paddle, Shell, Wing, and Wishbone.
 - The following trademarks are under license from Cambridge Sound Management, LLC, Cambridge, MA: QtPro Soundmasking, Qt Quiet Technology, and Sonet Qt.
 - The following is a trademark of Electri-Cable Assemblies, Shelton, CT: Interact.
 - The following is a trademark of Clestra Hauserman: IRYS.
 - The following is a trademark of Wiesner-Hager Möbel GmbH: Nooi.
 - The following are trademarks of PolyVision: a³, e³, Flow, Motif, PolyVision, Sans, and Serif.
 - The following is a trademark of Bostock Company, Inc: SnapCab.
 - The following is a trademark of Williams-Sonoma, Inc: West Elm.
 - The following is a trademark of Elena Marquina Testor: nanimarquina.
 - The following is a trademark of Forbo International SA: Forbo.
- Trademarks used here in are the property of Steelcase, Inc. or of their respective owners.*