Wood Casegoods, Elective Elements, and FlexFrame

Volume 3

Terms and Conditions	2
Sample Order Form	10
Participating Steelcase Dealers	12
Steelcase Showrooms and Manufacturing Locations	17

Steelcase Wood Furniture	
Walden (SIN 711.8)	19
Convene (SIN 711.11)	71
Verlay (SIN 711.11)	135
Surface Materials	153
Elective Elements (SIN 711.2)	169
Surface Materials	565
FlexFrame (SIN 711.1)	579
Surface Materials	607
Victor2 (SIN 711.3)	615

Resources	621
------------------	------------

► For a list of all trademarks, refer to the last page of this specification guide.

Terms and Conditions

Customer Information

For more information, please contact your participating Steelcase GSA dealer.

For more information, please contact your participating Steelcase GSA dealer.

For more information, please contact your participating Steelcase GSA dealer.

For more information, please contact your participating Steelcase GSA dealer.

For more information, please contact your participating Steelcase GSA dealer.

For more information, please contact your participating Steelcase GSA dealer.

For more information, please contact your participating Steelcase GSA dealer.

For more information, please contact your participating Steelcase GSA dealer.

Sample Order Form

Sample Order Form

ORDER FOR SUPPLIES OR SERVICES			PAGE	OF	PAGES
IMPORTANT: Mark all packages and papers with contract and/or order numbers.					
DATE OF ORDER 1 6-1-04	CONTRACT NO. (If any) 2 GS-27F-0014V	ORDER NO. 3 10 - 000	REQUISITION/REFERENCE NO.		
ISSUING OFFICE (Address correspondence to) 4 GSA 1 Town Street City, State, Zip Name and Telephone Number		SHIP TO: (Consignee and address, ZIP Code) 5 GSA 2 Town Street City, State, Zip Name and Telephone Number			
TO: CONTRACTOR (Name, address and ZIP Code) 6 Steelcase Inc. c/o Participating Dealer 901 44th Street, SE Grand Rapids, MI 49508 Attn: Solutions Fullfillment Team CH-2W-SS (GSA)		Cage Code: 39880		TYPE OF ORDER <input type="checkbox"/> A. PURCHASE — Reference your _____ Please furnish the following on the terms and conditions specified on both sides of this order and on the attached sheets, if any, including delivery as indicated. This purchase is negotiated under authority of: <input type="checkbox"/> B. DELIVERY — Except for billing instructions on the reverse, this delivery order is subject to instructions contained on this side only of this form and is issued subject to the terms and conditions of the above-numbered contract.	
ACCOUNTING AND APPROPRIATION DATA			REQUISITIONING OFFICE		
			BUSINESS CLASSIFICATION (Check appropriate box(es)) 20 <input type="checkbox"/> SMALL <input checked="" type="checkbox"/> OTHER THAN SMALL <input type="checkbox"/> DIS-ADVANTAGED <input type="checkbox"/> WOMEN-OWNED		
FCA DESTINATION 7		GOVERNMENT NO.	DELIVER TO FCA DESTINATION ON OR BEFORE (Date) 8 ARO date	DISCOUNT TERMS 9 Net 30 days	
PLACE OF INSPECTION AND ACCEPTANCE					

(See reverse for Rejections)

ITEM NO. (A)	SUPPLIES OR SERVICES (B)	QUANTITY ORDERED (C)	UNIT (D)	UNIT PRICE (E)	AMOUNT (F)	QUANTITY ACCEPTED (G)	
1	10 One lot of Steelcase Office Furniture: See attached specifications	13 1		14 \$000	15 \$000		
2	11 Design: \$55.41/hour	2	hrs	\$000	\$000		
3	12 Installation	1		\$000	\$000		
SEE BILLING INSTRUCTIONS ON REVERSE		SHIPPING POINT		GROSS SHIPPING WEIGHT		INVOICE NO.	
		MAIL INVOICE TO: (Include ZIP Code) 17 GSA, 3 Town Street, City, State, Zip				16 \$000	(H) TOT. (Cont. pages) ◀ (I) GRAND TOTAL ◀

UNITED STATES OF AMERICA BY (Signature) 18 Contracting Officer signature and telephone no.	NAME (Typed) 19 John Doe, Department Manager TITLE: CONTRACTING/ORDERING OFFICER
--	---

NSN 7540_01_152_8083

50347-101

OPTIONAL FORM 347 (10-83)
Prescribed by GSA
FAR (48 CFR) 53.213 (e)

- 1 Order date
- 2 Contract number
- 3 Order number
- 4 Issuing office: Requester name and telephone number
- 5 Shipping address: Contact name and telephone number
- 6 Contractor:
Steelcase Inc.
c/o Participating Dealer
901 - 44th Street, S.E.
Grand Rapids, MI 49508
Attn: Solutions Fulfillment Team
- 7 FCA destination
- 8 ARO date (After Receipt of Order)
- 9 Terms: Net 30 days
- 10 Complete product description, including SIN number, style number, all applicable surface materials.
- 11 Separate line for design
- 12 Separate line for installation
- 13 Quantity ordered
- 14 Individual unit price
- 15 Amount (quantity x unit price)
- 16 Total cost
- 17 Invoice address
- 18 Authorized contracting officer signature and telephone number
- 19 Authorized contracting officer name and title (typed)
- 20 Steelcase is the seller of record and is not registered as "small," "disadvantaged," or "woman-owned." If one of these boxes is checked in error, a modification will be required.

Please note on order that all invoice payments must be sent to:

Steelcase Inc.
62087 Collection Center Dr.
Chicago, IL 60693-0620

Storage and Delays

(Open Market) In the event that the site is not accessible, or safe and adequate storage space is not available during installation, the furnishings will be stored until delivery or installation can be accomplished. Pricing for storage will be negotiated on a project-by-project basis. Invoices will be sent to the local government purchasing facility upon delivery of the furniture to a designated storage facility. Steelcase shall provide notice to the Government purchasing facility that the furnishings are available for inspection by the Government at the Storage facility. Upon this notice, the Government, or representative for the Government, must inspect and accept the furniture prior to payment of any invoice. The inspection and acceptance must be completed within reasonable time frame agreed upon by both parties. Payment will be made by the Government 30 days after acceptance of the furniture.

Participating Steelcase Dealers

Alabama

Dekalb Office of Alabama
2901 Second Ave South
Birmingham, AL 35233
Phone: (205) 933-9100

Kyser OfficeWorks Inc.
2400 Spruce Street
Montgomery, AL 36107-3150
Phone: (334) 834-9400
Fax: (334) 262-0701

OEC Business Interiors
104 East I-65 Service Road North
Mobile, AL 36607-2501
Phone: (251) 471-3368
Fax: (251) 471-0019

Office Interiors by OSCO
1300 Meridian Street
Suite 203
Huntsville, AL 35801
Phone: (256) 604-5696
Fax: (256) 604-5699

OSCO Inc.
229 Grant Street SE
Decatur, AL 35601-2511
Phone: (256) 340-5100
Fax: (256) 340-5108

Alaska

Capital Office Systems
1120 East 35th Avenue
Anchorage, AK 99508-4257
Phone: (907) 777-1500
Fax: (907) 777-1515

Capital Office Systems
3201 Industrial Avenue
Fairbanks, AK 99701-7370
Phone: (907) 456-3946
Fax: (907) 452-6257

Capital Office Systems
3143 Channel Drive
Juneau, AK 99801-7214
Phone: (907) 780-3636
Fax: (907) 780-2290

Arizona

Atmosphere Commercial Interiors
815 North Central Avenue
Phoenix, AZ 85004
Phone: (602) 252-6971

Atmosphere Commercial Interiors
Suite 100
88 East Broadway Boulevard
Tucson, Arizona 85701-1720
Phone: (520) 792-4200

Atmosphere Commercial Interiors
Suite 100
88 East Broadway Boulevard
Tucson, Arizona 85701-1720
Phone: (520) 792-4200
Fax: (540) 791-9568

Arkansas

ImageWorks
Suite B
1424 North Shackleford
Little Rock, AR 72211
Phone: (501) 944-7501

Today's Office Inc.
717 West 7th Street
Little Rock, AR 72201-4044
Phone: (501) 375-5050
Fax: (501) 375-1350

Today's Office Inc.
3157 West Sunset Avenue
Springdale, AR 72762-4945
Phone: (479) 751-5861
Fax: (479) 756-2233

California

BKM Office Environments
816 Via Alondra
Camarillo, CA 93012
Phone: (877) 256-1256
Fax: (805) 339-9032

BKM San Diego
Suite 100
9201 Spectrum Center Blvd.
San Diego, CA 92123-1407
Phone: (858) 569-4700
Fax: (858) 277-8931

One Workplace L. Ferrari
2500 De La Cruz Blvd.
Santa Clara, CA 95050
Phone: (669) 800-2500
Fax: (669) 800-2501

One Workplace L. Ferrari
7220 Edgewater Drive
Oakland, CA 94621
Phone: (510) 729-7800
Fax: (510) 729-7801

One Workplace L. Ferrari
475 Brannan Street
San Francisco, CA 94107-1731
Phone: (415) 357-2200
Fax: (415) 357-2201

Peninsula Business Interiors
325 Main Street
Salinas, CA 93901-2705
Phone: (831) 757-4107
Fax: (831) 757-1339

Tangram Interiors
Suite 102
4057 W Shaw Ave
Fresno, CA 93722-6212
Phone: (559) 275-7070
Fax: (559) 275-7080

Tangram Interiors
Suite 100
2850 South Red Hill Avenue
Santa Ana, CA 92705-5532
Phone: (949) 955-6700
Fax: (949) 955-6799

Tangram Interiors
9200 Sorensen Avenue
Santa Fe Springs, CA 90670-2645
Phone: (562) 365-5000
Fax: (562) 365-5399

United Corporate Furnishings
1780 North Market Blvd.
Sacramento, CA 95834-1997
Phone: (916) 553-5900
Fax: (916) 553-5800

Colorado

Office Outfitters & Planners Inc.
749 Main Street
Grand Junction, CO 81501-3535
Phone: (970) 245-6300
Fax: (970) 245-6301

OfficeScapes
2506 Zeppelin Rd
Colorado Springs, CO 80916
Phone: (719) 574-1113
Fax: (719) 574-1133

OfficeScapes
9900 East 51st Avenue
Denver, CO 80238-2430
Phone: (303) 574-1115
Fax: (303) 574-1116

OfficeScapes
Suite 180
4812 McMurry Avenue
Fort Collins, CO 80525-6222
Phone: (970) 223-5959
Fax: (970) 223-5858

Connecticut

Red Thread
300 East River Drive
East Hartford, CT 06108-4205
Phone: (860) 528-9981
Fax: (860) 528-1843

Red Thread
488 Wheelers Farm Rd.
Milford, CT 06461
Phone: (203) 874-7754
Fax: (203) 876-7915

Red Thread
700 Canal St 3rd Fl
Stamford, CT 06902
Phone: (860) 528-9981

Red Thread
40 Main Street
Torrington, CT 06790
Phone: (860) 482-2679
Fax: (860) 482-3590

Delaware

Corporate Interiors Inc.
223 Lisa Drive
New Castle, DE 19720-4193
Phone: (302) 323-9100
Fax: (302) 323-9251

Florida

American Business Interiors
215 Waverly Place
Melbourne, FL 32901-5444
Phone: (321) 723-5003
Fax: (321) 984-4221

Empire Office
Suite 140
2 Oakwood Boulevard
Hollywood, FL 33020
Phone: (954) 707-6200

Empire Office
South Florida
3201 Commerce Parkway
Miramar, FL 33025-3908
Phone: (954) 435-7300
Fax: (954) 435-7212

Empire Office
Suite 17
2315 Lynx Lane
Orlando, FL 32804
Phone: (407) 628-2400

Empire Office
5112 West Linebaugh Avenue
Tampa, FL 33624
Phone: (813) 418-3300

Empire Office
Suite 2
7830 Byron Drive
West Palm Beach, FL 33404-3332
Phone: (561) 840-8600
Fax: (561) 840-1873

Leitz & Reed Office Products
1119 Florida Avenue
Lynn Haven, FL 32444-4622
Phone: (850) 271-2600
Fax: (850) 271-0076

OEC Business Interiors
1601 NW 80th Boulevard
Gainesville, FL 32606-9140
Phone: (352) 332-1192
Fax: (352) 333-8002

· OEC Business Interiors
· 2393 SW College Road
· Ocala, FL 34474-1661
· Phone: (352) 620-2888
· Fax: (352) 620-2891

· OEC Business Interiors
· 6254 North W Street
· Pensacola, FL 32503-2746
· Phone: (850) 438-1100
· Fax: (850) 432-0003

· Office Furniture & Design Concepts
· 11866 Metro Parkway
· Ft. Myers, FL 33966-1307
· Phone: (239) 337-1212
· Fax: (239) 337-4910

· Perdue Office Interiors
· Suite 100
· 5 W Forsyth
· Jacksonville, FL 32256-7440
· Phone: (904) 737-5858
· Fax: (904) 737-6088

· Perdue Office Interiors
· Suite C7
· 1516 Capital Circle SE
· Tallahassee, FL 32301
· Phone: (850) 383-4225

Georgia

· Advent Business Interiors
· 1318 U.S. HWY 82 West
· Leesburg, GA 31721
· Phone: (229) 439-7418
· Fax: (229) 435-1279

· Advent Business Interiors
· 110 West Macon Park Dr.
· Macon, GA 31210
· Phone: (478) 471-0600

· DeKalb Office Environments
· 1320 Ridgeland Parkway
· Alpharetta, GA 30004-8442
· Phone: (770) 360-0200
· Fax: (770) 360-0305

· McWaters Inc.
· 3708 Benchmark Drive
· Augusta, GA 30907
· Phone: (706) 396-5400
· Fax: (706) 396-5401

· McWaters Inc.
· 117 Prosperity Drive
· Savannah, GA 31408-9551
· Phone: (912) 352-9000
· Fax: (912) 352-2034

Hawaii

· Interior Showplace Ltd.
· 956 Queen Street
· Honolulu, HI 96814-4118
· Phone: (808) 593-8420
· Fax: (808) 591-8324

Idaho

· Porter's Office Products
· 435 West Center Street
· Pocatello, ID 83204-3241
· Phone: (208) 232-1233
· Fax: (208) 232-8759

· Porter's Office Products
· 1050 North 2nd East
· Rexburg, ID 83440-5127
· Phone: (208) 356-4616
· Fax: (208) 356-8901

· Office Environment Company
· 623 South Americana Blvd.
· Boise, ID 83702-5120
· Phone: (208) 385-0507
· Fax: (208) 385-9392

Illinois

· A. Pomerantz
· Suite 940
· 222 Merchandise Mart Plaza
· Chicago, IL 60654-1223
· Phone: (312) 929-3335
· Fax: (312) 929-3311

· Atmosphere Commercial Interiors
· 801 North Perryville Road
· Rockford, IL 61107
· Phone: (815) 398-3300

· Egyptian Business Furniture
· 129 West Main Street
· Belleville, IL 62220-1501
· Phone: (618) 234-2323
· Fax: (618) 236-3295

· Interiors for Business Inc.
· 409 N River Street
· Batavia, IL 60510-2359
· Phone: (630) 761-1070
· Fax: (630) 761-1065

· Lincoln Office
· 205 Eastgate Drive
· Washington, IL 61571-9238
· Phone: (309) 427-2500
· Fax: (309) 427-2625

· Forward Space
· Suite 614
· 222 Merchandise Mart Plaza
· Chicago, IL 60654-1223
· Phone: (312) 563-5206

· Forward Space
· 1142 N North Branch Street
· Chicago, IL 60642
· Phone: (312) 942-1100
· Fax: (312) 942-9840

· Forward Space
· 13820 West Business Center Drive
· Lake Forest, IL 60045-1181
· Phone: (847) 573-8890
· Fax: (847) 573-8891

· Forward Space
· Suite 150
· 1111 West 22nd Street
· Oak Brook, IL 60523
· Phone: (312) 563-5206

Indiana

· Business Furnishings LLC
· 4102 Meghan Beeler Court
· South Bend, IN 46628
· Phone: (574) 243-3255
· Fax: (574) 243-3266

· Business Furniture LLC
· 6102 Victory Way
· Indianapolis, IN 46278-2934
· Phone: (317) 216-1600
· Fax: (317) 216-1601

· Corporate Design Inc.
· Suite 400
· 1419 West Lloyd Expressway
· Evansville, IN 47710-1002
· Phone: (812) 422-3000
· Fax: (812) 422-3413

· Lincoln Office
· 1200 Arrowhead Court
· Crown Point, IN 46307-8222
· Phone: (219) 662-2777
· Fax: (219) 662-7770

Iowa

· Lincoln Office
· 1026 Mound St
· Davenport, IA 52803
· Phone: (563) 322-5660

· Tallgrass Business Resources
· Highway 6 West
· 218 Second Street
· Coralville, IA 52241-2608
· Phone: (319) 338-3135
· Fax: (319) 338-7484

· Workspace Inc.
· 309 Locust Street
· Des Moines, IA 50309-1788
· Phone: (515) 288-7090
· Fax: (515) 288-0250

Kansas

· Design Central Inc.
· 152 South 5th Street
· Salina, KS 67401
· Phone: (785) 825-4131
· Fax: (785) 825-4778

· Scott Rice Office Interiors
· 224 East Douglas
· Wichita, KS 67211-1640
· Phone: (316) 269-2700
· Fax: (316) 269-3527

· Scott Rice Office Works
· 14720 West 105th Street
· Lenexa, KS 66215-4414
· Phone: (913) 888-7600
· Fax: (913) 227-7793

Kentucky

· Office Resources Inc.
· 530 Corvette Drive
· Bowling Green, KY 42101-7132
· Phone: (270) 781-5858
· Fax: (270) 781-5884

· Office Resources Inc.
· 101 Bradley Drive
· Nicholasville, KY 40356-9121
· Phone: (859) 885-6161
· Fax: (859) 885-9610

· Office Resources Inc.
· 816 East Broadway
· Louisville, KY 40204-1053
· Phone: (502) 589-8400
· Fax: (502) 589-8408

Louisiana

· Frost-Barber Inc.
· 9322 Interline Avenue
· Baton Rouge, LA 70809-1966
· Phone: (225) 926-5000
· Fax: (225) 926-5011

· Workplace Solutions
· 401 St. Joseph Street
· New Orleans, LA 70130
· Phone: (504) 522-9558
· Fax: (504) 522-7070

Maine

· Red Thread
· One City Center
· Portland, ME 04101
· Phone: (207) 774-4900
· Fax: (207) 774-8155

Maryland

· Arbee Associates
· 6311 Ammendale Road
· Beltsville, MD 20705-1249
· Phone: (410) 385-5180
· Fax: (410) 385-5199

· Arbee Associates
· 9300 Gaither Road
· Gaithersburg, MD 20877
· Phone: (301) 963-3900
· Fax: (301) 977-1734

· Dancker, Sellow & Douglas Inc.
· Suite 309
· 509 Exeter Street
· Baltimore, MD 21202
· Phone: (301) 671-2541
· Fax: (301) 797-1504

Participating Steelcase Dealers, continued

Dancker, Sellaw & Douglas Inc.
9200 Alaking Court
Suite 100
Capitol Heights, MD 20743
Phone: (301) 350-8700
Fax: (301) 350-9393

Massachusetts

Red Thread
Suite 600
101 Seaport Blvd.
Boston, MA 02210-1838
Phone: (617) 439-4900
Fax: (617) 439-4131

Red Thread
Suite 150
293 Boston Post Road West
Marlborough, MA 01752-4615
Phone: (508) 449-6550
Fax: (508) 449-6570

Red Thread
Suite 1108
1350 Main Street
Springfield, MA 01103
Phone: (413) 736-1802

Red Thread
100 Fordham Road
Wilmington, MA 01887
Phone: (978) 658-3900
Fax: (978) 694-4107

Michigan

Custer Office Environments Inc.
2435 Plaza Drive
Benton Harbor, MI 49022-2229
Phone: (616) 926-8719
Fax: (616) 926-9482

Custer Office Environments Inc.
217 Grandville Ave SW
Grand Rapids, MI 49503-4013
Phone: (616) 458-6322
Fax: (616) 458-1117

Custer Office Environments Inc.
5737 East Cork Street
Kalamazoo, MI 49048-9668
Phone: (269) 342-3919
Fax: (269) 342-3923

Custer Office Environments
442 East Michigan
Marquette, MI 49885
Phone: (906) 226-1161
Fax: (906) 226-1164

Custer Office Environments
120 East Front Street
Traverse City, MI 49684
Phone: (616) 402-8489

NBS
701 Salzburg Avenue
Bay City, MI 48706-5390
Phone: (989) 895-8574
Fax: (989) 895-8545

NBS
5133 West Grand River Avenue
Lansing, MI 48906-9117
Phone: (517) 886-0072
Fax: (517) 886-0014

NBS
2595 Bellingham Drive
Troy, MI 48083-2036
Phone: (248) 823-5400
Fax: (248) 823-5401

Minnesota

Atmosphere Commercial Interiors
Suite 350
81 South 9th Street
Minneapolis, MN 55402-3226
Phone: (612) 343-0868
Fax: (612) 332-5733

Burgher Office Equipment Company
101 East Chestnut Street
Virginia, MN 55792-2512
Phone: (218) 749-2661
Fax: (218) 749-2662

Duluth Typewriter & Business Furniture
30 N 3rd. Ave W
Duluth, MN 55802-1607
Phone: (218) 722-5811
Fax: (218) 722-4876

General Office Products Company
4521 Highway 7
Minneapolis, MN 55416-4098
Phone: (952) 925-7500
Fax: (952) 925-7531

Mississippi

Workplace Solutions
251 West South Street
Jackson, MS 39203-3636
Phone: (601) 354-4960
Fax: (601) 353-6231

Workplace Solutions
2207 5th Street
Meridian, MS 38652
Phone: (601) 484-7279

Workplace Solutions
520 Main Street
Natchez, MS 39120
Phone: (601) 442-1494
Fax: (601) 442-0457

Workplace Solutions
718 West Bankhead St.
New Albany, MS 38652
Phone: (662) 534-0882
Fax: (662) 534-5753

OEC Business Interiors
12199 Highway 49 N.
Suite 300
Gulfport, MS 39503-3167
Phone: (228) 539-9575
Fax: (228) 539-9566

Missouri

Color-Art Integrated Interiors
1325 North Warson Road
Saint Louis, MO 63132-1807
Phone: (314) 432-3000
Fax: (314) 993-2752

Marathon Office Interiors
1715 Paris Road
Columbia, MO 65201-5571
Phone: (573) 875-7115
Fax: (573) 875-7116

Montana

KR Office Interiors
119 North 7th Avenue
Bozeman, MT 59715
Phone: (406) 587-3775
Fax: (406) 587-4636

KR Office Interiors
1710 North Montana Avenue
Helena, MT 59601
Phone: (406) 513-1004
Fax: (406) 513-1006

Missoula's Office City
115 West Broadway Street
Missoula, MT 59802-4217
Phone: (406) 543-7171
Fax: (406) 543-4254

Peterson's Quality Office Equipment
502 North 32nd Street
Billings, MT 59101-6003
Phone: (406) 245-5151
Fax: (406) 245-7516

Western Office Equipment
317 2nd Street South
Great Falls, MT 59405-1802
Phone: (406) 761-7473
Fax: (406) 761-0245

Nebraska

Eakes Office Plus
2911 13th Street
Columbus, NE 68601-4829
Phone: (402) 564-2679
Fax: (402) 564-0295

Eakes Office Plus
Suite 201
2630 North Yager Road
Fremont, NE 68025-7800
Phone: (402) 941-5001
Fax: (402) 941-5002

Eakes Office Plus
617 West Third Street
Grand Island, NE 68801-5946
Phone: (308) 382-8026
Fax: (308) 382-7401

Eakes Office Plus
839 West Second Street
Hastings, NE 68901-5099
Phone: (402) 463-2537
Fax: (402) 463-6802

Eakes Office Plus
2401 Avenue A
Kearney, NE 68847-5498
Phone: (308) 234-2538
Fax: (308) 234-2540

Eakes Office Plus
110 N 35th Street
Lincoln, NE 68503
Phone: (402) 438-6700
Fax: (402) 438-6701

Eakes Office Plus
1803 North 6th Street
Beatrice, NE 68310
Phone: (402) 228-7202
Fax: (402) 228-0262

Eakes Office Plus
120 Norris Avenue
McCook, NE 69001
Phone: (308) 345-5447
Fax: (308) 345-5237

Eakes Office Plus
510 W. 13th Street
Souix City, NE 68776
Phone: (402) 412-2334

Eakes Office Plus
201 South 1st Street
Norfolk, NE 68701-5303
Phone: (402) 371-4181
Fax: (402) 371-5139

Eakes Office Plus
520 North Vine Street
North Platte, NE 69101-3954
Phone: (308) 534-7800
Fax: (308) 534-3936

Eakes Office Plus
710 North Lincoln Ave.
York, NE 68467
Phone: (402) 362-5442
Fax: (402) 362-7530

Sheppard's Business Interiors Inc.
725 South 72nd Street
Omaha, NE 68114-4665
Phone: (402) 393-8888
Fax: (402) 393-0113

Nevada

Machabee Office Environments
6435 Sunset Corporate Drive
Las Vegas, NV 89120-2798
Phone: (702) 263-8800
Fax: (702) 263-8801

Machabee Office Environments
1335 Greg Parkway #101
Sparks, NV 89431
Phone: (775) 329-3145
Fax: (775) 786-5710

New Hampshire

Red Thread
Suite 103
650 Elm Street
Manchester, NH 03101-1160
Phone: (603) 668-5511
Fax: (603) 668-6851

New Jersey

Arbee Associates
1531 South Washington Avenue
Piscataway, NJ 08854-3815
Phone: (732) 424-3900
Fax: (732) 752-6034

Concepts Office Furnishings
280 North Midland Avenue
Building J
Saddle Brook, NJ 07663-5708
Phone: (201) 727-9110
Fax: (201) 727-9112

Dancker, Sellow, and Douglas
291 Evans Way
Somerville, NJ 08876-3766
Phone: (908) 231-1600
Fax: (908) 231-6469

W.S. Goff Company Inc.
5104 Oakland Blvd.
Mays Landing, NJ 08330-2016
Phone: (609) 625-5600
Fax: (609) 625-5633

New Mexico

Business Environments
5351 Wilshire Avenue, N.E.
Albuquerque, NM 87113-1834
Phone: (505) 888-4400
Fax: (505) 889-9146

New York

AFD Contract Furniture Inc
810 7th Avenue
New York, NY 10019
Phone: (212) 721-7100
Fax: (212) 721-7175

Merkel-Donohue
1 Interstate Avenue
Albany, NY 12205
Phone: (518) 273-9359
Fax: (518) 272-1552

Empire Office Inc.
105 Madison Avenue
New York, NY 10016-8810
Phone: (212) 607-5500
Fax: (212) 607-5654

Merkel-Donohue
1349 University Avenue Suite 2
Rochester, NY 14607
Phone: (585) 325-7696
Fax: (585) 325-3065

Prentice Office Environments
472 Franklin Street
Buffalo, NY 14202-1302
Phone: (716) 884-8452
Fax: (716) 884-0894

Stevens Office Interiors
6804 Manlius Center Road
East Syracuse, NY 13057-3902
Phone: (315) 479-5595
Fax: (315) 428-1688

Waldner's Business Environments
125 Route 110
Farmingdale, NY 11735-4864
Phone: (631) 844-9300
Fax: (631) 694-3503

Waldner's Business Environments
215 Lexington Avenue, 9th Floor
New York, NY 10016-6023
Phone: (212) 696-7500
Fax: (212) 696-7699

Waldner's Business Environments
411 Theodore Fremd Avenue
3rd Floor, South Building
Rye, NY 10580-1410
Phone: (914) 921-8500
Fax: (914) 921-0991

North Carolina

Office Environments Inc.
11407 Granite Street
Charlotte, NC 28273-6429
Phone: (704) 714-7200
Fax: (704) 714-7400

Young Office Environments
of Asheville Inc.
71 Thompson St
Asheville, NC 28803-2328
Phone: (888) 202-0508
Fax: (828) 505-1974

Storr Office Environments Inc.
496 Gallimore Dairy Road
Greensboro, NC 27409-9202
Phone: (336) 217-4500
Fax: (336) 217-4501

Storr Office Environments Inc.
10800 World Trade Blvd.
Raleigh, NC 27617-4200
Phone: (919) 313-3700
Fax: (919) 313-3701

Williams Office Environments Inc.
407 Ray Avenue
Fayetteville, NC 28301-4915
Phone: (910) 483-0354
Fax: (910) 486-4077

North Dakota

Fireside Office Products Inc.
1713 East Bismarck Expressway
Bismarck, ND 58504-6706
Phone: (701) 258-8586
Fax: (701) 223-9598

Hannaher's
1809 13th Avenue North
Grand Forks, ND 58203-2323
Phone: (701) 746-6466
Fax: (701) 746-0737

Hannaher's Inc.
4324 20th Avenue SW
Fargo, ND 58103-4434
Phone: (701) 277-7222
Fax: (701) 277-7097

Ohio

Business Furniture
8 North Main Street
Dayton, OH 45439
Phone: (937) 293-1010
Fax: (937) 293-7501

Loth Inc.
3574 East Kemper Road
Cincinnati, OH 45241-2009
Phone: (513) 554-4900
Fax: (513) 554-8737

Loth Company
855 Grandview Avenue
Columbus, OH 43215-1123
Phone: (614) 487-4000
Fax: (614) 487-4306

NBS
4 North St. Clair Street
Toledo, OH 43604
Phone: (419) 662-2040
Fax: (419) 662-2041

Ohio Desk
34 Swartz Road
Akron, OH 44319
Phone: (330) 499-1030

Ohio Desk
1122 Prospect Avenue
Cleveland, OH 44115-1292
Phone: (216) 623-0600
Fax: (216) 623-0611

Ohio Desk
5100 Market Street
Youngstown, OH 44512
Phone: (330) 782-3331

Oklahoma

Scott Rice
2900 North Hemlock Circle
Broken Arrow, OK 74012-1185
Phone: (918) 362-4300
Fax: (918) 362-4303

Scott Rice
7501 Broadway Ext
Oklahoma City, OK 73116-9015
Phone: (405) 848-2224
Fax: (405) 848-3999

Oregon

Hypn
Suite 103/104
150 SW Scalehouse Loop
Bend, OR 97702
Phone: (541) 317-8777
Fax: (541) 317-2833

Hypn
620 NE 19th Avenue
Portland, OR 97232-2832
Phone: (503) 226-4151
Fax: (503) 226-9233

Pennsylvania

A. Pomerantz & Company
Suite 7000
701 Market Street
Philadelphia, PA 19106-1597
Phone: (215) 408-2100
Fax: (215) 408-2110

Corporate Interiors
Suite 200
161 Washington Street
Conshohocken, PA 19428-2083
Phone: (610) 631-5400
Fax: (610) 631-2720

Interior Workplace Solutions LLC.
145 Stewart Road
Wilkes-Barre, PA 18706
Phone: (570) 288-7211
Fax: (570) 970-5817

Franklin Interiors
Suite 600
2740 Smallman Street
Pittsburgh, PA 15222-4720
Phone: (412) 261-2525
Fax: (412) 255-4089

Participating Steelcase Dealers, continued

Pennsylvania

Interior Workplace Solutions LLC.
6765 Ambassador Drive
Allentown, PA 18106-9510
Phone: (610) 391-0733
Fax: (610) 391-1155

Interior Workplace Solutions LLC.
Suite B-25
2209 Quarry Drive
Reading, PA 19609-1155
Phone: (610) 670-1800
Fax: (610) 670-8181

McCartney's Inc.
819 Howard Avenue
Altoona, PA 16601-4727
Phone: (814) 505-1111
Fax: (814) 949-6197

Phillips Workplace Interiors
6345 Flank Drive
Harrisburg, PA 17112
Phone: (844) 228-2600

South Carolina

Aiken Office Supply Inc.
2560 Whiskey Road
Aiken, SC 29803-9664
Phone: (803) 648-8339
Fax: (803) 649-4470

McWaters Inc.
1104 Shop Road
Columbia, SC 29201-4743
Phone: (803) 256-8303
Fax: (803) 252-5567

McWaters Inc.
3841 Commercial Center Drive
Ladson, SC 29456-4146
Phone: (843) 486-1823

Wulbern-Koval Company Inc.
1111 Morrison Drive
Charleston, SC 29403-3119
Phone: (843) 577-7666
Fax: (843) 577-7299

Young Office Environments
1280 Ridge Road
Greenville, SC 29607-4626
Phone: (864) 281-9500
Fax: (864) 281-9555

South Dakota

Interstate Office Products Inc.
228 South Main Avenue
Sioux Falls, SD 57104-6310
Phone: (605) 339-0300
Fax: (605) 339-1989

Western Stationers
714 Saint Joseph Street
Rapid City, SD 57701-2721
Phone: (605) 342-3310
Fax: (605) 342-4746

Tennessee

Bentco Office Solutions
1501 Stuart Street
Chattanooga, TN 37406
Phone: (423) 756-4437
Fax: (423) 756-6198

Memphis Business Interiors
4539 West Distriplex Drive
Memphis, TN 38118-7280
Phone: (901) 360-8899
Fax: (901) 360-8370

Office Resources Inc.
4020 Armory Oaks Drive
Nashville, TN 37204
Phone: (615) 376-1200
Fax: (615) 376-1245

Workspace Interiors
Suite 300
200 E. Main Street
Kingsport, TN 37660-4354
Phone: (423) 392-2600
Fax: (423) 392-2601

Workspace Interiors
2820 Middlebrook Pike
Knoxville, TN 39721
Phone: (865) 223-5404
Fax: (865) 223-5405

Texas

Abilene Printing & Stationery
218 Cedar Street
Abilene, TX 79601-5720
Phone: (915) 677-2673
Fax: (915) 675-6963

BKM Total Office of Texas
9755 Clifford Drive
Dallas, TX 75220
Phone: (214) 902-7200
Fax: (214) 902-7201

Business Interiors
1111 Valley View Lane
Irving, TX 75061-6008
Phone: (817) 858-2000
Fax: (817) 858-2020

McCoys Inc.
6869 Old Katy Road
Houston, TX 77024-2105
Phone: (713) 862-4600
Fax: (713) 862-7676

Rockford Business Interiors
211 East Riverside Drive
Austin, TX 78704-1203
Phone: (512) 442-0703
Fax: (512) 442-6555

Texas Wilson Office Furniture & Services
5801 George McVay Drive
McAllen, Texas 78503
Phone: (210) 647-8800
Fax: (210) 647-3110

Texas Wilson Office Furniture & Services

6812 Fairgrounds Pkwy
San Antonio, TX 78238-4536
Phone: (210) 647-8800
Fax: (210) 647-3110

West Supply Company
1601 Scurry
Big Spring, TX 79720
Phone: (432) 264-1788
Fax: (432) 264-1789

West Supply Company
2 South Chadbourne Street
San Angelo, TX 76903-5875
Phone: (325) 655-8181
Fax: (325) 655-5480

Utah

MidWest Office Furniture
987 South West Temple
Salt Lake City, UT 84101-2988
Phone: (801) 359-7681
Fax: (801) 355-2713

Vermont

Red Thread
180 Battery St Ste 210
Burlington, VT 05401-5212
Phone: (802) 862-0434
Fax: (802) 862-0729

Virginia

Barrows
1302 Rockland Avenue
Roanoke, VA 24012-3838
Phone: (540) 362-5700
Fax: (540) 362-4826

Creative Office Environments
11798 North Lakeridge Boulevard
Ashland, VA 23005-8152
Phone: (804) 329-0400
Fax: (804) 321-3134

Creative Office Environments LLC
650 Peter Jefferson Parkway #140
Charlottesville, VA 22911
Phone: (434) 327-1898
Fax: (434) 327-1896

Creative Office Environments LLC
Suite C
500 Woodlake Circle
Chesapeake, VA 23320-2807
Phone: (757) 549-4801
Fax: (757) 549-2795

reDistrict
Suite 30
66 Canal Center Plaza
Arlington, VA 22314
Phone: (703) 276-8901
Fax: (703) 276-8908

Washington

OpenSquare
6th Floor
5601 Sixth Avenue South
Seattle, WA 98108-2522
Phone: (206) 768-8000
Fax: (206) 768-0236

OpenSquare
126 South Sheridan Street
Spokane, WA 99202-1527
Phone: (509) 483-1000
Fax: (509) 483-1011

Wisconsin

Atmosphere Commercial Interiors
999 Fourier Drive Suite 200
Madison, WI 53717
Phone: (608) 257-0521
Fax: (608) 257-1859

Puerto Rico

AFD Contract Furnishings
Suite 250
350 Chardon Avenue
Torre Chardon
San Juan, Puerto Rico 00918-2123
Phone: (787) 754-2938
Fax: (787) 754-8076

Showrooms

Atlanta

Steelcase Inc.
Suite AL-175
303 Peachtree Center
Atlanta, GA 30303
Phone: (404) 523-2201

Chicago

Steelcase Worklife Chicago
Suite 300
222 Merchandise Mart
Chicago, IL 60654-1174
Phone: (312) 321-3720

Chicago

Coalesse
Suite 1032
222 Merchandise Mart
Chicago, IL 60654
Phone: (312) 467-1783

Dallas

Steelcase Inc.
1616 Hi Line Drive
Dallas, TX 75207
Phone: (214) 871-3044

Grand Rapids

Steelcase Inc.
901 44th Street, SE
Grand Rapids, MI 49508-7594
Phone: (616) 247-2710

New York

Steelcase Worklife New York
4 Columbus Circle
New York, NY 10019-1100
Phone: (212) 445-8800

Philadelphia

Steelcase Inc.
One Liberty Place
1650 Market Street, 3rd Floor
Philadelphia, PA 19103-7307
Phone: (215) 561-5331

San Francisco

Steelcase Inc.
Suite 110
475 Brannan Street
San Francisco, CA 94107
Phone: (415) 344-6700

Santa Monica

Steelcase Inc.
1217 2nd Street
Santa Monica, CA 90401-1180
Phone: (310) 633-2200

Washington D.C.

Steelcase Inc.
1121 14th Street NW
4th Floor
Washington, DC 20005

Manufacturing Sites

Amex de Mexico

Calle 5 Sur No.160
Ciudad Industrial
Tijuana, Mexico B.C. 22500
Phone: 52-662-342-6234

Athens

214 Durham Drive
Athens, AL 35611
Phone: (256) 232-8112

Grand Rapids Wood Furniture

4100 68th Street SE
Caledonia, MI 49316
Phone: (616) 698-5735

Kentwood Distribution Center

4384 52nd Street SE
Kentwood, MI 49512-9673

Kentwood West

4360 52nd Street SE
Kentwood, MI 49512

Details

901 44th Street SE
Grand Rapids, MI 49508
Phone: (616) 247-2710

Reynosa Plant

Ave. Prologis S/N Ed. 8 Suite
801 Prologis Park Pharr Bridge
Reynosa,
Tamaulipas, Mx CP. 88780
Phone: 52-899-263-9000



Walden



Statement of Line **20**

Specifying

Desks (SIN 711.8)	26
Single-Pedestal Desks with Legs (SIN 711.8)	30
Table Desks (SIN 711.8)	32
Straight Run-Offs (SIN 711.8)	34
Bullet Run-Offs (SIN 711.8)	35
Bullet-Shape Tables (SIN 711.8)	36
Desk Returns (SIN 711.8)	38
Returns (SIN 711.8)	40
Bridges (SIN 711.8)	42
Modesty Panels (SIN 711.8)	43
Corner Unit (SIN 711.8)	44
Full Storage Credenzas (SIN 711.8)	46
Kneespace Credenzas (SIN 711.8)	50
Shell Credenzas (SIN 711.8)	54
Mobile Pedestal (SIN 711.8)	56
Lateral Files (SIN 711.8)	58
Service Modules (SIN 711.8)	61
Tackboards (SIN 711.8)	62
Light Valances (SIN 711.8)	63
Back Panels for Desktop Organizers (SIN 711.8)	64
Stacking Bookcases (SIN 711.8)	65
Freestanding Bookcases (SIN 711.8)	66
Vertical Cabinets, Wardrobes, and Towers (SIN 711.8)	68
Accessories (SIN 711.8)	70

Statement of Line

Walden

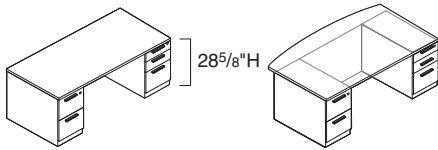

Specifying
▶ Page 26

Double-Pedestal Desks

	60"W	66"W	72"W
30"D	■	■	
36"D			■ ●

● = Bowed worksurface ■ = Straight worksurface

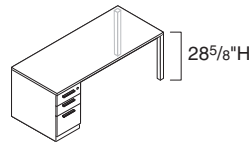

Specifying
▶ Page 30

Single Pedestal Desks with Legs*

	60"W	66"W	72"W
30"D	●	●	●

*Drawing shows left-hand unit. Right-hand unit is also available.

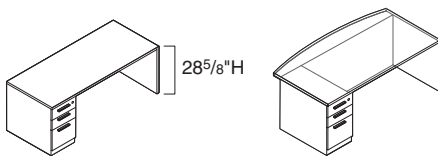

Specifying
▶ Page 26

Single-Pedestal Desks*

	60"W	66"W	72"W
30"D	■	■	■
36"D			■ ●

● = Bowed worksurface ■ = Straight worksurface

*Drawing shows left-hand unit. Right-hand unit is also available.

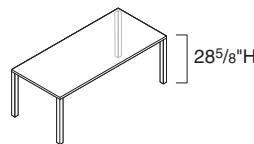

Specifying
▶ Page 32

Table Desks

	60"W	66"W	72"W
30"D	●	●	●
36"D			●

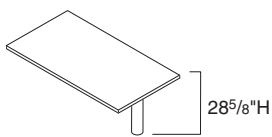

Specifying
▶ Page 34

Straight Run-Offs

	48"W	60"W	72"W
30"D	●	●	
36"D			●

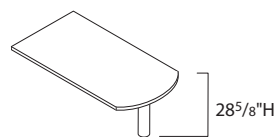

Specifying
▶ Page 35

Bullet Run-Offs

	48"W	60"W	72"W
30"D	●	●	
36"D			●



Walden

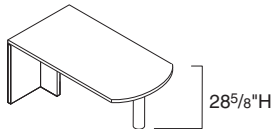

Specifying
▶ Page 36

Bullet-Shape Tables

	60"W	72"W
30"D	●	
36"D		●

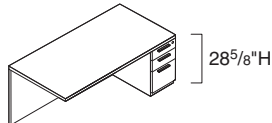

Specifying
▶ Page 38

Desk Returns*

	60"W	72"W
30"D	●	●

*Drawing shows right-hand unit. Left-hand unit is also available.

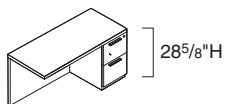

Specifying
▶ Page 40

Returns*

	42"W	48"W	72"W
24"D	●	●	●

*Drawing shows right-hand unit. Left-hand unit is also available.

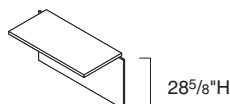

Specifying
▶ Page 42

Bridges

	42"W	48"W
24"D	●	●

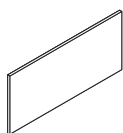

Specifying
▶ Page 43

Modesty Panels

	30"W	36"W	42"W	48"W	54"W	60"W	66"W	78"W	84"W	90"W
18"H	●	●	●	●	●	●	●	●	●	●

Statement of Line, Walden, continued

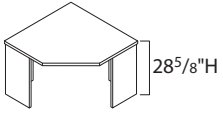

Specifying
▶ Page 44

Corner Unit

42"W

24"D ●

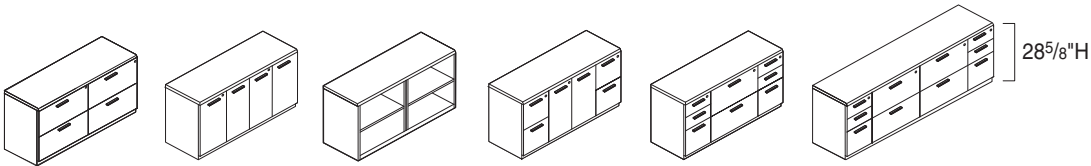

Specifying
▶ Page 46

Full-Storage Credenzas

60"W 66"W 72"W 90"W

24"D ● ● ● ●

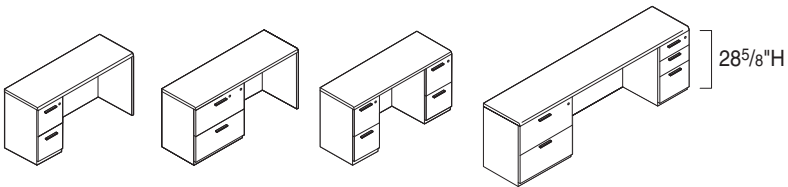

Specifying
▶ Page 50

Kneespace Credenzas*

60" W 66"W 72"W 90"W 96"W 102"W

24"D ● ● ● ● ● ●

*Drawing shows left-hand unit. Right-hand unit is also available.

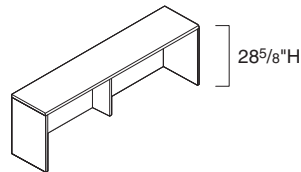

Specifying
▶ Page 54

Shell Credenzas

	72"W	96"W	102"W
24"D	●	●	●

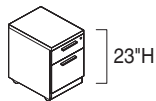

Specifying
▶ Page 56

Mobile Pedestal

	15 1/2"W
22 3/4"D	●

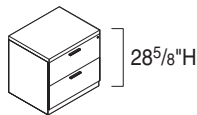

Specifying
▶ Page 58

Lateral Files

	30"W	36"W
24"D	●	●

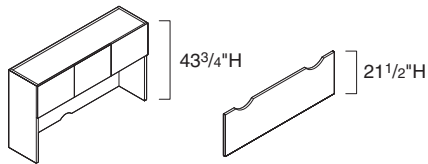

Specifying
▶ Pages 61
and 62

Service Modules and Tackboards

	60"W	66"W	72"W	90"W
15"D	●	●	●	●

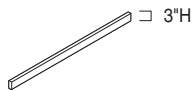

Specifying
▶ Page 63

Light Valances

	57 3/4"W	63 3/4"W	69 3/4"W	87 3/4"W
3"H	●	●	●	●

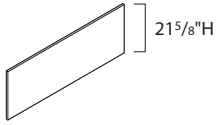

Specifying
▶ Page 64

Back Panels for Desktop Organizers

	60"W	72"W
3/4"D	●	●

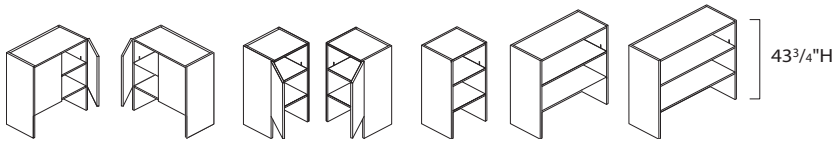

Specifying
▶ Page 65

Stacking Bookcases

	15"W	30"W	36"W
15"D	●	●	●

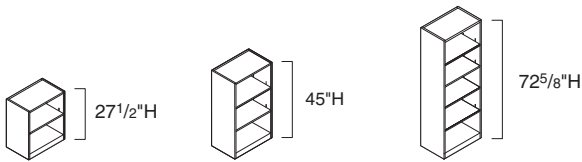

Specifying
▶ Page 66

Freestanding Bookcases

	30"W	36"W
15"D	●	●

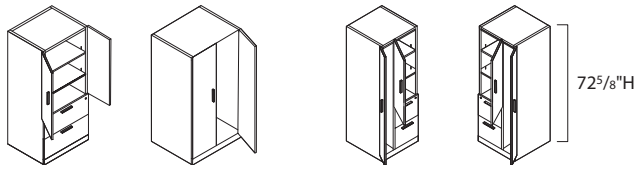

Specifying
Page 68

Vertical Cabinets, Wardrobes, and Towers

	24"W	30"W	36"
24"D	■	●	●

● = Vertical Cabinets and Wardrobes ■ = Towers

Desks

SIN 711.8

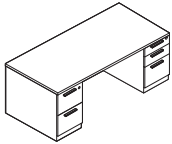

Tip: Single-pedestal desks are built as units, but they are reconfigurable. However, the units will be defaced and will require replacement parts to reconfigure the desk.

Standard Includes	Required to Specify
-------------------	---------------------

- Desk case: wood group 1
- Desk worksurface: wood group 1 veneer or laminate price group 1
- Full-height back panel and full-height pedestals
- Lock: keyed random
- One pencil tray per desk: black plastic
- One fastened metal filing system per file drawer: black only
- Leveling glides: black only

- 1 Style number
 - 2 Wood color number for desk
 - 3 Laminate color number for worksurface, if selected
 - 4 Worksurface profile (see below under Required Selections)
 - 5 Pull shape (see below under Required Selections)
 - 6 Finish color number for pull
 - 7 Finish color number for lock
 - 8 Options, if selected (see below)
- ▶ See *Surface Materials*, page 154.

Required Selections (No Additional Cost)
--

Worksurface Edge Profiles

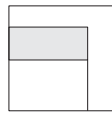

Square

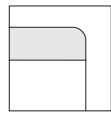

Bullnose

Pull Shape

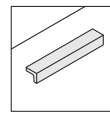

L

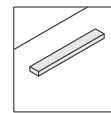

Line

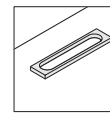

Loop

Options	Price	Required to Specify
---------	-------	---------------------

Surface Materials	<p>Wood veneer worksurface</p> <ul style="list-style-type: none"> • Wood group 2 • Wood group 3 • Customiz stain on case and worksurface • Full-fill finish on wood group 1 <p>Laminate worksurface</p> <ul style="list-style-type: none"> • High-Pressure Laminate price group 2 • Open Line laminate 	<p>Prices at right</p> <p>Prices at right</p> <p>No cost</p> <p>Prices at right</p> <hr/> <p>See information at left</p> <p>+\$69 plus cost of laminate</p> <p>Prices at right</p> <p>Prices at right</p> <p>No cost</p>	<p>Specify wood color number.</p> <p>Specify wood color number.</p> <p>Specify with <i>Customiz stain</i>.</p> <p>▶ See <i>Surface Materials Reference Manual</i>.</p> <p>Specify full-fill finish number.</p> <hr/> <p>Specify High-Pressure Laminate color number.</p> <p>▶ See <i>Surface Materials Reference Manual</i>.</p>
--------------------------	--	--	--

Cable Management	<p>Round grommets</p> <ul style="list-style-type: none"> • For 36"D Desks <ul style="list-style-type: none"> • For 30"D desks 	<p>+\$74 each</p> <p>+\$74 each</p>	<p>Left: Specify with <i>EGRHL</i> and color number.</p> <p>Center: Specify with <i>EGRHC</i> and color number.</p> <p>Right: Specify with <i>EGRHR</i> and color number.</p> <p>Left: Specify with <i>EGRL</i> and color number.</p> <p>Center: Specify with <i>EGRC</i> and color number.</p> <p>Right: Specify with <i>EGRR</i> and color number.</p>
-------------------------	---	--	--

Tip: The thickness of the worksurface is 1/4".

Tip: 36"D worksurfaces have 6" overhang.

Tip: Bow desks have square edge on visitor side regardless which edge is selected.

For laminate price group 2 pricing, please refer to the electronic catalog or SmartTools.

▶ Options, continued on next page

► Options, continued from previous page

Options	Price	Required to Specify
Cable Management Flip Up Power Units • For 36"D desks	+\$326 each	Left: Specify with VPFHL and color number. Center: Specify with VPFHC and color number. Right: Specify with VPFHR and color number.
• For 30"D desks	+\$326 each	Left: Specify with VPFL and color number. Center: Specify with VPFC and color number. Right: Specify with VEFR and color number.
Lock and Keying Lock • Ember Chrome • Polished Chrome	No cost No cost	Specify with 9250 Ember Chrome lock. Specify with 9201 Polished Chrome lock.
Keying • Factory- and field-installed		► Page 622



Specification Information										
Dimensions D W	Knee-space Width	Style Number	Base Prices	Options (Add \$ to Base Price)						
				Wood Case	Wood Work-surface	Laminate Work-surface	Wood Case/ Wood Top	Wood Case/ Laminate Top	Wood Group 2	Wood Group 3

Double-Pedestal Desks—28⁵/₈" High

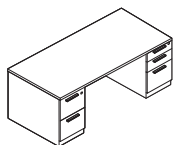

30"	60"	30"	WLDD3060	\$3481	\$3202	+\$332	+\$1162	+\$263	+\$ 920	+\$69
30"	66"	36"	WLDD3066	\$3543	\$3264	+\$332	+\$1162	+\$263	+\$ 920	+\$69
36"	72"	42"	WLDD3672	\$3696	\$3417	+\$389	+\$1365	+\$293	+\$1030	+\$96

Double-Pedestal Bow Desk—28⁵/₈" High

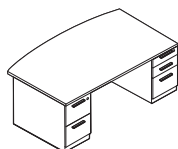

36" ¹ / ₄ "	72"	42"	WLDB364272	\$3813	\$3461	+\$389	+\$1365	+\$293	+\$1030	+\$96
-----------------------------------	-----	-----	-------------------	--------	--------	--------	---------	--------	---------	-------

► Specification Information, continued on next page

Desks, continued

SIN 711.8

► Specification Information, continued from previous page

Specification Information

Dimensions		Knee-space Width	Style Number	Base Prices		Options (Add \$ to Base Price)				
D	W			Wood Case	Wood Work-surface	Laminate Work-surface	Wood Case/ Wood Top	Wood Case/ Laminate Top	Wood	Wood
						Wood Group 2	Wood Group 3	Wood Group 2	Wood Group 3	Full-Fill Finish on Wood Group 1

Single-Pedestal Desks—28⁵/₈" High



Left-Hand Single-Pedestal Desks

30"	60"	43 ⁷ / ₈ "	WLDS3060L	\$2639	\$2360	+\$311	+\$1085	+\$242	+\$843	+\$69
30"	66"	49 ⁷ / ₈ "	WLDS3066L	\$2703	\$2424	+\$311	+\$1085	+\$242	+\$843	+\$69
30"	72"	55 ⁷ / ₈ "	WLDS3072L	\$2768	\$2489	+\$341	+\$1194	+\$272	+\$952	+\$69
36"	72"	55 ⁷ / ₈ "	WLDS3672L	\$2857	\$2578	+\$368	+\$1287	+\$272	+\$952	+\$96

Right-Hand Single-Pedestal Desks

30"	60"	43 ⁷ / ₈ "	WLDS3060R	\$2639	\$2360	+\$311	+\$1085	+\$242	+\$843	+\$69
30"	66"	49 ⁷ / ₈ "	WLDS3066R	\$2703	\$2424	+\$311	+\$1085	+\$242	+\$843	+\$69
30"	72"	55 ⁷ / ₈ "	WLDS3072R	\$2768	\$2489	+\$341	+\$1194	+\$272	+\$952	+\$69
36"	72"	55 ⁷ / ₈ "	WLDS3672R	\$2857	\$2578	+\$368	+\$1287	+\$272	+\$952	+\$96

Single-Pedestal Bow Desks—28⁵/₈" High

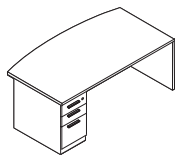

Left-Hand Single-Pedestal Bow Desks

36 ¹ / ₂ "	72"	55 ⁷ / ₈ "	WLDW364272L	\$2975	\$2623	+\$368	+\$1287	+\$272	+\$952	+\$96
----------------------------------	-----	----------------------------------	--------------------	--------	--------	--------	---------	--------	--------	-------

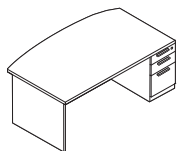

Right-Hand Single-Pedestal Bow Desks

36 ¹ / ₂ "	72"	55 ⁷ / ₈ "	WLDW364272R	\$2975	\$2623	+\$368	+\$1287	+\$272	+\$952	+\$96
----------------------------------	-----	----------------------------------	--------------------	--------	--------	--------	---------	--------	--------	-------



Single-Pedestal Desks with Legs

SIN 711.8

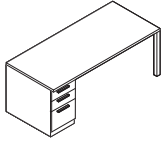

Tip: Ships knocked down.

Standard Includes	Required to Specify
<ul style="list-style-type: none"> • Desk case: wood group 1 • Desk worksurface: wood group 1 veneer or laminate price group 1 • Legs: paint • Full-height pedestal • Lock: keyed random • One pencil tray per desk: black plastic • One fastened metal filing system per file drawer: black only • Leveling glides: black only • Counterweight package 	<ol style="list-style-type: none"> 1 Style number 2 Wood color number for desk 3 Laminate color number for worksurface, if selected 4 Worksurface profile (see below under Required Selections) 5 Pull shape (see below under Required Selections) 6 Paint color number for legs 7 Finish color number for pull 8 Finish color number for lock 9 Options, if selected (see below) <p>▶ See <i>Surface Materials</i>, page 154.</p>

Required Selections (No Additional Cost)

Worksurface Edge Profiles

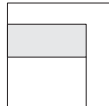

Square

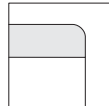

Bullnose

Pull Shape

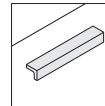

L

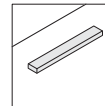

Line

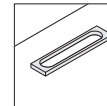

Loop

Options	Price	Required to Specify
Surface Materials Wood veneer worksurface <ul style="list-style-type: none"> • Wood group 2 • Wood group 3 • Customiz stain on case and worksurface • Full-fill finish on wood group 1 	Prices at right Prices at right No cost Prices at right	Specify wood color number. Specify wood color number. Specify with <i>Customiz stain</i> . ▶ See <i>Surface Materials Reference Manual</i> . Specify full-fill finish number.
Laminate worksurface <ul style="list-style-type: none"> • High-Pressure Laminate price group 2 • Open Line laminate 	See information at left +\$ 69 plus cost of laminate Prices at right Prices at right No cost	Specify High-Pressure Laminate color number. ▶ See <i>Surface Materials Reference Manual</i> . Specify wood color number. Specify wood color number. Specify with <i>Customiz stain</i> . ▶ See <i>Surface Materials Reference Manual</i> .
Cable Management <ul style="list-style-type: none"> • Round grommets • Flip up power units 	+\$ 74 each +\$326 each	Left: Specify with <i>EGRL</i> and color number. Center: Specify with <i>EGRC</i> and color number. Right: Specify with <i>EGRR</i> and color number. Left: Specify with <i>VPFL</i> and color number. Center: Specify with <i>VPFC</i> and color number. Right: Specify with <i>VPFR</i> and color number.
Lock and Keying <ul style="list-style-type: none"> • Lock <ul style="list-style-type: none"> • Ember Chrome • Polished Chrome • Keying <ul style="list-style-type: none"> • Factory- and field-installed 	No cost No cost	Specify with <i>9250 Ember Chrome lock</i> . Specify with <i>9201 Polished Chrome lock</i> . ▶ Page 622
Related Products <ul style="list-style-type: none"> • Accessories 		▶ Page 70

For laminate price group 2 pricing, please refer to the electronic catalog or SmartTools.

Tip: Do not specify grommet or flip up power unit above leg.

Specification Information

Dimensions		Knee-space Width	Style Number	Base Prices		Options (Add \$ to Base Price)				
D	W			Wood Panels	Wood Work-surface	Laminate Work-surface	Wood	Wood Case/Laminate Top	Wood Case/Laminate Top	Full-Fill Finish on Wood Group 1
						Wood Group 2	Wood Group 3	Wood Group 2	Wood Group 3	

Single-Pedestal Desks with Legs—28⁵/₈" High

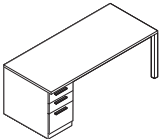

Left-Hand Single-Pedestal Desks with Legs

30"	60"	43"	WDL3060L	\$2306	\$2027	+\$138	+\$484	+\$69	+\$242	+\$69
30"	66"	49"	WDL3066L	\$2340	\$2061	+\$138	+\$484	+\$69	+\$242	+\$69
30"	72"	55"	WDL3072L	\$2372	\$2093	+\$138	+\$484	+\$69	+\$242	+\$69
:	:	:	:	:	:	:	:	:	:	:

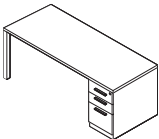

Right-Hand Single-Pedestal Desks with Legs

30"	60"	43"	WDL3060R	\$2306	\$2027	+\$138	+\$484	+\$69	+\$242	+\$69
30"	66"	49"	WDL3066R	\$2340	\$2061	+\$138	+\$484	+\$69	+\$242	+\$69
30"	72"	55"	WDL3072R	\$2372	\$2093	+\$138	+\$484	+\$69	+\$242	+\$69
:	:	:	:	:	:	:	:	:	:	:

Table Desks

SIN 711.8

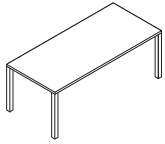

Tip: Ships knocked down.

Tip: Worksurfaces supported by legs, or tethered brackets that have unsupported spans less than or equal to 84"W, use one worksurface brace. For unsupported spans greater than 84"W, two worksurface braces are required for support.

▶ See Elective Elements Specification Guide.

For laminate price group 2 pricing, please refer to the electronic catalog or SmartTools.

Tip: Do not specify grommet or flip up power unit above leg.

Standard Includes	Required to Specify
-------------------	---------------------

- | | |
|---|---|
| <ul style="list-style-type: none"> • Desk worksurface: wood group 1 veneer or laminate price group 1 • Legs: painted metal • Leveling glides: black only | <ol style="list-style-type: none"> 1 Style number 2 Wood or laminate color number for worksurface 3 Worksurface profile (see below under Required Selections) 4 Paint finish number for legs 5 Options, if selected (see below) <p>▶ See <i>Surface Materials</i>, page 154.</p> |
|---|---|

Required Selections (No Additional Cost)
--

Worksurface Edge Profiles

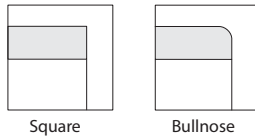

Options	Price	Required to Specify
---------	-------	---------------------

Surface Materials	<p>Wood veneer worksurface</p> <ul style="list-style-type: none"> • Wood group 2 • Wood group 3 • Customiz stain on worksurface • Full-fill finish on wood group 1 <p>Laminate worksurface</p> <ul style="list-style-type: none"> • High-Pressure Laminate price group 2 • Open Line laminate 	<p>Prices at right</p> <p>Prices at right</p> <p>No cost</p> <p>Prices at right</p> <p>See information at left</p> <p>+\$ 69 plus cost of laminate</p>	<p>Specify wood color number.</p> <p>Specify wood color number.</p> <p>Specify with <i>Customiz stain</i>.</p> <p>▶ See <i>Surface Materials Reference Manual</i>.</p> <p>Specify full-fill finish number.</p> <p>Specify High-Pressure Laminate color number.</p> <p>▶ See <i>Surface Materials Reference Manual</i>.</p>
Cable Management	<p>Round grommets</p> <ul style="list-style-type: none"> • For 30"D desk • For 36"D desk <p>Flip Up Power Units</p> <ul style="list-style-type: none"> • For 30"D desk • For 36"D desk 	<p>+\$ 74 each</p> <p>+\$ 74 each</p> <p>+\$326 each</p> <p>+\$326 each</p>	<p>Center: Specify with <i>EGRC</i> and color number.</p> <p>Left: Specify with <i>EGRHL</i> and color number.</p> <p>Center: Specify with <i>EGRHC</i> and color number.</p> <p>Right: Specify with <i>EGRHR</i> and color number.</p> <p>Center: Specify with <i>VPFC</i> and color number.</p> <p>Left: Specify with <i>VPFHL</i> and color number.</p> <p>Center: Specify with <i>VPFHC</i> and color number.</p> <p>Right: Specify with <i>VPFHR</i> and color number.</p>
Related Products	<ul style="list-style-type: none"> • Modesty panels • Accessories • Worksurface brace 	<p>▶ Page 43</p> <p>▶ Page 70</p> <p>▶ Page 274</p>	

Specification Information

• Dimensions		• Style Number	• Base Prices		• Options (Add \$ to Base Price)		
D	W		Wood Worksurface	Laminate Worksurface	Wood Top	Wood	Finish
:	:	:	:	:	Group 2	Group 3	on Wood
:	:	:	:	:	:	:	Group 1

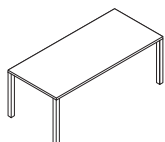
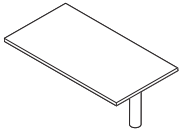

Table Desk—28⁵/₈" High

30"	60"	WLTD3060	\$1580	\$1301	+\$69	+\$242	+\$69
30"	66"	WLTD3066	\$1614	\$1335	+\$69	+\$242	+\$69
30"	72"	WLTD3072	\$1646	\$1367	+\$69	+\$242	+\$69
36"	72"	WLTD3672	\$1732	\$1453	+\$96	+\$335	+\$69
:	:	:	:	:	:	:	:

Straight Run-Offs

SIN 711.8



Tip: Ships knocked down.

Standard Includes	Required to Specify
<ul style="list-style-type: none"> • Worksurface: wood group 1 or laminate price group 1 • Column support: painted or plated metal • Attachment hardware 	<ol style="list-style-type: none"> 1 Style number 2 Wood or laminate color number for run-off 3 Worksurface profile (see below under Required Selections) 4 Color number for column support 5 Options, if selected (see below) <p>▶ See <i>Surface Materials</i>, page 154.</p>

Required Selections (No Additional Cost)

Worksurface Edge Profiles

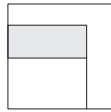

Square

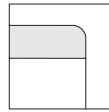

Bullnose

Options	Price	Required to Specify
Surface Materials <ul style="list-style-type: none"> • Wood veneer worksurface <ul style="list-style-type: none"> • Wood group 2 • Wood group 3 • Customiz stain • Full-fill finish on wood group 1 • Laminate worksurface <ul style="list-style-type: none"> • High-Pressure Laminate price group 2 • Open Line laminate 	<ul style="list-style-type: none"> Prices below Prices below No cost Prices below See information at left +\$ 69 plus cost of laminate 	<ul style="list-style-type: none"> Specify wood color number. Specify wood color number. Specify <i>with Customiz stain</i>. ▶ See <i>Surface Materials Reference Manual</i>. Specify full-fill finish number. Specify High-Pressure Laminate color number. ▶ See <i>Surface Materials Reference Manual</i>.
Cable Management <ul style="list-style-type: none"> • Round grommets • Flip up power units 	<ul style="list-style-type: none"> +\$ 74 each +\$326 each 	<ul style="list-style-type: none"> Left: Specify <i>with EGRL</i> and color number. Right: Specify <i>with EGRR</i> and color number. Left: Specify <i>with VPFL</i> and color number. Right: Specify <i>with VPFR</i> and color number.
Support <ul style="list-style-type: none"> • Disk column • Square legs 	<ul style="list-style-type: none"> +\$284 +\$114 	<ul style="list-style-type: none"> Specify <i>with disk column</i>. Specify <i>with square legs</i>.
Related Products <ul style="list-style-type: none"> • Accessories 		▶ Page 70

For laminate price group 2 pricing, please refer to the electronic catalog or SmartTools.

Specification Information

• Dimensions		• Style	• Base		• Options		
D	W	Number	Prices		(Add \$ to Base Price)		
•••••	•••••	•••••	•••••	•••••	•••••	•••••	•••••
			Wood Worksurface	Laminate Worksurface	Wood Top	• Full-Fill	
					Wood	• Wood	• Finish
					Group 2	• Group 3	• on Wood
							• Group 1

Straight Run-Offs—28⁵/₈" High

30"	48"	WLRS3048	\$ 911	\$786	+\$47	+\$164	+\$47
30"	60"	WLRS3060	\$1070	\$791	+\$69	+\$242	+\$69
36"	72"	WLRS3672	\$1179	\$900	+\$96	+\$335	+\$96
•	•	•	•	•	•	•	•

Bullet Run-Offs

SIN 711.8

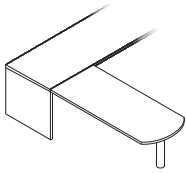

Tip: Ships knocked down.

Standard Includes	Required to Specify
<ul style="list-style-type: none"> • Worksurface: wood group 1 or laminate price group 1 • Column support: painted or plated metal • Attachment hardware 	<ol style="list-style-type: none"> 1 Style number 2 Wood or laminate color number for run-off 3 Worksurface profile (see below under Required Selections) 4 Color number for column support 5 Options, if selected (see below) <p>▶ See <i>Surface Materials</i>, page 154.</p>

Required Selections (No Additional Cost)

Worksurface Edge Profiles

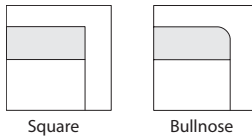

Options	Price	Required to Specify
Surface Materials Wood veneer worksurface <ul style="list-style-type: none"> • Wood group 2 • Wood group 3 • Customiz stain <ul style="list-style-type: none"> • Full-fill finish on wood group 1 Laminate worksurface <ul style="list-style-type: none"> • High-Pressure Laminate price group 2 • Open Line laminate 	<ul style="list-style-type: none"> Prices below Prices below No cost <ul style="list-style-type: none"> Prices below <ul style="list-style-type: none"> See information at left +\$ 69 plus cost of laminate 	<ul style="list-style-type: none"> Specify wood color number. Specify wood color number. Specify with <i>Customiz stain</i>. ▶ See <i>Surface Materials Reference Manual</i>. Specify full-fill finish number. <ul style="list-style-type: none"> Specify High-Pressure Laminate color number. ▶ See <i>Surface Materials Reference Manual</i>.
Cable Management <ul style="list-style-type: none"> • Round grommets • Flip up power units 	<ul style="list-style-type: none"> +\$ 74 each +\$326 each 	<ul style="list-style-type: none"> Left: Specify with <i>EGRL</i> and color number. Right: Specify with <i>EGRR</i> and color number. Left: Specify with <i>VPFL</i> and color number. Right: Specify with <i>VPFR</i> and color number.
Disk Column <ul style="list-style-type: none"> • Disk column 	<ul style="list-style-type: none"> +\$284 	<ul style="list-style-type: none"> Specify with <i>disk column</i>.
Related Products <ul style="list-style-type: none"> • Accessories 		<ul style="list-style-type: none"> ▶ Page 70

For laminate price group 2 pricing, please refer to the electronic catalog or SmartTools.

Specification Information

Dimensions		Style	Base Prices		Options		
D	W	Number	Wood Worksurface	Laminate Worksurface	(Add \$ to Base Price)		
					Wood Top	Full-Fill	
					Wood	Wood	Finish
					Group 2	Group 3	on Wood
							Group 1

Bullet Run-Offs—28⁵/₈" High

30"	48"	WLRB3048	\$1234	\$1109	+\$96	+\$335	+\$96
30"	60"	WLRB3060	\$1401	\$1122	+\$96	+\$335	+\$96
36"	72"	WLRB3672	\$1590	\$1311	+\$96	+\$335	+\$96

Bullet-Shape Tables

SIN 711.8

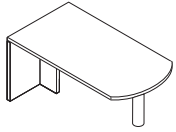

Tip: Ships knocked down.

Tip: Bullet-shape tables must be attached to a bridge or return for stability.

Standard Includes	Required to Specify
-------------------	---------------------

- Worksurface and end panel: wood group 1
- Column support: painted or plated metal

- 1 Style number
 - 2 Wood color number for worksurface and end panel
 - 3 Worksurface profile (see below under Required Selections)
 - 4 Column support color number
 - 5 Options, if selected (see below)
- ▶ See *Surface Materials*, page 154.

Required Selections (No Additional Cost)
--

Worksurface Edge Profiles

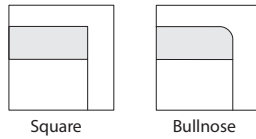

Options	Price	Required to Specify
---------	-------	---------------------

Surface Materials

Wood veneer worksurface

- Wood group 2
- Wood group 3
- Customiz stain on worksurface and panels
- Full-fill finish on wood group 1

Prices below
Prices below
No cost
Prices below

Specify wood color number.
Specify wood color number.
Specify *with Customiz stain*.
▶ See *Surface Materials Reference Manual*.
Specify full-fill finish number.

Laminate worksurface

- Wood group 2 on panels
- Wood group 3 on panels
- Customiz stain on panels
- High-Pressure Laminate price group 2
- Open Line laminate

Prices below
Prices below
No cost
See information at left
+\$ 69
plus cost of laminate

Specify wood color number.
Specify wood color number.
Specify *with Customiz stain*.
Specify High-Pressure Laminate color number.
▶ See *Surface Materials Reference Manual*.

Cable Management

- Round grommets
- Flip up power units

+\$ 74 each
+\$326 each

Left: Specify *with EGRL* and color number.
Right: Specify *with EGRR* and color number.
Left: Specify *with VPFL* and color number.
Right: Specify *with VPFR* and color number.

Disk Column

- Disk column

+\$284

Specify *with disk column*.

Related Products

- Accessories

▶ Page 70

For laminate price group 2 pricing, please refer to the electronic catalog or SmartTools.

Specification Information

Dimensions		Style Number	Base Prices		Options (Add \$ to Base Price)			
D	W		Wood Panel	Wood Work-surface	Wood		Full-Fill Finish on Wood Group 1	
					Wood Panel/ Wood Top	Wood Panel/ Laminate Top		Wood Group 2

Bullet-Shape Tables—28⁵/₈" High

30"	60"	WLTB3060	\$1965	\$1686	+\$165	+\$577	+\$69	+\$242	+\$96
36"	72"	WLTB3672	\$2186	\$1907	+\$165	+\$577	+\$69	+\$242	+\$96



Desk Returns

SIN 711.8

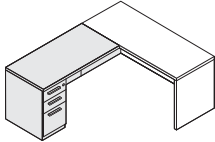

Tip: Desk return cannot be used freestanding.

Standard Includes	Required to Specify
-------------------	---------------------

- Return case: wood group 1
- Return worksurface: wood group 1 veneer or laminate price group 1
- Full-height pedestals
- Full-height finished back panel
- Locks: keyed random
- One pencil tray per desk return: black plastic
- One fastened metal filing system per file drawer: black only
- Leveling glides: black only
- Attachment hardware

- 1 Style number
 - 2 Wood color number for desk return
 - 3 Laminate color number for worksurface, if selected
 - 4 Worksurface profile (see below under Required Selections)
 - 5 Pull shape (see below under Required Selections)
 - 6 Finish color number for pull
 - 7 Finish color number for lock
 - 8 Options, if selected (see below)
- ▶ See *Surface Materials*, page 154.

Required Selections (No Additional Cost)
--

Worksurface Edge Profiles

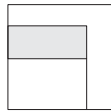

Square

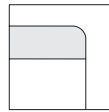

Bullnose

Pull Shape

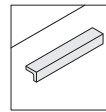

L

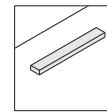

Line

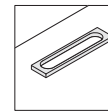

Loop

Options	Price	Required to Specify
---------	-------	---------------------

Surface Materials

Wood veneer worksurface

- Wood group 2
- Wood group 3
- Customiz stain on case and worksurface
- Full-fill finish on wood group 1

Prices at right
 Prices at right
 No cost
 Prices at right

Specify wood color number.
 Specify wood color number.
 Specify *with Customiz stain*.
 ▶ See *Surface Materials Reference Manual*.
 Specify full-fill finish number.

Laminate worksurface

- Wood group 2 on case
- Wood group 3 on case
- Customiz stain on case
- High-Pressure Laminate price group 2
- Open Line laminate

Prices at right
 Prices at right
 No cost
 See information at left
 +\$ 69
 plus cost of laminate

Specify wood color number.
 Specify wood color number.
 Specify *with Customiz stain*.
 Specify High-Pressure Laminate color number.
 ▶ See *Surface Materials Reference Manual*.

Cable Management

- Round grommets
- Flip up power units

+\$ 74 each
 +\$326 each

Center: Specify *with EGRC* and color number.
 Center: Specify *with VPFC* and color number.

Lock and Keying

Lock

- Ember Chrome
- Polished Chrome

No cost
 No cost

Specify *with 9250 Ember Chrome lock*.
 Specify *with 9201 Polished Chrome lock*.

Keying

- Factory- and field-installed keying

▶ Page 622

Related Products

- Accessories

▶ Page 70

For laminate price group 2 pricing, please refer to the electronic catalog or SmartTools.

Specification Information										
Dimensions		Knee-space	Style Number	Base Prices		Options (Add \$ to Base Price)				
D	W			Wood Panels	Wood Work-surface	Laminate Work-surface	Wood	Wood	Wood	Wood
						Wood Case/ Wood Top	Wood Case/ Laminate Top	Wood Group 2	Wood Group 3	

Desk Returns—28⁵/₈" High

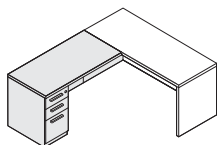

Left: two box and one file drawer

Left-Hand

30"	60"	45"	WLRD3060L	\$2554	\$2275	+\$285	+\$ 998	+\$216	+\$756	+\$69
30"	72"	57"	WLRD3072L	\$2727	\$2448	+\$344	+\$1201	+\$248	+\$866	+\$96

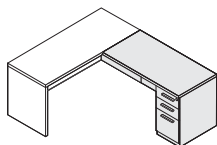

Right: two box and one file drawer

Right-Hand

30"	60"	45"	WLRD3060R	\$2554	\$2275	+\$285	+\$ 998	+\$216	+\$756	+\$69
30"	72"	57"	WLRD3072R	\$2727	\$2448	+\$344	+\$1201	+\$248	+\$866	+\$96

Returns

SIN 711.8

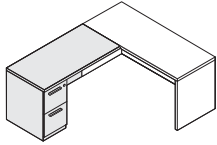

Tip: Return cannot be used freestanding.

Standard Includes	Required to Specify
<ul style="list-style-type: none"> Return case: wood group 1 Return worksurface: wood group 1 veneer or laminate price group 1 Full-height pedestals Full-height finished back panel Locks: keyed random One fastened metal filing system per file drawer: black only Leveling glides: black only Attachment hardware 	<ol style="list-style-type: none"> Style number Wood color number for return Laminate color number for worksurface, if selected Worksurface profile (see below under Required Selections) Pull shape (see below under Required Selections) Finish color number for pull Finish color number for lock Options, if selected (see below) <p>▶ See <i>Surface Materials</i>, page 154.</p>

Required Selections (No Additional Cost)

Worksurface Edge Profiles

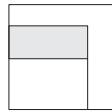

Square

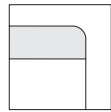

Bullnose

Pull Shape

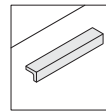

L

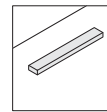

Line

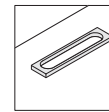

Loop

Options	Price	Required to Specify
Surface Materials Wood veneer worksurface <ul style="list-style-type: none"> Wood group 2 Wood group 3 Customiz stain on case and worksurface Full-fill finish on wood group 1 Laminate worksurface <ul style="list-style-type: none"> Wood group 2 on case Wood group 3 on case Customiz stain on case High-Pressure Laminate price group 2 Open Line laminate 	<ul style="list-style-type: none"> Prices at right Prices at right No cost Prices at right <hr/> <ul style="list-style-type: none"> Prices at right Prices at right No cost See information at left +\$ 69 plus cost of laminate 	<ul style="list-style-type: none"> Specify wood color number. Specify wood color number. Specify <i>with Customiz stain</i>. ▶ See <i>Surface Materials Reference Manual</i>. Specify full-fill finish number. <hr/> <ul style="list-style-type: none"> Specify wood color number. Specify wood color number. Specify <i>with Customiz stain</i>. Specify High-Pressure Laminate color number. ▶ See <i>Surface Materials Reference Manual</i>.
Back Panel <ul style="list-style-type: none"> Delete finished back panel 	<ul style="list-style-type: none"> Prices at right 	<ul style="list-style-type: none"> Specify <i>with no back panel</i>.
Cable Management <ul style="list-style-type: none"> Round grommets Flip up power units 	<ul style="list-style-type: none"> +\$ 74 each +\$326 each 	<ul style="list-style-type: none"> Center: Specify <i>with EGRC</i> and color number. Center: Specify <i>with VPFC</i> and color number.
Lock and Keying <ul style="list-style-type: none"> Lock <ul style="list-style-type: none"> Ember Chrome Polished Chrome Keying <ul style="list-style-type: none"> Factory- and field-installed keying 	<ul style="list-style-type: none"> No cost No cost 	<ul style="list-style-type: none"> Specify <i>with 9250 Ember Chrome lock</i>. Specify <i>with 9201 Polished Chrome lock</i>. <hr/> <ul style="list-style-type: none"> ▶ Page 622
Related Products <ul style="list-style-type: none"> Accessories 		<ul style="list-style-type: none"> ▶ Page 70

For laminate price group 2 pricing, please refer to the electronic catalog or SmartTools.

Specification Information

Dimensions		Knee-space	Style Number	Base Prices		Options (Add \$ to Base Price)							
D	W			Wood Panels	Wood Work-surface	Laminate Work-surface	Wood Case/ Wood Top	Wood Case/ Laminate Top	Wood	Wood	Wood	Wood	Full-Fill Finish on Wood Group 1

Returns—28⁵/₈" High

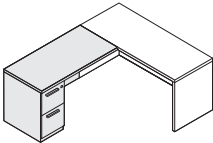

Left: two file drawers

Left-Hand											
D	W	Depth	Style Number	Base Price 1	Base Price 2	Option 1	Option 2	Option 3	Option 4	Option 5	Option 6
24"	42"	27"	WLRT2442L	\$1981	\$1856	+\$212	+\$ 742	+\$165	+\$578	+\$47	-\$410
24"	48"	33"	WLRT2448L	\$2046	\$1921	+\$212	+\$ 742	+\$165	+\$578	+\$47	-\$441
24"	72"	57"	WLRT2472L	\$2305	\$2071	+\$293	+\$1030	+\$224	+\$788	+\$69	-\$566

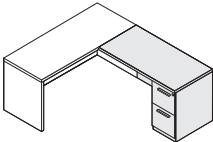

Right: two file drawers

Right-Hand											
D	W	Depth	Style Number	Base Price 1	Base Price 2	Option 1	Option 2	Option 3	Option 4	Option 5	Option 6
24"	42"	27"	WLRT2442R	\$1981	\$1856	+\$212	+\$ 742	+\$165	+\$578	+\$47	-\$410
24"	48"	33"	WLRT2448R	\$2046	\$1921	+\$212	+\$ 742	+\$165	+\$578	+\$47	-\$441
24"	72"	57"	WLRT2472R	\$2305	\$2071	+\$293	+\$1030	+\$224	+\$788	+\$69	-\$566

Bridges

SIN 711.8

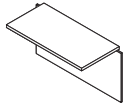

Tip: Ships knocked down.

Tip: Modesty panel is 6" longer than the worksurface width.

Tip: Specify bridge with no back panel when connecting to a corner unit.

Standard Includes	Required to Specify
-------------------	---------------------

- Bridge: wood group 1
- Full-height finished back panel
- Attachment hardware

- 1 Style number
 - 2 Wood color number for bridge
 - 3 Laminate color number for worksurface, if selected
 - 4 Worksurface profile (see below under Required Selections)
 - 5 Options, if selected (see below)
- ▶ See *Surface Materials*, page 154.

Required Selections (No Additional Cost)
--

Worksurface Edge Profiles

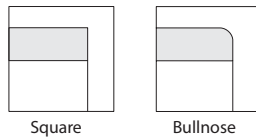

Options	Price	Required to Specify
---------	-------	---------------------

Surface Materials

Wood veneer worksurface

- Wood group 2 Prices below
- Wood group 3 Prices below
- Customiz stain on worksurface and panel No cost
- Full-fill finish on wood group 1 Prices below

Specify wood color number.
Specify wood color number.
Specify *with Customiz stain*.
▶ See *Surface Materials Reference Manual*.
Specify full-fill finish number.

Laminate worksurface

- Wood group 2 on panel Prices below
- Wood group 3 on panel Prices below
- Customiz stain on panel No cost
- High-Pressure Laminate price group 2 See information at left
- Open Line laminate +\$ 69 plus cost of laminate

Specify wood color number.
Specify wood color number.
Specify *with Customiz stain*.
Specify High-Pressure Laminate color number.
▶ See *Surface Materials Reference Manual*.

Back Panel

- Delete finished back panel Prices below

Specify *with no back panel*.

Cable Management

- Round grommets +\$ 74 each
- Flip up power units +\$326 each

Center: Specify *with EGRC* and color number.
Center: Specify *with VPFC* and color number.

Related Products

- Accessories

▶ Page 70

For laminate price group 2 pricing, please refer to the electronic catalog or SmartTools.

Specification Information										
---------------------------	--	--	--	--	--	--	--	--	--	--

Dimensions		Style Number	Base Prices		Options (Add \$ to Base Price)					
D	W		Wood Panels	Laminate Work-surface	Wood				Full-Fill Finish on Wood Group 1	No Back Panel
.....

Bridges—28⁵/₈" High

24"	42"	WLGG2442	\$ 942	\$817	+\$116	+\$406	+\$69	+\$242	+\$47	-\$254
24"	48"	WLGG2448	\$1008	\$883	+\$143	+\$499	+\$96	+\$335	+\$47	-\$286

Modesty Panels

SIN 711.8

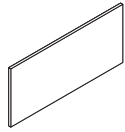

Tip: Specify modesty panel 12" shorter than worksurface it is being applied on.

For laminate price group 2 pricing, please refer to the electronic catalog or SmartTools.

Standard Includes		Required to Specify	
<ul style="list-style-type: none"> Modesty panel: wood group 1 or laminate price group 1 Attachment hardware 		<ul style="list-style-type: none"> 1 Style number 2 Wood or laminate color number for modesty panel 3 Options, if selected (see below) ▶ See <i>Surface Materials</i>, page 154. 	
Surface Materials	Options	Price	Required to Specify
	<ul style="list-style-type: none"> Wood group 2 Wood group 3 Customiz stain on wood High-Pressure Laminate price group 2 Open Line laminate 	<ul style="list-style-type: none"> Prices below Prices below No cost See information at left +\$69 plus cost of laminate 	<ul style="list-style-type: none"> Specify wood color number. Specify wood color number. Specify <i>with Customiz stain</i>. Specify High-Pressure Laminate color number. ▶ See <i>Surface Materials Reference Manual</i>.
Related Products	<ul style="list-style-type: none"> Table desk 		▶ Page 32

Specification Information						
Dimensions		Style Number	Base Prices		Options (Add \$ to Base Price)	
W	H		Wood Group 1	Laminate	Wood Group 2	Wood Group 3
30"	18"	WLN3018	\$ 470	\$ 426	+\$ 69	+\$242
36"	18"	WLN3618	\$ 503	\$ 459	+\$ 69	+\$242
42"	18"	WLN4218	\$ 543	\$ 499	+\$ 69	+\$242
48"	18"	WLN4818	\$ 587	\$ 543	+\$ 69	+\$242
54"	18"	WLN5418	\$ 633	\$ 589	+\$ 69	+\$242
60"	18"	WLN6018	\$ 682	\$ 638	+\$ 96	+\$335
66"	18"	WLN6618	\$ 726	\$ 644	+\$ 96	+\$335
78"	18"	WLN7818	\$1006	\$ 924	+\$124	+\$436
84"	18"	WLN8418	\$1074	\$ 992	+\$124	+\$436
90"	18"	WLN9018	\$1148	\$1066	+\$124	+\$436

Corner Unit

SIN 711.8

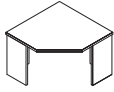

Tip: The front three edges of a laminate worksurface will have solid wood edge nosing. This edge molding will always match the wood color that is specified; therefore, it could be different than the laminate color.

Tip: Must be attached to a bridge or return for stability. Cannot be used freestanding.

Standard Includes

- Corner unit panels: wood group 1
- Corner worksurface: wood group 1 veneer or laminate price group 1
- Leveling glides: black only

Required to Specify

- 1 Style number
 - 2 Wood color number for corner unit
 - 3 Laminate color number for worksurface, if selected
 - 4 Worksurface edge profile (see below under Required Selections)
 - 5 Options, if selected (see below)
- ▶ See *Surface Materials*, page 154.

Required Selections (No Additional Cost)

Worksurface Edge Profiles

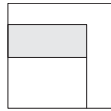

Square

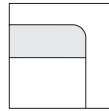

Bullnose

Options

Options	Price	Required to Specify
Surface Materials <ul style="list-style-type: none"> • Wood veneer worksurface <ul style="list-style-type: none"> • Wood group 2 • Wood group 3 • Customiz stain on panels and worksurface • Full-fill finish on wood group 1 • Laminate worksurface <ul style="list-style-type: none"> • Wood group 2 on panels • Wood group 3 on panels • Customiz stain on panels • High-Pressure Laminate price group 2 • Open Line laminate 	<ul style="list-style-type: none"> Prices below Prices below No cost Prices below <hr/> <ul style="list-style-type: none"> Prices below Prices below No cost See information at left +\$ 69 plus cost of laminate 	<ul style="list-style-type: none"> Specify wood color number. Specify wood color number. Specify <i>with Customiz stain</i>. ▶ See <i>Surface Materials Reference Manual</i>. Specify full-fill finish number. <hr/> <ul style="list-style-type: none"> Specify wood color number. Specify wood color number. Specify <i>with Customiz stain</i>. Specify High-Pressure Laminate color number. ▶ See <i>Surface Materials Reference Manual</i>.
Back Panel <ul style="list-style-type: none"> • Delete finished back panel 	<ul style="list-style-type: none"> Prices below 	<ul style="list-style-type: none"> Specify <i>with no back panel</i>.
Cable Management <ul style="list-style-type: none"> • Round grommets • Flip up power units 	<ul style="list-style-type: none"> +\$ 74 each +\$326 each 	<ul style="list-style-type: none"> Center: Specify <i>with EGRC</i> and color number. Center: Specify <i>with VPFC</i> and color number.
Related Products <ul style="list-style-type: none"> • Accessories 		<ul style="list-style-type: none"> ▶ Page 70

For laminate price group 2 pricing, please refer to the electronic catalog or SmartTools.

Specification Information

Dimensions D W	Style Number	Base Prices	Options (Add \$ to Base Price)							
			Wood Panels		Wood				Full-Fill	No
			Wood Work-surface	Laminate Work-surface	Wood Panel/ Wood Top	Wood Panel/ Laminate Top	Wood	Wood	Finish on Wood Group 1	Back Panel
					Wood Group 2	Wood Group 3	Wood Group 2	Wood Group 3		

Corner Unit—28⁵/₈" High

24"	42"	WLUC4242242	\$1993	\$1785	+\$94	+\$328	+\$47	+\$164	+\$47	-\$569
-----	-----	--------------------	--------	--------	-------	--------	-------	--------	-------	--------



Full Storage Credenzas

SIN 711.8

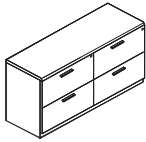

Standard Includes	Required to Specify
<ul style="list-style-type: none"> • Credenza case: wood group 1 • Credenza worksurface: wood group 1 veneer or laminate price group 1 • Full-height pedestals • Full-height finished back panel • Locks: keyed random • One pencil tray per box/box/file pedestal: black plastic • One fastened metal filing system per file drawer: black only • Leveling glides: black only 	<ol style="list-style-type: none"> 1 Style number 2 Wood color number for credenza 3 Laminate color number for worksurface, if selected 4 Worksurface profile (see below under Required Selections) 5 Pull shape (see below under Required Selections) 6 Finish color number for pull 7 Finish color number for lock 8 Options, if selected (see below) <p>▶ See <i>Surface Materials</i>, page 154.</p>

Required Selections (No Additional Cost)

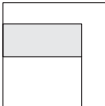
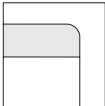
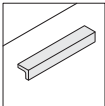
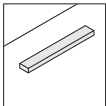
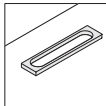
Worksurface Edge Profiles	Pull Shape
<div style="display: flex; justify-content: space-around;"> <div style="text-align: center;">  <p>Square</p> </div> <div style="text-align: center;">  <p>Bullnose</p> </div> </div>	<div style="display: flex; justify-content: space-around;"> <div style="text-align: center;">  <p>L</p> </div> <div style="text-align: center;">  <p>Line</p> </div> <div style="text-align: center;">  <p>Loop</p> </div> </div>

Options	Price	Required to Specify
<p>Surface Materials</p> <p>Wood veneer worksurface</p> <ul style="list-style-type: none"> • Wood group 2 • Wood group 3 • Customiz stain on case and worksurfaces • Full-fill finish on wood group 1 <p>Laminate worksurface</p> <ul style="list-style-type: none"> • Wood group 2 on case • Wood group 3 on case • Customiz stain on case • High-Pressure Laminate price group 2 • Open Line laminate 	<p>Prices at right</p> <p>Prices at right</p> <p>No cost</p> <p>Prices at right</p> <hr/> <p>Prices at right</p> <p>Prices at right</p> <p>No cost</p> <p>See information at left</p> <p>+\$ 69 plus cost of laminate</p>	<p>Specify wood color number.</p> <p>Specify wood color number.</p> <p>Specify <i>with Customiz stain</i>.</p> <p>▶ See <i>Surface Materials Reference Manual</i>.</p> <p>Specify full-fill finish number.</p> <hr/> <p>Specify wood color number.</p> <p>Specify wood color number.</p> <p>Specify <i>with Customiz stain</i>.</p> <p>Specify High-Pressure Laminate color number.</p> <p>▶ See <i>Surface Materials Reference Manual</i>.</p>
<p>Back Panel</p> <ul style="list-style-type: none"> • Delete finished back panel 	<p>Prices at right</p>	<p>Specify <i>with no back panel</i>.</p>
<p>Cable Management</p> <ul style="list-style-type: none"> • Round grommets • Flip up power units • Scallop 	<p>+\$ 74 each</p> <p>+\$326 each</p> <p>+\$ 39 each</p>	<p>Left: Specify <i>with EGRL</i> and color number.</p> <p>Center: Specify <i>with EGRC</i> and color number.</p> <p>Right: Specify <i>with EGRR</i> and color number.</p> <p>Left: Specify <i>with VPFL</i> and color number.</p> <p>Center: Specify <i>with VPFC</i> and color number.</p> <p>Right: Specify <i>with VPFR</i> and color number.</p> <p>Specify <i>with scallop</i>.</p>
<p>Counterweight Package</p> <ul style="list-style-type: none"> • Add counterweight package • Omit counterweight package 	<p>No cost</p> <p>-\$ 65</p>	<p>Specify <i>with counterweight package</i>.</p> <p>Specify <i>with no counterweight package</i>.</p>
<p>Lock and Keying</p> <p>Lock</p> <ul style="list-style-type: none"> • Ember Chrome • Polished Chrome <p>Keying</p> <ul style="list-style-type: none"> • Factory- and field-installed keying 	<p>No cost</p> <p>No cost</p>	<p>Specify <i>with 9250 Ember Chrome lock</i>.</p> <p>Specify <i>with 9201 Polished Chrome lock</i>.</p> <p>▶ Page 622</p>
<p>Related Products</p> <ul style="list-style-type: none"> • Accessories 		<p>▶ Page 70</p>

For laminate price group 2 pricing, please refer to the electronic catalog or SmartTools.

Tip: In certain pedestal credenza configurations, the center grommet could be unusable.

Tip: See Application Topics for counterweight rules.

Specification Information

• Dimensions		• Style Number	• Base Prices		• Options (Add \$ to Base Price)					
D	W		Wood Panels	Wood Work-surface	Wood	Wood	Wood	Wood	Full-Fill Finish on Wood Group 1	No Back Panel
			Wood	Laminate	Wood Panel/ Wood Top	Wood Panel/ Laminate Top	Wood Group 2	Wood Group 3		

Credenzas—28⁵/₈" High

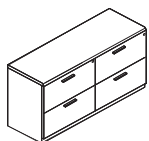

Lateral File/Lateral File

24"	60"	WLCZ2460A	\$3896	\$3662	+\$368	+\$1289	+\$299	+\$1047	+\$69	-\$418
24"	72"	WLCZ2472A	\$4641	\$4407	+\$437	+\$1529	+\$368	+\$1287	+\$69	-\$473

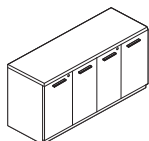

Hinged Doors/Hinged Doors

24"	60"	WLCZ2460B	\$3984	\$3750	+\$368	+\$1289	+\$299	+\$1047	+\$69	-\$418
24"	72"	WLCZ2472B	\$4582	\$4348	+\$399	+\$1396	+\$330	+\$1154	+\$69	-\$473

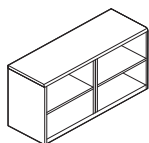

Open/Open

24"	60"	WLCZ2460C	\$3294	\$3060	+\$332	+\$1162	+\$263	+\$ 920	+\$69	-\$418
24"	72"	WLCZ2472C	\$3560	\$3326	+\$362	+\$1272	+\$293	+\$1030	+\$69	-\$473

► Specification Information, continued on next page

Full Storage Credenzas, continued

SIN 711.8

► Specification Information, continued from previous page

Specification Information											
Dimensions		Style Number	Base Prices		Options (Add \$ to Base Price)						
D	W		Wood Panels	Wood Work-surface	Laminate Work-surface	Wood	Wood	Wood	Wood	Full-Fill Finish on Wood Group 1	No Back Panel
			Wood	Wood	Wood	Wood	Wood	Wood	Wood		
			Group 2	Group 2	Group 2	Group 3	Group 2	Group 3	Group 3		

Credenzas—28⁵/₈" High

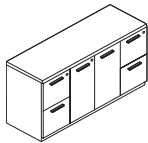

Pedestal/Hinged Doors/Pedestal

24"	60"	WLCZ2460D	\$4604	\$4370	+\$419	+\$1467	+\$350	+\$1225	+\$69	-\$418
24"	66"	WLCZ2466D	\$4898	\$4664	+\$419	+\$1467	+\$350	+\$1225	+\$69	-\$446
24"	72"	WLCZ2472D	\$4968	\$4734	+\$419	+\$1467	+\$350	+\$1225	+\$69	-\$473
24"	90"	WLCZ2490D	\$6681	\$6367	+\$606	+\$2122	+\$537	+\$1880	+\$69	-\$624



Pedestal/Lateral File/Pedestal

24"	60"	WLCZ2460E	\$4561	\$4327	+\$419	+\$1467	+\$350	+\$1225	+\$69	-\$418
24"	66"	WLCZ2466E	\$4928	\$4694	+\$419	+\$1467	+\$350	+\$1225	+\$69	-\$446
24"	90"	WLCZ2490E	\$6591	\$6277	+\$606	+\$2122	+\$537	+\$1880	+\$69	-\$624



Kneespace Credenzas

SIN 711.8

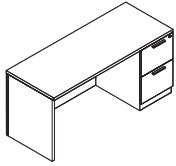

Tip: 102"W Credenzas will ship knocked down.

Standard Includes	Required to Specify
<ul style="list-style-type: none"> • Credenza case: wood group 1 • Credenza worksurface: wood group 1 veneer or laminate price group 1 • Full-height pedestals • Full-height finished back panel • Locks: keyed random • One pencil tray per box/box/file pedestal: black plastic • One fastened metal filing system per file drawer: black only • Leveling glides: black only 	<ol style="list-style-type: none"> 1 Style number 2 Wood color number for credenza 3 Laminate color number for worksurface, if selected 4 Worksurface profile (see below under Required Selections) 5 Pull shape (see below under Required Selections) 6 Finish color number for pull 7 Finish color number for lock 8 Options, if selected (see below) <p>▶ See <i>Surface Materials</i>, page 154.</p>

Required Selections (No Additional Cost)

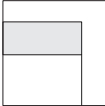
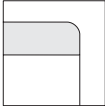
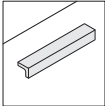
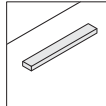
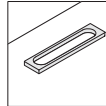
Worksurface Edge Profiles	Pull Shape
<div style="display: flex; justify-content: space-around;"> <div style="text-align: center;">  <p>Square</p> </div> <div style="text-align: center;">  <p>Bullnose</p> </div> </div>	<div style="display: flex; justify-content: space-around;"> <div style="text-align: center;">  <p>L</p> </div> <div style="text-align: center;">  <p>Line</p> </div> <div style="text-align: center;">  <p>Loop</p> </div> </div>

Options	Price	Required to Specify
<p>Surface Materials</p> <p>Wood veneer worksurface</p> <ul style="list-style-type: none"> • Wood group 2 • Wood group 3 • Customiz stain on case and worksurface • Full-fill finish on wood group 1 <p>Laminate worksurface</p> <ul style="list-style-type: none"> • Wood group 2 on case • Wood group 3 on case • Customiz stain on case • High-Pressure Laminate price group 2 • Open Line laminate 	<p>Prices at right</p> <p>Prices at right</p> <p>No cost</p> <p>Prices at right</p> <hr/> <p>Prices at right</p> <p>Prices at right</p> <p>No cost</p> <p>See information at left</p> <p>+\$ 69 plus cost of laminate</p>	<p>Specify wood color number.</p> <p>Specify wood color number.</p> <p>Specify <i>with Customiz stain</i>.</p> <p>▶ See <i>Surface Materials Reference Manual</i>. Specify full-fill finish number.</p> <hr/> <p>Specify wood color number.</p> <p>Specify wood color number.</p> <p>Specify <i>with Customiz stain</i>.</p> <p>Specify High-Pressure Laminate color number.</p> <p>▶ See <i>Surface Materials Reference Manual</i>.</p>
<p>Back Panel</p> <ul style="list-style-type: none"> • Delete finished back panel 	<p>Prices at right</p>	<p>Specify <i>with no back panel</i>.</p>
<p>Cable Management</p> <ul style="list-style-type: none"> • Round grommets • Flip up power units • Scallop 	<p>+\$ 74 each</p> <p>+\$326 each</p> <p>+\$ 39 each</p>	<p>Left: Specify <i>with EGRL</i> and color number.</p> <p>Center: Specify <i>with EGRC</i> and color number.</p> <p>Right: Specify <i>with EGRR</i> and color number.</p> <p>Left: Specify <i>with VPFL</i> and color number.</p> <p>Center: Specify <i>with PFC</i> and color number.</p> <p>Right: Specify <i>with VPFR</i> and color number.</p> <p>Specify <i>with scallop</i>.</p>
<p>Counterweight Package</p> <ul style="list-style-type: none"> • Add counterweight package • Omit counterweight package 	<p>No cost</p> <p>-\$ 65</p>	<p>Specify <i>with counterweight package</i>.</p> <p>Specify <i>with no counterweight package</i>.</p>
<p>Lock and Keying</p> <p>Lock</p> <ul style="list-style-type: none"> • Ember Chrome • Polished Chrome <p>Keying</p> <ul style="list-style-type: none"> • Factory- and field-installed keying 	<p>No cost</p> <p>No cost</p>	<p>Specify <i>with 9250 Ember Chrome lock</i>.</p> <p>Specify <i>with 9201 Polished Chrome lock</i>.</p> <p>▶ Page 622</p>
<p>Related Products</p> <ul style="list-style-type: none"> • Accessories 		<p>▶ Page 70</p>

For laminate price group 2 pricing, please refer to the electronic catalog or SmartTools.

Tip: See Application Topics for counterweight rules.

Specification Information

Dimensions		Knee-space	Style Number	Base Prices		Options (Add \$ to Base Price)					
D	W			Wood Panels	Wood Work-surface	Laminate Work-surface	Wood	Wood	Wood	Wood	Full-Fill Finish on Wood Group 1
						Wood Case/ Wood Top	Wood Case/ Laminate Top	Wood Group 2	Wood Group 3		

Credenzas—28⁵/₈" High

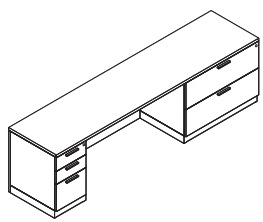

Pedestal/Kneewell/Lateral File

24"	90"	45"	WLCZ2490J	\$4395	\$4081	+\$454	+\$1591	+\$385	+\$1349	+\$69	-\$624
24"	96"	51"	WLCZ2496J	\$4552	\$4238	+\$454	+\$1591	+\$385	+\$1349	+\$69	-\$663
24"	102"	51"	WLCZ24102J	\$4723	\$4409	+\$481	+\$1684	+\$385	+\$1349	+\$96	-\$703

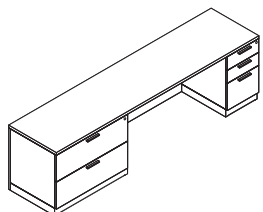

Lateral File/Kneewell/Pedestal

24"	90"	45"	WLCZ2490K	\$4395	\$4081	+\$454	+\$1591	+\$385	+\$1349	+\$69	-\$624
24"	96"	51"	WLCZ2496K	\$4552	\$4238	+\$454	+\$1591	+\$385	+\$1349	+\$69	-\$663
24"	102"	51"	WLCZ24102K	\$4723	\$4409	+\$481	+\$1684	+\$385	+\$1349	+\$96	-\$703

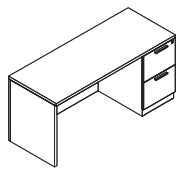

Kneewell/Pedestal

24"	60"	43 ⁷ / ₈ "	WLCZ2460L	\$2344	\$2110	+\$311	+\$1085	+\$242	+\$ 843	+\$69	-\$418
24"	66"	49 ⁷ / ₈ "	WLCZ2466L	\$2408	\$2174	+\$311	+\$1085	+\$242	+\$ 843	+\$69	-\$446
24"	72"	55 ⁷ / ₈ "	WLCZ2472L	\$2475	\$2241	+\$341	+\$1194	+\$272	+\$ 952	+\$69	-\$473

► **Specification Information, continued on next page**

Tip: Single pedestal credenzas with no back panel may not be used freestanding and must be attached to a bridge, return, desk return, or run-off top. Single pedestal credenzas without back panel may be used freestanding if a service module is placed on a credenza. Single pedestal credenzas with back panel may be used freestanding.

Kneespace Credenzas, continued

SIN 711.8

► Specification Information, continued from previous page

Specification Information

• Dimensions		• Knee-space	• Style Number	• Base Prices		• Options (Add \$ to Base Price)						
D	W			Wood Panels	Wood Work-surface	Laminate Work-surface	Wood Case/ Wood Top	Wood Case/ Laminate Top	Wood	Wood	Wood	Wood

Credenzas—28⁵/₈" High

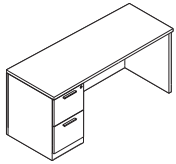

Pedestal/Kneewell

24"	60"	43 ⁷ / ₈ "	WLCZ2460M	\$2344	\$2110	+\$311	+\$1085	+\$242	+\$ 843	+\$69	-\$418
24"	66"	49 ⁷ / ₈ "	WLCZ2466M	\$2408	\$2174	+\$311	+\$1085	+\$242	+\$ 843	+\$69	-\$446
24"	72"	55 ⁷ / ₈ "	WLCZ2472M	\$2475	\$2241	+\$341	+\$1194	+\$272	+\$ 952	+\$69	-\$473

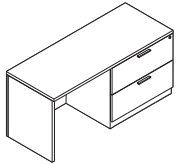

Kneewell/Lateral File

24"	60"	28 ⁷ / ₈ "	WLCZ2460N	\$2727	\$2493	+\$327	+\$1147	+\$258	+\$ 905	+\$69	-\$418
24"	72"	34 ⁷ / ₈ "	WLCZ2472N	\$2790	\$2556	+\$327	+\$1147	+\$258	+\$ 905	+\$69	-\$473
24"	90"	58 ⁷ / ₈ "	WLCZ2490N	\$3167	\$2853	+\$358	+\$1256	+\$289	+\$1014	+\$69	-\$624

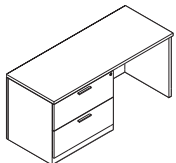

Lateral File/Kneewell

24"	60"	28 ⁷ / ₈ "	WLCZ2460P	\$2727	\$2493	+\$327	+\$1147	+\$258	+\$ 905	+\$69	-\$418
24"	72"	34 ⁷ / ₈ "	WLCZ2472P	\$2790	\$2556	+\$327	+\$1147	+\$258	+\$ 905	+\$69	-\$473
24"	90"	58 ⁷ / ₈ "	WLCZ2490P	\$3167	\$2853	+\$358	+\$1256	+\$289	+\$1014	+\$69	-\$624

► Specification Information, continued on next page

Tip: Single pedestal credenzas with no back panel may not be used freestanding and must be attached to a bridge, return, desk return, or run-off top. Single pedestal credenzas without back panel may be used freestanding if a service module is placed on a credenza. Single pedestal credenzas with back panel may be used freestanding.

► Specification Information, continued from previous page

Specification Information																						
Dimensions D	W	Knee-space	Style Number	Base Prices		Options (Add \$ to Base Price)																
				Wood Panels	Wood Work-surface	Laminate Work-surface	Wood Case/ Wood Top	Wood Case/ Laminate Top	Wood	Wood	Wood	Wood	Full-Fill Finish on Wood Group 1	No Back Panel								
.

Credenzas—28⁵/₈" High

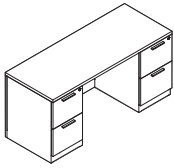

Pedestal/Kneewell/Pedestal												
D	W	Space	Style Number	Base Price 1	Base Price 2	Option 1	Option 2	Option 3	Option 4	Option 5	Option 6	Option 7
24"	60"	30"	WLCZ2460R	\$3129	\$2895	+\$254	+\$ 889	+\$185	+\$ 647	+\$69	-\$418	
24"	66"	36"	WLCZ2466R	\$3191	\$2957	+\$332	+\$1162	+\$263	+\$ 920	+\$69	-\$446	
24"	72"	42"	WLCZ2472R	\$3261	\$3027	+\$362	+\$1272	+\$293	+\$1030	+\$69	-\$473	
.

Shell Credenzas

SIN 711.8

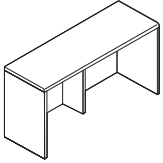

Tip: Ships knocked down.

Standard Includes	Required to Specify
<ul style="list-style-type: none"> • Credenza case: wood group 1 • Credenza worksurface: wood group 1 veneer or laminate price group 1 • Full-height finished back panel • Locks: keyed random • Leveling glides: black only 	<ol style="list-style-type: none"> 1 Style number 2 Wood color number for credenza 3 Laminate color number for worksurface, if selected 4 Worksurface profile (see below under Required Selections) 5 Options, if selected (see below) <p>▶ See <i>Surface Materials</i>, page 154.</p>

Required Selections (No Additional Cost)

Worksurface Edge Profiles

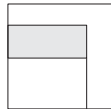

Square

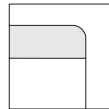

Bullnose

Options	Price	Required to Specify
<p>Surface Materials</p> <p>Wood veneer worksurface</p> <ul style="list-style-type: none"> • Wood group 2 • Wood group 3 • Customiz stain on case and worksurface • Full-fill finish on wood group 1 <hr/> <p>Laminate worksurface</p> <ul style="list-style-type: none"> • Wood group 2 on case • Wood group 3 on case • Customiz stain on case • High-Pressure Laminate price group 2 • Open Line laminate 	<p>Prices at right</p> <p>Prices at right</p> <p>No cost</p> <p>Prices at right</p> <hr/> <p>Prices at right</p> <p>Prices at right</p> <p>No cost</p> <p>See information at left</p> <p>+\$ 69 plus cost of laminate</p>	<p>Specify wood color number.</p> <p>Specify wood color number.</p> <p>Specify <i>with Customiz stain</i>.</p> <p>▶ See <i>Surface Materials Reference Manual</i>.</p> <p>Specify full-fill finish number.</p> <hr/> <p>Specify wood color number.</p> <p>Specify wood color number.</p> <p>Specify <i>with Customiz stain</i>.</p> <p>Specify High-Pressure Laminate color number.</p> <p>▶ See <i>Surface Materials Reference Manual</i>.</p>
<p>Back Panel</p> <ul style="list-style-type: none"> • Delete finished back panel 	<p>Prices at right</p>	<p>Specify <i>with no back panel</i>.</p>
<p>Cable Management</p> <ul style="list-style-type: none"> • Round grommets • Flip up power units • Scallop 	<p>+\$ 74 each</p> <p>+\$326 each</p> <p>+\$ 39 each</p>	<p>Left: Specify <i>with EGRL</i> and color number.</p> <p>Center: Specify <i>with EGRC</i> and color number.</p> <p>Right: Specify <i>with EGRR</i> and color number.</p> <p>Left: Specify <i>with VPFL</i> and color number.</p> <p>Center: Specify <i>with VPFC</i> and color number.</p> <p>Right: Specify <i>with VPRF</i> and color number.</p> <p>Specify <i>with scallop</i>.</p>
<p>Related Products</p> <ul style="list-style-type: none"> • Accessories 		<p>▶ Page 70</p>

For laminate price group 2 pricing, please refer to the electronic catalog or SmartTools.

Specification Information

• Dimensions		• Style Number	• Base Prices		• Options (Add \$ to Base Price)							
D	W		Wood Panels		Wood				Full-Fill	No		
			Wood	Laminate	Wood Panel/ Wood Top	Wood Panel/ Laminate Top	Wood	Wood	Wood	Wood	Finish on Wood Group 1	Back Panel
			Work- surface	Work- surface	Wood Group 2	Wood Group 3	Wood Group 2	Wood Group 3				

Credenzas—28⁵/₈" High

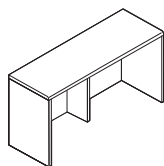

Shells

24"	72"	WLCZ2472F	\$1916	\$1682	+\$319	+\$1116	+\$250	+\$ 874	+\$69	-\$473
24"	96"	WLCZ2496F	\$2543	\$2229	+\$393	+\$1374	+\$324	+\$1132	+\$69	-\$663
24"	102"	WLCZ24102F	\$2714	\$2400	+\$420	+\$1467	+\$324	+\$1132	+\$96	-\$703
:	:	:	:	:	:	:	:	:	:	:

Mobile Pedestal

SIN 711.8

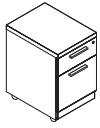

Standard Includes	Required to Specify
<ul style="list-style-type: none"> • Mobile pedestal: wood group 1 • Wood group 1 top with veneer square edge • Lock: keyed random • One pencil tray per mobile pedestal: black plastic • One fastened metal filing system per file drawer: black only • Counterweight package installed • Four non-locking casters: black plastic only 	<ol style="list-style-type: none"> 1 Style number 2 Wood color number for mobile pedestal 3 Pull shape (see below under Required Selections) 4 Finish color number for pull 5 Finish color number for lock 6 Options, if selected (see below) <p>▶ See <i>Surface Materials</i>, page 154.</p>

Required Selections (No Additional Cost)

Pull Shape

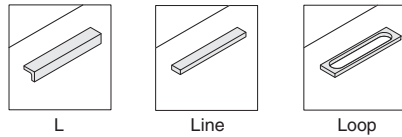

Options	Price	Required to Specify
Surface Materials <ul style="list-style-type: none"> • Wood group 2 • Wood group 3 • Customiz stain on wood 	Prices below Prices below No cost	Specify wood color number. Specify wood color number. Specify <i>with Customiz stain</i> . ▶ See <i>Surface Materials Reference Manual</i> .
Lock and Keying	Lock <ul style="list-style-type: none"> • Ember Chrome • Polished Chrome 	No cost No cost Specify <i>with 9250 Ember Chrome lock</i> . Specify <i>with 9201 Polished Chrome lock</i> .
	Keying <ul style="list-style-type: none"> • Factory- and field-installed keying 	▶ Page 622
Related Products	<ul style="list-style-type: none"> • Accessories 	▶ Page 70

Specification Information

Dimensions			Style	Base	Options
D	W	H	Number	Price	(Add \$ to Base Price)
22	15	23	WLPM201523	\$1146	+\$69
					+\$242

Mobile Pedestal

Dimensions	Style Number	Base Price	Options
22 3/4" x 15 1/2" x 23"	WLPM201523	\$1146	+\$69 +\$242



Lateral Files—Freestanding 2-High

SIN 711.8

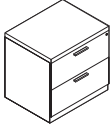

Standard Includes	Required to Specify
<ul style="list-style-type: none"> Lateral file: wood group 1 Profiled worksurface top Full-height finished back panel Locks: keyed random One fastened metal filing system per file drawer: black only Leveling glides: black only Counterweight package shipped separately 	<ol style="list-style-type: none"> Style number Wood color number for lateral file Worksurface profile (see below under Required Selections) Pull shape (see below under Required Selections) Finish color number for pull Finish color number for lock Options, if selected (see below) <p>▶ See <i>Surface Materials</i>, page 154.</p>

Required Selections (No Additional Cost)

Worksurface Edge Profiles

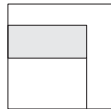

Square

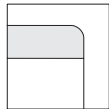

Bullnose

Pull Shape

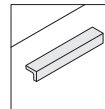

L

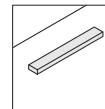

Line

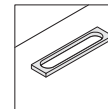

Loop

Options	Price	Required to Specify
Surface Materials <ul style="list-style-type: none"> Wood veneer worksurface <ul style="list-style-type: none"> Wood group 2 Wood group 3 Customiz stain on case and worksurface Full-fill finish on wood group 1 Laminate worksurface <ul style="list-style-type: none"> Wood group 2 on case Wood group 3 on case Customiz stain on case High-Pressure Laminate price group 2 Open Line laminate 	<ul style="list-style-type: none"> Prices at right Prices at right No cost Prices at right <hr/> <ul style="list-style-type: none"> Prices at right Prices at right No cost See information at left +\$69 plus cost of laminate 	<ul style="list-style-type: none"> Specify wood color number. Specify wood color number. Specify <i>with Customiz stain</i>. ▶ See <i>Surface Materials Reference Manual</i>. Specify full-fill finish number. <hr/> <ul style="list-style-type: none"> Specify wood color number. Specify wood color number. Specify <i>with Customiz stain</i>. Specify High-Pressure Laminate color number. ▶ See <i>Surface Materials Reference Manual</i>.
Back Panel <ul style="list-style-type: none"> Delete finished back panel 	<ul style="list-style-type: none"> Prices at right 	<ul style="list-style-type: none"> Specify <i>with no back panel</i>.
Lock and Keying <ul style="list-style-type: none"> Lock <ul style="list-style-type: none"> Ember Chrome Polished Chrome Keying <ul style="list-style-type: none"> Factory- and field-installed keying 	<ul style="list-style-type: none"> No cost No cost 	<ul style="list-style-type: none"> Specify <i>with 9250 Ember Chrome lock</i>. Specify <i>with 9201 Polished Chrome lock</i>. <hr/> <ul style="list-style-type: none"> ▶ Page 622
Related Products <ul style="list-style-type: none"> Accessories 		<ul style="list-style-type: none"> ▶ Page 70

For laminate price group 2 pricing, please refer to the electronic catalog or SmartTools.

Specification Information

• Dimensions		• Style Number	• Base Prices		• Options (Add \$ to Base Price)					
D	W		Wood Panels	Wood Work-surface	Laminate Work-surface	Wood Panel/ Wood Top	Wood Panel/ Laminate Top	Full-Fill Finish on Wood Group 1	No Back Panel	
					Wood Group 2	Wood Group 3	Wood Group 2	Wood Group 3		

Lateral Files—28⁵/₈" High

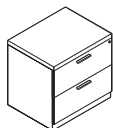

With Two Drawers

24"	30"	WLLF243028T	\$2535	\$2325	+\$185	+\$640	+\$157	+\$546	+\$29	-\$344
24"	36"	WLLF243628T	\$2649	\$2439	+\$204	+\$710	+\$157	+\$546	+\$47	-\$376

Lateral Files—Freestanding 4-High

SIN 711.8



Standard Includes	Required to Specify
-------------------	---------------------

<ul style="list-style-type: none"> • Lateral file: wood group 1 • Finished, inset top • Finished back panel • Locks: keyed random • One fastened metal filing system per file drawer: black only • Leveling glides: black only • Counterweight package shipped separately 	<ul style="list-style-type: none"> 1 Style number 2 Wood color number for lateral file 3 Pull shape (see below under Required Selections) 4 Finish color number for pull 5 Finish color number for lock 6 Options, if selected (see below) ▶ See <i>Surface Materials</i>, page 154.
--	---

Required Selections (No Additional Cost)
--

Pull Shape

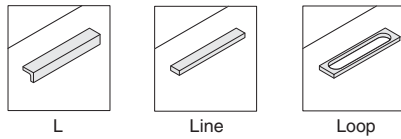

Options	Price	Required to Specify
---------	-------	---------------------

<p>Surface Materials</p> <ul style="list-style-type: none"> • Wood group 2 • Wood group 3 • Customiz stain on wood 	<p>Prices below Prices below No cost</p>	<p>Specify wood color number. Specify wood color number. Specify <i>with Customiz stain</i>. ▶ See <i>Surface Materials Reference Manual</i>.</p>
<p>Lock and Keying</p> <p>Lock</p> <ul style="list-style-type: none"> • Ember Chrome • Polished Chrome <p>Keying</p> <ul style="list-style-type: none"> • Factory- and field-installed keying 	<p>No cost No cost</p>	<p>Specify <i>with 9250 Ember Chrome lock</i>. Specify <i>with 9201 Polished Chrome lock</i>. ▶ Page 622</p>
<p>Related Products</p> <ul style="list-style-type: none"> • Accessories 		<p>▶ Page 70</p>

Specification Information					
---------------------------	--	--	--	--	--

Dimensions			Style	Base	Options	
D	W	H	Number	Price	(Add \$ to Base Price)	
					<p>Wood</p> <p>Wood : Wood Group 2 : Group 3</p>	

Lateral Files

With Four Drawers

24"	30"	51"	WLLF243051F	\$3989	+\$244	+\$851
24"	36"	51"	WLLF243651F	\$4298	+\$244	+\$851

Service Modules

SIN 711.8

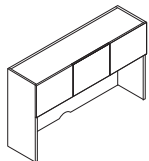

Tip: Finished exterior back adds 3/4" to depth of unit.

For laminate price group 2 pricing, please refer to the electronic catalog or SmartTools.

Tip: When laminate back panel is specified, top edge of back panel is laminate.

Tip: Glass doors do not lock.

Standard Includes		Required to Specify	
<ul style="list-style-type: none"> • Service module: wood group 1 • Back: exterior back - unfinished, interior back - wood • Cable routing scallop on bottom edge of back panel • Attachment hardware: black paint only 		1 Style number 2 Wood color number for service module 3 Options, if selected (see below) ▶ See <i>Surface Materials</i> , page 154.	
Options	Price	Required to Specify	
Surface Materials <ul style="list-style-type: none"> • Wood group 2 • Wood group 3 • Customiz stain on wood 	Prices below Prices below No cost	Specify wood color number. Specify wood color number. Specify with <i>Customiz stain</i> . ▶ See <i>Surface Materials Reference Manual</i> .	
Finished Back <ul style="list-style-type: none"> • Finished exterior back 	Prices below	Specify with <i>finished exterior back</i> .	
Interior Back <ul style="list-style-type: none"> • Laminate price group 1 interior back • Laminate price group 2 interior back • Open Line laminate on interior back 	Prices below See information at left +\$ 69 plus cost of laminate	Specify with <i>laminate interior back</i> . Specify with <i>laminate interior back</i> . ▶ See <i>Surface Materials Reference Manual</i> .	
Wood Framed Glass Doors for Service Modules <ul style="list-style-type: none"> • Non-locking glass doors 	+\$144 per door	Specify with <i>glass doors</i> .	
Lock and Keying	Lock on units to 72"W <ul style="list-style-type: none"> • Ember Chrome +\$128 • Polished Chrome +\$128 	Specify with <i>9250 Ember Chrome lock</i> . Specify with <i>9201 Polished Chrome lock</i> .	
	Lock on 90"W unit <ul style="list-style-type: none"> • Ember Chrome +\$192 • Polished Chrome +\$192 	Specify with <i>9250 Ember Chrome lock</i> . Specify with <i>9201 Polished Chrome lock</i> .	
	Keying <ul style="list-style-type: none"> • Factory- and field-installed keying 	▶ Page 622	
Related Products	<ul style="list-style-type: none"> • Tackboards • Light valance 	▶ Page 62 ▶ Page 63	

Specification Information							
Dimensions	Number of	Style	Base	Options (Add \$ to Base Price)			
D W H	Doors	Number	Price	Wood			
..
..
..
..
..
..
..
..
..
..
..
..
..

Service Modules									
All Closed									
15"	60"	43 3/4"	3	WLMS156043C	\$2155	+\$272	+\$ 952	+\$426	-\$215
15"	66"	43 3/4"	4	WLMS156643C	\$2202	+\$272	+\$ 952	+\$426	-\$215
15"	72"	43 3/4"	4	WLMS157243C	\$2523	+\$272	+\$ 952	+\$426	-\$215
15"	90"	43 3/4"	5	WLMS159043C	\$2894	+\$404	+\$1411	+\$569	-\$285
..
..
Open									
15"	60"	43 3/4"	N.A.	WLMS156043P	\$2012	+\$272	+\$ 952	+\$426	-\$215
15"	66"	43 3/4"	N.A.	WLMS156643P	\$2059	+\$272	+\$ 952	+\$426	-\$215
15"	72"	43 3/4"	N.A.	WLMS157243P	\$2379	+\$272	+\$ 952	+\$426	-\$215
15"	90"	43 3/4"	N.A.	WLMS159043P	\$2752	+\$404	+\$1411	+\$569	-\$285
..
..

Walden

Tackboards

SIN 711.8

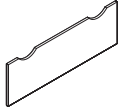

Standard Includes	Required to Specify
-------------------	---------------------

- | | |
|--|--|
| <ul style="list-style-type: none"> • Tackboard: vertical surface fabric group 1 | <ul style="list-style-type: none"> 1 Style number 2 Fabric color number for tackboard 3 Options, if selected (see below) ▶ See <i>Surface Materials</i>, page 154. |
|--|--|

Options	Price	Required to Specify
---------	-------	---------------------

Surface Materials	<ul style="list-style-type: none"> • Fabric price group 1 • Fabric price group 2 • Fabric price group 3 • Fabric price group 4 • Fabric price group 5 • Fabric price group COM 	<ul style="list-style-type: none"> No cost +\$ 12 +\$ 55 +\$ 75 +\$120 +\$ 16 	<ul style="list-style-type: none"> Specify fabric color number. Specify fabric color number. Specify fabric color number. Specify fabric color number. Specify fabric color number. Specify fabric color number. ▶ See <i>Surface Materials Reference Manual</i>.
--------------------------	--	---	--

Related Products	<ul style="list-style-type: none"> • Service modules • Light valance 	<ul style="list-style-type: none"> ▶ Page 61 ▶ Page 63
-------------------------	--	--

Specification Information		
---------------------------	--	--

• Dimensions	• Style	• Base
W H	Number	Price
.	.	.
.	.	.
.	.	.

Tackboards

Service Module Application

60"	21½"	WLIT6021S	\$356
66"	21½"	WLIT6621S	\$376
72"	21½"	WLIT7221S	\$433
90"	21½"	WLIT9021S	\$498
.	.	.	.

Light Valances

SIN 711.8

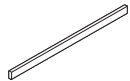
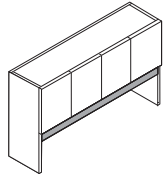

Walden

Standard Includes	Required to Specify
-------------------	---------------------

- Light valance: wood group 1
- Attachment hardware

- 1 Style number
- 2 Wood color number for valance
- 3 Options, if selected (see below)
- ▶ See *Surface Materials*, page 154.

	Options	Price	Required to Specify
--	---------	-------	---------------------

Surface Materials

- Wood group 2
- Wood group 3
- Customiz stain on wood

Prices below
Prices below
No cost

- Specify wood color number.
- Specify wood color number.
- Specify *with Customiz stain*.
- ▶ See *Surface Materials Reference Manual*.

Related Products

- Service modules

▶ Page 61

Specification Information					
Dimensions		Style Number	Base Price	Options	
W	H			(Add \$ to Base Price)	
				Wood	
				Wood Group 2	Wood Group 3
57 ³ / ₄ "	3"	WLAL60S	\$232	+\$69	+\$242
63 ³ / ₄ "	3"	WLAL66S	\$244	+\$69	+\$242
69 ³ / ₄ "	3"	WLAL72S	\$258	+\$69	+\$242
87 ³ / ₄ "	3"	WLAL90S	\$296	+\$69	+\$242
:	:	:	:	:	:

Dimensions		Style Number	Base Price	Options	
W	H			(Add \$ to Base Price)	
				Wood	
				Wood Group 2	Wood Group 3
57 ³ / ₄ "	3"	WLAL60S	\$232	+\$69	+\$242
63 ³ / ₄ "	3"	WLAL66S	\$244	+\$69	+\$242
69 ³ / ₄ "	3"	WLAL72S	\$258	+\$69	+\$242
87 ³ / ₄ "	3"	WLAL90S	\$296	+\$69	+\$242
:	:	:	:	:	:

Back Panels for Desktop Organizers

SIN 711.8

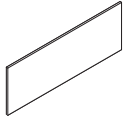

Standard Includes	Required to Specify
<ul style="list-style-type: none"> Back panel: wood group 1 veneer or laminate price group 1 Attachment hardware 	<ol style="list-style-type: none"> Style number Wood or laminate color number for back panel Options, if selected (see below) <p>▶ See <i>Surface Materials</i>, page 154.</p>

Surface Materials	Options	Price	Required to Specify
	Wood back panel <ul style="list-style-type: none"> Wood group 2 Wood group 3 Customiz stain on wood 	Prices below Prices below No cost	Specify wood color number. Specify wood color number. Specify <i>with Customiz stain</i> . ▶ See <i>Surface Materials Reference Manual</i> .
	Laminate back panel <ul style="list-style-type: none"> High-Pressure Laminate price group 2 Open Line laminate 	See information at left +\$69 plus cost of laminate	Specify High-Pressure Laminate color number. ▶ See <i>Surface Materials Reference Manual</i> .

For laminate price group 2 pricing, please refer to the electronic catalog or SmartTools.

Specification Information						
Dimensions			Style	Base Prices		Options
D	W	H	Number	Wood	Laminate	Wood
.....	Group 1
.....
.....
.....
.....
.....
.....
.....
.....

Finished Back Panels

Finished Back Panel for Use with Combo Desktop Organizers							
Depth	Width	Height	Style Number	Base Price	Option Price	Option Price	Total Price
3/4"	60"	21 5/8"	AWNB6021V	\$359	\$298	+\$47	+\$164
3/4"	72"	21 5/8"	AWNB7221V	\$395	\$334	+\$69	+\$242
.....

Stacking Bookcases

SIN 711.8

Walden

Standard Includes	Required to Specify
<ul style="list-style-type: none"> Bookcase: wood group 1 Back: exterior back - unfinished, interior back - wood 	1 Style number 2 Wood color number for bookcase 3 Options, if selected (see below) ▶ See <i>Surface Materials</i> , page 154.

Options	Price	Required to Specify
Surface <ul style="list-style-type: none"> Wood group 2 Wood group 3 Customiz stain on wood 	Prices below Prices below No cost	Specify wood color number. Specify wood color number. Specify with <i>Customiz stain</i> . ▶ See <i>Surface Materials Reference Manual</i> .
Finished Back <ul style="list-style-type: none"> Finished exterior back 	Prices below	Specify with <i>finished exterior back</i> .
Interior Back <ul style="list-style-type: none"> Laminate price group 1 interior back Laminate price group 2 interior back Open Line laminate on interior back 	Prices below See information at left +\$ 69 plus cost of laminate	Specify with <i>laminate interior back</i> . Specify with <i>laminate interior back</i> . ▶ See <i>Surface Materials Reference Manual</i> .
Heavy Load Shelf <ul style="list-style-type: none"> On 15"W bookcases On 30"W and 36"W bookcases 	+\$ 57 +\$114	Specify with <i>heavy load shelf</i> . Specify with <i>heavy load shelf</i> .
Related Products <ul style="list-style-type: none"> Accessories Freestanding bookcase 		▶ Page 70 ▶ Page 66

Tip: Finished exterior back adds 3/4" to depth of unit.

For laminate price group 2 pricing, please refer to the electronic catalog or SmartTools.

Tip: When laminate back panel is specified, top edge of back panel is laminate.

Tip: Specify optional 1 1/8" thick heavy load shelves for heavy load conditions. Heavy load conditions are defined as loads of 100 lbs or greater. Heavy load shelves should be specified on wider units (30"W or 36"W) loaded with books or other heavy objects.

Specification Information							
Dimensions			Style	Base	Options		
D	W	H	Number	Price	(Add \$ to Base Price)		
:	:	:	:	:	Wood		
:	:	:	:	:	Wood	Wood	Finished
:	:	:	:	:	Group 2	Group 3	Exterior
:	:	:	:	:			Laminate
:	:	:	:	:			Interior
:	:	:	:	:			Wood Back
:	:	:	:	:			Back

Stacking Bookcases

Open								
15"	15"	43 3/4"	WLBS151543P	\$ 860	+\$177	+\$624	+\$285	-\$141
15"	30"	43 3/4"	WLBS153043P	\$1203	+\$177	+\$624	+\$285	-\$141
15"	36"	43 3/4"	WLBS153643P	\$1278	+\$177	+\$624	+\$285	-\$141
Two Doors								
15"	30"	43 3/4"	WLBS153043D	\$1688	+\$224	+\$788	+\$285	-\$141
15"	36"	43 3/4"	WLBS153643D	\$1765	+\$224	+\$788	+\$285	-\$141
Door Hinged Left-Hand								
15"	15"	43 3/4"	WLBS151543L	\$1146	+\$208	+\$726	+\$285	-\$141
Door Hinged Right-Hand								
15"	15"	43 3/4"	WLBS151543R	\$1146	+\$208	+\$726	+\$285	-\$141

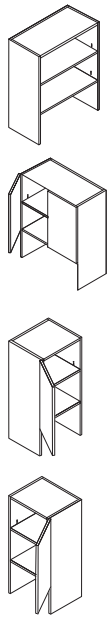

Freestanding Bookcases

SIN 711.8

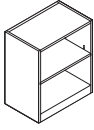

Tip: When laminate back panel is specified, top edge of back panel is laminate.

For laminate price group 2 pricing, please refer to the electronic catalog or SmartTools.

Tip: Specify optional 1 1/8" thick heavy load shelves for heavy load conditions. Heavy load conditions are defined as loads of 100 lbs or greater. Heavy load shelves should be specified on wider units (30"W or 36"W) loaded with books or other heavy objects.

Standard Includes	Required to Specify
<ul style="list-style-type: none"> • Bookcase: wood group 1 • Leveling glides: black only • Finished inset exterior back panel on 27 1/2"H and 45"H units • Unfinished inset exterior back panel on 72 5/8"H units • Finished inset top 	<ul style="list-style-type: none"> 1 Style number 2 Wood color number for bookcase 3 Options, if selected (see below) ▶ See <i>Surface Materials</i>, page 154.

Options	Price	Required to Specify
Surface Materials <ul style="list-style-type: none"> • Wood group 2 • Wood group 3 • Customiz stain on wood 	<ul style="list-style-type: none"> Prices at right Prices at right No cost 	<ul style="list-style-type: none"> Specify wood color number. Specify wood color number. Specify with <i>Customiz stain</i>. ▶ See <i>Surface Materials Reference Manual</i>.
Back Panel <ul style="list-style-type: none"> • 72 5/8"H bookcase only • Finished wood interior and exterior • Laminate price group 1 interior and unfinished exterior • Laminate price group 2 interior and unfinished exterior • Open Line laminate on interior back 	<ul style="list-style-type: none"> +\$285 -\$215 See information at left +\$ 69 plus cost of laminate 	<ul style="list-style-type: none"> Specify with <i>wood interior and wood exterior back</i>. Specify with <i>laminate interior and unfinished exterior back</i>. Specify with <i>laminate interior and unfinished exterior back</i>. ▶ See <i>Surface Materials Reference Manual</i>.
Heavy Load Shelf <ul style="list-style-type: none"> • On 27 1/2"H bookcases • On 45"H bookcases • On 72 5/8"H bookcases 	<ul style="list-style-type: none"> +\$ 57 +\$114 +\$228 	<ul style="list-style-type: none"> Specify with <i>heavy load shelf</i>. Specify with <i>heavy load shelf</i>. Specify with <i>heavy load shelf</i>.
Related Products <ul style="list-style-type: none"> • Accessories • Stacking bookcase 		<ul style="list-style-type: none"> ▶ Page 70 ▶ Page 65



Specification Information						
Dimensions D W H			Style Number	Base Price	Options (Add \$ to Base Price)	
					Wood	
					Wood	Wood
					Group 2	Group 3

Freestanding Bookcases

27 1/2"H Bookcases

15"	30"	27 1/2"	WLBF153028P	\$1919	+\$177	+\$ 624
15"	36"	27 1/2"	WLBF153628P	\$1999	+\$177	+\$ 624
:	:	:	:	:	:	:

45"H Bookcases

15"	30"	45"	WLBF153045P	\$2140	+\$177	+\$ 624
15"	36"	45"	WLBF153645P	\$2245	+\$177	+\$ 624
:	:	:	:	:	:	:

72 5/8"H Bookcases

15"	30"	72 5/8"	WLBF153072P	\$2383	+\$330	+\$1154
15"	36"	72 5/8"	WLBF153672P	\$2513	+\$330	+\$1154
:	:	:	:	:	:	:

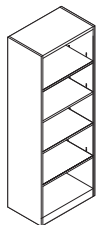
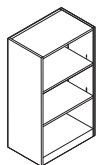
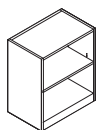

Vertical Cabinets, Wardrobes, and Towers

SIN 711.8



Standard Includes	Required to Specify
<ul style="list-style-type: none"> Vertical cabinets, wardrobes and towers: wood group 1 Back panel: interior finished - wood, exterior - unfinished Lock: keyed random One fastened metal filing system per file drawer: black only Leveling glides: black only 	<ol style="list-style-type: none"> Style number Wood color number Pull shape (see below under Required Selections) Finish color number for pulls Finish color number for lock Options, if selected (see below) <p>▶ See <i>Surface Materials</i>, page 154.</p>

Required Selections (No Additional Cost)

Pull Shape

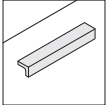

L

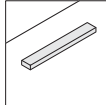

Line

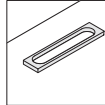

Loop

Options	Price	Required to Specify
<p>Surface Materials</p> <ul style="list-style-type: none"> Wood group 2 Wood group 3 Customiz stain on wood 	<p>Prices at right</p> <p>Prices at right</p> <p>No cost</p>	<p>Specify wood color number.</p> <p>Specify wood color number.</p> <p>Specify <i>with Customiz stain</i>.</p> <p>▶ See <i>Surface Materials Reference Manual</i>.</p>
<p>Materials</p>		
<p>Back Panel</p> <ul style="list-style-type: none"> Finished wood interior and exterior Laminate price group 1 interior and unfinished exterior Laminate price group 2 interior and unfinished exterior Open Line laminate on interior back 	<p>+\$215</p> <p>-\$215</p> <p>See information at left</p> <p>+\$ 69 plus cost of laminate</p>	<p>Specify <i>with wood interior and wood exterior back</i>.</p> <p>Specify <i>with laminate interior and unfinished exterior back</i>.</p> <p>Specify <i>with laminate interior and unfinished exterior back</i>.</p> <p>▶ See <i>Surface Materials Reference Manual</i>.</p>
<p>Lock and Keying</p>		
<p>Lock</p> <ul style="list-style-type: none"> Ember Chrome Polished Chrome 	<p>No cost</p> <p>No cost</p>	<p>Specify <i>with 9250 Ember Chrome lock</i>.</p> <p>Specify <i>with 9201 Polished Chrome lock</i>.</p>
<p>Keying</p> <ul style="list-style-type: none"> Factory- and field-installed keying 		<p>▶ Page 622</p>
<p>Related Products</p>	<ul style="list-style-type: none"> Accessories 	<p>▶ Page 70</p>

Tip: When laminate back panel is specified, top edge of back panel is laminate.

For laminate price group 2 pricing, please refer to the electronic catalog or SmartTools.

Specification Information

Dimensions D W H	Style Number	Base Price	Options (Add \$ to Base Price)
			Wood
			Wood : Wood Group 2 : Group 3

Vertical Cabinets

One Fixed Shelf, Two Adjustable Shelves

24" 30" 72 ⁵ / ₈ "	WLKV243072B	\$3164	+\$510	+\$1787
24" 36" 72 ⁵ / ₈ "	WLKV243672B	\$3482	+\$510	+\$1787
:	:	:	:	:



Wardrobes

24" 30" 72 ⁵ / ₈ "	WLKW243072	\$2175	+\$510	+\$1787
24" 36" 72 ⁵ / ₈ "	WLKW243672	\$2394	+\$510	+\$1787
:	:	:	:	:

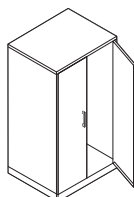

Towers

With Door Hinged Left-Hand

24" 24" 72 ⁵ / ₈ "	WLTW242472G	\$2353	+\$312	+\$1092
--	--------------------	--------	--------	---------

With Door Hinged Right-Hand

24" 24" 72 ⁵ / ₈ "	WLTW242472H	\$2353	+\$312	+\$1092
:	:	:	:	:

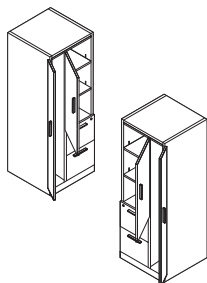

Accessories

SIN 711.8

Wood Center Drawer

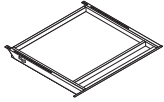

Tip: Dimensions given are outside dimensions.

Standard Includes	Required to Specify
<ul style="list-style-type: none"> • Non-locking center drawer: wood group 1 • Mounting frame: black paint only 	<ul style="list-style-type: none"> 1 Style number 2 Wood color number for center drawer 3 Options, if selected (see below) ▶ See <i>Surface Materials</i>, page 154.

Options	Price	Required to Specify
Surface Materials <ul style="list-style-type: none"> • Wood group 2 • Wood group 3 • Customiz stain 	<ul style="list-style-type: none"> +\$19 +\$71 No cost 	<ul style="list-style-type: none"> Specify wood color number. Specify wood color number. Specify <i>with Customiz stain</i>. ▶ See <i>Surface Materials Reference Manual</i>.

Specification Information				
• Dimensions			• Style	• Base
D	W	H	Number	Price
23"	21 ⁵ / ₁₆ "	2 ¹ / ₄ "	AWAC23212	\$346

2 1/2" Round Grommet



Tip: Grommet AWAG2 is for use on worksurfaces only.

Tip: When using AWAG2 in the Universal parametric straight worksurface, specify the 2" grommet cutout option. Actual diameter of cutout is 2¹/₄".

Tip: For grommet location information, ▶ See Wood Casegoods Specification Guide.

Standard Includes	Required to Specify
<ul style="list-style-type: none"> • Grommet: paint or metal • Installation instructions 	<ul style="list-style-type: none"> 1 Style number 2 Paint or metal color number ▶ See <i>Surface Materials</i>, page 154.

Specification Information			
• Dimensions		• Style	• Price
D	W	Number	
2 ¹ / ₂ "	2 ¹ / ₂ "	AWAG2	\$68

Flip Up Power Unit



Standard Includes	Required to Specify
<ul style="list-style-type: none"> • Power unit: 0835 Black paint or 4799 Platinum paint • Two outlets: black plastic • Attachment hardware • 6' power cord with grounded plug: black plastic 	<ul style="list-style-type: none"> 1 Style number 2 Paint color number for flip up power unit

Specification Information				
• Dimensions			• Style	• Price
D	W	H	Number	
4 ¹ / ₄ "	5 ¹ / ₂ "	2"	AWVFP	\$288

Convene



Statement of Line **72**



Application Topics

Availability of Conference Top Options	
Round, Square, and Cushion Tops	78
Oval Tops	79
Rectangular, Boat-Shape, and Racetrack Tops	80
Specifying Conference Top Options	81



Specifying

Wood Conference Table Tops (SIN 711.11)	84
Laminate Conference Table Tops (SIN 711.11)	96
Bases for Conference Tables (SIN 711.11)	108
Power and Communication Accessories (SIN 711.11)	116
Contemporary-Style Furniture (SIN 711.11)	118
Transitional-Style Furniture (SIN 711.11)	126

Statement of Line

Convene

Conference Tables and Bases

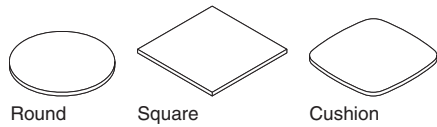

Specifying
▶ Pages 84–86,
96–98

Round, Square, and Cushion Table Tops

	36"W	42"W	48"W	54"W	60"W	66"W	72"W
36"D	● ■						
42"D		● ■					
48"D			● ■				
54"D				● ■			
60"D					● ■		
66"D						●	
72"D							●

● = Round ■ = Square and Cushion

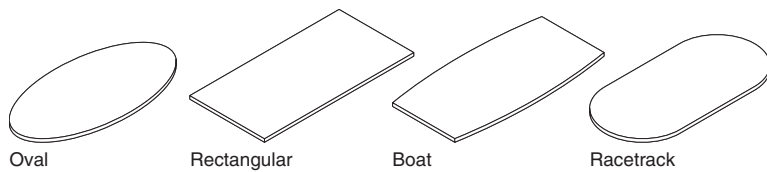

Specifying
▶ Pages 88–94,
100–106

Oval, Rectangular, Boat-Shape, and Racetrack Tops

	60"W	66"W	72"W	84"W	96"W	108"W	120"W	144"W	168"W	192"W	216"W
36"D	● ■	● ■	● ■	● ■							
42"D			● ■	● ■	● ■	● ■					
48"D				■	● ■	● ■	● ■	● ■			
54"D						● ■	● ■	● ■	■		
60"D							● ■	● ■	● ■	■	■
66"D								● ■	● ■	● ■	■
72"D									● ■	● ■	● ■

● = Oval ■ = Rectangular, Boat-Shape, and Racetrack

Conference Tables and Bases, continued

Specifying
▶ Page 108–115

Conference Table Bases



T-flex
base



X-flex
base



U-panel
base



X-panel
base



Rectangular
base



Contemporary
disk base



Transitional
disk base



Circular drum
base

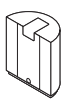

Half drum
base

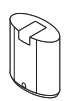

Elliptical drum
base

Contemporary-Style Coordinating Furniture

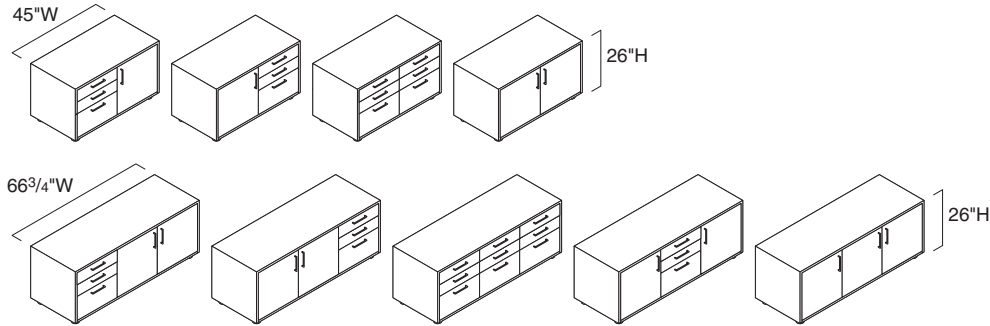

Specifying
▶ Page 118

Storage Credenzas

	45"W	67"W
24"D	●	●

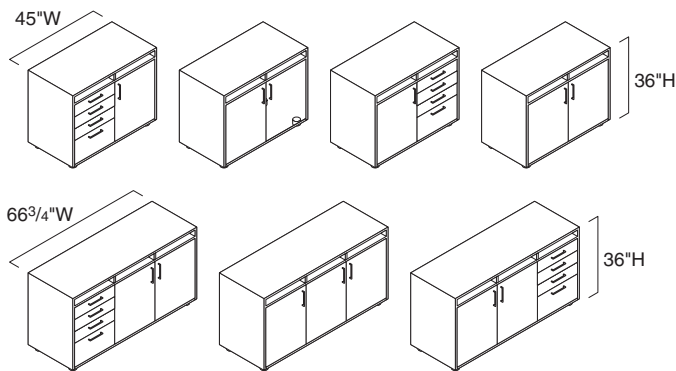

Specifying
▶ Page 120

Buffet-Height Credenzas

	45"W	67"W
24"D	●	●

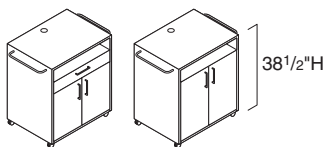

Specifying
▶ Page 122

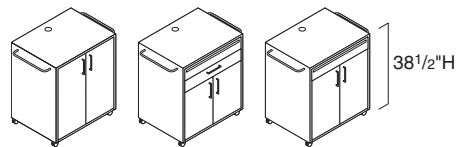

Specifying
▶ Page 123

Media Carts

	32"W
24"D	●

Hospitality Carts

	32"W
24"D	●

Contemporary-Style Coordinating Furniture, continued

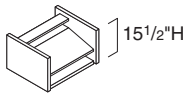

Specifying
▶ Page 124

Table Top Lectern

25"W
22"D ●

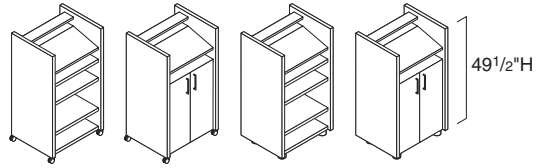

Specifying
▶ Page 124

Full-Height Lecterns

25"W
22"D ●

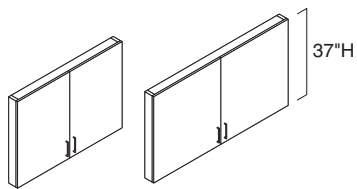

Specifying
▶ Page 125

Wallboards

56"W 70"W
5"D ● ●

Transitional-Style Coordinating Furniture

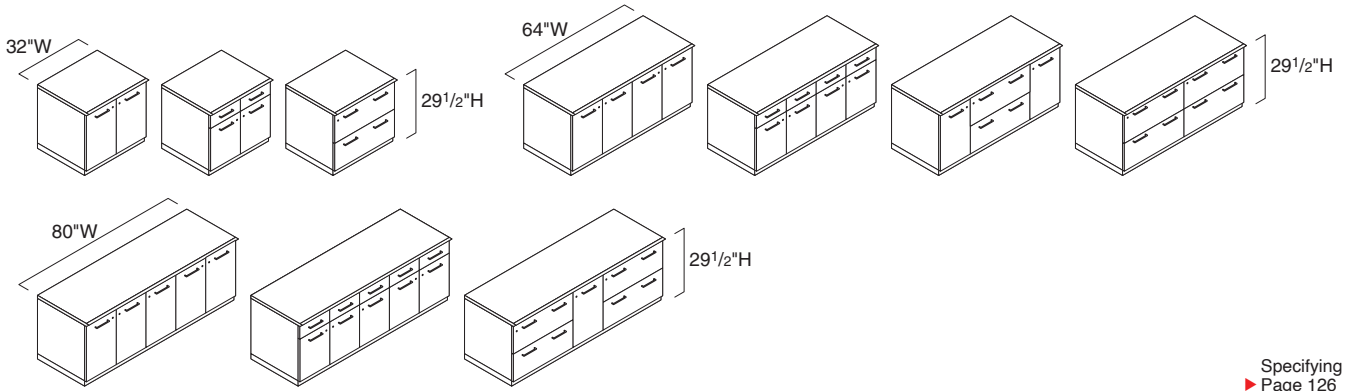

Specifying
▶ Page 126

Storage Credenzas

	32"W	64"W	80"W
25 1/4"D	●	●	●

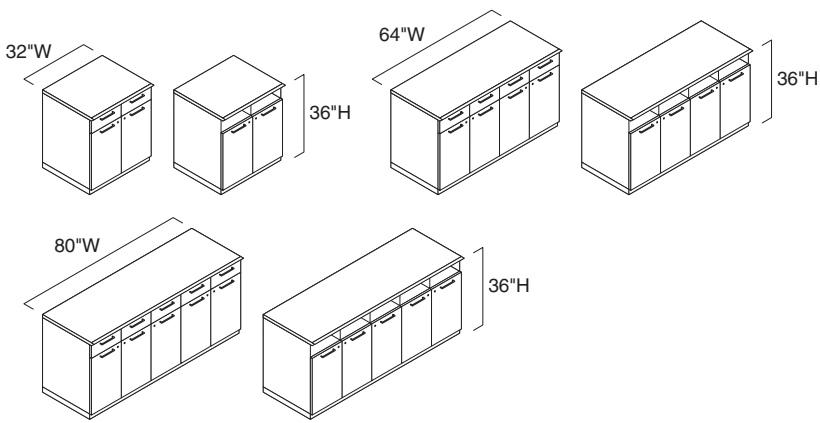

Specifying
▶ Page 128

Buffet-Height Credenzas

	32"W	64"W	80"W
25 1/4"D	●	●	●



Specifying
▶ Page 130

Specifying
▶ Page 131

Media Carts

	32 1/2"W
25"D	●

Hospitality Carts

	32 1/2"W
25"D	●

Transitional-Style Coordinating Furniture, continued

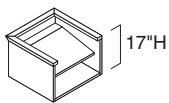

Specifying
▶ Page 132

Table Top Lectern

27½"W

23½"D ●

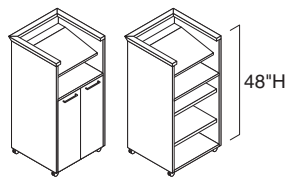

Specifying
▶ Page 132

Full-Height Lecterns

27½"W

23½"D ●

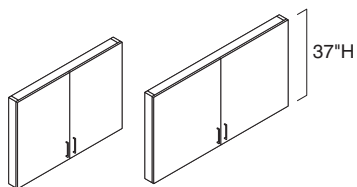

Specifying
▶ Page 133

Wallboards

56"W

70"W

5"D ● ●

Availability of Conference Top Options

Round, Square, and Cushion Tops

▶ See *Wood Caseworks and Tables Specification Guide for Power and Communication Accessory Locations.*

	Round Tops							Square Tops					Cushion Tops				
	36" diameter	42" diameter	48" diameter	54" diameter	60" diameter	66" diameter	72" diameter	36"W	42"W	48"W	54"W	60"W	36"W	42"W	48"W	54"W	60"W

Grommets

▶ Page 81 for Specifying Information

One 2 1/2" round	■	■	■	■	■	■	■	■	■	■	■	■	■	■	■	■	■
Two 2 1/2" round	•	•	•	•	•	•	•	•	•	•	•	•	•	•	•	•	•
Four 2 1/2" round	•	•	•	•	•	•	•	•	•	•	•	•	•	•	•	•	•

Power Channels

▶ Page 81 for Specifying Information

One power channel	•	•	•	•	•	•	•	•	•	•	•	•	•	•	•	•	•
Two power channels	•	•	•	•	•	•	•	•	•	•	•	•	•	•	•	•	•

Power Units

▶ Page 82 for Specifying Information

One power unit	■	■	■	■	■	•	•	■	■	■	■	■	■	■	■	■	■
Two power units	•	•	•	•	•	■	■	•	•	•	•	•	•	•	•	•	•
Four power units	•	•	•	•	•	•	•	•	•	•	•	•	•	•	•	•	•
Six power units	•	•	•	•	•	•	•	•	•	•	•	•	•	•	•	•	•

Factory-Cut Hole for Power and Communication Sphere

▶ Page 83 for Specifying Information

One 3"-diameter hole	■	■	■	■	■	•	•	■	■	■	■	■	■	■	■	■	■
Two 3"-diameter holes	•	•	•	•	•	•	•	•	•	•	•	•	•	•	•	•	•
Four 3"-diameter holes	•	•	•	•	•	•	•	•	•	•	•	•	•	•	•	•	•

Factory-Cut Hole for Round Power and Communication Port

▶ Page 83 for Specifying Information

One 3 1/2"-diameter hole	■	■	■	■	■	•	•	■	■	■	■	■	■	■	■	■	■
Two 3 1/2"-diameter holes	•	•	•	•	•	•	•	•	•	•	•	•	•	•	•	•	•
Four 3 1/2"-diameter holes	•	•	•	•	•	•	•	•	•	•	•	•	•	•	•	•	•

Factory-Cut Hole for Oval Power and Communication Port

▶ Page 83 for Specifying Information

One 12"W hole	•	•	•	•	•	•	•	•	•	•	•	•	•	•	•	•	•
Two 12"W holes	•	•	•	•	•	•	•	•	•	•	•	•	•	•	•	•	•

Legend

- = Not available
- = Available

Availability of Conference Top Options

Oval Tops

▶ See *Wood Casegoods and Tables Specification Guide for Power and Communication Accessory Locations.*

Oval Tops	36"W			42"W			48"W			54"W			60"W			66"W			72"W						
	60"W	66"W	72"W	84"W	72"W	84"W	96"W	108"W	120"W	144"W	108"W	120"W	144"W	168"W	120"W	144"W	168"W	192"W	216"W	144"W	168"W	192"W	216"W	168"W	192"W

Grommets

▶ Page 81 for Specifying Information

One 2 1/2" round	■	■	■	■	■	■	■	■	■	■	■	■	■	■	■	■	■	■	■	■	■	■	■	■	■	■
Two 2 1/2" round	■	■	■	■	■	■	■	■	■	■	■	■	■	■	■	■	■	■	■	■	■	■	■	■	■	■
Four 2 1/2" round	■	■	■	■	■	■	■	■	■	■	■	■	■	■	■	■	■	■	■	■	■	■	■	■	■	■

Power Channels

▶ Page 81 for Specifying Information

One power channel	■	■	■	■	■	■	■	■	■	■	■	■	■	■	■	■	■	■	■	■	■	■	■	■	■	■
Two power channels	■	■	■	■	■	■	■	■	■	■	■	■	■	■	■	■	■	■	■	■	■	■	■	■	■	■

Power Units

▶ Page 82 for Specifying Information

One power unit	■	■	■	■	■	■	■	■	■	■	■	■	■	■	■	■	■	■	■	■	■	■	■	■	■	■
Two power units	■	■	■	■	■	■	■	■	■	■	■	■	■	■	■	■	■	■	■	■	■	■	■	■	■	■
Four power units	■	■	■	■	■	■	■	■	■	■	■	■	■	■	■	■	■	■	■	■	■	■	■	■	■	■
Six power units	■	■	■	■	■	■	■	■	■	■	■	■	■	■	■	■	■	■	■	■	■	■	■	■	■	■

Factory-Cut Hole for Power and Communication Sphere

▶ Page 83 for Specifying Information

One 3"-diameter hole	■	■	■	■	■	■	■	■	■	■	■	■	■	■	■	■	■	■	■	■	■	■	■	■	■	■
Two 3"-diameter holes	■	■	■	■	■	■	■	■	■	■	■	■	■	■	■	■	■	■	■	■	■	■	■	■	■	■
Four 3"-diameter holes	■	■	■	■	■	■	■	■	■	■	■	■	■	■	■	■	■	■	■	■	■	■	■	■	■	■

Factory-Cut Hole for Round Power and Communication Port

▶ Page 83 for Specifying Information

One 3 1/2"-diameter hole	■	■	■	■	■	■	■	■	■	■	■	■	■	■	■	■	■	■	■	■	■	■	■	■	■	■
Two 3 1/2"-diameter holes	■	■	■	■	■	■	■	■	■	■	■	■	■	■	■	■	■	■	■	■	■	■	■	■	■	■
Four 3 1/2"-diameter holes	■	■	■	■	■	■	■	■	■	■	■	■	■	■	■	■	■	■	■	■	■	■	■	■	■	■

Factory-Cut Hole for Oval Power and Communication Port

▶ Page 83 for Specifying Information

One 12"W hole	■	■	■	■	■	■	■	■	■	■	■	■	■	■	■	■	■	■	■	■	■	■	■	■	■	■
Two 12"W holes	■	■	■	■	■	■	■	■	■	■	■	■	■	■	■	■	■	■	■	■	■	■	■	■	■	■

Legend

- = Not available
- = Available

Availability of Conference Top Options

Rectangular, Boat-Shape, and Racetrack Tops

▶ See page *Wood Caseloads and Tables Specification Guide for Power and Communication Accessory Locations.*

Rectangular, Boat-Shape, and Racetrack Tops	36"W			42"W			48"W			54"W			60"W			66"W			72"W									
	60"W	66"W	72"W	84"W	72"W	84"W	96"W	108"W	84"W	96"W	108"W	120"W	144"W	108"W	120"W	144"W	168"W	120"W	144"W	168"W	192"W	216"W	144"W	168"W	192"W	216"W	168"W	192"W

Grommets

▶ Page 81 for Specifying Information

One 2 1/2" round	■	■	■	■	■	■	■	■	■	■	■	■	■	■	■	■	■	■	■	■	■	■	■	■	■	■	■	■	■
Two 2 1/2" round	■	■	■	■	■	■	■	■	■	■	■	■	■	■	■	■	■	■	■	■	■	■	■	■	■	■	■	■	■
Four 2 1/2" round	■	■	■	■	■	■	■	■	■	■	■	■	■	■	■	■	■	■	■	■	■	■	■	■	■	■	■	■	■

Power Channels

▶ Page 81 for Specifying Information

One power channel	■	■	■	■	■	■	■	■	■	■	■	■	■	■	■	■	■	■	■	■	■	■	■	■	■	■	■	■	■
Two power channels	■	■	■	■	■	■	■	■	■	■	■	■	■	■	■	■	■	■	■	■	■	■	■	■	■	■	■	■	■

Power Units

▶ Page 82 for Specifying Information

One power unit	■	■	■	■	■	■	■	■	■	■	■	■	■	■	■	■	■	■	■	■	■	■	■	■	■	■	■	■	■
Two power units	■	■	■	■	■	■	■	■	■	■	■	■	■	■	■	■	■	■	■	■	■	■	■	■	■	■	■	■	■
Four power units	■	■	■	■	■	■	■	■	■	■	■	■	■	■	■	■	■	■	■	■	■	■	■	■	■	■	■	■	■
Six power units	■	■	■	■	■	■	■	■	■	■	■	■	■	■	■	■	■	■	■	■	■	■	■	■	■	■	■	■	■

Factory-Cut Hole for Power and Communication Sphere

▶ Page 83 for Specifying Information

One 3"-diameter hole	■	■	■	■	■	■	■	■	■	■	■	■	■	■	■	■	■	■	■	■	■	■	■	■	■	■	■	■	■
Two 3"-diameter holes	■	■	■	■	■	■	■	■	■	■	■	■	■	■	■	■	■	■	■	■	■	■	■	■	■	■	■	■	■
Four 3"-diameter holes	■	■	■	■	■	■	■	■	■	■	■	■	■	■	■	■	■	■	■	■	■	■	■	■	■	■	■	■	■

Factory-Cut Hole for Round Power and Communication Port

▶ Page 83 for Specifying Information

One 3 1/2"-diameter hole	■	■	■	■	■	■	■	■	■	■	■	■	■	■	■	■	■	■	■	■	■	■	■	■	■	■	■	■	■
Two 3 1/2"-diameter holes	■	■	■	■	■	■	■	■	■	■	■	■	■	■	■	■	■	■	■	■	■	■	■	■	■	■	■	■	■
Four 3 1/2"-diameter holes	■	■	■	■	■	■	■	■	■	■	■	■	■	■	■	■	■	■	■	■	■	■	■	■	■	■	■	■	■

Factory-Cut Hole for Oval Power and Communication Port

▶ Page 83 for Specifying Information

One 12"W hole	■	■	■	■	■	■	■	■	■	■	■	■	■	■	■	■	■	■	■	■	■	■	■	■	■	■	■	■	■
Two 12"W holes	■	■	■	■	■	■	■	■	■	■	■	■	■	■	■	■	■	■	■	■	■	■	■	■	■	■	■	■	■

Legend

- = Not available
- = Available

Specifying Conference Top Options

Grommets



▶ See Availability of Conference Top Options, pages 78–80.

Options	Price	Required to Specify
• One 2½"-round grommet	+\$ 74	Center: Specify with <i>CGRC</i> and select 0835 Black, 4799 Platinum Metallic, 9201 Polished Chrome, or 9211 Nickel.
• Two 2½"-round grommets	+\$148	Left/Right: Specify with <i>CGRLR</i> and select 0835 Black, 4799 Platinum Metallic, 9201 Polished Chrome, or 9211 Nickel.
• Four 2½"-round grommets	+\$296	Left/Center/Center/Right: Specify with <i>CGRLCCR</i> and select 0835 Black, 4799 Platinum Metallic, 9201 Polished Chrome, or 9211 Nickel.

Power Channels

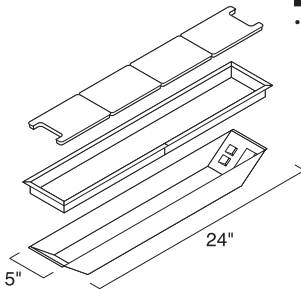

▶ See Availability of Conference Top Options, pages 78–80.

Tip: Power channel conduit must be hard-wired in the field.

Tip: Power channels cannot be used on tops supported by X-panel bases.

Tip: Power channels cannot be used on 54"D x 120"W oval tops supported by T- or X-flex bases.

Tip: Technology covers are included with power units and power channels. Specify additional covers only if you need a different style or replacements.

Tip: AAPs are available from Extron Electronics. For information on AAPs and to find an Extron Electronics dealer, contact Extron at 800.633.9876 or online at extron.com.

Options	Price	Required to Specify
<ul style="list-style-type: none"> • One power channel <ul style="list-style-type: none"> —Power channel with four electrical outlets and 6' conduit for hardwiring in the field —Faceplates to accommodate four customer-supplied voice/data receptacles —Two square and two wire access technology covers —In place of the faceplates provided, up to four single space Extron Electronics Architectural Adapter Plates (AAPs) can be used for data solutions —Sleeve: paint or metal 	+\$ 765	Center: Specify with <i>CPCC</i> and select technology cover color: 2970 Cameo White (default) or 2971 Nocturne Black. Select sleeve color: 0835 Black or 4799 Platinum (default).
<ul style="list-style-type: none"> • Two power channels <ul style="list-style-type: none"> —Two power channels each with four electrical outlets and 6' conduit for hardwiring in the field —Faceplates to accommodate eight customer-supplied voice/data receptacles —Four square and four wire access technology covers —In place of the faceplates provided, up to eight single space Extron Electronics Architectural Adapter Plates (AAPs) can be used for data solutions —Two sleeves: paint or metal 	+\$1530	Left/Right: Specify with <i>CPCLR</i> and select technology cover color: 2970 Cameo White (default) or 2971 Nocturne Black. Select sleeve color: 0835 Black or 4799 Platinum (default).

Specifying Conference Top Options, continued

Power Units

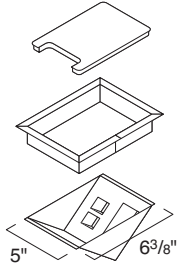

► See Availability of Conference Top Options, pages 78–80.

Tip: Power unit conduit must be hardwired in the field.

Tip: Technology covers are included with power units and power channels. Specify additional covers only if you need a different style or replacements.

Options	Price	Required to Specify
<ul style="list-style-type: none"> • One power unit <ul style="list-style-type: none"> —One power unit with two electrical outlets and 6' conduit for hardwiring in the field —Faceplates to accommodate two customer-supplied voice/data receptacles —In place of the faceplates provided, up to two single space Extron Electronics Architectural Adapter Plates (AAPs) can be used for data solutions —One wire access technology cover —Sleeve: paint or metal 	+\$ 369	Specify <i>with CPU1</i> and select technology cover color: 2970 Cameo White (default) or 2971 Nocturne Black. Select sleeve color: 0835 Black or 4799 Platinum (default).
<ul style="list-style-type: none"> • Two power units <ul style="list-style-type: none"> —Two power units each with two electrical outlets and 6' conduit for hardwiring in the field —Faceplates to accommodate four customer-supplied voice/data receptacles —In place of the faceplates provided, up to four single space Extron Electronics Architectural Adapter Plates (AAPs) can be used for data solutions —Two wire access technology covers —Two sleeves: paint or metal 	+\$ 738	Specify <i>with CPU2</i> and select technology cover color: 2970 Cameo White (default) or 2971 Nocturne Black. Select sleeve color: 0835 Black or 4799 Platinum (default).
<ul style="list-style-type: none"> • Four power units <ul style="list-style-type: none"> —Four power units each with two electrical outlets and 6' conduit for hardwiring in the field —Faceplates to accommodate eight customer-supplied voice/data receptacles —In place of the faceplates provided, up to eight single space Extron Electronics Architectural Adapter Plates (AAPs) can be used for data solutions —Four wire access technology covers —Four sleeves: paint or metal 	+\$1476	Specify <i>with CPU4</i> and select technology cover color: 2970 Cameo White (default) or 2971 Nocturne Black. Select sleeve color: 0835 Black or 4799 Platinum (default).
<ul style="list-style-type: none"> • Six power units <ul style="list-style-type: none"> —Six power units each with two electrical outlets and 6' conduit for hardwiring in the field —Faceplates to accommodate twelve customer-supplied voice/data receptacles —In place of the faceplates provided, up to twelve single space Extron Electronics Architectural Adapter Plates (AAPs) can be used for data solutions —Six wire access technology covers —Six sleeves: paint or metal 	+\$2214	Specify <i>with CPU6</i> and select technology cover color: 2970 Cameo White (default) or 2971 Nocturne Black. Select sleeve color: 0835 Black or 4799 Platinum (default).

Factory-Cut Hole for Power and Communication Accessories

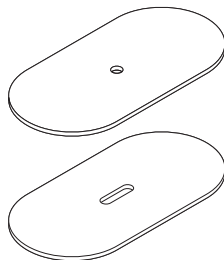

▶ See Availability of Conference Top Options, pages 78–80.

Tip: Remember to order the power and communication ports and spheres separately.

▶ See Wood Casegoods and Tables Specification Guide.

Tip: Oval ports cannot be used on the following top and base combinations:

- 54" x 120" oval tops with T- or X-flex bases
- 54" x 144" oval tops with X-panel bases
- 60" x 144" racetrack, rectangle, and boat-shape tops with elliptical drum bases.

Options	Price	Required to Specify
Hole for power and communication sphere		
• One 3" diameter hole	+\$ 34	Center: Specify with CPSC.
• Two 3" diameter holes	+\$ 68	Left/Right: Specify with CPSLR.
• Four 3" diameter holes	+\$136	Left/Center/Center/Right: Specify with CPSLCCR.
Hole for round power and communication port		
• One 3½" diameter hole	+\$ 34	Center: Specify with CSPC.
• Two 3½" diameter holes	+\$ 68	Left/Right: Specify with CSPLR.
• Four 3½" diameter holes	+\$136	Left/Center/Center/Right: Specify with CSPLCCR.
Hole for oval power and communication port		
• One 12"W hole	+\$ 34	Center: Specify with CLPC.
• Two 12"W holes	+\$ 68	Left/Right: Specify with CLPLR.

Round Wood Conference Table Tops

SIN 711.11



Tip: Your specification is not complete until you add a third letter to the style number to define the table edge profile.

Standard Edge Profiles For Diameter Tops 36"-60"

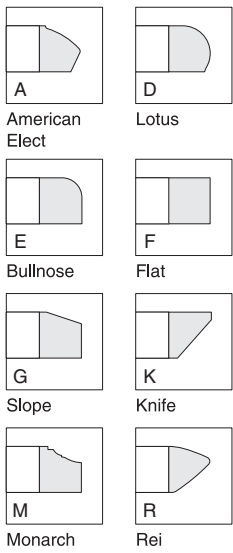

Large Edge Profiles For Diameter Tops 66"-72"

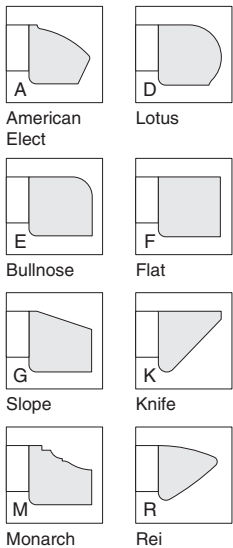

Standard Includes Required to Specify

- Table top: wood group 1 veneer with solid wood edge
- 1 Style number with appropriate edge profile letter indicated in the space provided (For example, CW_R36 becomes CWFR36 for flat edge profile)
 - ▶ See edge profiles below.
- 2 Wood veneer color number for top
- 3 Options, if selected (see below)
 - ▶ See *Surface Materials*, page 154.

Options	Price	Required to Specify
Surface Materials	<ul style="list-style-type: none"> Wood group 2 Prices below Wood group 3 Prices below Customiz stain on wood No cost 	Specify wood color number. Specify wood color number. Specify with <i>Customiz stain</i> . ▶ See <i>Surface Materials Reference Manual</i> . Specify full-fill finish number.
<ul style="list-style-type: none"> Full-fill finish on wood group 1 	Prices below	

Additional Options

- ▶ See *Availability of Conference Top Options*, pages 78–80.
- ▶ See *Specifying Conference Top Options*, page 81.

Specification Information

Diameter	Style Number	Base Price	Options (Add \$ to Base Price)			
			Wood	Wood	Wood	Full-Fill Finish on Wood
			Group 2	Group 3	Group 1	
36"	CW_R36	\$1425	+\$ 47	+\$164	+\$24	
42"	CW_R42	\$1714	+\$ 69	+\$242	+\$24	
48"	CW_R48	\$2157	+\$ 69	+\$242	+\$24	
54"	CW_R54	\$2801	+\$124	+\$436	+\$46	
60"	CW_R60	\$3252	+\$124	+\$436	+\$46	
66"	CW_R66	\$3927	+\$157	+\$546	+\$46	
72"	CW_R72	\$4579	+\$203	+\$709	+\$46	

Square Wood Conference Table Tops

SIN 711.11

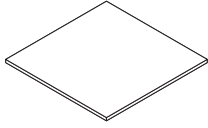

Tip: Your specification is not complete until you add a third letter to the style number to define the table top edge profile.

Standard Edge Profiles For Tops 36"W-60"W

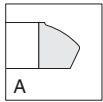

American Elect

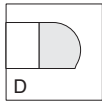

Lotus

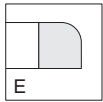

Bullnose

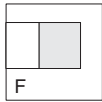

Flat

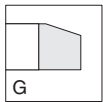

Slope

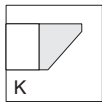

Knife

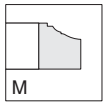

Monarch

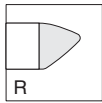

Rei

Standard Includes

- Table top: wood group 1 veneer with solid wood edge

Required to Specify

- Style number with appropriate edge profile letter indicated in the space provided (For example, CW_S36 becomes CWFS36 for flat edge profile)
 - See edge profiles below.
- Wood veneer color number for top
- Options, if selected (see below)
 - See *Surface Materials*, page 154.

Options	Price	Required to Specify
Surface Materials	<ul style="list-style-type: none"> Wood group 2: Prices below Wood group 3: Prices below Customiz stain on wood: No cost 	Specify wood color number. Specify wood color number. Specify with <i>Customiz stain</i> . See <i>Surface Materials Reference Manual</i> . Specify full-fill finish number.
<ul style="list-style-type: none"> Full-fill finish on wood group 1: Prices below 	Prices below	

Additional Options

- See *Availability of Conference Top Options*, pages 78–80.
- See *Specifying Conference Top Options*, page 81.

Specification Information

Dimensions		Style Number	Base Price	Options (Add \$ to Base Price)					
D	W			Wood	Full-Fill	Finish on			
36"	36"	CW_S36	\$1165	+	\$ 47	+	\$164	+	\$24
42"	42"	CW_S42	\$1402	+	\$ 69	+	\$242	+	\$24
48"	48"	CW_S48	\$1767	+	\$ 69	+	\$242	+	\$46
54"	54"	CW_S54	\$2512	+	\$124	+	\$436	+	\$46
60"	60"	CW_S60	\$3336	+	\$124	+	\$436	+	\$46

Convене

Cushion Wood Conference Table Tops

SIN 711.11

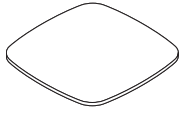

Tip: Your specification is not complete until you add a third letter to the style number to define the table top edge profile.

Standard Edge Profiles For Tops 36"W-60"W

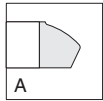

American Elect

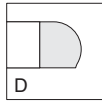

Lotus

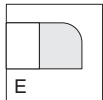

Bullnose

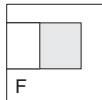

Flat

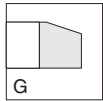

Slope

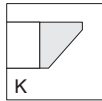

Knife

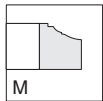

Monarch

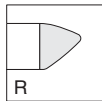

Rei

Standard Includes	Required to Specify
-------------------	---------------------

- | | |
|---|---|
| <ul style="list-style-type: none"> Table top: wood group 1 veneer with solid wood edge | <ul style="list-style-type: none"> 1 Style number with appropriate edge profile letter indicated in the space provided (For example, CW_C36 becomes CWFC36 for flat edge profile) <ul style="list-style-type: none"> ▶ See edge profiles below. 2 Wood veneer color number for top 3 Options, if selected (see below) <ul style="list-style-type: none"> ▶ See <i>Surface Materials</i>, page 154. |
|---|---|

Surface Materials	Options	Price	Required to Specify
-------------------	---------	-------	---------------------

- | | | | |
|--|--|---|---|
| <ul style="list-style-type: none"> Wood group 2 Wood group 3 Customiz stain on wood | <ul style="list-style-type: none"> Full-fill finish on wood group 1 | <ul style="list-style-type: none"> Prices below Prices below No cost Prices below | <ul style="list-style-type: none"> Specify wood color number. Specify wood color number. Specify <i>with Customiz stain</i>. ▶ See <i>Surface Materials Reference Manual</i>. Specify full-fill finish number. |
|--|--|---|---|

Additional Options

- ▶ See *Availability of Conference Top Options*, pages 78–80.
- ▶ See *Specifying Conference Top Options*, page 81.

Specification Information

• Dimensions		• Style Number	• Base Price	• Options (Add \$ to Base Price)		
D	W			Wood	Wood Group 2	Wood Group 3
36"	36"	CW_C36	\$1399	+\$ 47	+\$164	+\$24
42"	42"	CW_C42	\$1684	+\$ 69	+\$242	+\$24
48"	48"	CW_C48	\$2120	+\$ 69	+\$242	+\$46
54"	54"	CW_C54	\$3016	+\$124	+\$436	+\$46
60"	60"	CW_C60	\$4006	+\$124	+\$436	+\$46

Oval Wood Conference Table Tops

SIN 711.11



Standard Includes	Required to Specify
-------------------	---------------------

- | | |
|---|---|
| <ul style="list-style-type: none"> • Table top: wood group 1 veneer with solid wood edge | <p>1 Style number with appropriate edge profile letter indicated in the space provided (For example, CW_J3660 becomes CWFJ3660 for flat edge profile)</p> <ul style="list-style-type: none"> ▶ See edge profiles at right. <p>2 Wood veneer color number for top</p> <p>3 Options, if selected (see below)</p> <ul style="list-style-type: none"> ▶ See <i>Surface Materials</i>, page 154. |
|---|---|

	Options	Price	Required to Specify
--	---------	-------	---------------------

Surface Materials	<ul style="list-style-type: none"> • Wood group 2 • Wood group 3 • Customiz stain on wood 	<p>Prices at right</p> <p>Prices at right</p> <p>No cost</p>	<p>Specify wood color number.</p> <p>Specify wood color number.</p> <p>Specify <i>with Customiz stain</i>.</p> <ul style="list-style-type: none"> ▶ See <i>Surface Materials Reference Manual</i>. <p>Specify full-fill finish number.</p>
	<ul style="list-style-type: none"> • Full-fill finish on wood group 1 	<p>Prices at right</p>	

- | | |
|---------------------------|---|
| Additional Options | <ul style="list-style-type: none"> ▶ See <i>Availability of Conference Top Options</i>, pages 78–80. ▶ See <i>Specifying Conference Top Options</i>, page 81. |
|---------------------------|---|

Tip: Your specification is not complete until you add a third letter to the style number to define the table top edge profile.

Standard Edge Profiles For Tops 60"W-120"W

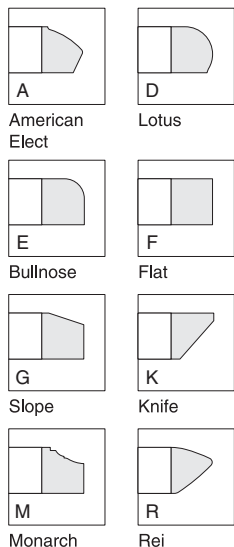

Large Edge Profiles For Tops 144"W and Wider

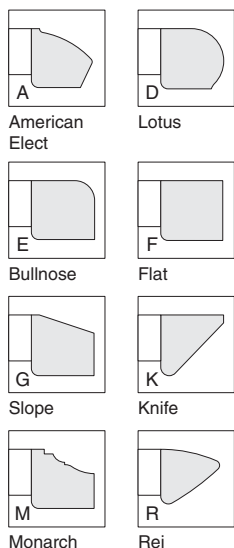

Specification Information

Dimensions		Style Number	Base Price	Options (Add \$ to Base Price)		
D	W			Wood	Wood	Full-Fill Finish on Wood
				Group 2	Group 3	Group 1
36"	60"	CW_J3660	\$ 2407	+\$ 69	+\$ 242	+\$ 46
	66"	CW_J3666	\$ 2586	+\$ 96	+\$ 335	+\$ 46
	72"	CW_J3672	\$ 2775	+\$ 96	+\$ 335	+\$ 46
	84"	CW_J3684	\$ 3146	+\$124	+\$ 436	+\$ 46
42"	72"	CW_J4272	\$ 3156	+\$124	+\$ 436	+\$ 46
	84"	CW_J4284	\$ 3456	+\$124	+\$ 436	+\$ 46
	96"	CW_J4296	\$ 3899	+\$157	+\$ 546	+\$ 46
	108"	CW_J42108	\$ 4352	+\$157	+\$ 546	+\$ 69
48"	84"	CW_J4884	\$ 3797	+\$157	+\$ 546	+\$ 46
	96"	CW_J4896	\$ 4024	+\$157	+\$ 546	+\$ 69
	108"	CW_J48108	\$ 4916	+\$203	+\$ 709	+\$ 69
	120"	CW_J48120	\$ 6019	+\$203	+\$ 709	+\$ 69
54"	108"	CW_J54108	\$ 5638	+\$229	+\$ 804	+\$ 69
	120"	CW_J54120	\$ 6547	+\$229	+\$ 804	+\$ 91
	144"	CW_J54144	\$ 7775	+\$285	+\$ 999	+\$ 91
60"	120"	CW_J60120	\$ 6996	+\$252	+\$ 882	+\$ 91
	144"	CW_J60144	\$ 9406	+\$303	+\$1061	+\$115
	168"	CW_J60168	\$12,321	+\$322	+\$1124	+\$115
66"	144"	CW_J66144	\$10,432	+\$322	+\$1124	+\$115
	168"	CW_J66168	\$12,844	+\$368	+\$1287	+\$138
	192"	CW_J66192	\$14,009	+\$413	+\$1443	+\$138
72"	168"	CW_J72168	\$14,996	+\$413	+\$1443	+\$138
	192"	CW_J72192	\$16,524	+\$459	+\$1606	+\$161
	216"	CW_J72216	\$17,931	+\$505	+\$1771	+\$183



Rectangular Wood Conference Table Tops

SIN 711.11

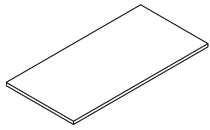

Standard Includes	Required to Specify
-------------------	---------------------

- | | |
|---|--|
| <ul style="list-style-type: none"> Table top: wood group 1 veneer with solid wood edge | <ul style="list-style-type: none"> 1 Style number with appropriate edge profile letter indicated in the space provided (For example, CW_T3660 becomes CWFT3660 for flat edge profile) <ul style="list-style-type: none"> ▶ See edge profiles at right. 2 Wood veneer color number for top 3 Options, if selected (see below) <ul style="list-style-type: none"> ▶ See <i>Surface Materials</i>, page 154. |
|---|--|

	Options	Price	Required to Specify
--	---------	-------	---------------------

Surface Materials	• Wood group 2	Prices at right	Specify wood color number. Specify wood color number. Specify <i>with Customiz stain</i> . ▶ See <i>Surface Materials Reference Manual</i> . Specify full-fill finish number.
	• Wood group 3	Prices at right	
	• Customiz stain on wood	No cost	
	• Full-fill finish on wood group 1	Prices at right	

- | | |
|---------------------------|--|
| Additional Options | ▶ See <i>Availability of Conference Top Options</i> , pages 78–80. |
| | ▶ See <i>Specifying Conference Top Options</i> , page 81. |

Tip: Your specification is not complete until you add a third letter to the style number to define the table top edge profile.

**Standard Edge Profiles
For Tops 60"W-120"W**

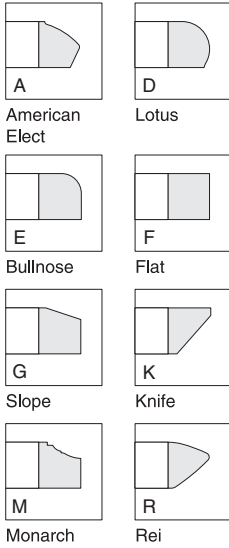

**Large Edge Profiles
For Tops 144"W and
Wider**

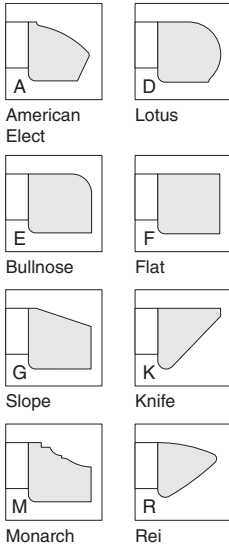

Specification Information

Dimensions		Style Number	Base Price	Options (Add \$ to Base Price)		
D	W			Wood	Wood	Full-Fill Finish on Wood
				Group 2	Group 3	Group 1
36"	60"	CW_T3660	\$ 2073	+\$ 69	+\$ 242	+\$ 46
	66"	CW_T3666	\$ 2230	+\$ 96	+\$ 335	+\$ 46
	72"	CW_T3672	\$ 2389	+\$ 96	+\$ 335	+\$ 46
	84"	CW_T3684	\$ 2709	+\$124	+\$ 436	+\$ 46
42"	72"	CW_T4272	\$ 2718	+\$124	+\$ 436	+\$ 46
	84"	CW_T4284	\$ 2978	+\$124	+\$ 436	+\$ 46
	96"	CW_T4296	\$ 3357	+\$157	+\$ 546	+\$ 46
	108"	CW_T42108	\$ 3747	+\$157	+\$ 546	+\$ 69
48"	84"	CW_T4884	\$ 3270	+\$157	+\$ 546	+\$ 46
	96"	CW_T4896	\$ 3469	+\$157	+\$ 546	+\$ 69
	108"	CW_T48108	\$ 4234	+\$203	+\$ 709	+\$ 69
	120"	CW_T48120	\$ 5184	+\$203	+\$ 709	+\$ 69
	144"	CW_T48144	\$ 5717	+\$252	+\$ 882	+\$ 91
54"	108"	CW_T54108	\$ 4856	+\$229	+\$ 804	+\$ 69
	120"	CW_T54120	\$ 5636	+\$229	+\$ 804	+\$ 91
	144"	CW_T54144	\$ 6695	+\$285	+\$ 999	+\$ 91
	168"	CW_T54168	\$ 8110	+\$322	+\$1124	+\$115
60"	120"	CW_T60120	\$ 6025	+\$252	+\$ 882	+\$ 91
	144"	CW_T60144	\$ 8100	+\$303	+\$1061	+\$115
	168"	CW_T60168	\$10,612	+\$322	+\$1124	+\$115
	192"	CW_T60192	\$10,950	+\$368	+\$1287	+\$138
	216"	CW_T60216	\$11,293	+\$413	+\$1443	+\$161
66"	144"	CW_T66144	\$ 9485	+\$322	+\$1124	+\$115
	168"	CW_T66168	\$11,677	+\$368	+\$1287	+\$138
	192"	CW_T66192	\$12,739	+\$413	+\$1443	+\$138
	216"	CW_T66216	\$14,751	+\$459	+\$1606	+\$161
72"	168"	CW_T72168	\$13,627	+\$413	+\$1443	+\$138
	192"	CW_T72192	\$15,020	+\$459	+\$1606	+\$161
	216"	CW_T72216	\$16,301	+\$505	+\$1771	+\$183

Boat-Shape Wood Conference Table Tops

SIN 711.11

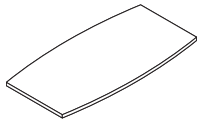

Standard Includes	Required to Specify
-------------------	---------------------

- | | |
|---|--|
| <ul style="list-style-type: none"> Table top: wood group 1 veneer with solid wood edge | <ol style="list-style-type: none"> Style number with appropriate edge profile letter indicated in the space provided (For example, CW_B3660 becomes CWFB3660 for flat edge profile) <ul style="list-style-type: none"> ▶ See edge profiles at right. Wood veneer color number for top Options, if selected (see below) <ul style="list-style-type: none"> ▶ See <i>Surface Materials</i>, page 154. |
|---|--|

	Options	Price	Required to Specify
--	---------	-------	---------------------

Surface Materials	• Wood group 2	Prices at right	Specify wood color number. Specify wood color number. Specify <i>with Customiz stain</i> . ▶ See <i>Surface Materials Reference Manual</i> . Specify full-fill finish number.
	• Wood group 3	Prices at right	
	• Customiz stain on wood	No cost	
	• Full-fill finish on wood group 1	Prices at right	

- | | |
|---------------------------|--|
| Additional Options | ▶ See <i>Availability of Conference Top Options</i> , pages 78–80. |
| | ▶ See <i>Specifying Conference Top Options</i> , page 81. |

Tip: Your specification is not complete until you add a third letter to the style number to define the table top edge profile.

Standard Edge Profiles For Tops 60"W-120"W

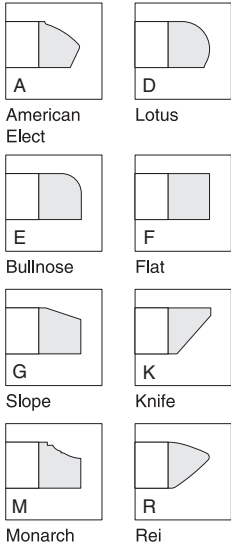

Large Edge Profiles For Tops 144"W and Wider

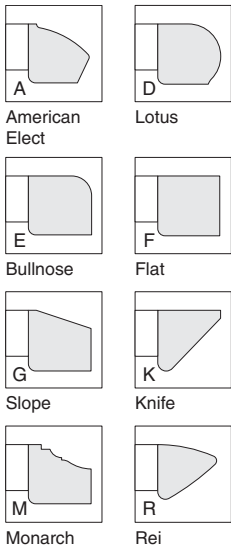

Specification Information

Dimensions		Style Number	Base Price	Options (Add \$ to Base Price)		
D	W			Wood	Wood Group 2	Full-Fill Finish on Wood Group 1
30"/36"	60"	CW_B3660	\$ 2407	+\$ 69	+\$ 242	+\$ 46
	66"	CW_B3666	\$ 2586	+\$ 96	+\$ 335	+\$ 46
	72"	CW_B3672	\$ 2775	+\$ 96	+\$ 335	+\$ 46
	84"	CW_B3684	\$ 3146	+\$124	+\$ 436	+\$ 46
36"/42"	72"	CW_B4272	\$ 3156	+\$124	+\$ 436	+\$ 46
	84"	CW_B4284	\$ 3456	+\$124	+\$ 436	+\$ 46
	96"	CW_B4296	\$ 3899	+\$157	+\$ 546	+\$ 46
	108"	CW_B42108	\$ 4352	+\$157	+\$ 546	+\$ 69
41"/48"	84"	CW_B4884	\$ 3797	+\$157	+\$ 546	+\$ 46
	96"	CW_B4896	\$ 4024	+\$157	+\$ 546	+\$ 69
	108"	CW_B48108	\$ 4916	+\$203	+\$ 709	+\$ 69
	120"	CW_B48120	\$ 6019	+\$203	+\$ 709	+\$ 69
46"/54"	144"	CW_B48144	\$ 6638	+\$252	+\$ 882	+\$ 91
	108"	CW_B54108	\$ 5638	+\$229	+\$ 804	+\$ 69
	120"	CW_B54120	\$ 6547	+\$229	+\$ 804	+\$ 91
	144"	CW_B54144	\$ 7775	+\$285	+\$ 999	+\$ 91
51"/60"	168"	CW_B54168	\$ 9417	+\$322	+\$1124	+\$115
	120"	CW_B60120	\$ 6996	+\$252	+\$ 882	+\$ 91
	144"	CW_B60144	\$ 9406	+\$303	+\$1061	+\$115
	168"	CW_B60168	\$12,321	+\$322	+\$1124	+\$115
56"/66"	192"	CW_B60192	\$12,714	+\$368	+\$1287	+\$138
	216"	CW_B60216	\$13,113	+\$413	+\$1443	+\$161
	144"	CW_B66144	\$10,432	+\$322	+\$1124	+\$115
	168"	CW_B66168	\$12,844	+\$368	+\$1287	+\$138
61"/72"	192"	CW_B66192	\$14,009	+\$413	+\$1443	+\$138
	216"	CW_B66216	\$16,228	+\$459	+\$1606	+\$161
	168"	CW_B72168	\$14,996	+\$413	+\$1443	+\$138
	192"	CW_B72192	\$16,524	+\$459	+\$1606	+\$161
216"	CW_B72216	\$17,931	+\$505	+\$1771	+\$183	

Racetrack Wood Conference Table Tops

SIN 711.11



Standard Includes	Required to Specify
-------------------	---------------------

- | | |
|---|--|
| <ul style="list-style-type: none"> • Table top: wood group 1 veneer with solid wood edge | <ul style="list-style-type: none"> 1 Style number with appropriate edge profile letter indicated in the space provided (For example, CW_K3660 becomes CWFK3660 for flat edge profile) ▶ See edge profiles at right. 2 Wood veneer color number for top 3 Options, if selected (see below) ▶ See <i>Surface Materials</i>, page 154. |
|---|--|

	Options	Price	Required to Specify
--	---------	-------	---------------------

- | | | | |
|--------------------------|--|---|---|
| Surface Materials | <ul style="list-style-type: none"> • Wood group 2 • Wood group 3 • Customiz stain on wood | <ul style="list-style-type: none"> Prices at right Prices at right No cost | <ul style="list-style-type: none"> Specify wood color number. Specify wood color number. Specify <i>with Customiz stain</i>. ▶ See <i>Surface Materials Reference Manual</i>. Specify full-fill finish number. |
| | <ul style="list-style-type: none"> • Full-fill finish on wood group 1 | <ul style="list-style-type: none"> Prices at right | |

- | | |
|---------------------------|---|
| Additional Options | <ul style="list-style-type: none"> ▶ See <i>Availability of Conference Top Options</i>, pages 78–80. ▶ See <i>Specifying Conference Top Options</i>, page 81. |
|---------------------------|---|

Tip: Your specification is not complete until you add a third letter to the style number to define the table top edge profile.

**Standard Edge Profiles
For Tops 60"W-120"W**

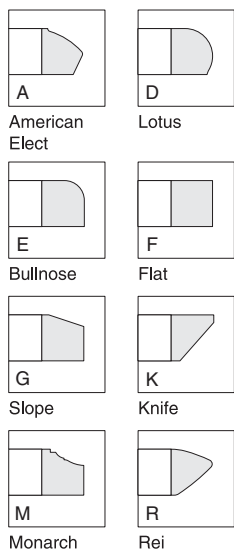

**Large Edge Profiles
For Tops 144"W and
Wider**

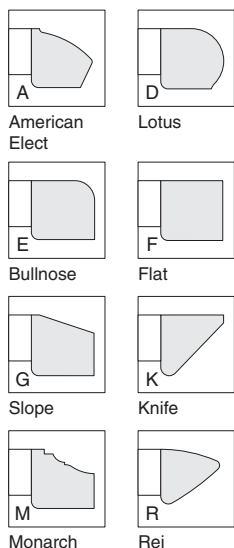

Specification Information

Dimensions		Style Number	Base Price	Options (Add \$ to Base Price)		
D	W			Wood	Wood Group 2	Wood Group 3
36"	60"	CW_K3660	\$ 2298	+\$ 69	+\$ 242	+\$ 46
	66"	CW_K3666	\$ 2470	+\$ 96	+\$ 335	+\$ 46
	72"	CW_K3672	\$ 2647	+\$ 96	+\$ 335	+\$ 46
	84"	CW_K3684	\$ 3002	+\$124	+\$ 436	+\$ 46
42"	72"	CW_K4272	\$ 3012	+\$124	+\$ 436	+\$ 46
	84"	CW_K4284	\$ 3299	+\$124	+\$ 436	+\$ 46
	96"	CW_K4296	\$ 3720	+\$157	+\$ 546	+\$ 46
	108"	CW_K42108	\$ 4153	+\$157	+\$ 546	+\$ 69
48"	84"	CW_K4884	\$ 3623	+\$157	+\$ 546	+\$ 46
	96"	CW_K4896	\$ 3840	+\$157	+\$ 546	+\$ 69
	108"	CW_K48108	\$ 4691	+\$203	+\$ 709	+\$ 69
	120"	CW_K48120	\$ 5746	+\$203	+\$ 709	+\$ 69
54"	144"	CW_K48144	\$ 6338	+\$252	+\$ 882	+\$ 91
	108"	CW_K54108	\$ 5382	+\$229	+\$ 804	+\$ 69
	120"	CW_K54120	\$ 6250	+\$229	+\$ 804	+\$ 91
	144"	CW_K54144	\$ 7419	+\$285	+\$ 999	+\$ 91
60"	168"	CW_K54168	\$ 8988	+\$322	+\$1124	+\$115
	120"	CW_K60120	\$ 6678	+\$252	+\$ 882	+\$ 91
	144"	CW_K60144	\$ 8979	+\$303	+\$1061	+\$115
	168"	CW_K60168	\$11,762	+\$322	+\$1124	+\$115
66"	192"	CW_K60192	\$12,135	+\$368	+\$1287	+\$138
	216"	CW_K60216	\$12,517	+\$413	+\$1443	+\$161
	144"	CW_K66144	\$ 9959	+\$322	+\$1124	+\$115
	168"	CW_K66168	\$12,261	+\$368	+\$1287	+\$138
72"	192"	CW_K66192	\$13,372	+\$413	+\$1443	+\$138
	216"	CW_K66216	\$15,488	+\$459	+\$1606	+\$161
	168"	CW_K72168	\$14,312	+\$413	+\$1443	+\$138
	192"	CW_K72192	\$15,772	+\$459	+\$1606	+\$161
216"	CW_K72216	\$17,115	+\$505	+\$1771	+\$183	



Round Laminate Conference Table Tops

SIN 711.11



Tip: Your specification is not complete until you add a third letter to the style number to define the table top edge profile.

For laminate price group 2 pricing, please refer to the electronic catalog or SmartTools.

Standard Edge Profiles For Diameter Tops 36"–60"

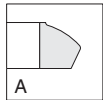

American Elect

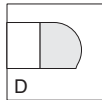

Lotus

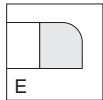

Bullnose

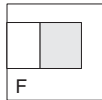

Flat

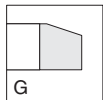

Slope

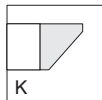

Knife

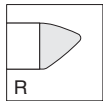

Rei

Large Edge Profiles For Diameter Tops 66"–72"

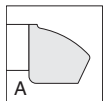

American Elect

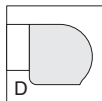

Lotus

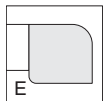

Bullnose

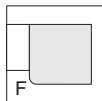

Flat

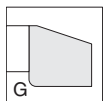

Slope

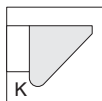

Knife

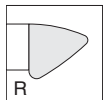

Rei

Standard Includes	Required to Specify
-------------------	---------------------

- Table top: laminate price group 1 with solid wood group 1 edge

- 1 Style number with appropriate edge profile letter indicated in the space provided (For example, CL_R36 becomes CLFR36 for flat edge profile)
 - ▶ See edge profiles below.
- 2 Laminate color number for top
- 3 Wood finish number for edge profile
- 4 Options, if selected (see below)
 - ▶ See *Surface Materials*, page 154.

Surface Materials	Options	Price	Required to Specify
-------------------	---------	-------	---------------------

Surface Materials

- Wood group 2 on wood edge profile: Prices below
- Wood group 3 on wood edge profile: Prices below
- Customiz stain on wood edge profile: No cost
- High-Pressure Laminate price group 2: See information at left
- Open Line laminate: +\$69 plus cost of laminate

Specify wood color number.

Specify wood color number.

- Specify with *Customiz stain*.
- ▶ See *Surface Materials Reference Manual*. Specify High-Pressure Laminate color number.
- ▶ See *Surface Materials Reference Manual*.

Additional Options

- ▶ See *Availability of Conference Top Options*, pages 78–80.
- ▶ See *Specifying Conference Top Options*, page 81.

Specification Information

Diameter	Style Number	Base Price	Options (Add \$ to Base Price)	
			Wood on Edge Group 2	Wood on Edge Group 3
36"	CL_R36	\$1344	+\$ 28	+\$ 94
42"	CL_R42	\$1622	+\$ 32	+\$110
48"	CL_R48	\$2036	+\$ 32	+\$110
54"	CL_R54	\$2645	+\$ 65	+\$226
60"	CL_R60	\$3073	+\$ 65	+\$226
66"	CL_R66	\$3713	+\$ 78	+\$274
72"	CL_R72	\$4330	+\$100	+\$352

Square Laminate Conference Table Tops

SIN 711.11

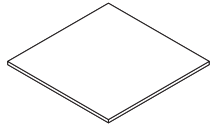

Tip: Your specification is not complete until you add a third letter to the style number to define the table top edge profile.

For laminate price group 2 pricing, please refer to the electronic catalog or SmartTools.

Standard Edge Profiles For Tops 36"W-60"W

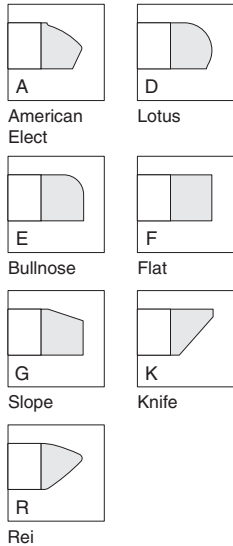

Standard Includes	Required to Specify
-------------------	---------------------

<ul style="list-style-type: none"> Table top: laminate price group 1 with solid wood group 1 edge 	<ol style="list-style-type: none"> Style number with appropriate edge profile letter indicated in the space provided (For example, CL_S36 becomes CLFS36 for flat edge profile) <ul style="list-style-type: none"> ▶ See edge profiles below. Laminate color number for top Wood finish number for edge profile Options, if selected (see below) <ul style="list-style-type: none"> ▶ See <i>Surface Materials</i>, page 154.
--	---

Surface Materials	Options	Price	Required to Specify
-------------------	---------	-------	---------------------

<ul style="list-style-type: none"> Wood group 2 on wood edge profile Wood group 3 on wood edge profile Customiz stain on wood edge profile High-Pressure Laminate price group 2 Open Line laminate 	<ul style="list-style-type: none"> Wood group 2 on wood edge profile Wood group 3 on wood edge profile Customiz stain on wood edge profile High-Pressure Laminate price group 2 Open Line laminate 	<ul style="list-style-type: none"> Prices below Prices below No cost See information at left +\$69 plus cost of laminate 	<ul style="list-style-type: none"> Specify wood color number. Specify wood color number. Specify with <i>Customiz stain</i>. ▶ See <i>Surface Materials Reference Manual</i>. Specify High-Pressure Laminate color number. ▶ See <i>Surface Materials Reference Manual</i>.
---	---	---	--

Additional Options ▶ See *Availability of Conference Top Options*, pages 78–80.
▶ See *Specifying Conference Top Options*, page 81.

Specification Information

Dimensions		Style Number	Base Price	Options (Add \$ to Base Price)	
D	W			<u>Wood on Edge</u>	
				Wood Group 2	Wood Group 3
36"	36"	CL_S36	\$1103	+\$28	+\$ 94
42"	42"	CL_S42	\$1326	+\$32	+\$110
48"	48"	CL_S48	\$1671	+\$32	+\$110
54"	54"	CL_S54	\$2373	+\$65	+\$226
60"	60"	CL_S60	\$3155	+\$65	+\$226

Convене

Cushion Laminate Conference Table Tops

SIN 711.11

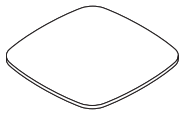

Tip: Your specification is not complete until you add a third letter to the style number to define the table top edge profile.

For laminate price group 2 pricing, please refer to the electronic catalog or SmartTools.

Standard Edge Profiles For Tops 36"W-60"W

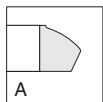

American Elect

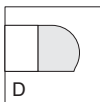

Lotus

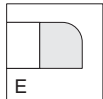

Bullnose

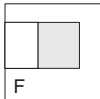

Flat

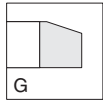

Slope

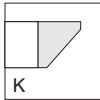

Knife

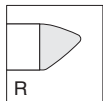

Rei

Standard Includes	Required to Specify
-------------------	---------------------

- Table top: laminate price group 1 with solid wood group 1 edge

- Style number with appropriate edge profile letter indicated in the space provided (For example, CL_C36 becomes CLFC36 for flat edge profile)
 - ▶ See edge profiles below.
- Laminate color number for top
- Wood finish number for edge profile
- Options, if selected (see below)
 - ▶ See *Surface Materials*, page 154.

Surface Materials	Options	Price	Required to Specify
-------------------	---------	-------	---------------------

Surface Materials	• Wood group 2 on wood edge profile	Prices below	Specify wood color number.
	• Wood group 3 on wood edge profile	Prices below	Specify wood color number.
	• Customiz stain on wood edge profile	No cost	Specify <i>with Customiz stain</i> .
	• High-Pressure Laminate price group 2	See information at left	▶ See <i>Surface Materials Reference Manual</i> . Specify High-Pressure Laminate color number.
	• Open Line laminate	+\$69 plus cost of laminate	▶ See <i>Surface Materials Reference Manual</i> .

Additional Options ▶ See *Availability of Conference Top Options*, pages 78–80.
 ▶ See *Specifying Conference Top Options*, page 81.

Specification Information

• Dimensions		• Style	• Base	• Options	
D	W	Number	Price	(Add \$ to Base Price)	
36"	36"	CL_C36	\$1324	+\$28	+\$ 94
42"	42"	CL_C42	\$1595	+\$32	+\$110
48"	48"	CL_C48	\$2005	+\$32	+\$110
54"	54"	CL_C54	\$2848	+\$65	+\$226
60"	60"	CL_C60	\$3783	+\$65	+\$226

• Wood on Edge	
Wood Group 2	Wood Group 3
+	+

Oval Laminate Conference Table Tops

SIN 711.11



Tip: Your specification is not complete until you add a third letter to the style number to define the table top edge profile.

For laminate price group 2 pricing, please refer to the electronic catalog or SmartTools.

Standard Includes	Required to Specify
-------------------	---------------------

<ul style="list-style-type: none"> Table top: laminate price group 1 with solid wood group 1 edge 	<ol style="list-style-type: none"> Style number with appropriate edge profile letter indicated in the space provided (For example, CL_J3660 becomes CLFJ3660 for flat edge profile) <ul style="list-style-type: none"> ▶ See edge profiles below. Laminate color number for top Wood finish number for edge profile Options, if selected (see below) <ul style="list-style-type: none"> ▶ See <i>Surface Materials</i>, page 154.
--	---

Surface Materials	Options	Price	Required to Specify
-------------------	---------	-------	---------------------

Surface Materials	• Wood group 2 on wood edge profile	Prices at right	Specify wood color number.
	• Wood group 3 on wood edge profile	Prices at right	Specify wood color number.
	• Customiz stain on wood edge profile	No cost	Specify <i>with Customiz stain</i> .
	• High-Pressure Laminate price group 2	See information at left	▶ See <i>Surface Materials Reference Manual</i> . Specify High-Pressure Laminate color number.
	• Open Line laminate	+\$69 plus cost of laminate	▶ See <i>Surface Materials Reference Manual</i> .

Additional Options ▶ See *Availability of Conference Top Options*, pages 78–80.
 ▶ See *Specifying Conference Top Options*, page 81.

Standard Edge Profiles For Tops 60"W–120"W

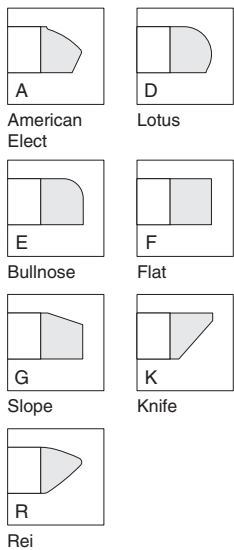

Large Edge Profiles For Tops 144"W and Wider

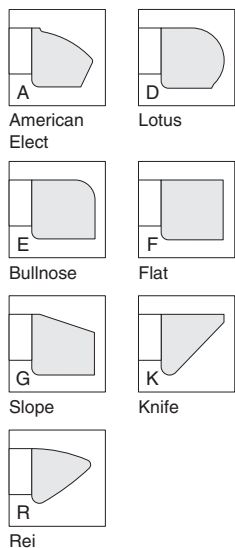

Specification Information					
Dimensions		Style Number	Base Price	Options	
D	W			(Add \$ to Base Price)	
				Wood on Edge	
				Wood Group 2	Wood Group 3
36"	60"	CL_J3660	\$ 2281	+\$ 32	+\$110
	66"	CL_J3666	\$ 2452	+\$ 47	+\$164
	72"	CL_J3672	\$ 2628	+\$ 47	+\$164
	84"	CL_J3684	\$ 2980	+\$ 65	+\$226
42"	72"	CL_J4272	\$ 2990	+\$ 65	+\$226
	84"	CL_J4284	\$ 3275	+\$ 65	+\$226
	96"	CL_J4296	\$ 3692	+\$ 78	+\$274
	108"	CL_J42108	\$ 4125	+\$ 78	+\$274
48"	84"	CL_J4884	\$ 3596	+\$ 78	+\$274
	96"	CL_J4896	\$ 3812	+\$ 78	+\$274
	108"	CL_J48108	\$ 4657	+\$100	+\$352
	120"	CL_J48120	\$ 5702	+\$100	+\$352
54"	108"	CL_J54108	\$ 5342	+\$116	+\$407
	120"	CL_J54120	\$ 6202	+\$116	+\$407
	144"	CL_J54144	\$ 7365	+\$138	+\$485
60"	120"	CL_J60120	\$ 6629	+\$124	+\$436
	144"	CL_J60144	\$ 8911	+\$153	+\$531
	168"	CL_J60168	\$11,672	+\$161	+\$561
66"	144"	CL_J66144	\$ 9883	+\$161	+\$561
	168"	CL_J66168	\$12,169	+\$181	+\$640
	192"	CL_J66192	\$13,275	+\$208	+\$726
72"	168"	CL_J72168	\$14,202	+\$208	+\$726
	192"	CL_J72192	\$15,656	+\$229	+\$804
	216"	CL_J72216	\$16,988	+\$252	+\$882



Rectangular Laminate Conference Table Tops

SIN 711.11

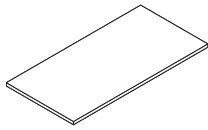

Standard Includes	Required to Specify
-------------------	---------------------

- Table top: laminate price group 1 with solid wood group 1 edge

- 1 Style number with appropriate edge profile letter indicated in the space provided (For example, CL_T3660 becomes CLFT3660 for flat edge profile)
 - ▶ See edge profiles at right.
- 2 Laminate color number for top
- 3 Wood finish number for edge profile
- 4 Options, if selected (see below)
 - ▶ See *Surface Materials*, page 154.

Surface Materials	Options	Price	Required to Specify
-------------------	---------	-------	---------------------

Surface Materials	• Wood group 2 on wood edge profile	Prices at right	Specify wood color number.
	• Wood group 3 on wood edge profile	Prices at right	Specify wood color number.
	• Customiz stain on wood edge profile	No cost	Specify <i>with Customiz stain</i> . ▶ See <i>Surface Materials Reference Manual</i> .
	• High-Pressure Laminate price group 2	See information at left	Specify High-Pressure Laminate color number. ▶ See <i>Surface Materials Reference Manual</i> .
	• Open Line laminate	+\$69 plus cost of laminate	

For laminate price group 2 pricing, please refer to the electronic catalog or SmartTools.

- | | |
|---------------------------|---|
| Additional Options | <ul style="list-style-type: none"> ▶ See <i>Availability of Conference Top Options</i>, pages 78–80. ▶ See <i>Specifying Conference Top Options</i>, page 81. |
|---------------------------|---|

Tip: Your specification is not complete until you add a third letter to the style number to define the table top edge profile.

**Standard Edge Profiles
For Tops 60"W-120"W**

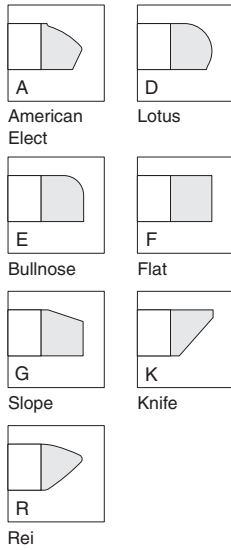

**Large Edge Profiles
For Tops 144"W and
Wider**

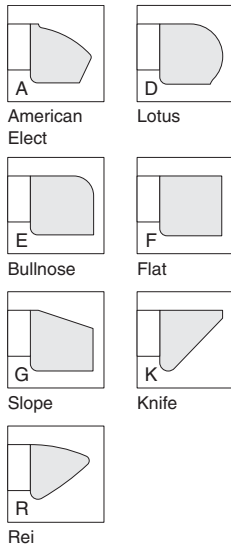

Specification Information

Dimensions		Style Number	Base Price	Options (Add \$ to Base Price)	
D	W			Wood Group 2	Wood Group 3
36"	60"	CL_T3660	\$ 1968	+\$ 32	+\$110
	66"	CL_T3666	\$ 2118	+\$ 47	+\$164
	72"	CL_T3672	\$ 2268	+\$ 47	+\$164
	84"	CL_T3684	\$ 2573	+\$ 65	+\$226
42"	72"	CL_T4272	\$ 2581	+\$ 65	+\$226
	84"	CL_T4284	\$ 2827	+\$ 65	+\$226
	96"	CL_T4296	\$ 3190	+\$ 78	+\$274
	108"	CL_T42108	\$ 3564	+\$ 78	+\$274
48"	84"	CL_T4884	\$ 3108	+\$ 78	+\$274
	96"	CL_T4896	\$ 3290	+\$ 78	+\$274
	108"	CL_T48108	\$ 4021	+\$100	+\$352
	120"	CL_T48120	\$ 4926	+\$100	+\$352
	144"	CL_T48144	\$ 5431	+\$124	+\$436
54"	108"	CL_T54108	\$ 4613	+\$116	+\$407
	120"	CL_T54120	\$ 5355	+\$116	+\$407
	144"	CL_T54144	\$ 6360	+\$138	+\$485
	168"	CL_T54168	\$ 7704	+\$161	+\$561
60"	120"	CL_T60120	\$ 5725	+\$124	+\$436
	144"	CL_T60144	\$ 7696	+\$153	+\$531
	168"	CL_T60168	\$10,082	+\$161	+\$561
	192"	CL_T60192	\$10,403	+\$181	+\$640
	216"	CL_T60216	\$10,729	+\$208	+\$726
66"	144"	CL_T66144	\$ 8987	+\$161	+\$561
	168"	CL_T66168	\$11,061	+\$181	+\$640
	192"	CL_T66192	\$12,065	+\$208	+\$726
	216"	CL_T66216	\$13,977	+\$229	+\$804
72"	168"	CL_T72168	\$12,912	+\$208	+\$726
	192"	CL_T72192	\$14,232	+\$229	+\$804
	216"	CL_T72216	\$15,445	+\$252	+\$882



Boat-Shape Laminate Conference Table Tops

SIN 711.11

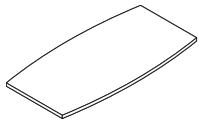

Standard Includes	Required to Specify
-------------------	---------------------

- Table top: laminate price group 1 with solid wood group 1 edge

- 1 Style number with appropriate edge profile letter indicated in the space provided (For example, CL_B3660 becomes CLFB3660 for flat edge profile)
 - ▶ See edge profiles at right.
- 2 Laminate color number for top
- 3 Wood finish number for edge profile
- 4 Options, if selected (see below)
 - ▶ See *Surface Materials*, page 154.

Surface Materials	Options	Price	Required to Specify
-------------------	---------	-------	---------------------

Surface Materials	• Wood group 2 on wood edge profile	Prices at right	Specify wood color number.
	• Wood group 3 on wood edge profile	Prices at right	Specify wood color number.
	• Customiz stain on wood edge profile	No cost	Specify <i>with Customiz stain</i> . ▶ See <i>Surface Materials Reference Manual</i> .
	• High-Pressure Laminate price group 2	See information at left	Specify High-Pressure Laminate color number.
	• Open Line laminate	+\$69 plus cost of laminate	▶ See <i>Surface Materials Reference Manual</i> .

For laminate price group 2 pricing, please refer to the electronic catalog or SmartTools.

Additional Options

- ▶ See *Availability of Conference Top Options*, pages 78–80.
- ▶ See *Specifying Conference Top Options*, page 81.

Tip: Your specification is not complete until you add a third letter to the style number to define the table top edge profile.

Standard Edge Profiles For Tops 60"W-120"W

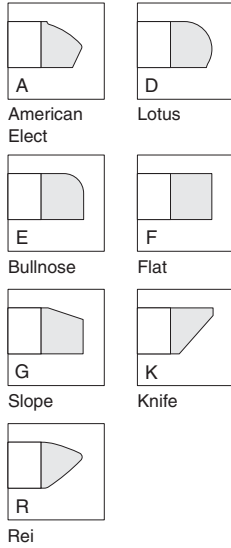

Large Edge Profiles For Tops 144"W and Wider

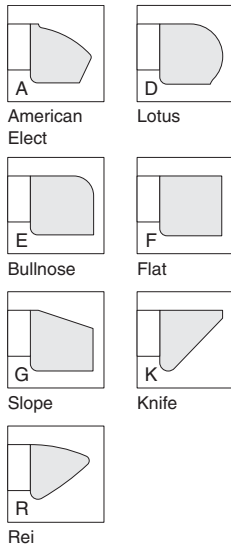

Specification Information

Dimensions		Style Number	Base Price	Options (Add \$ to Base Price)	
D	W			Wood Group 2	Wood Group 3
30"/36"	60"	CL_B3660	\$ 2281	+\$ 32	+\$110
	66"	CL_B3666	\$ 2452	+\$ 47	+\$164
	72"	CL_B3672	\$ 2628	+\$ 47	+\$164
	84"	CL_B3684	\$ 2980	+\$ 65	+\$226
36"/42"	72"	CL_B4272	\$ 2990	+\$ 65	+\$226
	84"	CL_B4284	\$ 3275	+\$ 65	+\$226
	96"	CL_B4296	\$ 3692	+\$ 78	+\$274
	108"	CL_B42108	\$ 4125	+\$ 78	+\$274
41"/48"	84"	CL_B4884	\$ 3596	+\$ 78	+\$274
	96"	CL_B4896	\$ 3814	+\$ 78	+\$274
	108"	CL_B48108	\$ 4657	+\$100	+\$352
	120"	CL_B48120	\$ 5702	+\$100	+\$352
	144"	CL_B48144	\$ 6288	+\$124	+\$436
46"/54"	108"	CL_B54108	\$ 5342	+\$116	+\$407
	120"	CL_B54120	\$ 6202	+\$116	+\$407
	144"	CL_B54144	\$ 7364	+\$138	+\$485
	168"	CL_B54168	\$ 8920	+\$161	+\$561
51"/60"	120"	CL_B60120	\$ 6629	+\$124	+\$436
	144"	CL_B60144	\$ 8909	+\$153	+\$531
	168"	CL_B60168	\$11,672	+\$161	+\$561
	192"	CL_B60192	\$12,046	+\$181	+\$640
	216"	CL_B60216	\$12,423	+\$208	+\$726
56"/66"	144"	CL_B66144	\$ 9883	+\$161	+\$561
	168"	CL_B66168	\$12,169	+\$181	+\$640
	192"	CL_B66192	\$13,275	+\$208	+\$726
	216"	CL_B66216	\$15,373	+\$229	+\$804
61"/72"	168"	CL_B72168	\$14,202	+\$208	+\$726
	192"	CL_B72192	\$15,656	+\$229	+\$804
	216"	CL_B72216	\$16,988	+\$252	+\$882

Convене

Racetrack Laminate Conference Table Tops

SIN 711.11



Standard Includes	Required to Specify
-------------------	---------------------

- Table top: laminate price group 1 with solid wood group 1 edge

- 1 Style number with appropriate edge profile letter indicated in the space provided (For example, CL_K3660 becomes CLFK3660 for flat edge profile)
 - ▶ See edge profiles at right.
- 2 Laminate color number for top
- 3 Wood finish number for edge profile
- 4 Options, if selected (see below)
 - ▶ See *Surface Materials*, page 154.

Surface Materials	Options	Price	Required to Specify
-------------------	---------	-------	---------------------

Surface Materials

- | | | |
|--|-----------------------------|--|
| • Wood group 2 on wood edge profile | Prices at right | |
| • Wood group 3 on wood edge profile | Prices at right | |
| • Customiz stain on wood edge profile | No cost | |
| • High-Pressure Laminate price group 2 | See information at left | |
| • Open Line laminate | +\$69 plus cost of laminate | |

- Specify wood color number.
- Specify wood color number.
- Specify *with Customiz stain*.
- ▶ See *Surface Materials Reference Manual*. Specify High-Pressure Laminate color number.
 - ▶ See *Surface Materials Reference Manual*.

For laminate price group 2 pricing, please refer to the electronic catalog or SmartTools.

Additional Options

- ▶ See *Availability of Conference Top Options*, pages 78–80.
- ▶ See *Specifying Conference Top Options*, page 81.

Tip: Your specification is not complete until you add a third letter to the style number to define the table top edge profile.

**Standard Edge Profiles
For Tops 60"W-120"W**

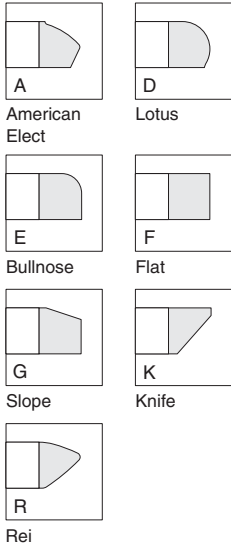

**Large Edge Profiles
For Tops 144"W and
Wider**

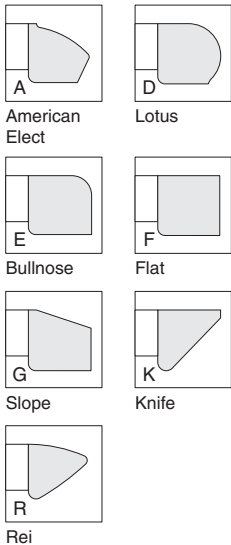

Specification Information

Dimensions		Style Number	Base Price	Options (Add \$ to Base Price)	
D	W			Wood Group 2	Wood Group 3
36"	60"	CL_K3660	\$ 2177	+\$ 32	+\$110
	66"	CL_K3666	\$ 2341	+\$ 47	+\$164
	72"	CL_K3672	\$ 2509	+\$ 47	+\$164
	84"	CL_K3684	\$ 2845	+\$ 65	+\$226
42"	72"	CL_K4272	\$ 2857	+\$ 65	+\$226
	84"	CL_K4284	\$ 3124	+\$ 65	+\$226
	96"	CL_K4296	\$ 3525	+\$ 78	+\$274
	108"	CL_K42108	\$ 3936	+\$ 78	+\$274
48"	84"	CL_K4884	\$ 3434	+\$ 78	+\$274
	96"	CL_K4896	\$ 3641	+\$ 78	+\$274
	108"	CL_K48108	\$ 4444	+\$100	+\$352
	120"	CL_K48120	\$ 5444	+\$100	+\$352
	144"	CL_K48144	\$ 6002	+\$124	+\$436
54"	108"	CL_K54108	\$ 5098	+\$116	+\$407
	120"	CL_K54120	\$ 5919	+\$116	+\$407
	144"	CL_K54144	\$ 7027	+\$138	+\$485
	168"	CL_K54168	\$ 8517	+\$161	+\$561
60"	120"	CL_K60120	\$ 6323	+\$124	+\$436
	144"	CL_K60144	\$ 8504	+\$153	+\$531
	168"	CL_K60168	\$11,142	+\$161	+\$561
	192"	CL_K60192	\$11,497	+\$181	+\$640
	216"	CL_K60216	\$11,859	+\$208	+\$726
66"	144"	CL_K66144	\$ 9432	+\$161	+\$561
	168"	CL_K66168	\$11,613	+\$181	+\$640
	192"	CL_K66192	\$12,668	+\$208	+\$726
	216"	CL_K66216	\$14,674	+\$229	+\$804
72"	168"	CL_K72168	\$13,560	+\$208	+\$726
	192"	CL_K72192	\$14,942	+\$229	+\$804
	216"	CL_K72216	\$16,214	+\$252	+\$882

Convене

Bases for Conference Tables

SIN 711.11

Metal Flex Bases

Tip: Power units and round ports cannot be used on tops supported by T- or X-flex bases.

Tip: Oval ports and power channels cannot be used on 54"D x 120"W oval tops supported by flex bases.

Standard Includes	Required to Specify
-------------------	---------------------

- Metal flex base: paint or metal
- Attachment hardware

- 1 Style number
- 2 Paint or metal color number for base:
0835 Black
4799 Platinum
- 3 Options, if selected (see below)
▶ See *Surface Materials*, page 154.

Surface Materials	Options	Price	Required to Specify
-------------------	---------	-------	---------------------

	T-flex base		
	• Brushed aluminum	+\$172	Specify with 8042 Brushed Aluminum.
	X-flex base		
	• Brushed aluminum	+\$172	Specify with 8042 Brushed Aluminum.

Specification Information				
• Dimensions			• Style	• Base
D	W	H	Number	Price

T-Flex Base

24"	24"	27½"	CFLEXT24	\$ 822
30"	30"	27½"	CFLEXT30	\$ 959
:	:	:	:	:

X-Flex Base

24"	24"	27½"	CFLEXX24	\$1247
30"	30"	27½"	CFLEXX30	\$1368
:	:	:	:	:

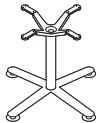
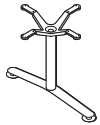

U- and X-Panel Bases

Tip: Power channels cannot be used on tops supported by X-panel bases.

Tip: Oval ports cannot be used on 54"D x 144"W oval tops supported by X-panel bases.

Standard Includes	Required to Specify
-------------------	---------------------

- | | |
|--|--|
| <ul style="list-style-type: none"> • U- or X-panel base: wood group 1 • Wire management cavity • Cylinder feet: paint or metal • Attachment hardware | <ol style="list-style-type: none"> 1 Style number 2 Wood color number for base 3 Paint or metal color number for feet:
0835 Black
4799 Platinum
8042 Brushed Aluminum 4 Options, if selected (see below)
▶ See <i>Surface Materials</i>, page 154. |
|--|--|

Options	Price	Required to Specify
---------	-------	---------------------

Surface Materials <ul style="list-style-type: none"> • Wood group 2 • Wood group 3 • Customiz stain on wood 	Prices below Prices below No cost	Specify wood color number. Specify wood color number. Specify with <i>Customiz stain</i> . ▶ See <i>Surface Materials Reference Manual</i> .
Foot Details <ul style="list-style-type: none"> • Square feet 	No cost	Specify with <i>square feet</i> and select 0835 Black, 4799 Platinum, or 8042 Brushed Aluminum.

Specification Information

Dimensions			Style Number	Base Price	Options	
D	W	H			(Add \$ to Base Price)	Wood



U-Panel

4"	18"	27½"	CWUPC418	\$1015	+\$ 47	+\$164
4"	24"	27½"	CWUPC424	\$1161	+\$ 69	+\$242
6"	30"	27½"	CWUPC630	\$1451	+\$ 96	+\$335
6"	36"	27½"	CWUPC636	\$1597	+\$116	+\$407
:	:	:	:	:	:	:



X-Panel

24"	24"	27½"	CWXPC424	\$1521	+\$ 69	+\$242
30"	30"	27½"	CWXPC630	\$1797	+\$ 96	+\$335
36"	36"	27½"	CWXPC636	\$1934	+\$116	+\$407
:	:	:	:	:	:	:

Bases for Conference Tables, continued

SIN 711.11

Rectangular Bases

Standard Includes	Required to Specify
<ul style="list-style-type: none"> Rectangular base: wood group 1 Removable panel for access to wire cavity Recessed toe kick on base, if selected: metallic finish Wood molding on base, if selected: wood to match base Glides: black plastic Attachment hardware 	<ol style="list-style-type: none"> Style number Wood color number for base Metallic finish color number for recessed toe kick, if selected: 0835 Black 8042 Brushed Aluminum 8046 Polished Aluminum Options, if selected (see below) ▶ See <i>Surface Materials</i>, page 154.

Options	Price	Required to Specify
Surface Materials <ul style="list-style-type: none"> Wood group 2 Wood group 3 Customiz stain on wood 	Prices below Prices below No cost	Specify wood color number. Specify wood color number. Specify with <i>Customiz stain</i> . ▶ See <i>Surface Materials Reference Manual</i> .

Specification Information						
• Dimensions			• Style	• Base	• Options	
D	W	H	Number	Price	(Add \$ to Base Price)	
					Wood	
					Wood	Wood
					Group 2	Group 3

With Recessed Toe Kick

18"	4"	27½"	CWREC418	\$ 899	+\$ 47	+\$164
24"	4"	27½"	CWREC424	\$ 966	+\$ 69	+\$242
30"	6"	27½"	CWREC630	\$1182	+\$ 96	+\$335
36"	6"	27½"	CWREC636	\$1346	+\$116	+\$407
:	:	:	:	:	:	:

With Wood Molding

18"	4"	27½"	CWRET418	\$1053	+\$ 47	+\$164
24"	4"	27½"	CWRET424	\$1142	+\$ 69	+\$242
30"	6"	27½"	CWRET630	\$1412	+\$ 96	+\$335
36"	6"	27½"	CWRET636	\$1624	+\$116	+\$407
:	:	:	:	:	:	:



Rectangular Bases with Feet



Standard Includes	Required to Specify
-------------------	---------------------

- | | |
|---|--|
| <ul style="list-style-type: none"> • Rectangular base: wood group 1 • Removable panel for access to wire cavity • Cylinder feet: paint or metal • Attachment hardware | <ol style="list-style-type: none"> 1 Style number 2 Wood color number for base 3 Paint or metal color number for feet:
0835 Black
4799 Platinum
8042 Brushed Aluminum 4 Options, if selected (see below)
▶ See <i>Surface Materials</i>, page 154. |
|---|--|

Options	Price	Required to Specify
---------	-------	---------------------

Surface Materials	<ul style="list-style-type: none"> • Wood group 2 • Wood group 3 • Customiz stain on wood 	Prices below Prices below No cost	Specify wood color number. Specify wood color number. Specify with <i>Customiz stain</i> . ▶ See <i>Surface Materials Reference Manual</i> .
Foot Detail	<ul style="list-style-type: none"> • Square feet 	No cost	Specify with <i>square feet</i> and select 0835 Black, 4799 Platinum, or 8042 Brushed Aluminum.

Specification Information

Dimensions			Style Number	Base Price	Options (Add \$ to Base Price)	
D	W	H			Wood Group 2	Wood Group 3
18"	4"	27½"	CWREF418	\$1035	+\$ 47	+\$164
24"	4"	27½"	CWREF424	\$1103	+\$ 69	+\$242
30"	6"	27½"	CWREF630	\$1318	+\$ 96	+\$335
36"	6"	27½"	CWREF636	\$1485	+\$116	+\$407



Bases for Conference Tables, continued

SIN 711.11

Freestanding Table Bases



Tip: Freestanding table base does not have cable routing capabilities.

Tip: No technology solution can be accommodated directly above the table base.

Standard Includes	Required to Specify
<ul style="list-style-type: none"> Table base: 4799 Platinum Metallic or 7207 Black Attachment hardware: black paint only 	<ul style="list-style-type: none"> 1 Style number 2 Color number: <ul style="list-style-type: none"> 4799 Platinum Metallic 7207 Black

Specification Information

Dimensions			Style	Quantity	Price
D	W	H	Number		
28"	28"	27½"	AWQT28	1	\$871

Freestanding Table Base

28"	28"	27½"	AWQT28	1	\$871
-----	-----	------	---------------	---	-------

Circular Drum Bases

Standard Includes	Required to Specify
<ul style="list-style-type: none"> • Circular drum base: wood group 1 • Removable panel for access to wire cavity • Hole in bottom of base for floor monument access • Recessed toe kick on base, if selected: metallic finish • Wood molding on base, if selected: wood to match base • Glides: black plastic • Attachment hardware 	<ol style="list-style-type: none"> 1 Style number 2 Wood color number for base 3 Metallic finish color number for recessed toe kick, if selected: <ul style="list-style-type: none"> 0835 Black 8042 Brushed Aluminum 8046 Polished Aluminum 4 Options, if selected (see below) <ul style="list-style-type: none"> ▶ See <i>Surface Materials</i>, page 154.

Options	Price	Required to Specify
Surface Materials <ul style="list-style-type: none"> • Wood group 2 • Wood group 3 • Customiz stain on wood 	Prices below Prices below No cost	Specify wood color number. Specify wood color number. Specify <i>with Customiz stain</i> . ▶ See <i>Surface Materials Reference Manual</i> .

Specification Information							
• Dimensions			• Style Number	• Base Price	• Options		
D	W	H			(Add \$ to Base Price)	Wood	Wood

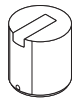

With Recessed Toe Kick

18"	18"	27½"	CWCIRC18	\$1103	+\$ 47	+\$164
24"	24"	27½"	CWCIRC24	\$1245	+\$ 69	+\$242
30"	30"	27½"	CWCIRC30	\$1451	+\$ 96	+\$335
36"	36"	27½"	CWCIRC36	\$1656	+\$116	+\$407

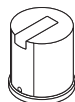

With Wood Molding

18"	18"	27½"	CWCIRT18	\$1401	+\$ 47	+\$164
24"	24"	27½"	CWCIRT24	\$1580	+\$ 69	+\$242
30"	30"	27½"	CWCIRT30	\$1842	+\$ 96	+\$335
36"	36"	27½"	CWCIRT36	\$2105	+\$116	+\$407

Bases for Conference Tables, continued

SIN 711.11

Half Drum Bases

Standard Includes	Required to Specify
<ul style="list-style-type: none"> Half drum base: wood group 1 Removable panel for access to wire cavity Hole in bottom of base for floor monument access Recessed toe kick on base, if selected: metallic finish Wood molding on base, if selected: wood to match base Glides: black plastic Attachment hardware 	<ul style="list-style-type: none"> 1 Style number 2 Wood color number for base 3 Metallic finish color number for recessed toe kick, if selected: <ul style="list-style-type: none"> 0835 Black 8042 Brushed Aluminum 8046 Polished Aluminum 4 Options, if selected (see below) <p>► See <i>Surface Materials</i>, page 154.</p>

Options	Price	Required to Specify
Surface Materials <ul style="list-style-type: none"> Wood group 2 Wood group 3 Customiz stain on wood 	<ul style="list-style-type: none"> Prices below Prices below No cost 	<ul style="list-style-type: none"> Specify wood color number. Specify wood color number. Specify <i>with Customiz stain</i>. <p>► See <i>Surface Materials Reference Manual</i>.</p>

Specification Information					
Dimensions			Style Number	Base Price	Options (Add \$ to Base Price)
D	W	H			
:	:	:	:	:	Wood Wood : Wood Group 2 : Group 3



With Recessed Toe Kick						
9"	18"	27½"	CWHDC18	\$ 966	+\$ 47	+\$164
12"	24"	27½"	CWHDC24	\$1035	+\$ 69	+\$242
15"	30"	27½"	CWHDC30	\$1245	+\$ 96	+\$335
18"	36"	27½"	CWHDC36	\$1437	+\$116	+\$407
:	:	:	:	:	:	:



With Wood Molding						
9"	18"	27½"	CWHDT18	\$1228	+\$ 47	+\$164
12"	24"	27½"	CWHDT24	\$1316	+\$ 69	+\$242
15"	30"	27½"	CWHDT30	\$1580	+\$ 96	+\$335
18"	36"	27½"	CWHDT36	\$1825	+\$116	+\$407
:	:	:	:	:	:	:

Elliptical Drum Bases

Standard Includes	Required to Specify
<ul style="list-style-type: none"> • Elliptical drum base: wood group 1 • Removable panel for access to wire cavity • Hole in bottom of base for floor monument access • Recessed toe kick on base, if selected: metallic finish • Wood molding on base, if selected: wood to match base • Glides: black plastic • Attachment hardware 	<ol style="list-style-type: none"> 1 Style number 2 Wood color number for base 3 Metallic finish color number for recessed toe kick, if selected: <ul style="list-style-type: none"> 0835 Black 8042 Brushed Aluminum 8046 Polished Aluminum 4 Options, if selected (see below) <ul style="list-style-type: none"> ▶ See <i>Surface Materials</i>, page 154.

Options	Price	Required to Specify
Surface Materials <ul style="list-style-type: none"> • Wood group 2 • Wood group 3 • Customiz stain on wood 	Prices below Prices below No cost	Specify wood color number. Specify wood color number. Specify <i>with Customiz stain</i> . ▶ See <i>Surface Materials Reference Manual</i> .

Specification Information					
Dimensions			Style Number	Base Price	Options (Add \$ to Base Price)
D	W	H			
					Wood Wood Group 2 Wood Group 3



With Recessed Toe Kick						
D	W	H	Style Number	Base Price	Options	Total Price
12"	24"	27½"	CWELC24	\$1245	+\$ 69	+\$242
15"	30"	27½"	CWELC30	\$1451	+\$ 96	+\$335
18"	36"	27½"	CWELC36	\$1656	+\$116	+\$407



With Wood Molding						
D	W	H	Style Number	Base Price	Options	Total Price
12"	24"	27½"	CWELT24	\$1580	+\$ 69	+\$242
15"	30"	27½"	CWELT30	\$1842	+\$ 96	+\$335
18"	36"	27½"	CWELT36	\$2105	+\$116	+\$407

Power and Communication Accessories

SIN 711.11

Technology Covers

Standard Includes	Required to Specify
<ul style="list-style-type: none"> Technology covers: Corian 	<ul style="list-style-type: none"> 1 Style number 2 Corian color number: <ul style="list-style-type: none"> 2970 Cameo White 2971 Nocturne Black

Specification Information

Dimensions			Style Number	Price
D	W	H		

Wire Access Grommet Cover

4½"	6"	¼"	DAC84	\$83
-----	----	----	--------------	------

Square Cover

4½"	6"	¼"	DAX84	\$83
-----	----	----	--------------	------



Tip: Technology covers are included with power units and power channels. Specify additional covers only if you need a different style or replacements.

▶ See *Power Channels and Power Units*, pages 81–82.

Flip Up Power Unit



Tip: For field installation, a 5" wide by 3¾" depth cut out is required. Also at least a 2½" clearance from the bottom of the flange (including the thickness of the worksurface) is required to allow the routing of the wire and to avoid an interference with drawers.

Standard Includes	Required to Specify
<ul style="list-style-type: none"> Power unit: 0835 black paint or 4799 Platinum paint Two outlets: black plastic Attachment hardware 6' power cord with grounded plug: black plastic 	<ul style="list-style-type: none"> 1 Style number 2 Paint color number for power unit

Specification Information

Dimensions			Style Number	Price
D	W	H		

Flip Up Power Unit

4¼"	5½"	2"	AWVFP	\$288
-----	-----	----	--------------	-------

Power Boxes and Power/Communication Boxes

Tip: Power boxes can provide power/data access in media carts.

Standard Includes	Required to Specify
<ul style="list-style-type: none"> • Power box • Power/communication box with adapters for two customer-supplied data couplers/jacks • 6' power cord with three-prong plug or 6' flexible metal conduit 	Style number

Specification Information

• Dimensions			• Style	• Price
D	W	H	Number	
:	:	:	:	:

Power Boxes

3"	3"	1"	SPP	\$230
:	:	:	:	:

Hardwired Power Boxes

3"	3"	1"	SPPH	\$475
:	:	:	:	:

Power/Communication Boxes

3"	3"	1"	SPC	\$231
:	:	:	:	:

Hardwired Power/Communication Boxes

3"	3"	1"	SPCH	\$351
:	:	:	:	:

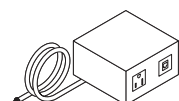
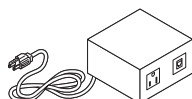
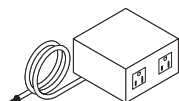
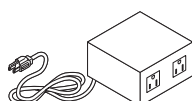

Tip: Jacks can be purchased by calling any of the manufacturers listed below:

- AMP Corporation 1.800.522.6752
- Leviton 1.800.722.2082
- Lucent 1.800.344.0223
- Krone 1.800.775.5766
- Panduit 1.800.777.3300

Contemporary-Style Storage Credenzas

SIN 711.11

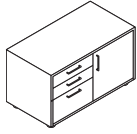

Standard Includes	Required to Specify
<ul style="list-style-type: none"> • Credenza: wood group 1 • Finished back panel: wood to match credenza • Pulls: paint or metal • Locks, keyed random: 9250 Ember Chrome • One adjustable shelf behind each door • One hanging file folder frame per file drawer: black plastic • Cylinder feet: paint or metal 	<ol style="list-style-type: none"> 1 Style number 2 Wood veneer color number for credenza 3 Pulls (see below) 4 Paint or metal color number for feet 5 Options, if selected (see below) <p>▶ See <i>Surface Materials</i>, page 154.</p>

	Options	Price	Required to Specify
Surface Materials	• Wood group 2	+\$ 322	Specify wood color number. Specify wood color number. Specify with <i>Customiz stain</i> . ▶ See <i>Surface Materials Reference Manual</i> .
	• Wood group 3	+\$1124	
	• Customiz stain on wood	No cost	
Pulls	• Tab pull	No cost	Specify with <i>tab pull</i> and select 0835 Black, 4799 Platinum, 9201 Polished Chrome, or 9211 Nickel. Specify with <i>jazz pull</i> and select 0835 Black, 4799 Platinum, 9201 Polished Chrome, or 9211 Nickel. Specify with <i>nile pull</i> and select 0835 Black, 4799 Platinum, 9201 Polished Chrome, or 9211 Nickel.
	• Jazz pull	+\$ 11 each	
	• Nile pull	+\$ 11 each	
Foot Detail	• Square feet	No cost	Specify with <i>square feet</i> and select 0835 Black, 4799 Platinum, or 8042 Brushed Aluminum.
Lock and Keying	Lock		
	• Polished Chrome	No cost	Specify with <i>9201 Polished Chrome lock</i> .
Lock and Keying	Keying		
	• Factory- and field-installed keying		▶ Page 622
Translucent Doors	Doors		
	• Non-locking translucent glass doors	+\$ 243 per door	Add suffix G to style number.
Grommets	• Two 2½"-round worksurface grommets	+\$ 148	Left/right: Specify with <i>CGRLR</i> and select 0835 Black, 4799 Platinum Metallic, 9201 Polished Chrome, or 9211 Nickel.

Tip: Specify 4799 Platinum finish on pulls to match translucent door frame.

Specification Information

Dimensions			Style	Base
D	W	H	Number	Price

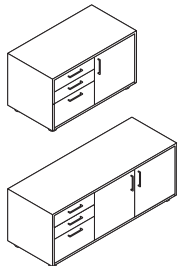

Credenza with Left-Hand Drawers and Right-Hand Door

24"	45"	26"	CWDL4526	\$3113
-----	-----	-----	-----------------	--------

Credenza with Left-Hand Drawers and Right-Hand Double Doors

24"	67"	26"	CWDL6726	\$4410
-----	-----	-----	-----------------	--------

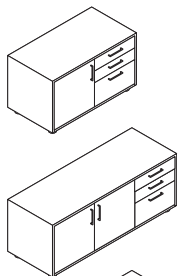

Credenza with Right-Hand Drawers and Left-Hand Door

24"	45"	26"	CWDR4526	\$3113
-----	-----	-----	-----------------	--------

Credenza with Right-Hand Drawers and Left-Hand Double Doors

24"	67"	26"	CWDR6726	\$4410
-----	-----	-----	-----------------	--------

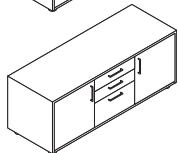

Credenza with Center Drawers and Right- and Left-Hand Doors

24"	67"	26"	CWCDC6726	\$4410
-----	-----	-----	------------------	--------

Credenzas with All Drawers

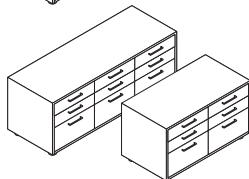

24"	45"	26"	CWDWC4526	\$3270
-----	-----	-----	------------------	--------

24"	67"	26"	CWADC6726	\$4631
-----	-----	-----	------------------	--------

Credenzas with All Doors

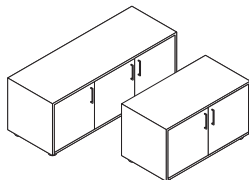

24"	45"	26"	CWDDC4526	\$2964
-----	-----	-----	------------------	--------

24"	67"	26"	CWTDC6726	\$4198
-----	-----	-----	------------------	--------



Contemporary-Style Buffet-Height Credenzas

SIN 711.11

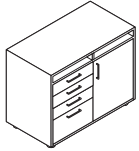

Standard Includes	Required to Specify
<ul style="list-style-type: none"> • Buffet-height credenza: wood group 1 • Finished back panel: wood to match credenza • Pulls: paint or metal • Locks, keyed random: 9250 Ember Chrome • Two adjustable shelves behind each door • One hanging file folder frame per file drawer: black plastic • Cylinder feet: paint or metal 	<ol style="list-style-type: none"> 1 Style number 2 Wood veneer color number for credenza 3 Pulls (see below) 4 Paint or metal color number for feet 5 Options, if selected (see below) <p>▶ See <i>Surface Materials</i>, page 154.</p>

	Options	Price	Required to Specify
Surface Materials	• Wood group 2	+\$ 322	Specify wood color number. Specify wood color number. Specify with <i>Customiz stain</i> . ▶ See <i>Surface Materials Reference Manual</i> .
	• Wood group 3	+\$1124	
	• Customiz stain on wood	No cost	
Pulls	• Tab pull	No cost	Specify with <i>tab pull</i> and select 0835 Black, 4799 Platinum, 9201 Polished Chrome, or 9211 Nickel. Specify with <i>jazz pull</i> and select 0835 Black, 4799 Platinum, 9201 Polished Chrome, or 9211 Nickel. Specify with <i>nile pull</i> and select 0835 Black, 4799 Platinum, 9201 Polished Chrome, or 9211 Nickel.
	• Jazz pull	+\$ 11 each	
	• Nile pull	+\$ 11 each	
Foot Detail	• Square feet	No cost	Specify with <i>square feet</i> and select 0835 Black, 4799 Platinum, or 8042 Brushed Aluminum.
Lock and Keying	Lock		
	• Polished Chrome	No cost	Specify with <i>9201 Polished Chrome lock</i> .
Lock and Keying	Keying		
	• Factory- and field-installed keying		▶ Page 622
Translucent Doors	Doors		
	• Non-locking translucent glass doors	+\$ 313 per door	Add suffix G to style number.
Grommets	• Two 2½"-round worksurface grommets	+\$ 148	Left/right: Specify with <i>CGRLR</i> and select 0835 Black, 4799 Platinum Metallic, 9201 Polished Chrome, or 9211 Nickel.

Tip: Specify 4799 Platinum finish on pulls to match translucent door frame.

Specification Information

Dimensions			Style	Base
D	W	H	Number	Price

Buffet-Height Credenza with Left-Hand Drawers and Right-Hand Door

24"	45"	36"	CWDL4536	\$3579
-----	-----	-----	-----------------	--------

Buffet-Height Credenza with Left-Hand Drawers and Right-Hand Double Doors

24"	67"	36"	CWDL6736	\$5070
-----	-----	-----	-----------------	--------

Buffet-Height Credenza with Right-Hand Drawers and Left-Hand Door

24"	45"	36"	CWDR4536	\$3579
-----	-----	-----	-----------------	--------

Buffet-Height Credenza with Right-Hand Drawers and Left-Hand Double Doors

24"	67"	36"	CWDR6736	\$5070
-----	-----	-----	-----------------	--------

Buffet-Height Credenzas with All Doors

24"	45"	36"	CWDC4536	\$3410
-----	-----	-----	-----------------	--------

24"	67"	36"	CWDC6736	\$4831
-----	-----	-----	-----------------	--------

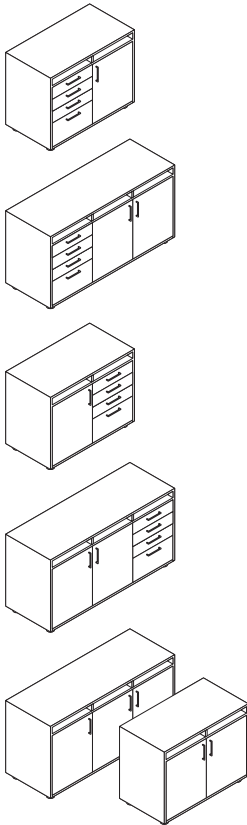

Convenga

Contemporary-Style Media Carts

SIN 711.11

Standard Includes	Required to Specify
<ul style="list-style-type: none"> • Media cart: wood group 1 • Pulls: paint or metal • Side handles: paint or metal to match pulls • Locks, keyed random: 9250 Ember Chrome • Wire management cavity and back panel fold-down door • 2½"-round grommet: paint or metal • Locking casters, if selected: black plastic • Cylinder feet, if selected: paint or metal 	<ol style="list-style-type: none"> 1 Style number 2 Wood veneer color number for media cart 3 Pulls (see below) 4 Paint or metal color number for grommet 5 Paint or metal color number for feet, if selected 6 Options, if selected (see below) <p>▶ See <i>Surface Materials</i>, page 154.</p>

Options	Price	Required to Specify
Surface Materials <ul style="list-style-type: none"> • Wood group 2 • Wood group 3 • Customiz stain on wood 	+\$177 +\$624 No cost	Specify wood color number. Specify wood color number. Specify <i>with Customiz stain</i> . ▶ See <i>Surface Materials Reference Manual</i> .
Pulls <ul style="list-style-type: none"> • Tab pull • Jazz pull • Nile pull 	No cost +\$ 11 each +\$ 11 each	Specify <i>with tab pull</i> and select 0835 Black, 4799 Platinum, 9201 Polished Chrome, or 9211 Nickel. Specify <i>with jazz pull</i> and select 0835 Black, 4799 Platinum, 9201 Polished Chrome, or 9211 Nickel. Specify <i>with nile pull</i> and select 0835 Black, 4799 Platinum, 9201 Polished Chrome, or 9211 Nickel.
Foot Detail <ul style="list-style-type: none"> • Square feet 	No cost	Specify <i>with square feet</i> and select 0835 Black, 4799 Platinum, 8042 Brushed Aluminum.
Lock and Keying <ul style="list-style-type: none"> • Polished Chrome 	No cost	Specify <i>with 9201 Polished Chrome lock</i> .
	Keying <ul style="list-style-type: none"> • Factory- and field-installed keying 	▶ Page 622
Translucent Doors <ul style="list-style-type: none"> • Non-locking translucent glass doors 	+\$313 per double doors	Add suffix G to style number.

Tip: Specify 4799 Platinum finish on pulls to match translucent door frame.

Specification Information				
Dimensions			Style	Base
D	W	H	Number	Price

Media Carts with Casters

With Open Shelf, Drawer, Double Doors, and One Adjustable Shelf in the Cabinet

24"	32"	38½"	CWDWCMED	\$2714
-----	-----	------	-----------------	--------

With Open Shelf, Double Doors, and One Fixed Shelf and One Adjustable Shelf in the Cabinet

24"	32"	38½"	CWOSCMED	\$2464
-----	-----	------	-----------------	--------

Media Carts with Feet

With Open Shelf, Drawer, Double Doors, and One Adjustable Shelf in the Cabinet

24"	32"	38½"	CWDWCMEDF	\$2975
-----	-----	------	------------------	--------

With Open Shelf, Double Doors, and One Fixed Shelf and One Adjustable Shelf in the Cabinet

24"	32"	38½"	CWOSCMEDF	\$2722
-----	-----	------	------------------	--------

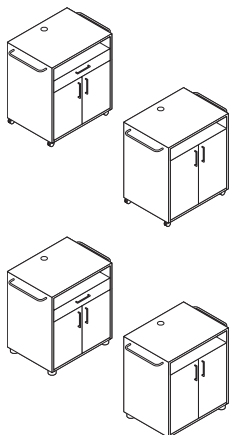

Contemporary-Style Hospitality Carts

SIN 711.11

Standard Includes	Required to Specify
<ul style="list-style-type: none"> Hospitality cart: wood group 1 Pulls: paint or metal Side handles: paint or metal to match pulls Locks, keyed random: 9250 Ember Chrome Non-skid pad for cart top 2 1/2"-round grommet: paint or metal Locking casters: black plastic 	<ol style="list-style-type: none"> Style number Wood veneer color number for hospitality cart Pulls (see below) Paint or metal color number for grommet Options, if selected (see below) <p>▶ See <i>Surface Materials</i>, page 154.</p>

Options	Price	Required to Specify
Surface Materials <ul style="list-style-type: none"> Wood group 2 Wood group 3 Customiz stain on wood 	<ul style="list-style-type: none"> +\$177 +\$624 No cost 	Specify wood color number. Specify wood color number. Specify with <i>Customiz stain</i> . ▶ See <i>Surface Materials Reference Manual</i> .
Pulls <ul style="list-style-type: none"> Tab pull Jazz pull Nile pull 	<ul style="list-style-type: none"> No cost +\$ 11 each +\$ 11 each 	Specify with <i>tab pull</i> and select 0835 Black, 4799 Platinum, 9201 Polished Chrome, or 9211 Nickel. Specify with <i>jazz pull</i> and select 0835 Black, 4799 Platinum, 9201 Polished Chrome, or 9211 Nickel. Specify with <i>nile pull</i> and select 0835 Black, 4799 Platinum, 9201 Polished Chrome, or 9211 Nickel.
Lock and Keying <ul style="list-style-type: none"> Polished Chrome 	<ul style="list-style-type: none"> No cost 	Specify with <i>9201 Polished Chrome lock</i> . ▶ Page 622
Translucent Doors <ul style="list-style-type: none"> Non-locking translucent glass doors 	<ul style="list-style-type: none"> +\$313 per double doors 	Add suffix G to style number.

Tip: Specify 4799 Platinum finish on pulls to match translucent door frame.

Specification Information				
Dimensions			Style	Base
D	W	H	Number	Price
.

Hospitality Carts

With Double Doors and Two Fixed Shelves and One Adjustable Shelf in the Cabinet

24"	32"	38 1/2"	CWDDCHP	\$2586
-----	-----	---------	----------------	--------

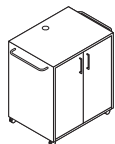

With Pull-Out Shelf, Drawer, Double Doors, and One Adjustable Shelf in the Cabinet

24"	32"	38 1/2"	CWDWCHP	\$2714
-----	-----	---------	----------------	--------



With Pull-Out Shelf, Double Doors, and One Fixed Shelf and One Adjustable Shelf in the Cabinet

24"	32"	38 1/2"	CWOSCHP	\$2464
-----	-----	---------	----------------	--------

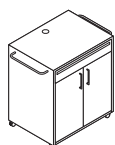

Contemporary-Style Lecterns

SIN 711.11

Standard Includes	Required to Specify
<ul style="list-style-type: none"> Lectern: wood group 1 Pulls on non-locking doors, if selected: paint or metal Task light Wire management channel Cylinder feet, if selected: paint or metal Locking casters, if selected: black plastic 	<ol style="list-style-type: none"> Style number Wood veneer color number for lectern Pulls and paint or metal color number (see below) Paint or metal color number for feet, if selected Options, if selected (see below) <p>▶ See <i>Surface Materials</i>, page 154.</p>

Options	Price	Required to Specify
Surface Materials <ul style="list-style-type: none"> Wood group 2 Wood group 3 Customiz stain on wood 	Prices below Prices below No cost	Specify wood color number. Specify wood color number. Specify <i>with Customiz stain</i> . ▶ See <i>Surface Materials Reference Manual</i> .
Pulls <ul style="list-style-type: none"> Tab pull Jazz pull Nile pull 	No cost +\$11 each +\$11 each	Specify <i>with tab pull</i> and select 0835 Black, 4799 Platinum, 9201 Polished Chrome, or 9211 Nickel. Specify <i>with jazz pull</i> and select 0835 Black, 4799 Platinum, 9201 Polished Chrome, or 9211 Nickel. Specify <i>with nile pull</i> and select 0835 Black, 4799 Platinum, 9201 Polished Chrome, or 9211 Nickel.
Foot Detail <ul style="list-style-type: none"> Square feet 	No cost	Specify <i>with square feet</i> and select 0835 Black, 4799 Platinum, 8042 Brushed Aluminum, or 9201 Polished Chrome.

Specification Information						
Dimensions			Style	Base	Options	
D	W	H	Number	Price	(Add \$ to Base Price)	
..	Wood .. Wood : Wood .. Group 2 : Group 3	

Table Top Lectern

22"	25"	16½"	CWCLECT	\$1372	+\$ 96	+\$335
-----	-----	------	----------------	--------	--------	--------

Full-Height Lecterns

With Casters and Two Fixed and Two Adjustable Open Shelves

22"	25"	49½"	CWCLEC	\$2590	+\$177	+\$624
-----	-----	------	---------------	--------	--------	--------

With Casters, Non-Locking Door, and One Fixed and Two Adjustable Shelves in the Cabinet

22"	25"	49½"	CWCLECD	\$2982	+\$177	+\$624
-----	-----	------	----------------	--------	--------	--------

With Feet and Two Fixed and Two Adjustable Open Shelves

22"	25"	49½"	CWCLECF	\$2851	+\$177	+\$624
-----	-----	------	----------------	--------	--------	--------

With Feet, Non-Locking Door, and One Fixed and Two Adjustable Shelves in the Cabinet

22"	25"	49½"	CWCLECDF	\$3240	+\$177	+\$624
-----	-----	------	-----------------	--------	--------	--------

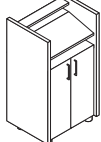
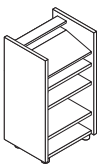
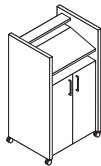
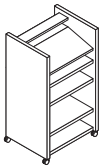

Contemporary-Style Wallboards

SIN 711.11

Tip: Interior writing surface accommodates magnets. Surface is also suitable for projection.

Standard Includes	Required to Specify
<ul style="list-style-type: none"> • Wallboard doors with full 180° hinges and pegs to hang flip-chart pads: wood group 1 • Tackable surface on door interior: 2166 Forbo bulletin board • Pulls: paint or metal • Interior writing surface for dry-erase markers: white porcelain 	<ul style="list-style-type: none"> 1 Style number 2 Wood veneer color number for wallboard 3 Pulls (see below) 4 Options, if selected (see below) ▶ See <i>Surface Materials</i>, page 154.

Options	Price	Required to Specify
Surface Materials <ul style="list-style-type: none"> • Wood group 2 • Wood group 3 • Customiz stain on wood 	<ul style="list-style-type: none"> +\$ 96 +\$335 No cost 	<ul style="list-style-type: none"> Specify wood color number. Specify wood color number. Specify <i>with Customiz stain</i>. ▶ See <i>Surface Materials Reference Manual</i>.
Pulls <ul style="list-style-type: none"> • Tab pull • Jazz pull • Nile pull 	<ul style="list-style-type: none"> No cost +\$ 11 each +\$ 11 each 	<ul style="list-style-type: none"> Specify <i>with tab pull</i> and select 0835 Black, 4799 Platinum, 9201 Polished Chrome, or 9211 Nickel. Specify <i>with jazz pull</i> and select 0835 Black, 4799 Platinum, 9201 Polished Chrome, or 9211 Nickel. Specify <i>with nile pull</i> and select 0835 Black, 4799 Platinum, 9201 Polished Chrome, or 9211 Nickel.
Marker Board Door Interiors <ul style="list-style-type: none"> • Marker board surface on door interiors 	<ul style="list-style-type: none"> +\$196 	<ul style="list-style-type: none"> Specify <i>with marker board doors</i>.

Specification Information				
• Dimensions			• Style	• Base
D	W	H	Number	Price
5"	56"	37"	CWAWLB56	\$2697
5"	70"	37"	CWAWLB70	\$3197

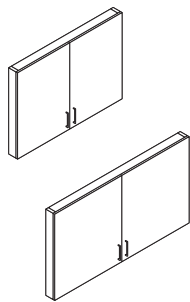

Transitional-Style Storage Credenzas

SIN 711.11

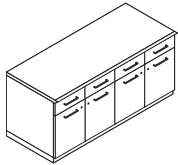

Standard Includes	Required to Specify
-------------------	---------------------

<ul style="list-style-type: none"> • Credenza: wood group 1 • Finished back panel with wire access cutouts: wood to match credenza • Pulls: paint or metal • Locks, keyed random: 9250 Ember Chrome • One adjustable shelf behind each door • One hanging file folder frame per file drawer: black plastic 	<p>1 Style number with appropriate edge profile letter indicated in the space provided. (For example, CWDD_3229 becomes CWDDF3229 for flat edge profile)</p> <p>▶ See edge profiles below.</p> <p>2 Wood veneer color number for credenza</p> <p>3 Pulls (see below)</p> <p>4 Options, if selected (see below)</p> <p>▶ See <i>Surface Materials</i>, page 154.</p>
--	---

Edge Profiles

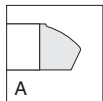

American Elect

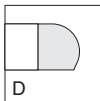

Lotus

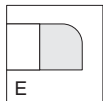

Bullnose

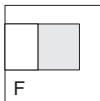

Flat

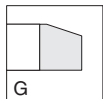

Slope

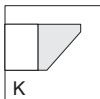

Knife

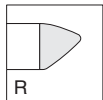

Rei

Options	Price	Required to Specify
---------	-------	---------------------

Surface Materials	<ul style="list-style-type: none"> • Wood group 2 +\$ 322 • Wood group 3 +\$1124 • Customiz stain on wood No cost • Full-fill finish on wood group 1 +\$ 24 	<p>Specify wood color number. Specify wood color number. Specify <i>with Customiz stain</i>.</p> <p>▶ See <i>Surface Materials Reference Manual</i>. Specify full-fill finish color number for credenza top.</p>
Pulls	<ul style="list-style-type: none"> • Tab pull No cost • Jazz pull +\$ 11 each • Nile pull +\$ 11 each 	<p>Specify <i>with tab pull</i> and select 0835 Black, 4799 Platinum, 9201 Polished Chrome, or 9211 Nickel.</p> <p>Specify <i>with jazz pull</i> and select 0835 Black, 4799 Platinum, 9201 Polished Chrome, or 9211 Nickel.</p> <p>Specify <i>with nile pull</i> and select 0835 Black, 4799 Platinum, 9201 Polished Chrome, or 9211 Nickel.</p>
Lock and Keying	<p>Lock</p> <ul style="list-style-type: none"> • Polished Chrome No cost <p>Keying</p> <ul style="list-style-type: none"> • Factory- and field-installed keying 	<p>Specify <i>with 9201 Polished Chrome lock</i>.</p> <p>▶ Page 622</p>
Grommets	<ul style="list-style-type: none"> • One 2½"-round worksurface grommet available on 32"W credenzas +\$ 74 • Two 2½"-round worksurface grommets available on 64"W and 80"W credenzas +\$ 148 • Three 2½"-round worksurface grommets available on 80"W credenzas +\$ 222 	<p>Center: Specify <i>with CGRC</i> and select 0835 Black, 9201 Polished Chrome, or 9211 Nickel.</p> <p>Left/right: Specify <i>with CGRLR</i> and select 0835 Black, 9201 Polished Chrome, or 9211 Nickel.</p> <p>Left/center/right: Specify <i>with CGRLCR</i> and select 0835 Black, 4799 Platinum Metallic, 9201 Polished Chrome, or 9211 Nickel.</p>

Tip: Your specification is not complete until you add a fifth letter to the style number to define the edge profile.

Specification Information

Dimensions			Style	Base
D	W	H	Number	Price

Credenzas with All Doors

25"	32"	29½"	CWDD_3229	\$2230
25"	64"	29½"	CWDD_6429	\$4201
25"	80"	29½"	CWDD_8029	\$4728

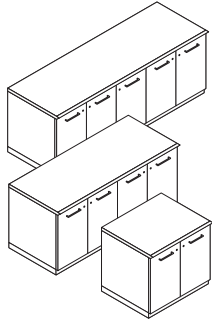

Credenzas with Box Drawers and Doors

25"	32"	29½"	CWBD_3229	\$2453
25"	64"	29½"	CWBD_6429	\$4625
25"	80"	29½"	CWBD_8029	\$5202

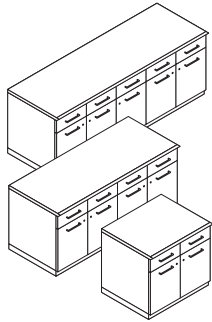

Credenzas with Lateral File Drawers

25"	32"	29½"	CWLF_3229	\$2453
25"	64"	29½"	CWLL_6429	\$4625

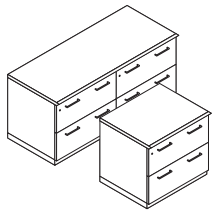

Credenzas with Lateral File Drawers and Doors

25"	64"	29½"	CWLD_6429	\$4625
25"	80"	29½"	CWLD_8029	\$5202

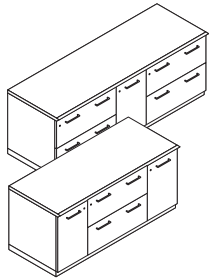

Transitional-Style Buffet-Height Credenzas

SIN 711.11

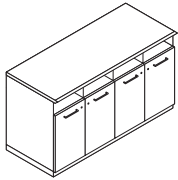

Standard Includes	Required to Specify
-------------------	---------------------

<ul style="list-style-type: none"> • Buffet-height credenza: wood group 1 • Finished back panel with wire access cutouts: wood to match credenza • Pulls: paint or metal • Locks, keyed random: 9250 Ember Chrome • Two adjustable shelves behind each door • One hanging file folder frame per file drawer: black plastic 	<p>1 Style number with appropriate edge profile letter indicated in the space provided. (For example, CWOD_3236 becomes CWODF3236 for flat edge profile)</p> <p>▶ See edge profiles below.</p> <p>2 Wood veneer color number for credenza</p> <p>3 Pulls (see below)</p> <p>4 Options, if selected (see below)</p> <p>▶ See <i>Surface Materials</i>, page 154.</p>
--	---

Edge Profiles

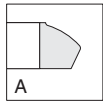

A
American Elect

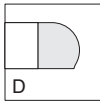

D
Lotus

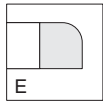

E
Bullnose

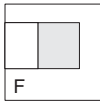

F
Flat

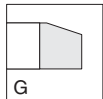

G
Slope

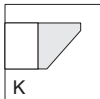

K
Knife

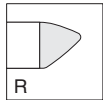

R
Rei

Options	Price	Required to Specify
---------	-------	---------------------

Surface Materials	<ul style="list-style-type: none"> • Wood group 2 +\$ 322 • Wood group 3 +\$1124 • Customiz stain on wood No cost • Full-fill finish on wood group 1 +\$ 24 	<p>Specify wood color number.</p> <p>Specify wood color number.</p> <p>Specify <i>with Customiz stain</i>.</p> <p>▶ See <i>Surface Materials Reference Manual</i>.</p> <p>Specify full-fill finish color number for credenza top.</p>
Pulls	<ul style="list-style-type: none"> • Tab pull No cost • Jazz pull +\$ 11 each • Nile pull +\$ 11 each 	<p>Specify <i>with tab pull</i> and select 0835 Black, 4799 Platinum, 9201 Polished Chrome, or 9211 Nickel.</p> <p>Specify <i>with jazz pull</i> and select 0835 Black, 4799 Platinum, 9201 Polished Chrome, or 9211 Nickel.</p> <p>Specify <i>with nile pull</i> and select 0835 Black, 4799 Platinum, 9201 Polished Chrome, or 9211 Nickel.</p>
Lock and Keying	<p>Lock</p> <ul style="list-style-type: none"> • Polished Chrome No cost <p>Keying</p> <ul style="list-style-type: none"> • Factory- and field-installed keying 	<p>Specify <i>with 9201 Polished Chrome lock</i>.</p> <p>▶ Page 622</p>
Grommets	<ul style="list-style-type: none"> • One 2½"-round worksurface grommet available on 32"W credenzas +\$ 74 • Two 2½"-round worksurface grommets available on 64"W and 80"W credenzas +\$ 148 • Three 2½"-round worksurface grommets available on 80"W credenzas +\$ 222 	<p>Center: Specify <i>with CGRC</i> and select 0835 Black, 9201 Polished Chrome, or 9211 Nickel.</p> <p>Left/right: Specify <i>with CGRLR</i> and select 0835 Black, 9201 Polished Chrome, or 9211 Nickel.</p> <p>Left/center/right: Specify <i>with CGRLCR</i> and select 0835 Black, 4799 Platinum Metallic, 9201 Polished Chrome, or 9211 Nickel.</p>

Tip: Your specification is not complete until you add a fifth letter to the style number to define the edge profile.

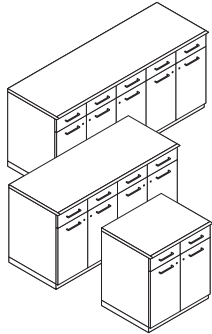
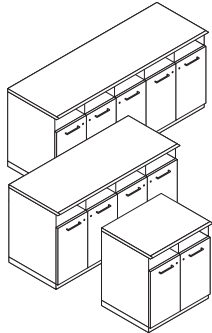

Specification Information

Dimensions			Style	Base
D	W	H	Number	Price

Buffet-Height Credenzas with Open Shelves and Doors

25"	32"	36"	CWOD_3236	\$2565
25"	64"	36"	CWOD_6436	\$4387
25"	80"	36"	CWOD_8036	\$4938
:	:	:	:	:

Buffet-Height Credenzas with Box Drawers and Doors

25"	32"	36"	CWBD_3236	\$2819
25"	64"	36"	CWBD_6436	\$4831
25"	80"	36"	CWBD_8036	\$5430
:	:	:	:	:



Transitional-Style Media Carts

SIN 711.11

Standard Includes	Required to Specify
<ul style="list-style-type: none"> Media cart: wood group 1 Pulls: paint or metal Side handles: paint or metal to match pulls Locks, keyed random: 9250 Ember Chrome Wire management cavity and back panel fold-down door 2½"-round grommet: paint or metal Locking casters: black plastic 	<ol style="list-style-type: none"> Style number with appropriate edge profile letter indicated in the space provided. (For example, CWDD_MED becomes CWDDFMED for flat edge profile) <ul style="list-style-type: none"> ▶ See edge profiles below. Wood veneer color number for media cart Pulls (see below) Paint or metal color number for grommet Options, if selected (see below) <ul style="list-style-type: none"> ▶ See <i>Surface Materials</i>, page 154.

Edge Profiles

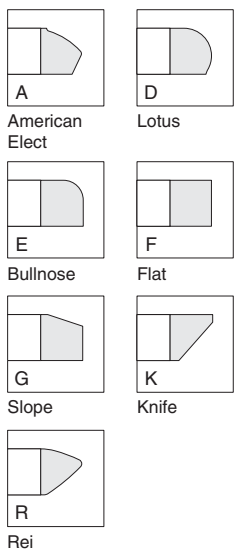

Tip: Your specification is not complete until you add a fifth letter to the style number to define the edge profile.

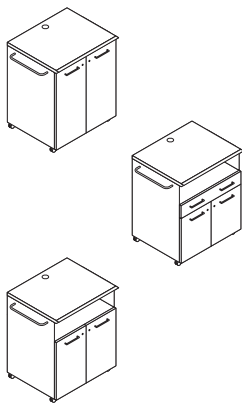

Options	Price	Required to Specify
Surface Materials <ul style="list-style-type: none"> Wood group 2 +\$177 Wood group 3 +\$624 Customiz stain on wood No cost Full-fill finish on wood group 1 +\$ 24 		Specify wood color number. Specify wood color number. Specify with <i>Customiz stain</i> . ▶ See <i>Surface Materials Reference Manual</i> . Specify full-fill finish color number for top.
Pulls <ul style="list-style-type: none"> Tab pull No cost Jazz pull +\$ 11 each Nile pull +\$ 11 each 		Specify with <i>tab pull</i> and select 0835 Black, 4799 Platinum, 9201 Polished Chrome, or 9211 Nickel. Specify with <i>jazz pull</i> and select 0835 Black, 4799 Platinum, 9201 Polished Chrome, or 9211 Nickel. Specify with <i>nile pull</i> and select 0835 Black, 4799 Platinum, 9201 Polished Chrome, or 9211 Nickel.
Lock and Keying <ul style="list-style-type: none"> Lock <ul style="list-style-type: none"> Polished Chrome No cost Keying <ul style="list-style-type: none"> Factory- and field-installed keying 		Specify with <i>9201 Polished Chrome lock</i> . ▶ Page 622

Specification Information

• Dimensions			• Style	• Base
D	W	H	Number	Price

Media Carts

With Double Doors and Two Fixed Shelves and One Adjustable Shelf in the Cabinet

25"	32½"	38½"	CWDD_MED	\$2586
-----	------	------	-----------------	--------

With Open Shelf, Drawer, Double Doors, and One Adjustable Shelf in the Cabinet

25"	32½"	38½"	CWDW_MED	\$2714
-----	------	------	-----------------	--------

With Open Shelf, Double Doors, and One Fixed Shelf and One Adjustable Shelf in the Cabinet

25"	32½"	38½"	CWOS_MED	\$2464
-----	------	------	-----------------	--------

Transitional-Style Hospitality Carts

SIN 711.11

Standard Includes	Required to Specify
<ul style="list-style-type: none"> • Hospitality cart: wood group 1 • Pulls: paint or metal • Side handles: paint or metal to match pulls • Locks, keyed random: 9250 Ember Chrome • Non-skid pad for cart top • 2½" round grommet: paint or metal • Locking casters: black plastic 	<ol style="list-style-type: none"> 1 Style number with appropriate edge profile letter indicated in the space provided. (For example, CWDD_HP becomes CWDDFHP for flat edge profile) ▶ See edge profiles below 2 Wood veneer color number for hospitality cart 3 Pulls (see below) 4 Paint or metal color number for grommet 5 Options, if selected (see below) ▶ See <i>Surface Materials</i>, page 154.

Edge Profiles

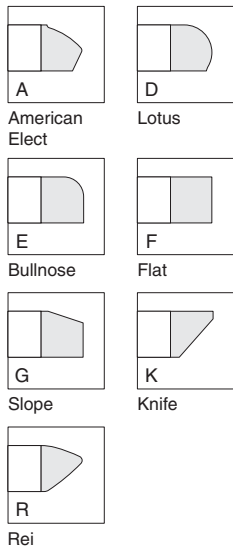

Rei
Tip: Your specification is not complete until you add a fifth letter to the style number to define the edge profile.

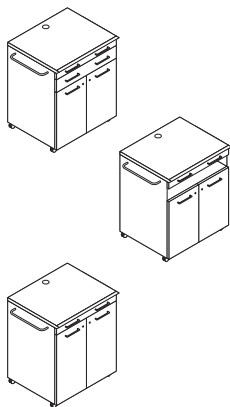

Options	Price	Required to Specify
Surface Materials <ul style="list-style-type: none"> • Wood group 2 +\$177 • Wood group 3 +\$624 • Customiz stain on wood No cost • Full-fill finish on wood group 1 +\$ 24 		Specify wood color number. Specify wood color number. Specify <i>with Customiz stain</i> . ▶ See <i>Surface Materials Reference Manual</i> . Specify full-fill finish color number for top.
Pulls <ul style="list-style-type: none"> • Tab pull No cost • Jazz pull +\$ 11 each • Nile pull +\$ 11 each 		Specify <i>with tab pull</i> and select 0835 Black, 4799 Platinum, 9201 Polished Chrome, or 9211 Nickel. Specify <i>with jazz pull</i> and select 0835 Black, 4799 Platinum, 9201 Polished Chrome, or 9211 Nickel. Specify <i>with nile pull</i> and select 0835 Black, 4799 Platinum, 9201 Polished Chrome, or 9211 Nickel.
Lock and Keying <ul style="list-style-type: none"> • Polished Chrome No cost 		Specify <i>with 9201 Polished Chrome lock</i> .
Keying <ul style="list-style-type: none"> • Factory- and field-installed keying 		▶ Page 622

Specification Information

• Dimensions			• Style	• Base
D	W	H	Number	Price

Hospitality Carts

With Pull-Out Shelf, Drawer, Double Doors, and One Adjustable Shelf in the Cabinet

25"	32"	38½"	CWDW_HP	\$2714
-----	-----	------	----------------	--------

With Pull-Out Shelf, Open Shelf, Double Doors, and One Adjustable Shelf in the Cabinet

25"	32"	38½"	CWOS_HP	\$2464
-----	-----	------	----------------	--------

With Pull-Out Shelf, Double Doors, and One Fixed Shelf and One Adjustable Shelf in the Cabinet

25"	32"	38½"	CWDD_HP	\$2586
-----	-----	------	----------------	--------

Transitional-Style Lecterns

SIN 711.11

Standard Includes	Required to Specify
<ul style="list-style-type: none"> Lectern: wood group 1 Pulls on non-locking door, if selected: paint or metal Task light Wire management channel Locking casters on full-height lecterns: black plastic 	<ol style="list-style-type: none"> Style number with appropriate edge profile letter indicated in the space provided. (For example, CW_LECT becomes CWFLECT for flat edge profile) <ul style="list-style-type: none"> ▶ See edge profiles below. Wood veneer color number for lectern Pulls and paint or metal color number (see below) Options, if selected (see below) <ul style="list-style-type: none"> ▶ See <i>Surface Materials</i>, page 154.

Edge Profiles

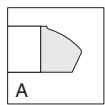

American Elect

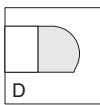

Lotus

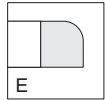

Bullnose

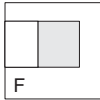

Flat

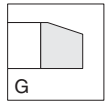

Slope

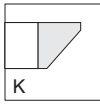

Knife

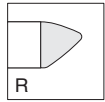

Rei

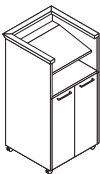
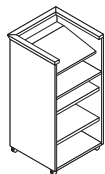
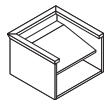

Options	Price	Required to Specify
Surface Materials <ul style="list-style-type: none"> Wood group 2 Wood group 3 Customiz stain on wood 	Prices below Prices below No cost	Specify wood color number. Specify wood color number. Specify with <i>Customiz stain</i> . ▶ See <i>Surface Materials Reference Manual</i> .
Pulls <ul style="list-style-type: none"> Tab pull Jazz pull Nile pull 	No cost +\$11 each +\$11 each	Specify with <i>tab pull</i> and select 0835 Black, 4799 Platinum, 9201 Polished Chrome, or 9211 Nickel. Specify with <i>jazz pull</i> and select 0835 Black, 4799 Platinum, 9201 Polished Chrome, or 9211 Nickel. Specify with <i>nile pull</i> and select 0835 Black, 4799 Platinum, 9201 Polished Chrome, or 9211 Nickel.

Specification Information

Dimensions			Style Number	Base Price	Options (Add \$ to Base Price)
D	W	H			
:	:	:	:	:	Wood Wood : Wood Group 2 : Group 3

Table Top Lectern

23½"	27½"	17"	CW_LECT	\$1372	+\$ 96	+\$335
------	------	-----	----------------	--------	--------	--------

Full-Height Lecterns

With Two Fixed and Two Adjustable Open Shelves

23½"	27½"	48"	CW_LEC	\$2590	+\$177	+\$624
------	------	-----	---------------	--------	--------	--------

With Non-Locking Door and One Fixed and Two Adjustable Shelves in the Cabinet

23½"	27½"	48"	CW_LECD	\$2982	+\$177	+\$624
------	------	-----	----------------	--------	--------	--------

Tip: Your specification is not complete until you add a fifth letter to the style number to define the edge profile.

Transitional-Style Wallboards

SIN 711.11

Tip: Interior writing surface accommodates magnets. Surface is also suitable for projection.

Standard Includes	Required to Specify
<ul style="list-style-type: none"> • Wallboard doors with full 180° hinges and pegs to hang flip-chart pads: wood group 1 • Tackable surface on door interior: 2166 Forbo bulletin board • Pulls: paint or metal • Interior writing surface for dry-erase markers: white porcelain 	<ul style="list-style-type: none"> 1 Style number 2 Wood veneer color number for wallboard 3 Pulls (see below) 4 Options, if selected (see below) ▶ See <i>Surface Materials</i>, page 154.

Options	Price	Required to Specify
Surface Materials <ul style="list-style-type: none"> • Wood group 2 • Wood group 3 • Customiz stain on wood 	<ul style="list-style-type: none"> +\$ 96 +\$335 No cost 	<ul style="list-style-type: none"> Specify wood color number. Specify wood color number. Specify <i>with Customiz stain</i>. ▶ See <i>Surface Materials Reference Manual</i>.
Pulls <ul style="list-style-type: none"> • Tab pull • Jazz pull • Nile pull 	<ul style="list-style-type: none"> No cost +\$ 11 each +\$ 11 each 	<ul style="list-style-type: none"> Specify <i>with tab pull</i> and select 0835 Black, 4799 Platinum, 9201 Polished Chrome, or 9211 Nickel. Specify <i>with jazz pull</i> and select 0835 Black, 4799 Platinum, 9201 Polished Chrome, or 9211 Nickel. Specify <i>with nile pull</i> and select 0835 Black, 4799 Platinum, 9201 Polished Chrome, or 9211 Nickel.
Marker Board Door Interiors <ul style="list-style-type: none"> • Marker board surface on door interiors 	<ul style="list-style-type: none"> +\$196 	<ul style="list-style-type: none"> Specify <i>with marker board doors</i>.

Specification Information				
• Dimensions			• Style	• Base
D	W	H	Number	Price
5"	56"	37"	CWAWLB56	\$2697
5"	70"	37"	CWAWLB70	\$3197

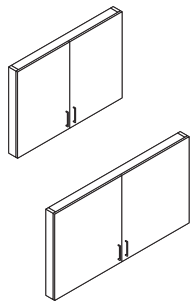

Verlay

Statement of Line	136
--------------------------	------------

Specifying	
Round Tables (SIN 711.11)	138
Gumdrop Tables (SIN 711.11)	140
Square Tables (SIN 711.11)	142
Rectangle Tables (SIN 711.11)	144
Sightline Tables (SIN 711.11)	148



Statement of Line

Verlay

Collaboration Tables



Specifying
▶ Page 138

Round Tables

42" Diameter	48" Diameter	54" Diameter	60" Diameter
●	●	●	●

Tip: Available parametrically in 1/16" increments.



Specifying
▶ Page 140

Gumdrop Tables

	42"W	48"W	54"W	60"W	66"W
42"D	●	●	●	●	●
48"D	●	●	●	●	●

Tip: Table tops are tapered. Depth will change over the length of table from the depth listed above to 6" smaller.

Tip: Available parametrically in 1/16" increments; except when a laminate top surface is specified, parametric sizes must be specified in 3" increments.

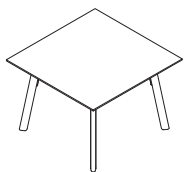

Specifying
▶ Page 142

Square Tables

	42"W	48"W
42"D	●	
48"D		●

Tip: Available parametrically in 1/16" increments; except when softened shape type and laminate top surface is specified, parametric sizes must be specified in 3" increments.

Collaboration Tables, continued

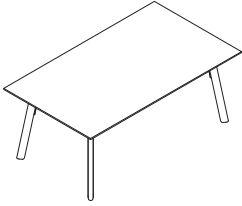

Specifying
▶ Page 144

Rectangle Tables

	72"W	84"W	96"W
42"D	●	●	●
48"D	●	●	●

Tip: Available parametrically in 1/16" increments; except when softened shape type and laminate top surface is specified, parametric sizes must be specified in 3" increments.

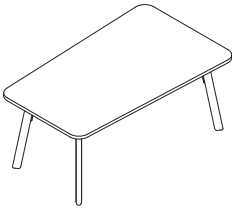

Specifying
▶ Page 148

Sightline Tables

	72"W	96"W
42"D	●	●
48"D	●	●

Tip: Table tops are tapered. Depth will change over the length of table from the depth listed above to a 36"D.

Tip: Available parametrically in 1/16" increments; except when softened shape type and laminate top surface is specified, parametric sizes must be specified in 3" increments.

Round Tables

SIN 711.11



Tip: All tables are available parametrically in 1/16" increments.

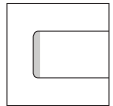

3 mm Plastic or Wood Edge

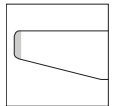

Slice Wood Veneer Edge

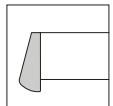

Drop Wood Edge

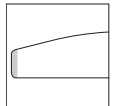

Eased Wood Edge

Tip: Wood edge finish will match top finish.

Tip: Eased wood edge is not available on laminate tops.

For laminate price group 2 pricing, please refer to the electronic catalog or SmartTools.

Standard Includes	Required to Specify
<ul style="list-style-type: none"> • Worksurface: High-Pressure Laminate price group 1 with 3 mm plastic edge • Long grain direction • Solid wood legs: maple • Leg bracket: paint price group 1 	<ol style="list-style-type: none"> 1 Style number 2 Size option (see below under Required Selections) 3 Diameter (see below under Required Selections) 4 Edge profile (see below under Required Selections) 5 Laminate color number for worksurface, if selected 6 Plastic color number for 3 mm plastic edge, if selected 7 Paint color number for leg bracket 8 Options, if selected (see below) <p>▶ See <i>Surface Materials</i>, page 153.</p>

Required Selections		Price	Required to Specify										
Size Option	<ul style="list-style-type: none"> • Modular • Parametric 	No cost No cost	Specify with <i>modular</i> . Specify with <i>parametric</i> .										
Diameter	<table border="0"> <tr> <th style="text-align: left;">Modular</th> <th style="text-align: left;">Parametric</th> </tr> <tr> <td>• 42" Dia.</td> <td>• 42"–47¹⁵/₁₆" Dia.</td> </tr> <tr> <td>• 48" Dia.</td> <td>• 48"–53¹⁵/₁₆" Dia.</td> </tr> <tr> <td>• 54" Dia.</td> <td>• 54"–59¹⁵/₁₆" Dia.</td> </tr> <tr> <td>• 60" Dia.</td> <td>• 60" Dia.</td> </tr> </table>	Modular	Parametric	• 42" Dia.	• 42"–47 ¹⁵ / ₁₆ " Dia.	• 48" Dia.	• 48"–53 ¹⁵ / ₁₆ " Dia.	• 54" Dia.	• 54"–59 ¹⁵ / ₁₆ " Dia.	• 60" Dia.	• 60" Dia.	Prices at right Prices at right Prices at right Prices at right	Specify diameter. Specify diameter. Specify diameter. Specify diameter.
Modular	Parametric												
• 42" Dia.	• 42"–47 ¹⁵ / ₁₆ " Dia.												
• 48" Dia.	• 48"–53 ¹⁵ / ₁₆ " Dia.												
• 54" Dia.	• 54"–59 ¹⁵ / ₁₆ " Dia.												
• 60" Dia.	• 60" Dia.												
Edge Profile, 3 mm Plastic or Wood Edge	<ul style="list-style-type: none"> • 3 mm plastic edge • 3 mm wood edge 	No cost No cost	Specify with <i>3 mm plastic edge</i> . Specify with <i>3 mm wood edge</i> .										
Edge Profile, Slice Wood Edge	<table border="0"> <tr> <th style="text-align: left;">Modular</th> <th style="text-align: left;">Parametric</th> </tr> <tr> <td>• 42" Dia.</td> <td>• 42"–47¹⁵/₁₆" Dia.</td> </tr> <tr> <td>• 48" Dia.</td> <td>• 48"–53¹⁵/₁₆" Dia.</td> </tr> <tr> <td>• 54" Dia.</td> <td>• 54"–59¹⁵/₁₆" Dia.</td> </tr> <tr> <td>• 60" Dia.</td> <td>• 60" Dia.</td> </tr> </table>	Modular	Parametric	• 42" Dia.	• 42"–47 ¹⁵ / ₁₆ " Dia.	• 48" Dia.	• 48"–53 ¹⁵ / ₁₆ " Dia.	• 54" Dia.	• 54"–59 ¹⁵ / ₁₆ " Dia.	• 60" Dia.	• 60" Dia.	+\$250 +\$275 +\$300 +\$350	Specify with <i>slice wood edge</i> . Specify with <i>slice wood edge</i> . Specify with <i>slice wood edge</i> . Specify with <i>slice wood edge</i> .
Modular	Parametric												
• 42" Dia.	• 42"–47 ¹⁵ / ₁₆ " Dia.												
• 48" Dia.	• 48"–53 ¹⁵ / ₁₆ " Dia.												
• 54" Dia.	• 54"–59 ¹⁵ / ₁₆ " Dia.												
• 60" Dia.	• 60" Dia.												
Edge Profile, Drop Wood Edge	<table border="0"> <tr> <th style="text-align: left;">Modular</th> <th style="text-align: left;">Parametric</th> </tr> <tr> <td>• 42" Dia.</td> <td>• 42"–47¹⁵/₁₆" Dia.</td> </tr> <tr> <td>• 48" Dia.</td> <td>• 48"–53¹⁵/₁₆" Dia.</td> </tr> <tr> <td>• 54" Dia.</td> <td>• 54"–59¹⁵/₁₆" Dia.</td> </tr> <tr> <td>• 60" Dia.</td> <td>• 60" Dia.</td> </tr> </table>	Modular	Parametric	• 42" Dia.	• 42"–47 ¹⁵ / ₁₆ " Dia.	• 48" Dia.	• 48"–53 ¹⁵ / ₁₆ " Dia.	• 54" Dia.	• 54"–59 ¹⁵ / ₁₆ " Dia.	• 60" Dia.	• 60" Dia.	+\$400 +\$425 +\$450 +\$500	Specify with <i>drop wood edge</i> . Specify with <i>drop wood edge</i> . Specify with <i>drop wood edge</i> . Specify with <i>drop wood edge</i> .
Modular	Parametric												
• 42" Dia.	• 42"–47 ¹⁵ / ₁₆ " Dia.												
• 48" Dia.	• 48"–53 ¹⁵ / ₁₆ " Dia.												
• 54" Dia.	• 54"–59 ¹⁵ / ₁₆ " Dia.												
• 60" Dia.	• 60" Dia.												
Edge Profile, Eased Wood Edge	<table border="0"> <tr> <th style="text-align: left;">Modular</th> <th style="text-align: left;">Parametric</th> </tr> <tr> <td>• 42" Dia.</td> <td>• 42"–47¹⁵/₁₆" Dia.</td> </tr> <tr> <td>• 48" Dia.</td> <td>• 48"–53¹⁵/₁₆" Dia.</td> </tr> <tr> <td>• 54" Dia.</td> <td>• 54"–59¹⁵/₁₆" Dia.</td> </tr> <tr> <td>• 60" Dia.</td> <td>• 60" Dia.</td> </tr> </table>	Modular	Parametric	• 42" Dia.	• 42"–47 ¹⁵ / ₁₆ " Dia.	• 48" Dia.	• 48"–53 ¹⁵ / ₁₆ " Dia.	• 54" Dia.	• 54"–59 ¹⁵ / ₁₆ " Dia.	• 60" Dia.	• 60" Dia.	+\$550 +\$575 +\$600 +\$650	Specify with <i>eased wood edge</i> . Specify with <i>eased wood edge</i> . Specify with <i>eased wood edge</i> . Specify with <i>eased wood edge</i> .
Modular	Parametric												
• 42" Dia.	• 42"–47 ¹⁵ / ₁₆ " Dia.												
• 48" Dia.	• 48"–53 ¹⁵ / ₁₆ " Dia.												
• 54" Dia.	• 54"–59 ¹⁵ / ₁₆ " Dia.												
• 60" Dia.	• 60" Dia.												

Options		Price	Required to Specify
Surface Materials	High-Pressure Laminate top <ul style="list-style-type: none"> • High-Pressure Laminate price group 2 • Open Line laminate (OLL) 	See information at left +\$ 69 plus cost of laminate	Specify High-Pressure Laminate color number. ▶ See <i>Surface Materials Reference Manual</i> .
	Wood top <ul style="list-style-type: none"> • Wood group 1 • Wood group 2 • Wood group 3 • Customiz stain 	Prices at right Prices at right Prices at right Prices at right	Specify wood color number. Specify wood color number. Specify wood color number. Specify with <i>Customiz stain</i> .
	<ul style="list-style-type: none"> • Full-fill finish on wood group 1 	Prices at right	▶ See <i>Surface Materials Reference Manual</i> . Specify full-fill finish number.

▶ Options, continued on next page

SIN 711.11

► Options, continued from previous page

Tip: Leg finish defaults to top surface finish if top surface is a maple, oak, or walnut species. With all other species of top surface, the leg is specifiable in any finish.

Options	Price	Required to Specify
Surface Materials, continued		
Leg species		
• Maple	No cost	Specify maple finish number.
• Oak	+\$150	Specify oak finish number.
• Walnut	+\$200	Specify walnut finish number.
Leg bracket		
• Paint price group 1	No cost	Specify paint color number.
• Paint price group 2	+\$ 80	Specify paint color number.
• Paint price group 3	+\$140	Specify paint color number.
CC grommet		
• Paint price group 1	No cost	Specify paint color number.
• Paint price group 2	+\$ 12	Specify paint color number.
• Paint price group 3	+\$ 20	Specify paint color number.
CC grommet lid		
• Paint price group 1	No cost	Specify paint color number.
• Paint price group 2	+\$ 8	Specify paint color number.
• Paint price group 3	+\$ 15	Specify paint color number.
Grain Direction		
• Long grain	No cost	Specify with long grain.
• No grain direction	No cost	Specify with no grain direction.
• Short grain	No cost	Specify with short grain.
Grommet(s)		
• No grommet	No cost	Specify with no grommet.
• CC grommet		
– One CC grommet	+\$150	Specify with one CC grommet.
– Two CC grommets	+\$300	Specify with two CC grommets.
Surface Power	Available on tables with CC grommet(s) only	
• Three power	+\$135	Specify with three power.
• Two power, two USB type A	+\$250	Specify with two power, two USB type A.
• One USB type C, two power	+\$350	Specify with one USB type C, two power.
• One USB type C, two USB type A, one power	+\$400	Specify with one USB type C, two USB type A, one power.
Infeed		
• Plug	No cost	Specify with plug.
• Hardwire	+\$ 30	Specify with hardwire.
Cord Length		
• 72"L	No cost	Specify with 72"L.
• 144"L	+\$ 75	Specify with 144"L.

Tip: When OLL top surface is selected, grain direction defaults to vertical.

Tip: Two CC grommets are only specifiable on 54" and larger round tables.

Tip: Cord length is only specifiable when a hardwire infeed is selected.

Verlay

Specification Information

Style Number	Dimensions		Base Prices		Options (Add \$ to Base Price)		
	Modular Diameter	Parametric Diameter	Laminate Top	Wood Group 1 Top	Wood Top	Wood Group 2	Wood Group 3
VLYRWL	42"	42"–47 ¹⁵ / ₁₆ "	\$4024	\$4099	+\$ 69	+\$242	+\$25
	48"	48"–53 ¹⁵ / ₁₆ "	\$4228	\$4328	+\$ 69	+\$242	+\$25
	54"	54"–59 ¹⁵ / ₁₆ "	\$4439	\$4564	+\$124	+\$436	+\$47
	60"	60"	\$4661	\$4811	+\$124	+\$436	+\$47



Gumdrop Tables

SIN 711.11



Tip: Gumdrop tables are available only in a softened shape type.

Tip: Gumdrop tables are available parametrically in 1/16" increments; except when a laminate top surface is specified, parametric sizes must be specified in 3" increments.



3 mm Plastic or Wood Edge

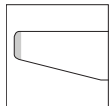

Slice Wood Veneer Edge

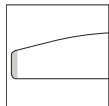

Eased Wood Edge

Tip: Wood edge finish will match top finish.

Tip: Eased wood edge is not available on laminate tops.

For laminate price group 2 pricing, please refer to the electronic catalog or SmartTools.

Standard Includes	Required to Specify
<ul style="list-style-type: none"> • Worksurface: High-Pressure Laminate price group 1 with 3 mm plastic edge • Long grain direction • Solid wood legs: maple • Leg bracket: paint price group 1 	<ol style="list-style-type: none"> 1 Style number 2 Size option (see below under Required Selections) 3 Depth (see below under Required Selections) 4 Width (see below under Required Selections) 5 Edge profile (see below under Required Selections) 6 Laminate color number for worksurface, if selected 7 Plastic color number for 3 mm plastic edge, if selected 8 Paint color number for leg bracket 9 Options, if selected (see below) <p>▶ See <i>Surface Materials</i>, page 153.</p>

Required Selections		Price	Required to Specify																		
Size Option	<ul style="list-style-type: none"> • Modular • Parametric 	No cost No cost	Specify with <i>modular</i> . Specify with <i>parametric</i> .																		
Depth (Longest Side)	<table border="0"> <tr> <td>Modular</td> <td>Parametric</td> </tr> <tr> <td>• 42"D</td> <td>• 42"D–47¹⁵/₁₆"D</td> </tr> <tr> <td>• 48"D</td> <td>• 48"D</td> </tr> </table>	Modular	Parametric	• 42"D	• 42"D–47 ¹⁵ / ₁₆ "D	• 48"D	• 48"D	Prices at right Prices at right	Specify depth. Specify depth.												
Modular	Parametric																				
• 42"D	• 42"D–47 ¹⁵ / ₁₆ "D																				
• 48"D	• 48"D																				
Width	<table border="0"> <tr> <td>Modular</td> <td>Parametric</td> </tr> <tr> <td>• 42"W</td> <td>• 42"W–47¹⁵/₁₆"W</td> </tr> <tr> <td>• 48"W</td> <td>• 48"W–53¹⁵/₁₆"W</td> </tr> <tr> <td>• 54"W</td> <td>• 54"W–59¹⁵/₁₆"W</td> </tr> <tr> <td>• 60"W</td> <td>• 60"W–65¹⁵/₁₆"W</td> </tr> <tr> <td>• 66"W</td> <td>• 66"W</td> </tr> </table>	Modular	Parametric	• 42"W	• 42"W–47 ¹⁵ / ₁₆ "W	• 48"W	• 48"W–53 ¹⁵ / ₁₆ "W	• 54"W	• 54"W–59 ¹⁵ / ₁₆ "W	• 60"W	• 60"W–65 ¹⁵ / ₁₆ "W	• 66"W	• 66"W	Prices at right Prices at right Prices at right Prices at right Prices at right	Specify width. Specify width. Specify width. Specify width. Specify width.						
Modular	Parametric																				
• 42"W	• 42"W–47 ¹⁵ / ₁₆ "W																				
• 48"W	• 48"W–53 ¹⁵ / ₁₆ "W																				
• 54"W	• 54"W–59 ¹⁵ / ₁₆ "W																				
• 60"W	• 60"W–65 ¹⁵ / ₁₆ "W																				
• 66"W	• 66"W																				
Edge Profile, 3 mm Plastic or Wood Edge	<ul style="list-style-type: none"> • 3 mm plastic edge • 3 mm wood edge 	No cost No cost	Specify with <i>3 mm plastic edge</i> . Specify with <i>3 mm wood edge</i> .																		
Edge Profile, Slice Wood Edge	<table border="0"> <tr> <td>Modular</td> <td>Parametric</td> <td></td> </tr> <tr> <td>• 42"W</td> <td>• 42"W–47¹⁵/₁₆"W</td> <td>+\$250</td> </tr> <tr> <td>• 48"W</td> <td>• 48"W–53¹⁵/₁₆"W</td> <td>+\$260</td> </tr> <tr> <td>• 54"W</td> <td>• 54"W–59¹⁵/₁₆"W</td> <td>+\$270</td> </tr> <tr> <td>• 60"W</td> <td>• 60"W–65¹⁵/₁₆"W</td> <td>+\$280</td> </tr> <tr> <td>• 66"W</td> <td>• 66"W</td> <td>+\$290</td> </tr> </table>	Modular	Parametric		• 42"W	• 42"W–47 ¹⁵ / ₁₆ "W	+\$250	• 48"W	• 48"W–53 ¹⁵ / ₁₆ "W	+\$260	• 54"W	• 54"W–59 ¹⁵ / ₁₆ "W	+\$270	• 60"W	• 60"W–65 ¹⁵ / ₁₆ "W	+\$280	• 66"W	• 66"W	+\$290		Specify with <i>slice wood edge</i> . Specify with <i>slice wood edge</i> . Specify with <i>slice wood edge</i> . Specify with <i>slice wood edge</i> . Specify with <i>slice wood edge</i> .
Modular	Parametric																				
• 42"W	• 42"W–47 ¹⁵ / ₁₆ "W	+\$250																			
• 48"W	• 48"W–53 ¹⁵ / ₁₆ "W	+\$260																			
• 54"W	• 54"W–59 ¹⁵ / ₁₆ "W	+\$270																			
• 60"W	• 60"W–65 ¹⁵ / ₁₆ "W	+\$280																			
• 66"W	• 66"W	+\$290																			
Edge Profile, Eased Wood Edge	<table border="0"> <tr> <td>Modular</td> <td>Parametric</td> <td></td> </tr> <tr> <td>• 42"W</td> <td>• 42"W–47¹⁵/₁₆"W</td> <td>+\$550</td> </tr> <tr> <td>• 48"W</td> <td>• 48"W–53¹⁵/₁₆"W</td> <td>+\$560</td> </tr> <tr> <td>• 54"W</td> <td>• 54"W–59¹⁵/₁₆"W</td> <td>+\$570</td> </tr> <tr> <td>• 60"W</td> <td>• 60"W–65¹⁵/₁₆"W</td> <td>+\$580</td> </tr> <tr> <td>• 66"W</td> <td>• 66"W</td> <td>+\$590</td> </tr> </table>	Modular	Parametric		• 42"W	• 42"W–47 ¹⁵ / ₁₆ "W	+\$550	• 48"W	• 48"W–53 ¹⁵ / ₁₆ "W	+\$560	• 54"W	• 54"W–59 ¹⁵ / ₁₆ "W	+\$570	• 60"W	• 60"W–65 ¹⁵ / ₁₆ "W	+\$580	• 66"W	• 66"W	+\$590		Specify with <i>eased wood edge</i> . Specify with <i>eased wood edge</i> . Specify with <i>eased wood edge</i> . Specify with <i>eased wood edge</i> . Specify with <i>eased wood edge</i> .
Modular	Parametric																				
• 42"W	• 42"W–47 ¹⁵ / ₁₆ "W	+\$550																			
• 48"W	• 48"W–53 ¹⁵ / ₁₆ "W	+\$560																			
• 54"W	• 54"W–59 ¹⁵ / ₁₆ "W	+\$570																			
• 60"W	• 60"W–65 ¹⁵ / ₁₆ "W	+\$580																			
• 66"W	• 66"W	+\$590																			

Options		Price	Required to Specify
Surface Materials	High-Pressure Laminate top <ul style="list-style-type: none"> • High-Pressure Laminate price group 2 • Open Line laminate (OLL) 	See information at left +\$ 69 plus cost of laminate	Specify High-Pressure Laminate color number. ▶ See <i>Surface Materials Reference Manual</i> .
	Wood top <ul style="list-style-type: none"> • Wood group 1 • Wood group 2 • Wood group 3 • Customiz stain 	Prices at right Prices at right Prices at right Prices at right	Specify wood color number. Specify wood color number. Specify wood color number. Specify with <i>Customiz stain</i> .
	<ul style="list-style-type: none"> • Full-fill finish on wood group 1 	Prices at right	▶ See <i>Surface Materials Reference Manual</i> . Specify full-fill finish number.

▶ Options, continued on next page

SIN 711.11

► Options, continued from previous page

Options	Price	Required to Specify
Surface Materials, continued		
Leg species		
• Maple	No cost	Specify maple finish number.
• Oak	+\$150	Specify oak finish number.
• Walnut	+\$200	Specify walnut finish number.
Leg bracket		
• Paint price group 1	No cost	Specify paint color number.
• Paint price group 2	+\$ 80	Specify paint color number.
• Paint price group 3	+\$140	Specify paint color number.
CC grommet		
• Paint price group 1	No cost	Specify paint color number.
• Paint price group 2	+\$ 12	Specify paint color number.
• Paint price group 3	+\$ 20	Specify paint color number.
CC grommet lid		
• Paint price group 1	No cost	Specify paint color number.
• Paint price group 2	+\$ 8	Specify paint color number.
• Paint price group 3	+\$ 15	Specify paint color number.
Grain Direction		
• Long grain	No cost	Specify with long grain.
• No grain direction	No cost	Specify with no grain direction.
• Short grain	No cost	Specify with short grain.
Grommet(s)	Available on tables with CC grommet(s) only	
• No grommet	No cost	Specify with no grommet.
• CC grommet		
– One CC grommet	+\$150	Specify with one CC grommet.
– Two CC grommets	+\$300	Specify with two CC grommets.
• Long grommet		
– One long grommet	+\$200	Specify with one long grommet.
Surface Power		
• Three power	+\$135	Specify with three power.
• Two power, two USB type A	+\$250	Specify with two power, two USB type A.
• One USB type C, two power	+\$350	Specify with one USB type C, two power.
• One USB type C, two USB type A, one power	+\$400	Specify with one USB type C, two USB type A, one power.
Infeed		
• Plug	No cost	Specify with plug.
• Hardwire	+\$ 30	Specify with hardwire.
Cord Length		
• 72"L	No cost	Specify with 72"L.
• 144"L	+\$ 75	Specify with 144"L.

Tip: Leg finish defaults to top surface finish if top surface is a maple, oak, or walnut species. With all other species of top surface, the leg is specifiable in any finish.

Tip: When OLL top surface is selected, grain direction defaults to vertical.

Tip: Long grommet is only specifiable on 66"W gumdrop tables.

Tip: Two CC grommets are only specifiable on 54"W and larger gumdrop tables.

Tip: Cord length is only specifiable when a hardwire infeed is selected.

Specification Information

• Style Number	• Dimensions				• Base Prices			• Options (Add \$ to Base Price)		
	• Depth (Longest Side)		• Width		• Laminate Top	• Wood Group 1 Top	• Wood Top		Full-Fill Finish on Wood Group 1	
	Modular Depth	Parametric Depth	Modular Width	Parametric Width		Wood Group 2	Wood Group 3			
VLYGDWL	42"	42"–47 ¹⁵ / ₁₆ "	42"	42"–47 ¹⁵ / ₁₆ "	\$3905	\$3980	+\$ 71	+\$240	+\$25	
	42"	42"–47 ¹⁵ / ₁₆ "	48"	48"–53 ¹⁵ / ₁₆ "	\$4305	\$4405	+\$106	+\$250	+\$25	
	42"	42"–47 ¹⁵ / ₁₆ "	54"	54"–59 ¹⁵ / ₁₆ "	\$4555	\$4680	+\$141	+\$260	+\$47	
	42"	42"–47 ¹⁵ / ₁₆ "	60"	60"–65 ¹⁵ / ₁₆ "	\$4805	\$4955	+\$176	+\$270	+\$47	
	42"	42"–47 ¹⁵ / ₁₆ "	66"	66"	\$5055	\$5230	+\$211	+\$280	+\$47	
	48"	48"	42"	42"–47 ¹⁵ / ₁₆ "	\$3955	\$4080	+\$ 71	+\$240	+\$25	
	48"	48"	48"	48"–53 ¹⁵ / ₁₆ "	\$4355	\$4505	+\$106	+\$250	+\$25	
	48"	48"	54"	54"–59 ¹⁵ / ₁₆ "	\$4605	\$4780	+\$141	+\$260	+\$47	
	48"	48"	60"	60"–65 ¹⁵ / ₁₆ "	\$4855	\$5055	+\$176	+\$270	+\$47	
	48"	48"	66"	66"	\$5105	\$5330	+\$211	+\$280	+\$47	



Tip: The smallest side on a gumdrop table is always 6" shorter than the longest side. For example, a 42"D table would have a 36"D tapered side.

Square Tables

SIN 711.11

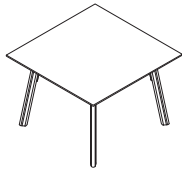

Tip: Square tables are available parametrically in 1/16" increments; except when softened shape type and laminate top surface is specified, parametric sizes must be specified in 3" increments.

Tip: Rounded and square corner shapes are only available on tables with straight shape type, not softened shape type.

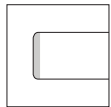

3 mm Plastic or Wood Edge

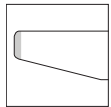

Slice Wood Veneer Edge

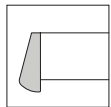

Drop Wood Edge

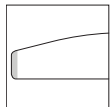

Eased Wood Edge

Tip: Wood edge finish will match top finish.

Tip: Solid drop wood edge not available on softened shapes.

Tip: Eased wood edge is not available on laminate tops or tops with square corners.

Standard Includes	Required to Specify
<ul style="list-style-type: none"> • Worksurface: High-Pressure Laminate price group 1 with 3 mm plastic edge • Long grain direction • Straight shape type • Solid wood legs: maple • Leg bracket: paint price group 1 	<ol style="list-style-type: none"> 1 Style number 2 Size option (see below under Required Selections) 3 Width (see below under Required Selections) 4 Corner shape (see below under Required Selections) 5 Edge profile (see below under Required Selections) 6 Laminate color number for worksurface, if selected 7 Plastic color number for 3 mm plastic edge, if selected 8 Paint color number for leg bracket 9 Options, if selected (see below) <p>▶ See <i>Surface Materials</i>, page 153.</p>

Required Selections	Price	Required to Specify									
Size Option <ul style="list-style-type: none"> • Modular • Parametric 	No cost No cost	Specify with modular. Specify with parametric.									
Width <table border="0"> <tr> <td>Modular</td> <td>Parametric</td> <td></td> </tr> <tr> <td>• 42"W</td> <td>• 42"W-44 1/2"W</td> <td>Prices at right</td> </tr> <tr> <td>• 48"W</td> <td>• 44 9/16"W-48"W</td> <td>Prices at right</td> </tr> </table>	Modular	Parametric		• 42"W	• 42"W-44 1/2"W	Prices at right	• 48"W	• 44 9/16"W-48"W	Prices at right		Specify width. Specify width.
Modular	Parametric										
• 42"W	• 42"W-44 1/2"W	Prices at right									
• 48"W	• 44 9/16"W-48"W	Prices at right									
Corner Shape <ul style="list-style-type: none"> • Rounded • Square 	No cost No cost	Specify with rounded corners. Specify with square corners.									
Edge Profile, 3 mm Plastic or Wood Edge <ul style="list-style-type: none"> • 3 mm plastic edge • 3 mm wood edge 	No cost No cost	Specify with 3 mm plastic edge. Specify with 3 mm wood edge.									
Edge Profile, Slice Wood Edge <table border="0"> <tr> <td>Modular</td> <td>Parametric</td> <td></td> </tr> <tr> <td>• 42"W</td> <td>• 42"W-44 1/2"W</td> <td>+\$250</td> </tr> <tr> <td>• 48"W</td> <td>• 44 9/16"W-48"W</td> <td>+\$275</td> </tr> </table>	Modular	Parametric		• 42"W	• 42"W-44 1/2"W	+\$250	• 48"W	• 44 9/16"W-48"W	+\$275		Specify with slice wood edge. Specify with slice wood edge.
Modular	Parametric										
• 42"W	• 42"W-44 1/2"W	+\$250									
• 48"W	• 44 9/16"W-48"W	+\$275									
Edge Profile, Drop Wood Edge <table border="0"> <tr> <td>Modular</td> <td>Parametric</td> <td></td> </tr> <tr> <td>• 42"W</td> <td>• 42"W-44 1/2"W</td> <td>+\$400</td> </tr> <tr> <td>• 48"W</td> <td>• 44 9/16"W-48"W</td> <td>+\$425</td> </tr> </table>	Modular	Parametric		• 42"W	• 42"W-44 1/2"W	+\$400	• 48"W	• 44 9/16"W-48"W	+\$425		Specify with drop wood edge. Specify with drop wood edge.
Modular	Parametric										
• 42"W	• 42"W-44 1/2"W	+\$400									
• 48"W	• 44 9/16"W-48"W	+\$425									
Edge Profile, Eased Wood Edge <table border="0"> <tr> <td>Modular</td> <td>Parametric</td> <td></td> </tr> <tr> <td>• 42"W</td> <td>• 42"W-44 1/2"W</td> <td>+\$550</td> </tr> <tr> <td>• 48"W</td> <td>• 44 9/16"W-48"W</td> <td>+\$575</td> </tr> </table>	Modular	Parametric		• 42"W	• 42"W-44 1/2"W	+\$550	• 48"W	• 44 9/16"W-48"W	+\$575		Specify with eased wood edge. Specify with eased wood edge.
Modular	Parametric										
• 42"W	• 42"W-44 1/2"W	+\$550									
• 48"W	• 44 9/16"W-48"W	+\$575									

Options	Price	Required to Specify
Surface Materials <ul style="list-style-type: none"> • High-Pressure Laminate price group 2 • Open Line laminate (OLL) 	See information at left +\$ 69 plus cost of laminate	Specify High-Pressure Laminate color number. ▶ See <i>Surface Materials Reference Manual</i> .
Wood top <ul style="list-style-type: none"> • Wood group 1 • Wood group 2 • Wood group 3 • Customiz stain 	Prices at right Prices at right Prices at right Prices at right	Specify wood color number. Specify wood color number. Specify wood color number. Specify with Customiz stain. ▶ See <i>Surface Materials Reference Manual</i> .
<ul style="list-style-type: none"> • Full-fill finish on wood group 1 	Prices at right	Specify full-fill finish number.

▶ Options, continued on next page

For laminate price group 2 pricing, please refer to the electronic catalog or SmartTools.

SIN 711.11

► Options, continued from previous page

Tip: Leg finish defaults to top surface finish if top surface is a maple, oak, or walnut species. With all other species of top surface, the leg is specifiable in any finish.

Options	Price	Required to Specify
Surface Materials, continued		
Leg species		
• Maple	No cost	Specify maple finish number.
• Oak	+\$150	Specify oak finish number.
• Walnut	+\$200	Specify walnut finish number.
Leg bracket		
• Paint price group 1	No cost	Specify paint color number.
• Paint price group 2	+\$ 80	Specify paint color number.
• Paint price group 3	+\$140	Specify paint color number.
CC grommet		
• Paint price group 1	No cost	Specify paint color number.
• Paint price group 2	+\$ 12	Specify paint color number.
• Paint price group 3	+\$ 20	Specify paint color number.
CC grommet lid		
• Paint price group 1	No cost	Specify paint color number.
• Paint price group 2	+\$ 8	Specify paint color number.
• Paint price group 3	+\$ 15	Specify paint color number.
Shape Type, Softened		
Modular		
• 42"W	+\$291	Specify with softened shape type.
• 48"W	+\$364	Specify with softened shape type.
Parametric		
• 42"W-44 ¹ / ₂ "W		
• 44 ⁹ / ₁₆ "W-48"W		
Grain Direction		
• Long grain	No cost	Specify with long grain.
• No grain direction	No cost	Specify with no grain direction.
• Short grain	No cost	Specify with short grain.
Grommet		
• No grommet	No cost	Specify with no grommet.
• CC grommet		
– One CC grommet	+\$150	Specify with one CC grommet.
Surface Power		
Available on tables with CC grommet(s) only		
• Three power	+\$135	Specify with three power.
• Two power, two USB type A	+\$250	Specify with two power, two USB type A.
• One USB type C, two power	+\$350	Specify with one USB type C, two power.
• One USB type C, two USB type A, one power	+\$400	Specify with one USB type C, two USB type A, one power.
Infeed		
• Plug	No cost	Specify with plug.
• Hardwire	+\$ 30	Specify with hardwire.
Cord Length		
• 72"L	No cost	Specify with 72"L.
• 144"L	+\$ 75	Specify with 144"L.

Tip: When OLL top surface is selected, grain direction defaults to vertical.

Tip: Cord length is only specifiable when a hardwire infeed is selected.

Specification Information

Style Number	Dimensions		Base Prices		Options (Add \$ to Base Price)		
	Modular Width	Parametric Width	Laminate Top	Wood Group 1 Top	Wood Top	Wood Group 2	Wood Group 3
VLYSQWL	42"	42"-44 ¹ / ₂ "	\$4024	\$4099	Full-Fill	Finish on Wood	Group 1
	48"	44 ⁹ / ₁₆ "-48"	\$4228	\$4353	Wood Group 2	Wood Group 3	

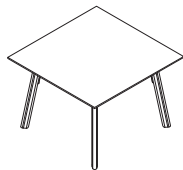

Rectangle Tables

SIN 711.11

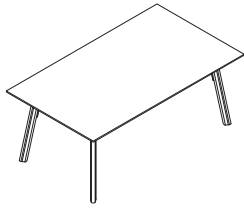

Tip: Rectangle tables are available parametrically in 1/16" increments; except when softened shape type and laminate top surface is specified, parametric sizes must be specified in 3" increments.

Tip: Rounded and square corner shapes are only available on tables with straight shape type, not softened shape type.

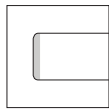

3 mm Plastic or Wood Edge

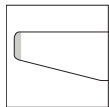

Slice Wood Veneer Edge

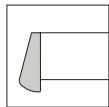

Drop Wood Edge

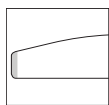

Eased Wood Edge

Tip: Wood edge finish will match top finish.

Tip: Solid drop wood edge not available on softened shapes.

Tip: Eased wood edge is not available on laminate tops or tops with square corners.

Standard Includes	Required to Specify
-------------------	---------------------

- Worksurface: High-Pressure Laminate price group 1 with 3 mm plastic edge
- Long grain direction
- Straight shape type
- Solid wood legs: maple
- Leg bracket: paint price group 1

- 1 Style number
 - 2 Size option (see below under Required Selections)
 - 3 Depth (see below under Required Selections)
 - 4 Width (see below under Required Selections)
 - 5 Corner shape (see below under Required Selections)
 - 6 Edge profile (see below under Required Selections)
 - 7 Laminate color number for worksurface, if selected
 - 8 Plastic color number for 3 mm plastic edge, if selected
 - 9 Paint color number for leg bracket
 - 10 Options, if selected (see below)
- ▶ See *Surface Materials*, page 153.

	Required Selections	Price	Required to Specify												
Size Option	<ul style="list-style-type: none"> • Modular • Parametric 	No cost No cost	Specify with modular. Specify with parametric.												
Depth	<table border="1"> <thead> <tr> <th>Modular</th> <th>Parametric</th> </tr> </thead> <tbody> <tr> <td>• 42"D</td> <td>• 42"D-47¹⁵/₁₆"D</td> </tr> <tr> <td>• 48"D</td> <td>• 48"D</td> </tr> </tbody> </table>	Modular	Parametric	• 42"D	• 42"D-47 ¹⁵ / ₁₆ "D	• 48"D	• 48"D	Prices at right Prices at right	Specify depth. Specify depth.						
Modular	Parametric														
• 42"D	• 42"D-47 ¹⁵ / ₁₆ "D														
• 48"D	• 48"D														
Width	<table border="1"> <thead> <tr> <th>Modular</th> <th>Parametric</th> </tr> </thead> <tbody> <tr> <td>• 72"W</td> <td>• 72"W-83¹⁵/₁₆"W</td> </tr> <tr> <td>• 84"W</td> <td>• 84"W-95¹⁵/₁₆"W</td> </tr> <tr> <td>• 96"W</td> <td>• 96"W</td> </tr> </tbody> </table>	Modular	Parametric	• 72"W	• 72"W-83 ¹⁵ / ₁₆ "W	• 84"W	• 84"W-95 ¹⁵ / ₁₆ "W	• 96"W	• 96"W	Prices at right Prices at right Prices at right	Specify width. Specify width. Specify width.				
Modular	Parametric														
• 72"W	• 72"W-83 ¹⁵ / ₁₆ "W														
• 84"W	• 84"W-95 ¹⁵ / ₁₆ "W														
• 96"W	• 96"W														
Corner Shape	<ul style="list-style-type: none"> • Rounded • Square 	No cost No cost	Specify with rounded corners. Specify with square corners.												
Edge Profile, 3 mm Plastic or Wood Edge	<ul style="list-style-type: none"> • 3 mm plastic edge • 3 mm wood edge 	No cost No cost	Specify with 3 mm plastic edge. Specify with 3 mm wood edge.												
Edge Profile, Slice Wood Edge	<table border="1"> <thead> <tr> <th>Modular</th> <th>Parametric</th> <th>Price</th> </tr> </thead> <tbody> <tr> <td>• 72"W</td> <td>• 72"W-83¹⁵/₁₆"W</td> <td>+\$350</td> </tr> <tr> <td>• 84"W</td> <td>• 84"W-95¹⁵/₁₆"W</td> <td>+\$375</td> </tr> <tr> <td>• 96"W</td> <td>• 96"W</td> <td>+\$400</td> </tr> </tbody> </table>	Modular	Parametric	Price	• 72"W	• 72"W-83 ¹⁵ / ₁₆ "W	+\$350	• 84"W	• 84"W-95 ¹⁵ / ₁₆ "W	+\$375	• 96"W	• 96"W	+\$400		Specify with slice wood edge. Specify with slice wood edge. Specify with slice wood edge.
Modular	Parametric	Price													
• 72"W	• 72"W-83 ¹⁵ / ₁₆ "W	+\$350													
• 84"W	• 84"W-95 ¹⁵ / ₁₆ "W	+\$375													
• 96"W	• 96"W	+\$400													
Edge Profile, Drop Wood Edge	<table border="1"> <thead> <tr> <th>Modular</th> <th>Parametric</th> <th>Price</th> </tr> </thead> <tbody> <tr> <td>• 72"W</td> <td>• 72"W-83¹⁵/₁₆"W</td> <td>+\$500</td> </tr> <tr> <td>• 84"W</td> <td>• 84"W-95¹⁵/₁₆"W</td> <td>+\$525</td> </tr> <tr> <td>• 96"W</td> <td>• 96"W</td> <td>+\$550</td> </tr> </tbody> </table>	Modular	Parametric	Price	• 72"W	• 72"W-83 ¹⁵ / ₁₆ "W	+\$500	• 84"W	• 84"W-95 ¹⁵ / ₁₆ "W	+\$525	• 96"W	• 96"W	+\$550		Specify with drop wood edge. Specify with drop wood edge. Specify with drop wood edge.
Modular	Parametric	Price													
• 72"W	• 72"W-83 ¹⁵ / ₁₆ "W	+\$500													
• 84"W	• 84"W-95 ¹⁵ / ₁₆ "W	+\$525													
• 96"W	• 96"W	+\$550													
Edge Profile, Eased Wood Edge	<table border="1"> <thead> <tr> <th>Modular</th> <th>Parametric</th> <th>Price</th> </tr> </thead> <tbody> <tr> <td>• 72"W</td> <td>• 72"W-83¹⁵/₁₆"W</td> <td>+\$650</td> </tr> <tr> <td>• 84"W</td> <td>• 84"W-95¹⁵/₁₆"W</td> <td>+\$675</td> </tr> <tr> <td>• 96"W</td> <td>• 96"W</td> <td>+\$700</td> </tr> </tbody> </table>	Modular	Parametric	Price	• 72"W	• 72"W-83 ¹⁵ / ₁₆ "W	+\$650	• 84"W	• 84"W-95 ¹⁵ / ₁₆ "W	+\$675	• 96"W	• 96"W	+\$700		Specify with eased wood edge. Specify with eased wood edge. Specify with eased wood edge.
Modular	Parametric	Price													
• 72"W	• 72"W-83 ¹⁵ / ₁₆ "W	+\$650													
• 84"W	• 84"W-95 ¹⁵ / ₁₆ "W	+\$675													
• 96"W	• 96"W	+\$700													

▶ Options, on next page

SIN 711.11

► Required Selections, on previous page

	Options	Price	Required to Specify
Surface Materials	High-Pressure Laminate top		
	• High-Pressure Laminate price group 2	See information at left	Specify High-Pressure Laminate color number.
	• Open Line laminate (OLL)	+\$ 69 plus cost of laminate	► See <i>Surface Materials Reference Manual</i> .
	Wood top		
	• Wood group 1	Prices at right	Specify wood color number.
	• Wood group 2	Prices at right	Specify wood color number.
	• Wood group 3	Prices at right	Specify wood color number.
	• Customiz stain	Prices at right	Specify with <i>Customiz stain</i> .
	• Full-fill finish on wood group 1	Prices at right	► See <i>Surface Materials Reference Manual</i> . Specify full-fill finish number.
	Leg species		
• Maple	No cost	Specify maple finish number.	
• Oak	+\$150	Specify oak finish number.	
• Walnut	+\$200	Specify walnut finish number.	
Leg bracket			
• Paint price group 1	No cost	Specify paint color number.	
• Paint price group 2	+\$ 80	Specify paint color number.	
• Paint price group 3	+\$140	Specify paint color number.	
CC grommet			
• Paint price group 1	No cost	Specify paint color number.	
• Paint price group 2	+\$ 12	Specify paint color number.	
• Paint price group 3	+\$ 20	Specify paint color number.	
CC grommet lid			
• Paint price group 1	No cost	Specify paint color number.	
• Paint price group 2	+\$ 8	Specify paint color number.	
• Paint price group 3	+\$ 15	Specify paint color number.	
Shape Type, Softened	Modular	Parametric	
	• 72"W	• 72"W–83 ¹⁵ / ₁₆ "W	+\$350
	• 84"W	• 84"W–95 ¹⁵ / ₁₆ "W	+\$450
	• 96"W	• 96"W	+\$550
			Specify with <i>softened shape type</i> .
Grain Direction	• Long grain	No cost	Specify with <i>long grain</i> .
	• No grain direction	No cost	Specify with <i>no grain direction</i> .
	• Short grain	No cost	Specify with <i>short grain</i> .
Grommet(s)	• No grommet	No cost	Specify with <i>no grommet</i> .
	• CC grommet		
	– One CC grommet	+\$150	Specify with <i>one CC grommet</i> .
	– Two CC grommets	+\$300	Specify with <i>two CC grommets</i> .
	– Three CC grommets	+\$450	Specify with <i>three CC grommets</i> .
	– Four CC grommets	+\$600	Specify with <i>four CC grommets</i> .
	• Long grommet		
	– One long grommet	+\$200	Specify with <i>one long grommet</i> .
	– Two long grommets	+\$400	Specify with <i>two long grommets</i> .
Surface Power	Available on tables with CC grommet(s) only		
	• Three power	+\$135	Specify with <i>three power</i> .
	• Two power, two USB type A	+\$250	Specify with <i>two power, two USB type A</i> .
	• One USB type C, two power	+\$350	Specify with <i>one USB type C, two power</i> .
	• One USB type C, two USB type A, one power	+\$400	Specify with <i>one USB type C, two USB type A, one power</i> .
Infeed	• Plug	No cost	Specify with <i>plug</i> .
	• Hardwire	+\$ 30	Specify with <i>hardwire</i> .
Cord Length	• 72"L	No cost	Specify with <i>72"L</i> .
	• 144"L	+\$ 75	Specify with <i>144"L</i> .

For laminate price group 2 pricing, please refer to the electronic catalog or SmartTools.

Tip: Leg finish defaults to top surface finish if top surface is a maple, oak, or walnut species. With all other species of top surface, the leg is specifiable in any finish.

Tip: When OLL top surface is selected, grain direction defaults to vertical.

Tip: Two CC grommets are only specifiable on 54"W and larger sightline tables. Three CC grommets are only specifiable on 96"W and larger sightline tables. Four CC grommets are only specifiable on 78"W and larger sightline tables.

Tip: Two long grommets are only specifiable on 90"W and larger sightline tables.

Tip: Cord length is only specifiable when a hardwire infeed is selected.

Tip: Cord length is not specifiable with a long metal grommet count of two, or a CC grommet count of three or four.

► Specification Information, on next page

Rectangle Tables, continued

SIN 711.11

► Options, on previous page

Specification Information

• Style Number	• Dimensions				• Base Prices		• Options (Add \$ to Base Price)		
	• Depth		• Width		• Laminate Top	• Wood Group 1 Top	• Wood Top		Full-Fill Finish on Wood Group 1
	Modular Depth	Parametric Depth	Modular Width	Parametric Width			Wood Group 2	Wood Group 3	
VLYRECWL	42"	42"-47 ¹⁵ / ₁₆ "	72"	72"-83 ¹⁵ / ₁₆ "	\$4929	\$5144	+\$120	+\$440	+\$71
	42"	42"-47 ¹⁵ / ₁₆ "	84"	84"-95 ¹⁵ / ₁₆ "	\$5079	\$5304	+\$140	+\$490	+\$71
	42"	42"-47 ¹⁵ / ₁₆ "	96"	96"	\$5229	\$5479	+\$160	+\$540	+\$71
	48"	48"	72"	72"-83 ¹⁵ / ₁₆ "	\$5329	\$5544	+\$120	+\$440	+\$71
	48"	48"	84"	84"-95 ¹⁵ / ₁₆ "	\$5529	\$5779	+\$140	+\$490	+\$71
	48"	48"	96"	96"	\$5679	\$5954	+\$160	+\$540	+\$71

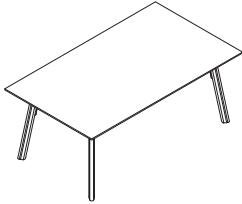

SIN 711.11

Sightline Tables

SIN 711.11

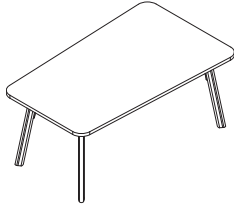

Tip: Sightline tables are available parametrically in 1/16" increments; except when softened shape type and laminate top surface is specified, parametric sizes must be specified in 3" increments.

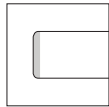

3 mm Plastic or Wood Edge

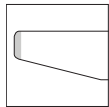

Slice Wood Veneer Edge

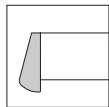

Drop Wood Edge

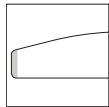

Eased Wood Edge

Tip: Eased wood edge is not available on laminate tops.

Tip: Wood edge finish will match top finish.

Tip: Solid drop wood edge not available on softened shapes.

Standard Includes	Required to Specify
<ul style="list-style-type: none"> • Worksurface: High-Pressure Laminate price group 1 with 3 mm plastic edge • Long grain direction • Straight shape type • Solid wood legs: maple • Leg bracket: paint price group 1 	<ol style="list-style-type: none"> 1 Style number 2 Size option (see below under Required Selections) 3 Depth (see below under Required Selections) 4 Width (see below under Required Selections) 5 Edge profile (see below under Required Selections) 6 Laminate color number for worksurface, if selected 7 Plastic color number for 3 mm plastic edge, if selected 8 Paint color number for leg bracket 9 Options, if selected (see below) <p>▶ See <i>Surface Materials</i>, page 153.</p>

Required Selections		Price	Required to Specify						
Size Option	<ul style="list-style-type: none"> • Modular • Parametric 	No cost No cost	Specify <i>with modular</i> . Specify <i>with parametric</i> .						
Depth (Longest Side)	<table border="0"> <tr> <td>Modular</td> <td>Parametric</td> </tr> <tr> <td>• 42"D</td> <td>• 42"D–47¹⁵/₁₆"D</td> </tr> <tr> <td>• 48"D</td> <td>• 48"D</td> </tr> </table>	Modular	Parametric	• 42"D	• 42"D–47 ¹⁵ / ₁₆ "D	• 48"D	• 48"D	Prices at right Prices at right	Specify depth. Specify depth.
Modular	Parametric								
• 42"D	• 42"D–47 ¹⁵ / ₁₆ "D								
• 48"D	• 48"D								
Width	<table border="0"> <tr> <td>Modular</td> <td>Parametric</td> </tr> <tr> <td>• 72"W</td> <td>• 72"W–83¹⁵/₁₆"W</td> </tr> <tr> <td>• 96"W</td> <td>• 84"W–96"W</td> </tr> </table>	Modular	Parametric	• 72"W	• 72"W–83 ¹⁵ / ₁₆ "W	• 96"W	• 84"W–96"W	Prices at right Prices at right	Specify width. Specify width.
Modular	Parametric								
• 72"W	• 72"W–83 ¹⁵ / ₁₆ "W								
• 96"W	• 84"W–96"W								
Edge Profile, 3 mm Plastic or Wood Edge	<ul style="list-style-type: none"> • 3 mm plastic edge • 3 mm wood edge 	No cost No cost	Specify <i>with 3 mm plastic edge</i> . Specify <i>with 3 mm wood edge</i> .						
Edge Profile, Slice Wood Edge	<table border="0"> <tr> <td>Modular</td> <td>Parametric</td> </tr> <tr> <td>• 72"W</td> <td>• 72"W–83¹⁵/₁₆"W</td> </tr> <tr> <td>• 96"W</td> <td>• 84"W–96"W</td> </tr> </table>	Modular	Parametric	• 72"W	• 72"W–83 ¹⁵ / ₁₆ "W	• 96"W	• 84"W–96"W	+\$350 +\$400	Specify <i>with slice wood edge</i> . Specify <i>with slice wood edge</i> .
Modular	Parametric								
• 72"W	• 72"W–83 ¹⁵ / ₁₆ "W								
• 96"W	• 84"W–96"W								
Edge Profile, Drop Wood Edge	<table border="0"> <tr> <td>Modular</td> <td>Parametric</td> </tr> <tr> <td>• 72"W</td> <td>• 72"W–83¹⁵/₁₆"W</td> </tr> <tr> <td>• 96"W</td> <td>• 84"W–96"W</td> </tr> </table>	Modular	Parametric	• 72"W	• 72"W–83 ¹⁵ / ₁₆ "W	• 96"W	• 84"W–96"W	+\$500 +\$550	Specify <i>with drop wood edge</i> . Specify <i>with drop wood edge</i> .
Modular	Parametric								
• 72"W	• 72"W–83 ¹⁵ / ₁₆ "W								
• 96"W	• 84"W–96"W								
Edge Profile, Eased Wood Edge	<table border="0"> <tr> <td>Modular</td> <td>Parametric</td> </tr> <tr> <td>• 72"W</td> <td>• 72"W–83¹⁵/₁₆"W</td> </tr> <tr> <td>• 96"W</td> <td>• 84"W–96"W</td> </tr> </table>	Modular	Parametric	• 72"W	• 72"W–83 ¹⁵ / ₁₆ "W	• 96"W	• 84"W–96"W	+\$650 +\$700	Specify <i>with eased wood edge</i> . Specify <i>with eased wood edge</i> .
Modular	Parametric								
• 72"W	• 72"W–83 ¹⁵ / ₁₆ "W								
• 96"W	• 84"W–96"W								

For laminate price group 2 pricing, please refer to the electronic catalog or SmartTools.

Tip: Leg finish defaults to top surface finish if top surface is a maple, oak, or walnut species. With all other species of top surface, the leg is specifiable in any finish.

Tip: When OLL top surface is selected, grain direction defaults to vertical.

Tip: Two CC grommets are only specifiable on 54"W and larger sightline tables. Three CC grommets are only specifiable on 96"W and larger sightline tables. Four CC grommets are only specifiable on 78"W and larger sightline tables.

Tip: Two long grommets are only specifiable on 90"W and larger sightline tables.

Tip: Cord length is only specifiable when a hardwire infeed is selected.

Tip: Cord length is not specifiable with a long metal grommet count of two, or a CC grommet count of three or four.

	Options	Price	Required to Specify
Surface Materials	High-Pressure Laminate top		
	• High-Pressure Laminate price group 2	See information at left	Specify High-Pressure Laminate color number.
	• Open Line laminate (OLL)	+\$ 69 plus cost of laminate	▶ See <i>Surface Materials Reference Manual</i> .
	Wood top		
	• Wood group 1	Prices at right	Specify wood color number.
	• Wood group 2	Prices at right	Specify wood color number.
	• Wood group 3	Prices at right	Specify wood color number.
	• Customiz stain	Prices at right	Specify with <i>Customiz stain</i> .
	• Full-fill finish on wood group 1	Prices at right	▶ See <i>Surface Materials Reference Manual</i> . Specify full-fill finish number.
	Leg species		
• Maple	No cost	Specify maple finish number.	
• Oak	+\$150	Specify oak finish number.	
• Walnut	+\$200	Specify walnut finish number.	
Leg bracket			
• Paint price group 1	No cost	Specify paint color number.	
• Paint price group 2	+\$ 80	Specify paint color number.	
• Paint price group 3	+\$140	Specify paint color number.	
CC grommet			
• Paint price group 1	No cost	Specify paint color number.	
• Paint price group 2	+\$ 12	Specify paint color number.	
• Paint price group 3	+\$ 20	Specify paint color number.	
CC grommet lid			
• Paint price group 1	No cost	Specify paint color number.	
• Paint price group 2	+\$ 8	Specify paint color number.	
• Paint price group 3	+\$ 15	Specify paint color number.	
Shape Type, Softened	Modular	Parametric	
	• 72"W	• 72"W–83 ¹⁵ / ₁₆ "W	+\$350
	• 96"W	• 84"W–96"W	+\$550
			Specify with <i>softened shape type</i> . Specify with <i>softened shape type</i> .
Grain Direction	• Long grain	No cost	Specify with <i>long grain</i> .
	• No grain direction	No cost	Specify with <i>no grain direction</i> .
	• Short grain	No cost	Specify with <i>short grain</i> .
Grommet(s)	• No grommet	No cost	Specify with <i>no grommet</i> .
	• CC grommet		
	– One CC grommet	+\$150	Specify with <i>one CC grommet</i> .
	– Two CC grommets	+\$300	Specify with <i>two CC grommets</i> .
	– Three CC grommets	+\$450	Specify with <i>three CC grommets</i> .
	– Four CC grommets	+\$600	Specify with <i>four CC grommets</i> .
	• Long grommet		
	– One long grommet	+\$200	Specify with <i>one long grommet</i> .
	– Two long grommets	+\$400	Specify with <i>two long grommets</i> .
Surface Power	Available on tables with CC grommet(s) only		
	• Three power	+\$135	Specify with <i>three power</i> .
	• Two power, two USB type A	+\$250	Specify with <i>two power, two USB type A</i> .
	• One USB type C, two power	+\$350	Specify with <i>one USB type C, two power</i> .
	• One USB type C, two USB type A, one power	+\$400	Specify with <i>one USB type C, two USB type A, one power</i> .
Infeed	• Plug	No cost	Specify with <i>plug</i> .
	• Hardwire	+\$ 30	Specify with <i>hardwire</i> .
Cord Length	• 72"L	No cost	Specify with <i>72"L</i> .
	• 144"L	+\$ 75	Specify with <i>144"L</i> .

▶ **Specification Information, on next page**

Sightline Tables, continued

SIN 711.11

► Options, on previous page

Specification Information

• Style Number	• Dimensions				• Base Prices			• Options (Add \$ to Base Price)	
	• Depth		• Width		• Laminate Top	• Wood Group 1 Top	• Wood Top		Full-Fill Finish on Wood Group 1
	Modular Depth	Parametric Depth	Modular Width	Parametric Width			Wood Group 2	Wood Group 3	
VLYSTLWL	42"	42"-47 ¹⁵ / ₁₆ "	72"	72"-83 ¹⁵ / ₁₆ "	\$5425	\$5625	+\$165	+\$436	+\$71
	42"	42"-47 ¹⁵ / ₁₆ "	96"	84"-96"	\$5600	\$5950	+\$192	+\$546	+\$71
	48"	48"	72"	72"-83 ¹⁵ / ₁₆ "	\$5475	\$5675	+\$165	+\$436	+\$71
	48"	48"	96"	84"-96"	\$5650	\$6000	+\$192	+\$546	+\$71

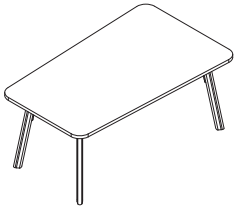

Tip: The smallest side on a sightline table is always 36"D, due to the taper.

SIN 711.11

Surface Materials

Surface Materials	154
Veneer Cut Guidelines	158
Color Availability Matrices	160
Walden Open Line Laminate Edge	167
Specification Guidelines for Vertical Fabric Applications	168

Surface Materials

This listing includes all the surface material choices that are available for the products in this specification guide.

Resources

For more information about surface materials, refer to the following resources:

Additional surface materials specification tools are available to assist you in the specification process—the Surface Materials Binders.

Surface Materials

Binders include:

- Surface Materials Reference Manual
- A complete set of swatch cards for hard surfaces, vertical surface fabrics, and seating upholstery

Wood

▶ See *Wood Color Availability Matrix* on page 160 for color availability by product line.

Steelcase carefully selects veneer and solid wood for consistent color and grain structure. Wood is a natural material and variations will occur in color, grain and texture. These variations are part of the inherent natural beauty of wood and are not considered defects.

Forest Stewardship Council (FSC) certified wood (veneer and core) is available on most Steelcase wood products through the Specials RFQ process.

All wood products will darken with age and exposure to ultraviolet light. This is especially apparent with cherry and maple veneer. We recommend that desk accessories be rearranged periodically to ensure even aging of wood surfaces.

When storing your wood furniture, please follow the following guidelines:

- Do not store products in trailers
- Store products in areas that simulate office temperatures (60°F to 90°F)
- Store products in areas that maintain constant, office-like humidity levels
- Keep product away from light. Cover products to make sure they are not exposed to light.

Steelcase Surfaces

Veneer

Veneers are matched for proper balance and consistency. Veneers are available or quarter cut, except for Oak, which is rift cut.

▶ Refer to the *Veneer Cut Guidelines* on page 158 for descriptions of each cut.

Open-pore finish is a medium gloss finish that leaves the wood grain texture visible to the eye and distinguishable to the touch.

▶ See *Surface Materials Reference Manual* for a listing of available veneers for Victor2.

Flat-cut open-pore finish choices

Wood Group 1

- 3062 FC/OP Graphite Walnut
- 3402 FC/OP Clear Cherry (Aged)
- 3412 FC/OP Natural Cherry
- 3422 FC/OP Medium Cherry
- 3522 FC/OP Clear Maple*
- 3572 FC/OP Amber on Maple
- 3592 FC/OP Blonde on Maple
- 3702 FC/OP Clear Walnut
- 3712 FC/OP Natural Walnut
- 3722 FC/OP Dark Mahogany on Walnut
- 3752 FC/OP Medium Walnut
- 3762 FC/OP Dark Walnut
- 3772 FC/OP Medium Mahogany on Walnut

Quarter-cut open-pore finish choices

Wood Group 1

- 3042 QC/OP Ash*
- 3222 QC/OP Clear Maple*
- 3272 QC/OP Amber on Maple
- 3292 QC/OP Blonde on Maple
- 3302 QC/OP Clear Walnut
- 3312 QC/OP Natural Walnut
- 3322 QC/OP Dark Mahogany on Walnut
- 3352 QC/OP Medium Walnut
- 3362 QC/OP Dark Walnut
- 3372 QC/OP Medium Mahogany on Walnut
- 3382 QC/OP Graphite Walnut

Rift-cut open-pore finish choices

Wood Group 1

- 3602 RC/OP Desert Oak
- 3612 RC/OP Warm Oak
- 3692 RC/OP Espresso Oak

Full-fill finish is a medium-gloss finish that completely fills the grain texture, yet allows the grain pattern to be seen. The wood has a lustrous, satiny look, and it is smooth to the touch. This finish is available on the wood worksurface or top only.

Tip: For ease of specification, full-fill finish codes can be selected on other veneer components being used in settings with full-fill veneer worksurfaces. The other components will not have the final fill coat applied, but the finish color will be consistent with the full-fill worksurfaces.

Flat-cut full-fill finish choices

Wood Group 1

- 3064 FC/FF Graphite Walnut
- 3404 FC/FF Clear Cherry (Aged)
- 3414 FC/FF Natural Cherry
- 3424 FC/FF Medium Cherry
- 3524 FC/FF Clear Maple*
- 3544 FC/FF Blonde on Maple
- 3574 FC/FF Amber on Maple
- 3704 FC/FF Clear Walnut
- 3714 FC/FF Natural Walnut
- 3724 FC/FF Dark Mahogany on Walnut
- 3754 FC/FF Medium Walnut
- 3764 FC/FF Dark Walnut
- 3774 FC/FF Medium Mahogany on Walnut

Quarter-cut full-fill finish choices

Wood Group 1

- 3224 QC/FF Clear Maple*
- 3274 QC/FF Amber on Maple
- 3294 QC/FF Blonde on Maple
- 3304 QC/FF Clear Walnut
- 3314 QC/FF Natural Walnut
- 3324 QC/FF Dark Mahogany on Walnut
- 3354 QC/FF Medium Walnut
- 3364 QC/FF Dark Walnut
- 3374 QC/FF Medium Mahogany on Walnut
- 3384 QC/FF Graphite Walnut

Rift-cut full-fill finish choices

Wood Group 1

- 3604 RC/FF Desert Oak
- 3614 RC/FF Warm Oak
- 3694 RC/FF Espresso Oak

**To ensure an understanding of the color ranges and characteristic variations of natural veneer, a sign-off sheet is required prior to orders being accepted for this clear-coat finish. The sign-off sheet is available through Steelcase advertising stock. Please use form number 09-0000756 for 3042, form number 05-0001370 for 3222 and 3224.*

Premium Veneers

A selection of Premium veneers in this collection are available on most Steelcase brand products. The collection will be available as close to standard leadtimes as possible. However, because adequate supplies of veneer and solids must be secured, all orders will be scheduled individually. Leadtimes will vary based on Premium veneer and Premium solids availability at the time the order is placed. The collection is Graded-In as Wood Group 2 and Wood Group 3, and supported like standard veneers to make ordering easy. Please see the Steelcase surface materials section on village.steelcase.com for sample information and product line availability. All premium veneers are in clear-coat.

Quarter-cut open-pore finish choices

Wood Group 2

- 3032 QC/OP Dark Thin Line Bamboo
- 3052 QC/OP Ribbon Sapele

Wood Group 3

- 3832 QC/OP Figured Anegre
- 3842 QC/OP Figured Makore

Tip: Full-fill finish is not available on premium veneers as a standard.

**To ensure an understanding of the color ranges and characteristic variations of natural veneer, a sign-off sheet is required prior to orders being accepted for this clear-coat finish. The sign-off sheet is available through Steelcase advertising stock. Please use form number 09-0000755 for 3032, form number 09-0000757 for 3052, form number 09-0000758 for 3832, and form number 09-0000759 for 3842.*

Select Surfaces

For information on products within Select Surfaces, including accent paints and fabrics from Designtex, Gabriel, Kvadrat, and Pollack, please refer to the *Surface Materials Reference Manual* or visit www.steelcase.com/surface-materials under the Select Surfaces section.

Composite Veneer

Composite veneers are an engineered wood intended to create specific grain patterns and characteristics. They are pre-stained and finished with Steelcase's Clarity water-borne UV topcoat, which protects the environment while providing durability and clarity. Only open-pore finishes are available on composite wood. Composite veneer and matching edge bands are available on most Steelcase brand products. Composites, for use as a solid nosing substitute, are not available. Steelcase does not recommend mixing composite veneers with natural solid nosings because composite and natural wood grain and color matching are rarely compatible. Composite veneers are Graded-In as Wood Group 1 pricing.

Note: Known for their color consistency, composite veneers feature a clear coat finish. Because the veneers are sourced in large lots, overall color within a specific purchase order should have minimal color inconsistency. However, composite customers should know that colors may vary slightly from dye lot to dye lot. This inconsistency may be noticed when replacement pieces are ordered that may be from different dye lots, or when a new project phase is installed. Also note that composite veneers tend to fade and lighten over time, especially with sun exposure.

Flat-cut open-pore finish choices

Wood Group 1

3JDX FC/OP Oak Composite
3JFX FC/OP Maple Composite
3JHX FC/OP Cherry Composite
3JXX FC/OP Walnut Composite

Quarter-cut open-pore finish choices

Wood Group 1

3F8X QC/OP European Walnut Composite
3GAX QC/OP Gold Teak Composite
3GFX QC/OP Rosewood Composite
3GGX QC/OP Zebrano Composite
3HGX QC/OP Oak Composite
3HVX QC/OP Walnut Composite
3JEX QC/OP Maple Composite
3JGX QC/OP Cherry Composite
3ZNX QC/OP Night Cerused Oak Composite

Tip: Be conscious if mixing the flat cut and the quarter cut in composites, there may be large variation in color.

Natural Veneer

Natural veneer is available in the Select Surfaces offering. Natural veneer may have extended lead-times. Place your order as you normally would for any other finish, calling out the appropriate finish code.

The following finishes are available through the natural veneer offering:

Flat-cut open-pore finish choices

Wood Group 1

3342 FC/OP Black Walnut
35A2 FC/OP Blanch Maple
37A2 FC/OP Thunder Walnut

Wood Group 3

3082 FC/OP Washed Walnut

Flat-cut full-fill finish choices

Wood Group 1

3734 FC/FF Black Walnut

Wood Group 3

3084 FC/FF Washed Walnut

Quarter-cut open-pore finish choices

Wood Group 1

32A2 QC/OP Blanch Maple
33A2 QC/OP Thunder Walnut
3392 QC/OP Black Walnut

Quarter-cut full-fill finish choices

Wood Group 1

3394 QC/FF Black Walnut

Rift-cut open-pore finish choices

Wood Group 1

36A2 RC/OP Volcanic Oak

Planked Veneer

Planked veneer is available in the Select Surfaces offering. Planked veneer may have extended lead-times. Place your order as you normally would for any other finish, calling out the appropriate finish code.

The following finishes are available through the planked veneer offering:

Wood Group 1

3P41 OP Planked Cherry
3P51 OP Planked Maple
3P61 OP Planked Oak
3P71 OP Planked Walnut

Tip: Known for its uniqueness, planked veneer has intentional and natural variations that include, but are not limited to: character marks, grain pattern, color, and natural color aging.

Custom Surfaces

Customiz stain is a service that allows you to create your own stain colors and finishes on standard veneer. Customiz stain color is available on all product lines that offer wood veneer.

A \$500 stain-matching fee applies on CUSTOMIZ requests (Exception: The \$500 fee does not apply on matches to Coalesse standard finishes or for a low-gloss finish request on a standard color). The \$500 fee covers the cost of formulating the Customiz color finish and applies regardless of whether or not an order for product is placed.

In addition, an approval form must be signed to indicate customer acceptance of Customiz match. A \$1,500 initiation fee will be charged prior to first order entry. This initiation fee activates the finish for unlimited use on any Steelcase product for an 18 month time period. After the 18 month time period has lapsed, the Customiz finish may be reactivated for another 18 months for a \$1,000 fee at any point within five years after the \$1,500 initiation fee was paid. If the finish is not reactivated within five years after the \$1,500 initiation fee was paid, the finish will be culled and the customer will need to pay the \$1,500 initiation fee again. All style number related Customiz charges products are no cost as of April 2014. The matching and initiation fees are not discountable.

Customiz stain takes 10 days to formulate. Consult the *Surface Materials Reference Manual* for more information. Custom veneers are also available and must be quoted by Steelcase specials group. Customiz stain on custom veneers takes 2 to 4 weeks to formulate.

Requirements and information on ordering a Customiz stain color are found in the *Surface Materials Reference Manual*.

Laminate

▶ See *Surface Materials Reference Manual* for a listing of available laminates for Victor2.

▶ See *Laminate Color Availability Matrix* on page 162 for color availability by product line.

Steelcase Surfaces

Applies to:

- Verlay tables

Tip: Low-Pressure Laminates are not available for Verlay.

High-Pressure Laminate

Price Group 1

Fiber Laminate

2850 Vanadium Fiber
2851 Rhyme Fiber
2852 Tungsten Fiber
2854 Vellum Fiber
2859 Novell Fiber
2860 Granite Fiber
2861 Coconut Fiber
2862 Stucco Fiber

Metallic Laminate

2503 Brushed Silver

Micro Laminate

2920 Marl Micro
2921 Gypsum Micro
2922 Clay Micro
2923 Shadow Micro

Patina Laminate

2870 Blonde Bronze Patina
2871 Blackened Bronze Patina
2873 Instant Iron Patina

Surface Materials, continued

Solid Laminate

- 2722 Cream
- 2730 Arctic White
- 2746 Black
- 2759 Warm White
- 2811 Mist
- 2883 Seagull
- 2884 Milk
- 2885 Dune
- 2HMG Merle

Speckle Laminate

- 2820 Coffee Speckle
 - 2822 Woodrose Speckle
 - 2823 Driftwood Speckle
 - 2824 Smoke Speckle
 - 2825 Vanadium Speckle
- Tip: Some wood veneer finishes and woodgrain laminates share the same name. Because of the difference in materials, veneers and laminates of the same name are not an exact match but do coordinate with each other.*

* 2503 Brushed Silver does not apply to Verlay.

Woodgrain Laminate

- 2406 Clear Cherry
 - 2409 Clear Maple
 - 2410 Graphite Walnut*
 - 2412 Natural Cherry
 - 2422 Medium Cherry
 - 2511 Winter on Maple
 - 2538 Clear Walnut
 - 2539 Warm Oak
 - 2592 Blonde on Maple
 - 2714 Natural Walnut
 - 2772 Medium Mahogany on Walnut
 - 2HAK Clear Oak
 - 2HAT Acacia
 - 2HAN Ash Noce
 - 2HAW Ash Wenge
 - 2HBN Bisque Noce
 - 2HBW Bisque Wenge
 - 2HCN Clay Noce
 - 2HCW Clay Wenge
 - 2HSN Storm Noce
 - 2HSW Storm Wenge
- * When blending laminate and veneer on the same unit, the Graphite Walnut laminate is Quarter Cut and matches Quarter Cut Graphite Walnut veneer.

Turnstone Laminate Collection

A selection of laminates and edge bands in this collection are available on Steelcase brand products. This collection is available with standard leadtimes and supported like standard laminates to help make ordering easy. Please see the turnstone section of village.steelcase.com for swatching information

- 2535 Virginia Walnut
- 2536 Blackwood
- 2612 Marble Maple
- 2614 Chocolate Walnut
- 2615 Marble Cherry

Select Surfaces

High-Pressure Laminate

Price Group 1

Textured Woodgrain Laminate

- 2TH2 Fawn Cypress
- 2TH3 Weathered Char
- 2TH4 Saddle Oak
- 2TH5 Veranda Teak
- 2TH6 Persian Cherry
- 2TH7 Walnut Heights

Price Group 2

Textured Industrial Laminate

- 2UH1 Reclaimed Aggregate
- 2UH2 Reclaimed Gravel
- 2UH4 Cement
- 2UH6 Sheetrock

Steelcase Surfaces

Low-Pressure Laminate

Fiber Laminate

- 2L50 Vanadium Fiber LPL
- 2L52 Tungsten Fiber LPL

Metallic Laminate

- 2L03 Brushed Silver LPL

Solid Laminate

- 247L Black V2 LPL
- 275L Warm White LPL
- 2L30 Arctic White LPL
- 2L83 Seagull LPL
- 2L84 Milk LPL
- 2L85 Dune LPL
- 2LMG Merle LPL

Woodgrain Laminate

- 246L Mahogany LPL
- 25L1 Winter on Maple LPL
- 25L5 Virginia Walnut LPL
- 25L6 Blackwood LPL
- 25L8 Clear Walnut LPL
- 25L9 Warm Oak LPL
- 262L Marbled Maple LPL
- 264L Chocolate Walnut LPL
- 265L Marbled Maple LPL
- 267L Marbled Cherry V2 LPL
- 26L1 Natural Cherry V2 LPL
- 2L09 Clear Maple LPL
- 2LAK Clear Oak LPL
- 2LAN Ash Noce LPL
- 2LAT Acacia LPL
- 2LAW Ash Wenge LPL
- 2LBN Bisque Noce LPL
- 2LBW Bisque Wenge LPL
- 2LCN Clay Noce LPL
- 2LCW Clay Wenge LPL
- 2LSN Storm Noce LPL
- 2LSW Storm Wenge LPL

Custom Surfaces

Open Line Laminate (OLL)

This service allows you to order non-standard laminate at an additional processing fee of \$67 per unit, plus the cost of the laminate.

High-Pressure Laminate pricing does not include premium or digitally printed patterns from any suppliers. Laminate cost may also vary for basic or standard laminates from other suppliers. Please contact the OLL consultant at 616.475.2426 for pricing. The cost of the laminate will be added to your invoice as a separate line on the acknowledgement.

When processing orders for Open Line laminate, specify 2900 in the laminate finish field and enter the OLL manufacturer information. Specify appropriate 2K finish number for the edge finish.

Laminate Approval and Material Requirements

To confirm whether a particular laminate has already been tested for use on a specific Steelcase product or to determine material square foot requirements:

- Visit www.steelcase.com

For additional information, refer to the *Steelcase Surface Materials Reference Manual*.

Paint

► See *Surface Materials Reference Manual* for a listing of available paints for Victor2.

Steelcase Surfaces

Applies to:

- Lighting
- Verlay tables

Price Group 1

Smooth Paint

- 4242 Milk

Textured Paint

- 7207 Black
- 7225 Sand
- 7236 Fog
- 7237 Slate
- 7238 Fieldstone
- 7241 Arctic White
- 7243 Seagull
- 7278 Dark Bronze
- 7360 Merle

Price Group 2

Smooth Metallic Paint

- 4728 Nickel Metallic
- 4743 Mineral Metallic
- 4744 Pearl Metallic
- 4750 Champagne Metallic
- 4752 Steel Metallic
- 4788 Gold Dust Metallic
- 4798 Sterling Metallic
- 4799 Platinum Metallic

Textured Metallic Paint

- 7245 Carbon Metallic
- 7246 Midnight Metallic

Applies to:

- 2 1/2" round grommet

Price Group 1

Smooth Paint

- 7241 Arctic White
- 7278 Dark Bronze

Price Group 2

Standard Paint

- 0835 Black

Smooth Metallic Paint

- 4799 Platinum Metallic

Select Surfaces

Price Group 3

Accent paint

Accent paints allow you to choose from a pre-matched color palette of trend driven colors. Refer to the *Surface Materials Reference Manual* for more information.

Plastic

Steelcase Surfaces

Applies to:

- Verlay tables

- 6000 Black
- 6001 Coffee
- 6009 Arctic White
- 6034 Natural Cherry
- 6036 Medium Cherry
- 6037 Winter on Maple
- 6038 Blonde on Maple
- 6041 Natural Walnut
- 6045 Medium Mahogany on Walnut

- 6052 Milk
- 6053 Seagull
- 6213 Acacia
- 6219 Clear Oak
- 6231 Graphite Walnut*
- 6234 Clear Cherry
- 6237 Clear Maple*
- 6242 Virginia Walnut
- 6243 Blackwood
- 6245 Clear Walnut
- 6246 Warm Oak
- 6249 Platinum Solid
- 6271 Plywood
- 6527 Merle
- 6615 Grey V5
- 6619 Ice
- 6631 Cream
- 6635 Dawn
- 6636 Mist
- 6654 Sand
- 6655 Warm White
- 6676 Marbled Maple
- 6677 Chocolate Walnut
- 6678 Marbled Cherry
- 6689 Brushed Silver
- 6694 Slate
- 6695 Midnight
- 6697 Fog
- 6698 Fieldstone
- 6703 Ash Wenge
- 6704 Storm Wenge
- 6705 Bisque Wenge
- 6706 Clay Wenge
- 6707 Ash Noce
- 6708 Bisque Noce
- 6709 Clay Noce
- 6710 Storm Noce

- * Not available on Low-Pressure Laminate

Select Surfaces

Applies to:

- Verlay tables
- 6T02 Fawn Cypress
- 6T03 Weathered Char
- 6T04 Saddle Oak
- 6T05 Veranda Teak
- 6T06 Persian Cherry
- 6T07 Walnut Heights
- 6T08 Aggregate
- 6T09 Gravel
- 6T10 Cement
- 6T12 Sheetrock

Custom Surfaces**Price Group 3****PerfectMatch**

PerfectMatch is a service that allows you to create your own paint color. Refer to the *Surface Materials Reference Manual* for more information about this program.

Plated Metal**Steelcase Surfaces**

► See *Plated and Painted Metal Color Availability Matrix* on page 166 for color availability by product line.

8042	Brushed Aluminum
8046	Polished Aluminum
9201	Polished Chrome
9211	Nickel
9212	Silver
9214	Antique Pewter
9230	Antique Bronze
9250	Ember Chrome

Applies to:

- 2½" round grommet
- | | |
|------|-----------------|
| 9201 | Polished Chrome |
| 9211 | Nickel |

Solid Surface**Steelcase Surfaces**

Applies to:

- Technology cover for Convene

Dupont Corian

2970	Cameo White
2971	Nocturne Black

Vertical Surface Fabric**Steelcase Surfaces****Price Group 1****Abacus**

P122	Entasis
P123	Portico
P124	Opus
P125	Cusp
P126	Artifact
P129	Atlas

Alloy

P525	Polar
P526	Skim
P527	Bubbly
P528	Tern
P529	Shore
P530	Asti
P531	Silver
P532	Oxide
P533	Element
P534	Construct
P535	Currency
P536	Iron

Boccie

P200	New Rice
P201	New Almond
P202	New Nutmeg
P203	New Camel
P204	New Opal
P205	New Mist
P206	New Plum
P207	New Lichen
P208	New Spearmint
P209	New Sky

Buzz2

5F03	Tomato
5F04	Red
5F05	Burgundy
5F06	Sky
5F07	Blue
5F08	Navy
5F10	Grape
5F11	Eggplant
5F15	Stone
5F16	Grey
5F17	Black
5G50	Dunegrass
5G51	Sable
5G52	Barley
5G53	Sunrise
5G54	Carrot
5G55	Pumpkin
5G56	Timber
5G57	Rouge
5G58	Chocolate
5G59	Meadow
5G60	Ivy
5G61	Cyan
5G62	Atlantic
5G63	Crocus
5G64	Alpine
5G65	Tornado

Charm

P505	Shell
P506	Mimosa
P507	Birch
P508	Sparkle
P509	Ginkgo
P510	Debut
P511	Clover
P512	Spicy
P513	Twilight

Lapel

P409	Cement
P410	Pebble
P411	Beech
P412	Dune
P413	Grain
P414	Sprout
P415	Misty Blue
P416	Maple
P417	Slate

Optic

P540	Hazel
P541	Twinkle
P542	Orion
P543	Seaglass
P544	Shine
P545	Halo
P546	Whiskey
P547	Bath
P548	Whisper
P549	Breezy
P550	Wry
P551	Glimmer

Pianista

P420	Sand
P421	Mist
P422	Rain
P423	Natural
P424	Flax
P425	Denim
P426	Carbon
P427	Stone
P428	Flax
P429	Oat
P430	Wheat
P431	Maize

Rhythm

P555	Allegro
P556	Tempo
P557	Refrain
P558	Pitch
P559	Harmony
P560	Melody
P561	Stanza
P562	Opus

Tinsel

P516	Lit
P517	Ego
P518	Fizz
P519	Muse
P520	Depth
P521	Bliss
P522	Grow
P523	Dolce

Price Group 2**Bariolage**

G200	New Etude
G201	New Andante
G202	New Cantata
G203	New Adagio
G204	New Melody
G205	New Ballata
G206	New Sonata

Bouquet

P165	Hosta
P166	Dundee
P169	Argenta
P170	Hoya
P173	Camomile

Code

5FA1	Fossil
5FA2	Gabbro
5FA3	Reed
5FA4	Bluff
5FA5	Sea Salt
5FA6	Cannon
5FA7	Tussah
5FA8	Mica
5FA9	Ecru
5FB1	Bamboo

Flip: Orbit

5F85	Mud Pie
5F86	Hummus
5F87	Petoskey
5F88	Pluto
5F89	Papyrus
5F91	Blizzard
5F92	Briquette

Flip: TexHex

5F75	Mud Pie
5F76	Hummus
5F77	Petoskey
5F78	Pluto
5F79	Papyrus
5F97	Blizzard
5F98	Briquette

Fresco

G001	Sandrift
G002	Mistiblu
G003	Faon
G006	Chamoline
G007	Grapenut
G017	Flint

Latch

P600	Seashell
P601	Clam
P602	Eggshell
P603	Zen
P604	Cool Gray
P605	Armor
P606	Sentinel
P607	Rye
P608	Billow
P609	Nimbus

Milano

N002	Delft
N003	Woodland
N004	Sunshadow
N005	Olivine
N012	Teakwood

Price Group 3

Billiard Multi-Use by Designtex

Select Surfaces

For information on products within Select Surfaces, including accent paints and fabrics from Designtex, Gabriel, Kvadrat, and Pollack, please refer to the *Surface Materials Reference Manual* or visit www.steelcase.com/surface-materials under the Select Surfaces section.

Custom Surfaces**Price Group COM (Customer's Own Material)****Fabric Approval and Yardage**

To confirm whether a particular COM material has already been tested for use on a specific Steelcase product or to determine actual yardage requirements:

- Visit www.steelcase.com

For additional information regarding Customer's Own Material

call 1.888.STEELCASE (1.888.783.3522) or send an e-mail to lineone@steelcase.com.

Veneer Cut Guidelines

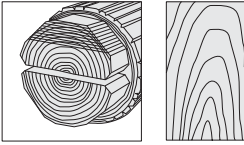

Flat Cut

Veneer is cut parallel to the flat side of the cant at a tangent to the growth rings of the tree. This produces a cathedral or oval pattern. On average, there is a 6-8" wide leaf width. On an 18" wide surface, there will likely be three leaves showing a repeated pattern.

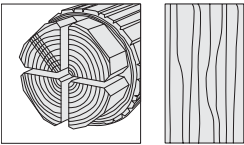

Quarter Cut

Veneer is cut from quarter sections of the log which are produced by cutting each cant in half. Cutting lines are at an angle of approximately 90 degrees to the growth rings at the center of the quarter. This produces a straight grain or ribbon pattern. On average, leaves are 2½-4" wide.

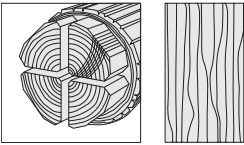

Rift Cut

This veneer cut is specifically for oak. Cutting lines are an arc approximately perpendicular to the growth rings. This produces a comb-like straight grain or ribbon pattern. On average, leaves are 2½-4" wide.

Color Availability Matrices

Wood

Legend

- = Not available
- = Available
- = Available with exceptions

Flat Cut

Cherry

	Fill Level	Walden	Convane	Verlay
3402 FC/OP Clear Cherry (Aged)	OP	■	■	■
3404 FC/FF Clear Cherry (Aged)	FF	□	□	■
3412 FC/OP Natural Cherry	OP	■	■	■
3414 FC/FF Natural Cherry	FF	□	□	■
3422 FC/OP Medium Cherry	OP	■	■	■
3424 FC/FF Medium Cherry	FF	□	□	■

Maple

3522 FC/OP Clear Maple*	OP	■	■	■
3524 FC/FF Clear Maple*	FF	□	□	■
3544 FC/FF Blonde on Maple	FF	□	□	■
3572 FC/OP Amber on Maple	OP	■	■	■
3574 FC/FF Amber on Maple	FF	□	□	■
3592 FC/OP Blonde on Maple	OP	■	■	■

Walnut

3062 FC/OP Graphite Walnut	OP	■	■	■
3064 FC/FF Graphite Walnut	FF	□	□	■
3702 FC/OP Clear Walnut	OP	■	■	■
3704 FC/FF Clear Walnut	FF	□	□	■
3712 FC/OP Natural Walnut	OP	■	■	■
3714 FC/FF Natural Walnut	FF	□	□	■
3722 FC/OP Dark Mahogany on Walnut	OP	■	■	■
3724 FC/FF Dark Mahogany on Walnut	FF	□	□	■
3752 FC/OP Medium Walnut	OP	■	■	■
3754 FC/FF Medium Walnut	FF	□	□	■
3762 FC/OP Dark Walnut	OP	■	■	■
3764 FC/FF Dark Walnut	FF	□	□	■
3772 FC/OP Medium Mahogany on Walnut	OP	■	■	■
3774 FC/FF Medium Mahogany on Walnut	FF	□	□	■

Quarter Cut

Ash

3042 QC/OP Ash*	OP	■	■	■
-----------------	----	---	---	---

Maple

3222 QC/OP Clear Maple*	OP	■	■	■
3224 QC/FF Clear Maple*	FF	□	□	■
3272 QC/OP Amber on Maple	OP	■	■	■
3274 QC/FF Amber on Maple	FF	□	□	■
3292 QC/OP Blonde on Maple	OP	■	■	■
3294 QC/FF Blonde on Maple	FF	□	□	■

Available wood color choices are indicated in this matrix for each Steelcase Wood Furniture product.
 ▶ Refer to page 158 for the Veneer Cut Guidelines.

Quarter Cut, continued

Walnut

	Fill Level	Walden	Convane	Verlay
3302 QC/OP Clear Walnut	OP	■	■	■
3304 QC/FF Clear Walnut	FF	□	□	■
3312 QC/OP Natural Walnut	OP	■	■	■
3314 QC/FF Natural Walnut	FF	□	□	■
3322 QC/OP Dark Mahogany on Walnut	OP	■	■	■
3324 QC/FF Dark Mahogany on Walnut	FF	□	□	■
3352 QC/OP Medium Walnut	OP	■	■	■
3354 QC/FF Medium Walnut	FF	□	□	■
3362 QC/OP Dark Walnut	OP	■	■	■
3364 QC/FF Dark Walnut	FF	□	□	■
3372 QC/OP Medium Mahogany on Walnut	OP	■	■	■
3374 QC/FF Medium Mahogany on Walnut	FF	□	□	■
3382 QC/OP Graphite Walnut	OP	■	■	■
3384 QC/FF Graphite Walnut	FF	□	□	■

Rift Cut

Oak

3602 RC/OP Desert Oak	OP	■	■	■
3604 RC/FF Desert Oak	FF	□	□	■
3612 RC/OP Warm Oak	OP	■	■	■
3614 RC/FF Warm Oak	FF	□	□	■
3692 RC/OP Espresso Oak	OP	■	■	■
3694 RC/FF Espresso Oak	FF	□	□	■

Premium Wood*

Wood Group 2

3032 QC/OP Dark Thin Line Bamboo	OP	■	■	■
3052 QC/OP Ribbon Sapele	OP	■	■	■

Wood Group 3

3832 QC/OP Figured Anegre	OP	■	■	■
3842 QC/OP Figured Makore	OP	■	■	■

▶ Continued on next page

Fill Level Key

- FF = Full-fill
- OP = Open-pore
- FC = Full-cut
- QC = Quarter-cut
- RC = Rift-cut
- ▶ For a description of fill level, see *Surface Materials Reference Manual*.

* To ensure an understanding of the color ranges and characteristic variations of natural veneer, a sign-off sheet is required prior to orders being accepted for this clear-coat finish. The sign-off sheet is available through Steelcase advertising stock. Form number 05-0001370.

Wood, continued from previous page

Available wood color choices are indicated in this matrix for each Steelcase Wood Furniture product.

	Fill Level	Walden	Convane	Verlay
--	------------	--------	---------	--------

Select Surfaces—Composite Veneers**

Wood Group 1

3F8X QC/OP European Walnut Composite	OP	□	•	■
3HGX QC/OP Oak Composite	OP	•	•	•
3HVX QC/OP Walnut Composite	FF	•	•	•
3JDX FC/OP Oak Composite	OP	•	•	•
3JEX QC/OP Maple Composite	FF	•	•	•
3JFX FC/OP Maple Composite	OP	•	•	•
3JGX QC/OP Cherry Composite	FF	•	•	•
3JHX FC/OP Cherry Composite	OP	•	•	•
3JJX FC/OP Walnut Composite	FF	•	•	•
3ZNX QC/OP Night Cerused Oak Composite	OP	•	•	■

Select Surfaces—Natural Veneer

Wood Group 1

32A2 QC/OP Blanch Maple	OP	■	■	■
33A2 QC/OP Thunder Walnut	OP	■	■	■
3342 FC/OP Black Walnut	OP	■	■	■
3392 QC/OP Black Walnut	OP	■	■	■
3394 QC/FF Black Walnut	OP	■	■	■
35A2 FC/OP Blanch Maple	OP	■	■	■
36A2 RC/OP Volcanic Oak	OP	■	■	■
37A2 FC/OP Thunder Walnut	OP	■	■	■
3734 FC/FF Black Walnut	OP	■	■	■

Wood Group 3

3082 FC/OP Washed Walnut	OP	■	■	■
3084 FC/FF Washed Walnut	OP	■	■	■

Select Surfaces—Planked Veneer

Wood Group 1

3P41 Planked Cherry	OP	□	■	•
3P51 Planked Maple	OP	□	■	■
3P61 Planked Oak	OP	□	■	■
3P71 Planked Walnut	OP	□	■	■

Legend

- = Not available
- = Available
- = Available with exceptions

Fill Level Key

- FF = Full-fill
- OP = Open-pore
- FC = Full-cut
- QC = Quarter-cut
- RC = Rift-cut
- ▶ For a description of fill level, see *Surface Materials Reference Manual*.

Note: Full-fill finish is not available on Premium veneers as a standard.

**To ensure an understanding of the color ranges and characteristics of composite veneer, a sign-off sheet is required prior to orders being accepted for composite projects. Please consult the surface materials reference manual or the composite sign-off sheet available through Steelcase advertising stock. Form number 14-0000141. ▶ Refer to page 158 for the Veneer Cut Guidelines.

Color Availability Matrices, continued

Laminate

Available laminate color choices are indicated in this matrix for each Steelcase Wood Furniture product.

Legend

- = Not available
- = Available
- = Available with exceptions

	Steelcase Wood Furniture								
	Convane	Currency	Elective Elements	FlexFrame	Mackinac	Payback	Verlay	Victor2	Walden
High-Pressure Laminates (HPL) Price Group 1									
Fiber Laminates									
2850 Vanadium Fiber	■	□	■	■	■	•	■	■	•
2851 Rhyme Fiber	■	□	■	■	■	•	■	■	•
2852 Tungsten Fiber	■	□	■	■	■	•	■	■	•
2854 Vellum Fiber	■	□	■	■	■	•	■	■	•
2859 Novell Fiber	■	□	■	■	■	•	■	■	•
2860 Granite Fiber	■	□	■	■	■	•	■	■	•
2861 Coconut Fiber	■	□	■	■	■	•	■	■	•
2862 Stucco Fiber	■	□	■	■	■	•	■	■	•
Metallic Laminate									
2503 Brushed Silver	•	□	•	•	•	•	•	•	•
Micro Laminates									
2920 Marl Micro	■	□	■	■	■	•	■	■	•
2921 Gypsum Micro	■	□	■	■	■	•	■	■	•
2922 Clay Micro	■	□	■	■	■	•	■	■	•
2923 Shadow Micro	■	□	■	■	■	•	■	■	•
Patina Laminates									
2870 Blonde Bronze Patina	■	□	■	■	■	•	■	■	•
2871 Blackened Bronze Patina	■	□	■	■	■	•	■	■	•
2873 Instant Iron Patina	■	□	■	■	■	•	■	■	•
Solid Laminates									
2722 Cream	■	□	■	■	■	•	■	■	■
2730 Arctic White	■	□	■	■	■	•	■	■	■
2746 Black	■	□	■	■	■	•	■	■	■
2759 Warm White	■	□	■	■	■	•	■	■	■
2811 Mist	■	□	■	■	■	•	■	■	■
2883 Seagull	■	□	■	■	■	•	■	■	■
2884 Milk	■	□	■	■	■	•	■	■	■
2885 Dune	■	□	■	■	■	•	■	■	■
2HMG Merle	•	□	■	■	■	•	■	■	■

▶ Continued on next page

Laminate, continued from previous page

Available laminate color choices are indicated in this matrix for each Steelcase Wood Furniture product.

Legend

- = Not available
- = Available
- = Available with exceptions

	Steelcase Wood Furniture									
	Convane	Currency	Elective Elements	FlexFrame	Mackinac	Payback	Verlay	Victor2	Walden	
High-Pressure Laminates (HPL) Price Group 1										
Speckle Laminates										
2820 Coffee Speckle	■	□	■	■	■	•	■	■	•	
2822 Woodrose Speckle	■	□	■	■	■	•	■	■	•	
2823 Driftwood Speckle	■	□	■	■	■	•	■	■	•	
2824 Smoke Speckle	■	□	■	■	■	•	■	■	•	
2825 Vanadium Speckle	■	□	■	■	■	•	■	■	•	
Woodgrain Laminates										
2406 Clear Cherry	■	□	■	■	■	•	■	■	■	
2409 Clear Maple	■	□	■	■	■	•	■	■	■	
2410 Graphite Walnut	■	□	■	■	■	•	■	■	■	
2412 Natural Cherry	■	□	■	■	■	•	■	■	■	
2422 Medium Cherry	■	□	■	■	■	•	■	■	■	
2511 Winter on Maple	■	□	■	■	■	•	■	■	■	
2538 Clear Walnut	■	□	■	■	■	•	■	■	■	
2539 Warm Oak	■	□	■	■	■	•	■	■	■	
2592 Blonde on Maple	■	□	■	■	■	•	■	■	■	
2714 Natural Walnut	■	□	■	■	■	•	■	■	■	
2772 Med Mahogany on Walnut	■	□	■	■	■	•	■	■	■	
2HAK Clear Oak	■	□	■	■	■	•	■	■	■	
2HAN Ash Noce	■	□	■	■	■	•	■	■	■	
2HAT Acacia	■	□	■	■	■	•	■	■	■	
2HAW Ash Wenge	■	□	■	■	■	•	■	■	■	
2HBN Bisque Noce	■	□	■	■	■	•	■	■	■	
2HBW Bisque Wenge	■	□	■	■	■	•	■	■	■	
2HCN Clay Noce	■	□	■	■	■	•	■	■	■	
2HCW Clay Wenge	■	□	■	■	■	•	■	■	■	
2HSN Storm Noce	■	□	■	■	■	•	■	■	■	
2HSW Storm Wenge	■	□	■	■	■	•	■	■	■	

Color Availability Matrices, continued

Laminate, continued from previous page

Available laminate color choices are indicated in this matrix for each Steelcase Wood Furniture product.

Legend

- = Not available
- = Available
- = Available with exceptions

	Steelcase Wood Furniture									
	Convane	Currency	Elective Elements	FlexFrame	Mackinac	Payback	Verlay	Victor2	Walden	
Select Surfaces - Textured Laminate (HPL) Price Group 2										
2TH2 Fawn Cypress	■	□	■	■	■	•	■	■	■	
2TH3 Weathered Char	■	□	■	■	■	•	■	■	■	
2TH4 Saddle Oak	■	□	■	■	■	•	■	■	■	
2TH5 Veranda Teak	■	□	■	■	■	•	■	■	■	
2TH6 Persian Cherry	■	□	■	■	■	•	■	■	■	
2TH7 Walnut Heights	■	□	■	■	■	•	■	■	■	
2UH1 Reclaimed Aggregate	■	□	■	■	■	•	■	■	■	
2UH2 Reclaimed Gravel	■	□	■	■	■	•	■	■	■	
2UH4 Cement	□	□	□	■	■	•	■	■	■	
2UH6 Sheetrock	■	□	■	■	■	•	■	■	■	
turnstone Laminate Collection (HPL) Price Group 1										
2535 Virginia Walnut	•	□	■	□	■	•	■	■	•	
2536 Blackwood	•	□	■	□	■	•	■	■	•	
2612 Marbled Maple	•	□	■	□	■	•	■	■	•	
2614 Chocolate Walnut	•	□	□	□	■	•	■	■	•	
2615 Marbled Cherry	•	□	■	□	■	•	■	■	•	
Low-Pressure Laminates (LPL)										
Fiber Laminates										
2L50 Vanadium Fiber LPL	•	■	•	■	•	•	•	•	•	
2L52 Tungsten Fiber LPL	•	■	•	■	•	•	•	•	•	
Metallic Laminate										
2L03 Brushed Silver LPL	•	■	•	■	•	•	•	•	•	
Solid Laminates										
247L Black Version 2 LPL	•	■	•	■	•	■	•	•	•	
275L Warm White LPL	•	•	•	■	•	■	•	•	•	
2L30 Arctic White LPL	•	■	•	■	•	■	•	•	•	
2L83 Seagull LPL	•	■	•	■	•	■	•	•	•	
2L84 Milk LPL	•	■	•	■	•	■	•	•	•	
2L85 Dune LPL	•	■	•	■	•	■	•	•	•	
2LMG Merle LPL	•	■	•	■	•	■	•	•	•	

Laminate, continued from previous page

Available laminate color choices are indicated in this matrix for each Steelcase Wood Furniture product.

Legend

- = Not available
- = Available
- = Available with exceptions

	Steelcase Wood Furniture								
	Convete	Currency	Elective Elements	FlexFrame	Mackinac	Payback	Verlay	Victor2	Walden
Low-Pressure Laminates (LPL)									
Woodgrain Laminates									
24L0 Graphite Walnut LPL	•	■	•	■	•	■	•	•	•
25L1 Winter on Maple LPL	•	■	•	■	•	■	•	•	•
25L5 Virginia Walnut LPL	•	■	•	■	•	■	•	•	•
25L6 Blackwood LPL	•	■	•	■	•	■	•	•	•
25L8 Clear Walnut LPL	•	■	•	■	•	■	•	•	•
25L9 Warm Oak LPL	•	■	•	■	•	■	•	•	•
26L1 Natural Cherry Version 2 LPL	•	■	•	■	•	■	•	•	•
246L Mahogany LPL	•	•	•	•	•	■	•	•	•
262L Marbled Maple LPL	•	■	•	■	•	■	•	•	•
264L Chocolate Walnut LPL	•	■	•	■	•	■	•	•	•
265L Marbled Cherry LPL	•	•	•	•	•	■	•	•	•
267L Marbled Cherry Version 2 LPL	•	■	•	■	•	•	•	•	•
2L09 Clear Maple LPL	•	■	•	■	•	■	•	•	•
2LAK Clear Oak LPL	•	■	•	■	•	■	•	•	•
2LAN Ash Noce LPL	•	■	•	■	•	■	•	•	•
2LAT Acacia LPL	•	■	•	■	•	■	•	•	•
2LAW Ash Wenge LPL	•	■	•	■	•	■	•	•	•
2LBN Bisque Noce LPL	•	■	•	■	•	■	•	•	•
2LBW Bisque Wenge LPL	•	■	•	■	•	■	•	•	•
2LCN Clay Noce LPL	•	■	•	■	•	■	•	•	•
2LCW Clay Wenge LPL	•	■	•	■	•	■	•	•	•
2LSN Storm Noce LPL	•	■	•	■	•	■	•	•	•
2LSW Storm Wenge LPL	•	■	•	■	•	■	•	•	•
Open Line Laminate (Upcharge)									
Open Line Laminate	□	■	■	■	■	•	■	■	■

Color Availability Matrices, continued

Plated and Painted Metal

Not every plated metal color is available on every metal component for every product line. This matrix gives you an overview of which plated metal colors are available on each product line and component.

Legend

- = Not available
- = Available
- = Available with exceptions

		0835 Black	4728 Nickel Metallic	4750 Champagne Metallic	4798 Sterling Metallic	4799 Platinum Metallic	7207 Black Textured	7225 Sand	7241 Arctic White	7243 Seagull	7246 Midnight Metallic	7360 Merle	8042 Brushed Aluminum	8043 Anodized Aluminum	8046 Polished Aluminum	9201 Polished Chrome	9211 Nickel	9212 Silver	9214 Antique Pewter	9230 Antique Bronze	9250 Ember Chrome
Convene	Pulls	■	•	•	•	■	•	•	•	•	•	•	•	•	•	•	■	■	•	•	•
	Locks	•	•	•	•	•	•	•	•	•	•	•	•	•	•	•	■	•	•	•	■
	Base toe kicks	■	•	•	•	•	•	•	•	•	•	•	•	■	•	■	•	•	•	•	•
	Square and cylinder feet	■	•	•	•	■	•	•	•	•	•	•	•	■	•	•	•	•	•	•	•
	Flex base	■	•	•	•	■	•	•	•	•	•	•	•	■	•	•	•	•	•	•	•
	Grommets	■	•	•	•	■	•	•	•	•	•	•	•	•	•	•	■	■	•	•	•
	Power unit and power channel sleeves	■	•	•	•	■	•	•	•	•	•	•	•	•	•	•	•	•	•	•	•
Walden	Pulls	■	•	•	•	■	•	•	•	•	•	•	•	•	•	•	•	•	•	•	•
	Grommets	■	•	•	•	■	•	•	•	•	•	•	•	•	•	•	•	•	•	•	•
	Power unit	■	•	•	•	■	•	•	•	•	•	•	•	•	•	•	•	•	•	•	•
	Columns	•	•	•	•	■	■	•	•	•	•	•	•	•	•	•	•	•	•	•	•
	Leg	•	•	•	•	■	■	•	•	•	•	•	•	•	•	•	•	•	•	•	•
	Modesty panel brackets	■	•	•	•	■	•	•	•	•	•	•	•	•	•	•	•	•	•	•	•

Walden Open Line Laminate Edge

Coordination Matrix for Plastic Edges

The colors of the plastic edges

are determined by the 2K finish number selected.

2K Number Selection	Plastic Edge Color
2K00	6619 Ice
2K01	6245 Clear Walnut
2K03	6246 Warm Oak
2K04	6234 Clear Cherry
2K10	6041 Natural Walnut
2K15	6615 Grey V5
2K21	6036 Medium Cherry
2K22	6631 Cream
2K27	6034 Natural Cherry
2K28	Vellum Fiber Match
2K34	Novell Fiber Match
2K35	6697 Fog
2K36	6695 Midnight
2K37	6242 Virginia Walnut
2K38	6009 Arctic White
2K48	6654 Sand
2K49	6053 Seagull
2K50	6052 Milk
2K52	6249 Platinum Solid
2K59	6655 Warm White
2K60	Granite Fiber Match
2K65	6037 Winter on Maple
2K71	6045 Medium Mahogany on Walnut
2K73	Instant Iron Patina Match
2K74	6237 Clear Maple
2K75	6231 Graphite Walnut

Tip: To improve consistency, default edge colors are now identified by 6000-series numbers; actual colors and defaults have not changed. Because default edge colors are not actually entered when specifying products, no specification changes are required. (Previous specification guides used 2000-series numbers to describe default edge colors, while 6000-series numbers were used for customer-specified edge colors, even though the edges were identical.)

► See the *Surface Materials Reference Manual* for more details.

Tip: Standard laminates being used in the Open Line laminate program to obtain a different edge detail will be charged the processing fee upcharge; however, no additional charges for the laminate will be applied.

2K Number Selection	Plastic Edge Color
2K78	6694 Slate
2K79	6698 Fieldstone
2K81	6038 Blonde on Maple
2K92	6000 Black
2K93	6001 Coffee
2K94	6635 Dawn
2K98	6636 Mist
2KAC	6213 Acacia
2KAK	6219 Clear Oak
2KAN	6707 Ash Noce
2KAW	6703 Ash Wenge
2KBN	6708 Bisque Noce
2KBW	6705 Bisque Wenge
2KCN	6709 Clay Noce
2KCW	6706 Clay Wenge
2KMI	6527 Merle
2KSN	6710 Storm Noce
2KSW	6704 Storm Wenge

Select Surfaces

2KT2	6T02 Fawn Cypress
2KT3	6T03 Weathered Char
2KT4	6T04 Saddle Oak
2KT5	6T05 Veranda Teak
2KT6	6T06 Persian Cherry
2KT7	6T07 Walnut Heights
2KU1	6T08 Aggregate
2KU2	6T09 Gravel
2KU4	6T10 Cement
2KU6	6T12 Sheetrock

Specification Guidelines for Vertical Fabric Applications

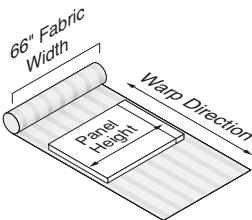

Warp horizontal means the height dimension of the tackboard is perpendicular to the warp of the fabric.

Application Topics

Tip: Fabric warp direction cannot be altered from standard on tackboards.

Customer's Own Material Yardage Requirements

Pre-approved fabrics are available. To determine if the fabric you want is on the pre-approved list, call a COM Consultant at 616.246.9822.

Surface Materials Representatives are also available to answer your questions and to provide clarification. They can also help with situations where you are using fabrics under 66"W. Call 616.246.9822.

For further information regarding COM fabrics, refer to the Steelcase *Surface Materials Reference Manual*.

Additional fabric is required to accommodate flaws, wrinkles, and other imperfections.

Standard Warp Directions

Fabric	Standard	Tackboards
Abacus	D	H
Alloy	D	H
Bariolage	D	H
Billiard Multi-Use by Designtex	D	H
Boccie	D	H
Bouquet	D	H
Buzz2	D	H
Charm*	D	H
Flip: Orbit	D	HO
Flip: TexHex	D	HO
Fresco	D	H
Lapel	D	H
Latch	D	H
Milano	D	H
Optic	D	H
Pianista	D	H
Rhythm	D	H
Rhythm	D	H

D = Directional
 ND = Non-directional
 H = Warp horizontal
 HO = Horizontal only

For Designtex Cutting Direction, see *Surface Materials Reference Manual*.

*These fabrics have some color restrictions. Check the *Surface Materials Reference Manual* for color availability.

Elective Elements

	
Statement of Line	170

	
Specifying Elective Elements	
Height-Adjustable Desks (SIN 711.2)	199
Worksurfaces (SIN 711.2)	209
Worksurface Supports (SIN 711.2)	247
Storage (SIN 711.2)	279
Electrical and Cable Management (SIN 711.2)	555

Statement of Line

Elective Elements

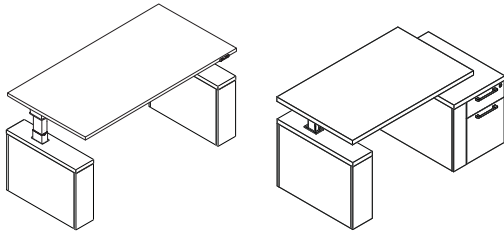

Specifying
▶ Page 199

Height-Adjustable Desks

	60"W	66"W	72"W	78"W	84"W	90"W	96"W
30"D	●	●	●	●	●	●	●
36"D	●	●	●	●	●	●	●

Planned widths shown

Tip: 90"W and 96"W are not available on the full-width top desk.

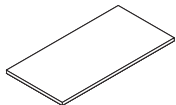

Specifying
▶ Page 210

Straight Worksurfaces

18"	30" 540 sq. in.	36" 648 sq. in.	42" 756 sq. in.	48" 864 sq. in.	54" 972 sq. in.	60" 1080 sq. in.	66" 1188 sq. in.	72" 1296 sq. in.	78" 1404 sq. in.	84" 1512 sq. in.	90" 1620 sq. in.
24"	24" 576 sq. in.	30" 720 sq. in.	36" 864 sq. in.	42" 1008 sq. in.	48" 1152 sq. in.	54" 1296 sq. in.	60" 1440 sq. in.	66" 1584 sq. in.	72" 1728 sq. in.	78" 1872 sq. in.	84" 2016 sq. in.
24"	90" 2160 sq. in.	96" 2304 sq. in.	102" 2448 sq. in.	108" 2592 sq. in.	114" 2736 sq. in.	120" 2880 sq. in.					
30"	24" 720 sq. in.	30" 900 sq. in.	36" 1080 sq. in.	42" 1260 sq. in.	48" 1440 sq. in.	54" 1620 sq. in.	60" 1800 sq. in.	66" 1980 sq. in.	72" 2160 sq. in.	78" 2340 sq. in.	84" 2520 sq. in.
30"	90" 2700 sq. in.	96" 2880 sq. in.	102" 3060 sq. in.	108" 3240 sq. in.	114" 3420 sq. in.	120" 3600 sq. in.					

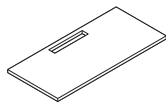

Specifying
▶ Page 214

Technology Straight Worksurfaces

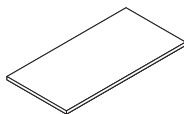
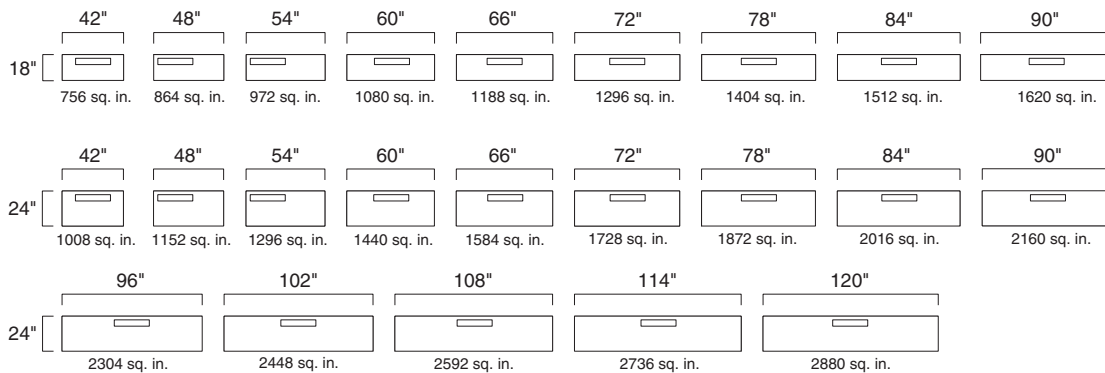

Specifying
▶ Page 216

Desk Worksurfaces—Straight and Bow Fronts

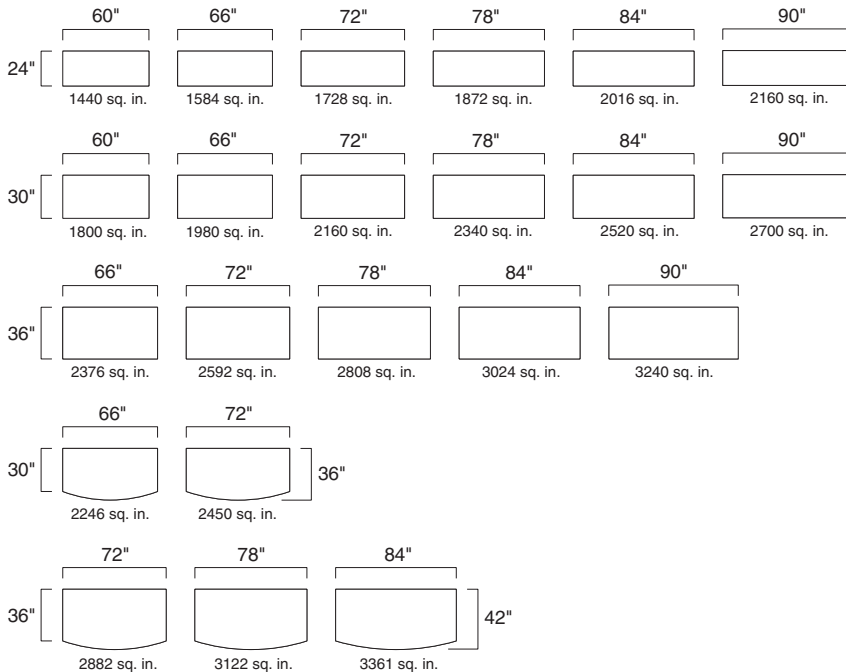

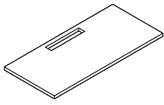

Specifying
▶ Page 218

Technology Desk Worksurfaces—Straight

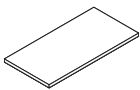
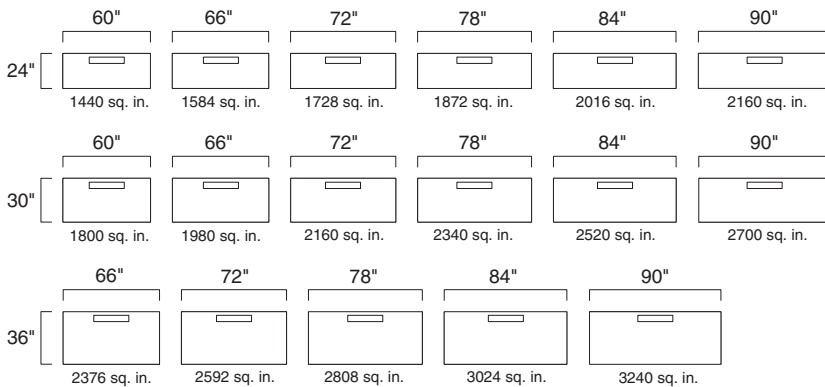

Specifying
▶ Page 220

Return Worksurfaces

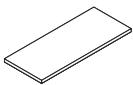
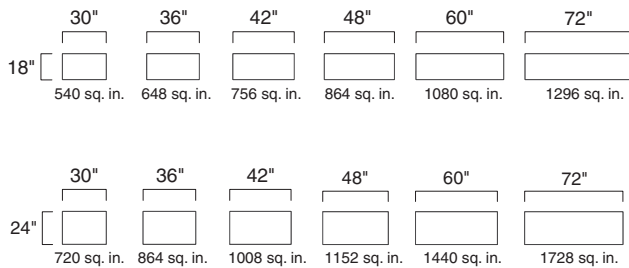

Specifying
▶ Page 224

Bridge Worksurfaces

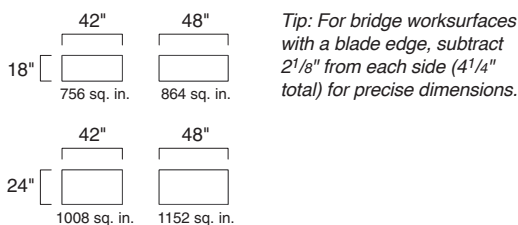

* Left-hand units shown. Right-hand units available.

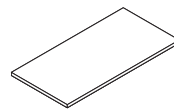

Specifying
▶ Page 222

Desk Return Worksurfaces

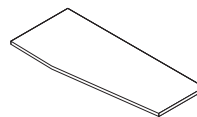
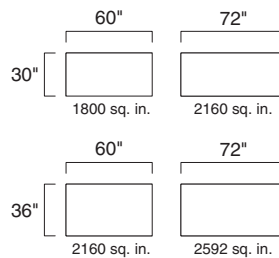

Left-hand unit

Specifying
▶ Page 226

Single Tapered Worksurfaces*

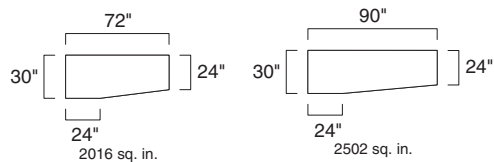

* Left-hand units shown. Right-hand units available.

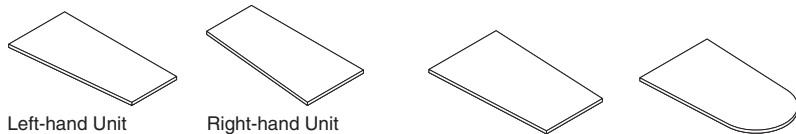

Specifying
▶ Page 228

Tapered Worksurfaces—Single* and Double, Straight and Rounded, Run-Off

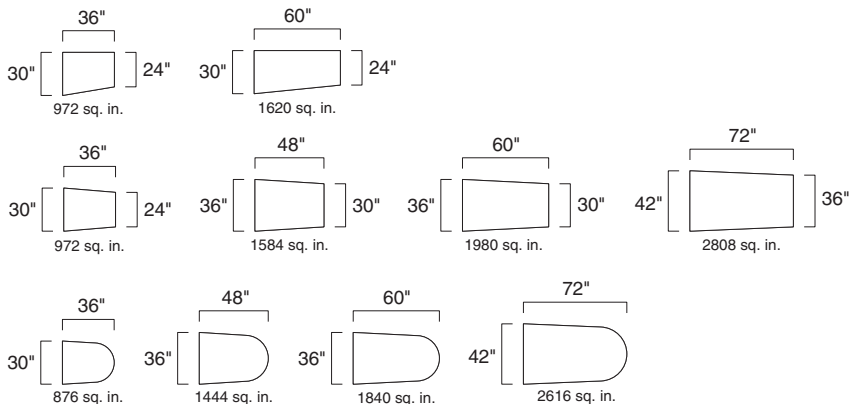

* Single tapered worksurfaces left-hand units shown.
Right-hand units available.

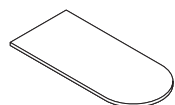

Specifying
▶ Page 230

Bullet Worksurfaces—Run-Off and Freestanding

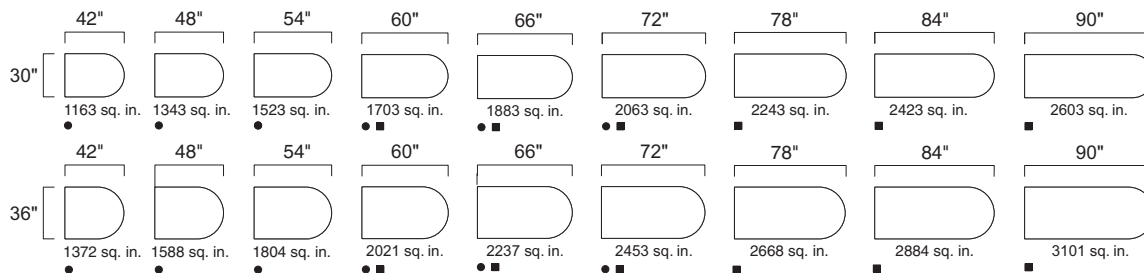

● = Run-Off
■ = Freestanding

Statement of Line, Elective Elements, continued

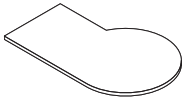

Specifying
▶ Page 232



Specifying
▶ Page 234

P-Top Worksurfaces—Run-Off and Freestanding

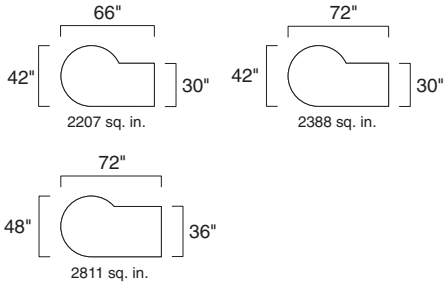

Meeting Worksurfaces

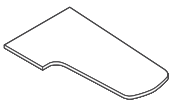
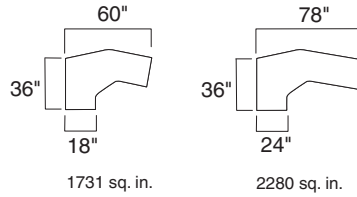

Specifying
▶ Page 236

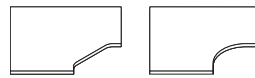

Specifying
▶ Page 238

Extended Bullet Worksurfaces

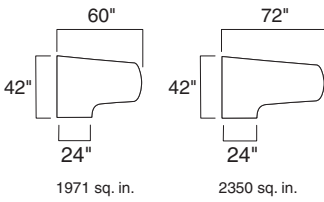

Corner Worksurfaces—Straight and Curved Front

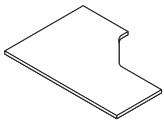
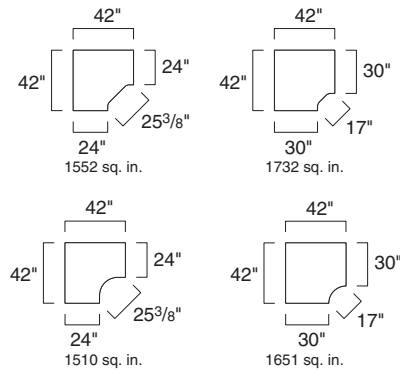

Specifying
▶ Page 240

Extended Corner Worksurfaces*

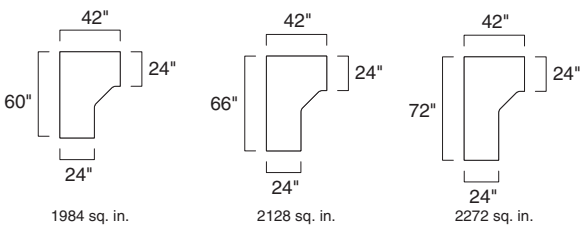

*Left-hand units shown.
Right-hand units available.

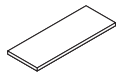

Specifying
▶ Page 242

Transaction Worksurfaces

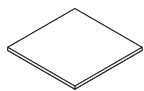
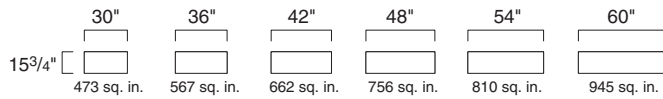

Specifying
▶ Page 244



Specifying
▶ Page 248

Personal Table Tops

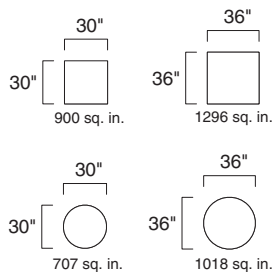

Back Panels

	15"W	18"W	30"W	36"W
15 ¹ / ₂ "H			●	●
21 ¹ / ₂ "H	●	●		
27 ¹ / ₂ "H	●	●		
35 ⁷ / ₈ "H	●			

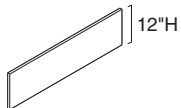

Specifying
▶ Page 266

Modesty Panels for Use with Desks, Meeting, and Extended Bullet Worksurfaces

	24"W	30"W	36"W	42"W	48"W	54"W	60"W	66"W	72"W	78"W	84"W	90"W
12"H	●	●	●	●	●	●	●	●	●	●	●	●

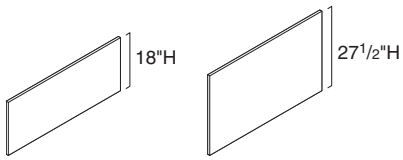

Specifying
▶ Page 266

Full-Height Modesty Panels for Use with Desks, Credenzas, and Backs for 30"W or 36"W Pedestals

	24"W	30"W	36"W	42"W	48"W	54"W	60"W	66"W	72"W	78"W	84"W	90"W	96"W	102"W	108"W	114"W	120"W
18"H				●	●	●	●	●	●	●	●	●					
27½"H	●	●	●	●	●	●	●	●	●	●	●	●	●	●	●	●	●

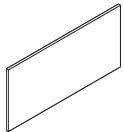

Specifying
▶ Page 266

Full-Height Modesty Panels for Use with Plinth Base 1.5 High Storage

	30"W	36"W	42"W	48"W	54"W	60"W	66"W	72"W	78"W	84"W	90"W	96"W
21½"H	●	●	●	●	●	●	●	●	●	●	●	●

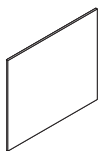

Specifying
▶ Page 266

Full-Height Modesty Panels for Bridges

For Use with Plinth Base and Leg Base

	48"W	54"W
18 ¹³ / ₁₆ "H	●	●
27½"H	●	●

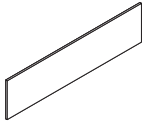

Specifying
▶ Page 266

Modesty Panels for Use with Run-Off Tops

For Use with Plinth Base and Leg Base

	39"W	42"W	45"W	48"W	51"W	54"W	57"W	60"W	64"W	66"W	69"W	72"W	75"W	78"W	81"W	84"W
18"H	•	•	•	•	•	•	•	•	•	•	•	•	•	•	•	•

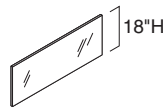
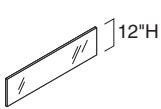

Specifying
▶ Page 270

Glass Modesty Panels

For Use with Plinth Base and Leg Base

	42"W	48"W	54"W	60"W	66"W	66"W	72"W
12"H	•	•	•	•	•	•	•
18 ³ / ₁₆ "H	•	•	•	•	•	•	•



Specifying
▶ Page 250

Filler Panels

For Use with Plinth Base and Leg Base

	3/4"D	1 1/2"D
10 ³ / ₈ "H	•	
15 1/2"H	•	•
21 1/2"H	•	•
27 1/2"H	•	•

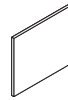

Specifying
▶ Page 252

Plinth Base End Panels

	15"D	17 1/4"D	23 1/4"D	29 1/4"D
21 1/2"H		•	•	
27 1/2"H	•	•	•	•

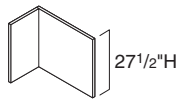
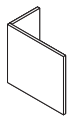

Left-hand

Right-hand

Specifying
▶ Page 252

Plinth Base L-Shape End Panels

	15"D	17 1/4"D	23 1/4"D	29 1/4"D
10 ³ / ₈ "H		•	•	•
15 1/2"H		•	•	
21 1/2"H		•	•	
27 1/2"H	•	•	•	•

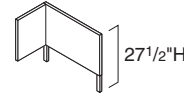
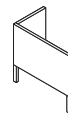

Left-hand

Right-hand

Specifying
▶ Page 264

Leg Base L-Shape End Panels

	15"D	18"D	24"D
27 1/2"H	•	•	•

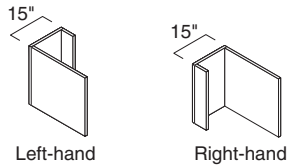

Specifying
▶ Page 252

Plinth Base J-Shape End Panels

	24"D	30"D
27½"H	●	●



Specifying
▶ Page 252

Plinth Base End Panels for Use with Montage Panels (On-Module)

	15"D	18"D	24"D	30"D
27½"H	●	●	●	●



Specifying
▶ Page 252

Plinth Base End Panels for Use with Answer Panels and Privacy Wall (On-Module)

	15"D	18"D	24"D	30"D
27½"H	●	●	●	●



Specifying
▶ Page 271

Perpendicular Tether Supports For Use with Plinth Base and Leg Base

	13⅝"W	19⅝"W
19⅝"D	●	●
25⅝"D	●	●
31⅝"D	●	●

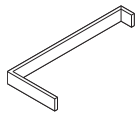

Specifying
▶ Page 272

Cable Shroud Supports For Use with Plinth Base and Leg Base

	48"W	54"W	60"W	66"W
19⅝"D	●	●	●	●
25⅝"D	●	●	●	●
31⅝"D	●	●	●	●

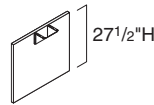

Specifying
▶ Page 256

Plinth Base Free Support End Panels

	30"D	36"D
27½"H	●	●

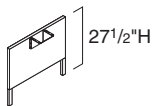

Specifying
▶ Page 265

Leg Base Free Support End Panels

	30"D	36"D
27½"H	●	●

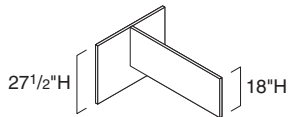

Specifying
▶ Page 258

Plinth Base Extended T-Shape End Panels (Includes Modesty Panel)

	39"W	42"W	44"W	45"W	48"W	50"W	51"W	54"W	57"W	60"W	63"W	66"W	69"W	72"W
30"D		●	●		●	●		●		●		●		●
36"D	●			●			●		●		●		●	

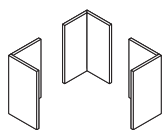

Specifying
▶ Page 260

Plinth Base Corner Support Kits

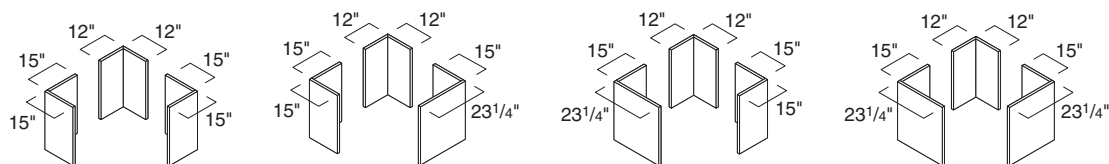

Specifying
▶ Page 260

Plinth Base Rear L-Shape Corner Support

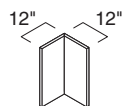

Specifying
▶ Page 261

Plinth Base Center Support Panels

	8"D	11"D
10 3/8"H	●	●
15 1/2"H	●	●
21 1/2"H	●	●
27 1/2"H	●	●

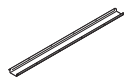

Specifying
▶ Page 274

Worksurface Braces

For Use with Plinth Base and Leg Base

	45"W	51"W	57"W	69"W
1"H	●	●	●	●

Rectangular Column Leg

For Use with Plinth Base and Leg Base

Without Base

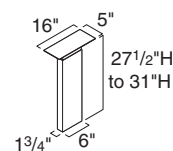

With Base

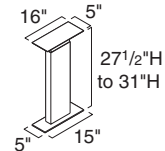

Specifying
▶ Page 276

Specifying
▶ Page 276

Column

For Use with Plinth Base and Leg Base

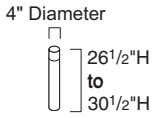

Disk Column

For Use with Plinth Base and Leg Base

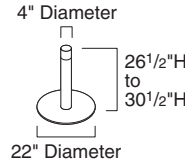

Specifying
▶ Page 276

Specifying
▶ Page 276

Adjustable-Height Legs

For Use with Plinth Base and Leg Base

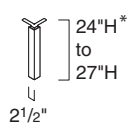
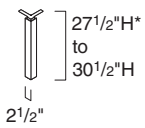

* Not including worksurfaces

Gate Legs

For Use with Plinth Base and Leg Base

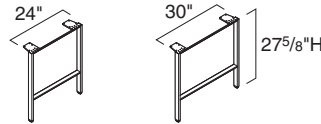

Specifying
▶ Page 276

Specifying
▶ Page 276

Freestanding Table Bases

For Use with Plinth Base and Leg Base

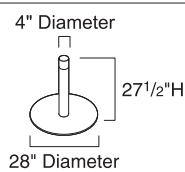
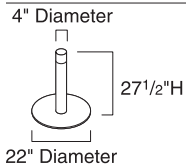

Parallel Slip-Fit Support

For Use with Plinth Base and Leg Base

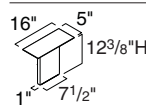

Specifying
▶ Page 276

Specifying
▶ Page 282

Storage Leg

Available for Use with Leg Base Storage Only

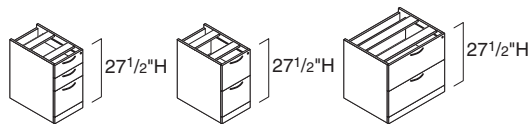
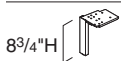

Plinth Base Pedestals with Drawers

	15"W	18"W	30"W	36"W
17 1/4"D	●	●	●	●
23 1/4"D	●	●	●	●
29 1/4"D	●	●	●	●

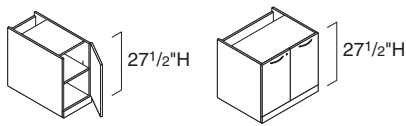

Specifying
▶ Page 282

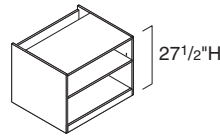

Specifying
▶ Page 282

Plinth Base Pedestals with Hinged Door(s)

	15"W	18"W	30"W	36"W
17 1/4"D	●	●	●	●
23 1/4"D	●	●	●	●
29 1/4"D	●		●	

Plinth Base Open Pedestals

	15"W	18"W	30"W	36"W
16 1/2"D	●	●	●	●
22 1/2"D	●	●	●	●
28 1/2"D			●	●

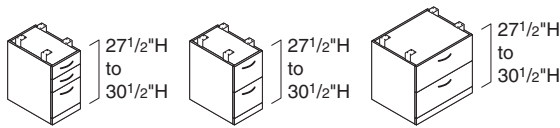

Specifying
▶ Page 288

Plinth Base Adjustable-Height Pedestals

	15"W	18"W	30"W	36"W
23 1/4"D	●	●	●	●
29 1/4"D	●	●	●	●

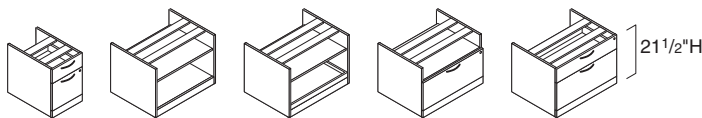

Specifying
▶ Page 292

Plinth Base 1.5 High Storage Units (21 1/2"H)

	15"W	18"W	30"W	36"W	42"W
16 1/2"D Open			●	●	●
22 1/2"D Open			●	●	●
22 1/2"D Open with Pull-Out Tray			●	●	
17 1/4"D Open with Lateral File			●	●	
23 1/4"D Open with Lateral File			●	●	
23 1/4"D Box/File		●	●	●	

Statement of Line, Elective Elements, continued

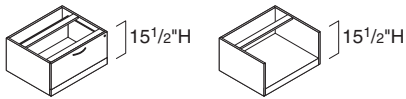

Specifying
▶ Page 296

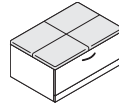

Specifying
▶ Page 298

Plinth Base One-High Pedestals

	30"W	36"W
16 1/2"D Bookcase	●	●
17 1/4"D Lateral File	●	●
23 1/4"D Lateral File	●	●
22 1/2"D Bookcase	●	●

Cushion Tops

For Use with Plinth Base and Leg Base

	30"W	36"W
18"D	●	●
24"D	●	●

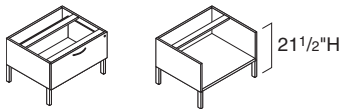

Specifying
▶ Page 348

Leg Base 21 1/2"H Storage

	30"W	36"W
18"D Lateral File	●	●
24"D Lateral File	●	●
23 1/16"D Open	●	●

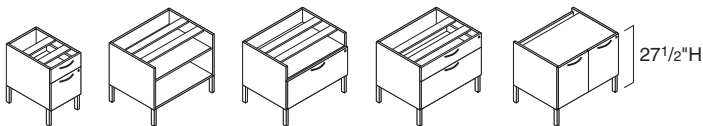

Specifying
▶ Page 350

Leg Base 27 1/2"H Storage

	15"W	18"W	30"W	36"W
18"D Box/File			●	●
24"D Box/File	●	●	●	●
18"D Open			●	●
24"D Open			●	●
18"D Open with Lateral File			●	●
18"D Hinged Doors			●	●
24"D Hinged Doors			●	●

Tip: If inset pull is selected, the pulls are on the door seam vertically.

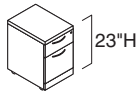

Specifying
▶ Page 300

Plinth Base Mobile Pedestal

15½"W
22¾"D ●

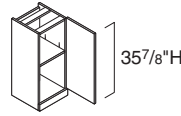

Specifying
▶ Page 302

Plinth Base High Pedestals

15½"W
15"D Open Unit ●
15¾"D Hinged Door ●

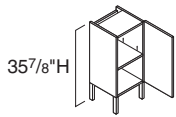

Specifying
▶ Page 356

Leg Base High Pedestal

15"W
15¾"D Hinged Door ●

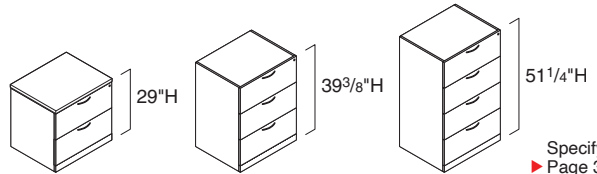

Specifying
▶ Page 304–306

Plinth Base Lateral Files

30"W	36"W
24"D ●	●

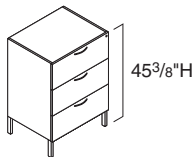

Specifying
▶ Page 358

Leg Base Lateral File

30"W	36"W
24"D ●	●

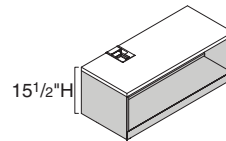

Specifying
▶ Page 308

One-High Open Plinth Base Pedestals for Ology Application

24"W	30"W	36"W	42"W
17¼"D ●	●	●	●

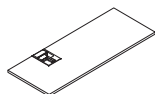

Specifying
▶ Page 310

Common Top for Ology Application

	24"W	30"W	36"W	42"W	48"W	54"W	60"W	66"W	72"W	78"W	84"W	90"W
18"D	●	●	●	●	●	●	●	●	●	●	●	●
	96"W	102"W	108"W	114"W	120"W							
18"D	●	●	●	●	●							

Statement of Line, Elective Elements, continued

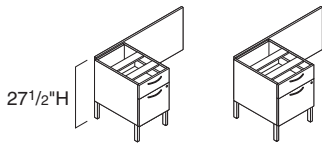

Specifying
▶ Page 360

Leg Base Return Credenzas

	42"W	48"W	60"W
18"D	●	●	●
24"D	●	●	●

Tip: Return credenzas are standard with either a 15"W or 18"W box/file positioned left or right with a 42"W, 48"W, or 60"W spanning back panel.

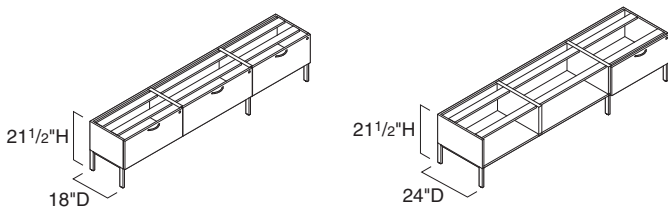

Specifying
▶ Page 364

Leg Base 21 1/2"H Credenzas

	30"W	36"W	60"W	66"W	72"W	90"W	96"W
18"D	●	●	●	●	●	●	●
24"D	●	●	●	●	●	●	●

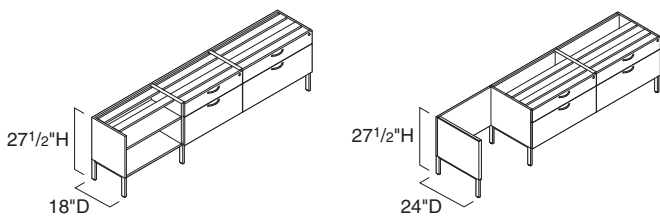

Specifying
▶ Page 374

Leg Base 27 1/2"H Credenzas

	15"W	18"W	30"W	36"W	42"W	45"W	48"W	54"W	60"W	66"W	72"W	78"W	84"W	90"W	96"W	102"W	108"W
18"D			●	●					●		●			●	●		
24"D	●	●	●	●	●	●	●	●	●	●	●	●	●	●	●	●	●

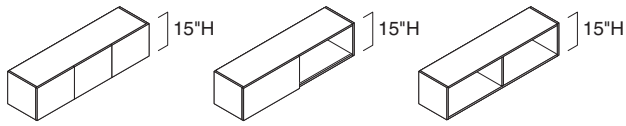

Specifying
▶ Page 484

15"H Single-High Overhead Cabinets
For Use with Plinth Base and Leg Base Storage

	30"W	36"W	42"W	48"W	54"W	60"W	66"W	72"W	78"W	84"W	90"W	96"W
15¾"D Hinged Doors	●	●	●	●	●	●	●	●	●	●	●	●
15¾"D Sliding Door		●	●	●	●	●	●	●	●	●	●	●
15"D Open	●	●	●	●	●	●	●	●	●	●	●	●
17¼"D Open	●	●	●	●	●	●	●	●	●	●	●	●
18"D Sliding Door		●	●	●	●	●	●	●	●	●	●	●
18"D Hinged Doors	●	●	●	●	●	●	●	●	●	●	●	●

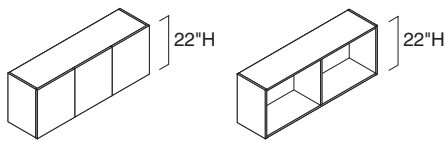

Specifying
▶ Page 490

22"H Single-High Overhead Cabinets
For Use with Plinth Base and Leg Base Storage

	30"W	36"W	42"W	48"W	54"W	60"W	66"W	72"W	78"W	84"W	90"W	96"W
15¾"D Hinged Doors	●	●	●	●	●	●	●	●	●	●	●	●
15"D Open	●	●	●	●	●	●	●	●	●	●	●	●

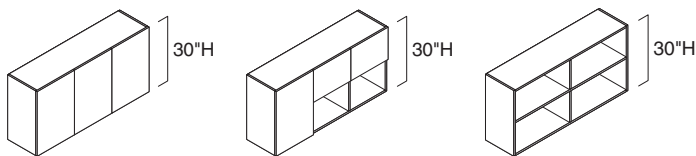

Specifying
▶ Page 494

Double-High Overhead Cabinets
For Use with Plinth Base and Leg Base Storage

	60"W	66"W	72"W	78"W	84"W	90"W	96"W
15¾"D Doors	●	●	●	●	●	●	●
15"D Open	●	●	●	●	●	●	●

Statement of Line, Elective Elements, continued

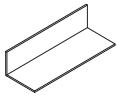

Specifying
Page 498

Floating Shelf with Shelf Back Panel

6"D Floating Shelf

	36"W	54"W	72"W	90"W
15"H	●	●	●	●
22"H	●	●	●	●
30"H	●	●	●	●

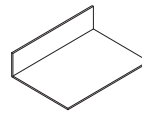

Specifying
Page 498

Floating Shelf with Shelf Back Panel

12"D Floating Shelf

	36"W	54"W	72"W	90"W
15"H	●	●	●	●
22"H	●	●	●	●
30"H	●	●	●	●

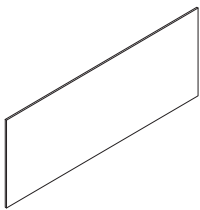

Specifying
Page 502

Floating Back Panel

12"D Floating Shelf

	36"W	54"W	72"W	90"W
15"H	●	●	●	●
22"H	●	●	●	●
36"H	●	●	●	●
48"H	●	●	●	●

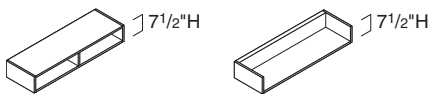

Specifying
Page 504

Organizer and Open Shelves

For Use with Plinth Base and Leg Base Storage

	30"W	36"W	42"W	48"W	54"W	60"W	66"W	72"W	78"W	84"W	90"W	96"W
15"D Organizer Shelf	●	●	●	●	●	●	●	●	●	●	●	●
15"D Open Shelf	●	●	●	●	●	●	●	●	●	●	●	●
17 1/4"D Organizer Shelf	●	●	●	●	●	●	●	●	●	●	●	●

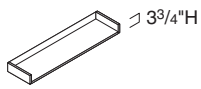

Specifying
▶ Page 504

Accessory Shelves

For Use with Plinth Base and Leg Base Storage

	30 ³ / ₈ "W	36 ³ / ₈ "W	45 ³ / ₈ "W	48 ³ / ₈ "W
12"D	●	●	●	●

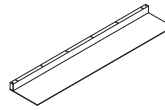

Specifying
▶ Page 508

Blade Accessory Shelves

For Use with Plinth Base and Leg Base Storage

	48"W	60"W	72"W	84"W	96"W
14 ¹ / ₈ "D Personal	●	●	●	●	●

Tip: Blade accessory shelf is available in corresponding widths for use with a service module or single side support.

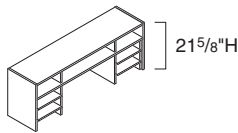

Specifying
▶ Page 510

Desktop Organizers – Combo

For Use with Plinth Base and Leg Base Storage

	60"W	72"W
15"D	●	●



Specifying
▶ Page 510

Desktop Organizer – Vertical

For Use with Plinth Base and Leg Base Storage

	14"W
14"D	●

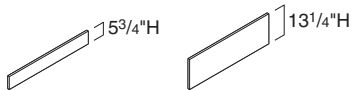

Specifying
▶ Page 512

Insert Back Panels for Overhead Storage

For Use with Plinth Base and Leg Base Storage

	28 ¹ / ₄ "W	34 ¹ / ₄ "W	40 ¹ / ₄ "W	46 ¹ / ₄ "W	52 ¹ / ₄ "W	58 ¹ / ₄ "W	64 ¹ / ₄ "W	70 ¹ / ₄ "W	76 ¹ / ₄ "W	82 ¹ / ₄ "W	88 ¹ / ₄ "W	94 ¹ / ₄ "W
5 ³ / ₄ "H	●	●	●	●	●	●	●	●	●	●	●	●
13 ¹ / ₄ "H	●	●	●	●	●	●	●	●	●	●	●	●

Statement of Line, Elective Elements, continued

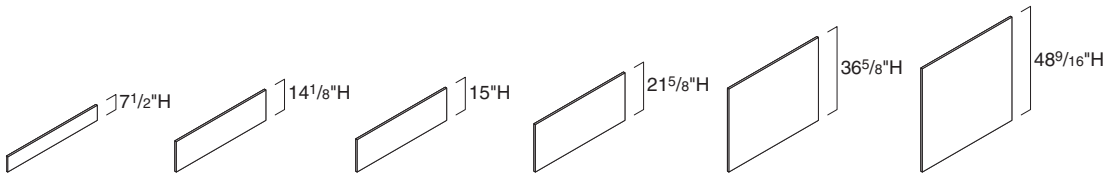

Specifying
▶ Page 514

Back Panels for Overhead Storage and Desktop Organizers

For Use with Plinth Base and Leg Base Storage

	15"W	18"W	30"W	36"W	42"W	48"W	54"W	60"W	66"W	72"W	78"W	84"W	90"W	96"W
7 1/2"H			•	•	•	•	•	•	•	•	•	•	•	•
14 1/8"H			•	•	•	•	•	•	•	•	•	•	•	•
15"H			•	•	•	•	•	•	•	•	•	•	•	•
21 5/8"H			•	•	•	•	•	•	•	•	•	•	•	•
22"H			•	•	•	•	•	•	•	•	•	•	•	•
36 5/8"H	•	•	•	•	•	•	•	•	•	•	•	•	•	•
43 3/4"H								•	•	•	•	•	•	•
48 9/16"H	•	•	•	•				•	•	•	•	•	•	•

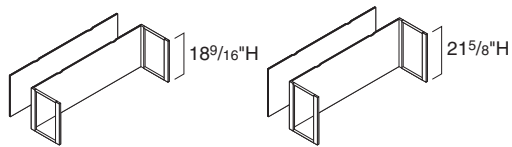

Specifying
▶ Page 518

Hutch Kits

For Use with Plinth Base and Leg Base Storage

	30"W	36"W	42"W	48"W	54"W	60"W	66"W	72"W	78"W	84"W	90"W	96"W
18 9/16"H					•	•	•	•	•	•	•	•
21 5/8"H	•	•	•	•	•	•	•	•	•	•	•	•

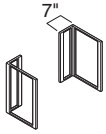

Specifying
▶ Page 521

Open Hutch Kits

For Use with Plinth Base and Leg Base Storage

	14½"H	17¼"H	21⅝"H
15"D	●	●	●
17¼"D	●	●	●



Specifying
▶ Page 522

Side Support Frames

For Use with Plinth Base and Leg Base Storage

	6⅝"H	7"H	14½"H	17¼"H	21⅝"H
15"D	●	●	●	●	●
17¼"D		●	●	●	●

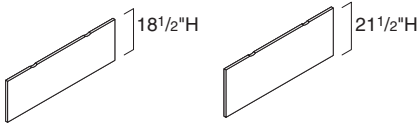

Specifying
▶ Page 524

Wall-Mounted Tackboards

	30"W	36"W	42"W	48"W	54"W	60"W	66"W	72"W	78"W	84"W	90"W	96"W
18½"H						●	●	●	●	●	●	●
21½"H	●	●	●	●	●	●	●	●	●	●	●	●

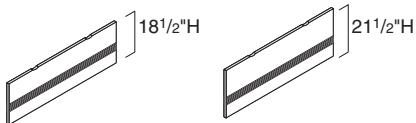

Specifying
▶ Page 524

Wall-Mounted Wood Panels with Slatwall

	30"W	36"W	42"W	48"W	54"W	60"W	66"W	72"W	78"W	84"W	90"W	96"W
18½"H						●	●	●	●	●	●	●
21½"H	●	●	●	●	●	●	●	●	●	●	●	●

Statement of Line, Elective Elements, continued

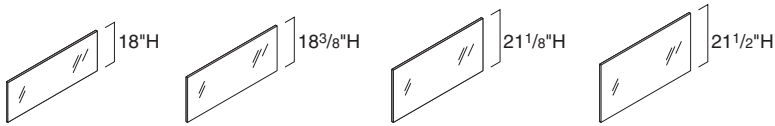

Specifying
▶ Page 532

Magnetic Back Painted Glass—With Single-High Overhead

	30"W	36"W	42"W	48"W	54"W	60"W	66"W	72"W	78"W	84"W	90"W	96"W
18"H**				●		●		●		●		●
18 ³ / ₈ "H				●		●		●		●		●
21 ¹ / ₈ "H**	●	●	●	●	●	●	●	●	●	●	●	●
21 ¹ / ₂ "H	●	●	●	●	●	●	●	●	●	●	●	●

**With cord management selection
Tip: 18"H and 18³/₈"H is for use with blade accessory shelf.

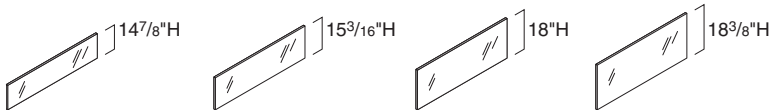

Specifying
▶ Page 532

Magnetic Back Painted Glass—With Double-High Overhead

	60"W	66"W	72"W	78"W	84"W	90"W	96"W
14 ⁷ / ₈ "H**	●		●		●		●
15 ³ / ₁₆ "H	●		●		●		●
18"H**	●	●	●	●	●	●	●
18 ³ / ₈ "H	●	●	●	●	●	●	●

**With cord management selection
Tip: 15³/₁₆"H and 14⁷/₈"H is for use with blade accessory shelf.

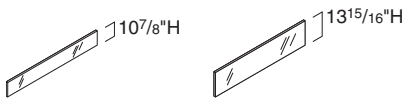

Specifying
▶ Page 532

Magnetic Back Painted Glass—With Single-High Service Module and Organizer

	60"W	66"W	72"W	78"W	84"W	90"W	96"W
10 ⁷ / ₈ "H	●		●		●		●
13 ¹⁵ / ₁₆ "H	●	●	●	●	●	●	●

Tip: 10⁷/₈"H is for use with blade accessory shelf.

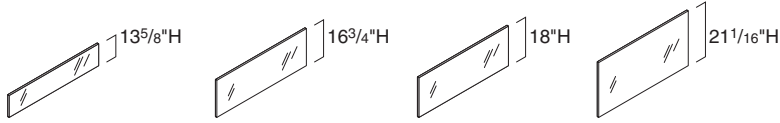

Specifying
▶ Page 532

Magnetic Back Painted Glass—With Single-High Service Module

	60"W	66"W	72"W	78"W	84"W	90"W	96"W
13 ⁵ / ₈ "H	●		●		●		●
16 ³ / ₄ "H	●	●	●	●	●	●	●
18"H	●	●	●	●	●	●	●
21 ¹ / ₁₆ "H	●	●	●	●	●	●	●

Tip: 13⁵/₈"H and 18"H is for use with blade accessory shelf.

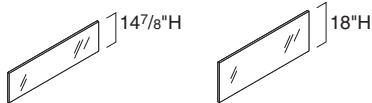

Specifying
▶ Page 532

Magnetic Back Painted Glass—With Double-High Service Module

	60"W	66"W	72"W	78"W	84"W	90"W	96"W
14 ⁷ / ₈ "H	●		●		●		●
18"H	●	●	●	●	●	●	●

Tip: 14⁷/₈"H is for use with blade accessory shelf.

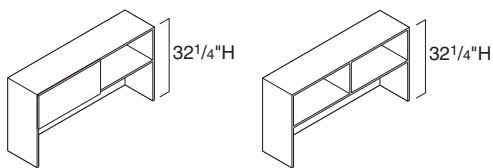

Specifying
▶ Page 536

Single-High Service Modules—32¹/₄"H

	60"W	66"W	72"W	78"W	84"W	90"W	96"W
15"D*	●	●	●	●	●	●	●

*Units with sliding doors are 15³/₄"D.

Statement of Line, Elective Elements, continued

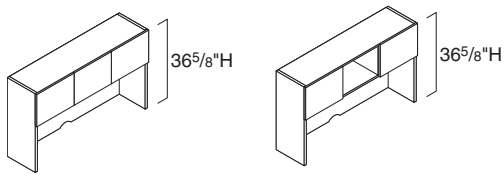

Specifying
▶ Page 540

Single-High Service Modules—36⁵/₈"H

	60"W	66"W	72"W	78"W	84"W	90"W	96"W
15 ³ / ₄ "D	●	●	●	●	●	●	●

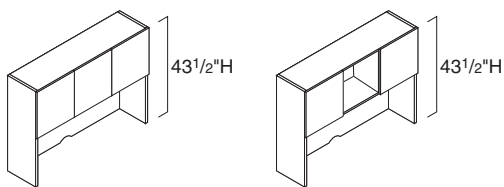

Specifying
▶ Page 542

Single-High Service Modules—43¹/₂"H

	60"W	66"W	72"W	78"W	84"W	90"W	96"W
15 ³ / ₄ "D	●	●	●	●	●	●	●

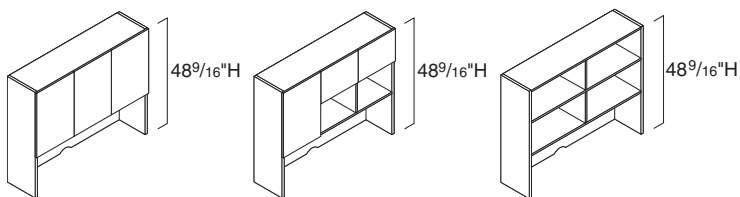

Specifying
▶ Page 546

Double-High Service Modules

	60"W	66"W	72"W	78"W	84"W	90"W	96"W
15 ³ / ₄ "D	●	●	●	●	●	●	●
15"D Open	●	●	●	●	●	●	●

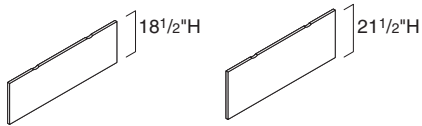

Specifying
▶ Page 550

Tackboards and Wood Panels with Slatwall for Use with Service Modules

	57 1/2"W	58 1/2"W	63 1/2"W	64 1/2"W	69 1/2"W	70 1/2"W	75 1/2"W	76 1/2"W	81 1/2"W	82 1/2"W	87 1/2"W	88 1/2"W	93 1/2"W	94 1/2"W
14 1/2"H*		●		●		●		●		●		●		●
17 1/4"H*		●		●		●		●		●		●		●
18 1/2"H	●		●		●		●		●		●		●	
21 1/2"H	●		●		●		●		●		●		●	

*14 1/2"H and 17 1/4"H are only available in tackboards.

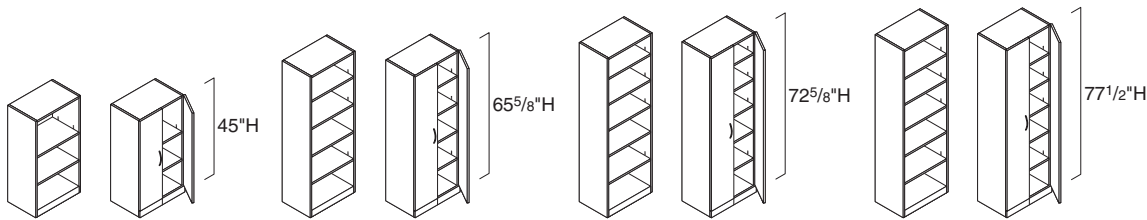

Specifying
▶ Pages 312 – 314

Plinth Base Freestanding Bookcases

	24"W	30"W	36"W
45"H	●	●	●
65 5/8"H	●	●	●
72 5/8"H	●	●	●
77 1/2"H	●	●	●

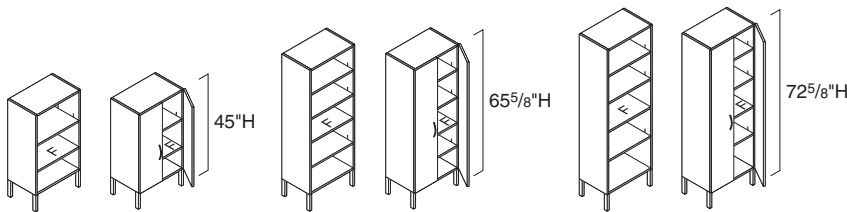

Specifying
▶ Page 456

Leg Base Freestanding Bookcases

	30"W	36"W
45"H	●	●
65 5/8"H	●	●
72 1/2"H	●	●

Note: All leg base bookcases are 15"D.

Statement of Line, Elective Elements, continued

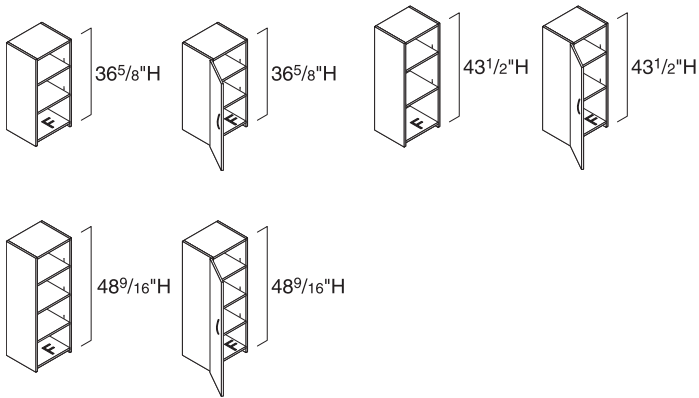

Specifying
▶ Pages 318 – 320

Stacking Bookcases

For Use with Plinth Base and Leg Base Storage

	15"W	18"W	30"W	36"W
36 ⁵ / ₈ "H	●	●	●	●
43 ¹ / ₂ "H	●	●	●	●
48 ⁹ / ₁₆ "H	●	●	●	●

Left-hand units shown. Right-hand units available.
 Tip: 36⁵/₈"H and 48⁹/₁₆"H units available 15"D (15³/₄" with doors).
 Tip: Hinged doors with pulls open 94°

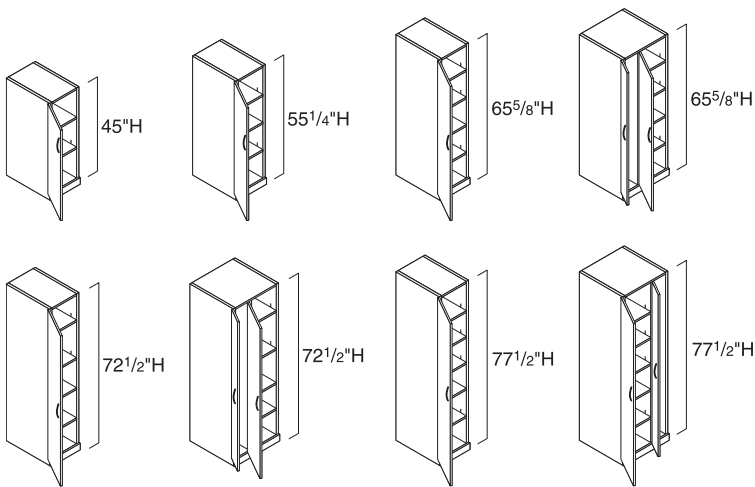

Specifying
▶ Page 326

Plinth Base Towers with Full-Height Doors

	15 ¹ / ₂ "W	24"W
18"D*	●	
24"D	●	●
30"D		●

Left-hand units shown. Right-hand units available.
 Tip: Hinged doors with pulls open 94°
 *18"D in 45"H and 55¹/₄"H only.

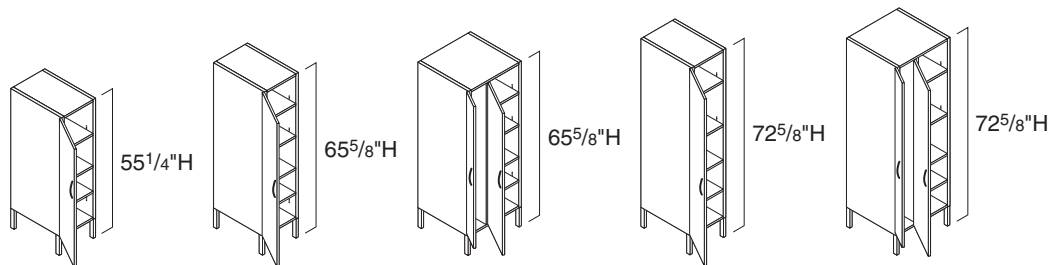

Specifying
▶ Page 468

Leg Base Towers with Full-Height Doors

	15 1/2"W	24"W
18"D*	●	
24"D	●	●

Left-hand units shown. Right-hand units available.
Tip: Hinged doors with pulls open 94°
 *18"D in 55 1/4"H.

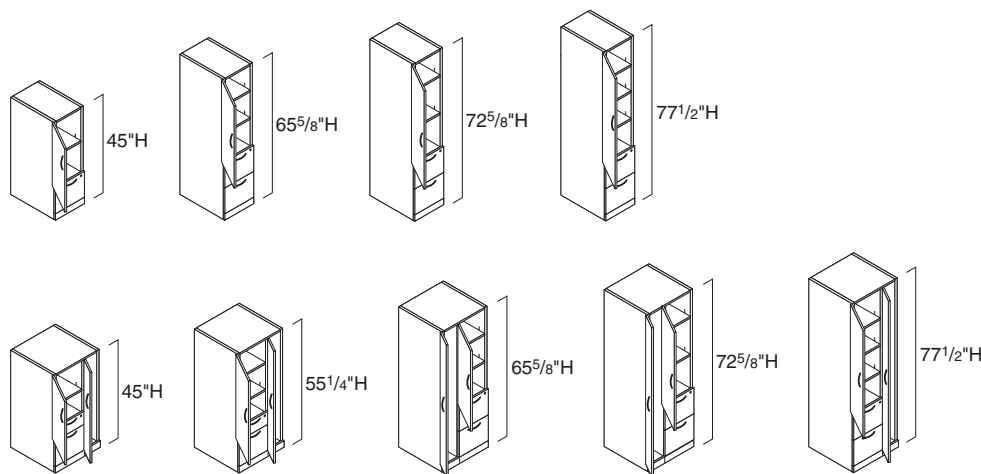

Specifying
▶ Page 330

Plinth Base Towers with Doors and Drawers

	15 1/2"W	24"W
18"D*		●
24"D	●	●
30"D		●

Left-hand units shown. Right-hand units available.
Tip: Hinged doors with pulls open 94°
 *18"D in 45"H and 55 1/4"H only.

Statement of Line, Elective Elements, continued

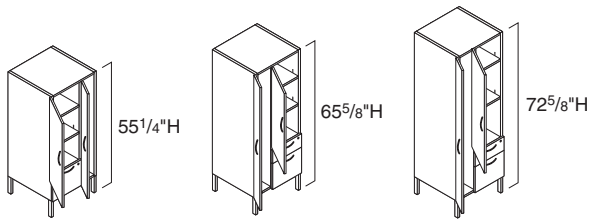

Specifying
Page 472

Leg Base Towers with Doors and Drawers

24"W

18"D* ●

24"D ●

Left-hand units shown. Right-hand units available.

Tip: Hinged doors with pulls open 94°

*18"D in 55 1/4"H.

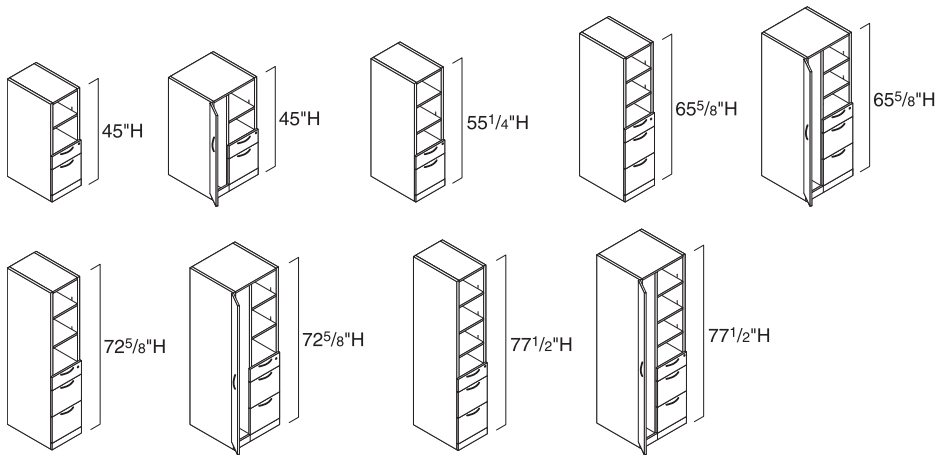

Specifying
Page 334

Plinth Base Towers with Open Shelves and Drawers

15 1/2"W 24"W

18"D* ●

24"D ● ●

Left-hand units shown. Right-hand units available.

Tip: Hinged doors with pulls open 94°

*18"D in 45"H and 55 1/4"H only.

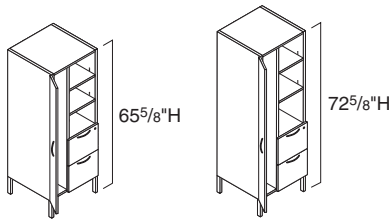

Specifying
▶ Page 476

Leg Base Towers with Open Shelves and Drawers

24"W

24"D ●

Left-hand units shown. Right-hand units available.
Tip: Hinged doors with pulls open 94°

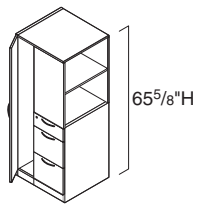

Specifying
▶ Page 334

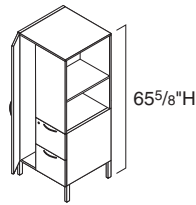

Specifying
▶ Page 476

Plinth Base Tower with Bookshelf, Drawers, and Wardrobe

24"W

24"D ●

Left-hand units shown. Right-hand units available.
Tip: Hinged doors with pulls open 94°

Leg Base Tower with Bookshelf, Drawers, and Wardrobe

24"W

24"D ●

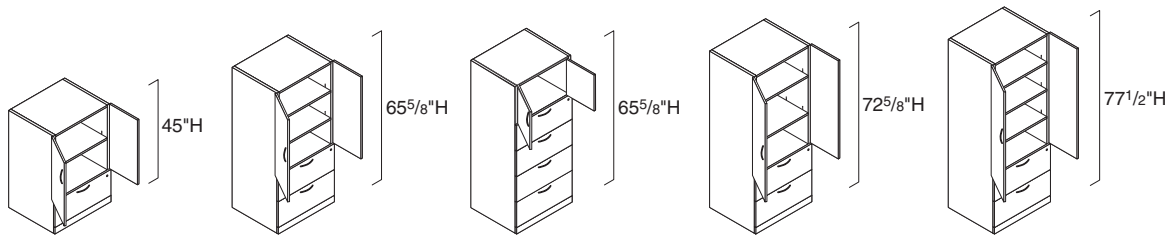

Specifying
▶ Page 338

Plinth Base Vertical Cabinets

30"W

24"D ●

Tip: Hinged doors with pulls open 94°

Statement of Line, Elective Elements, continued

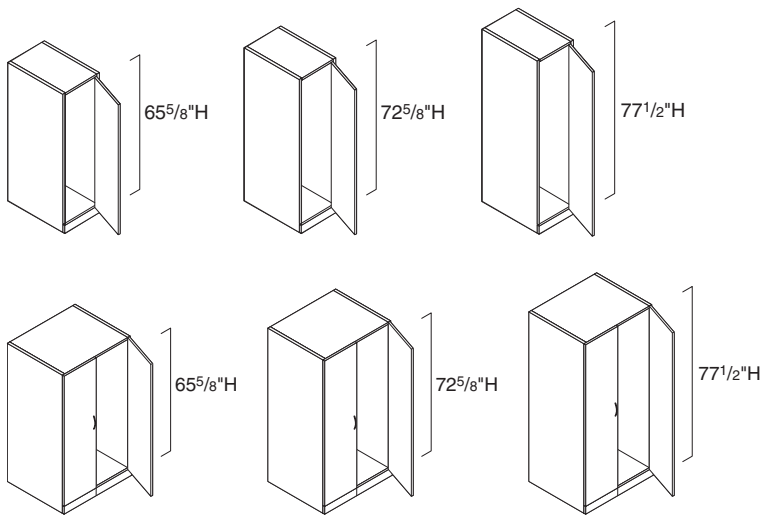

Specifying
▶ Page 342

Plinth Base Wardrobes

	15 1/2"W	30"W
24"D	●	●

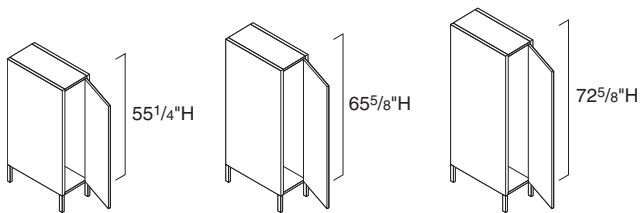

Specifying
▶ Page 480

Leg Base Wardrobes

	12"W
24"D	●

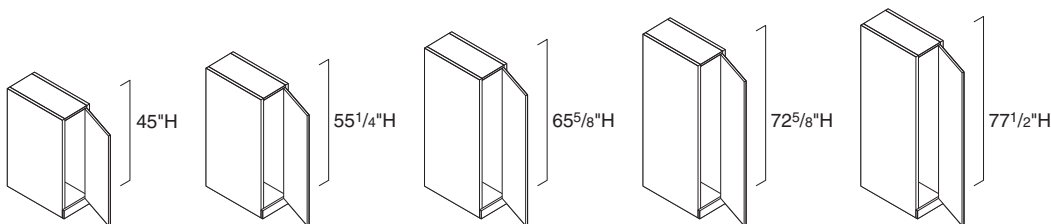

Specifying
▶ Page 342

Plinth Base Personal Wardrobes

	12"W
18"D	●
24"D	●

*Right-hand shown. Left-hand available.

Specifying Elective Elements Height-Adjustable Desks



Height-Adjustable Desks

Full-Width Desk (SIN 711.2)	200
Partial-Width Desk (SIN 711.2)	204

Height-Adjustable Desks

Full-Width Top

SIN 711.2

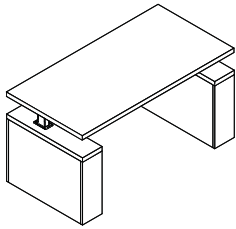

Standard Includes	Required to Specify
-------------------	---------------------

- Top: wood group 1 veneer
- Base: paint
- Two shrouds: wood group 1 veneer
- Edge: 3 mm wood square edge to match top
- Three-preset controller
- Lock, keyed random, if pedestal storage selected

- 1 Style number
 - 2 Depth (see below under Required Selections)
 - 3 Width (see below under Required Selections)
 - 4 Wood veneer color number for top
 - 5 Paint color number for base
 - 6 Wood veneer color number for shrouds
 - 7 Pull shape (see below under Required Selections)
 - 8 Options, if selected (see below)
- ▶ See *Surface Materials*, page 566.

	Required Selections	Price	Required to Specify
Depth	<ul style="list-style-type: none"> • 30"D • 36"D 	Prices at right Prices at right	Specify with 30"D. Specify with 36"D.
Width	<ul style="list-style-type: none"> • 60"W • 66"W • 72"W • 78"W • 84"W 	Prices at right Prices at right Prices at right Prices at right Prices at right	Specify with 60"W. Specify with 66"W. Specify with 72"W. Specify with 78"W. Specify with 84"W.

Pull Shape

Contemporary	Jazz	Bar	Nile	Integral*	Transitional	Inset	Beam
No cost	+\$19 each	+\$26 each	+\$26 each	+\$26 each	+\$26 each	+\$26 each	+\$37 each

*Not available on laminate or composite fronts.

Tip: For ease of specification, full-fill finish codes can be selected on other veneer components being used in settings with full-fill veneer top surfaces. The other components will not have the final fill coat applied, but the finish color will be consistent with the full-fill top surfaces.

For laminate price group 2 pricing, please refer to the electronic catalog or SmartTools.

	Options	Price	Required to Specify	
Surface Materials	Wood veneer top surface	<ul style="list-style-type: none"> • Wood group 2 • Wood group 3 • Full-fill finish on wood group 1 • Customiz stain 	Prices at right Prices at right Prices at right No cost	Specify wood color number. Specify wood color number. Specify full-fill finish number. Specify with <i>Customiz stain</i> .
	Laminate top surface	<ul style="list-style-type: none"> • Laminate price group 1 • Laminate price group 2 • Open Line laminate (OLL) 	-\$428 See information at left +\$ 69 plus cost of laminate	Specify laminate color number. Specify laminate color number. ▶ See <i>Surface Materials Reference Manual</i> .
	3 mm edge for 60"W-72"W laminate top surfaces	<ul style="list-style-type: none"> • Plastic • Wood group 2 • Wood group 3 • Full-fill finish on wood group 1 • Customiz stain 	No cost +\$ 69 +\$242 No cost No cost	Specify plastic color number. Specify wood color number. Specify wood color number. Specify full-fill finish number. Specify with <i>Customiz stain</i> .
	3 mm edge for 78"W-84"W laminate top surfaces	<ul style="list-style-type: none"> • Plastic • Wood group 2 • Wood group 3 • Full-fill finish on wood group 1 • Customiz stain 	No cost +\$ 96 +\$335 No cost No cost	Specify plastic color number. Specify wood color number. Specify wood color number. Specify full-fill finish number. Specify with <i>Customiz stain</i> .

▶ Options, continued on next page

► Options, continued from previous page

	Options	Price	Required to Specify
Surface Materials, continued	Wood veneer shroud case		
	• Wood group 2	+\$ 71	Specify wood color number.
	• Wood group 3	+\$ 244	Specify wood color number.
	• Full-fill finish on wood group 1	No cost	Specify full-fill finish number.
	• Customiz stain	No cost	Specify with <i>Customiz stain</i> .
	Laminate shroud case		
	• Laminate price group 1	-\$ 198	Specify laminate color number.
	• Laminate price group 2	See information at left	Specify laminate color number.
	• Open Line laminate (OLL)	+\$ 69 plus cost of laminate	► See <i>Surface Materials Reference Manual</i> .
	Wood veneer pedestal case		
	• Wood group 2	+\$ 71	Specify wood color number.
	• Wood group 3	+\$ 244	Specify wood color number.
	• Full-fill finish on wood group 1	No cost	Specify full-fill finish number.
	• Customiz stain	No cost	Specify with <i>Customiz stain</i> .
Laminate pedestal case			
• Laminate price group 1	-\$ 248	Specify laminate color number.	
• Laminate price group 2	See information at left	Specify laminate color number.	
• Open Line laminate (OLL)	+\$ 69 plus cost of laminate	► See <i>Surface Materials Reference Manual</i> .	
Wood veneer shroud front			
• Wood group 2	+\$ 28	Specify wood color number.	
• Wood group 3	+\$ 94	Specify wood color number.	
• Full-fill finish on wood group 1	No cost	Specify full-fill finish number.	
• Customiz stain	No cost	Specify with <i>Customiz stain</i> .	
Laminate shroud front			
• Laminate price group 1	-\$ 12	Specify laminate color number.	
• Laminate price group 2	See information at left	Specify laminate color number.	
• Open Line laminate (OLL)	No cost plus cost of laminate	► See <i>Surface Materials Reference Manual</i> .	
Wood veneer pedestal front			
• Wood group 2	+\$ 28	Specify wood color number.	
• Wood group 3	+\$ 94	Specify wood color number.	
• Full-fill finish on wood group 1	No cost	Specify full-fill finish number.	
• Customiz stain	No cost	Specify with <i>Customiz stain</i> .	
Laminate pedestal front			
• Laminate price group 1	-\$ 52	Specify laminate color number.	
• Laminate price group 2	See information at left	Specify laminate color number.	
• Open Line laminate (OLL)	No cost plus cost of laminate	► See <i>Surface Materials Reference Manual</i> .	
Wood veneer modesty panel			
• Wood group 2	Prices at right	Specify wood color number.	
• Wood group 3	Prices at right	Specify wood color number.	
• Full-fill finish on wood group 1	No cost	Specify full-fill finish number.	
• Customiz stain	No cost	Specify with <i>Customiz stain</i> .	
Laminate modesty panel			
• Laminate price group 1	-\$ 139	Specify laminate color number.	
• Laminate price group 2	See information at left	Specify laminate color number.	
• Open Line laminate (OLL)	+\$ 69 plus cost of laminate	► See <i>Surface Materials Reference Manual</i> .	
Worksurface Profile	Laminate top edge		
	• 3 mm plastic square	No cost	Specify plastic square edge finish number.
	• 3 mm wood square	+\$ 260	Specify wood square edge finish number.
Storage	• Shroud/shroud	No cost	Specify with <i>shroud/shroud</i> .
	• Shroud left/pedestal right	+\$1250	Specify with <i>shroud left/pedestal right</i> .
	• Shroud right/pedestal left	+\$1250	Specify with <i>shroud right/pedestal left</i> .
	• Pedestal/pedestal	+\$2500	Specify with <i>pedestal/pedestal</i> .

Tip: Option prices for wood veneer or laminate are per shroud or pedestal case. Each solution will have two charges, one for each side. Shroud and/or pedestal cases can only come in either wood veneer or laminate, not both.

Tip: Pedestal top or shroud top will match case finish.

For laminate price group 2 pricing, please refer to the electronic catalog or SmartTools.

Tip: Wood top must select wood square profile. Laminate top has the option of either a plastic square or wood square profile.

Tip: To see all possible storage configurations, see Elective Elements Specification Guide.

► Options, continued on next page

Height-Adjustable Desks, Full-Width Top, continued

SIN 711.2

► Options, continued from previous page

	Options	Price	Required to Specify
Lock and Keying	Lock		
	<ul style="list-style-type: none"> Ember chrome Polished chrome 	<ul style="list-style-type: none"> No cost No cost 	<ul style="list-style-type: none"> Specify with 9250 Ember Chrome lock. Specify with 9201 Polished Chrome lock.
	Keying		
	<ul style="list-style-type: none"> Factory- and field-installed keying units 		► Page 622
Floor Modesty Panel	<ul style="list-style-type: none"> No floor modesty panel Inset floor modesty panel Full-width floor modesty panel 	<ul style="list-style-type: none"> No cost Prices at right Prices at right 	<ul style="list-style-type: none"> Specify with no floor modesty panel. Specify with inset floor modesty panel. Specify with full-width floor modesty panel.
Hanging Modesty Panel	<ul style="list-style-type: none"> No hanging modesty panel Inset-hanging modesty panel Full-width hanging modesty panel 	<ul style="list-style-type: none"> No cost Prices at right Prices at right 	<ul style="list-style-type: none"> Specify with no hanging modesty panel. Specify with inset-hanging modesty panel. Specify with full-width hanging modesty panel.
Grain Direction	Veneer tops		
	<ul style="list-style-type: none"> Long grain Short grain 	<ul style="list-style-type: none"> No cost No cost 	<ul style="list-style-type: none"> Specify with long grain. Specify with short grain.
	Laminate tops		
	<ul style="list-style-type: none"> No grain direction Long grain Short grain (on 60"W) 	<ul style="list-style-type: none"> No cost No cost No cost 	<ul style="list-style-type: none"> Specify with no grain direction. Specify with long grain. Specify with short grain.
	Veneer storage and modesty panel		
	<ul style="list-style-type: none"> Horizontal grain Vertical grain 	<ul style="list-style-type: none"> No cost No cost 	<ul style="list-style-type: none"> Specify with horizontal grain. Specify with vertical grain.
	Laminate storage and modesty panel		
	<ul style="list-style-type: none"> No grain direction Horizontal grain Vertical grain 	<ul style="list-style-type: none"> No cost No cost No cost 	<ul style="list-style-type: none"> Specify with no grain direction. Specify with horizontal grain. Specify with vertical grain.

Tip: To see all possible floor and hanging modesty panel combinations, see Elective Elements Specification Guide.

Tip: Shroud top surface follows worksurface grain direction.

Tip: Short grain on laminate tops is only available on 60"W.

Tip: All modesty panels, with the exception of full-width hanging, are available on both 30"D and 36"D worksurfaces.

Tip: If a floor modesty panel is selected, then the grain direction of the storage and modesty panel must match. In the case of a laminate modesty panel greater than 60"W, then the grain direction on all pieces will be horizontal.

► For all available modesty panel configurations, see Elective Elements Specification Guide.

Modesty Panel Upcharges

Width	Options (Add \$ to Base Price)				Width	Options (Add \$ to Base Price)			
	Wood Group 1	Wood Group 2	Wood Group 3	Full-Fill Finish on Wood Group 1		Wood Group 1	Wood Group 2	Wood Group 3	Full-Fill Finish on Wood Group 1
60"	N.A.	N.A.	N.A.	N.A.	60"	N.A.	N.A.	N.A.	N.A.
66"	N.A.	N.A.	N.A.	N.A.	66"	N.A.	N.A.	N.A.	N.A.
72"	N.A.	N.A.	N.A.	N.A.	72"	N.A.	N.A.	N.A.	N.A.
78"	+\$469	+\$69	+\$242	No cost	78"	+\$512	+\$69	+\$242	No cost
84"	+\$512	+\$69	+\$242	No cost	84"	+\$556	+\$69	+\$242	No cost

Inset-Hanging Modesty Panel

For Use with Pedestal/Pedestal				
60"	N.A.	N.A.	N.A.	N.A.
66"	N.A.	N.A.	N.A.	N.A.
72"	N.A.	N.A.	N.A.	N.A.
78"	+\$469	+\$69	+\$242	No cost
84"	+\$512	+\$69	+\$242	No cost
For Use with Shroud/Pedestal				
60"	+\$469	+\$69	+\$242	No cost
66"	+\$512	+\$69	+\$242	No cost
72"	+\$556	+\$69	+\$242	No cost
78"	+\$600	+\$96	+\$335	No cost
84"	+\$643	+\$96	+\$335	No cost

Inset-Floor Modesty Panel

For Use with Pedestal/Pedestal				
60"	N.A.	N.A.	N.A.	N.A.
66"	N.A.	N.A.	N.A.	N.A.
72"	N.A.	N.A.	N.A.	N.A.
78"	+\$512	+\$69	+\$242	No cost
84"	+\$556	+\$69	+\$242	No cost
For Use with Shroud/Pedestal				
60"	+\$469	+\$69	+\$242	No cost
66"	+\$512	+\$69	+\$242	No cost
72"	+\$556	+\$69	+\$242	No cost
78"	+\$600	+\$96	+\$335	No cost
84"	+\$643	+\$96	+\$335	No cost

► Options, continued on next page

Tip: All modesty panels, with the exception of full-width hanging, are available on both 30"D and 36"D worksurfaces.

► For all available modesty panel configurations, see Elective Elements Specification Guide.

► Options, continued from previous page

Modesty Panel Upcharges, continued

Width	Options (Add \$ to Base Price)			
	Wood Group 1	Wood Group 2	Wood Group 3	Full-Fill Finish on Wood Group 1

Inset-Hanging Modesty Panel, continued

For Use with Shroud/Shroud				
60"	+\$556	+\$ 69	+\$242	No cost
66"	+\$600	+\$ 96	+\$335	No cost
72"	+\$643	+\$ 96	+\$335	No cost
78"	+\$685	+\$124	+\$436	No cost
84"	+\$728	+\$124	+\$436	No cost

Inset-Floor Modesty Panel, continued

For Use with Shroud/Shroud				
60"	+\$600	+\$ 96	+\$335	No cost
66"	+\$643	+\$ 96	+\$335	No cost
72"	+\$685	+\$124	+\$436	No cost
78"	+\$728	+\$124	+\$436	No cost
84"	+\$772	+\$157	+\$546	No cost

Full-Width Hanging Modesty Panel

For Use 36"D Worksurfaces				
60"	+\$685	+\$124	+\$436	No cost
66"	+\$728	+\$124	+\$436	No cost
72"	+\$772	+\$157	+\$546	No cost
78"	+\$870	+\$157	+\$546	No cost
84"	+\$934	+\$157	+\$546	No cost

Full-Width Floor Modesty Panel

For Use with 30"D and 36"D Worksurfaces				
60"	+\$685	+\$124	+\$436	No cost
66"	+\$728	+\$124	+\$436	No cost
72"	+\$772	+\$157	+\$546	No cost
78"	+\$870	+\$157	+\$546	No cost
84"	+\$934	+\$157	+\$546	No cost

Specification Information

Style Number	Width	Base Price	Options (Add \$ to Base Price)		
			Wood Group 2	Wood Group 3	Full-Fill Finish on Wood Group 1

30"D Worksurfaces

E6HADLS	Width	Base Price	Wood Group 2	Wood Group 3	Full-Fill Finish on Wood Group 1
	60"	\$6370	+\$69	+\$242	+\$69
	66"	\$6415	+\$69	+\$236	+\$69
	72"	\$6459	+\$69	+\$242	+\$69
	78"	\$6501	+\$96	+\$335	+\$96
	84"	\$6697	+\$96	+\$335	+\$96

36"D Worksurfaces

E6HADLS	Width	Base Price	Wood Group 2	Wood Group 3	Full-Fill Finish on Wood Group 1
	60"	\$6443	+\$96	+\$335	+\$96
	66"	\$6493	+\$96	+\$335	+\$96
	72"	\$6580	+\$96	+\$335	+\$96
	78"	\$6640	+\$96	+\$335	+\$96
	84"	\$6826	+\$96	+\$335	+\$96

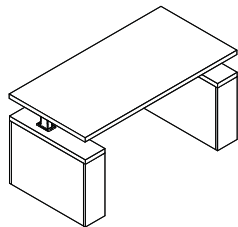

Elective Elements

Height-Adjustable Desks

Partial-Width Top

SIN 711.2

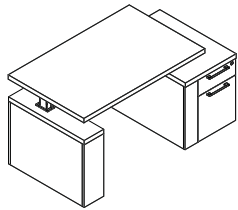

Standard Includes	Required to Specify
<ul style="list-style-type: none"> • Top: wood group 1 veneer • Base: paint • Pedestal/pedestal or shroud/pedestal: wood group 1 veneer • Edge: 3 mm wood square edge to match top • Three-preset controller • Standard close drawer slides • Lock, keyed random, if pedestal storage selected 	<ol style="list-style-type: none"> 1 Style number 2 Depth (see below under Required Selections) 3 Width (see below under Required Selections) 4 Wood veneer color number for top 5 Paint color number for base 6 Wood veneer color number for pedestal/pedestal or shroud/pedestal 7 Pull shape (see below under Required Selections) 8 Options, if selected (see below) <p>▶ See <i>Surface Materials</i>, page 566.</p>

Required Selections	Price	Required to Specify
Depth	<ul style="list-style-type: none"> • 30"D • 36"D 	Prices at right Prices at right Specify with 30"D. Specify with 36"D.
Width	<ul style="list-style-type: none"> • 60"W • 66"W • 72"W • 78"W • 84"W • 90"W • 96"W 	Prices at right Prices at right Prices at right Prices at right Prices at right Prices at right Prices at right Specify with 60"W. Specify with 66"W. Specify with 72"W. Specify with 78"W. Specify with 84"W. Specify with 90"W. Specify with 96"W.

Tip: 96" width is only available with pedestal/pedestal configuration. 60", 66", and 72" widths are only available with shroud/pedestal configuration.

Tip: With pedestal/pedestal configuration, 24" would be subtracted from the top width. With shroud/pedestal configuration, 12" would be subtracted from the top width.

Tip: For ease of specification, full-fill finish codes can be selected on other veneer components being used in settings with full-fill veneer top surfaces. The other components will not have the final fill coat applied, but the finish color will be consistent with the full-fill top surfaces.

For laminate price group 2 pricing, please refer to the electronic catalog or SmartTools.

Pull Shape	
Contemporary	Jazz
Bar	Nile
Integral*	Transitional
Inset	Beam
No cost	+\$19 each
+\$26 each	+\$26 each
+\$26 each	+\$26 each
+\$26 each	+\$26 each
+\$26 each	+\$26 each
+\$26 each	+\$26 each
+\$26 each	+\$37 each

*Not available on laminate or composite fronts.

Options	Price	Required to Specify
Surface Materials	Wood veneer top surfaces	
<ul style="list-style-type: none"> • Wood group 2 • Wood group 3 • Full-fill finish on wood group 1 • Customiz stain 	Prices at right Prices at right Prices at right No cost	Specify wood color number. Specify wood color number. Specify full-fill finish number. Specify with <i>Customiz stain</i> .
	Laminate top surfaces	
<ul style="list-style-type: none"> • Laminate • Laminate price group 2 • Open Line laminate (OLL) 	-\$428 See information at left +\$ 69 plus cost of laminate	Specify laminate color number. Specify laminate color number. ▶ See <i>Surface Materials Reference Manual</i> .
	Shroud/pedestal 3 mm edge for laminate top surface	
<ul style="list-style-type: none"> • Plastic • Wood group 2 • Wood group 3 • Full-fill finish on wood group 1 • Customiz stain 	No cost +\$ 69 +\$242 No cost No cost	Specify plastic color number. Specify wood color number. Specify wood color number. Specify full-fill finish number. Specify with <i>Customiz stain</i> .
	Pedestal/pedestal 3 mm edge for laminate top surface	
<ul style="list-style-type: none"> • Plastic • Wood group 2 • Wood group 3 • Full-fill finish on wood group 1 • Customiz stain 	No cost +\$ 96 +\$335 No cost No cost	Specify plastic color number. Specify wood color number. Specify wood color number. Specify full-fill finish number. Specify with <i>Customiz stain</i> .

▶ Options, continued on next page

► Options, continued from previous page

	Options	Price	Required to Specify
Surface Materials, continued	Wood veneer shroud case		
	• Wood group 2	+\$ 71	Specify wood color number.
	• Wood group 3	+\$ 244	Specify wood color number.
	• Full-fill finish on wood group 1	No cost	Specify full-fill finish number.
	• Customiz stain	No cost	Specify with <i>Customiz stain</i> .
	Laminate shroud case		
	• Laminate price group 1	-\$ 198	Specify laminate color number.
	• Laminate price group 2	See information at left	Specify laminate color number.
	• Open Line laminate (OLL)	+\$ 69 plus cost of laminate	► See <i>Surface Materials Reference Manual</i> .
	Wood veneer pedestal case		
	• Wood group 2	+\$ 71	Specify wood color number.
	• Wood group 3	+\$ 244	Specify wood color number.
	• Full-fill finish on wood group 1	No cost	Specify full-fill finish number.
	• Customiz stain	No cost	Specify with <i>Customiz stain</i> .
Laminate pedestal case			
• Laminate price group 1	-\$ 248	Specify laminate color number.	
• Laminate price group 2	See information at left	Specify laminate color number.	
• Open Line laminate (OLL)	+\$ 69 plus cost of laminate	► See <i>Surface Materials Reference Manual</i> .	
Wood veneer shroud front			
• Wood group 2	+\$ 28	Specify wood color number.	
• Wood group 3	+\$ 94	Specify wood color number.	
• Full-fill finish on wood group 1	No cost	Specify full-fill finish number.	
• Customiz stain	No cost	Specify with <i>Customiz stain</i> .	
Laminate shroud front			
• Laminate price group 1	-\$ 12	Specify laminate color number.	
• Laminate price group 2	See information at left	Specify laminate color number.	
• Open Line laminate (OLL)	No cost	► See <i>Surface Materials Reference Manual</i> .	
Wood veneer pedestal front			
• Wood group 2	+\$ 28	Specify wood color number.	
• Wood group 3	+\$ 94	Specify wood color number.	
• Full-fill finish on wood group 1	No cost	Specify full-fill finish number.	
• Customiz stain	No cost	Specify with <i>Customiz stain</i> .	
Laminate pedestal front			
• Laminate price group 1	-\$ 52	Specify laminate color number.	
• Laminate price group 2	See information at left	Specify laminate color number.	
• Open Line laminate (OLL)	No cost plus cost of laminate	► See <i>Surface Materials Reference Manual</i> .	
Wood veneer hanging modesty panel			
• Wood group 2	Prices at right	Specify wood color number.	
• Wood group 3	Prices at right	Specify wood color number.	
• Full-fill finish on wood group 1	No cost	Specify full-fill finish number.	
• Customiz stain	No cost	Specify with <i>Customiz stain</i> .	
Laminate hanging modesty panel			
• Laminate price group 1	-\$ 139	Specify laminate color number.	
• Laminate price group 2	See information at left	Specify laminate color number.	
• Open Line laminate (OLL)	+\$ 69 plus cost of laminate	► See <i>Surface Materials Reference Manual</i> .	
Worksurface Profile	Laminate top edge		
	• 3 mm plastic square	No cost	Specify plastic square edge finish number.
	• 3 mm wood square	+\$ 260	Specify wood square edge finish number.
Storage	• Shroud/shroud	No cost	Specify with <i>shroud/shroud</i> .
	• Shroud left/pedestal right	+\$1250	Specify with <i>shroud left/pedestal right</i> .
	• Shroud right/pedestal left	+\$1250	Specify with <i>shroud right/pedestal left</i> .
	• Pedestal/pedestal	+\$2500	Specify with <i>pedestal/pedestal</i> .

For laminate price group 2 pricing, please refer to the electronic catalog or SmartTools.

Tip: Wood top must select wood square profile. Laminate top has the option of either a plastic square or wood square profile.

Tip: To see all possible storage configurations, see Elective Elements Specification Guide.

► Options, continued on next page

Height-Adjustable Desks, Partial-Width Top, continued

SIN 711.2

► Options, continued from previous page

	Options	Price	Required to Specify
Lock and Keying	Lock		
	• Ember chrome • Polished chrome	No cost No cost	Specify with 9250 Ember Chrome lock. Specify with 9201 Polished Chrome lock.
	Keying		
	• Factory- and field-installed keying units		► Page 622
Floor Modesty Panel	• No floor modesty panel • Inset floor modesty panel • Full-width floor modesty panel	No cost Prices at right Prices at right	Specify with no floor modesty panel. Specify with inset floor modesty panel. Specify with full-width floor modesty panel.
Hanging Modesty Panel	• No hanging modesty panel • Inset-hanging modesty panel • Full-width hanging modesty panel	No cost Prices at right Prices at right	Specify with no hanging modesty panel. Specify with inset-hanging modesty panel. Specify with full-width hanging modesty panel.
Grain Direction	Veneer tops		
	• Long grain • Short grain	No cost No cost	Specify with long grain. Specify with short grain.
	Laminate tops		
	• No grain direction • Long grain • Short grain (on 60"W)	No cost No cost No cost	Specify with no grain direction. Specify with long grain. Specify with short grain.
	Veneer storage and modesty panel		
	• Horizontal grain • Vertical grain	No cost No cost	Specify with horizontal grain. Specify with vertical grain.
	Laminate storage and modesty panel		
	• No grain direction • Horizontal grain • Vertical grain	No cost No cost No cost	Specify with no grain direction. Specify with horizontal grain. Specify with vertical grain.

Tip: To see all possible floor and hanging modesty panel combinations, see Elective Elements Specification Guide.

Tip: Shroud top surface follows worksurface grain direction.

Tip: Short grain on laminate tops is only available on 60"W.

Tip: Full-width hanging modesty panel for use with shroud/pedestal and pedestal/pedestal only applies to 36" worksurfaces.

Modesty Panel Upcharges

Width	Options (Add \$ to Base Price)				Width	Options (Add \$ to Base Price)			
	Wood Group 1	Wood	Wood	Full-Fill Finish on Wood Group 1		Wood Group 1	Wood	Wood	Full-Fill Finish on Wood Group 1

Inset-Hanging Modesty Panel

For Use with Pedestal/Pedestal				
60"	N.A.	N.A.	N.A.	N.A.
66"	N.A.	N.A.	N.A.	N.A.
72"	N.A.	N.A.	N.A.	N.A.
78"	+\$469	+\$ 69	+\$242	No cost
84"	+\$512	+\$ 69	+\$242	No cost
90"	+\$556	+\$ 69	+\$242	No cost
96"	+\$600	+\$ 96	+\$335	No cost
For Use with Shroud/Pedestal				
60"	+\$469	+\$ 69	+\$242	No cost
66"	+\$512	+\$ 69	+\$242	No cost
72"	+\$556	+\$ 69	+\$242	No cost
78"	+\$600	+\$ 96	+\$335	No cost
84"	+\$643	+\$ 96	+\$335	No cost
90"	+\$685	+\$124	+\$436	No cost
96"	N.A.	N.A.	N.A.	N.A.

Inset-Floor Modesty Panel

For Use with Pedestal/Pedestal				
60"	N.A.	N.A.	N.A.	N.A.
66"	N.A.	N.A.	N.A.	N.A.
72"	N.A.	N.A.	N.A.	N.A.
78"	+\$512	+\$ 69	+\$242	No cost
84"	+\$556	+\$ 69	+\$242	No cost
90"	+\$600	+\$ 96	+\$335	No cost
96"	+\$643	+\$ 96	+\$335	No cost
For Use with Shroud/Pedestal				
60"	+\$469	+\$ 69	+\$242	No cost
66"	+\$512	+\$ 69	+\$242	No cost
72"	+\$556	+\$ 69	+\$242	No cost
78"	+\$600	+\$ 96	+\$335	No cost
84"	+\$643	+\$ 96	+\$335	No cost
90"	+\$685	+\$124	+\$436	No cost
96"	N.A.	N.A.	N.A.	N.A.

► Options, continued on next page

► Options, continued from previous page

Modesty Panel Upcharges, continued

Width	Options (Add \$ to Base Price)			
	Wood Group 1	Wood Group 2	Wood Group 3	Full-Fill Finish on Wood Group 1

Full-Width Hanging Modesty Panel

For Use Pedestal/Pedestal

Width	Wood Group 1	Wood Group 2	Wood Group 3	Full-Fill Finish on Wood Group 1
60"	N.A.	N.A.	N.A.	N.A.
66"	N.A.	N.A.	N.A.	N.A.
72"	N.A.	N.A.	N.A.	N.A.
78"	+\$643	+\$ 96	+\$335	No cost
84"	+\$685	+\$124	+\$436	No cost
90"	+\$728	+\$124	+\$436	No cost
96"	+\$772	+\$157	+\$546	No cost

For Use Shroud/Pedestal

60"	+\$600	+\$ 96	+\$335	No cost
66"	+\$643	+\$ 96	+\$335	No cost
72"	+\$685	+\$124	+\$436	No cost
78"	+\$728	+\$124	+\$436	No cost
84"	+\$772	+\$157	+\$546	No cost
90"	+\$870	+\$157	+\$546	No cost
96"	N.A.	N.A.	N.A.	N.A.

Full-Width Floor Modesty Panel

For Use with Pedestal/Pedestal

60"	N.A.	N.A.	N.A.	N.A.
66"	N.A.	N.A.	N.A.	N.A.
72"	N.A.	N.A.	N.A.	N.A.
78"	+\$ 870	+\$157	+\$546	No cost
84"	+\$ 934	+\$157	+\$546	No cost
90"	+\$1023	+\$157	+\$546	No cost
96"	+\$1088	+\$203	+\$709	No cost

For Use with Shroud/Pedestal

60"	+\$ 685	+\$124	+\$436	No cost
66"	+\$ 728	+\$124	+\$436	No cost
72"	+\$ 772	+\$157	+\$546	No cost
78"	+\$ 870	+\$157	+\$546	No cost
84"	+\$ 934	+\$157	+\$546	No cost
90"	+\$1023	+\$157	+\$546	No cost
96"	N.A.	N.A.	N.A.	N.A.

Specification Information

Style Number	Width	Base Price	Options (Add \$ to Base Price)		
			Wood		
			Wood Group 2	Wood Group 3	Full-Fill Finish on Wood Group 1

30"D Worksurfaces

For Use with Shroud/Pedestal

Style Number	Width	Base Price	Wood Group 2	Wood Group 3	Full-Fill Finish on Wood Group 1
E6HADLSP	60"	\$6280	+\$69	+\$242	+\$69
	66"	\$6325	+\$69	+\$242	+\$69
	72"	\$6370	+\$69	+\$242	+\$69
	78"	\$6415	+\$69	+\$242	+\$69
	84"	\$6459	+\$69	+\$242	+\$69
	90"	\$6501	+\$96	+\$335	+\$69

► Specification Information, continued on next page

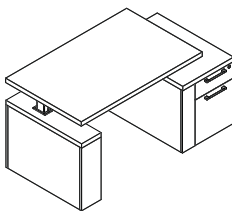

Height-Adjustable Desks, Partial-Width Top, continued

SIN 711.2

► Specification Information, continued from previous page

Specification Information			
Style Number	Width	Base Price	Options (Add \$ to Base Price)
			Wood
			Wood : Wood : Full-Fill Finish on
			Group 2 : Group 3 : Wood Group 1

30"D Worksurfaces, continued

For Use with Pedestal/Pedestal

E6HADLSP	Width	Base Price	Option 1	Option 2	Option 3
	78"	\$6325	+\$69	+\$242	+\$69
	84"	\$6370	+\$69	+\$242	+\$69
	90"	\$6415	+\$69	+\$242	+\$69
	96"	\$6459	+\$69	+\$242	+\$69

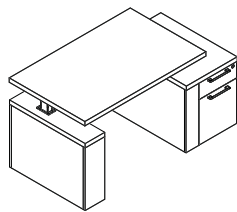

36"D Worksurfaces

For Use with Shroud/Pedestal

E6HADLSP	Width	Base Price	Option 1	Option 2	Option 3
	60"	\$6353	+\$96	+\$335	+\$69
	66"	\$6398	+\$96	+\$335	+\$69
	72"	\$6443	+\$96	+\$335	+\$69
	78"	\$6493	+\$96	+\$335	+\$69
	84"	\$6580	+\$96	+\$335	+\$69
	90"	\$6640	+\$96	+\$335	+\$69

For Use with Pedestal/Pedestal

E6HADLSP	Width	Base Price	Option 1	Option 2	Option 3
	78"	\$6398	+\$96	+\$335	+\$69
	84"	\$6443	+\$96	+\$335	+\$69
	90"	\$6493	+\$96	+\$335	+\$69
	96"	\$6580	+\$96	+\$335	+\$69

Specifying Elective Elements Worksurfaces

► For more detailed product information, see the *Elective Elements Wood Systems Furniture Specification Guide* or consult your Steelcase dealer.

Worksurfaces

Straight Worksurfaces (SIN 711.2)	210
Technology Straight Worksurfaces (SIN 711.2)	214
Desk Worksurfaces—Straight and Bow Fronts (SIN 711.2)	216
Technology Desk Worksurfaces—Straight (SIN 711.2)	218
Return Worksurfaces (SIN 711.2)	220
Desk Return Worksurfaces (SIN 711.2)	222
Bridge Worksurfaces (SIN 711.2)	224
Single Tapered Worksurfaces (SIN 711.2)	226
Tapered Worksurfaces—Single and Double, Run-Off (SIN 711.2)	228
Bullet Worksurfaces—Run-Off and Freestanding (SIN 711.2)	230
P-Top Worksurfaces—Run-Off and Freestanding (SIN 711.2)	232
Meeting Worksurfaces (SIN 711.2)	234
Extended Bullet Worksurfaces (SIN 711.2)	236
Corner Worksurfaces—Straight and Curved Front (SIN 711.2)	238
Extended Corner Worksurfaces (SIN 711.2)	240
Transaction Top Worksurfaces (SIN 711.2)	242
Personal Table Tops (SIN 711.2)	244
Worksurface Accessories (SIN 711.2)	246

Straight Worksurfaces

Wood Veneer or Laminate

SIN 711.2

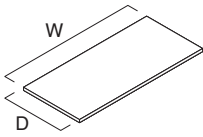

Standard Includes	Required to Specify
<ul style="list-style-type: none"> • Worksurface: wood group 1 veneer or laminate price group 1 • Wood group 1 worksurface with wood edge: <ul style="list-style-type: none"> –Solid wood edge on user’s side –Veneer edge on other sides • Laminate worksurface with plastic edge: <ul style="list-style-type: none"> –3 mm plastic edge on user’s side –1 mm plastic edge on other sides, plastic default to match user’s side • Laminate worksurface with wood edge: <ul style="list-style-type: none"> –Solid wood edge on user’s side –1 mm plastic edge on other sides, color default to match worksurface 	<ol style="list-style-type: none"> 1 Style number 2 Wood or laminate color number for worksurface 3 Wood or plastic edge color number for all sides on laminate worksurface, if selected 4 Worksurface profile (see below under Required Selections) 5 Options, if selected (see below) <p>▶ See <i>Surface Materials</i>, page 566.</p>

Required Selections (Prices at Right)

Wood Worksurface Edge Profiles			Laminate Worksurface Edge Profiles			
Wood Square Profile	Wood Bullnose Profile	Wood Blade Profile	Plastic Square Profile	Plastic Blade Profile	Wood Square Profile	Wood Bullnose Profile

Options	Price	Required to Specify
<p>Surface Materials</p> <p>Wood veneer worksurfaces</p> <ul style="list-style-type: none"> • Wood group 2 • Wood group 3 • Customiz stain • Full-fill finish on wood group 1 (not available on laminate worksurfaces with wood edge) <p>Laminate worksurfaces</p> <ul style="list-style-type: none"> • Laminate price group 2 • Open Line laminate • Wood group 2 on wood edge • Wood group 3 on wood edge • Customiz stain 	<p>Prices at right</p> <p>Prices at right</p> <p>No cost</p> <p>Prices at right</p> <hr/> <p>See information at left</p> <p>+\$ 69 plus cost of laminate</p> <p>Prices at right</p> <p>Prices at right</p> <p>No cost</p>	<p>Specify wood color number.</p> <p>Specify wood color number.</p> <p>Specify <i>with Customiz stain</i>.</p> <p>Specify wood veneer color number for worksurface.</p> <hr/> <p>Specify laminate color number.</p> <p>▶ See <i>Surface Materials Reference Manual</i>.</p> <p>Specify wood color number.</p> <p>Specify wood color number.</p> <p>Specify <i>with Customiz stain</i>.</p>
<p>Cable Management</p> <p>Round grommets</p> <ul style="list-style-type: none"> • Available on worksurfaces 54"W or smaller: metal • Available on worksurfaces 60"W or larger: metal <p>Square grommets</p> <ul style="list-style-type: none"> • Available on worksurfaces 54"W or smaller: aluminum door • Available on worksurfaces 60"W or larger: aluminum door <p>Scallop</p> <ul style="list-style-type: none"> • Available on center back only 	<p>+\$ 74</p> <p>+\$ 74</p> <p>+\$197</p> <p>+\$197</p> <p>+\$ 39</p>	<p>Center: <i>EGRC</i> and color number.</p> <p>Left: <i>EGRL</i> and color number.</p> <p>Right: <i>EGRR</i> and color number.</p> <p>Center: <i>EGRC</i> and color number.</p> <hr/> <p>Center: <i>EGSC</i> and color number.</p> <p>Left: <i>EGSL</i> and color number.</p> <p>Right: <i>EGSR</i> and color number.</p> <p>Center: <i>EGSC</i> and color number.</p> <hr/> <p>Specify <i>with scallop</i>.</p>
<p>Wood Veneer Short Grain Direction</p> <ul style="list-style-type: none"> • Available on wood veneer worksurfaces 	No cost	Specify <i>with short grain direction</i> .

For laminate price group 2 pricing, please refer to the electronic catalog or *SmartTools*.

Tip: Specify a scallop when a service module or hutch kit is used with a task light.

Tip: Refer to the selected panel Specification Guide to order supports for panel applications.



▶ Worksurface Edge Matrix in *Elective Elements Wood Systems Furniture Specification Guide*.

▶ Options, continued on next page

SIN 711.2

► Options, continued from previous page

Options		Required to Specify
Related Products	• Modesty panels	► Page 266
	• Plinth base and leg base end panels	► Pages 252–258 and 264–265
	• Gate leg	► Page 276
	• Perpendicular tether supports	► Page 271
	• Cable shroud supports	► Page 272
	• Adjustable-height legs	► Page 276
	• Plinth base and leg base storage	► Pages 281 and 347
	• Payback square legs	► See <i>Wood Casegoods and Tables Specification Guide</i> .

Specification Information										
Dimensions D W	Style Number	Base Prices						Options (Add \$ to Base Price)		
		Wood Group 1			Laminate Price Group 1			Wood		Full-Fill Finish on Wood Group 1
		Wood Square Edge	Wood Bullnose Edge	Wood Blade Edge	3 mm Plastic Square Edge	Laminate Blade Edge	Wood Square or Bullnose Edge	Wood Group 2	Wood Group 3	

Straight Worksurfaces

18"	30"	E6WS1830	\$ 509	\$ 613	\$ 661	\$220	\$319	\$ 386	+\$28	+\$ 94	+\$29
18"	36"	E6WS1836	\$ 522	\$ 626	\$ 674	\$233	\$332	\$ 399	+\$47	+\$164	+\$47
18"	42"	E6WS1842	\$ 577	\$ 681	\$ 729	\$251	\$372	\$ 453	+\$47	+\$164	+\$47
18"	48"	E6WS1848	\$ 624	\$ 728	\$ 776	\$298	\$419	\$ 500	+\$47	+\$164	+\$47
18"	54"	E6WS1854	\$ 646	\$ 750	\$ 798	\$320	\$441	\$ 522	+\$47	+\$164	+\$47
18"	60"	E6WS1860	\$ 705	\$ 809	\$ 857	\$342	\$484	\$ 579	+\$69	+\$242	+\$69
18"	66"	E6WS1866	\$ 748	\$ 852	\$ 900	\$385	\$527	\$ 622	+\$69	+\$242	+\$69
18"	72"	E6WS1872	\$ 800	\$ 904	\$ 952	\$437	\$579	\$ 674	+\$69	+\$242	+\$69
18"	78"	E6WS1878	\$ 842	\$ 946	\$ 994	\$479	\$621	\$ 716	+\$69	+\$242	+\$69
18"	84"	E6WS1884	\$1023	\$1127	\$1175	\$660	\$802	\$ 897	+\$69	+\$242	+\$69
18"	90"	E6WS1890	\$1193	\$1297	\$1345	\$830	\$972	\$1067	+\$69	+\$242	+\$69
24"	24"	E6WS2424	\$ 518	\$ 622	\$ 670	\$229	\$328	\$ 395	+\$28	+\$ 94	+\$29
24"	30"	E6WS2430	\$ 529	\$ 633	\$ 681	\$240	\$339	\$ 406	+\$28	+\$ 94	+\$29
24"	36"	E6WS2436	\$ 540	\$ 644	\$ 692	\$251	\$350	\$ 417	+\$47	+\$164	+\$47
24"	42"	E6WS2442	\$ 597	\$ 701	\$ 749	\$271	\$392	\$ 473	+\$47	+\$164	+\$47
24"	48"	E6WS2448	\$ 643	\$ 747	\$ 795	\$317	\$438	\$ 519	+\$47	+\$164	+\$47
24"	54"	E6WS2454	\$ 667	\$ 771	\$ 819	\$341	\$462	\$ 543	+\$47	+\$164	+\$47
24"	60"	E6WS2460	\$ 728	\$ 832	\$ 880	\$365	\$507	\$ 602	+\$69	+\$242	+\$69
24"	66"	E6WS2466	\$ 768	\$ 872	\$ 920	\$405	\$547	\$ 642	+\$69	+\$242	+\$69
24"	72"	E6WS2472	\$ 821	\$ 925	\$ 973	\$458	\$600	\$ 695	+\$69	+\$242	+\$69

► Specification Information, continued on next page

Straight Worksurfaces, Wood Veneer or Laminate, continued

SIN 711.2

► Specification Information, continued from previous page

Specification Information											
Dimensions D W	Style Number	Base Prices						Options (Add \$ to Base Price)			
		Wood Group 1			Laminate Price Group 1			Wood		Full-Fill Finish on Wood	
		Wood Square Edge	Wood Bullnose Edge	Wood Blade Edge	3 mm Plastic Square Edge	Laminate Blade Edge	Wood Square or Bullnose Edge	Wood Group 2	Wood Group 3	Group 1	Group 1

Straight Worksurfaces, continued

24"	78"	E6WS2478	\$ 859	\$ 963	\$1011	\$ 496	\$ 638	\$ 733	+\$ 69	+\$242	+\$ 69
24"	84"	E6WS2484	\$1043	\$1147	\$1195	\$ 680	\$ 822	\$ 917	+\$ 69	+\$242	+\$ 69
24"	90"	E6WS2490	\$1214	\$1318	\$1366	\$ 851	\$ 993	\$1088	+\$ 69	+\$242	+\$ 69
24"	96"	E6WS2496	\$1364	\$1468	\$1516	\$1001	\$1143	\$1238	+\$ 69	+\$242	+\$ 69
24"	102"	E6WS24102	\$1535	\$1639	\$1687	\$1136	\$1300	\$1410	+\$ 96	+\$335	+\$ 96
24"	108"	E6WS24108	\$1618	\$1722	\$1770	\$1219	\$1383	\$1493	+\$ 96	+\$335	+\$ 96
24"	114"	E6WS24114	\$1727	\$1831	\$1879	\$1328	\$1492	\$1602	+\$ 96	+\$335	+\$ 96
24"	120"	E6WS24120	\$1835	\$1939	\$1987	\$1436	\$1600	\$1710	+\$ 96	+\$335	+\$ 96
30"	24"	E6WS3024	\$ 593	\$ 697	\$ 745	\$ 304	\$ 403	\$ 470	+\$ 28	+\$ 94	+\$ 29
30"	30"	E6WS3030	\$ 613	\$ 717	\$ 765	\$ 324	\$ 423	\$ 490	+\$ 47	+\$164	+\$ 47
30"	36"	E6WS3036	\$ 631	\$ 735	\$ 783	\$ 342	\$ 441	\$ 508	+\$ 47	+\$164	+\$ 47
30"	42"	E6WS3042	\$ 685	\$ 789	\$ 837	\$ 359	\$ 480	\$ 561	+\$ 47	+\$164	+\$ 47
30"	48"	E6WS3048	\$ 735	\$ 839	\$ 887	\$ 409	\$ 530	\$ 611	+\$ 47	+\$164	+\$ 47
30"	54"	E6WS3054	\$ 761	\$ 865	\$ 913	\$ 435	\$ 556	\$ 637	+\$ 69	+\$242	+\$ 69
30"	60"	E6WS3060	\$ 826	\$ 930	\$ 978	\$ 463	\$ 605	\$ 700	+\$ 69	+\$242	+\$ 69
30"	66"	E6WS3066	\$ 871	\$ 975	\$1023	\$ 508	\$ 650	\$ 745	+\$ 69	+\$242	+\$ 69
30"	72"	E6WS3072	\$ 915	\$1019	\$1067	\$ 552	\$ 694	\$ 789	+\$ 69	+\$242	+\$ 69
30"	78"	E6WS3078	\$ 960	\$1064	\$1112	\$ 597	\$ 739	\$ 834	+\$ 69	+\$242	+\$ 69
30"	84"	E6WS3084	\$1154	\$1258	\$1306	\$ 791	\$ 933	\$1028	+\$ 69	+\$242	+\$ 69
30"	90"	E6WS3090	\$1333	\$1437	\$1485	\$ 970	\$1112	\$1207	+\$ 96	+\$335	+\$ 96
30"	96"	E6WS3096	\$1533	\$1637	\$1685	\$1170	\$1312	\$1407	+\$ 96	+\$335	+\$ 96
30"	102"	E6WS30102	\$1704	\$1808	\$1856	\$1305	\$1469	\$1579	+\$124	+\$436	+\$122
30"	108"	E6WS30108	\$1786	\$1890	\$1938	\$1387	\$1551	\$1661	+\$124	+\$436	+\$122
30"	114"	E6WS30114	\$1894	\$1998	\$2046	\$1495	\$1659	\$1769	+\$124	+\$436	+\$122
30"	120"	E6WS30120	\$2003	\$2107	\$2155	\$1604	\$1768	\$1878	+\$124	+\$436	+\$122
:	:	:	:	:	:	:	:	:	:	:	:

SIN 711.2

Technology Straight Worksurfaces

Wood Veneer or Laminate

SIN 711.2

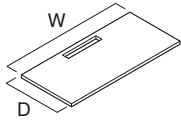

Standard Includes	Required to Specify
<ul style="list-style-type: none"> • Worksurface: wood group 1 veneer or laminate price group 1 • Wood group 1 worksurface with wood edge: <ul style="list-style-type: none"> –Solid wood edge on user’s side –Veneer edge on other sides • Laminate worksurface with plastic edge: <ul style="list-style-type: none"> –3 mm plastic edge on user’s side –1 mm plastic edge on other sides, plastic default to match user’s side • Laminate worksurface with wood edge: <ul style="list-style-type: none"> –Solid wood edge on user’s side –1 mm plastic edge on other sides, color default to match worksurface • One technology zone cut-out 	<ol style="list-style-type: none"> 1 Style number 2 Wood or laminate color number for worksurface 3 Wood or plastic edge color number for all sides on laminate worksurface, if selected 4 Worksurface profile (see below under Required Selections) 5 Technology zone cut-out location 6 Options, if selected (see below) <p>▶ See <i>Surface Materials</i>, page 566.</p>

Required Selections (Prices at Right)

Wood Worksurface Edge Profiles			Laminate Worksurface Edge Profiles			
Wood Square Profile	Wood Bullnose Profile	Wood Blade Profile	Plastic Square Profile	Plastic Blade Profile	Wood Square Profile	Wood Bullnose Profile

Options	Price	Required to Specify
<p>Surface Materials</p> <p>Wood veneer worksurfaces</p> <ul style="list-style-type: none"> • Wood group 2 • Wood group 3 • Customiz stain • Full-fill finish on wood group 1 <p>Laminate worksurfaces</p> <ul style="list-style-type: none"> • Laminate price group 2 • Open Line laminate • Wood group 2 on wood edge • Wood group 3 on wood edge • Customiz stain 	<p>Prices at right</p> <p>Prices at right</p> <p>No cost</p> <p>Prices at right</p> <hr/> <p>See information at left +\$69 plus cost of laminate</p> <p>Prices at right</p> <p>Prices at right</p> <p>No cost</p> <hr/> <p>No cost</p> <p>No cost</p>	<p>Specify wood color number.</p> <p>Specify wood color number.</p> <p>Specify <i>with Customiz stain</i>.</p> <p>Specify wood veneer color number for worksurface.</p> <hr/> <p>Specify laminate color number.</p> <p>▶ See <i>Surface Materials Reference Manual</i>.</p> <p>Specify wood color number.</p> <p>Specify wood color number.</p> <p>Specify <i>with Customiz stain</i>.</p> <hr/> <p>Left: <i>ET2L</i>.</p> <p>Center: <i>ET2C</i>.</p> <p>Right: <i>ET2R</i>.</p> <p>Left: <i>ET2L</i>.</p> <p>Right: <i>ET2R</i>.</p> <hr/> <p>Specify <i>with short grain direction</i>.</p>
<p>Technology Zone Cut-out</p> <ul style="list-style-type: none"> • Available on worksurfaces 42"W, 60"W, or larger • Available on worksurfaces 48"W or 54"W 	<p>No cost</p> <p>No cost</p>	<p>Left: <i>ET2L</i>.</p> <p>Center: <i>ET2C</i>.</p> <p>Right: <i>ET2R</i>.</p> <p>Left: <i>ET2L</i>.</p> <p>Right: <i>ET2R</i>.</p>
<p>Wood Veneer Short Grain Direction</p> <ul style="list-style-type: none"> • Available on wood veneer worksurfaces 	<p>No cost</p>	<p>Specify <i>with short grain direction</i>.</p>

Tip: No factory-installed grommets are available on technology worksurfaces. 2 1/2" round grommets are recommended.

For laminate price group 2 pricing, please refer to the electronic catalog or SmartTools.

Tip: Only one technology zone cut-out per worksurface.

Tip: Technology zone cut-outs are unfinished.

Tip: Refer to the selected panel Specification Guide to order supports for panel applications.



<p>Related Products</p> <ul style="list-style-type: none"> • Modesty panels • Plinth base and leg base end panels • Gate leg • Rectangular column leg • Column • Disk column • Adjustable-height legs • Plinth base and leg base storage • Payback square legs <p>• Technology zone</p>	<p>▶ Page 266</p> <p>▶ Pages 252–258 and 264–265</p> <p>▶ Page 276</p> <p>▶ Page 276</p> <p>▶ Page 276</p> <p>▶ Page 276</p> <p>▶ Page 277</p> <p>▶ Pages 281 and 347</p> <p>▶ See <i>Wood Casegoods and Tables Specification Guide</i>.</p> <p>▶ Page 556</p>
---	--

Specification Information											
Dimensions D W	Style Number	Base Prices						Options (Add \$ to Base Price)			
		Wood Group 1			Laminate Price Group 1			Wood		Full-Fill Finish on Wood	
		Wood Square Edge	Wood Bullnose Edge	Wood Blade Edge	3 mm Plastic Square Edge	Laminate Blade Edge	Wood Square or Bullnose Edge	Wood Group 2	Wood Group 3	Group 1	Group 1

Straight Worksurfaces

Technology											
18"	42"	E6WS1842T	\$ 634	\$ 738	\$ 786	\$ 308	\$ 429	\$ 510	+\$47	+\$164	+\$47
18"	48"	E6WS1848T	\$ 681	\$ 785	\$ 833	\$ 355	\$ 476	\$ 557	+\$47	+\$164	+\$47
18"	54"	E6WS1854T	\$ 703	\$ 807	\$ 855	\$ 377	\$ 498	\$ 579	+\$47	+\$164	+\$47
18"	60"	E6WS1860T	\$ 762	\$ 866	\$ 914	\$ 399	\$ 541	\$ 636	+\$69	+\$242	+\$69
18"	66"	E6WS1866T	\$ 805	\$ 909	\$ 957	\$ 442	\$ 584	\$ 679	+\$69	+\$242	+\$69
18"	72"	E6WS1872T	\$ 857	\$ 961	\$1009	\$ 494	\$ 636	\$ 731	+\$69	+\$242	+\$69
18"	78"	E6WS1878T	\$ 899	\$1003	\$1051	\$ 536	\$ 678	\$ 773	+\$69	+\$242	+\$69
18"	84"	E6WS1884T	\$1080	\$1184	\$1232	\$ 717	\$ 859	\$ 954	+\$69	+\$242	+\$69
18"	90"	E6WS1890T	\$1250	\$1354	\$1402	\$ 887	\$1029	\$1124	+\$69	+\$242	+\$69
24"	42"	E6WS2442T	\$ 654	\$ 758	\$ 806	\$ 328	\$ 449	\$ 530	+\$47	+\$164	+\$47
24"	48"	E6WS2448T	\$ 700	\$ 804	\$ 852	\$ 374	\$ 495	\$ 576	+\$47	+\$164	+\$47
24"	54"	E6WS2454T	\$ 724	\$ 828	\$ 876	\$ 398	\$ 519	\$ 600	+\$47	+\$164	+\$47
24"	60"	E6WS2460T	\$ 785	\$ 889	\$ 937	\$ 422	\$ 564	\$ 659	+\$69	+\$242	+\$69
24"	66"	E6WS2466T	\$ 825	\$ 929	\$ 977	\$ 462	\$ 604	\$ 699	+\$69	+\$242	+\$69
24"	72"	E6WS2472T	\$ 878	\$ 982	\$1030	\$ 515	\$ 657	\$ 752	+\$69	+\$242	+\$69
24"	78"	E6WS2478T	\$ 916	\$1020	\$1068	\$ 553	\$ 695	\$ 790	+\$69	+\$242	+\$69
24"	84"	E6WS2484T	\$1100	\$1204	\$1252	\$ 737	\$ 879	\$ 974	+\$69	+\$242	+\$69
24"	90"	E6WS2490T	\$1271	\$1375	\$1423	\$ 908	\$1050	\$1145	+\$69	+\$242	+\$69
24"	96"	E6WS2496T	\$1421	\$1525	\$1573	\$1058	\$1200	\$1295	+\$69	+\$242	+\$69
24"	102"	E6WS24102T	\$1592	\$1696	\$1744	\$1193	\$1357	\$1467	+\$96	+\$335	+\$96
24"	108"	E6WS24108T	\$1675	\$1779	\$1827	\$1276	\$1440	\$1550	+\$96	+\$335	+\$96
24"	114"	E6WS24114T	\$1784	\$1888	\$1936	\$1385	\$1549	\$1659	+\$96	+\$335	+\$96
24"	120"	E6WS24120T	\$1892	\$1996	\$2044	\$1493	\$1657	\$1767	+\$96	+\$335	+\$96

Elective Elements

Desk Worksurfaces—Straight and Bow Fronts

Wood Veneer or Laminate

SIN 711.2

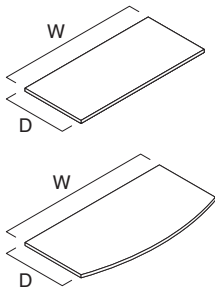

Tip: Any bow-front desk worksurface with an overhang must use a plinth base J-shape end panel and plinth base pedestal combination. The exception is when a return worksurface is attached to a straight or bow-front desk worksurface, then an overhang of no greater than 12" is allowed.

For laminate price group 2 pricing, please refer to the electronic catalog or SmartTools.

Tip: Grommets on desks with inset modesty panels should only be ordered in right or left position.

Tip: Recommended column and leg supports vary based on worksurface length and the support used on the opposite end. Refer to Worksurface Support Guidelines in Elective Elements Wood Systems Furniture Specifications Guide.

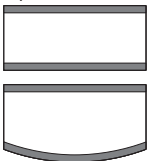

► Worksurface Edge Matrix in *Elective Elements Wood Systems Furniture Specification Guide*.

Standard Includes	Required to Specify
-------------------	---------------------

<ul style="list-style-type: none"> • Worksurface: wood group 1 veneer or laminate price group 1 • Wood group 1 worksurface with wood edge: <ul style="list-style-type: none"> –Solid wood edge on user and visitor’s side –Veneer edge on other sides • Laminate worksurface with plastic edge: <ul style="list-style-type: none"> –3 mm plastic edge on user and visitor’s side –1 mm plastic edge on other sides, plastic default to match user’s side • Laminate worksurface with wood edge: <ul style="list-style-type: none"> –Solid wood edge on user and visitor’s side –1 mm plastic edge on other sides, color default to match worksurface 	<ol style="list-style-type: none"> 1 Style number 2 Wood or laminate color number for worksurface 3 Wood or plastic edge color number for all sides on laminate worksurface, if selected 4 Worksurface profile (see below under Required Selections) 5 Options, if selected (see below) <p>► See <i>Surface Materials</i>, page 566.</p>
---	---

Required Selections (Prices at Right)

Wood Worksurface Edge Profiles			Laminate Worksurface Edge Profiles			
Wood Square Profile	Wood Bullnose Profile	Wood Blade Profile	Plastic Square Profile	Plastic Blade Profile	Wood Square Profile	Wood Bullnose Profile

Options	Price	Required to Specify
---------	-------	---------------------

<p>Surface Materials</p> <p>Wood veneer worksurfaces</p> <ul style="list-style-type: none"> • Wood group 2 • Wood group 3 • Customiz stain • Full-fill finish on wood group 1 (not available on laminate worksurfaces with wood edge) <p>Laminate worksurfaces</p> <ul style="list-style-type: none"> • Laminate price group 2 • Open Line laminate • Wood group 2 on wood edge • Wood group 3 on wood edge • Customiz stain 	<p>Prices at right</p> <p>Prices at right</p> <p>No cost</p> <p>Prices at right</p> <p>See information at left +\$ 69 plus cost of laminate</p> <p>Prices at right</p> <p>Prices at right</p> <p>No cost</p>	<p>Specify wood color number.</p> <p>Specify wood color number.</p> <p>Specify <i>with Customiz stain</i>.</p> <p>Specify wood veneer color number for worksurface.</p> <p>Specify laminate color number.</p> <p>► See <i>Surface Materials Reference Manual</i>.</p> <p>Specify wood color number.</p> <p>Specify wood color number.</p> <p>Specify <i>with Customiz stain</i>.</p>
--	--	--

Cable Management	Overhang grommets (for 30"D or 36"D worksurfaces that overhang)	Round grommets
------------------	---	----------------

<p>Round grommets</p> <ul style="list-style-type: none"> • Available on worksurfaces: metal <p>Square grommets</p> <ul style="list-style-type: none"> • Available on worksurfaces: aluminum or aluminum door <p>Rear grommets (only available on 30"D worksurfaces without an overhang)</p> <p>Round grommets</p> <ul style="list-style-type: none"> • Available on worksurfaces: metal <p>Square grommets</p> <ul style="list-style-type: none"> • Available on worksurfaces: aluminum or aluminum door 	<p>+\$ 74</p> <p>+\$197</p> <p>+\$ 74</p> <p>+\$197</p>	<p>Left: <i>EGRHL</i> and color number.</p> <p>Right: <i>EGRHR</i> and color number.</p> <p>Center: <i>EGRHC</i> and color number.</p> <p>Left: <i>EGSHL</i> and color number.</p> <p>Right: <i>EGSHR</i> and color number.</p> <p>Center: <i>EGSHC</i> and color number.</p> <p>Left: <i>EGRL</i> and color number.</p> <p>Right: <i>EGRR</i> and color number.</p> <p>Center: <i>EGRC</i> and color number.</p> <p>Left: <i>EGSL</i> and color number.</p> <p>Right: <i>EGSR</i> and color number.</p> <p>Center: <i>EGSC</i> and color number.</p>
---	---	---

► Options, continued on next page

► Options, continued from previous page

Related Products

- Modesty panels
 - Plinth base and leg base end panels
 - Gate leg
 - Perpendicular tether supports
 - Cable shroud supports
 - Adjustable-height legs
 - Plinth base and leg base storage
 - Payback square legs
- Page 266
 - Pages 252–258 and 264–265
 - Page 276
 - Page 271
 - Page 272
 - Page 277
 - Pages 281 and 347
 - See *Wood Casegoods and Tables Specification Guide*.

Specification Information

Dimensions		Style Number	Base Prices						Options			
D	W		Wood Group 1			Laminate Price Group 1			Wood		Full-Fill	
				Wood Square Edge	Wood Bullnose Edge	Wood Blade Edge	3 mm Plastic Square Edge	Laminate Blade Edge	Wood Square or Bullnose Edge	Wood Group 2	Wood Group 3	Finish on Wood Group 1

Straight-Front Desk Worksurfaces

24"	60"	E6WD2460	\$ 852	\$ 990	\$1058	\$ 424	\$ 581	\$ 684	+\$ 69	+\$242	+\$ 69
24"	66"	E6WD2466	\$ 909	\$1047	\$1115	\$ 481	\$ 638	\$ 741	+\$ 69	+\$242	+\$ 69
24"	72"	E6WD2472	\$ 946	\$1084	\$1152	\$ 518	\$ 675	\$ 778	+\$ 69	+\$242	+\$ 69
24"	78"	E6WD2478	\$ 986	\$1124	\$1192	\$ 558	\$ 715	\$ 818	+\$ 69	+\$242	+\$ 69
24"	84"	E6WD2484	\$1169	\$1307	\$1375	\$ 741	\$ 898	\$1001	+\$ 69	+\$242	+\$ 69
24"	90"	E6WD2490	\$1338	\$1476	\$1544	\$ 910	\$1067	\$1170	+\$ 69	+\$242	+\$ 69
30"	60"	E6WD3060	\$ 953	\$1091	\$1159	\$ 525	\$ 682	\$ 785	+\$ 69	+\$242	+\$ 69
30"	66"	E6WD3066	\$ 998	\$1136	\$1204	\$ 570	\$ 727	\$ 830	+\$ 69	+\$242	+\$ 69
30"	72"	E6WD3072	\$1042	\$1180	\$1248	\$ 614	\$ 771	\$ 874	+\$ 69	+\$242	+\$ 69
30"	78"	E6WD3078	\$1084	\$1222	\$1290	\$ 656	\$ 813	\$ 916	+\$ 96	+\$335	+\$ 96
30"	84"	E6WD3084	\$1280	\$1418	\$1486	\$ 852	\$1009	\$1112	+\$ 96	+\$335	+\$ 96
30"	90"	E6WD3090	\$1460	\$1598	\$1666	\$1032	\$1189	\$1292	+\$ 96	+\$335	+\$ 96
36"	66"	E6WD3666	\$1076	\$1214	\$1282	\$ 648	\$ 805	\$ 908	+\$ 96	+\$335	+\$ 96
36"	72"	E6WD3672	\$1163	\$1301	\$1369	\$ 735	\$ 892	\$ 995	+\$ 96	+\$335	+\$ 96
36"	78"	E6WD3678	\$1223	\$1361	\$1429	\$ 795	\$ 952	\$1055	+\$ 96	+\$335	+\$ 96
36"	84"	E6WD3684	\$1409	\$1547	\$1615	\$ 981	\$1138	\$1241	+\$ 96	+\$335	+\$ 96
36"	90"	E6WD3690	\$1607	\$1745	\$1813	\$1179	\$1336	\$1439	+\$ 96	+\$335	+\$ 96

Bow-Front Desk Worksurfaces

30"/36"	66"	E6WW303666	\$1123	\$1287	\$1365	\$ 602	\$ 763	\$ 870	+\$ 69	+\$242	+\$ 69
30"/36"	72"	E6WW303672	\$1169	\$1333	\$1411	\$ 648	\$ 809	\$ 916	+\$ 69	+\$242	+\$ 69
36"/42"	72"	E6WW364272	\$1326	\$1490	\$1568	\$ 805	\$ 966	\$1073	+\$ 96	+\$335	+\$ 96
36"/42"	78"	E6WW364278	\$1386	\$1550	\$1628	\$ 865	\$1026	\$1133	+\$ 96	+\$335	+\$ 96
36"/42"	84"	E6WW364284	\$1531	\$1695	\$1773	\$1010	\$1171	\$1278	+\$124	+\$436	+\$122

Tip: 36"/42" bow-front desk worksurfaces must be supported by 30"D pedestals or end panels.

Tip: When used in a single pedestal desk configuration, specify pedestal and end panel 6" less than the depth of the desk worksurface. This will create an overhang condition.

Technology Desk Worksurfaces—Straight

Wood Veneer or Laminate

SIN 711.2

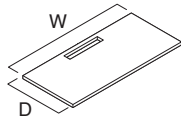

Standard Includes

- Worksurface: wood group 1 veneer or laminate price group 1
- Wood group 1 worksurface with wood edge:
 - Solid wood edge on user and visitor’s side
 - Veneer edge on other sides
- Laminate worksurface with plastic edge:
 - 3 mm plastic edge on user and visitor’s side
 - 1 mm plastic edge on other sides, plastic default to match user’s side
- Laminate worksurface with wood edge:
 - Solid wood edge on user and visitor’s side
 - 1 mm plastic edge on other sides, color default to match worksurface
- One technology zone cut-out

Required to Specify

- 1 Style number
 - 2 Wood or laminate color number for worksurface
 - 3 Wood or plastic edge color number for all sides on laminate worksurface, if selected
 - 4 Worksurface profile (see below under Required Selections)
 - 5 Technology zone cut-out location
 - 6 Options, if selected (see below)
- ▶ See *Surface Materials*, page 566.

Required Selections (Prices at Right)

Wood Worksurface Edge Profiles

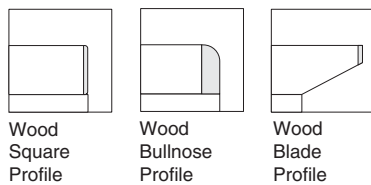

Wood Square Profile Wood Bullnose Profile Wood Blade Profile

Laminate Worksurface Edge Profiles

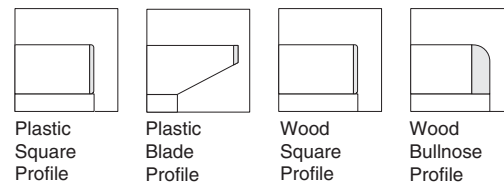

Plastic Square Profile Plastic Blade Profile Wood Square Profile Wood Bullnose Profile

Options

Options	Price	Required to Specify
Surface Materials Wood veneer worksurfaces <ul style="list-style-type: none"> • Wood group 2 • Wood group 3 • Customiz stain • Full-fill finish on wood group 1 	Prices at right Prices at right No cost Prices at right	Specify wood color number. Specify wood color number. Specify <i>with Customiz stain</i> . Specify wood veneer color number for worksurface.
Laminate worksurfaces <ul style="list-style-type: none"> • Laminate price group 2 • Open Line laminate • Wood group 2 on wood edge • Wood group 3 on wood edge • Customiz stain 	See information at left +\$69 plus cost of laminate Prices at right Prices at right No cost	Specify laminate color number. ▶ See <i>Surface Materials Reference Manual</i> . Specify wood color number. Specify wood color number. Specify <i>with Customiz stain</i> .
Technology Zone Cut-out <ul style="list-style-type: none"> • Available on worksurfaces 	No cost	Center: ET2C

Tip: No factory-installed grommets are available on technology worksurfaces. 2 1/2" round grommets are recommended.

For laminate price group 2 pricing, please refer to the electronic catalog or SmartTools.

Tip: Only one technology zone cut-out location per worksurface can be specified.

Tip: Technology zone cut-outs are unfinished.



Tip: Recommended column and leg supports vary based on worksurface length and support conditions on the other end. Refer to Worksurface Support Guidelines in Elective Elements Wood Systems Furniture Specifications Guide.

Related Products

- Modesty panels
 - Plinth base and leg base end panels
 - Gate leg
 - Perpendicular tether supports
 - Cable shroud supports
 - Rectangular column leg
 - Column
 - Disk column
 - Adjustable-height legs
 - Plinth base and leg base storage
 - Payback square legs
 - Technology zone
- ▶ Page 266
 ▶ Pages 252–258 and 264–265
 ▶ Page 276
 ▶ Page 271
 ▶ Page 272
 ▶ Page 276
 ▶ Page 276
 ▶ Page 276
 ▶ Page 277
 ▶ Pages 281 and 347
 ▶ See *Wood Casegoods and Tables Specification Guide*.
 ▶ Page 556

Specification Information

Dimensions		Style Number	Base Prices						Options		
D	W		Wood Group 1			Laminate Price Group 1			Wood		Full-Fill
			Wood Square Edge	Wood Bullnose Edge	Wood Blade Edge	3 mm Plastic Square Edge	Laminate Blade Edge	Wood Square or Bullnose Edge	Wood Group 2	Wood Group 3	Finish on Wood Group 1

Straight-Front Desk Worksurfaces

Technology											
24"	60"	E6WD2460T	\$ 909	\$1047	\$1115	\$ 481	\$ 638	\$ 741	+\$69	+\$242	+\$69
24"	66"	E6WD2466T	\$ 966	\$1104	\$1172	\$ 538	\$ 695	\$ 798	+\$69	+\$242	+\$69
24"	72"	E6WD2472T	\$1003	\$1141	\$1209	\$ 575	\$ 732	\$ 835	+\$69	+\$242	+\$69
24"	78"	E6WD2478T	\$1043	\$1181	\$1249	\$ 615	\$ 772	\$ 875	+\$69	+\$242	+\$69
24"	84"	E6WD2484T	\$1226	\$1364	\$1432	\$ 798	\$ 955	\$1058	+\$69	+\$242	+\$69
24"	90"	E6WD2490T	\$1395	\$1533	\$1601	\$ 967	\$1124	\$1227	+\$69	+\$242	+\$69
30"	60"	E6WD3060T	\$1010	\$1148	\$1216	\$ 582	\$ 739	\$ 842	+\$69	+\$242	+\$69
30"	66"	E6WD3066T	\$1055	\$1193	\$1261	\$ 627	\$ 784	\$ 887	+\$69	+\$242	+\$69
30"	72"	E6WD3072T	\$1099	\$1237	\$1305	\$ 671	\$ 828	\$ 931	+\$69	+\$242	+\$69
30"	78"	E6WD3078T	\$1141	\$1279	\$1347	\$ 713	\$ 870	\$ 973	+\$96	+\$335	+\$96
30"	84"	E6WD3084T	\$1337	\$1475	\$1543	\$ 909	\$1066	\$1169	+\$96	+\$335	+\$96
30"	90"	E6WD3090T	\$1517	\$1655	\$1723	\$1089	\$1246	\$1349	+\$96	+\$335	+\$96
36"	66"	E6WD3666T	\$1133	\$1271	\$1339	\$ 705	\$ 862	\$ 965	+\$96	+\$335	+\$96
36"	72"	E6WD3672T	\$1220	\$1358	\$1426	\$ 792	\$ 949	\$1052	+\$96	+\$335	+\$96
36"	78"	E6WD3678T	\$1280	\$1418	\$1486	\$ 852	\$1009	\$1112	+\$96	+\$335	+\$96
36"	84"	E6WD3684T	\$1466	\$1604	\$1672	\$1038	\$1195	\$1298	+\$96	+\$335	+\$96
36"	90"	E6WD3690T	\$1664	\$1802	\$1870	\$1236	\$1393	\$1496	+\$96	+\$335	+\$96



Return Worksurfaces

Wood Veneer or Laminate

SIN 711.2

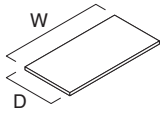

Standard Includes	Required to Specify
<ul style="list-style-type: none"> • Worksurface: wood group 1 veneer or laminate price group 1 • Wood group 1 worksurface with wood edge: <ul style="list-style-type: none"> –Solid wood edge on user’s side –Veneer edge on other sides (unless coped) • Laminate worksurface with plastic edge: <ul style="list-style-type: none"> –3 mm plastic edge on user’s side –1 mm plastic edge on other sides, plastic default to match user’s side • Laminate worksurface with wood edge: <ul style="list-style-type: none"> –Solid wood edge on user’s side –1 mm plastic edge on other sides (unless coped), color default to match worksurface • One end of the return worksurface is coped to fit into adjoining worksurface when specified with bullnose or blade edge profile • Attachment hardware: black paint only • End panel to modesty panel attachment bracket: black paint only 	<ol style="list-style-type: none"> 1 Style number 2 Wood or laminate color number for worksurface 3 Wood or plastic edge color number for all sides on laminate worksurface, if selected 4 Worksurface profile (see below under Required Selections) 5 Options, if selected (see below) <p>▶ See <i>Surface Materials</i>, page 566.</p>

Required Selections (Prices at Right)

Wood Worksurface Edge Profiles			Laminate Worksurface Edge Profiles			
Wood Square Profile	Wood Bullnose Profile	Wood Blade Profile	Plastic Square Profile	Plastic Blade Profile	Wood Square Profile	Wood Bullnose Profile

Options	Price	Required to Specify
<p>Surface Materials</p> <p>Wood veneer worksurfaces</p> <ul style="list-style-type: none"> • Wood group 2 • Wood group 3 • Customiz stain • Full-fill finish on wood group 1 (not available on laminate worksurfaces with wood edge) <p>Laminate worksurfaces</p> <ul style="list-style-type: none"> • Laminate price group 2 • Open Line laminate • Wood group 2 on wood edge • Wood group 3 on wood edge • Customiz stain 	<p>Prices at right</p> <p>Prices at right</p> <p>No cost</p> <p>Prices at right</p> <hr/> <p>See information at left +\$ 69 plus cost of laminate</p> <p>Prices at right</p> <p>Prices at right</p> <p>No cost</p>	<p>Specify wood color number.</p> <p>Specify wood color number.</p> <p>Specify <i>with Customiz stain</i>.</p> <p>Specify wood veneer color number for worksurface.</p> <hr/> <p>Specify laminate color number.</p> <p>▶ See <i>Surface Materials Reference Manual</i>.</p> <p>Specify wood color number.</p> <p>Specify wood color number.</p> <p>Specify <i>with Customiz stain</i>.</p>
<p>Cable Management</p> <p>Round grommets</p> <ul style="list-style-type: none"> • Available on all worksurfaces, except left and right grommet not available on 48"W or smaller worksurfaces: metal <p>Square grommets</p> <ul style="list-style-type: none"> • Available on all worksurfaces, except left and right grommet not available on 48"W or smaller worksurfaces: aluminum door <p>Scalloped</p> <ul style="list-style-type: none"> • Available on center back only 	<p>+\$ 74</p> <p>+\$197</p> <p>+\$ 39</p>	<p>Left: <i>EGRL</i> and color number.</p> <p>Right: <i>EGRR</i> and color number.</p> <p>Center: <i>EGRC</i> and color number.</p> <hr/> <p>Left: <i>EGSL</i> and color number.</p> <p>Right: <i>EGSR</i> and color number.</p> <p>Center: <i>EGSC</i> and color number.</p> <hr/> <p>Specify <i>with scallop</i>.</p>
<p>Wood Veneer Short Grain Direction</p> <ul style="list-style-type: none"> • Available on wood veneer worksurfaces 	No cost	Specify <i>with short grain direction</i> .

For laminate price group 2 pricing, please refer to the electronic catalog or SmartTools.

Tip: Specify a scallop when a service module or hutch kit is used with a task light.

Tip: Refer to the selected panel Specification Guide to order supports for panel applications.

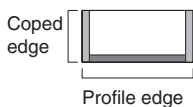

▶ Worksurface Edge Matrix in *Elective Elements Wood Systems Furniture Specification Guide*.

▶ Options, continued on next page

SIN 711.2

► Options, continued from previous page

Options	Price	Required to Specify
Related Products	<ul style="list-style-type: none"> • Modesty panels • Plinth base and leg base end panels • Adjustable-height legs • Plinth base and leg base storage • Payback square legs 	<ul style="list-style-type: none"> ► Page 266 ► Pages 252–258 and 264–265 ► Page 276 ► Pages 281 and 347 ► See <i>Wood Casegoods and Tables Specification Guide</i>.

Specification Information											
Dimensions D W	Style Number	Base Prices						Options (Add \$ to Base Price)			
		Wood Group 1			Laminate Price Group 1			Wood			Full-Fill Finish on Wood Group 1
		Wood Square Edge	Wood Bullnose Edge	Wood Blade Edge	3 mm Plastic Square Edge	Laminate Blade Edge	Wood Square or Bullnose Edge	Wood Group 2	Wood Group 3		

Return Worksurfaces

Left-Hand (coped on right side)

18"	30"	E6WR1830L	\$601	\$ 733	\$ 801	\$202	\$336	\$426	+\$47	+\$164	+\$47
18"	36"	E6WR1836L	\$616	\$ 748	\$ 816	\$217	\$351	\$441	+\$47	+\$164	+\$47
18"	42"	E6WR1842L	\$683	\$ 815	\$ 883	\$284	\$418	\$508	+\$47	+\$164	+\$47
18"	48"	E6WR1848L	\$736	\$ 868	\$ 936	\$337	\$471	\$561	+\$47	+\$164	+\$47
18"	60"	E6WR1860L	\$833	\$ 965	\$1033	\$434	\$568	\$658	+\$47	+\$164	+\$47
18"	72"	E6WR1872L	\$944	\$1076	\$1144	\$545	\$679	\$769	+\$69	+\$242	+\$69
24"	30"	E6WR2430L	\$633	\$ 765	\$ 833	\$234	\$368	\$458	+\$47	+\$164	+\$47
24"	36"	E6WR2436L	\$647	\$ 779	\$ 847	\$248	\$382	\$472	+\$47	+\$164	+\$47
24"	42"	E6WR2442L	\$704	\$ 836	\$ 904	\$305	\$439	\$529	+\$47	+\$164	+\$47
24"	48"	E6WR2448L	\$763	\$ 895	\$ 963	\$364	\$498	\$588	+\$47	+\$164	+\$47
24"	60"	E6WR2460L	\$853	\$ 985	\$1053	\$411	\$575	\$685	+\$47	+\$164	+\$47
24"	72"	E6WR2472L	\$947	\$1079	\$1147	\$505	\$669	\$779	+\$69	+\$242	+\$69

Right-Hand (coped on left side)

18"	30"	E6WR1830R	\$601	\$ 733	\$ 801	\$202	\$336	\$426	+\$47	+\$164	+\$47
18"	36"	E6WR1836R	\$616	\$ 748	\$ 816	\$217	\$351	\$441	+\$47	+\$164	+\$47
18"	42"	E6WR1842R	\$683	\$ 815	\$ 883	\$284	\$418	\$508	+\$47	+\$164	+\$47
18"	48"	E6WR1848R	\$736	\$ 868	\$ 936	\$337	\$471	\$561	+\$47	+\$164	+\$47
18"	60"	E6WR1860R	\$833	\$ 965	\$1033	\$434	\$568	\$658	+\$47	+\$164	+\$47
18"	72"	E6WR1872R	\$944	\$1076	\$1144	\$545	\$679	\$769	+\$69	+\$242	+\$69
24"	30"	E6WR2430R	\$633	\$ 765	\$ 833	\$234	\$368	\$458	+\$47	+\$164	+\$47
24"	36"	E6WR2436R	\$647	\$ 779	\$ 847	\$248	\$382	\$472	+\$47	+\$164	+\$47
24"	42"	E6WR2442R	\$704	\$ 836	\$ 904	\$305	\$439	\$529	+\$47	+\$164	+\$47
24"	48"	E6WR2448R	\$763	\$ 895	\$ 963	\$364	\$498	\$588	+\$47	+\$164	+\$47
24"	60"	E6WR2460R	\$853	\$ 985	\$1053	\$411	\$575	\$685	+\$47	+\$164	+\$47
24"	72"	E6WR2472R	\$947	\$1079	\$1147	\$505	\$669	\$779	+\$69	+\$242	+\$69

Desk Return Worksurfaces

Wood Veneer or Laminate

SIN 711.2

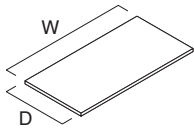

Standard Includes	Required to Specify
<ul style="list-style-type: none"> • Worksurface: wood group 1 veneer or laminate price group 1 • Wood group 1 worksurface with wood edge: <ul style="list-style-type: none"> –Solid wood edge on user’s side –Veneer edge on other sides (unless coped) • Laminate worksurface with plastic edge: <ul style="list-style-type: none"> –3 mm plastic edge on user’s side –1 mm plastic edge on other sides, plastic default to match user’s side • Laminate worksurface with wood edge: <ul style="list-style-type: none"> –Solid wood edge on user’s side –1 mm plastic edge on other sides (unless coped), color default to match worksurface • One end of the desk return worksurface is coped to fit into adjoining worksurface when specified with bullnose or blade edge profile • Attachment hardware: black paint only 	<ol style="list-style-type: none"> 1 Style number 2 Wood or laminate color number for worksurface 3 Wood or plastic edge color number for all sides on laminate worksurface, if selected 4 Worksurface profile (see below under Required Selections) 5 Options, if selected (see below) <p>▶ See <i>Surface Materials</i>, page 566.</p>

Required Selections (Prices at Right)

Wood Worksurface Edge Profiles			Laminate Worksurface Edge Profiles			
Wood Square Profile	Wood Bullnose Profile	Wood Blade Profile	Plastic Square Profile	Plastic Blade Profile	Wood Square Profile	Wood Bullnose Profile

Options Price Required to Specify

Surface Materials	Wood veneer worksurfaces <ul style="list-style-type: none"> • Wood group 2 • Wood group 3 • Customiz stain • Full-fill finish on wood group 1 (not available on laminate worksurfaces with wood edge) 	Prices at right Prices at right No cost Prices at right	Specify wood color number. Specify wood color number. Specify <i>with Customiz stain</i> . Specify wood veneer color number for worksurface.
	Laminate worksurfaces <ul style="list-style-type: none"> • Laminate price group 2 • Open Line laminate • Wood group 2 on wood edge • Wood group 3 on wood edge • Customiz stain 	See information at left +\$ 69 plus cost of laminate Prices at right Prices at right No cost	Specify laminate color number. ▶ See <i>Surface Materials Reference Manual</i> . Specify wood color number. Specify wood color number. Specify <i>with Customiz stain</i> .

For laminate price group 2 pricing, please refer to the electronic catalog or SmartTools.

Cable Management Overhang grommets (for 30"D or 36"D worksurfaces that overhang) Round grommets

• Available on worksurfaces: metal	+\$ 74	Left: <i>EGRHL</i> and color number. Right: <i>EGRHR</i> and color number. Center: <i>EGRHC</i> and color number.
------------------------------------	--------	---

• Available on worksurfaces: aluminum door	+\$197	Left: <i>EGSHL</i> and color number. Right: <i>EGSHR</i> and color number. Center: <i>EGSHC</i> and color number.
--	--------	---

Rear grommets (only available on 30"D worksurfaces without an overhang) Round grommets

• Available on worksurfaces: metal	+\$ 74	Left: <i>EGRL</i> and color number. Right: <i>EGRR</i> and color number. Center: <i>EGRC</i> and color number.
------------------------------------	--------	--

• Available on worksurfaces: aluminum door	+\$197	Left: <i>EGSL</i> and color number. Right: <i>EGSR</i> and color number. Center: <i>EGSC</i> and color number.
--	--------	--

• Available on center back only	+\$ 39	Specify <i>with scallop</i> .
---------------------------------	--------	-------------------------------

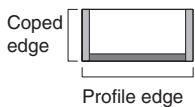

▶ Worksurface Edge Matrix in *Elective Elements Wood Systems Furniture Specification Guide*.

▶ Options, continued on next page

SIN 711.2

► Options, continued from previous page

Options	Price	Required to Specify
Wood Veneer Short Grain Direction	• Available on wood veneer worksurfaces No cost	Specify with short grain direction.
Related Products	• Modesty panels • Plinth base and leg base end panels • Adjustable-height legs • Plinth base and leg base storage • Payback square legs	► Page 266 ► Pages 252–258 and 264–265 ► Page 277 ► Pages 281 and 347 ► See <i>Wood Casegoods and Tables Specification Guide</i> .

Specification Information

Dimensions		Style Number	Base Prices			Laminate Price Group 1			Options (Add \$ to Base Price)		
D	W		Wood Square Edge	Wood Bullnose Edge	Wood Blade Edge	3 mm Plastic Square Edge	Laminate Blade Edge	Wood Square or Bullnose Edge	Wood Group 2	Wood Group 3	Full-Fill Finish on Wood Group 1

Desk Return Worksurfaces

Left-Hand (coped on right side)

30"	60"	E6WN3060L	\$ 953	\$1091	\$1159	\$511	\$675	\$785	+\$69	+\$242	+\$69
30"	72"	E6WN3072L	\$1042	\$1180	\$1248	\$600	\$764	\$874	+\$69	+\$242	+\$69
36"	60"	E6WN3660L	\$1013	\$1151	\$1219	\$571	\$735	\$845	+\$69	+\$242	+\$69
36"	72"	E6WN3672L	\$1102	\$1240	\$1308	\$660	\$824	\$934	+\$96	+\$335	+\$96

Right-Hand (coped on left side)

30"	60"	E6WN3060R	\$ 953	\$1091	\$1159	\$511	\$675	\$785	+\$69	+\$242	+\$69
30"	72"	E6WN3072R	\$1042	\$1180	\$1248	\$600	\$764	\$874	+\$69	+\$242	+\$69
36"	60"	E6WN3660R	\$1013	\$1151	\$1219	\$571	\$735	\$845	+\$69	+\$242	+\$69
36"	72"	E6WN3672R	\$1102	\$1240	\$1308	\$660	\$824	\$934	+\$96	+\$335	+\$96

Tip: Desk returns always have a 6" overhang when modesty panels are specified. Order 24"D end panels or pedestals for 30"D desk returns, and 30"D components for 36"D desk returns.



Bridge Worksurfaces

Wood Veneer or Laminate

SIN 711.2

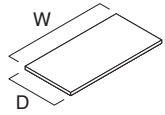

Tip: For bridge worksurfaces with a blade edge, subtract 2 1/8" from each side (4 1/4" total) for precise dimensions. This same rule applies to a bullet or P-top in a U-shape setting.

Tip: The nominal width of a bridge coped with blade edge work surface is approximately 4 1/4" less than a square edge.

Tip: Short grain direction is not available on laminate.

For laminate price group 2 pricing, please refer to the electronic catalog or SmartTools.

Tip: Specify a scallop when a service module or hutch kit is used with a task light.

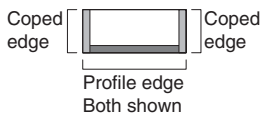

► Worksurface Edge Matrix in *Elective Elements Wood Systems Furniture Specification Guide*.

Standard Includes	Required to Specify
-------------------	---------------------

<ul style="list-style-type: none"> • Worksurface: wood group 1 veneer or laminate price group 1 • Wood group 1 work surface with wood edge: <ul style="list-style-type: none"> –Solid wood edge on user's side –Veneer edge on other sides (unless coped) • Laminate work surface with plastic edge: <ul style="list-style-type: none"> –3 mm plastic edge on user's side –1 mm plastic edge on other sides, plastic default to match user's side • Laminate work surface with wood edge: <ul style="list-style-type: none"> –Solid wood edge on user's side –1 mm plastic edge on other sides (unless coped), color default to match work surface • Both ends are coped to fit into adjoining work surface when specified with bullnose or blade edge profiles • Attachment hardware: black paint only 	<ol style="list-style-type: none"> 1 Style number 2 Wood or laminate color number for work surface 3 Wood or plastic edge color number for all sides on laminate work surface, if selected 4 Work surface profile (see below under Required Selections) 5 Options, if selected (see below) <p>► See <i>Surface Materials</i>, page 566.</p>
--	--

Required Selections (Prices at Right)

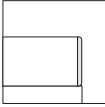
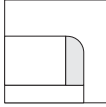
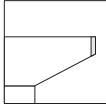
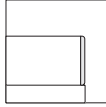
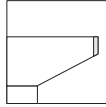
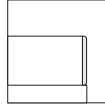
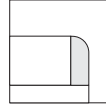
Wood Worksurface Edge Profiles	Laminate Worksurface Edge Profiles
 Wood Square Profile	 Wood Bullnose Profile
 Wood Blade Profile	 Plastic Square Profile
	 Plastic Blade Profile
	 Wood Square Profile
	 Wood Bullnose Profile

Options	Price	Required to Specify
---------	-------	---------------------

Surface Materials	Wood veneer worksurfaces <ul style="list-style-type: none"> • Wood group 2 • Wood group 3 • Customiz stain • Full-fill finish on wood group 1 (not available on laminate worksurfaces with wood edge) 	Prices at right Prices at right No cost Prices at right	Specify wood color number. Specify wood color number. Specify <i>with Customiz stain</i> . Specify wood veneer color number for work surface.
	Laminate worksurfaces <ul style="list-style-type: none"> • Laminate price group 2 • Open Line laminate 	See information at left +\$ 69 plus cost of laminate Prices at right Prices at right No cost	Specify laminate color number. ► See <i>Surface Materials Reference Manual</i> . Specify wood color number. Specify wood color number. Specify <i>with Customiz stain</i> .
Cable Management	Round grommets <ul style="list-style-type: none"> • Available on all worksurfaces: metal 	+\$ 74	Center: <i>EGRC</i> and color number.
	Square grommets <ul style="list-style-type: none"> • Available on all worksurfaces: aluminum door 	+\$197	Center: <i>EGSC</i> and color number.
	Scallop <ul style="list-style-type: none"> • Available on center back only 	+\$ 39	Specify <i>with scallop</i> .
	Wood Veneer Short Grain Direction <ul style="list-style-type: none"> • Available on wood veneer worksurfaces 	No cost	Specify <i>with short grain direction</i> .
Related Products	<ul style="list-style-type: none"> • Modesty panels 		► Page 266

SIN 711.2

Specification Information											
Dimensions		Style Number	Base Prices						Options		
D	W		Wood Group 1			Laminate Price Group 1			Wood		Full-Fill Finish on Wood Group 1
			Wood Square Edge	Wood Bullnose Edge	Wood Blade Edge	3 mm Plastic Square Edge	Laminate Blade Edge	Wood Square or Bullnose Edge	Wood Group 2	Wood Group 3	

Bridge Worksurfaces

18"	42"	E6WB1842	\$682	\$814	\$882	\$309	\$430	\$511	+\$28	+\$ 94	+\$29
18"	48"	E6WB1848	\$728	\$860	\$928	\$355	\$476	\$557	+\$28	+\$ 94	+\$29
24"	42"	E6WB2442	\$718	\$850	\$918	\$345	\$466	\$547	+\$47	+\$164	+\$47
24"	48"	E6WB2448	\$763	\$895	\$963	\$390	\$511	\$592	+\$47	+\$164	+\$47
.

Single Tapered Worksurfaces

Wood Veneer or Laminate

SIN 711.2

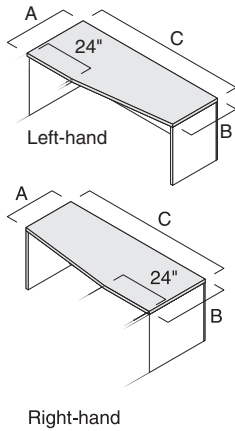

Standard Includes	Required to Specify
-------------------	---------------------

<ul style="list-style-type: none"> • Worksurface: wood group 1 veneer or laminate price group 1 • Wood group 1 worksurface with wood edge: <ul style="list-style-type: none"> –Solid wood edge on user’s side –Veneer edge on other sides • Laminate worksurface with plastic edge: <ul style="list-style-type: none"> –3 mm plastic edge on user’s side –1 mm plastic edge on other sides, plastic default to match user’s side • Laminate worksurface with wood edge: <ul style="list-style-type: none"> –Solid wood edge on user’s side –1 mm plastic edge on other sides, color default to match worksurface 	<ol style="list-style-type: none"> 1 Style number 2 Wood or laminate color number for worksurface 3 Wood or plastic edge color number for all sides on laminate worksurface, if selected 4 Worksurface profile (see below under Required Selections) 5 Options, if selected (see below) <p>▶ See <i>Surface Materials</i>, page 566.</p>
---	---

Required Selections (Prices at Right)

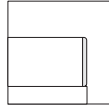
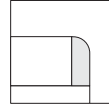
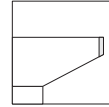
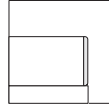
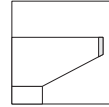
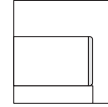
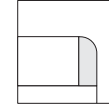
Wood Worksurface Edge Profiles	Laminate Worksurface Edge Profiles
 <p>Wood Square Profile</p>  <p>Wood Bullnose Profile</p>  <p>Wood Blade Profile</p>	 <p>Plastic Square Profile</p>  <p>Plastic Blade Profile</p>  <p>Wood Square Profile</p>  <p>Wood Bullnose Profile</p>

Options	Price	Required to Specify
---------	-------	---------------------

Surface Materials	<p>Wood veneer worksurfaces</p> <ul style="list-style-type: none"> • Wood group 2 +\$ 69 • Wood group 3 +\$242 • Customiz stain No cost • Full-fill finish on wood group 1 (not available on laminate worksurfaces with wood edge) +\$ 69 <p>Laminate worksurfaces</p> <ul style="list-style-type: none"> • Laminate price group 2 See information at left • Open Line laminate +\$ 69 plus cost of laminate • Wood group 2 on wood edge +\$ 69 • Wood group 3 on wood edge +\$242 • Customiz stain No cost 	<p>Specify wood color number. Specify wood color number. Specify <i>with Customiz stain</i>. Specify wood veneer color number for worksurface.</p> <hr/> <p>Specify laminate color number. ▶ See <i>Surface Materials Reference Manual</i>.</p> <hr/> <p>Specify wood color number. Specify wood color number. Specify <i>with Customiz stain</i>.</p>
Cable Management	<p>Round grommets</p> <ul style="list-style-type: none"> • Available on worksurfaces: metal +\$ 74 <p>Square grommets</p> <ul style="list-style-type: none"> • Available on worksurfaces: aluminum door +\$197 <p>Scallop</p> <ul style="list-style-type: none"> • Available on center back only +\$ 39 	<p>Left: <i>EGRL</i> and color number. Right: <i>EGRR</i> and color number. Center: <i>EGRC</i> and color number.</p> <hr/> <p>Left: <i>EGSL</i> and color number. Right: <i>EGSR</i> and color number. Center: <i>EGSC</i> and color number.</p> <hr/> <p>Specify <i>with scallop</i>.</p>
Wood Veneer Short Grain Direction	<ul style="list-style-type: none"> • Available on wood veneer worksurfaces No cost 	<p>Specify <i>with short grain direction</i>.</p>

For laminate price group 2 pricing, please refer to the electronic catalog or SmartTools.

Tip: Wood group 2 and 3 upcharges are in addition to wood group 1 upcharge.

Tip: Specify a scallop when a service module or hutch kit is used with a task light.

Tip: Refer to the selected panel Specification Guide to order supports for panel applications.



▶ Worksurface Edge Matrix in *Elective Elements Wood Systems Furniture Specification Guide*.

Related Products	Options
<ul style="list-style-type: none"> • Modesty panels • Plinth base and leg base end panels • Gate leg • Adjustable-height legs • Plinth base and leg base storage • Payback square legs 	<ul style="list-style-type: none"> ▶ Page 266 ▶ Pages 252–258 and 264–265 ▶ Page 276 ▶ Page 276 ▶ Pages 281 and 347 ▶ See <i>Wood Casegoods and Tables Specification Guide</i>.

SIN 711.2

Specification Information									
Dimensions			Style Number	Base Prices					
A	B	C		Wood Group 1			Laminate Price Group 1		
				Wood Square Edge	Wood Bullnose Edge	Wood Blade Edge	3 mm Plastic Square Edge	Laminate Blade Edge	Wood Square or Bullnose Edge

Single Tapered Worksurfaces

Left-Hand

A	B	C	Style Number	Wood Square Edge	Wood Bullnose Edge	Wood Blade Edge	3 mm Plastic Square Edge	Laminate Blade Edge	Wood Square or Bullnose Edge
30"	24"	72"	E6WH302472L	\$1159	\$1263	\$1311	\$ 796	\$ 938	\$1033
30"	24"	90"	E6WH302490L	\$1473	\$1577	\$1625	\$1110	\$1252	\$1347

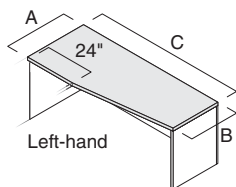

Left-hand

Right-Hand

A	B	C	Style Number	Wood Square Edge	Wood Bullnose Edge	Wood Blade Edge	3 mm Plastic Square Edge	Laminate Blade Edge	Wood Square or Bullnose Edge
24"	30"	72"	E6WH243072R	\$1159	\$1263	\$1311	\$ 796	\$ 938	\$1033
24"	30"	90"	E6WH243090R	\$1473	\$1577	\$1625	\$1110	\$1252	\$1347

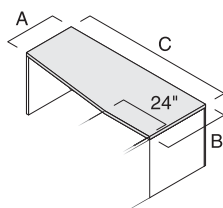

Right-hand

Tapered Worksurfaces—Single and Double, Run-Off

Wood Veneer or Laminate

SIN 711.2

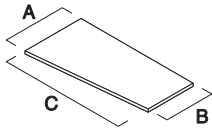

Standard Includes	Required to Specify
-------------------	---------------------

<ul style="list-style-type: none"> • Worksurface: wood group 1 veneer or laminate price group 1 • Wood group 1 worksurface with wood edge: <ul style="list-style-type: none"> –Solid wood edge on user’s side for single, on three sides for double –Veneer edge on other sides (unless coped) • Laminate worksurface with plastic edge: <ul style="list-style-type: none"> –3 mm plastic edge on user’s side for single, on three sides for double –1 mm plastic edge on other sides, plastic default to match user’s side • Laminate worksurface with wood edge: <ul style="list-style-type: none"> –Solid wood edge on user’s side for single, on three sides for double –1 mm plastic edge on other sides (unless coped), color default to match worksurface • One end is coped to fit into adjoining worksurface when specified with bullnose or blade edge profiles • Attachment hardware: black paint only 	<ol style="list-style-type: none"> 1 Style number 2 Wood or laminate color number for worksurface 3 Wood or plastic edge color number for all sides on laminate worksurface, if selected 4 Worksurface profile (see below under Required Selections) 5 Options, if selected (see below) <p>▶ See <i>Surface Materials</i>, page 566.</p>
--	---

Required Selections (Prices at Right)

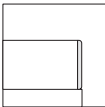
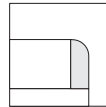
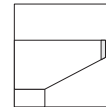
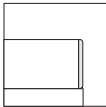
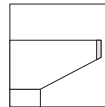
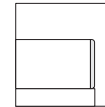
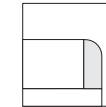
Wood Worksurface Edge Profiles	Laminate Worksurface Edge Profiles
 Wood Square Profile  Wood Bullnose Profile  Wood Blade Profile	 Plastic Square Profile  Plastic Blade Profile  Wood Square Profile  Wood Bullnose Profile

Options	Price	Required to Specify
---------	-------	---------------------

Surface Materials	Wood veneer worksurfaces <ul style="list-style-type: none"> • Wood group 2 +\$ 69 • Wood group 3 +\$242 • Customiz stain No cost • Full-fill finish on wood group 1 (not available on laminate worksurfaces with wood edge) +\$ 69 <hr/> Laminate worksurfaces <ul style="list-style-type: none"> • Laminate price group 2 See information at left • Open Line laminate +\$ 69 plus cost of laminate • Wood group 2 on wood edge +\$ 69 • Wood group 3 on wood edge +\$242 • Customiz stain No cost 	Specify wood color number. Specify wood color number. Specify <i>with Customiz stain</i> . Specify wood veneer color number for worksurface. <hr/> Specify laminate color number. ▶ See <i>Surface Materials Reference Manual</i> . <hr/> Specify wood color number. Specify wood color number. Specify <i>with Customiz stain</i> .
Cable Management	Round grommets <ul style="list-style-type: none"> • Available on worksurfaces: metal +\$ 74 <hr/> Square grommets <ul style="list-style-type: none"> • Available on worksurfaces: aluminum door +\$197 	Left: <i>EGRL</i> and color number. Right: <i>EGRR</i> and color number. <hr/> Left: <i>EGSL</i> and color number. Right: <i>EGSR</i> and color number.
Wood Veneer Short Grain Direction	<ul style="list-style-type: none"> • Available on wood veneer worksurfaces No cost 	Specify <i>with short grain direction</i> .

▶ Options, continued on next page

For laminate price group 2 pricing, please refer to the electronic catalog or *SmartTools*.

Tip: Wood group 2 and 3 upcharges are in addition to wood group 1 upcharge.

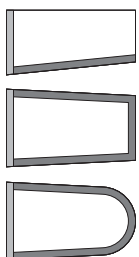

▶ Worksurface Edge Matrix in *Elective Elements Wood Systems Furniture Specification Guide*.

SIN 711.2

► Options, continued from previous page

Options		Required to Specify
Related Products	• Modesty panels	► Page 266
	• Plinth base and leg base end panels	► Pages 252–258 and 264–265
	• Gate leg	► Page 276
	• Column and disk column,	► Page 276
	• Rectangular column leg	► Page 276
	• Adjustable-height legs	► Page 277
	• Freestanding table base	► Page 277
• Plinth base and leg base storage	► Pages 281 and 347	
• Payback square legs	► See <i>Wood Casegoods and Tables Specification Guide</i> .	

Specification Information									
Dimensions			Style Number	Base Prices			Laminate Price Group 1		
A	B	C		Wood Group 1					
				Wood Square Edge	Wood Bullnose Edge	Wood Blade Edge	3 mm Plastic Square Edge	Laminate Blade Edge	Wood Square or Bullnose Edge

Single Tapered Run-Off

Left-Hand (coped on left side)

30"	24"	36"	E6WI302436L	\$ 930	\$1068	\$1136	\$ 557	\$ 681	\$ 764
30"	24"	60"	E6WI302460L	\$1158	\$1296	\$1364	\$ 687	\$ 868	\$ 989

Right-Hand (coped on right side)

24"	30"	36"	E6WI243036R	\$ 930	\$1068	\$1136	\$ 557	\$ 681	\$ 764
24"	30"	60"	E6WI243060R	\$1158	\$1296	\$1364	\$ 687	\$ 868	\$ 989

Double Tapered Run-Off

Straight End

30"	24"	36"	E6WF302436S	\$1065	\$1224	\$1298	\$ 565	\$ 754	\$ 879
36"	30"	48"	E6WF363048S	\$1258	\$1417	\$1491	\$ 685	\$ 901	\$1046
36"	30"	60"	E6WF363060S	\$1380	\$1539	\$1613	\$ 807	\$1023	\$1168
42"	36"	72"	E6WF423672S	\$1617	\$1776	\$1850	\$1000	\$1216	\$1361

Rounded End

30"	24"	36"	E6WF302436N	\$1125	\$1284	\$1358	\$ 625	\$ 814	\$ 939
36"	30"	48"	E6WF363048N	\$1320	\$1479	\$1553	\$ 747	\$ 963	\$1108
36"	30"	60"	E6WF363060N	\$1439	\$1598	\$1672	\$ 866	\$1082	\$1227
42"	36"	72"	E6WF423672N	\$1676	\$1835	\$1909	\$1059	\$1275	\$1420

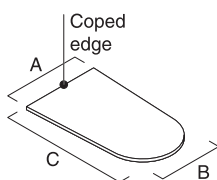
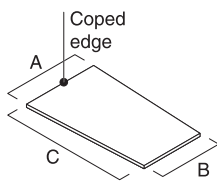
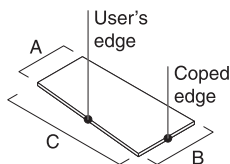
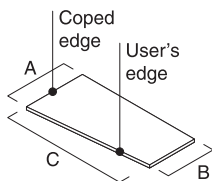

Tip: Refer to Modesty Panel Selection Guide when specifying modesty panels for Double Tapered Peninsula Worksurfaces.

Bullet Worksurfaces—Run-Off and Freestanding

Wood Veneer or Laminate

SIN 711.2

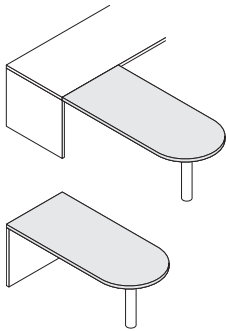

Tip: Recommended column and leg supports vary based on worksurface length and the support used on the opposite end. Refer to Worksurface Support Guidelines in Elective Elements Wood Systems Furniture Specifications Guide.



Bullet worksurface with coped edge



Bullet worksurface without coped edge

Tip: Your specification is not complete until you add a suffix to define the work-surface's edge profile.
 ▶ Worksurface Edge Matrix in Elective Elements Wood Systems Furniture Specification Guide.

For laminate price group 2 pricing, please refer to the electronic catalog or SmartTools.

Tip: Wood group 2 and 3 upcharges are in addition to wood group 1 upcharge.

Standard Includes	Required to Specify
-------------------	---------------------

- Worksurface: wood group 1 veneer or laminate price group 1
- Wood group 1 worksurface with wood edge:
 - Solid wood edge on three sides
 - Veneer edge on other sides (unless coped)
- Laminate worksurface with plastic edge:
 - 3 mm plastic edge on three sides
 - 1 mm plastic edge on other side, plastic default to match user's side
- Laminate worksurface with wood edge:
 - Solid wood edge on three sides
 - 1 mm plastic edge on other side (unless coped), color default to match worksurface
- Run-offs are coped on the end to fit into adjoining worksurface when specified with bullnose or blade profiles
- Run-offs include attachment hardware: black paint only

- 1 Style number
 - 2 Wood or laminate color number for worksurface
 - 3 Wood or plastic edge color number for all sides on laminate worksurface, if selected
 - 4 Worksurface profile (see below under Required Selections)
 - 5 Options, if selected (see below)
- ▶ See *Surface Materials*, page 566.

Required Selections (Prices at Right)	
---------------------------------------	--

Wood Worksurface Edge Profiles			Laminate Worksurface Edge Profiles			
Wood Square Profile	Wood Bullnose Profile	Wood Blade Profile	Plastic Square Profile	Plastic Blade Profile	Wood Square Profile	Wood Bullnose Profile

Surface Materials	Options	Price	Required to Specify
-------------------	---------	-------	---------------------

Surface Materials	Wood veneer worksurfaces	<ul style="list-style-type: none"> • Wood group 2 +\$ 96 • Wood group 3 +\$335 • Customiz stain No cost • Full-fill finish on wood group 1 (not available on laminate worksurfaces with wood edge) +\$ 96 	Specify wood color number. Specify wood color number. Specify <i>with Customiz stain</i> . Specify wood veneer color number for worksurface.
	Laminate worksurfaces	<ul style="list-style-type: none"> • Laminate price group 2 See information at left • Open Line laminate +\$ 69 plus cost of laminate • Wood group 2 on wood edge +\$ 96 • Wood group 3 on wood edge +\$335 • Customiz stain No cost 	Specify laminate color number. ▶ See <i>Surface Materials Reference Manual</i> . Specify wood color number. Specify wood color number. Specify <i>with Customiz stain</i> .
Cable Management	Round grommets	<ul style="list-style-type: none"> • Available on all worksurfaces: metal +\$ 74 	Left: <i>EGRL</i> and color number. Right: <i>EGRR</i> and color number.
	Square grommets	<ul style="list-style-type: none"> • Available on all worksurfaces: aluminum door +\$197 	Left: <i>EGSL</i> and color number. Right: <i>EGSR</i> and color number.
Wood Veneer Short Grain Direction	<ul style="list-style-type: none"> • Available on wood veneer worksurfaces No cost 		Specify <i>with short grain direction</i> .

Related Products	<ul style="list-style-type: none"> • 2/3-Height modesty panel • Plinth base and leg base free support end panels • Extended T-shape end panels • Rectangular column leg • Freestanding table base • Column • Disk column 	<ul style="list-style-type: none"> ▶ Page 266 ▶ Pages 256 and 265 ▶ Page 258 ▶ Page 276 ▶ Page 277 ▶ Page 276 ▶ Page 276
-------------------------	---	---

Specification Information

Dimensions D W	Style Number	Base Prices			Laminate Price Group 1		
		Wood Group 1			Laminate Price Group 1		
		Wood Square Edge	Wood Bullnose Edge	Wood Blade Edge	3 mm Plastic Square Edge	Laminate Blade Edge	Wood Square or Bullnose Edge

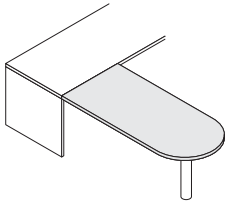

Bullet Run-Off Worksurfaces (coped on straight end)

30"	42"	E6WM3042	\$1165	\$1324	\$1398	\$ 575	\$ 785	\$ 927
30"	48"	E6WM3048	\$1254	\$1413	\$1487	\$ 664	\$ 874	\$1016
30"	54"	E6WM3054	\$1340	\$1499	\$1573	\$ 750	\$ 960	\$1102
30"	60"	E6WM3060	\$1408	\$1567	\$1641	\$ 818	\$1028	\$1170
30"	66"	E6WM3066	\$1497	\$1656	\$1730	\$ 863	\$1073	\$1215
30"	72"	E6WM3072	\$1591	\$1750	\$1824	\$ 957	\$1167	\$1309
36"	42"	E6WM3642	\$1241	\$1400	\$1474	\$ 651	\$ 861	\$1003
36"	48"	E6WM3648	\$1328	\$1487	\$1561	\$ 738	\$ 948	\$1090
36"	54"	E6WM3654	\$1417	\$1576	\$1650	\$ 827	\$1037	\$1179
36"	60"	E6WM3660	\$1483	\$1642	\$1716	\$ 893	\$1103	\$1245
36"	66"	E6WM3666	\$1571	\$1730	\$1804	\$ 937	\$1147	\$1289
36"	72"	E6WM3672	\$1666	\$1825	\$1899	\$1032	\$1242	\$1384

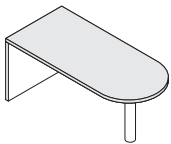

Freestanding Bullet Worksurfaces

30"	60"	E6WE3060	\$1358	\$1517	\$1591	\$ 768	\$ 978	\$1120
30"	66"	E6WE3066	\$1447	\$1606	\$1680	\$ 813	\$1023	\$1165
30"	72"	E6WE3072	\$1543	\$1702	\$1776	\$ 909	\$1119	\$1261
30"	78"	E6WE3078	\$1584	\$1743	\$1817	\$ 950	\$1160	\$1302
30"	84"	E6WE3084	\$1629	\$1788	\$1862	\$ 995	\$1205	\$1347
30"	90"	E6WE3090	\$1671	\$1830	\$1904	\$ 999	\$1258	\$1432
36"	60"	E6WE3660	\$1433	\$1592	\$1666	\$ 843	\$1053	\$1195
36"	66"	E6WE3666	\$1523	\$1682	\$1756	\$ 889	\$1099	\$1241
36"	72"	E6WE3672	\$1616	\$1775	\$1849	\$ 982	\$1192	\$1334
36"	78"	E6WE3678	\$1659	\$1818	\$1892	\$1025	\$1235	\$1377
36"	84"	E6WE3684	\$1704	\$1863	\$1937	\$1070	\$1280	\$1422
36"	90"	E6WE3690	\$1746	\$1905	\$1979	\$1074	\$1333	\$1507

Tip: Refer to Modesty Panel Selection Guide (for run-off worksurface) or Extended T-Shape End Panel Selection Guide (for freestanding work-surfaces) when specifying modesty panels or extended T-shape end panels.
▶ See Elective Elements Wood Systems Furniture Specification Guide.

P-Top Worksurfaces—Run-Off and Freestanding

Wood Veneer or Laminate

SIN 711.2

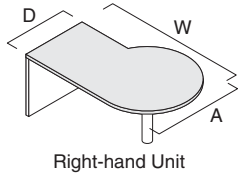
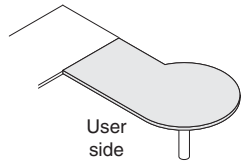

Tip: Recommended column and leg supports vary based on worksurface length and the support used on the opposite end. Refer to Worksurface Support Guidelines in Elective Elements Wood Systems Furniture Specifications Guide.



P-Top work surface with coped edge

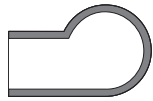

P-Top work surface without coped edge

▶ Worksurface Edge Matrix in Elective Elements Wood Systems Furniture Specification Guide.

For laminate price group 2 pricing, please refer to the electronic catalog or SmartTools.

Tip: Wood group 2 and 3 upcharges are in addition to wood group 1 upcharge.

Standard Includes

- Worksurface: wood group 1 veneer or laminate price group 1
- Wood group 1 worksurface with wood edge:
 - Solid wood edge on three sides
 - Veneer edge on other side (unless coped)
- Laminate worksurface with plastic edge:
 - 3 mm plastic edge on three sides
 - 1 mm plastic edge on other side, plastic default to match user's side
- Laminate worksurface with wood edge:
 - Solid wood edge on three sides
 - 1 mm plastic edge on other side edge (unless coped), color default to match worksurface
- Run-offs are coped on the end to fit into adjoining work surface when specified with bullnose or blade profiles
- Run-offs include attachment hardware: black paint only

Required to Specify

- 1 Style number
 - 2 Wood or laminate color number for worksurface
 - 3 Wood or plastic edge color number for all sides on laminate worksurface, if selected
 - 4 Worksurface profile (see below under Required Selections)
 - 5 Options, if selected (see below)
- ▶ See *Surface Materials*, page 566.

Required Selections (Prices at Right)

Wood Worksurface Edge Profiles

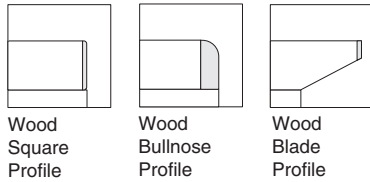

Laminate Worksurface Edge Profiles

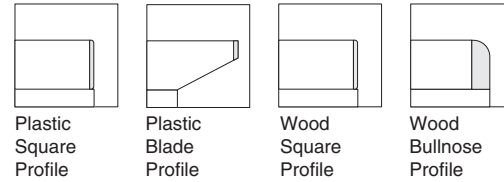

Options

Options	Price	Required to Specify
Surface Materials <ul style="list-style-type: none"> • Wood veneer worksurfaces <ul style="list-style-type: none"> • Wood group 2 +\$ 96 • Wood group 3 +\$335 • Customiz stain No cost • Full-fill finish on wood group 1 (not available on laminate worksurfaces with wood edge) +\$ 96 • Laminate worksurfaces <ul style="list-style-type: none"> • Laminate price group 2 See information at left • Open Line laminate +\$ 69 plus cost of laminate • Wood group 2 on wood edge +\$ 96 • Wood group 3 on wood edge +\$335 • Customiz stain No cost 		Specify wood color number. Specify wood color number. Specify <i>with Customiz stain</i> . Specify wood veneer color number for worksurface. Specify laminate color number. ▶ See <i>Surface Materials Reference Manual</i> . Specify wood color number. Specify wood color number. Specify <i>with Customiz stain</i> .
Cable Management <ul style="list-style-type: none"> • Round grommets <ul style="list-style-type: none"> • Available on all worksurfaces: metal +\$ 74 • Square grommets <ul style="list-style-type: none"> • Available on all worksurfaces: aluminum door +\$197 		Left: <i>EGRL</i> and color number. Right: <i>EGRR</i> and color number. Left: <i>EGSL</i> and color number. Right: <i>EGSR</i> and color number.
Wood Veneer Short Grain Direction <ul style="list-style-type: none"> • Available on wood veneer worksurfaces No cost 		Specify <i>with short grain direction</i> .
Related Products <ul style="list-style-type: none"> • 2/3-Height modesty panel • Plinth base and leg base free support end panels • Extended T-shape end panels • Rectangular column leg • Freestanding table base • Column • Disk column 		▶ Page 266 ▶ Pages 256 and 265 ▶ Page 258 ▶ Page 276 ▶ Page 277 ▶ Page 276 ▶ Page 276

Specification Information

Dimensions			Style Number	Base Prices			Laminate Price Group 1		
D	W	A		Wood Group 1					
				Wood Square Edge	Wood Bullnose Edge	Wood Blade Edge	3 mm Plastic Square Edge	Laminate Blade Edge	Wood Square or Bullnose Edge

P-Top Run-Off Worksurfaces (coped on straight end)

Left-Hand

30"	66"	42"	E6WG306642L	\$1785	\$1944	\$2018	\$1027	\$1286	\$1460
30"	72"	42"	E6WG307242L	\$1859	\$2018	\$2092	\$1101	\$1404	\$1607
36"	72"	48"	E6WG367248L	\$1971	\$2130	\$2204	\$1213	\$1516	\$1719

Right-Hand

30"	66"	42"	E6WG306642R	\$1785	\$1944	\$2018	\$1027	\$1286	\$1460
30"	72"	42"	E6WG307242R	\$1859	\$2018	\$2092	\$1101	\$1404	\$1607
36"	72"	48"	E6WG367248R	\$1971	\$2130	\$2204	\$1213	\$1516	\$1719

Freestanding P-Top Worksurfaces

Left-Hand

30"	66"	42"	E6WP306642L	\$1734	\$1893	\$1967	\$ 976	\$1235	\$1409
30"	72"	42"	E6WP307242L	\$1809	\$1968	\$2042	\$1051	\$1354	\$1557
36"	72"	48"	E6WP367248L	\$1923	\$2082	\$2156	\$1165	\$1468	\$1671

Right-Hand

30"	66"	42"	E6WP306642R	\$1734	\$1893	\$1967	\$ 976	\$1235	\$1409
30"	72"	42"	E6WP307242R	\$1809	\$1968	\$2042	\$1051	\$1354	\$1557
36"	72"	48"	E6WP367248R	\$1923	\$2082	\$2156	\$1165	\$1468	\$1671

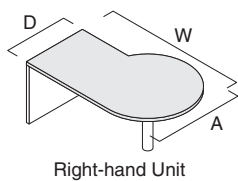
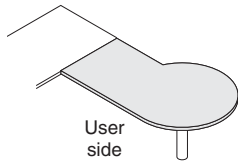

Tip: Refer to Modesty Panel Selection Guide (for run-off worksurfaces) or Extended T-Shape End Panel Selection Guide (for freestanding worksurfaces) when specifying modesty panels or extended T-shape end panels.

► See Elective Elements Wood Systems Furniture Specification Guide.

Meeting Worksurfaces

Wood Veneer or Laminate

SIN 711.2

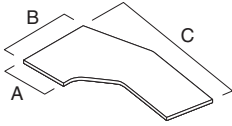

Left-hand shown

Tip: 60"W top will attach to an 18"D worksurface, and 78"W top will attach to a 24"W worksurface.

Tip: Meeting worksurfaces can be supported in one of the following ways on the outer edge: a pedestal with or without a slip fit bracket, a rectangular column leg with or without base, adjustable height legs, disk column or column leg, gate leg, free support end panel, L-shape end panel, or T-shape end panel.

For laminate price group 2 pricing, please refer to the electronic catalog or SmartTools.

Tip: Wood group 2 and 3 upcharges are in addition to wood group 1 upcharge.

Tip: Meeting worksurfaces must be attached to another worksurface. They are never freestanding.

Tip: Specify a 2/3-height modesty panel with optional hanging brackets, if desired. Refer to Modesty Panel Selection Guide. See Elective Elements Wood Systems Furniture Specification Guide.



Worksurface Edge Matrix in Elective Elements Wood Systems Furniture Specification Guide.

Standard Includes	Required to Specify
<ul style="list-style-type: none"> • Worksurface: wood group 1 veneer or laminate price group 1 • Wood group 1 worksurface with wood edge: <ul style="list-style-type: none"> –Solid wood edge on user and visitor’s side –Veneer edge on other sides • Laminate worksurface with plastic edge: <ul style="list-style-type: none"> –3 mm plastic edge on user and visitor’s side –1 mm plastic edge on other sides, plastic default to match user and visitor’s side • Laminate worksurface with wood edge: <ul style="list-style-type: none"> –Solid wood edge on user and visitor’s side –1 mm plastic edge on other sides, color default to match worksurface 	<ol style="list-style-type: none"> 1 Style number 2 Wood or laminate color number for worksurface 3 Wood or plastic edge color number for all sides on laminate worksurface, if selected 4 Worksurface profile (see below under Required Selections) 5 Options, if selected (see below) <p>▶ See <i>Surface Materials</i>, page 566.</p>

Required Selections (Prices at Right)

Wood Worksurface Edge Profiles			Laminate Worksurface Edge Profiles			
Wood Square Profile	Wood Bullnose Profile	Wood Blade Profile	Plastic Square Profile	Plastic Blade Profile	Wood Square Profile	Wood Bullnose Profile

Options	Price	Required to Specify
Surface Materials	<p>Wood veneer worksurfaces</p> <ul style="list-style-type: none"> • Wood group 2 +\$ 96 • Wood group 3 +\$335 • Customiz stain No cost • Full-fill finish on wood group 1 (not available on laminate worksurfaces with wood edge) +\$ 96 <p>Laminate worksurfaces</p> <ul style="list-style-type: none"> • Laminate price group 2 See information at left • Open Line laminate +\$ 69 plus cost of laminate • Wood group 2 on wood edge +\$ 96 • Wood group 3 on wood edge +\$335 • Customiz stain No cost 	<p>Specify wood color number.</p> <p>Specify wood color number. Specify with <i>Customiz stain</i>.</p> <p>Specify wood veneer color number for worksurface.</p> <hr/> <p>Specify laminate color number.</p> <p>▶ See <i>Surface Materials Reference Manual</i>.</p> <hr/> <p>Specify wood color number.</p> <p>Specify wood color number. Specify with <i>Customiz stain</i>.</p>
Cable Management	<p>Round grommets</p> <ul style="list-style-type: none"> • Available on all worksurfaces: metal +\$ 74 <p>Square grommets</p> <ul style="list-style-type: none"> • Available on all worksurfaces: aluminum door +\$197 	<p>Left (on right-hand units): EGRL and color number.</p> <p>Right (on left-hand units): EGRR and color number.</p> <hr/> <p>Left (on right-hand units): EGSL and color number.</p> <p>Right (on left-hand units): EGSR and color number.</p>
Related Products	<ul style="list-style-type: none"> • Return worksurfaces • Plinth base and leg base end panels • Rectangular column leg • Modesty panels • Column and disk column 	<ul style="list-style-type: none"> ▶ Page 220 ▶ Pages 252–258 and 264–265 ▶ Page 276 ▶ Page 266 ▶ Page 276

SIN 711.2

Specification Information									
Dimensions			Style Number	Base Prices					
A	B	C		Wood Group 1			Laminate Price Group 1		
				Wood Square Edge	Wood Bullnose Edge	Wood Blade Edge	3 mm Plastic Square Edge	Laminate Blade Edge	Wood Square or Bullnose Edge

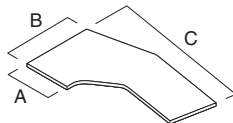

Tip: Support the 36"W end of the meeting work surface with a 29 1/4"D L-Shaped end panel or a 36"W T-Shaped end panel.

Meeting Worksurfaces

Left-Hand

Dimensions	Style Number	Wood Square Edge	Wood Bullnose Edge	Wood Blade Edge	3 mm Plastic Square Edge	Laminate Blade Edge	Wood Square or Bullnose Edge
18" x 36" x 60"	E6XG3660L	\$2370	\$2432	\$2455	\$1855	\$2103	\$2268
24" x 36" x 78"	E6XG3678L	\$2670	\$2732	\$2755	\$2127	\$2394	\$2571

Right-Hand

Dimensions	Style Number	Wood Square Edge	Wood Bullnose Edge	Wood Blade Edge	3 mm Plastic Square Edge	Laminate Blade Edge	Wood Square or Bullnose Edge
18" x 36" x 60"	E6XG3660R	\$2370	\$2432	\$2455	\$1855	\$2103	\$2268
24" x 36" x 78"	E6XG3678R	\$2670	\$2732	\$2755	\$2127	\$2394	\$2571

Extended Bullet Worksurfaces

Wood Veneer or Laminate

SIN 711.2

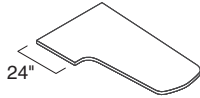

Left-hand shown

Standard Includes	Required to Specify
<ul style="list-style-type: none"> • Worksurface: wood group 1 veneer or laminate price group 1 • Wood group 1 worksurface with wood edge: <ul style="list-style-type: none"> –Solid wood edge on user and visitor’s side –Veneer edge on other sides • Laminate worksurface with plastic edge: <ul style="list-style-type: none"> –3 mm plastic edge on user and visitor’s side –1 mm plastic edge on other sides, plastic default to match user and visitor’s side • Laminate worksurface with wood edge: <ul style="list-style-type: none"> –Solid wood edge on user and visitor’s side –1 mm plastic edge on other sides, color default to match worksurface 	<ol style="list-style-type: none"> 1 Style number 2 Wood or laminate color number for worksurface 3 Wood or plastic edge color number for all sides on laminate worksurface, if selected 4 Worksurface profile (see below under Required Selections) 5 Options, if selected (see below) <p>▶ See <i>Surface Materials</i>, page 566.</p>

Required Selections (Prices at Right)

Wood Worksurface Edge Profiles			Laminate Worksurface Edge Profiles			
Wood Square Profile	Wood Bullnose Profile	Wood Blade Profile	Plastic Square Profile	Plastic Blade Profile	Wood Square Profile	Wood Bullnose Profile

Options	Price	Required to Specify
Surface Materials	<p>Wood veneer worksurfaces</p> <ul style="list-style-type: none"> • Wood group 2 +\$ 96 • Wood group 3 +\$335 • Customiz stain No cost • Full-fill finish on wood group 1 (not available on laminate worksurfaces with wood edge) +\$ 96 <p>Laminate worksurfaces</p> <ul style="list-style-type: none"> • Laminate price group 2 See information at left • Open Line laminate +\$ 69 plus cost of laminate • Wood group 2 on wood edge +\$ 96 • Wood group 3 on wood edge +\$335 • Customiz stain No cost 	<p>Specify wood color number.</p> <p>Specify wood color number.</p> <p>Specify <i>with Customiz stain</i>.</p> <p>Specify wood veneer color number for worksurface.</p> <hr/> <p>Specify laminate color number.</p> <p>▶ See <i>Surface Materials Reference Manual</i>.</p> <p>Specify wood color number.</p> <p>Specify wood color number.</p> <p>Specify <i>with Customiz stain</i>.</p>
Cable Management	<p>Round grommets</p> <ul style="list-style-type: none"> • Available on all worksurfaces: metal +\$ 74 <p>Square grommets</p> <ul style="list-style-type: none"> • Available on all worksurfaces: aluminum door +\$197 	<p>Left (on right-hand units): <i>EGRL</i> and color number.</p> <p>Right (on left-hand units): <i>EGRR</i> and color number.</p> <hr/> <p>Left (on right-hand units): <i>EGSL</i> and color number.</p> <p>Right (on left-hand units): <i>EGSR</i> and color number.</p>
Wood Veneer Short Grain Direction	<ul style="list-style-type: none"> • Available on wood veneer worksurfaces No cost 	<p>Specify <i>with short grain direction</i>.</p>

For laminate price group 2 pricing, please refer to the electronic catalog or SmartTools.

Tip: Wood group 2 and 3 upcharges are in addition to wood group 1 upcharge.

Tip: Extended bullet worksurfaces must be attached to another worksurface. They are never freestanding.

Tip: Specify a 12"H or 2/3-height modesty panel with optional hanging brackets, if desired. Refer to Modesty Panel Selection Guide.

▶ See *Elective Elements Wood Systems Furniture Specification Guide*.



▶ Worksurface Edge Matrix in *Elective Elements Wood Systems Furniture Specification Guide*.

Related Products		
<ul style="list-style-type: none"> • Return worksurfaces • Plinth base and leg base end panels • Rectangular column leg • Modesty panels • Column and disk column 		<ul style="list-style-type: none"> ▶ Page 220 ▶ Pages 252–258 and 264–265 ▶ Page 276 ▶ Page 266 ▶ Page 276

Specification Information								
Dimensions		Style Number	Base Prices					
D	W		Wood Group 1			Laminate Price Group 1		
			Wood Square Edge	Wood Bullnose Edge	Wood Blade Edge	3 mm Plastic Square Edge	Laminate Blade Edge	Wood Square or Bullnose Edge

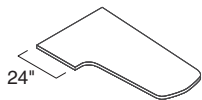

Tip: Support the 42"W end of the extended bullet worksurfaces with a 23 1/4"D or 29 1/4"D L-Shaped end panel or a 36"W T-Shaped end panel.

Extended Bullet Worksurfaces

Left-Hand

42"	60"	E6XD4260L	\$2135	\$2197	\$2220	\$1620	\$1868	\$2033
42"	72"	E6XD4272L	\$2318	\$2380	\$2403	\$1775	\$2023	\$2188

Right-Hand

42"	60"	E6XD4260R	\$2135	\$2197	\$2220	\$1620	\$1868	\$2033
42"	72"	E6XD4272R	\$2318	\$2380	\$2403	\$1775	\$2023	\$2188

Corner Worksurfaces—Straight and Curved Front

Wood Veneer or Laminate

SIN 711.2

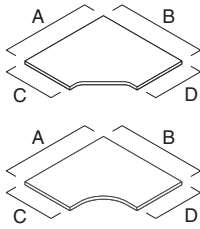

Tip: Straight- and curved-front worksurfaces have 45° grain.

Standard Includes	Required to Specify
<ul style="list-style-type: none"> • Worksurface: wood group 1 veneer or laminate price group 1 • Wood group 1 worksurface with wood edge: <ul style="list-style-type: none"> –Solid wood edge on user’s side –Veneer edge on other sides • Laminate worksurface with plastic edge: <ul style="list-style-type: none"> –3 mm plastic edge on user’s side –1 mm plastic edge on other sides, plastic default to match user’s side • Laminate worksurface with wood edge: <ul style="list-style-type: none"> –Solid wood edge on user’s side –1 mm plastic edge on other sides, color default to match worksurface 	<ol style="list-style-type: none"> 1 Style number 2 Wood or laminate color number for worksurface 3 Wood or plastic edge color number for all sides on laminate worksurface, if selected 4 Worksurface profile (see below under Required Selections) 5 Options, if selected (see below) <p>▶ See <i>Surface Materials</i>, page 566.</p>

Required Selections (Prices at Right)							
Wood Worksurface Edge Profiles				Laminate Worksurface Edge Profiles			
Wood Square Profile	Wood Bullnose Profile	Wood Blade Profile	Plastic Square Profile	Plastic Blade Profile	Wood Square Profile	Wood Bullnose Profile	Wood Blade Profile

Options	Price	Required to Specify
<p>Surface Materials</p> <p>Wood veneer worksurfaces</p> <ul style="list-style-type: none"> • Wood group 2 +\$ 47 • Wood group 3 +\$164 • Customiz stain No cost • Full-fill finish on wood group 1 (not available on laminate worksurfaces with wood edge) +\$ 47 <p>Laminate worksurfaces</p> <ul style="list-style-type: none"> • Laminate price group 2 See information at left • Open Line laminate +\$ 69 plus cost of laminate • Wood group 2 on wood edge +\$ 47 • Wood group 3 on wood edge +\$164 • Customiz stain No cost 		<p>Specify wood color number.</p> <p>Specify wood color number.</p> <p>Specify <i>with Customiz stain</i>.</p> <p>Specify wood veneer color number for worksurface.</p> <p>Specify laminate color number.</p> <p>▶ See <i>Surface Materials Reference Manual</i>.</p> <p>Specify wood color number.</p> <p>Specify wood color number.</p> <p>Specify <i>with Customiz stain</i>.</p>
<p>Cable Management</p> <p>Round grommets</p> <ul style="list-style-type: none"> • Available on all worksurfaces: metal +\$ 74 <p>Square grommets</p> <ul style="list-style-type: none"> • Available on all worksurfaces: aluminum door +\$197 <p>Scallops</p> <ul style="list-style-type: none"> • Available on center back of both back edges only +\$ 39 		<p>Left: <i>EGRL</i> and color number.</p> <p>Right: <i>EGRR</i> and color number.</p> <p>Center: <i>EGRC</i> and color number.</p> <p>Left: <i>EGSL</i> and color number.</p> <p>Right: <i>EGSR</i> and color number.</p> <p>Center: <i>EGSC</i> and color number.</p> <p>Specify <i>with scallops</i>.</p>

For laminate price group 2 pricing, please refer to the electronic catalog or SmartTools.

Tip: Wood group 2 and 3 upcharges are in addition to wood group 1 upcharge.

Tip: Refer to the selected panel Specification Guide to order supports for panel applications.

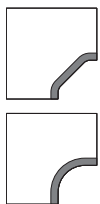

▶ Worksurface Edge Matrix in Elective Elements Wood Systems Furniture Specification Guide.

Related Products	
<ul style="list-style-type: none"> • Modesty panels • Plinth base and leg base end panels • Corner support kits and rear L-shape corner support 	<ul style="list-style-type: none"> ▶ Page 266 ▶ Pages 252–258 and 264–265 ▶ Page 260

SIN 711.2

Specification Information

Dimensions				Style Number	Base Prices					
A	B	C	D		Wood Group 1			Laminate Price Group 1		
					Wood Square Edge	Wood Bullnose Edge	Wood Blade Edge	3 mm Plastic Square Edge	Laminate Blade Edge	Wood Square Edge

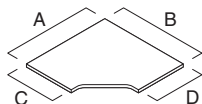

Straight-Front Corner Worksurfaces

42"	42"	24"	24"	E6WC4242242	\$736	\$767	\$791	\$494	\$586	\$649
42"	42"	30"	30"	E6WC4242303	\$827	\$858	\$882	\$585	\$677	\$740

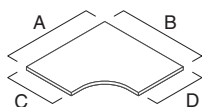

Curved-Front Corner Worksurfaces

42"	42"	24"	24"	E6WU4242242	\$883	\$914	\$938	\$611	\$703	\$794
42"	42"	30"	30"	E6WU4242303	\$933	\$964	\$988	\$661	\$753	\$844

Extended Corner Worksurfaces

Wood Veneer or Laminate

SIN 711.2

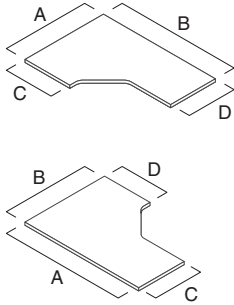

Standard Includes	Required to Specify
-------------------	---------------------

<ul style="list-style-type: none"> • Worksurface: wood group 1 veneer or laminate price group 1 • Wood group 1 worksurface with wood edge: <ul style="list-style-type: none"> –Solid wood edge on user’s side –Veneer edge on other sides • Laminate worksurface with plastic edge: <ul style="list-style-type: none"> –3 mm plastic edge on user’s side –1 mm plastic edge on other sides, plastic default to match user’s side • Laminate worksurface with wood edge: <ul style="list-style-type: none"> –Solid wood edge on user’s side –1 mm plastic edge on other sides, color default to match worksurface 	<ol style="list-style-type: none"> 1 Style number 2 Wood or laminate color number for worksurface 3 Wood or plastic edge color number for all sides on laminate worksurface, if selected 4 Worksurface profile (see below under Required Selections) 5 Options, if selected (see below) <p>▶ See <i>Surface Materials</i>, page 566.</p>
---	---

Required Selections (Prices at Right)

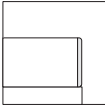
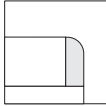
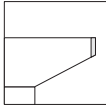
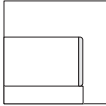
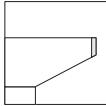
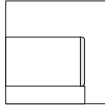
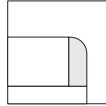
Wood Worksurface Edge Profiles	Laminate Worksurface Edge Profiles
 <p>Wood Square Profile</p>  <p>Wood Bullnose Profile</p>  <p>Wood Blade Profile</p>	 <p>Plastic Square Profile</p>  <p>Plastic Blade Profile</p>  <p>Wood Square Profile</p>  <p>Wood Bullnose Profile</p>

Options	Price	Required to Specify
---------	-------	---------------------

Surface Materials	<p>Wood veneer worksurfaces</p> <ul style="list-style-type: none"> • Wood group 2 +\$ 69 • Wood group 3 +\$242 • Customiz stain No cost • Full-fill finish on wood group 1 (not available on laminate worksurfaces with wood edge) +\$ 69 <p>Laminate worksurfaces</p> <ul style="list-style-type: none"> • Laminate price group 2 See information at left • Open Line laminate +\$ 69 plus cost of laminate • Wood group 2 on wood edge +\$ 69 • Wood group 3 on wood edge +\$242 • Customiz stain No cost 	<p>Specify wood color number. Specify wood color number. Specify <i>with Customiz stain</i>. Specify wood veneer color number for worksurface.</p> <hr/> <p>Specify laminate color number. ▶ See <i>Surface Materials Reference Manual</i>.</p> <p>Specify wood color number. Specify wood color number. Specify <i>with Customiz stain</i>.</p>
Cable Management	<p>Round grommets</p> <ul style="list-style-type: none"> • Available on all worksurfaces: metal +\$ 74 <p>Square grommets</p> <ul style="list-style-type: none"> • Available on all worksurfaces: aluminum door +\$197 <p>Scallops</p> <ul style="list-style-type: none"> • Available on center back of both back edges only +\$ 39 	<p>Left: <i>EGRL</i> and color number. Right: <i>EGRR</i> and color number. Center: <i>EGRC</i> and color number.</p> <hr/> <p>Left: <i>EGSL</i> and color number. Right: <i>EGSR</i> and color number. Center: <i>EGSC</i> and color number.</p> <hr/> <p>Specify <i>with scallops</i>.</p>
Wood Veneer Short Grain Direction	<ul style="list-style-type: none"> • Available on wood veneer worksurfaces No cost 	<p>Specify <i>with short grain direction</i>.</p>

For laminate price group 2 pricing, please refer to the electronic catalog or SmartTools.

Tip: Wood group 2 and 3 upcharges are in addition to wood group 1 upcharge.

Tip: Specify a scallop when a service module or hutch kit is used with a task light.

Tip: Refer to the selected panel Specification Guide to order supports for panel applications.



▶ Worksurface Edge Matrix in Elective Elements Wood Systems Furniture Specification Guide.

Related Products	<ul style="list-style-type: none"> • Modesty panels • Plinth base and leg base end panels • Corner support kits and rear L-shape corner support • Pedestals 	<ul style="list-style-type: none"> ▶ Page 266 ▶ Pages 252–258 and 264–265 ▶ Page 260 ▶ Pages 282–288
-------------------------	---	--

Specification Information										
Dimensions				Style Number	Base Prices					
A	B	C	D		Wood Group 1			Laminate Price Group 1		
					Wood Square Edge	Wood Bullnose Edge	Wood Blade Edge	3 mm Plastic Square Edge	Laminate Blade Edge	Wood Square Edge

Extended Corner Worksurfaces

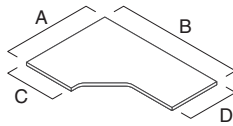

Right-Hand

42"	60"	24"	24"	E6XC4260242	\$1305	\$1367	\$1390	\$790	\$1038	\$1203
42"	66"	24"	24"	E6XC4266242	\$1377	\$1439	\$1462	\$862	\$1110	\$1275
42"	72"	24"	24"	E6XC4272242	\$1475	\$1537	\$1560	\$932	\$1199	\$1376

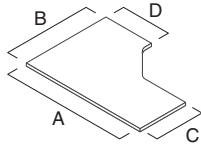

Left-Hand

60"	42"	24"	24"	E6XC6042242	\$1305	\$1367	\$1390	\$790	\$1038	\$1203
66"	42"	24"	24"	E6XC6642242	\$1377	\$1439	\$1462	\$862	\$1110	\$1275
72"	42"	24"	24"	E6XC7242242	\$1475	\$1537	\$1560	\$932	\$1199	\$1376

Transaction Top Worksurfaces

Wood Veneer or Laminate

SIN 711.2

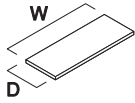

Standard Includes	Required to Specify
<ul style="list-style-type: none"> • Worksurface: wood group 1 veneer or laminate price group 1 • Wood group 1 worksurface with wood edge: <ul style="list-style-type: none"> –Solid wood edge on user and visitor’s side –Veneer edge on other sides • Laminate worksurface with plastic edge: <ul style="list-style-type: none"> –3 mm plastic edge on user and visitor’s side –1 mm plastic edge on other sides, plastic default to match user and visitor’s side • Laminate worksurface with wood edge: <ul style="list-style-type: none"> –Solid wood edge on user and visitor’s side –1 mm plastic edge on other sides, color default to match worksurface • Attachment hardware: black paint only • Top caps for Answer: paint or wood, if selected 	<ol style="list-style-type: none"> 1 Style number 2 Wood or laminate color number for worksurface 3 Wood or plastic edge color number for all sides on laminate worksurface, if selected 4 Worksurface profile (see below under Required Selections) 5 Paint or wood color number for Answer top caps, if selected 6 Options, if selected (see below) <p>▶ See <i>Surface Materials</i>, page 566.</p>

Required Selections (Prices at Right)

Wood Worksurface Edge Profiles			Laminate Worksurface Edge Profiles			
Wood Square Profile	Wood Bullnose Profile	Wood Blade Profile	Plastic Square Profile	Plastic Blade Profile	Wood Square Profile	Wood Bullnose Profile

Options	Price	Required to Specify
<p>Surface Materials</p> <p>Wood veneer worksurfaces</p> <ul style="list-style-type: none"> • Wood group 2 +\$ 28 • Wood group 3 +\$ 94 • Customiz stain No cost • Full-fill finish on wood group 1 (not available on laminate worksurfaces with wood edge) +\$ 29 <p>Laminate worksurfaces</p> <ul style="list-style-type: none"> • Laminate price group 2 See information at left • Open Line laminate +\$ 69 plus cost of laminate • Wood group 2 on wood edge +\$ 28 • Wood group 3 on wood edge +\$ 94 • Customiz stain No cost 		<p>Specify wood color number.</p> <p>Specify wood color number.</p> <p>Specify with <i>Customiz stain</i>.</p> <p>Specify wood veneer color number for worksurface.</p> <p>Specify laminate color number.</p> <p>▶ See <i>Surface Materials Reference Manual</i>.</p> <p>Specify wood color number.</p> <p>Specify wood color number.</p> <p>Specify with <i>Customiz stain</i>.</p>
<p>Top Cap on Answer Application</p> <p>Square top cap</p> <ul style="list-style-type: none"> • Wood veneer No cost • Paint -\$110 <p>Oval top cap</p> <ul style="list-style-type: none"> • Wood veneer No cost • Paint -\$110 <p>Square change-of-height at both ends, cable management top cap</p> <ul style="list-style-type: none"> • Wood veneer +\$ 6 • Paint -\$110 		<p>Specify with <i>square wood top cap</i>.</p> <p>Specify with <i>square painted top cap</i>.</p> <p>Specify with <i>oval wood top cap</i>.</p> <p>Specify with <i>oval painted top cap</i>.</p> <p>Specify with <i>square change-of-height wood top cap</i>.</p> <p>Specify with <i>square change-of-height painted top cap</i>.</p>

For laminate price group 2 pricing, please refer to the electronic catalog or SmartTools.

Tip: Actual width of Answer transaction worksurface is 6" shorter than the nominal planning dimension to accommodate change-of-height panel applications.



▶ Worksurface Edge Matrix in Elective Elements Wood Systems Furniture Specification Guide.

Related Products	
<ul style="list-style-type: none"> • Montage panels and supports • Answer panels and supports 	<ul style="list-style-type: none"> ▶ See <i>Montage Solutions Specification Guide</i>. ▶ See <i>Answer Solutions Specification Guide</i>.

SIN 711.2

Specification Information								
Dimensions		Style Number	Base Prices					
D	W		Wood Group 1			Laminate Price Group 1		
			Wood Square Edge	Wood Bullnose Edge	Wood Blade Edge	3 mm Plastic Square Edge	Laminate Blade Edge	Wood Square or Bullnose Edge

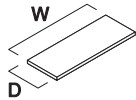

Transaction Top Worksurfaces

For Use with Montage Panels

15¾"	30"	E6WJ1530M	\$617	\$695	\$721	\$369	\$465	\$530
15¾"	36"	E6WJ1536M	\$644	\$722	\$748	\$396	\$492	\$557
15¾"	42"	E6WJ1542M	\$674	\$752	\$778	\$426	\$522	\$587
15¾"	48"	E6WJ1548M	\$700	\$778	\$804	\$452	\$548	\$613
15¾"	60"	E6WJ1560M	\$770	\$848	\$874	\$486	\$603	\$682

For Use with Answer Panels

15¾"	30"	E6WJ1530A	\$617	\$695	\$721	\$369	\$465	\$530
15¾"	36"	E6WJ1536A	\$644	\$722	\$748	\$396	\$492	\$557
15¾"	42"	E6WJ1542A	\$674	\$752	\$778	\$426	\$522	\$587
15¾"	48"	E6WJ1548A	\$700	\$778	\$804	\$452	\$548	\$613
15¾"	60"	E6WJ1560A	\$770	\$848	\$874	\$486	\$603	\$682

Personal Table Tops

Wood Veneer or Laminate

SIN 711.2

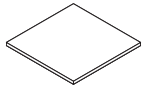

Standard Includes	Required to Specify
-------------------	---------------------

- Worksurface: wood group 1 veneer or laminate price group 1
- Wood group 1 worksurface with wood edge:
 - Solid wood edge on all sides
- Laminate worksurface with plastic edge:
 - 3 mm plastic edge on all sides
- Laminate worksurface with wood edge:
 - Solid wood edge on all sides

- 1 Style number
 - 2 Wood or laminate color number for worksurface
 - 3 Wood or plastic edge color number for all sides on laminate worksurface, if selected
 - 4 Worksurface profile (see below under Required Selections)
 - 5 Options, if selected (see below)
- ▶ See *Surface Materials*, page 566.

Required Selections (Prices at Right)

Wood Worksurface Edge Profiles

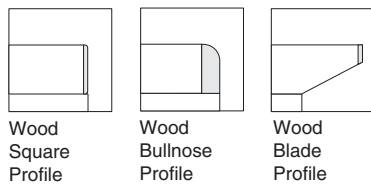

Laminate Worksurface Edge Profiles

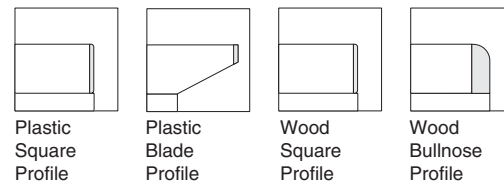

Options	Price	Required to Specify
---------	-------	---------------------

Surface Materials

Wood veneer worksurfaces

- Wood group 2 +\$ 47
- Wood group 3 +\$164
- Customiz stain No cost
- Full-fill finish on wood group 1 (not available on laminate worksurfaces with wood edge) +\$ 47

Specify wood color number.
Specify wood color number.
Specify *with Customiz stain*.
Specify wood veneer color number for worksurface.

Laminate worksurfaces

- Laminate price group 2 See information at left
- Open Line laminate +\$ 69 plus cost of laminate
- Wood group 2 on wood edge +\$ 47
- Wood group 3 on wood edge +\$164
- Customiz stain No cost

Specify laminate color number.
▶ See *Surface Materials Reference Manual*.
Specify wood color number.
Specify wood color number.
Specify *with Customiz stain*.

Related Products

- Convene disk base
- turnstone Groupwork table base

▶ See *Wood Casegoods and Tables Specification Guide*.
▶ See *turnstone Furniture Specification Guide*.

For laminate price group 2 pricing, please refer to the electronic catalog or SmartTools.

Tip: Refer to application guidelines in the specification guide from which you are selecting.



▶ Worksurface Edge Matrix in *Elective Elements Wood Systems Furniture Specification Guide*.

SIN 711.2

Specification Information

Dimensions D W	Style Number	Base Prices					
		Wood Group 1			Laminate Price Group 1		
		Wood Square Edge	Wood Bullnose Edge	Wood Blade Edge	3 mm Plastic Square Edge	Laminate Blade Edge	Wood Square or Bullnose Edge

Square Table Worksurfaces

30"	30"	E6WQ3030	\$ 878	\$ 956	\$1016	\$546	\$ 692	\$ 789
36"	36"	E6WQ3636	\$1055	\$1133	\$1193	\$723	\$ 869	\$ 966

Round Table Worksurfaces

30" Diameter	E6WO30	\$1170	\$1248	\$1308	\$766	\$ 955	\$1080
36" Diameter	E6WO36	\$1278	\$1356	\$1416	\$825	\$1041	\$1186

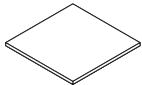

Worksurface Accessories

SIN 711.2

Wood Center Drawer

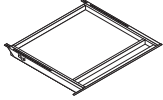

Tip: Dimensions given are outside dimensions. For inside dimensions: ▶ See *Elective Elements Wood Systems Furniture Specification Guide*.

Standard Includes	Required to Specify
<ul style="list-style-type: none"> • Non-locking center drawer: wood group 1 • Mounting frame: black paint only 	<ul style="list-style-type: none"> 1 Style number 2 Wood color number for center drawer 3 Options, if selected (see below) ▶ See <i>Surface Materials</i>, page 566.

Options	Price	Required to Specify
Surface Materials <ul style="list-style-type: none"> • Wood group 2 • Wood group 3 • Customiz stain 	<ul style="list-style-type: none"> +\$19 +\$71 No cost 	<ul style="list-style-type: none"> Specify wood color number. Specify wood color number. Specify with <i>Customiz stain</i>. ▶ See <i>Surface Materials Reference Manual</i>.

Specification Information				
• Dimensions			• Style	• Base
D	W	H	Number	Price
19 ³ / ₄ "	21 ⁵ / ₁₆ "	2 ¹ / ₄ "	AWAC23212	\$346

Plastic Center Drawer

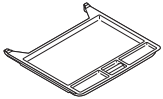

Tip: Dimensions given are outside dimensions. For inside dimensions: ▶ See *Elective Elements Wood Systems Furniture Specification Guide*.

Standard Includes	Required to Specify
<ul style="list-style-type: none"> • Non-locking center drawer: plastic • Drawer and slides: black textured plastic only 	<ul style="list-style-type: none"> Style number

Specification Information				
• Dimensions			• Style	• Price
D	W	H	Number	
19"	21"	1 ¹ / ₂ "	ASHC1921X1	\$85

Specifying Elective Elements Worksurface Supports

► For more detailed product information, see the *Elective Elements Wood Systems Furniture Specification Guide* or consult your Steelcase dealer.

Worksurface Supports

Plinth Base Supports

Back Panels (SIN 711.2)	248
Filler Panels (SIN 711.2)	250
End Panels (SIN 711.2)	252
Free Support End Panels (SIN 711.2)	256
T-Shape End Panels (SIN 711.2)	257
Extended T-Shape End Panels (Includes Modesty Panel) (SIN 711.2)	258
Corner Support Kits and Rear L-Shape Corner Support (SIN 711.2)	260
Center Support Panels (SIN 711.2)	261

Leg Base Supports

Back Panels (SIN 711.2)	262
Filler Panels (SIN 711.2)	263
End Panels (SIN 711.2)	264
Free Support End Panels (SIN 711.2)	265

Worksurface Supports for Use with Plinth Base and Leg Base Components

Modesty Panels (SIN 711.2)	266
Glass Modesty Panels (SIN 711.2)	270
Perpendicular Tether Supports (SIN 711.2)	271
Cable Shroud Supports (SIN 711.2)	272
Braces (SIN 711.2)	274
Legs and Supports (SIN 711.2)	276
Accessories for Supports (SIN 711.2)	278

Plinth Base Back Panels

Wood Veneer or Laminate

SIN 711.2

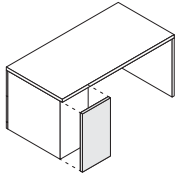

Tip: Use pedestal back panels when specifying 2/3-height modesty panels and overhanging worksurfaces in a desk configuration or if you want the back of a single pedestal finished.

Tip: Use full-height modesty panels to finish the back of two-high lateral files and other 30"W and 36"W pedestals.
▶ See Elective Elements Wood Systems Furniture Specification Guide.

Tip: For One-High open pedestals for use with Ology, add a finished back when visible from the rear.

For laminate price group 2 pricing, please refer to the electronic catalog or SmartTools.

Tip: Wood group 2 and 3 upcharges are in addition to wood group 1 upcharge.

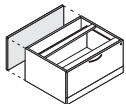
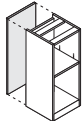
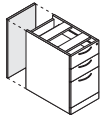

Standard Includes		Required to Specify	
<ul style="list-style-type: none"> Finished back panel: wood group 1 veneer or laminate price group 1 Attachment hardware: black paint only 		<ol style="list-style-type: none"> Style number Wood veneer or laminate color number for back panel (see prices below) Options, if selected (see below) ▶ See <i>Surface Materials</i> , page 566.	
Surface Materials	Options	Price	Required to Specify
	Wood veneer back panel		
	<ul style="list-style-type: none"> Wood group 2 Wood group 3 Customiz stain 	+\$ 47 +\$164 No cost	Specify wood color number. Specify wood color number. Specify <i>with Customiz stain</i> .
	Laminate back panel		
	<ul style="list-style-type: none"> Laminate price group 2 Open Line laminate 	See information at left +\$ 69 plus cost of laminate	Specify laminate color number. ▶ See <i>Surface Materials Reference Manual</i> .
Related Products	<ul style="list-style-type: none"> Worksurfaces Plinth base pedestals Plinth base one-high pedestals Plinth base high pedestals 		<ul style="list-style-type: none"> ▶ Page 209 ▶ Pages 282–288 ▶ Page 296 ▶ Page 302

Specification Information					
Dimensions			Style Number	Base Prices	
D	W	H		Wood Group 1	Laminate Price Group 1
.....
.....
.....
.....

Back Panels

For Use with 15"W or 18"W Pedestals

3/4"	15"	21 1/2"	E6NB1521P	\$203	\$143
3/4"	18"	21 1/2"	E6NB1821P	\$219	\$159
3/4"	15"	27 1/2"	E6NB1527P	\$203	\$143
3/4"	18"	27 1/2"	E6NB1827P	\$219	\$159

For Use with High Pedestals

3/4"	15"	35 7/8"	E6NB1536H	\$219	\$159
------	-----	---------	------------------	-------	-------

For Use with One-High Pedestals

3/4"	30"	15 1/2"	E6NB3015N	\$245	\$184
3/4"	36"	15 1/2"	E6NB3615N	\$263	\$202
.....

SIN 711.2

Plinth Base Filler Panels

SIN 711.2

For laminate price group 2 pricing, please refer to the electronic catalog or SmartTools.

Standard Includes		Required to Specify	
<ul style="list-style-type: none"> Finished filler panel: wood group 1 veneer or laminate price group 1 Attachment hardware: black paint only 		<ul style="list-style-type: none"> 1 Style number with appropriate suffix 2 Wood veneer or laminate color number for filler panel (see prices below) 3 Options, if selected (see below) ▶ See <i>Surface Materials</i>, page 566. 	
Options	Price	Required to Specify	
Surface Materials			
Wood veneer filler panel			
• Wood group 2	Prices below and at right	Specify wood color number.	
• Wood group 3	Prices below and at right	Specify wood color number.	
• Customiz stain	No cost	Specify <i>with Customiz stain</i> .	
Laminate filler panel			
• Laminate price group 2	See information at left +\$69	Specify laminate color number.	
• Open Line laminate	plus cost of laminate	▶ See <i>Surface Materials Reference Manual</i> .	
Related Products		▶ Page 222	
• Desk return worksurfaces		▶ Pages 282–288	
• Plinth base pedestals		▶ Page 292	
• Plinth base 1.5 high storage		▶ Page 296	
• Plinth base one-high pedestals			

Specification Information				
Dimensions D W H	Style Number	Base Prices		Options (Add \$ to Base Price)
		Wood Group 1	Laminate Price Group 1	
.....	Wood
.....	Wood : Wood
.....	Group 2 : Group 3

Filler Panels

For Use with Pedestals or L-Shape End Panels

3/4"	63/4"	27 1/2"	E6NF627P	\$114	\$ 78	+\$23	+\$78
------	-------	---------	-----------------	-------	-------	-------	-------

For Use with Back-to-Back Pedestals or L-Shape End Panels

1 1/2"	63/4"	27 1/2"	E6NF627B	\$172	\$118	+\$23	+\$78
--------	-------	---------	-----------------	-------	-------	-------	-------

For Use with Overhanging Worksurfaces in an L- or U-Shape Configuration

1 1/8"	53/8"	27 1/2"	E6NF627V	\$254	\$200	+\$23	+\$78
--------	-------	---------	-----------------	-------	-------	-------	-------

▶ Specification Information, continued on next page

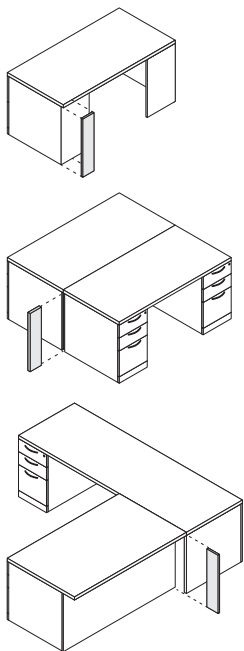

► Specification Information, continued from previous page

Specification Information							
Dimensions			Style Number	Base Prices		Options	
D	W	H		Wood Group 1	Laminate Price Group 1	(Add \$ to Base Price)	
						Wood	
						Wood	Wood
						Group 2	Group 3

Filler Panels, continued

For Use with 1.5 High Storage

3/4"	6 3/4"	21 1/2"	E6NF621M	\$110	\$ 75	+\$23	+\$78
------	--------	---------	-----------------	-------	-------	-------	-------

For Use with Back-to-Back 1.5 High Storage

1 1/2"	6 3/4"	21 1/2"	E6NF621D	\$165	\$113	+\$23	+\$78
--------	--------	---------	-----------------	-------	-------	-------	-------

For Use with One-High Pedestals

3/4"	6 3/4"	15 1/2"	E6NF615N	\$105	\$ 72	+\$23	+\$78
------	--------	---------	-----------------	-------	-------	-------	-------

For Use with Back-to-Back One-High Pedestals

1 1/2"	6 3/4"	15 1/2"	E6NF615A	\$154	\$105	+\$23	+\$78
--------	--------	---------	-----------------	-------	-------	-------	-------

For Use Above One-High Pedestals

3/4"	6"	10 3/4"	E6NF610C	\$105	\$ 72	+\$23	+\$78
------	----	---------	-----------------	-------	-------	-------	-------

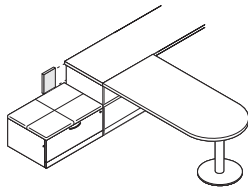
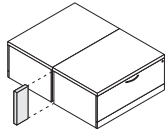
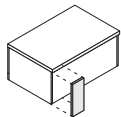
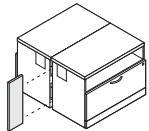
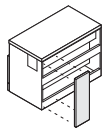

Plinth Base End Panels

Wood Veneer or Laminate

SIN 711.2

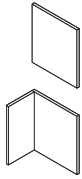

Right-hand shown

For laminate price group 2 pricing, please refer to the electronic catalog or SmartTools.

Standard Includes	Required to Specify
<ul style="list-style-type: none"> End panel: wood group 1 veneer or laminate price group 1 Attachment hardware: black paint only 	<ol style="list-style-type: none"> Style number with appropriate suffix Wood veneer or laminate color number for end panel (see prices below) Options, if selected (see below) <p>▶ See <i>Surface Materials</i>, page 566.</p>

Options	Price	Required to Specify
Surface Materials <ul style="list-style-type: none"> Wood veneer end panel <ul style="list-style-type: none"> Wood group 2 Wood group 3 Customiz stain Laminate end panel <ul style="list-style-type: none"> Laminate price group 2 Open Line laminate 	<ul style="list-style-type: none"> Prices below and at right Prices below and at right No cost See information at left +\$69 plus cost of laminate 	<ul style="list-style-type: none"> Specify wood color number. Specify wood color number. Specify with <i>Customiz stain</i>. Specify laminate color number. ▶ See <i>Surface Materials Reference Manual</i>.
Brackets For On-Module <ul style="list-style-type: none"> For use with Answer For use with Montage For use with Privacy Wall 	<ul style="list-style-type: none"> No cost No cost No cost 	<ul style="list-style-type: none"> Specify with <i>Answer bracket</i>. Specify with <i>Montage bracket</i>. Specify with <i>Privacy Wall bracket</i>.
Related Products <ul style="list-style-type: none"> Worksurfaces Modesty panels Plinth base pedestals Plinth base 1.5 high storage Plinth base one-high pedestals 		<ul style="list-style-type: none"> ▶ Page 209 ▶ Page 266 ▶ Pages 282–288 ▶ Page 292 ▶ Page 296

Specification Information				
Dimensions D W H	Style Number	Base Prices		Options (Add \$ to Base Price) Wood _____ Wood : Wood Group 2 : Group 3
		Wood Group 1	Laminate Price Group 1	

Tip: End panels less than 23 1/4"D should not be used in overhang configurations.

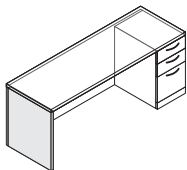

End Panels

For Use with 27 1/2" High Modesty Panels

Left-Hand

15"	1 1/8"	27 1/2"	E6NET1527L	\$335	\$243	+\$47	+\$164
17 1/4"	1 1/8"	27 1/2"	E6NET1727L	\$347	\$255	+\$47	+\$164
23 1/4"	1 1/8"	27 1/2"	E6NET2327L	\$361	\$269	+\$47	+\$164
29 1/4"	1 1/8"	27 1/2"	E6NET2927L	\$372	\$280	+\$47	+\$164

Right-Hand

15"	1 1/8"	27 1/2"	E6NET1527R	\$335	\$243	+\$47	+\$164
17 1/4"	1 1/8"	27 1/2"	E6NET1727R	\$347	\$255	+\$47	+\$164
23 1/4"	1 1/8"	27 1/2"	E6NET2327R	\$361	\$269	+\$47	+\$164
29 1/4"	1 1/8"	27 1/2"	E6NET2927R	\$372	\$280	+\$47	+\$164

▶ Specification Information, continued on next page

► Specification Information, continued from previous page

Specification Information							
Dimensions			Style Number	Base Prices		Options	
D	W	H		Wood Group 1	Laminate Price Group 1	(Add \$ to Base Price)	
						Wood	Wood
						Group 2	Group 3

End Panels, continued

For Use with Plinth Base 1.5 High Modesty Panels

Left-Hand

17¼"	17/16"	21½"	E6NET1721L	\$314	\$222	+\$47	+\$164
23¼"	17/16"	21½"	E6NET2321L	\$326	\$234	+\$47	+\$164

Right-Hand

17¼"	17/16"	21½"	E6NET1721R	\$314	\$222	+\$47	+\$164
23¼"	17/16"	21½"	E6NET2321R	\$326	\$234	+\$47	+\$164

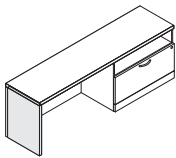

L-Shape End Panels

L-Shape for Use with No Modesty Panel

Left-Hand

15"	15"	27½"	E6NLT151527L	\$481	\$332	+\$69	+\$242
17¼"	15"	27½"	E6NLT171527L	\$494	\$345	+\$69	+\$242
23¼"	15"	27½"	E6NLT231527L	\$506	\$357	+\$69	+\$242
29¼"	15"	27½"	E6NLT291527L	\$519	\$370	+\$69	+\$242

Right-Hand

15"	15"	27½"	E6NLT151527R	\$481	\$332	+\$69	+\$242
17¼"	15"	27½"	E6NLT171527R	\$494	\$345	+\$69	+\$242
23¼"	15"	27½"	E6NLT231527R	\$506	\$357	+\$69	+\$242
29¼"	15"	27½"	E6NLT291527R	\$519	\$370	+\$69	+\$242

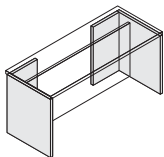

L-Shape for Use in Conjunction with Plinth Base 1.5 High Storage

Left-Hand

17¼"	15"	21½"	E6NLT171521L	\$458	\$309	+\$69	+\$242
23¼"	15"	21½"	E6NLT231521L	\$470	\$321	+\$69	+\$242

Right-Hand

17¼"	15"	21½"	E6NLT171521R	\$458	\$309	+\$69	+\$242
23¼"	15"	21½"	E6NLT231521R	\$470	\$321	+\$69	+\$242

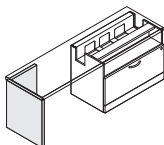

► Specification Information, continued on next page

Plinth Base End Panels, Wood Veneer or Laminate, continued

SIN 711.2

► Specification Information, continued from previous page

Specification Information							
Dimensions			Style Number	Base Prices		Options	
D	W	H		Wood Group 1	Laminate Price Group 1	(Add \$ to Base Price)	
						Wood	
						Wood Group 2	Wood Group 3

L-Shape End Panels, continued

L-Shape for Use Above One-High Pedestals

Left-Hand

17¼"	15"	10¾"	E6NLT171510L	\$421	\$290	+\$69	+\$242
23¼"	15"	10¾"	E6NLT231510L	\$434	\$303	+\$69	+\$242
29¼"	15"	10¾"	E6NLT291510L	\$446	\$315	+\$69	+\$242

Right-Hand

17¼"	15"	10¾"	E6NLT171510R	\$421	\$290	+\$69	+\$242
23¼"	15"	10¾"	E6NLT231510R	\$434	\$303	+\$69	+\$242
29¼"	15"	10¾"	E6NLT291510R	\$446	\$315	+\$69	+\$242

L-Shape for Use in Conjunction with One-High Pedestals

Left-Hand

17¼"	15"	15½"	E6NLT171515L	\$446	\$315	+\$69	+\$242
23¼"	15"	15½"	E6NLT231515L	\$460	\$329	+\$69	+\$242

Right-Hand

17¼"	15"	15½"	E6NLT171515R	\$446	\$315	+\$69	+\$242
23¼"	15"	15½"	E6NLT231515R	\$460	\$329	+\$69	+\$242

J-Shape End Panels

J-Shape for Use With Desk Worksurface

Left-Hand

24"	15"	27½"	E6NJT241527L	\$696	\$487	+\$69	+\$242
30"	15"	27½"	E6NJT301527L	\$720	\$511	+\$69	+\$242

Right-Hand

24"	15"	27½"	E6NJT241527R	\$696	\$487	+\$69	+\$242
30"	15"	27½"	E6NJT301527R	\$720	\$511	+\$69	+\$242

► Specification Information, continued on next page

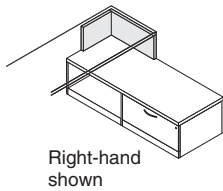

Tip: Recommended column and leg supports vary based on worksurface length and the support used on the opposite end. Refer to Worksurface Support Guidelines in Elective Elements Wood Systems Furniture Specifications Guide.

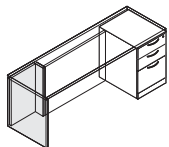
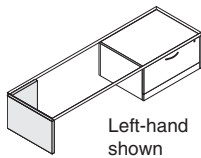

► Specification Information, continued from previous page

Specification Information							
Dimensions			Style Number	Base Prices		Options	
D	W	H		Wood Group 1	Laminate Price Group 1	(Add \$ to Base Price)	
						Wood _____	
						Wood Group 2	Wood Group 3

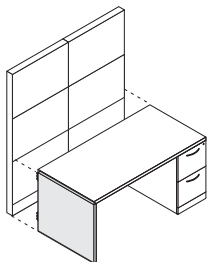

On Module End Panels

For Use with Answer Panels, Montage Panels, or Privacy Wall

Left-Hand

15"	17/16"	27 1/2"	E6NOT1527L	\$456	\$364	+\$47	+\$164
18"	17/16"	27 1/2"	E6NOT1827L	\$470	\$378	+\$47	+\$164
24"	17/16"	27 1/2"	E6NOT2427L	\$481	\$389	+\$47	+\$164
30"	17/16"	27 1/2"	E6NOT3027L	\$493	\$401	+\$47	+\$164

Right-Hand

15"	17/16"	27 1/2"	E6NOT1527R	\$456	\$364	+\$47	+\$164
18"	17/16"	27 1/2"	E6NOT1827R	\$470	\$378	+\$47	+\$164
24"	17/16"	27 1/2"	E6NOT2427R	\$481	\$389	+\$47	+\$164
30"	17/16"	27 1/2"	E6NOT3027R	\$493	\$401	+\$47	+\$164

Plinth Base Free Support End Panels

SIN 711.2



Tip: Free support end panels are replacements for the former full-height T-shape end panel style numbers.

For laminate price group 2 pricing, please refer to the electronic catalog or SmartTools.

Tip: For proper stability, bullet and P-top worksurfaces supported by 27½"H T-shape or extended T-shape end panels must be connected to a perpendicular worksurface forming an L- or U-shaped configuration.

Standard Includes	Required to Specify
<ul style="list-style-type: none"> Plinth base free support end panel: wood group 1 veneer or laminate price group 1 Steel gusset: black paint only Attachment hardware: black paint only 	<ol style="list-style-type: none"> Style number Wood veneer or laminate color number for end panel (see prices below) Options, if selected (see below) <p>▶ See <i>Surface Materials</i>, page 566.</p>

Options	Price	Required to Specify
Surface Materials		
Wood veneer end panel		
• Wood group 2	Prices below	Specify wood color number.
• Wood group 3	Prices below	Specify wood color number.
• Customiz stain	No cost	Specify with <i>Customiz stain</i> .
Laminate end panel		
• Laminate price group 2	See information at left	Specify laminate color number.
• Open Line laminate	+\$69 plus cost of laminate	▶ See <i>Surface Materials Reference Manual</i> .
Brackets For On-Module		
• For use with Answer	No cost	Specify with <i>Answer bracket</i> .
• For use with Montage	No cost	Specify with <i>Montage bracket</i> .
• For use with Privacy Wall	No cost	Specify with <i>Privacy Wall bracket</i> .
Related Products		
• Worksurfaces		▶ Page 209
• Modesty panels		▶ Page 266
• Plinth base pedestals		▶ Pages 282–288
• Plinth base 1.5 high storage		▶ Page 292
• Plinth base one-high pedestals		▶ Page 296

Specification Information							
Dimensions			Style Number	Base Prices		Options	
D	W	H		Wood Group 1	Laminate Price Group 1	(Add \$ to Base Price)	
						Wood	
						Wood Group 2	Wood Group 3
30"	6½"	27½"	E6NT30727	\$823	\$581	+\$69	+\$242
36"	6½"	27½"	E6NT36727	\$866	\$624	+\$69	+\$242

T-Shape End Panels

For Use with Plinth Base Storage

SIN 711.2

Standard Includes	Required to Specify
<ul style="list-style-type: none"> T-shape end panel: wood group 1 veneer or laminate price group 1 Attachment hardware: black paint only 	<ol style="list-style-type: none"> Style number with appropriate suffix Wood veneer or laminate color number for end panel (see prices below) Options, if selected (see below) <p>▶ See <i>Surface Materials</i>, page 566.</p>

Options	Price	Required to Specify
Surface Materials <ul style="list-style-type: none"> Wood veneer T-shape end panel <ul style="list-style-type: none"> Wood group 2 Wood group 3 Customiz stain 	<ul style="list-style-type: none"> Prices below Prices below No cost 	<ul style="list-style-type: none"> Specify wood color number. Specify wood color number. Specify <i>with Customiz stain</i>.

<ul style="list-style-type: none"> Laminate T-shape end panel <ul style="list-style-type: none"> Laminate price group 2 Open Line laminate 	<ul style="list-style-type: none"> See information at left +\$69 plus cost of laminate 	<ul style="list-style-type: none"> Specify laminate color number. ▶ See <i>Surface Materials Reference Manual</i>.
---	--	--

Related Products	
<ul style="list-style-type: none"> Bullet worksurfaces Column Disk column Plinth base 1.5 high storage Plinth base one-high pedestals 	<ul style="list-style-type: none"> ▶ Page 230 ▶ Page 276 ▶ Page 276 ▶ Page 292 ▶ Page 296

For laminate price group 2 pricing, please refer to the electronic catalog or SmartTools.

Tip: For proper stability, bullet worksurfaces supported by 27½"H T-shape or extended T-shape end panels must be connected to a perpendicular worksurface forming an L- or U-shaped configuration.

Specification Information						
Dimensions			Style Number	Base Prices		Options (Add \$ to Base Price)
D	W	H		Wood Group 1	Laminate Price Group 1	
						Wood
						Wood Group 2
						Wood Group 3

T-Shape End Panels

For Use with 1.5 High Storage

24"	12"	4 ² / ₅ "	E6NTT24124	\$375	\$244	+\$47	+\$164
30"	12"	4 ² / ₅ "	E6NTT30124	\$399	\$268	+\$47	+\$164
36"	12"	4 ² / ₅ "	E6NTT36124	\$421	\$290	+\$47	+\$164

For Use with One-High Pedestals

30"	12"	10 ³ / ₈ "	E6NTT301210	\$656	\$459	+\$69	+\$242
36"	12"	10 ³ / ₈ "	E6NTT361210	\$692	\$495	+\$69	+\$242

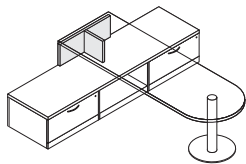
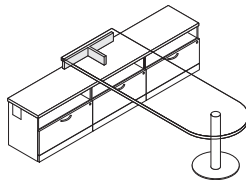

Tip: Recommended column and leg supports vary based on worksurface length and the support used on the opposite end. Refer to Worksurface Support Guidelines in Elective Elements Wood Systems Furniture Specifications Guide.

Plinth Base Extended T-Shape End Panels (Includes Modesty Panel)

SIN 711.2

Standard Includes	Required to Specify
<ul style="list-style-type: none"> Extended T-shape end panel, including end panel and 2/3-height modesty panel: wood group 1 veneer or laminate price group 1 Attachment hardware: black paint only (column ordered separately) 	<ol style="list-style-type: none"> 1 Style number with appropriate suffix 2 Wood veneer or laminate color number for extended T-shape end panel (see prices below) 3 Options, if selected (see below) <p>▶ See <i>Surface Materials</i>, page 566.</p>

Options	Price	Required to Specify
Surface		
Wood veneer extended T-shape end panel		
<ul style="list-style-type: none"> Wood group 2 Wood group 3 Customiz stain 	Prices below and at right Prices below and at right No cost	Specify wood color number. Specify wood color number. Specify with <i>Customiz stain</i> .
Laminate extended T-shape end panel		
<ul style="list-style-type: none"> Laminate price group 2 Open Line laminate 	See information at left +\$69 plus cost of laminate	Specify laminate color number. ▶ See <i>Surface Materials Reference Manual</i> .

Related Products	
<ul style="list-style-type: none"> Bullet worksurfaces Column Disk column 	▶ Page 230 ▶ Page 276 ▶ Page 276

For laminate price group 2 pricing, please refer to the electronic catalog or SmartTools.

Tip: For proper stability, bullet worksurfaces supported by 27 1/2" H T-shape or extended T-shape end panels must be connected to a perpendicular work-surface forming an L- or U-shaped configuration.

Specification Information			
Dimensions	Style Number	Base Prices	Options
D W H		Wood Group 1	Laminate Price Group 1
:	:	:	(Add \$ to Base Price)
:	:	:	Wood
:	:	:	Wood Group 2
:	:	:	Wood Group 3

Extended T-Shape End Panels

For Use with Freestanding Bullet Worksurfaces

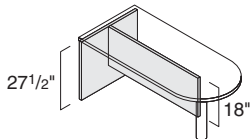

Length	Width	Height	Style Number	Wood Group 1 Price	Laminate Price Group 1	Option 1 Price	Option 2 Price
30"	42"	27 1/2"	E6NXT304227	\$1599	\$1357	+\$116	+\$407
30"	48"	27 1/2"	E6NXT304827	\$1635	\$1393	+\$142	+\$499
30"	54"	27 1/2"	E6NXT305427	\$1671	\$1429	+\$142	+\$499
30"	60"	27 1/2"	E6NXT306027	\$1681	\$1439	+\$142	+\$499
30"	66"	27 1/2"	E6NXT306627	\$1694	\$1452	+\$142	+\$499
30"	72"	27 1/2"	E6NXT307227	\$1707	\$1465	+\$203	+\$709
36"	39"	27 1/2"	E6NXT363927	\$1779	\$1537	+\$116	+\$407
36"	45"	27 1/2"	E6NXT364527	\$1815	\$1573	+\$142	+\$499
36"	51"	27 1/2"	E6NXT365127	\$1851	\$1609	+\$142	+\$499
36"	57"	27 1/2"	E6NXT365727	\$1863	\$1621	+\$142	+\$499
36"	63"	27 1/2"	E6NXT366327	\$1876	\$1634	+\$142	+\$499
36"	69"	27 1/2"	E6NXT366927	\$1888	\$1646	+\$203	+\$709

▶ Specification Information, continued on next page

Plinth Base Extended
T-Shape End Panels
(Includes Modesty Panel)

SIN 711.2

► **Specification Information, continued from previous page**

Specification Information							
Dimensions			Style Number	Base Prices		Options	
D	W	H		Wood Group 1	Laminate Price Group 1	(Add \$ to Base Price)	
						Wood	
						Wood Group 2	Wood Group 3

Extended T-Shape End Panels, continued

For Use with Freestanding P-Top Worksurfaces

Left-Hand

30"	44"	27½"	E6NXT304427L	\$1562	\$1320	+\$116	+\$407
30"	50"	27½"	E6NXT305027L	\$1599	\$1357	+\$142	+\$499
36"	51"	27½"	E6NXT365127L	\$1779	\$1537	+\$142	+\$499

Right-Hand

30"	44"	27½"	E6NXT304427R	\$1562	\$1320	+\$116	+\$407
30"	50"	27½"	E6NXT305027R	\$1599	\$1357	+\$142	+\$499
36"	51"	27½"	E6NXT365127R	\$1779	\$1537	+\$142	+\$499

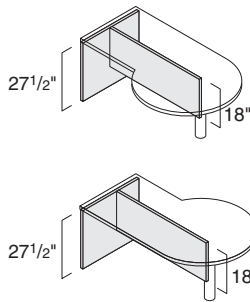

Plinth Base Corner Support Kits and Rear L-Shape Corner Support

SIN 711.2

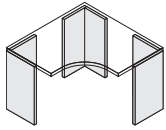

Tip: When specifying modesty panels for use with corner support kits, order modesty panels that are 12" shorter than the worksurface width where the modesty panel will be located.

Tip: Corner support kits are not available in leg base applications. Plinth base corner support kits are still a feasible option to be used within a leg base application, if needed.

For laminate price group 2 pricing, please refer to the electronic catalog or SmartTools.

Standard Includes	Required to Specify
<ul style="list-style-type: none"> • Corner support kit, including one rear L-shape corner support and two L-shape end panels: wood group 1 veneer or laminate price group 1 • Rear L-shape corner support: wood veneer or laminate • Attachment hardware: black paint only 	<ol style="list-style-type: none"> 1 Style number with appropriate suffix 2 Wood veneer or laminate color number for corner support kit or rear L-shape corner support (see prices below) 3 Options, if selected (see below) <p>▶ See <i>Surface Materials</i>, page 566.</p>

Options	Price	Required to Specify
Surface Materials		
Wood veneer corner support kit or rear L-shape corner support		
• Wood group 2	Prices below	Specify wood color number.
• Wood group 3	Prices below	Specify wood color number.
• Customiz stain	No cost	Specify <i>with Customiz stain</i> .
Laminate corner support kit or rear L-shape corner support		
• Laminate price group 2	See information at left	Specify laminate color number.
• Open Line laminate	+\$69 plus cost of laminate	▶ See <i>Surface Materials Reference Manual</i> .

Related Products	
• Corner worksurfaces	▶ Page 238
• Extended corner worksurfaces	▶ Page 240
• Plinth base L-shape end panels	▶ Page 252

Specification Information				
Dimensions	Style Number	Base Prices		Options
		Wood Group 1	Laminate Price Group 1	(Add \$ to Base Price)
				Wood
				Wood : Wood
				Group 2 : Group 3

Corner Support Kits

One 12" x 12" support, Two 15" x 15" supports, left and right	E6QKT151215	\$1049	\$723	+\$47	+\$164
One 15" x 15" support left, One 12" x 12" support, One 23 1/4" x 15" support right	E6QKT151223	\$1176	\$784	+\$47	+\$164
One 23 1/4" x 15" support left, One 12" x 12" support, One 15" x 15" support right	E6QKT231215	\$1176	\$784	+\$47	+\$164
One 12" x 12" support, Two 23 1/4" x 15" supports, left and right	E6QKT231223	\$1243	\$844	+\$47	+\$164

Tip: If an extended corner worksurface is supported by a pedestal or lateral file on one end, then specify a rear L-shape corner support and an L-shape end panel separately to support the back and other end.

Rear L-Shape Corner Support

One 12" x 12" support	E6QCT1212	\$338	\$237	+\$47	+\$164
-----------------------	------------------	-------	-------	-------	--------

Plinth Base Center Support Panels

SIN 711.2

For laminate price group 2 pricing, please refer to the electronic catalog or SmartTools.

Tip: When calculating unsupported spans, the 15" portion of an L-shaped end panel that runs along the back edge should not be considered. Measure the portion of the end panel that runs front-to-back.

Tip: For unsupported spans from 60"W to 90"W, use one worksurface brace or a center support panel. For spans greater than 90"W, a center support panel must be used.

Tip: 8"D center support panels are used with 18"D worksurfaces. 24"D and 30"D worksurfaces must use the 11"D center support panel.

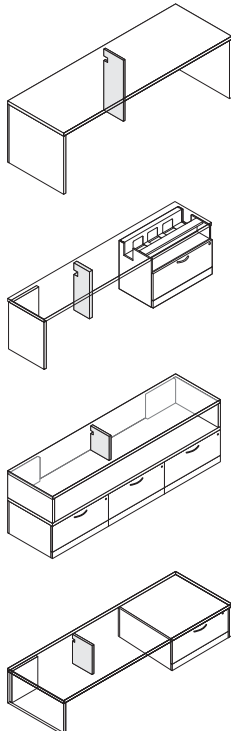

Standard Includes		Required to Specify	
<ul style="list-style-type: none"> Center support panel: wood group 1 veneer or laminate price group 1 Attachment hardware: black paint only 		<ul style="list-style-type: none"> 1 Style number with appropriate suffix 2 Wood veneer or laminate color number for center support panel (see prices below) 3 Options, if selected (see below) <p>▶ See <i>Surface Materials</i>, page 566.</p>	
Options	Price	Required to Specify	
Surface Materials			
Wood veneer center support panel			
<ul style="list-style-type: none"> Wood group 2 Wood group 3 Customiz stain 	Prices below Prices below No cost	Specify wood color number. Specify wood color number. Specify with <i>Customiz stain</i> .	
Laminate center support panel			
<ul style="list-style-type: none"> Laminate price group 2 Open Line laminate 	See information at left +\$69 plus cost of laminate	Specify laminate color number. ▶ See <i>Surface Materials Reference Manual</i> .	
Related Products	<ul style="list-style-type: none"> Worksurface braces 	▶ Page 274	

Specification Information								
Dimensions			Style Number		Base Prices		Options	
D	W	H	Number		Wood Group 1	Laminate Price Group 1	(Add \$ to Base Price)	
.....	Wood	
.....	Wood	Wood
.....	Group 2	Group 3

Center Support Panels

For Spans Greater Than 60"W

8"	¾"	27½"	E6NC827	\$295	\$239	+\$28	+\$94
11"	¾"	27½"	E6NC1127	\$308	\$252	+\$28	+\$94

For Use at 1.5 High Storage Height For Spans Greater Than 60"W

8"	1½"	21½"	E6NC821	\$281	\$225	+\$28	+\$94
11"	1½"	21½"	E6NC1121	\$292	\$236	+\$28	+\$94

For Use Above One-High Pedestal for Spans Greater Than 60"W

8"	¾"	10¾"	E6NC810	\$264	\$214	+\$28	+\$94
11"	¾"	10¾"	E6NC1110	\$278	\$228	+\$28	+\$94

For Use at One-High Height For Spans Greater Than 60"W

8"	¾"	15½"	E6NC815	\$276	\$226	+\$28	+\$94
11"	¾"	15½"	E6NC1115	\$287	\$237	+\$28	+\$94

Leg Base Back Panel

Wood Veneer or Laminate

SIN 711.2

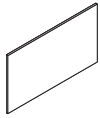

Standard Includes	Required to Specify
<ul style="list-style-type: none"> Finished back panel: wood group 1 veneer or laminate price group 1 Attachment hardware: black paint only 	<ol style="list-style-type: none"> Style number Wood veneer or laminate color number for back panel Options, if selected (see below) <ul style="list-style-type: none"> ▶ See <i>Surface Materials</i>, page 566.

Options	Price	Required to Specify
Surface Materials		
Wood veneer back panel		
• Wood group 2	+\$ 47	Specify wood color number.
• Wood group 3	+\$164	Specify wood color number.
• Customiz stain	No cost	Specify <i>with Customiz stain</i> .
Laminate back panel		
• Laminate price group 2	See information at left	Specify laminate color number.
• Open Line laminate	+\$ 69 plus cost of laminate	▶ See <i>Surface Materials Reference Manual</i> .
Related Products		
• Worksurfaces		▶ Page 209
• Leg base high pedestals		▶ Page 356

For laminate price group 2 pricing, please refer to the electronic catalog or SmartTools.

Specification Information					
Dimensions			Style	Base Prices	
D	W	H	Number	Wood Group 1	Laminate Price Group 1

For Use with High Pedestals

3/4"	147/8"	267/8"	E6NBL1527H	\$203	\$143

Leg Base Filler Panel

Leg Base Filler Panel

SIN 711.2

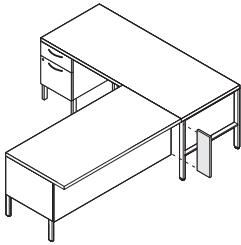

Tip: The leg base filler panel cannot be used in conjunction with the gate leg.

For laminate price group 2 pricing, please refer to the electronic catalog or SmartTools.

Standard Includes	Required to Specify
<ul style="list-style-type: none"> Finished filler panel: wood group 1 veneer or laminate price group 1 Attachment hardware: black paint only 	<ol style="list-style-type: none"> Style number Wood veneer or laminate color number for filler panel Options, if selected (see below) <p>▶ See <i>Surface Materials</i>, page 566.</p>

Options	Price	Required to Specify
Surface Materials Wood veneer filler panel <ul style="list-style-type: none"> Wood group 2 Wood group 3 Customiz stain 	Prices below Prices below No cost	Specify wood color number. Specify wood color number. Specify with <i>Customiz stain</i> .
Laminate filler panel <ul style="list-style-type: none"> Laminate price group 2 Open Line laminate 	See information at left +\$69 plus cost of laminate	Specify laminate color number. ▶ See <i>Surface Materials Reference Manual</i> .

Related Products	
<ul style="list-style-type: none"> Desk return worksurfaces Leg base 27¹/₂"H storage 	▶ Page 222 ▶ Page 350

Specification Information						
Dimensions			Style Number	Base Prices		Options (Add \$ to Base Price)
D	W	H		Wood Group 1	Laminate Price Group 1	
.....	Wood Group 2 : Wood Group 3 : Group 3

For Use with Overhanging Worksurfaces in a Leg Base Application

11 ¹ / ₈ "	5 ³ / ₄ "	18 ¹³ / ₁₆ "	E6NF618V	\$135	\$93	+\$23	+\$78
.....

Leg Base End Panels

SIN 711.2

Standard Includes	Required to Specify
<ul style="list-style-type: none"> End panel: wood group 1 veneer or laminate price group 1 Attachment hardware: black paint only Storage leg: paint or metal 	<ol style="list-style-type: none"> Style number with appropriate suffix Wood veneer or laminate color number for end panel (see prices below) Paint or metal color number for storage leg Options, if selected (see below) <p>▶ See <i>Surface Materials</i>, page 566.</p>

Surface Materials	Options	Price	Required to Specify
	Wood veneer end panel <ul style="list-style-type: none"> Wood group 2 Wood group 3 Customiz stain 	Prices below Prices below No cost	Specify wood color number. Specify wood color number. Specify <i>with Customiz stain</i> .
	Laminate end panel <ul style="list-style-type: none"> Laminate price group 2 Open Line laminate 	See information at left +\$69 plus cost of laminate	Specify laminate color number. ▶ See <i>Surface Materials Reference Manual</i> .
Related Products <ul style="list-style-type: none"> Worksurfaces Modesty panels Leg base 27¹/₂"H storage 			▶ Page 209 ▶ Page 266 ▶ Page 350

For laminate price group 2 pricing, please refer to the electronic catalog or SmartTools.

Specification Information						
Dimensions			Style Number	Base Prices		Options (Add \$ to Base Price)
D	W	H		Wood Group 1	Laminate Price Group 1	
.....	Wood Wood Group 2 Wood Group 3

Tip: End panels less than 23¹/₄"D should not be used in overhang configurations.

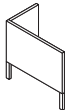

End Panels

For Use with 27¹/₂" High Leg Base Storage

Left-Hand

15"	15"	27 ¹ / ₂ "	E6NLL151527L	\$713	\$566	+\$69	+\$242
18"	15"	27 ¹ / ₂ "	E6NLL181527L	\$727	\$580	+\$69	+\$242
24"	15"	27 ¹ / ₂ "	E6NLL241527L	\$739	\$592	+\$69	+\$242

Right-Hand

15"	15"	27 ¹ / ₂ "	E6NLL151527R	\$713	\$566	+\$69	+\$242
18"	15"	27 ¹ / ₂ "	E6NLL181527R	\$727	\$580	+\$69	+\$242
24"	15"	27 ¹ / ₂ "	E6NLL241527R	\$739	\$592	+\$69	+\$242

Leg Base Free Support End Panels

SIN 711.2



Tip: Cannot be used to support freestanding work-surface. Must be used in an L- or U-shape configuration.

For laminate price group 2 pricing, please refer to the electronic catalog or SmartTools.

Standard Includes		Required to Specify	
<ul style="list-style-type: none"> Free support end panel: wood group 1 veneer or laminate price group 1 Storage leg: paint or metal Steel gusset: black paint only Attachment hardware: black paint only 		<ol style="list-style-type: none"> Style number Wood veneer or laminate color number for end panel Paint or metal color number for storage leg Options, if selected (see below) <p>▶ See <i>Surface Materials</i>, page 566.</p>	
Options		Price	Required to Specify
Surface Materials	Wood veneer free support end panel		
	<ul style="list-style-type: none"> Wood group 2 Wood group 3 Customiz stain 	Prices below Prices below No cost	Specify wood color number. Specify wood color number. Specify with <i>Customiz stain</i> .
	Laminate free support end panel		
	<ul style="list-style-type: none"> Laminate price group 2 Open Line laminate 	See information at left +\$69 plus cost of laminate	Specify laminate color number. ▶ See <i>Surface Materials Reference Manual</i> .
Brackets For On-Module	<ul style="list-style-type: none"> For use with Answer For use with Montage For use with Privacy Wall 	No cost No cost No cost	Specify with <i>Answer bracket</i> . Specify with <i>Montage bracket</i> . Specify with <i>Privacy Wall bracket</i> .
Related Products	<ul style="list-style-type: none"> Worksurfaces Modesty panels Leg base 27¹/₂"H storage Leg base 21¹/₂"H storage 		▶ Page 209 ▶ Page 266 ▶ Page 350 ▶ Page 348

Specification Information						
Dimensions			Style	Base Prices		Options
D	W	H	Number	Wood Group 1	Laminate Price Group 1	Wood
30"	7 ⁷ / ₁₆ "	27 ¹ / ₂ "	E6NTL30727	\$1030	\$788	+\$69 +\$242
36"	7 ⁷ / ₁₆ "	27 ¹ / ₂ "	E6NTL36727	\$1073	\$831	+\$69 +\$242
.

Elective Elements

Modesty Panels

Wood Veneer or Laminate

SIN 711.2

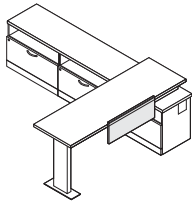

For laminate price group 2 pricing, please refer to the electronic catalog or SmartTools.

Tip: When woodgrain laminates are specified, the grain direction runs vertically for modesty panels up to 60"W, and horizontally for modesty panels from 66"W to 120"W.

Standard Includes	Required to Specify
-------------------	---------------------

- Modesty panel: wood group 1 veneer or laminate price group 1
- Attachment hardware: paint

- 1 Style number
 - 2 Wood veneer or laminate color number for modesty panel (see prices at right)
 - 3 Paint color number for attachment hardware:
0835 Black
4799 Platinum Metallic
 - 4 Options, if selected (see below)
- ▶ See *Surface Materials*, page 566.

Options	Price	Required to Specify
---------	-------	---------------------

Surface Materials

Wood veneer modesty panel

- Wood group 2
Prices at right
- Wood group 3
Prices at right
- Customiz stain
No cost

- Specify wood color number.
- Specify wood color number.
- Specify with *Customiz stain*.

Laminate modesty panel

- Laminate price group 2
See information at left +\$69 plus cost of laminate
- Open Line laminate

- Specify laminate color number.
- ▶ See *Surface Materials Reference Manual*.

Center Pass-Through

- Pass-through option for full-height modesty panel for credenza
+\$23

- Specify with *pass-through*.

Hanging Brackets

- Hanging bracket option for 2/3-height modesty panel for meeting and extended bullet worksurfaces
No cost

- Specify with *hanging brackets and select finishes*.

Related Products

- Worksurfaces
- Plinth base and leg base end panels
- Adjustable-height legs
- Plinth base pedestals
- Plinth base 1.5 high storage
- Leg base 21 1/2"H storage
- Leg base 27 1/2"H storage

- ▶ Page 209
- ▶ Pages 252–258 and 264–265
- ▶ Page 276
- ▶ Pages 282–288
- ▶ Page 292
- ▶ Page 348
- ▶ Page 350

Specification Information

• Dimensions			• Style	• Base Prices		• Options	
D	W	H	Number	Wood	Laminate	(Add \$ to Base Price)	
				Group 1	Price	Group 1	Wood
							Wood
							Group 2
							Group 3

Modesty Panels

12"H Modesty Panels for Desks, Meeting and Extended Bullet Worksurfaces

For Use with Plinth Base and Leg Base Application

3/4"	24"	12"	E6NM2412	\$233	\$ 94	+\$ 47	+\$164
3/4"	30"	12"	E6NM3012	\$278	\$139	+\$ 47	+\$164
3/4"	36"	12"	E6NM3612	\$321	\$182	+\$ 47	+\$164
3/4"	42"	12"	E6NM4212	\$364	\$225	+\$ 47	+\$164
3/4"	48"	12"	E6NM4812	\$407	\$268	+\$ 47	+\$164
3/4"	54"	12"	E6NM5412	\$450	\$311	+\$ 47	+\$164
3/4"	60"	12"	E6NM6012	\$493	\$354	+\$ 69	+\$242
3/4"	66"	12"	E6NM6612	\$536	\$397	+\$ 69	+\$242
3/4"	72"	12"	E6NM7212	\$579	\$440	+\$ 69	+\$242
3/4"	78"	12"	E6NM7812	\$678	\$508	+\$ 69	+\$242
3/4"	84"	12"	E6NM8412	\$742	\$572	+\$ 69	+\$242
3/4"	90"	12"	E6NM9012	\$830	\$660	+\$ 69	+\$242

2/3-Height Modesty Panels for Desks, Meeting and Extended Bullet Worksurfaces

For Use with Plinth Base and Leg Base Application

3/4"	42"	18"	E6NM4218	\$515	\$376	+\$ 69	+\$242
3/4"	48"	18"	E6NM4818	\$557	\$418	+\$ 96	+\$335
3/4"	54"	18"	E6NM5418	\$600	\$461	+\$ 96	+\$335
3/4"	60"	18"	E6NM6018	\$643	\$504	+\$124	+\$436
3/4"	66"	18"	E6NM6618	\$687	\$548	+\$124	+\$436
3/4"	72"	18"	E6NM7218	\$731	\$592	+\$157	+\$546
3/4"	78"	18"	E6NM7818	\$826	\$656	+\$157	+\$546
3/4"	84"	18"	E6NM8418	\$893	\$723	+\$157	+\$546
3/4"	90"	18"	E6NM9018	\$981	\$811	+\$157	+\$546

► **Specification Information, continued on next page**

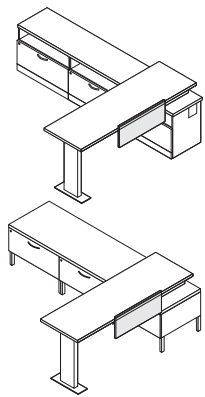

Tip: To determine the width of 12"H modesty panel to use with plinth base 1.5 high storage and cable shroud support, refer to the Cable Shroud Support and Modesty Panel Selection Guide.

► See Elective Elements Wood Systems Furniture Specification Guide.

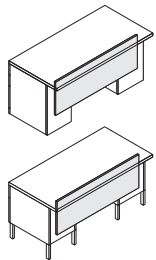

Tip: 2/3-height modesty panels can be used in conjunction with either plinth base or leg base storage.

Tip: 2/3-height desk modesty panels must attach to pedestal or leg support.

Tip: 2/3-height desk modesty panels should be used only with overhanging desk work-surfaces when a pedestal is used.

Tip: 2/3-height modesty panels are used with meeting and extended bullet worksurfaces. To determine the width of the modesty panel needed, refer to Modesty Panel Selection Guide for meeting and extended bullet worksurfaces.

► See Elective Elements Wood Systems Furniture Specification Guide.

Modesty Panels, Wood Veneer or Laminate, continued

SIN 711.2

► Specification Information, continued from previous page

Specification Information							
Dimensions			Style Number	Base Prices		Options	
D	W	H		Wood Group 1	Laminate Price Group 1	(Add \$ to Base Price)	
						Wood	
						Wood Group 2	Wood Group 3

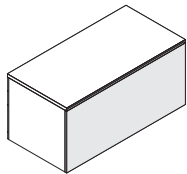

Tip: Optional pass-through for full-height modesty panels is unfinished.

Full-Height Modesty Panels for Desks/Credenzas and Backs for 30"W or 36"W, 27 1/2"H Pedestals

For Use with Plinth Base Application Only

Thickness	D	W	H	Style Number	Wood Price	Laminate Price	Option 1	Option 2
3/4"	24"	30"	27 1/2"	E6NM2427	\$ 429	\$ 290	+\$ 57	+\$203
3/4"	30"	36"	27 1/2"	E6NM3027	\$ 474	\$ 335	+\$ 69	+\$242
3/4"	36"	42"	27 1/2"	E6NM3627	\$ 518	\$ 379	+\$ 69	+\$242
3/4"	42"	48"	27 1/2"	E6NM4227	\$ 560	\$ 421	+\$ 69	+\$242
3/4"	48"	54"	27 1/2"	E6NM4827	\$ 603	\$ 464	+\$ 96	+\$335
3/4"	54"	60"	27 1/2"	E6NM5427	\$ 646	\$ 507	+\$ 96	+\$335
3/4"	60"	66"	27 1/2"	E6NM6027	\$ 690	\$ 551	+\$124	+\$436
3/4"	66"	72"	27 1/2"	E6NM6627	\$ 734	\$ 595	+\$124	+\$436
3/4"	72"	78"	27 1/2"	E6NM7227	\$ 775	\$ 636	+\$157	+\$546
3/4"	78"	84"	27 1/2"	E6NM7827	\$ 872	\$ 702	+\$157	+\$546
3/4"	84"	90"	27 1/2"	E6NM8427	\$ 938	\$ 768	+\$157	+\$546
3/4"	90"	96"	27 1/2"	E6NM9027	\$1026	\$ 832	+\$157	+\$546
3/4"	96"	102"	27 1/2"	E6NM9627	\$1093	\$ 899	+\$203	+\$709
3/4"	102"	108"	27 1/2"	E6NM10227	\$1158	\$ 964	+\$203	+\$709
3/4"	108"	114"	27 1/2"	E6NM10827	\$1223	\$1029	+\$203	+\$709
3/4"	114"	120"	27 1/2"	E6NM11427	\$1256	\$1062	+\$203	+\$709
3/4"	120"		27 1/2"	E6NM12027	\$1285	\$1091	+\$229	+\$804

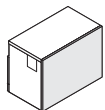

Full-Height Modesty and Back Panels for 1.5 High Storage

For Use with Plinth Base Application Only

Thickness	D	W	H	Style Number	Wood Price	Laminate Price	Option 1	Option 2
3/4"	30"	36"	21 1/2"	E6NM3021	\$ 444	\$ 305	+\$ 47	+\$164
3/4"	36"	42"	21 1/2"	E6NM3621	\$ 487	\$ 348	+\$ 69	+\$242
3/4"	42"	48"	21 1/2"	E6NM4221	\$ 531	\$ 392	+\$ 69	+\$242
3/4"	48"	54"	21 1/2"	E6NM4821	\$ 575	\$ 436	+\$ 96	+\$335
3/4"	54"	60"	21 1/2"	E6NM5421	\$ 618	\$ 479	+\$ 96	+\$335
3/4"	60"	66"	21 1/2"	E6NM6021	\$ 660	\$ 521	+\$124	+\$436
3/4"	66"	72"	21 1/2"	E6NM6621	\$ 703	\$ 564	+\$124	+\$436
3/4"	72"	78"	21 1/2"	E6NM7221	\$ 747	\$ 608	+\$157	+\$546
3/4"	78"	84"	21 1/2"	E6NM7821	\$ 845	\$ 675	+\$157	+\$546
3/4"	84"	90"	21 1/2"	E6NM8421	\$ 909	\$ 739	+\$157	+\$546
3/4"	90"	96"	21 1/2"	E6NM9021	\$ 998	\$ 828	+\$157	+\$546
3/4"	96"		21 1/2"	E6NM9621	\$1063	\$ 869	+\$203	+\$709

► Specification Information, continued on next page

► Specification Information, continued from previous page

Specification Information							
Dimensions			Style Number	Base Prices		Options	
D	W	H		Wood Group 1	Laminate Price Group 1	(Add \$ to Base Price)	
						Wood	
						Wood Group 2	Wood Group 3

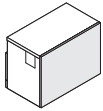

Full-Height Modesty Panels for 1.5 High Storage, continued

For Use with Plinth Base Application Only

3/4"	108"	21 1/2"	E6NM10821	\$ 1195	\$ 1001	+\$203	+\$709
3/4"	114"	21 1/2"	E6NM11421	\$ 1226	\$ 1032	+\$203	+\$709
3/4"	120"	21 1/2"	E6NM12021	\$ 1258	\$ 1064	+\$229	+\$804

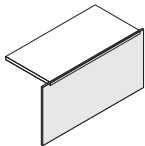

Full-Height Modesty Panels for Bridges

For Use with Plinth Base Application Only

For 42"W Bridge

3/4"	48"	27 1/2"	E6NM4827B	\$ 574	\$ 436	+\$ 69	+\$242
------	-----	---------	------------------	--------	--------	--------	--------

For 48"W Bridge

3/4"	54"	27 1/2"	E6NM5427B	\$ 618	\$ 480	+\$ 96	+\$335
------	-----	---------	------------------	--------	--------	--------	--------

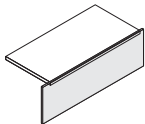

Full-Height Modesty Panels for Bridges in Leg Base Application

For Use with Leg Base Application Only

For 42"W Bridge

3/4"	48"	18 13/16"	E6NM4818B	\$ 574	\$ 436	+\$ 69	+\$242
------	-----	-----------	------------------	--------	--------	--------	--------

For 48"W Bridge

3/4"	54"	18 13/16"	E6NM5418B	\$ 618	\$ 480	+\$ 96	+\$335
------	-----	-----------	------------------	--------	--------	--------	--------

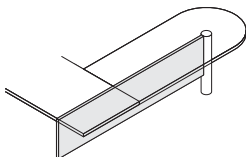

2/3-Height Modesty Panels for Use with Run-Off Worksurfaces*

For Use with Plinth Base and Leg Base Application

1 1/8"	39"	18"	E6NM3918R	\$ 530	\$ 391	+\$142	+\$499
1 1/8"	42"	18"	E6NM4218R	\$ 544	\$ 405	+\$142	+\$499
1 1/8"	45"	18"	E6NM4518R	\$ 563	\$ 424	+\$142	+\$499
1 1/8"	48"	18"	E6NM4818R	\$ 578	\$ 439	+\$142	+\$499
1 1/8"	51"	18"	E6NM5118R	\$ 589	\$ 450	+\$142	+\$499
1 1/8"	54"	18"	E6NM5418R	\$ 600	\$ 461	+\$142	+\$499
1 1/8"	57"	18"	E6NM5718R	\$ 623	\$ 484	+\$142	+\$499
1 1/8"	60"	18"	E6NM6018R	\$ 643	\$ 504	+\$169	+\$592
1 1/8"	64"	18"	E6NM6418R	\$ 660	\$ 521	+\$169	+\$592
1 1/8"	66"	18"	E6NM6618R	\$ 687	\$ 548	+\$169	+\$592
1 1/8"	69"	18"	E6NM6918R	\$ 708	\$ 569	+\$203	+\$709
1 1/8"	72"	18"	E6NM7218R	\$ 731	\$ 592	+\$203	+\$709
1 1/8"	75"	18"	E6NM7518R	\$ 793	\$ 623	+\$203	+\$709
1 1/8"	78"	18"	E6NM7818R	\$ 826	\$ 656	+\$203	+\$709
1 1/8"	81"	18"	E6NM8118R	\$ 860	\$ 690	+\$203	+\$709
1 1/8"	84"	18"	E6NM8418R	\$ 898	\$ 728	+\$203	+\$709

* To determine the width of the 2/3-height modesty panel needed, refer to *Modesty Panel Selection Guide for Run-Off Worksurfaces*

► See *Elective Elements Wood Systems Furniture Specification Guide*.

Glass Modesty Panels

SIN 711.2

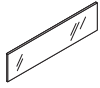

Tip: Glass modesty panels offer no structural support.

Tip: Glass modesty panel cannot mount in front of a power unit with cord pass-through due to bracket interference.

Tip: The glass modesty is available in two versions – end panel application and storage application. The storage application is 7/8" larger to fill the absence of headset on open storage in an L-shape application where the lack of open storage headset would adjoin against the modesty.

Tip: Use the glass modesty panels ending in "E" for any application with an end panel on both ends, end panel and storage on either end, or storage on both ends for tightest flush fit. This applies to both plinth and leg base applications.

Tip: When using the column leg application, specify separately rectangular column, column, or disk column leg for spacer.

Tip: Glass modesty panel cannot attach flush to same end of worksurface that has a pedestal as a support.

Standard Includes	Required to Specify
<ul style="list-style-type: none"> Glass modesty panel: glass and paint for back painted steel Attachment hardware 	<ol style="list-style-type: none"> Style number Glass color number for modesty panel Paint color number for back painted steel Options, if selected (see below) <p>▶ See <i>Surface Materials</i>, page 566.</p>

Options	Price	Required to Specify
Surface Materials <ul style="list-style-type: none"> Mirrored glass 	Prices below	Specify with <i>mirrored glass</i> .
Column Leg Application <ul style="list-style-type: none"> Column leg application 	+\$43	Specify with <i>column leg</i> .

Specification Information			
Dimensions	Style	Base	Options
W H	Number	Price	(Add \$ to Base Price)
.....	Glass
.....	Mirrored Glass

Glass Modesty Panels (For Use with End Panels)

For Use with Plinth Base and Leg Base Application

40 1/8"	12 1/16"	E6NMG4212E	\$ 908	+\$383
46 1/8"	12 1/16"	E6NMG4812E	\$1017	+\$383
52 1/8"	12 1/16"	E6NMG5412E	\$1124	+\$383
58 1/8"	12 1/16"	E6NMG6012E	\$1233	+\$527
64 1/8"	12 1/16"	E6NMG6612E	\$1341	+\$527
70 1/8"	12 1/16"	E6NMG7212E	\$1446	+\$527
40 1/8"	18 13/16"	E6NMG4218E	\$1285	+\$574
46 1/8"	18 13/16"	E6NMG4818E	\$1391	+\$574
52 1/8"	18 13/16"	E6NMG5418E	\$1499	+\$574
58 1/8"	18 13/16"	E6NMG6018E	\$1608	+\$789
64 1/8"	18 13/16"	E6NMG6618E	\$1717	+\$789
70 1/8"	18 13/16"	E6NMG7218E	\$1828	+\$789
.....

Glass Modesty Panels (For Use with Storage or Run-Off Applications)

For Use with Plinth Base and Leg Base Application

70 7/8"	12 1/16"	E6NMG7212S	\$1446	+\$527
40 7/8"	18 13/16"	E6NMG4218S	\$1285	+\$574
46 7/8"	18 13/16"	E6NMG4818S	\$1391	+\$574
52 7/8"	18 13/16"	E6NMG5418S	\$1499	+\$574
58 7/8"	18 13/16"	E6NMG6018S	\$1608	+\$789
64 7/8"	18 13/16"	E6NMG6618S	\$1717	+\$789
70 7/8"	18 13/16"	E6NMG7218S	\$1828	+\$789
.....

Perpendicular Tether Supports

SIN 711.2

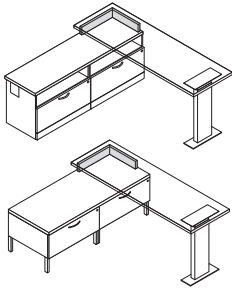

For laminate price group 2 pricing, please refer to the electronic catalog or SmartTools.

Tip: Depth of the perpendicular tether support is determined by the depth of the worksurface supported. Use a 19 5/8" D support for a 24" D worksurface. Use a 25 5/8" D support for a 30" D worksurface. Use a 31 5/8" D support for a 36" D worksurface.

Tip: Width of the perpendicular tether support is determined by the depth of the worksurface above the 1.5 high storage units. Use a 13 5/8" W support when the worksurface is 18" D. Use a 19 5/8" W support when the worksurface is 24" D.

Tip: Perpendicular tether supports are designed to work with desk worksurfaces. Any other worksurface will require holes to be drilled by installers.

Tip: The perpendicular support is not handed.

Standard Includes	Required to Specify
-------------------	---------------------

<ul style="list-style-type: none"> Perpendicular tether support: wood group 1 veneer or laminate price group 1 Attachment hardware: black paint only 	<ol style="list-style-type: none"> Style number with appropriate suffix Wood veneer or laminate color number for tether support (see prices below) Options, if selected (see below) <p>▶ See <i>Surface Materials</i>, page 566.</p>
--	---

Options	Price	Required to Specify
---------	-------	---------------------

Surface Materials	<ul style="list-style-type: none"> Wood veneer tether support <ul style="list-style-type: none"> Wood group 2 Wood group 3 Customiz stain Laminate tether support <ul style="list-style-type: none"> Laminate price group 2 Open Line laminate 	<ul style="list-style-type: none"> Prices below Prices below No cost <p>See information at left +\$69 plus cost of laminate</p>	<ul style="list-style-type: none"> Specify wood color number. Specify wood color number. Specify with <i>Customiz stain</i>. Specify laminate color number. ▶ See <i>Surface Materials Reference Manual</i>.
--------------------------	---	--	--

Related Products	
------------------	--

<ul style="list-style-type: none"> Technology desk worksurfaces Bullet worksurfaces P-Top worksurfaces Plinth base 1.5 high storage Rectangular column leg Column Disk column Freestanding table base Leg base 27 1/2" H storage 	<ul style="list-style-type: none"> ▶ Page 218 ▶ Page 230 ▶ Page 232 ▶ Page 292 ▶ Page 276 ▶ Page 276 ▶ Page 276 ▶ Page 277 ▶ Page 350
---	--

Specification Information								
Dimensions			Style	Base Prices		Options		
D	W	H	Number	Wood Group 1	Laminate Price Group 1	Wood	Wood	Wood

.....
.....
.....
.....
.....
.....
.....
.....

For Use with Plinth Base 1.5 High Storage or Leg Base 21 1/2" H Storage							
---	--	--	--	--	--	--	--

19 5/8"	13 5/8"	4 5/8"	E6NPT19134	\$364	\$233	+\$47	+\$164
25 5/8"	13 5/8"	4 5/8"	E6NPT25134	\$375	\$244	+\$47	+\$164
31 5/8"	13 5/8"	4 5/8"	E6NPT31134	\$387	\$256	+\$47	+\$164
19 5/8"	19 5/8"	4 5/8"	E6NPT19194	\$375	\$244	+\$47	+\$164
25 5/8"	19 5/8"	4 5/8"	E6NPT25194	\$387	\$256	+\$47	+\$164
31 5/8"	19 5/8"	4 5/8"	E6NPT31194	\$399	\$268	+\$47	+\$164
.....

Elective Elements

Cable Shroud Supports

SIN 711.2

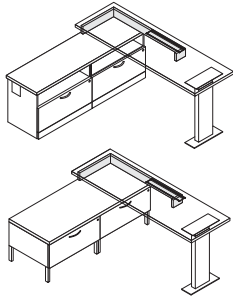

For laminate price group 2 pricing, please refer to the electronic catalog or SmartTools.

Tip: Width of cable shroud support is determined by the width of the technology desk work-surface with technology zone. 48"W cable shroud supports are used with 60"W desks. 54"W cable shroud supports are used with 66" and 72"W desks. Use 60"W cable shroud supports with 78" and 84"W desks and 66"W cable shroud supports with 90"W desks.

Standard Includes	Required to Specify
-------------------	---------------------

- | | |
|--|--|
| <ul style="list-style-type: none"> • Cable shroud support: wood group 1 veneer or laminate price group 1 • Attachment hardware: black paint only | <ul style="list-style-type: none"> 1 Style number with appropriate suffix 2 Wood veneer or laminate color number for cable shroud support (see prices at right) 3 Options, if selected (see below) ▶ See <i>Surface Materials</i>, page 566. |
|--|--|

Options	Price	Required to Specify
---------	-------	---------------------

Surface Materials

Wood veneer cable shroud support

- | | | |
|--|---|---|
| <ul style="list-style-type: none"> • Wood group 2 • Wood group 3 • Customiz stain | <ul style="list-style-type: none"> Prices at right Prices at right No cost | <ul style="list-style-type: none"> Specify wood color number. Specify wood color number. Specify <i>with Customiz stain</i>. |
|--|---|---|

Laminate cable shroud support

- | | | |
|--|--|--|
| <ul style="list-style-type: none"> • Laminate price group 2 • Open Line laminate | <ul style="list-style-type: none"> See information at left +\$69 plus cost of laminate | <ul style="list-style-type: none"> Specify laminate color number. ▶ See <i>Surface Materials Reference Manual</i>. |
|--|--|--|

Related Products

- | | |
|---|--|
| <ul style="list-style-type: none"> • Technology desk worksurfaces • 12"H modesty panels • Rectangular column leg • Column • Disk column • Freestanding table base • Plinth base 1.5 high storage • Leg base 27¹/₂"H storage | <ul style="list-style-type: none"> ▶ Page 218 ▶ Page 266 ▶ Page 276 ▶ Page 276 ▶ Page 276 ▶ Page 276 ▶ Page 292 ▶ Page 350 |
|---|--|

Specification Information

• Dimensions			• Style Number	• Base Prices		• Options	
D	W	H		Wood Group 1	Laminate Price Group 1	(Add \$ to Base Price)	Wood
							Wood : Wood Group 2 : Group 3

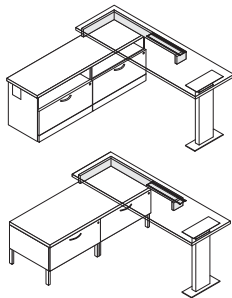

Cable Shroud Supports

For Use with Plinth Base 1.5 High Storage or Leg Base 21 1/2" H Storage

Left-Hand

19 5/8"	48"	4 5/8"	E6NST19484L	\$416	\$277	+\$47	+\$164
19 5/8"	54"	4 5/8"	E6NST19544L	\$426	\$287	+\$47	+\$164
19 5/8"	60"	4 5/8"	E6NST19604L	\$439	\$300	+\$47	+\$164
19 5/8"	66"	4 5/8"	E6NST19664L	\$450	\$311	+\$47	+\$164
25 5/8"	48"	4 5/8"	E6NST25484L	\$426	\$287	+\$47	+\$164
25 5/8"	54"	4 5/8"	E6NST25544L	\$439	\$300	+\$47	+\$164
25 5/8"	60"	4 5/8"	E6NST25604L	\$450	\$311	+\$47	+\$164
25 5/8"	66"	4 5/8"	E6NST25664L	\$461	\$322	+\$47	+\$164
31 5/8"	48"	4 5/8"	E6NST31484L	\$439	\$300	+\$47	+\$164
31 5/8"	54"	4 5/8"	E6NST31544L	\$450	\$311	+\$47	+\$164
31 5/8"	60"	4 5/8"	E6NST31604L	\$461	\$322	+\$47	+\$164
31 5/8"	66"	4 5/8"	E6NST31664L	\$474	\$335	+\$47	+\$164

Right-Hand

19 5/8"	48"	4 5/8"	E6NST19484R	\$416	\$277	+\$47	+\$164
19 5/8"	54"	4 5/8"	E6NST19544R	\$426	\$287	+\$47	+\$164
19 5/8"	60"	4 5/8"	E6NST19604R	\$439	\$300	+\$47	+\$164
19 5/8"	66"	4 5/8"	E6NST19664R	\$450	\$311	+\$47	+\$164
25 5/8"	48"	4 5/8"	E6NST25484R	\$426	\$287	+\$47	+\$164
25 5/8"	54"	4 5/8"	E6NST25544R	\$439	\$300	+\$47	+\$164
25 5/8"	60"	4 5/8"	E6NST25604R	\$450	\$311	+\$47	+\$164
25 5/8"	66"	4 5/8"	E6NST25664R	\$461	\$322	+\$47	+\$164
31 5/8"	48"	4 5/8"	E6NST31484R	\$439	\$300	+\$47	+\$164
31 5/8"	54"	4 5/8"	E6NST31544R	\$450	\$311	+\$47	+\$164
31 5/8"	60"	4 5/8"	E6NST31604R	\$461	\$322	+\$47	+\$164
31 5/8"	66"	4 5/8"	E6NST31664R	\$474	\$335	+\$47	+\$164

Braces

SIN 711.2

Worksurface Braces



Tip: Worksurfaces supported by pedestals or end panels that have unsupported spans from 60"W to 90"W, use one work surface brace or a center support panel. Select the work surface brace length closest to the unsupported span. For spans greater than 90"W, a center support panel must be used.

Tip: Worksurfaces supported by legs or tethered brackets that have unsupported spans less than 24"D x 84"W, use one work surface brace. For unsupported spans greater than 24"D x 84"W, two work surface braces are required for support.

Tip: When calculating unsupported spans, the 15" portion of an L-shaped end panel that runs along the back edge should not be considered. Measure the portion of the end panel that runs front-to-back.

Standard Includes	Required to Specify
<ul style="list-style-type: none"> • Worksurface brace: 4713 Black paint only 	Style number

Related Products
<ul style="list-style-type: none"> • Plinth base center support panels

Specification Information				
• Dimensions			• Style	• Price
D	W	H	Number	
:	:	:	:	:
:	:	:	:	:

Worksurface Braces

5"	45"	1"	AWQE45	\$49
5"	51"	1"	AWQE51	\$53
5"	57"	1"	AWQE57	\$67
5"	69"	1"	AWQE69	\$84
:	:	:	:	:

Tower Brace

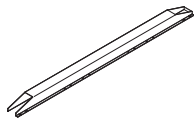

Tip: Two 15"W leg base towers can be supported on four legs. Use a tower brace and a suspension/ganging hardware kit to avoid extra storage legs at the seam.

Tip: Additional sizes of under-storage braces are available in Service Parts online.

Standard Includes	Required to Specify
-------------------	---------------------

- Tower brace: 4713 Black paint only

Style number

Related Products

- Leg base towers

▶ Pages 468–476

Specification Information				
• Dimensions			• Style	• Price
D	W	H	Number	

3 ¹ / ₄ "	28 ⁷ / ₈ "	27 ⁷ / ₈ "	E6BR30	\$124
---------------------------------	----------------------------------	----------------------------------	---------------	-------

Legs and Supports

SIN 711.2

Tip: Worksurfaces supported by legs or tethered brackets that have unsupported spans less than or equal to 24"D x 84"W, use one worksurface brace. Spans greater than 24"D x 84"W, two worksurface braces are required for support.

Tip: When specifying a rectangular column leg for use with a worksurface 78"W or larger, the rectangular column leg with base must be used.

Tip: The rectangular column leg is adjustable 2 1/4" to support worksurfaces up to 31"H.

Tip: Rectangular column legs, rectangular column legs with bases, columns, and disk columns should not be used to support freestanding tables. They are used to support the end of run-off worksurfaces.

Tip: The gate leg cannot be used with the Universal top or blade edge profile.

Tip: When using a blade edge profile, rules are slightly more stringent due to construction. ▶ See Elective Elements Specification Guide.

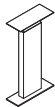

with base



disk column

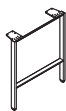

Standard Includes	Required to Specify
<ul style="list-style-type: none"> Rectangular column leg: paint Column: paint Disk column: paint Freestanding table base: paint Gate leg: paint Adjustable-height legs: paint Cord cover on adjustable-height legs: 6527 Merle plastic Parallel slip-fit support: paint Storage leg: paint or metal Storage legs with reveal, includes two legs and one reveal: paint or metal Attachment hardware: black paint only 	<ul style="list-style-type: none"> 1 Style number 2 Color number for rectangular column leg, column, disk column, gate leg, freestanding table base, adjustable-height legs, parallel slip-fit support, or storage legs, if selected 3 Options, if selected (see below) ▶ See <i>Surface Materials</i>, page 566.

Options	Price	Required to Specify
Surface Materials On column (AWQP4) <ul style="list-style-type: none"> Polished Chrome 	+\$114	Specify with 9201 Polished Chrome column.

Specification Information			
Dimensions			Style
D	W	H	Number
			Quantity
			Base Price

Rectangular Column Leg			
6"	1 3/4"	27 1/2"-31"	E6QR6227T 1 \$677

With Base			
6"	1 3/4"	27 1/2"-31"	E6QR6227TB 1 \$759

Column			
4" Diameter	AWQP4	1	\$515

Disk Column			
4" Diameter Column, 22" Disk	AWQD422	1	\$764

Gate Legs			
24"	1 1/2"	27 5/8"	E6GL24127 1 \$634
30"	1 1/2"	27 5/8"	E6GL30127 1 \$634

▶ Specification Information, continued on next page

► Specification Information, continued from previous page

Specification Information

Dimensions			Style	Quantity	Base
D	W	H	Number		Price



freestanding table base

Tip: Specify a 22" diameter base for 30" tops. Specify a 28" diameter base for 36" tops.

Tip: Glides on freestanding table bases are non-adjustable.

Freestanding Table Bases

4" Diameter Column, 22" Disk	AWQT22	1	\$780
4" Diameter Column, 28" Disk	AWQT28	1	\$871



adjustable-height leg

Tip: Power units with cord pass-through cannot be installed in left or right position when using adjustable-height legs.

Adjustable-Height Legs

2 1/2"	2 1/2"	24"–27"	E6QL24	1	\$304
2 1/2"	2 1/2"	27 1/2"–30 1/2"	E6QL27	1	\$304



parallel slip-fit support

Parallel Slip-Fit Support

7 1/2"	12 1/8"	E6SF712	1	\$520
--------	---------	----------------	---	-------



Tip: Storage legs are used for leg base storage components. Single legs are for replacement purposes.

Storage Legs

Single, Left-Hand Leg

1 1/2"	3/4"	8 3/4"	E6SL8SL	1	\$104
--------	------	--------	----------------	---	-------

Single, Right-Hand Leg

1 1/2"	3/4"	8 3/4"	E6SL8SR	1	\$104
--------	------	--------	----------------	---	-------

Tip: Storage legs with a reveal are for use on the outside of a leg base storage component. The reveal is used to finish the end panels of the unit.

Tip: When storage legs are shared between two units, the extra legs should be saved for later use, such as reconfiguration.

Tip: E6SL8SL and E6SL8SR are TAA compliant when purchased as service parts for a credenza, bookcase, or wardrobe application which is installed in the U.S. or designated country (as defined in FAR 52.225-5).

Tip: E6SL188R and E6SL248R are TAA compliant when purchased as part of a credenza, bookcase, or wardrobe application which is installed in the U.S. or designated country (as defined in FAR 52.225-5).

Storage Legs with Reveal

18"	8 3/4"	E6SL188R	2	\$259
24"	8 3/4"	E6SL248R	2	\$259

Accessories for Supports

SIN 711.2

Standard Includes	Required to Specify
-------------------	---------------------

- Bracket: black paint only
- Attachment hardware for bracket

Style number

Related Products

- Worksurfaces
- Modesty panels
- Plinth base and leg base end panels

- ▶ Page 209
- ▶ Page 266
- ▶ Pages 252–258 and 264–265

Specification Information	
---------------------------	--

Style Number	Price

End Panel to Modesty Panel Attachment Bracket

AWQB	\$23
-------------	------



Tip: End panel to modesty panel attachment bracket is shipped with corner support kits, rear L-shape corner supports, and return work-surfaces. These brackets are used to secure end panels to modesty panels at the base.

Felt Tape–100' Roll

AWAF100	\$73
----------------	------



Tip: Felt tape can be used to create consistent reveals between components and can be used to seal light leaks in back-to-back installations.

Flush-Mount Brackets

AWQF	\$26
-------------	------

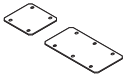

Tip: Flush-mount brackets are shipped with run-off, bridge, and return work-surfaces. Additional brackets may be ordered to align work-surfaces if needed.

Specifying Elective Elements Storage

Plinth Base Storage	281
Leg Base Storage	347
Above Worksurface Storage	483

Specifying Plinth Base Storage

Plinth Base Pedestals and Lateral Files

Pedestals (SIN 711.2)	282
Adjustable-Height Pedestals (SIN 711.2)	288
Pedestal Accessories (SIN 711.2)	290
1.5 High Storage (SIN 711.2)	292
Cable Access Cover (SIN 711.2)	295
One-High Pedestals (SIN 711.2)	296
Cushion Tops (SIN 711.2)	298
Mobile Pedestal (SIN 711.2)	300
High Pedestals (SIN 711.2)	302
Lateral Files (SIN 711.2)	304

Storage for Ology Application

One-High Open Plinth Base Pedestals for Ology Application (SIN 711.2)	308
Common Top for Ology Application (SIN 711.2)	310

Plinth Base Bookcases

Freestanding Bookcases—Open (SIN 711.2)	312
Freestanding Bookcases with Doors (SIN 711.2)	314
Stacking Bookcases—Open (SIN 711.2)	318
Stacking Bookcases with Doors (SIN 711.2)	320
Finished Back Panels for Stacking Bookcases (SIN 711.2)	324

Plinth Base Towers, Vertical Cabinets, and Wardrobes

Towers with Full-Height Doors (SIN 711.2)	326
Towers with Doors and Drawers (SIN 711.2)	330
Towers with Open Shelves and Drawers (SIN 711.2)	334
Vertical Cabinets (SIN 711.2)	338
Wardrobes (SIN 711.2)	342

► For more detailed product information, see the *Elective Elements Wood Systems Furniture Specification Guide* or consult your Steelcase dealer.

Plinth Base Pedestals

Wood Veneer or Laminate

SIN 711.2

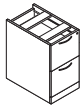

Standard Includes	Required to Specify
<ul style="list-style-type: none"> Underworksurface storage: <ul style="list-style-type: none"> –Wood group 1 case with wood group 1 front –Laminate price group 1 case with same or contrasting laminate front –Laminate price group 1 case with wood group 1 front Unfinished back Unfinished open top Dovetail drawer construction One fastened metal filing system per file drawer: black only One partition per box drawer: solid wood One pencil tray per two box drawers: solid wood Lock, keyed random Counterweight, if selected Standard close drawer slides 	<ol style="list-style-type: none"> Style number Wood or laminate color number for underworksurface storage Laminate color number for laminate fronts on laminate case, if selected Wood color number for wood fronts on laminate cases, if selected Pull shape (see below under Required Selections) Finish color number for pull Finish color number for lock Options, if selected (see below) <p>▶ See <i>Surface Materials</i>, page 566.</p>

Required Selections

Pull Shape

Contemporary	Jazz	Bar	Nile	Integral*	Transitional	Inset	Beam
No cost	+\$19 each	+\$26 each	+\$26 each	+\$26 each	+\$26 each	+\$26 each	+\$37 each

*Not available on laminate or composite fronts.

For laminate price group 2 pricing, please refer to the electronic catalog or SmartTools.

Tip: Glide hole covers are black and are visible in underworksurface bookcases.

Tip: When integral pull is specified with a 9250 Ember Chrome lock, the lock housing is black. When 9201 Polished Chrome lock is specified, the lock housing is nickel.

Tip: Locks are not available on pedestals with a single door specified with integral or beam pulls. Units with double doors and have an integral or beam pull do lock.

Tip: Metal shelves only available on hinged door and open units.

Tip: When selected, miter fold box drawers include one black plastic pencil tray. Plastic pencil tray is designed to fit 15"W box drawer, but ships with both 15"W and 18"W pedestal, the pencil tray rests on the bottom of the drawer.

Options	Price	Required to Specify
Surface Materials <ul style="list-style-type: none"> Wood underworksurface storage case <ul style="list-style-type: none"> Wood group 2 Wood group 3 Customiz stain Laminate underworksurface storage case <ul style="list-style-type: none"> Laminate price group 2 Open Line laminate Wood group 2 on wood fronts Wood group 3 on wood fronts Customiz stain 	<ul style="list-style-type: none"> Prices at right Prices at right No cost See information at left +\$ 69 plus cost of laminate Prices at right Prices at right No cost 	<ul style="list-style-type: none"> Specify wood color number. Specify wood color number. Specify <i>with Customiz stain</i>. Specify laminate color number. ▶ See <i>Surface Materials Reference Manual</i>. Specify wood color number. Specify wood color number. Specify <i>with Customiz stain</i>.
Drawer Slide <ul style="list-style-type: none"> Soft close drawer slides 	<ul style="list-style-type: none"> +\$ 30 per drawer 	<ul style="list-style-type: none"> Specify <i>with soft close drawers</i>.
Lock and Keying <ul style="list-style-type: none"> Lock <ul style="list-style-type: none"> Ember Chrome Polished Chrome Keying <ul style="list-style-type: none"> Factory- and field-installed keying units 	<ul style="list-style-type: none"> No cost No cost ▶ Page 622 	<ul style="list-style-type: none"> Specify <i>with 9250 Ember Chrome lock</i>. Specify <i>with 9201 Polished Chrome lock</i>.
Shelves <ul style="list-style-type: none"> 3/4" shelf Metal shelf 	<ul style="list-style-type: none"> No cost –\$ 26 per shelf 	<ul style="list-style-type: none"> Specify <i>with 3/4" shelf</i>. Specify <i>with metal shelves</i> and select paint color number.
Miter Fold Drawer <ul style="list-style-type: none"> (Not available on 17¼"D drawer units) For two file drawers or two lateral file drawers For two box and one file drawer 	<ul style="list-style-type: none"> –\$ 64 –\$101 	<ul style="list-style-type: none"> Specify <i>with miter fold drawers</i>. Specify <i>with miter fold drawers</i>.

▶ Options, continued on next page

► Options, continued from previous page

Tip: When selected, miter fold box drawers include one black plastic pencil tray.

Tip: Order finished back panels or modesty panels when units will be exposed.

Tip: When applying a cushion top to a freestanding 27½"H two-high lateral file, a finished back panel must be used.

Options	Price	Required to Specify	
Counterweight Package	<ul style="list-style-type: none"> Add counterweight package Omit counterweight package on drawer units Omit counterweight package on 23¼"D and 29¼"D two-high lateral files 	<ul style="list-style-type: none"> No cost -\$ 65 -\$130 	<ul style="list-style-type: none"> Specify with counterweight package. Specify with no counterweight package. Specify with no counterweight package.
Related Products	<ul style="list-style-type: none"> Worksurfaces Back panels for use with 15"W or 18"W pedestals Modesty panels Cushion top 	<ul style="list-style-type: none"> ► Page 209 ► Page 248 ► Page 266 ► Page 298 	

Specification Information										
Dimensions			Style Number	Base Prices			Options (Add \$ to Base Price)			
D	W	H		Wood Group 1 Case	Laminate Price Group 1 Case	Wood Group 1 Front	Laminate Price Group 1 Front	Wood Group 1 Front	Wood	Wood
								Wood Case with Wood Front	Laminate Case with Wood Front	
								Wood Group 2	Wood Group 3	Wood Group 2
										Wood Group 3

Plinth Base Pedestals



Two File Drawers

17¼"	15"	27½"	E6PD171527F	\$1472	\$ 990	\$1224	+\$71	+\$244	+\$28	+\$94
23¼"	15"	27½"	E6PD231527F	\$1472	\$ 990	\$1224	+\$71	+\$244	+\$28	+\$94
29¼"	15"	27½"	E6PD291527F	\$1558	\$1076	\$1310	+\$71	+\$244	+\$28	+\$94
17¼"	18"	27½"	E6PD171827F	\$1572	\$1090	\$1324	+\$71	+\$244	+\$28	+\$94
23¼"	18"	27½"	E6PD231827F	\$1572	\$1090	\$1324	+\$71	+\$244	+\$28	+\$94
29¼"	18"	27½"	E6PD291827F	\$1659	\$1177	\$1411	+\$71	+\$244	+\$28	+\$94



Two Box and One File Drawer

17¼"	15"	27½"	E6PD171527B	\$1587	\$1105	\$1339	+\$71	+\$244	+\$28	+\$94
23¼"	15"	27½"	E6PD231527B	\$1587	\$1105	\$1339	+\$71	+\$244	+\$28	+\$94
29¼"	15"	27½"	E6PD291527B	\$1673	\$1191	\$1425	+\$71	+\$244	+\$28	+\$94
17¼"	18"	27½"	E6PD171827B	\$1736	\$1254	\$1488	+\$71	+\$244	+\$28	+\$94
23¼"	18"	27½"	E6PD231827B	\$1736	\$1254	\$1488	+\$71	+\$244	+\$28	+\$94
29¼"	18"	27½"	E6PD291827B	\$1827	\$1345	\$1579	+\$71	+\$244	+\$28	+\$94

► Specification Information, continued on next page

Elective Elements

Plinth Base Pedestals, Wood Veneer or Laminate, continued

SIN 711.2

► **Specification Information, continued from previous page**

Specification Information											
Dimensions			Style Number	Base Prices			Options (Add \$ to Base Price)				
D	W	H		Wood Group 1 Case	Laminate Price Group 1 Case	Wood Group 1 Front	Laminate Price Group 1 Front	Wood Group 1 Front	Wood Case with Wood Front	Laminate Case with Wood Front	Wood Group 2

Plinth Base Pedestals, continued

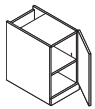

Hinged Door with One Adjustable Shelf

Hinged Left

17¼"	15"	27½"	E6PD171527L	\$1321	\$ 850	\$1073	+\$71	+\$244	+\$28	+\$94
23¼"	15"	27½"	E6PD231527L	\$1377	\$ 906	\$1129	+\$71	+\$244	+\$28	+\$94
17¼"	18"	27½"	E6PD171827L	\$1360	\$ 889	\$1112	+\$71	+\$244	+\$28	+\$94
23¼"	18"	27½"	E6PD231827L	\$1418	\$ 947	\$1170	+\$71	+\$244	+\$28	+\$94

Hinged Right

17¼"	15"	27½"	E6PD171527R	\$1321	\$ 850	\$1073	+\$71	+\$244	+\$28	+\$94
23¼"	15"	27½"	E6PD231527R	\$1377	\$ 906	\$1129	+\$71	+\$244	+\$28	+\$94
17¼"	18"	27½"	E6PD171827R	\$1360	\$ 889	\$1112	+\$71	+\$244	+\$28	+\$94
23¼"	18"	27½"	E6PD231827R	\$1418	\$ 947	\$1170	+\$71	+\$244	+\$28	+\$94

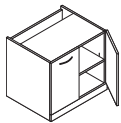

Two Hinged Doors with One Adjustable Shelf

17¼"	30"	27½"	E6PD173027D	\$1943	\$1249	\$1592	+\$87	+\$305	+\$28	+\$94
23¼"	30"	27½"	E6PD233027D	\$2024	\$1330	\$1673	+\$87	+\$305	+\$28	+\$94
29¼"	30"	27½"	E6PD293027D	\$2089	\$1395	\$1738	+\$87	+\$305	+\$28	+\$94
17¼"	36"	27½"	E6PD173627D	\$2000	\$1306	\$1649	+\$87	+\$305	+\$28	+\$94
23¼"	36"	27½"	E6PD233627D	\$2084	\$1390	\$1733	+\$87	+\$305	+\$28	+\$94

► **Specification Information, continued on next page**

► Specification Information, continued from previous page

Specification Information												
Dimensions			Style Number	Base Prices			Options					
D	W	H		Wood Group 1 Case	Laminate Price Group 1 Case	Wood Group 1 Front	Laminate Price Group 1 Front	Wood Group 1 Front	Wood Case with Wood Front	Laminate Case with Wood Front		
									Wood Group 2	Wood Group 3	Wood Group 2	Wood Group 3

Plinth Base Pedestals, continued

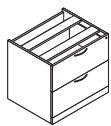

Two High Lateral Files

17¼"	30"	27½"	E6PD173027F	\$1998	\$1284	\$1647	+\$87	+\$305	+\$28	+\$94
23¼"	30"	27½"	E6PD233027F	\$1998	\$1284	\$1647	+\$87	+\$305	+\$28	+\$94
29¼"	30"	27½"	E6PD293027F	\$2093	\$1379	\$1742	+\$87	+\$305	+\$28	+\$94
17¼"	36"	27½"	E6PD173627F	\$2419	\$1496	\$2032	+\$87	+\$305	+\$28	+\$94
23¼"	36"	27½"	E6PD233627F	\$2419	\$1496	\$2032	+\$87	+\$305	+\$28	+\$94
29¼"	36"	27½"	E6PD293627F	\$2545	\$1622	\$2158	+\$87	+\$305	+\$28	+\$94

Specification Information												
Dimensions			Style Number	Base Prices			Options					
D	W	H		Wood Group 1 Case	Laminate Price Group 1 Case	Wood Group 1 Open Front	Laminate Price Group 1 Open Front	Wood Group 1 Open Front	Wood Case with Open Front	Laminate Case with Open Front		
									Wood Group 2	Wood Group 3	Wood Group 2	Wood Group 3

Plinth Base Pedestals



Underworksurface Bookcases with One-Adjustable Shelf

16½"	15"	27½"	E6PD161527P	\$1175	\$ 927		+\$43	+\$150		
22½"	15"	27½"	E6PD221527P	\$1224	\$ 976		+\$43	+\$150		
16½"	18"	27½"	E6PD161827P	\$1211	\$ 963		+\$43	+\$150		
22½"	18"	27½"	E6PD221827P	\$1262	\$1014		+\$43	+\$150		

► Specification Information, continued on next page

Elective Elements

Plinth Base Pedestals, Wood Veneer or Laminate, continued

SIN 711.2

► **Specification Information, continued from previous page**

Specification Information							
Dimensions			Style Number	Base Prices		Options	
D	W	H		Wood Group 1 Case Open Front	Laminate Price Group 1 Case Open Front	(Add \$ to Base Price)	
						Wood	Wood Case with Open Front
						Wood	Wood
						Group 2	Group 3

Plinth Base Pedestals, continued

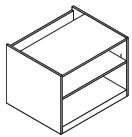

Underworksurface Bookcases with One Adjustable Shelf

16½"	30"	27½"	E6PD163027P	\$1458	\$1095	+\$69	+\$242
22½"	30"	27½"	E6PD223027P	\$1551	\$1188	+\$69	+\$242
28½"	30"	27½"	E6PD283027P	\$1671	\$1308	+\$69	+\$242
16½"	36"	27½"	E6PD163627P	\$1546	\$1183	+\$69	+\$242
22½"	36"	27½"	E6PD223627P	\$1643	\$1258	+\$69	+\$242
28½"	36"	27½"	E6PD283627P	\$1764	\$1379	+\$69	+\$242

SIN 711.2

Plinth Base Adjustable-Height Pedestals

Wood Veneer or Laminate

SIN 711.2

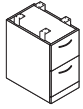

Tip: Adjustable-height brackets are available in polished chrome only.

Standard Includes	Required to Specify
<ul style="list-style-type: none"> Underworksurface storage: <ul style="list-style-type: none"> –Wood group 1 case with wood group 1 front –Laminate price group 1 case with same or contrasting laminate front –Laminate price group 1 case with wood group 1 front Height adjustment hardware Unfinished back Finished inset top Dovetail drawer construction One fastened metal filing system per file drawer: black only One partition per box drawer: solid wood One pencil tray per two box drawers: solid wood Lock, keyed random Counterweight, if selected Standard close drawer slides 	<ol style="list-style-type: none"> Style number Wood or laminate color number for underworksurface storage Laminate color number for laminate fronts on laminate case, if selected Wood color number for wood fronts on laminate cases, if selected Pull shape (see below under Required Selections) Finish color number for pull Finish color number for lock Options, if selected (see below) <p>▶ See <i>Surface Materials</i>, page 566.</p>

Required Selections

Pull Shape

Contemporary	Jazz	Bar	Nile	Integral*	Transitional	Inset	Beam
No cost	+\$19 each	+\$26 each	+\$26 each	+\$26 each	+\$26 each	+\$26 each	+\$37 each

*Not available on laminate or composite fronts.

Options	Price	Required to Specify
Surface Materials <ul style="list-style-type: none"> Wood underworksurface storage case <ul style="list-style-type: none"> • Wood group 2 • Wood group 3 • Customiz stain Laminate underworksurface storage case <ul style="list-style-type: none"> • Laminate price group 2 • Open Line laminate • Wood group 2 on wood fronts • Wood group 3 on wood fronts • Customiz stain 	<ul style="list-style-type: none"> Prices at right Prices at right No cost See information at left +\$ 69 plus cost of laminate Prices at right Prices at right No cost 	<ul style="list-style-type: none"> Specify wood color number. Specify wood color number. Specify with <i>Customiz stain</i>. Specify laminate color number. ▶ See <i>Surface Materials Reference Manual</i>. Specify wood color number. Specify wood color number. Specify with <i>Customiz stain</i>.
Drawer Slide <ul style="list-style-type: none"> • Soft close drawer slides 	<ul style="list-style-type: none"> +\$ 30 per drawer 	<ul style="list-style-type: none"> Specify with <i>soft close drawers</i>.
Lock and Keying <ul style="list-style-type: none"> • Lock <ul style="list-style-type: none"> • Ember Chrome • Polished Chrome • Keying <ul style="list-style-type: none"> • Factory- and field-installed keying units 	<ul style="list-style-type: none"> No cost No cost 	<ul style="list-style-type: none"> Specify with <i>9250 Ember Chrome lock</i>. Specify with <i>9201 Polished Chrome lock</i>. ▶ Page 622
Miter Fold Drawer <ul style="list-style-type: none"> • For two file drawers or two lateral file drawers • For two box and one file drawer 	<ul style="list-style-type: none"> –\$ 64 –\$101 	<ul style="list-style-type: none"> Specify with <i>miter fold drawers</i>. Specify with <i>miter fold drawers</i>.
Counterweight Package <ul style="list-style-type: none"> • Add counterweight package • Omit counterweight package for 15"W or 18"W pedestals • Omit counterweight package on lateral files 	<ul style="list-style-type: none"> No cost –\$ 65 –\$130 	<ul style="list-style-type: none"> Specify with <i>counterweight package</i>. Specify with <i>no counterweight package</i>. Specify with <i>no counterweight package</i>.

▶ Options, continued on next page

For laminate price group 2 pricing, please refer to the electronic catalog or SmartTools.

Tip: Soft close drawer slides only apply to storage that has 15"W and 18"W drawers.

Tip: Soft close slides are available for both dovetail and miter fold construction.

Tip: When integral pull is specified with a 9250 Ember Chrome lock, the lock housing is black. When 9201 Polished Chrome lock is specified, the lock housing is nickel.

Tip: When selected, miter fold box drawers include one black plastic pencil tray and drawer divider.

Tip: Order finished back panels or modesty panels when units will be exposed.

► Options, continued from previous page

Related Products

- Worksurfaces ► Page 209
- Back panels for use with 15"W or 18"W pedestals ► Page 248
- Modesty panels ► Page 266
- Adjustable-height legs ► Page 277

Specification Information

Dimensions			Style Number	Base Prices			Options (Add \$ to Base Price)				
D	W	H		Wood Group 1 Case	Laminate Price Group 1 Case	Wood Group 1 Front	Wood Group 1 Front	Wood Group 2	Wood Group 3	Wood Group 2	Wood Group 3
							Wood Case with Wood Front	Laminate Case with Wood Front			

Plinth Base Adjustable-Height Pedestals—27½"–30½" High

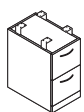

Two File Drawers

Dimensions	Style Number	Wood Case	Laminate Case	Wood Front	Wood Front	Wood Group 2	Wood Group 3	Wood Group 2	Wood Group 3
23¼" 15"	E6PA231527F	\$2067	\$1585	\$1819	+\$71	+\$244	+\$28	+\$94	
29¼" 15"	E6PA291527F	\$2156	\$1674	\$1908	+\$71	+\$244	+\$28	+\$94	
23¼" 18"	E6PA231827F	\$2171	\$1689	\$1923	+\$71	+\$244	+\$28	+\$94	

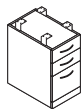

Two Box and One File Drawer

Dimensions	Style Number	Wood Case	Laminate Case	Wood Front	Wood Front	Wood Group 2	Wood Group 3	Wood Group 2	Wood Group 3
23¼" 15"	E6PA231527B	\$2184	\$1702	\$1936	+\$71	+\$244	+\$28	+\$94	
29¼" 15"	E6PA291527B	\$2270	\$1788	\$2022	+\$71	+\$244	+\$28	+\$94	
23¼" 18"	E6PA231827B	\$2334	\$1852	\$2086	+\$71	+\$244	+\$28	+\$94	

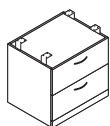

Two High Lateral Files

Dimensions	Style Number	Wood Case	Laminate Case	Wood Front	Wood Front	Wood Group 2	Wood Group 3	Wood Group 2	Wood Group 3
23¼" 30"	E6PA233027F	\$2700	\$1986	\$2349	+\$87	+\$305	+\$28	+\$94	
23¼" 36"	E6PA233627F	\$3121	\$2371	\$2734	+\$87	+\$305	+\$28	+\$94	

Pedestal Accessories

SIN 711.2

Pencil Trays

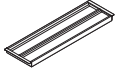

Standard Includes	Required to Specify
-------------------	---------------------

- Pencil tray: wood group 1

- 1 Style number
- 2 Wood color number for tray
- ▶ See *Surface Materials*, page 566.

Specification Information				
• Dimensions			• Style	• Price
D	W	H	Number	

D	W	H	Style Number	Price
---	---	---	--------------	-------

Pencil Trays

Wood for Wood Dovetail Drawers

4½"	12 ¹¹ / ₁₆ "	¾"	AWAP15B	\$74
4½"	15 ¹¹ / ₁₆ "	¾"	AWAP18B	\$84
:	:	:	:	:

Drawer Dividers

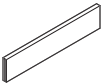

Standard Includes	Required to Specify
-------------------	---------------------

- Drawer divider: wood group 1

- Style number

Specification Information			
• Dimensions		• Style	• Price
W	H	Number	

W	H	Style Number	Price
---	---	--------------	-------

Drawer Dividers

Wood

11 ⁷ / ₈ "	2½"	AWAD15B	\$68
14 ⁷ / ₈ "	2½"	AWAD18B	\$77
:	:	:	:

SIN 711.2

Plinth Base 1.5 High Storage (21½"H)

Wood Veneer or Laminate

SIN 711.2

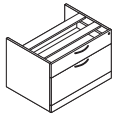

Tip: Glide hole covers are black and are visible in open units.

Tip: Multiple units can be ganged together under a single worksurface.

Standard Includes	Required to Specify
-------------------	---------------------

- Drawer units:
 - Wood group 1 case with wood group 1 front
 - Laminate price group 1 case with same or contrasting laminate front
 - Laminate price group 1 case with wood group 1 front
- Bookcase:
 - Wood group 1 case
 - Laminate price group 1 case
- Pull-out tray unit: pull-out tray-clear anodized aluminum; tray bottom: black
- Unfinished back
- Unfinished open top
- Dovetail drawer construction
- One fastened metal filing system per filing drawer: black only
- Lock, keyed random
- Counterweight package, if selected
- Standard close drawer slides

- 1 Style number
 - 2 Wood veneer or laminate color number for drawer units or bookcase
 - 3 Laminate color number for laminate fronts on laminate case, if selected
 - 4 Wood color number for wood fronts on laminate cases, if selected
 - 5 Pull shape (see below under Required Selections)
 - 6 Finish color number for pull
 - 7 Finish color number for lock
 - 8 Options, if selected (see below)
- ▶ See *Surface Materials*, page 566.

Required Selections

Pull Shape

Contemporary	Jazz	Bar	Nile	Integral*	Transitional	Inset	Beam
No cost	+\$19 each	+\$26 each	+\$26 each	+\$26 each	+\$26 each	+\$26 each	+\$37 each

*Not available on laminate or composite fronts.

Options	Price	Required to Specify
---------	-------	---------------------

Surface Materials	Wood storage case	Prices at right Prices at right No cost	Specify wood color number. Specify wood color number. Specify <i>with Customiz stain</i> .
	Laminate storage case	See information at left +\$69 plus cost of laminate Prices at right Prices at right No cost	Specify laminate color number. ▶ See <i>Surface Materials Reference Manual</i> . Specify wood color number. Specify wood color number. Specify <i>with Customiz stain</i> .
Drawer Slide	• Soft close drawer slides	+\$30 per drawer	Specify <i>with soft close drawers</i> .
Lock and Keying	Lock	• Ember Chrome • Polished Chrome	No cost No cost Specify <i>with 9250 Ember Chrome lock</i> . Specify <i>with 9201 Polished Chrome lock</i> .
	Keying	• Factory- and field-installed keying	▶ Page 622
Shelves	• ¾" shelf • Metal shelf	No cost –\$26 per shelf	Specify <i>with ¾" shelf</i> . Specify <i>with metal shelves</i> and select paint color number.
Technology Trough	• Technology trough for power and data routing: black	+\$57	Specify <i>with technology trough</i> .
Cut-out	• Right side only • Left side only • Both sides • No cut-outs	No cost No cost No cost No cost	Specify <i>with right cut-out</i> . Specify <i>with left cut-out</i> . Specify <i>with both cut-outs</i> . Specify <i>with no cut-outs</i> .

▶ Options, continued on next page

For laminate price group 2 pricing, please refer to the electronic catalog or SmartTools.

Tip: Soft close drawer slides only apply to storage that has 15"W and 18"W drawers.

Tip: Soft close slides are available for both dovetail and miter fold construction.

Tip: When integral pull is specified with a 9250 Ember Chrome lock, the lock housing is black. When 9201 Polished Chrome lock is specified, the lock housing is nickel.

Tip: Metal shelves only available on open units.

Tip: The space at the back of the units with technology troughs accommodates wires.

Tip: Cut-outs are unfinished.

SIN 711.2

► Options, continued from previous page

Tip: For counterweight rules see application topics in Elective Elements Wood Systems Furniture Specification Guide.

Tip: Counterweight is included with 17¼"D box/file units come with counterweight; no need to specify.

Options	Price	Required to Specify
Counterweight Package	<ul style="list-style-type: none"> Add counterweight package Omit counterweight package on 23¼"D box/file units, box/lateral units, or open/lateral units 	No cost -\$130 Specify with counterweight package. Specify with no counterweight package.
Related Products	<ul style="list-style-type: none"> Straight worksurfaces Technology straight worksurfaces Perpendicular tether supports Cable shroud supports Cushion tops Technology zones 	<ul style="list-style-type: none"> ► Page 210 ► Page 214 ► Page 271 ► Page 272 ► Page 298 ► Page 556

Specification Information												
Dimensions			Style Number	Base Prices			Options					
D	W	H		Wood Group 1 Case	Laminate Price Group 1 Case	Wood Group 1 Front	Laminate Price Group 1 Front	Wood Group 1 Front	Wood Case with Wood Front	Laminate Case with Wood Front		
									Wood Group 2	Wood Group 3	Wood Group 2	Wood Group 3

Plinth Base Storage



Box/File										
23¼"	15"	21½"	E6PD231521C	\$1367	\$ 885	\$1119	+\$71	+\$244	+\$28	+\$94
23¼"	18"	21½"	E6PD231821C	\$1517	\$1035	\$1269	+\$71	+\$244	+\$28	+\$94

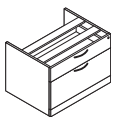

Box/Lateral File										
23¼"	30"	21½"	E6PD233021C	\$1773	\$1219	\$1518	+\$87	+\$305	+\$28	+\$94
23¼"	36"	21½"	E6PD233621C	\$2050	\$1432	\$1795	+\$87	+\$305	+\$28	+\$94

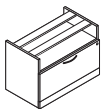

Open/Lateral File										
17¼"	30"	21½"	E6PD173021G	\$1631	\$1013	\$1376	+\$87	+\$305	+\$28	+\$94
17¼"	36"	21½"	E6PD173621G	\$1765	\$1179	\$1542	+\$87	+\$305	+\$28	+\$94
23¼"	30"	21½"	E6PD233021G	\$1721	\$1103	\$1466	+\$87	+\$305	+\$28	+\$94
23¼"	36"	21½"	E6PD233621G	\$1878	\$1275	\$1638	+\$87	+\$305	+\$28	+\$94

► Specification Information, continued on next page

Elective Elements

Plinth Base 1.5 High Storage (21½"H), Wood Veneer or Laminate, continued

SIN 711.2

► **Specification Information, continued from previous page**

Specification Information							
Dimensions			Style Number	Base Prices		Options	
D	W	H		Wood Group 1 Case Open Front	Laminate Price Group 1 Case Open Front	(Add \$ to Base Price)	
						Wood	
						Wood Case with Open Front	
						Wood Group 2	Wood Group 3

Plinth Base Storage

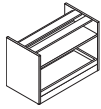

Open/Pull-out Tray

22½"	30"	21½"	E6PD223021T	\$1721	\$1416	+\$69	+\$242
22½"	36"	21½"	E6PD223621T	\$1937	\$1522	+\$69	+\$242

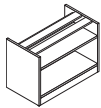

Open Bookcase

16½"	30"	21½"	E6PD163021P	\$1370	\$1007	+\$69	+\$242
16½"	36"	21½"	E6PD163621P	\$1453	\$1090	+\$69	+\$242
16½"	42"	21½"	E6PD164221P	\$1538	\$1175	+\$69	+\$242
22½"	30"	21½"	E6PD223021P	\$1461	\$1098	+\$69	+\$242
22½"	36"	21½"	E6PD223621P	\$1567	\$1204	+\$69	+\$242
22½"	42"	21½"	E6PD224221P	\$1674	\$1311	+\$69	+\$242

Tip: Trays are field installed. Template is provided to insure placement accuracy.

Cable Access Cover

SIN 711.2



Tip: Specify a cable access cover to enclose the unfinished cut-out in a plinth base 1.5 high storage unit when exposed at the end of a run. Side panels with no cut-outs are also available as an option.

Standard Includes	Required to Specify
-------------------	---------------------

- | | |
|--|--------------|
| <ul style="list-style-type: none"> Cable access cover: 8043 Clear Anodized Aluminum | Style number |
|--|--------------|

Specification Information		
---------------------------	--	--

• Dimensions	• Style	• Price
D W	Number	

Cable Access Cover		
--------------------	--	--

47/8"	57/8"	E6AJ45	\$173
:	:	:	:

Plinth Base One-High Pedestals (15½"H)

Wood Veneer or Laminate

SIN 711.2

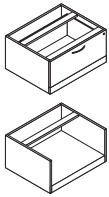

Standard Includes	Required to Specify
<ul style="list-style-type: none"> Lateral file: <ul style="list-style-type: none"> –Wood group 1 case with wood group 1 front –Laminate price group 1 case with same or contrasting laminate front –Laminate price group 1 case with wood group 1 front Bookcase: <ul style="list-style-type: none"> –Wood group 1 case –Laminate price group 1 case Unfinished back Unfinished open top Dovetail drawer construction One fastened metal filing system per filing drawer: <ul style="list-style-type: none"> black only Lock, keyed random Counterweight package 	<ol style="list-style-type: none"> Style number Wood veneer or laminate color number for lateral file or bookcase Laminate color number for laminate fronts on laminate case, if selected Wood color number for wood fronts on laminate cases, if selected Pull shape (see below under Required Selections) Finish color number for pull Finish color number for lock Options, if selected (see below) <ul style="list-style-type: none"> ▶ See <i>Surface Materials</i>, page 566.

Required Selections

Pull Shape

Contemporary No cost	Jazz +\$19 each	Bar +\$26 each	Nile +\$26 each	Integral* +\$26 each	Transitional +\$26 each	Inset +\$26 each	Beam +\$37 each

*Not available on laminate or composite fronts.

Options	Price	Required to Specify
Surface Materials <ul style="list-style-type: none"> Wood storage case <ul style="list-style-type: none"> Wood group 2 Wood group 3 Customiz stain Laminate storage case <ul style="list-style-type: none"> Laminate price group 2 Open Line laminate Wood group 2 on wood fronts Wood group 3 on wood fronts Customiz stain 	Prices at right Prices at right No cost See information at left +\$69 plus cost of laminate Prices at right Prices at right No cost	Specify wood color number. Specify wood color number. Specify with <i>Customiz stain</i> . Specify laminate color number. ▶ See <i>Surface Materials Reference Manual</i> . Specify wood color number. Specify wood color number. Specify with <i>Customiz stain</i> .
Lock and Keying <ul style="list-style-type: none"> Lock <ul style="list-style-type: none"> Ember Chrome Polished Chrome Keying <ul style="list-style-type: none"> Factory- and field-installed keying units 	No cost No cost	Specify with <i>9250 Ember Chrome lock</i> . Specify with <i>9201 Polished Chrome lock</i> . ▶ Page 622
Miter Fold Drawer <ul style="list-style-type: none"> For lateral file drawer 	–\$53	Specify with <i>miter fold drawer</i> .
Related Products <ul style="list-style-type: none"> Straight worksurfaces Finished back panels Cushion tops 		▶ Page 210 ▶ Page 248 ▶ Page 298

For laminate price group 2 pricing, please refer to the electronic catalog or SmartTools.

Tip: Glide hole covers are black and are visible in underworksurface bookcases.

Tip: When integral pull is specified with a 9250 Ember Chrome lock, the lock housing is black. When 9201 Polished Chrome lock is specified, the lock housing is nickel.

Tip: Finish tops of one-high storage units with cushions or worksurfaces.

Tip: Multiple units can be ganged together under a single worksurface.

Tip: Counterweights are included and are always required in one-highs with file drawers. Counterweights are field-installed.

Specification Information

Dimensions			Style Number	Base Prices			Options					
D	W	H		Wood Group 1 Case	Laminate Price Group 1 Case	(Add \$ to Base Price)						
				Wood Group 1 Front	Laminate Price Group 1 Front	Wood Group 1 Front	Wood Case with Wood Front	Laminate Case with Wood Front	Wood Group 2	Wood Group 3	Wood Group 2	Wood Group 3

Plinth Base Pedestals

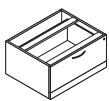

File Drawer

17 1/4"	30"	15 1/2"	E6PD173015N	\$1453	\$1153	\$1333	+\$71	+\$244	+\$28	+\$94
23 1/4"	30"	15 1/2"	E6PD233015N	\$1453	\$1153	\$1333	+\$71	+\$244	+\$28	+\$94
17 1/4"	36"	15 1/2"	E6PD173615N	\$1680	\$1362	\$1560	+\$87	+\$305	+\$28	+\$94
23 1/4"	36"	15 1/2"	E6PD233615N	\$1680	\$1362	\$1560	+\$87	+\$305	+\$28	+\$94

Specification Information

Dimensions			Style Number	Base Prices			Options					
D	W	H		Wood Group 1 Case Open Front	Laminate Price Group 1 Case Open Front	(Add \$ to Base Price)						
				Wood Group 1 Case Open Front	Laminate Price Group 1 Case Open Front	Wood Case with Open Front	Wood Group 2	Wood Group 3				

Plinth Base Pedestals

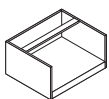

Open Bookcase

16 1/2"	30"	15 1/2"	E6PD163015P	\$1282	\$ 919		+\$43	+\$150		
22 1/2"	30"	15 1/2"	E6PD223015P	\$1369	\$1006		+\$43	+\$150		
16 1/2"	36"	15 1/2"	E6PD163615P	\$1360	\$ 997		+\$43	+\$150		
22 1/2"	36"	15 1/2"	E6PD223615P	\$1490	\$1127		+\$43	+\$150		

Elective Elements

Cushion Tops

SIN 711.2

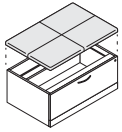

Tip: Cushion top is not designed to be used on open one-high bookcase units. If that application is desired, specify a work-surface to be mounted on the bookcase and attach the cushion top to the work-surface. This will raise the overall height of the unit by an additional 1½".

Tip: Cushion top ships separately from storage.

Tip: Cushion top attaches to one high plinth base and 21½"H leg base pedestals, two-high lateral files, and plinth base 1.5 high storage units. 42"W cushion tops are not available.

Tip: A back panel is required when using a cushion top. Note: Leg base credenzas and pedestals come with an unfinished back panel. Order separately in plinth base storage.

Tip: Seam pattern is determined by upholstery selected.

▶ See *Elective Elements Wood Systems Furniture Specification Guide*.

Standard Includes	Required to Specify
-------------------	---------------------

- Cushion top: fabric
- Attachment hardware

- 1 Style number
 - 2 Fabric color number
 - 3 Options, if selected (see below)
- ▶ See *Surface Materials*, page 566.

Surface Materials	Options	Price	Required to Specify
-------------------	---------	-------	---------------------

Surface Materials

Upholstery

- Fabric price group 1 No cost
- Fabric price group 2 +\$ 10
- Fabric price group 3 +\$ 40
- Fabric price group 4 +\$ 49
- Fabric price group 5 +\$ 62
- Fabric price group 6 +\$ 87
- Fabric price group 7 +\$106
- Fabric price group 8 +\$153
- Fabric price group 9 +\$196
- Fabric price group 10 +\$238
- Leather price group +\$610
- Select Surfaces leather price group 1 +\$610
- Elmosoft leather price group +\$705
- Select Surfaces leather price group 2 +\$705
- Customer's Own Material (COM) +\$ 16
- or Customer's Own Leather (COL)

- Specify fabric color number.
- Specify fabric color number.
- Specify fabric color number.
- Specify fabric color number.
- Specify fabric color number.
- Specify fabric color number.
- Specify fabric color number.
- Specify fabric color number.
- Specify fabric color number.
- Specify fabric color number.
- Specify leather color number.
- ▶ See *Surface Materials Reference Manual*.
- Specify Elmosoft leather color number.
- ▶ See *Surface Materials Reference Manual*.
- ▶ See *Surface Materials Reference Manual*.

Related Materials

- Plinth base freestanding 2-high lateral files
- Plinth base one-high storage
- Plinth base 1.5 high storage
- Leg base 21½"H storage
- Leg base 27½"H storage

- ▶ Page 304
- ▶ Page 296
- ▶ Page 292
- ▶ Page 348
- ▶ Page 350

Specification Information

• Dimensions			• Style	• Base
D	W	H	Number	Price

Cushion Tops

18"	30"	1½"	E6AT1830	\$494
24"	30"	1½"	E6AT2430	\$531
18"	36"	1½"	E6AT1836	\$506
24"	36"	1½"	E6AT2436	\$542

SIN 711.2

Plinth Base Mobile Pedestal

Wood Veneer or Laminate

SIN 711.2



Standard Includes	Required to Specify
<ul style="list-style-type: none"> • Mobile pedestal: <ul style="list-style-type: none"> –Wood group 1 case with wood group 1 front –Laminate price group 1 case with same or contrasting laminate front –Laminate price group 1 case with wood group 1 front • Wood group 1 top on wood cases: <ul style="list-style-type: none"> –Veneer square edge on all sides –Wood grain running in long direction on wood worksurface • Laminate price group 1 top on laminate cases: <ul style="list-style-type: none"> –1 mm plastic square edge on all sides, color defaulted • Dovetail drawer construction • One fastened metal filing system per file drawer: black only • One partition: solid wood • One pencil tray: solid wood • Four non-locking casters: black plastic only • Lock, keyed random • Counterweight package • Standard close drawer slides 	<ol style="list-style-type: none"> 1 Style number 2 Wood or laminate color number for mobile pedestal 3 Laminate color number for laminate fronts on laminate case, if selected 4 Wood color number for wood fronts on laminate cases, if selected 5 Pull shape (see below under Required Selections) 6 Finish color number for pull 7 Finish color number for lock 8 Options, if selected (see below) <p>▶ See <i>Surface Materials</i>, page 566.</p>

Required Selections

Pull Shape

Contemporary No cost	Jazz +\$19 each	Bar +\$26 each	Nile +\$26 each	Integral* +\$26 each	Transitional +\$26 each	Inset +\$26 each	Beam +\$37 each

*Not available on laminate or composite fronts.

Options	Price	Required to Specify
Surface Materials <ul style="list-style-type: none"> • Wood mobile pedestal case <ul style="list-style-type: none"> • Wood group 2 • Wood group 3 • Customiz stain • Full-fill finish on wood group 1 	<ul style="list-style-type: none"> Prices at right Prices at right No cost +\$29 	<ul style="list-style-type: none"> Specify wood color number. Specify wood color number. Specify with <i>Customiz stain</i>. Specify wood veneer color number.
<ul style="list-style-type: none"> • Laminate price group 2 • Open Line laminate 	<ul style="list-style-type: none"> See information at left +\$69 plus cost of laminate Prices at right Prices at right No cost 	<ul style="list-style-type: none"> Specify laminate color number. ▶ See <i>Surface Materials Reference Manual</i>. Specify wood color number. Specify wood color number. Specify with <i>Customiz stain</i>.
Drawer Slide <ul style="list-style-type: none"> • Soft close drawer slides 	<ul style="list-style-type: none"> +\$30 per drawer 	<ul style="list-style-type: none"> Specify with <i>soft close drawers</i>.
Lock and Keying <ul style="list-style-type: none"> • Lock <ul style="list-style-type: none"> • Ember Chrome • Polished Chrome • Keying <ul style="list-style-type: none"> • Factory- and field-installed keying units 	<ul style="list-style-type: none"> No cost No cost 	<ul style="list-style-type: none"> Specify with <i>9250 Ember Chrome lock</i>. Specify with <i>9201 Polished Chrome lock</i>. ▶ Page 622
Miter Fold Drawer <ul style="list-style-type: none"> • Miter fold drawer 	<ul style="list-style-type: none"> –\$69 	<ul style="list-style-type: none"> Specify with <i>miter fold drawers</i>.

▶ Options, continued on next page

For laminate price group 2 pricing, please refer to the electronic catalog or SmartTools.

Tip: Soft close drawer slides only apply to storage that has 15"W and 18"W drawers.

Tip: Soft close slides are available for both dovetail and miter fold construction.

Tip: When integral pull is specified with a 9250 Ember Chrome lock, the lock housing is black. When 9201 Polished Chrome lock is specified, the lock housing is nickel.

► Options, continued from previous page

Tip: Depth of cushion top is 20¾".

Tip: Seam pattern is determined by upholstery selected.

► See Elective Elements Wood Systems Furniture Specification Guide.

Options	Price	Required to Specify
Cushion Top	• Cushion top +\$294 each	Specify <i>with cushion top</i> and select fabric color number.
Upholstery	• Fabric price group 1 • Fabric price group 2 • Fabric price group 3 • Fabric price group 4 • Fabric price group 5 • Fabric price group 6 • Fabric price group 7 • Fabric price group 8 • Fabric price group 9 • Fabric price group 10 • Leather price group • Select Surfaces leather price group 1 • Elmosoft leather price group • Select Surfaces leather price group 2 • Customer's Own Material (COM) or Customer's Own Leather (COL)	No cost +\$ 10 +\$ 40 +\$ 49 +\$ 62 +\$ 87 +\$106 +\$153 +\$196 +\$238 +\$610 +\$610 +\$705 +\$705 +\$ 16
		Specify fabric color number. Specify fabric color number. Specify fabric color number. Specify fabric color number. Specify fabric color number. Specify fabric color number. Specify fabric color number. Specify fabric color number. Specify fabric color number. Specify fabric color number. Specify leather color number. ► See <i>Surface Materials Reference Manual</i> . Specify Elmosoft leather color number. ► See <i>Surface Materials Reference Manual</i> . ► See <i>Surface Materials Reference Manual</i> .

Specification Information

Dimensions			Style Number	Base Prices		Options						
D	W	H		Wood Group 1 Case	Laminate Price Group 1 Case	(Add \$ to Base Price)						
				Wood Group 1 Front	Laminate Price Group 1 Front	Wood Group 1 Front	Wood Case with Wood Front	Wood Group 2	Wood Group 3	Laminate Case with Wood Front	Wood Group 2	Wood Group 3

Plinth Base Mobile Pedestal



One Box and One File Drawer

22¾"	15½"	23"	E6PM201523	\$1624	\$1129	\$1363	+\$71	+\$244	+\$28	+\$94
------	------	-----	-------------------	--------	--------	--------	-------	--------	-------	-------

Elective Elements

Plinth Base High Pedestals

Wood Veneer or Laminate

SIN 711.2

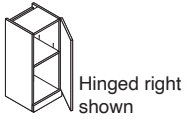

Standard Includes	Required to Specify
-------------------	---------------------

- High pedestal:
 - Wood group 1 case with wood group 1 front
 - Laminate price group 1 case with same or contrasting laminate front
 - Laminate price group 1 case with wood group 1 front
- Unfinished back
- Unfinished open top
- Lock, keyed random (not available on open high pedestal)

- 1 Style number
 - 2 Wood or laminate color number for high pedestal
 - 3 Laminate color number for laminate fronts on laminate case, if selected
 - 4 Wood color number for wood fronts on laminate cases, if selected
 - 5 Pull shape (see below under Required Selections)
 - 6 Finish color number for pull
 - 7 Finish color number for lock
 - 8 Options, if selected (see below)
- ▶ See *Surface Materials*, page 566.

Required Selections

Pull Shape

Contemporary	Jazz	Bar	Nile	Integral*	Transitional	Inset	Beam
No cost	+\$19 each	+\$26 each	+\$26 each	+\$26 each	+\$26 each	+\$26 each	+\$37 each

*Not available on laminate or composite fronts.

Options	Price	Required to Specify
---------	-------	---------------------

Surface Materials	Wood high pedestal case	Prices at right Prices at right No cost	Specify wood color number. Specify wood color number. Specify <i>with Customiz stain</i> .
	Laminate high pedestal case	See information at left +\$69 plus cost of laminate Prices at right Prices at right No cost	Specify laminate color number. ▶ See <i>Surface Materials Reference Manual</i> . Specify wood color number. Specify wood color number. Specify <i>with Customiz stain</i> .
Lock and Keying	Lock	No cost No cost	Specify <i>with 9250 Ember Chrome lock</i> . Specify <i>with 9201 Polished Chrome lock</i> .
	Keying	Factory- and field-installed keying units	▶ Page 622
Shelves	• 3/4" shelf • Metal shelf	No cost –\$26 per shelf	Specify <i>with 3/4" shelf</i> . Specify <i>with metal shelves</i> and select paint color number.
Related Products	• Back panels for use with high pedestals • Single-high overhead cabinets • Side support frame		▶ Page 248 ▶ Pages 484–490 ▶ Page 522

For laminate price group 2 pricing, please refer to the electronic catalog or SmartTools.

Tip: When integral pull is specified with a 9250 Ember Chrome lock, the lock housing is black. When 9201 Polished Chrome lock is specified, the lock housing is nickel.

Tip: Locks not available on high pedestals with doors specified with integral or beam pulls.

Specification Information

Dimensions			Style Number	Base Prices			Options			
D	W	H		Wood Group 1 Case	Laminate Price Group 1 Case	Wood Group 1 Front	Wood Group 1 Front	Wood Group 1 Front	Wood Group 2	Wood Group 3
								Wood Case with Wood Front	Laminate Case with Wood Front	
								Wood Group 2	Wood Group 3	Wood Group 2
								Wood Group 3		Wood Group 3

Plinth Base High Pedestals



Hinged Door with One Adjustable Shelf

Hinged Left

15¾"	15"	35⅞"	E6PH151535L	\$1650	\$1179	\$1402	+\$71	+\$244	+\$28	+\$94
------	-----	------	--------------------	--------	--------	--------	-------	--------	-------	-------

Hinged Right

15¾"	15"	35⅞"	E6PH151535R	\$1650	\$1179	\$1402	+\$71	+\$244	+\$28	+\$94
------	-----	------	--------------------	--------	--------	--------	-------	--------	-------	-------

Specification Information

Dimensions			Style Number	Base Prices			Options			
D	W	H		Wood Group 1 Case	Laminate Price Group 1 Case	Wood Group 1 Open Front	Wood Group 1 Open Front	Wood Group 2	Wood Group 3	Wood Group 3
								Wood Case with Open Front		
								Wood Group 2	Wood Group 3	

Plinth Base High Pedestals

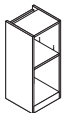

Open with One Adjustable Shelf

15"	15"	35⅞"	E6PH151535P	\$1325	\$992		+\$69	+\$242		
-----	-----	------	--------------------	--------	-------	--	-------	--------	--	--

Elective Elements

Plinth Base Lateral Files—Freestanding 2-High

Wood Veneer or Laminate

SIN 711.2

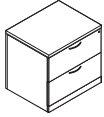

Standard Includes	Required to Specify
-------------------	---------------------

- | | |
|---|--|
| <ul style="list-style-type: none"> • Worksurface: wood group 1 veneer or laminate price group 1 • Wood group 1 worksurface with wood edge: <ul style="list-style-type: none"> –Solid wood edge on visitor’s side –Veneer edge on other sides • Laminate price group 1 worksurface with plastic edge: <ul style="list-style-type: none"> –3 mm plastic edge on user and visitor’s side –1 mm plastic edge on other sides, plastic default to match user’s side • Laminate price group 1 worksurface with wood edge: <ul style="list-style-type: none"> –Solid wood edge on user and visitor’s side –1 mm plastic edge on other sides, color default to match worksurface • Lateral file case: <ul style="list-style-type: none"> –Wood group 1 case with wood group 1 front –Laminate price group 1 case with same or contrasting laminate front –Laminate price group 1 case with wood group 1 front • Proud finished back panel to match case • One fastened metal filing system per file drawer: <ul style="list-style-type: none"> black only • Lock, keyed random • Counterweight package • Standard close drawers | <ol style="list-style-type: none"> 1 Style number 2 Wood or laminate color number for worksurface and lateral file case 3 Wood or plastic edge color number for all sides on laminate worksurface, if selected 4 Laminate color number for laminate fronts on laminate case, if selected 5 Wood color number for wood fronts on laminate cases, if selected 6 Worksurface profile (see below under Required Selections) 7 Pull shape (see below under Required Selections) 8 Finish color number for pull 9 Options, if selected (see below) <p>▶ See <i>Surface Materials</i>, page 566.</p> |
|---|--|

Required Selections (Prices at Right)

Wood Worksurface Edge Profiles			Laminate Worksurface Edge Profiles			
Wood Square Profile	Wood Bullnose Profile	Wood Blade Profile	Plastic Square Profile	Plastic Blade Profile	Wood Square Profile	Wood Bullnose Profile

Pull Shape							
Contemporary	Jazz	Bar	Nile	Integral*	Transitional	Inset	Beam
No cost	+\$19 each	+\$26 each	+\$26 each	+\$26 each	+\$26 each	+\$26 each	+\$37 each

*Not available on laminate or composite fronts.

SIN 711.2

	Options	Price	Required to Specify
Surface Materials	Wood lateral file		
	• Wood group 2	+\$ 59	Specify wood color number.
	• Wood group 3	+\$211	Specify wood color number.
	• Customiz stain	No cost	Specify with <i>Customiz stain</i> .
	Laminate lateral file		
	• Laminate price group 1 front on laminate case	-\$363	Specify laminate color number.
	• Laminate price group 2 front on laminate case	See information at left	Specify laminate color number.
	• Open Line laminate	+\$ 69 plus cost of laminate	▶ See <i>Surface Materials Reference Manual</i> .
	• Wood group 2 on wood edge on 30"W	+\$ 28	Specify wood color number.
	• Wood group 3 on wood edge on 30"W	+\$ 94	Specify wood color number.
	• Wood group 2 on wood edge on 36"W	+\$ 47	Specify wood color number.
	• Wood group 3 on wood edge on 36"W	+\$164	Specify wood color number.
	• Customiz stain on wood edge on 30"W	No cost	Specify with <i>Customiz stain</i> .
	• Customiz stain on edge on 36"W	No cost	Specify with <i>Customiz stain</i> .
	• Wood group 2 on wood front	+\$ 53	Specify with <i>wood front on laminate case</i> and indicate wood color number.
	• Wood group 3 on wood front	+\$188	Specify with <i>wood front on laminate case</i> and indicate wood color number.
	• Customiz stain on wood front	No cost	Specify with <i>Customiz stain</i> .
Lock and Keying	Lock		
	• Ember Chrome	No cost	Specify with <i>9250 Ember Chrome lock</i> .
	• Polished Chrome	No cost	Specify with <i>9201 Polished Chrome lock</i> .
	Keying		
	• Factory- and field-installed keying		▶ Page 622
Miter Fold Drawer	• For two-high	-\$106	Specify with <i>miter fold drawer construction</i> .

For laminate price group 2 pricing, please refer to the electronic catalog or SmartTools.

Tip: When integral pull is specified with a 9250 Ember Chrome lock, the lock housing is black. When 9201 Polished Chrome lock is specified, the lock housing is nickel.

Specification Information

• Dimensions			• Style Number	• Base Prices					
D	W	H		Wood Group 1			Laminate Price Group 1		
				Wood Square Edge	Wood Bullnose Edge	Wood Blade Edge	3 mm Plastic Square Edge	Laminate Blade Edge	Wood Square or Bullnose Edge

Plinth Base Lateral Files

Two-High Lateral Files

24"	30"	29"	Style Number	Wood Square Edge	Wood Bullnose Edge	Wood Blade Edge	3 mm Plastic Square Edge	Laminate Blade Edge	Wood Square or Bullnose Edge
			E6LF243029T	\$2605	\$2709	\$2757	\$2254	\$2353	\$2420
			E6LF243629T	\$2789	\$2893	\$2941	\$2402	\$2501	\$2568

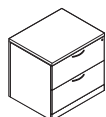

Plinth Base Lateral Files—Freestanding 3-High and 4-High

Wood Veneer or Laminate

SIN 711.2



Standard Includes	Required to Specify
<ul style="list-style-type: none"> Lateral file: <ul style="list-style-type: none"> –Wood group 1 case with wood group 1 front –Laminate price group 1 case with same or contrasting laminate front –Laminate price group 1 case with wood group 1 front Finished inset top and back panel One fastened metal filing system per file drawer: black only Lock, keyed random Counterweight package 	<ol style="list-style-type: none"> Style number Wood or laminate color number for lateral file Laminate color number for laminate fronts on laminate case, if selected Wood color number for wood fronts on laminate cases, if selected Pull shape (see below under Required Selections) Finish color number for pull Options, if selected (see below) <p>▶ See <i>Surface Materials</i>, page 566.</p>

Required Selections

Pull Shape

Contemporary	Jazz	Bar	Nile	Integral*	Transitional	Inset	Beam
No cost	+\$19 each	+\$26 each	+\$26 each	+\$26 each	+\$26 each	+\$26 each	+\$37 each

*Not available on laminate or composite fronts.

Options	Price	Required to Specify
Surface Materials <ul style="list-style-type: none"> Wood lateral file case <ul style="list-style-type: none"> Wood group 2 Wood group 3 Customiz stain Laminate lateral file case <ul style="list-style-type: none"> Laminate price group 2 Open Line laminate Wood group 2 on wood fronts Wood group 3 on wood fronts Customiz stain 	<ul style="list-style-type: none"> Prices at right Prices at right No cost See information at left +\$ 69 plus cost of laminate Prices at right Prices at right No cost 	<ul style="list-style-type: none"> Specify wood color number. Specify wood color number. Specify <i>with Customiz stain</i>. Specify laminate color number. ▶ See <i>Surface Materials Reference Manual</i>. Specify wood color number. Specify wood color number. Specify <i>with Customiz stain</i>.
Lock and Keying <ul style="list-style-type: none"> Lock <ul style="list-style-type: none"> Ember Chrome Polished Chrome Keying <ul style="list-style-type: none"> Factory- and field-installed keying units 	<ul style="list-style-type: none"> No cost No cost 	<ul style="list-style-type: none"> Specify <i>with 9250 Ember Chrome lock</i>. Specify <i>with 9201 Polished Chrome lock</i>. ▶ Page 622
Miter Fold Drawer <ul style="list-style-type: none"> For three-high For four-high 	<ul style="list-style-type: none"> –\$159 –\$212 	<ul style="list-style-type: none"> Specify <i>with miter fold drawer construction</i>. Specify <i>with miter fold drawer construction</i>.

For laminate price group 2 pricing, please refer to the electronic catalog or SmartTools.

Tip: When integral pull is specified with a 9250 Ember Chrome lock, the lock housing is black. When 9201 Polished Chrome lock is specified, the lock housing is nickel.

SIN 711.2

Specification Information														
Dimensions			Style Number	Base Prices			Options							
D	W	H		Wood Group 1 Case	Laminate Price Group 1 Case	Wood Group 1 Front	Laminate Price Group 1 Front	Wood Group 1 Front	Wood					
									Wood Case with Wood Front	Laminate Case with Wood Front	Wood Group 2	Wood Group 3	Wood Group 2	Wood Group 3

Plinth Base Lateral Files



Three-High Lateral Files

24"	30"	39 3/8"	E6LF243041E	\$3146	\$2095	\$2698	+\$242	+\$850	+\$69	+\$242
24"	36"	39 3/8"	E6LF243641E	\$3376	\$2256	\$2889	+\$242	+\$850	+\$69	+\$242



Four-High Lateral Files

24"	30"	51 1/4"	E6LF243051F	\$3841	\$2451	\$3298	+\$242	+\$850	+\$69	+\$242
24"	36"	51 1/4"	E6LF243651F	\$4132	\$2636	\$3543	+\$242	+\$850	+\$69	+\$242

One-High Open Plinth Base Pedestals for Ology Application

SIN 711.2

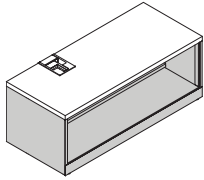

Tip: Ships without top. Picture shows fully assembled product. To specify a top option, see style number E6WSHAD
▶ page 310.

Tip: Leveling glides adjust up to 3/4".

For laminate price group 2 pricing, please refer to the electronic catalog or SmartTools.

Tip: If back panel eliminated, use Elective Elements' filler panel when against wall or back-to-back, if desired.

Tip: Modesty panels and screens must be undersized and justified to the outside of the straight worksurface when used.

Tip: Select a common top to create a one-high credenza.

Tip: To help avoid pinch point, the pedestal for Ology application extends 1" past the back of the Elective Elements common top.

Standard Includes	Required to Specify
<ul style="list-style-type: none"> Case with back panel: wood group 1 veneer or laminate price group 1 Grommet in top of case Removable interior cover Skeleton bone wire manager 	<ol style="list-style-type: none"> Style number Width (see below under Required Selections) Wood or laminate color number for case Options, if selected (see below) <p>▶ See <i>Surface Materials</i>, page 566.</p>

Required Selections	Price	Required to Specify
Width		
• 24"W	Prices below	Specify with 24"W.
• 30"W	Prices below	Specify with 30"W.
• 36"W	Prices below	Specify with 36"W.
• 42"W	Prices below	Specify with 42"W.

Options	Price	Required to Specify
Surface Materials		
Case		
• Laminate price group 1	-\$191	Specify laminate color number.
• Laminate price group 2	See information at left	Specify laminate color number.
• Open Line laminate	-\$122 plus cost of laminate	▶ See <i>Surface Materials Reference Manual</i> .
• Wood group 1	No cost	Specify wood color number.
• Wood group 2	+\$ 43	Specify wood color number.
• Wood group 3	+\$150	Specify wood color number.
• Full-fill finish on wood group 1	No cost	Specify wood veneer color number.
• Customiz stain	No cost	Specify with <i>Customiz stain</i> .
Grain Direction		
• No grain direction	No cost	Specify with <i>no grain direction</i> .
• Vertical	No cost	Specify with <i>vertical grain direction</i> .
• Horizontal	No cost	Specify with <i>horizontal grain direction</i> .

Related Products	<ul style="list-style-type: none"> Common top for Ology application Ology height-adjustable desks 	<p>▶ Page 310</p> <p>▶ See <i>Height Adjustable Desks Specification Guide</i>.</p>
-------------------------	---	--

Specification Information					
Style Number	Dimensions			Base Price	Option
	D	H	W		(Add \$ to Base Price)
					Omit Back Panel
E6PDHAD	17 1/4"	15 1/2"	24"	\$1553	-\$127
	17 1/4"	15 1/2"	30"	\$1656	-\$145
	17 1/4"	15 1/2"	36"	\$1759	-\$163
	17 1/4"	15 1/2"	42"	\$1867	-\$181

One-High Open Plinth
Base Pedestals for Ology
Application

SIN 711.2

Common Top for Ology Application

SIN 711.2

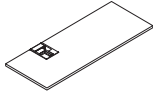

Standard Includes	Required to Specify
<ul style="list-style-type: none"> • Common top: wood group 1 veneer or laminate price group 1 • Wood group 1 common top with wood edge: <ul style="list-style-type: none"> –3 mm wood square profile on user side –0.5 mm veneer on other sides • Laminate price group 1 common top with plastic edge: <ul style="list-style-type: none"> –3 mm plastic edge on user's side –1 mm plastic edge on other sides, plastic default to match user's side • Laminate price group 1 common top with wood edge: <ul style="list-style-type: none"> –Solid wood edge on user's side –1 mm plastic edge on other sides, color default to match worksurface 	<ol style="list-style-type: none"> 1 Style number 2 Width (see below under Required Selections) 3 Wood or laminate color number 4 Wood edge color number for all sides on wood worksurface, if selected 5 Plastic edge color number for all sides on laminate worksurface, if selected 6 Common top profile (see below under Required Selections) 7 Application (see below under Required Selections) 8 Options, if selected (see below) <p>▶ See <i>Surface Materials</i>, page 566.</p>

	Required Selections	Price	Required to Specify
Width	<ul style="list-style-type: none"> • 24"W • 30"W • 36"W • 42"W • 48"W • 54"W • 60"W • 66"W • 72"W • 78"W • 84"W • 90"W • 96"W • 102"W • 108"W • 114"W • 120"W 	<p>Prices at right</p> <p>Prices at right</p> <p>Prices at right</p> <p>Prices at right</p> <p>Prices at right</p> <p>Prices at right</p> <p>Prices at right</p> <p>Prices at right</p> <p>Prices at right</p> <p>Prices at right</p> <p>Prices at right</p> <p>Prices at right</p> <p>Prices at right</p> <p>Prices at right</p> <p>Prices at right</p> <p>Prices at right</p> <p>Prices at right</p> <p>Prices at right</p> <p>Prices at right</p> <p>Prices at right</p> <p>Prices at right</p> <p>Prices at right</p>	<p>Specify with 24"W.</p> <p>Specify with 30"W.</p> <p>Specify with 36"W.</p> <p>Specify with 42"W.</p> <p>Specify with 48"W.</p> <p>Specify with 54"W.</p> <p>Specify with 60"W.</p> <p>Specify with 66"W.</p> <p>Specify with 72"W.</p> <p>Specify with 78"W.</p> <p>Specify with 84"W.</p> <p>Specify with 90"W.</p> <p>Specify with 96"W.</p> <p>Specify with 102"W.</p> <p>Specify with 108"W.</p> <p>Specify with 114"W.</p> <p>Specify with 120"W.</p>

Wood Common Top Edge Profile	Laminate Common Top Edge Profile	Price
<p>Wood Square Profile</p>	<p>Plastic Square Profile Wood Square Profile</p>	<p>Prices at right</p>

Application	<ul style="list-style-type: none"> • Left-hand application • Right-hand application 	<p>No cost</p> <p>No cost</p>	<p>Specify with <i>Ology left-hand application</i>.</p> <p>Specify with <i>Ology right-hand application</i>.</p>
--------------------	---	-------------------------------	--

SIN 711.2

Options	Price	Required to Specify
Surface Materials		
Wood veneer common top		
• Wood group 2	Prices below	Specify wood color number.
• Wood group 3	Prices below	Specify wood color number.
• Full-fill finish on wood group 1	Prices below	Specify wood color number.
• Customiz stain	No cost	Specify <i>with Customiz stain</i>
Laminate common top		
• Laminate price group 1	Prices below	Specify laminate color number.
• Laminate price group 2	See information at left	Specify laminate color number.
• Open Line laminate	Prices below plus cost of laminate	▶ See <i>Surface Materials Reference Manual</i> .
• Wood group 2 on wood edge	Prices below	Specify wood color number.
• Wood group 3 on wood edge	Prices below	Specify wood color number.
Grain Direction		
Veneer common top		
• Long grain	No cost	Specify <i>with long grain</i> .
• Short grain	No cost	Specify <i>with short grain</i> .
Laminate common top		
• No grain direction	No cost	Specify <i>with no grain direction</i> .
• Long grain	No cost	Specify <i>with long grain</i> .
• Short grain (on 60"W)	No cost	Specify <i>with short grain</i> .
Related Products		
• One-high open plinth base pedestals for Ology application		▶ Page 308
• Modesty panels		▶ Page 266
• Universal privacy/modesty screens		▶ Page 266
• Ology height-adjustable desks		▶ See <i>Height Adjustable Desks Specification Guide</i> .

For laminate price group 2 pricing, please refer to the electronic catalog or SmartTools.

Tip: Short grain on laminate tops is only available on 60"W.

Specification Information

Style Number	Dimensions		Base Prices			Options (Add \$ to Base Price)			
	D	W	Wood Group 1	Laminate Price Group 1		Wood		Full-Fill Finish on Wood Group 1	Open Line Laminate
			Wood Square Edge	3 mm Plastic Square Edge	Wood Square Edge	Wood Group 2	Wood Group 3		
E6WSHAD	18"	24"	\$ 479	\$ 190	\$ 431	+\$28	+\$ 94	+\$29	-\$220
	18"	30"	\$ 509	\$ 220	\$ 461	+\$28	+\$ 94	+\$29	-\$220
	18"	36"	\$ 522	\$ 233	\$ 474	+\$47	+\$164	+\$47	-\$220
	18"	42"	\$ 577	\$ 251	\$ 528	+\$47	+\$164	+\$47	-\$257
	18"	48"	\$ 624	\$ 298	\$ 575	+\$47	+\$164	+\$47	-\$257
	18"	54"	\$ 646	\$ 320	\$ 597	+\$47	+\$164	+\$47	-\$257
	18"	60"	\$ 705	\$ 342	\$ 654	+\$69	+\$242	+\$69	-\$294
	18"	66"	\$ 748	\$ 385	\$ 697	+\$69	+\$242	+\$69	-\$294
	18"	72"	\$ 800	\$ 437	\$ 749	+\$69	+\$242	+\$69	-\$294
	18"	78"	\$ 842	\$ 479	\$ 791	+\$69	+\$242	+\$69	-\$294
	18"	84"	\$1023	\$ 660	\$ 972	+\$69	+\$242	+\$69	-\$294
	18"	90"	\$1193	\$ 830	\$1142	+\$69	+\$242	+\$69	-\$294
	18"	96"	\$1372	\$1009	\$1321	+\$69	+\$242	+\$69	-\$294
	18"	102"	\$1578	\$1179	\$1528	+\$96	+\$335	+\$96	-\$330
	18"	108"	\$1815	\$1416	\$1765	+\$96	+\$335	+\$96	-\$330
	18"	114"	\$2087	\$1688	\$2037	+\$96	+\$335	+\$96	-\$330
	18"	120"	\$2400	\$2001	\$2350	+\$96	+\$335	+\$96	-\$330

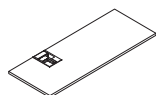

Elective Elements

Plinth Base Freestanding Bookcases—Open

Wood Veneer or Laminate

SIN 711.2

Tip: Freestanding bookcases that are 72½"H or 77½"H have an unfinished back and must be placed up against a wall or back-to-back.

Tip: Shelves with less than 12" of clearance height will not hold some binders in the vertical orientation.

For laminate price group 2 pricing, please refer to the electronic catalog or SmartTools.

Tip: Specify optional 1⅛" thick heavy load shelves for heavy load conditions. Heavy load conditions are defined as loads of 100 pounds or greater. Heavy load shelves should be specified on wider units (30"W or 36"W) loaded with books or other heavy objects.

Tip: Glide hole covers are black and are visible in bookcases.

Standard Includes	Required to Specify
<ul style="list-style-type: none"> Open bookcase <ul style="list-style-type: none"> –Wood group 1 or laminate price group 1 Finished inset back on 45"H and 65⅝"H bookcases Unfinished inset back on 72½"H or 77½"H bookcases Shelves: wood or laminate to match case 	<ol style="list-style-type: none"> Style number Wood or laminate color number for bookcase Options, if selected (see below) <ul style="list-style-type: none"> ▶ See <i>Surface Materials</i>, page 566.

Options	Price	Required to Specify
Surface Materials Wood bookcase <ul style="list-style-type: none"> Wood group 2 Wood group 3 Customiz stain Laminate bookcase <ul style="list-style-type: none"> Laminate price group 2 Open Line laminate Customiz stain 	Prices below and at right Prices below and at right No cost See information at left +\$ 69 plus cost of laminate No cost	Specify wood color number. Specify wood color number. Specify with Customiz stain. Specify laminate color number. ▶ See <i>Surface Materials Reference Manual</i> . Specify with Customiz stain.
Shelves Heavy load shelves <ul style="list-style-type: none"> On 45"H and 65⅝"H bookcases On 72½"H or 77½"H bookcases Metal shelf	+\$ 48 +\$117 –\$ 26 per shelf	Specify with heavy load shelves. Specify with heavy load shelves. Specify with metal shelves and select paint color number.

Specification Information							
Dimensions			Style	Base Prices		Options	
D	W	H	Number	Wood Group 1 Case Open Front	Laminate Price Group 1 Case Open Front	(Add \$ to Base Price)	
.....	Wood : Wood : Group 2 : Group 3	

Plinth Base Freestanding Bookcases

Open

45"H Bookcases

One Adjustable Shelf, Two Fixed Shelves

15"	24"	45"	E6BF152445P	\$1754	\$1272	+\$177	+\$624
15"	30"	45"	E6BF153045P	\$1858	\$1376	+\$177	+\$624
15"	36"	45"	E6BF153645P	\$1962	\$1480	+\$177	+\$624

65⅝"H Bookcases

Three Adjustable Shelves, Two Fixed Shelves

15"	24"	65⅝"	E6BF152465P	\$2131	\$1649	+\$330	+\$1154
15"	30"	65⅝"	E6BF153065P	\$2254	\$1772	+\$330	+\$1154
15"	36"	65⅝"	E6BF153665P	\$2377	\$1895	+\$330	+\$1154

▶ Specification Information, continued on next page

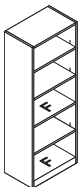
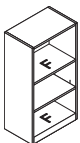

► Specification Information, continued from previous page

Specification Information							
Dimensions			Style Number	Base Prices		Options	
D	W	H		Wood Group 1 Case Open Front	Laminate Price Group 1 Case Open Front	(Add \$ to Base Price)	Wood
							Wood Case with Open Front
							Wood Group 2 Wood Group 3

Plinth Base Freestanding Bookcases, continued

Open

72½"H Bookcases

Three Adjustable Shelves, Two Fixed Shelves

15"	24"	72½"	E6BF152472P	\$2306	\$1824	+\$330	+\$1154
15"	30"	72½"	E6BF153072P	\$2440	\$1958	+\$330	+\$1154
15"	36"	72½"	E6BF153672P	\$2573	\$2091	+\$330	+\$1154

77½"H Bookcases

Four Adjustable Shelves, Two Fixed Shelves

15"	24"	77½"	E6BF152477P	\$2483	\$2001	+\$330	+\$1154
15"	30"	77½"	E6BF153077P	\$2625	\$2143	+\$330	+\$1154
15"	36"	77½"	E6BF153677P	\$2766	\$2284	+\$330	+\$1154

F=Fixed shelf

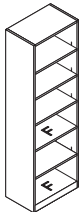
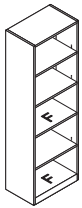

F = Fixed shelf

Plinth Base Freestanding Bookcases with Doors

Wood Veneer or Laminate

SIN 711.2

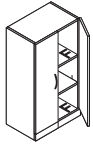

Tip: It is recommended that 72½"H or 77½"H freestanding bookcases be placed up against a wall.

Tip: Shelves with less than 12" of clearance height will not hold some binders in the vertical orientation.

Standard Includes	Required to Specify
-------------------	---------------------

<ul style="list-style-type: none"> Bookcase with double doors: <ul style="list-style-type: none"> –Wood group 1 case with wood group 1 front –Laminate price group 1 case with same or contrasting laminate front –Laminate price group 1 case with wood group 1 front Finished inset back on 45"H and 65⅝"H bookcases Unfinished inset back on 72½"H or 77½"H bookcases Shelves: wood or laminate to match case 	<ol style="list-style-type: none"> Style number Wood or laminate color number for bookcase Laminate color number for laminate fronts on laminate case, if selected Wood color number for wood fronts on laminate cases, if selected Pull shape (see below under Required Selections) Finish color number for pull Options, if selected (see below) <p>▶ See <i>Surface Materials</i>, page 566.</p>
--	--

Required Selection

Pull Shape

Contemporary	Jazz	Bar	Nile	Integral*	Transitional	Inset	Beam
No cost	+\$19 each	+\$26 each	+\$26 each	+\$26 each	+\$26 each	+\$26 each	+\$37 each

*Not available on laminate or composite fronts.

Options	Price	Required to Specify
---------	-------	---------------------

<p>Surface Materials</p> <ul style="list-style-type: none"> Wood bookcase <ul style="list-style-type: none"> • Wood group 2 • Wood group 3 • Customiz stain 	<p>Prices at right Prices at right No cost</p>	<p>Specify wood color number. Specify wood color number. Specify <i>with Customiz stain</i>.</p>
---	--	--

For laminate price group 2 pricing, please refer to the electronic catalog or SmartTools.

<ul style="list-style-type: none"> Laminate bookcase <ul style="list-style-type: none"> • Laminate price group 2 • Open Line laminate Wood group 2 on wood fronts Wood group 3 on wood fronts Customiz stain 	<p>See information at left +\$ 69 plus cost of laminate Prices at right Prices at right No cost</p>	<p>Specify laminate color number. ▶ See <i>Surface Materials Reference Manual</i>. Specify wood color number. Specify wood color number. Specify <i>with Customiz stain</i>.</p>
---	---	--

Tip: Glass doors have a magnetic touch latch. They do not have pulls.

Painted Glass Door(s) for Bookcases	Non-locking glass doors	Price	Required to Specify
	• On 24"W x 45"H bookcases	+\$ 656	Specify <i>with glass doors</i> and select finish. Specify <i>with glass doors</i> and select finish. Specify <i>with glass doors</i> and select finish. Specify <i>with glass doors</i> and select finish. Specify <i>with glass doors</i> and select finish. Specify <i>with glass doors</i> and select finish. Specify <i>with glass doors</i> and select finish. Specify <i>with glass doors</i> and select finish. Specify <i>with glass doors</i> and select finish. Specify <i>with glass doors</i> and select finish. Specify <i>with glass doors</i> and select finish.
	• On 30"W x 45"H bookcases	+\$ 706	
	• On 36"W x 45"H bookcases	+\$ 774	
	• On 24"W x 65⅝"H bookcases	+\$ 774	
	• On 30"W x 65⅝"H bookcases	+\$ 872	
	• On 36"W x 65⅝"H bookcases	+\$1016	
	• On 24"W x 72½"H bookcases	+\$ 847	
	• On 30"W x 72½"H bookcases	+\$ 945	
	• On 36"W x 72½"H bookcases	+\$1053	
	• On 24"W x 77½"H bookcases	+\$ 918	
	• On 30"W x 77½"H bookcases	+\$1016	
	• On 36"W x 77½"H bookcases	+\$1086	

Tip: Double-door units with integral or beam pulls will have a single pull on the right-hand door.

<p>Frame</p> <ul style="list-style-type: none"> Painted metal frame for glass doors 	<p>No cost</p>	<p>Specify <i>with frame</i> and select paint color number.</p>
---	----------------	---

▶ Options, continued on next page

Tip: Specify optional 1⅝" thick heavy load shelves for heavy load conditions. Heavy load conditions are defined as loads of 100 pounds or greater. Heavy load shelves should be specified on wider units (30"W or 36"W) loaded with books or other heavy objects.

SIN 711.2

► Options, continued from previous page

	Options	Price	Required to Specify
Mirrored Glass Door(s) for Bookcases	Non-locking glass doors		
	• On 24"W x 45"H bookcases	+\$ 920	Specify with <i>mirrored glass door</i> and select finish.
	• On 30"W x 45"H bookcases	+\$ 986	Specify with <i>mirrored glass door</i> and select finish.
	• On 36"W x 45"H bookcases	+\$1086	Specify with <i>mirrored glass door</i> and select finish.
	• On 24"W x 65 ⁵ / ₈ "H bookcases	+\$1086	Specify with <i>mirrored glass door</i> and select finish.
	• On 30"W x 65 ⁵ / ₈ "H bookcases	+\$1218	Specify with <i>mirrored glass door</i> and select finish.
	• On 36"W x 65 ⁵ / ₈ "H bookcases	+\$1424	Specify with <i>mirrored glass door</i> and select finish.
	• On 24"W x 72 ¹ / ₂ "H bookcases	+\$1182	Specify with <i>mirrored glass door</i> and select finish.
	• On 30"W x 72 ¹ / ₂ "H bookcases	+\$1322	Specify with <i>mirrored glass door</i> and select finish.
	• On 36"W x 72 ¹ / ₂ "H bookcases	+\$1474	Specify with <i>mirrored glass door</i> and select finish.
	• On 24"W x 77 ¹ / ₂ "H bookcases	+\$1286	Specify with <i>mirrored glass door</i> and select finish.
	• On 30"W x 77 ¹ / ₂ "H bookcases	+\$1424	Specify with <i>mirrored glass door</i> and select finish.
• On 36"W x 77 ¹ / ₂ "H bookcases	+\$1522	Specify with <i>mirrored glass door</i> and select finish.	
	Frame		
	• Painted metal frame for glass doors	No cost	Specify with <i>frame</i> and select paint color number.
Shelves	Heavy load shelves		
	• On 45"H and 65 ⁵ / ₈ "H bookcases	+\$ 48	Specify with <i>heavy load shelves</i> .
	• On 72 ¹ / ₂ "H or 77 ¹ / ₂ "H bookcases	+\$ 117	Specify with <i>heavy load shelves</i> .
	• Metal shelf	-\$ 26 per shelf	Specify with <i>metal shelves</i> and select paint color number.

► Specification Information, on next page

Elective Elements

Plinth Base Freestanding Bookcases with Doors, Wood Veneer or Laminate, continued

SIN 711.2

► Options, on previous page

Specification Information

Dimensions			Style Number	Base Prices			Options					
D	W	H		Wood Group 1 Case	Laminate Price Group 1 Case	Wood Group 1 Front	(Add \$ to Base Price)					
							Wood Case with Wood Front	Laminate Case with Wood Front	Wood Group 2	Wood Group 3	Wood Group 2	Wood Group 3

Plinth Base Freestanding Bookcases

With Two Doors

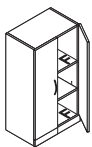

45"H Bookcases

One Adjustable Shelf, Two Fixed Shelves

Dimensions	Style Number	Wood Case	Laminate Case	Wood Front	Wood Group 2	Wood Group 3	Wood Group 2	Wood Group 3
157/8" 24" 45"	E6BF152445D	\$2405	\$1680	\$2133	+\$224	+\$788	+\$47	+\$164
157/8" 30" 45"	E6BF153045D	\$2509	\$1784	\$2237	+\$224	+\$788	+\$47	+\$164
157/8" 36" 45"	E6BF153645D	\$2614	\$1889	\$2342	+\$246	+\$866	+\$69	+\$242

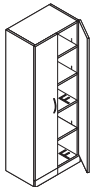

655/8"H Bookcases

Three Adjustable Shelves, Two Fixed Shelves

Dimensions	Style Number	Wood Case	Laminate Case	Wood Front	Wood Group 2	Wood Group 3	Wood Group 2	Wood Group 3
157/8" 24" 655/8"	E6BF152465D	\$2782	\$2057	\$2510	+\$399	+\$1396	+\$69	+\$242
157/8" 30" 655/8"	E6BF153065D	\$2904	\$2179	\$2632	+\$399	+\$1396	+\$69	+\$242
157/8" 36" 655/8"	E6BF153665D	\$3027	\$2302	\$2755	+\$428	+\$1498	+\$96	+\$335

► Specification Information, continued on next page

► Specification Information, continued from previous page

Specification Information												
Dimensions			Style Number	Base Prices			Options					
D	W	H		Wood Group 1 Case	Laminate Price Group 1 Case	Wood Group 1 Front	(Add \$ to Base Price)					
				Wood Group 1 Case	Laminate Price Group 1 Case	Wood Group 1 Front	Wood Case with Wood Front	Wood Group 2	Wood Group 3	Laminate Case with Wood Front	Wood Group 2	Wood Group 3

Plinth Base Freestanding Bookcases, continued

With Two Doors

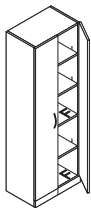

72 1/2"H Bookcases

Three Adjustable Shelves, Two Fixed Shelves

15 7/8"	24"	72 1/2"	E6BF152472D	\$2957	\$2232	\$2685	+\$407	+\$1428	+\$69	+\$242
15 7/8"	30"	72 1/2"	E6BF153072D	\$3090	\$2365	\$2818	+\$428	+\$1498	+\$96	+\$335
15 7/8"	36"	72 1/2"	E6BF153672D	\$3223	\$2498	\$2951	+\$428	+\$1498	+\$96	+\$335

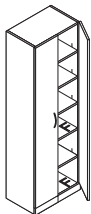

77 1/2"H Bookcases

Four Adjustable Shelves, Two Fixed Shelves

15 7/8"	24"	77 1/2"	E6BF152477D	\$3132	\$2407	\$2860	+\$407	+\$1428	+\$69	+\$242
15 7/8"	30"	77 1/2"	E6BF153077D	\$3276	\$2551	\$3004	+\$428	+\$1498	+\$96	+\$335
15 7/8"	36"	77 1/2"	E6BF153677D	\$3417	\$2692	\$3145	+\$428	+\$1498	+\$96	+\$335

Stacking Bookcases—Open

Wood Veneer or Laminate

SIN 711.2

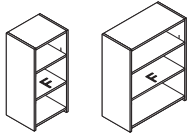

Tip: Shelves with less than 12" of clearance height will not hold some binders in the vertical orientation.

For laminate price group 2 pricing, please refer to the electronic catalog or SmartTools.

Tip: Specify optional 1 1/8" thick heavy load shelves for heavy load conditions. Heavy load conditions are defined as loads of 100 pounds or greater. Heavy load shelves should be specified on wider units (30"W or 36"W) loaded with books or other heavy objects.

Tip: 7 1/2"H shelves and single-high overhead cabinets can be suspended between stacking bookcases. Specify suspension hardware kit separately.

Tip: 36 5/8"H stacking bookcases align with 65 5/8"H freestanding storage when mounted at standard work-surfaces height of 29". 43 3/4"H stacking bookcases align with 72 5/8"H freestanding storage when mounted at standard work-surfaces height of 29".

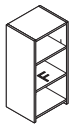

F = Fixed shelf

Standard Includes	Required to Specify
<ul style="list-style-type: none"> Open bookcase <ul style="list-style-type: none"> – wood group 1 or laminate price group 1 Unfinished inset back Shelves: wood or laminate to match case 	<ol style="list-style-type: none"> Style number Wood or laminate color number for bookcase Options, if selected (see below) <ul style="list-style-type: none"> ▶ See <i>Surface Materials</i>, page 566.

Options	Price	Required to Specify
Surface Materials Wood bookcase <ul style="list-style-type: none"> Wood group 2 Wood group 3 Customiz stain 	Prices below and at right Prices below and at right No cost	Specify wood color number. Specify wood color number. Specify with <i>Customiz stain</i> .

Laminate bookcase <ul style="list-style-type: none"> Laminate price group 2 Open Line laminate 	See information at left +\$ 69 plus cost of laminate	Specify laminate color number. ▶ See <i>Surface Materials Reference Manual</i> .
---	--	---

Finished Inset Back <ul style="list-style-type: none"> Laminate Wood 	+\$146 +\$288	Specify with <i>laminate finished inset back</i> . Specify with <i>wood finished inset back</i> .
---	------------------	--

Shelves Heavy load shelves <ul style="list-style-type: none"> On 36 5/8"H and 43 3/4"H bookcases On 48 9/16"H bookcases 	+\$ 48 +\$ 70	Specify with <i>heavy load shelves</i> . Specify with <i>heavy load shelves</i> .
<ul style="list-style-type: none"> Metal shelf 	–\$ 26 per shelf	Specify with <i>metal shelves</i> and select paint color number.

Related Products <ul style="list-style-type: none"> Single-high overhead cabinets Organizer, open, and accessory shelves Suspension hardware kit Finished back panels for stacking bookcases 	▶ Pages 484–490 ▶ Page 504 ▶ Page 522 ▶ Page 324
---	---

Specification Information							
Dimensions			Style	Base Prices		Options	
D	W	H	Number	Wood Group 1 Case	Laminate Price Group 1 Case	Open Front	Open Front
.....
.....
.....
.....
.....
.....
.....
.....

Stacking Bookcases

36 5/8"H Bookcases

Open, One Fixed Shelf, Two Adjustable Shelves

15"	15"	36 5/8"	E6BS151536P	\$1178	\$ 757	+\$177	+\$624
15"	18"	36 5/8"	E6BS151836P	\$1280	\$ 859	+\$177	+\$624
15"	30"	36 5/8"	E6BS153036P	\$1650	\$1229	+\$177	+\$624
15"	36"	36 5/8"	E6BS153636P	\$1753	\$1332	+\$177	+\$624
.....

▶ Specification Information, continued on next page

► Specification Information, continued from previous page

Specification Information							
Dimensions			Style Number	Base Prices		Options	
D	W	H		Wood Group 1 Case	Laminate Price Group 1 Case	(Add \$ to Base Price)	
				Open Front	Open Front	Wood	
						Wood Case with Open Front	
						Wood Group 2	Wood Group 3

Stacking Bookcases, continued

43½"H Bookcases

Open, One Fixed Shelf, Two Adjustable Shelves

15"	15"	43½"	E6BS151543P	\$1298	\$ 877	+\$177	+\$ 624
15"	18"	43½"	E6BS151843P	\$1398	\$ 977	+\$177	+\$ 624
15"	30"	43½"	E6BS153043P	\$1814	\$1393	+\$177	+\$ 624
15"	36"	43½"	E6BS153643P	\$1918	\$1497	+\$177	+\$ 624
:	:	:	:	:	:	:	:

48⅞"H Bookcases

Open, One Fixed Shelf, Three Adjustable Shelves

15"	15"	48⅞"	E6BS151548P	\$1415	\$ 994	+\$330	+\$1154
15"	18"	48⅞"	E6BS151848P	\$1517	\$1096	+\$330	+\$1154
15"	30"	48⅞"	E6BS153048P	\$1978	\$1557	+\$330	+\$1154
15"	36"	48⅞"	E6BS153648P	\$2083	\$1662	+\$330	+\$1154
:	:	:	:	:	:	:	:

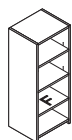
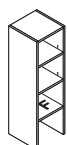

F = Fixed shelf

Stacking Bookcases with Doors

Wood Veneer or Laminate

SIN 711.2

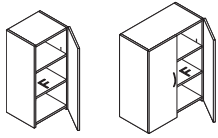

Tip: 36⁵/₈"H stacking bookcases align with 65⁵/₈"H freestanding storage when mounted at standard work-surfaces height of 29". 43¹/₂"H stacking bookcases align with 72¹/₂"H freestanding storage when mounted at standard work-surfaces height of 29".

Standard Includes	Required to Specify
-------------------	---------------------

- Bookcase with door(s), if selected:
 - Wood group 1 case with wood group 1 front
 - Laminate price group 1 case with same or contrasting laminate front
 - Laminate price group 1 case with wood group 1 front
- Single door on 15"W and 18"W units
- Two doors on 30"W and 36"W units
- Unfinished inset back
- Shelves: wood or laminate to match case

- 1 Style number
 - 2 Wood or laminate color number for bookcase
 - 3 Laminate color number for laminate fronts on laminate case, if selected
 - 4 Wood color number for wood fronts on laminate cases, if selected
 - 5 Pull shape (see below under Required Selections)
 - 6 Finish color number for pull
 - 7 Options, if selected (see below)
- ▶ See *Surface Materials*, page 566.

Required Selection

Pull Shape

Contemporary	Jazz	Bar	Nile	Integral*	Transitional	Inset	Beam
No cost	+\$19 each	+\$26 each	+\$26 each	+\$26 each	+\$26 each	+\$26 each	+\$37 each

*Not available on laminate or composite fronts.

Options	Price	Required to Specify
---------	-------	---------------------

Surface Materials	Wood bookcase case	Prices at right	Specify wood color number.
	<ul style="list-style-type: none"> • Wood group 2 • Wood group 3 • Customiz stain 	Prices at right No cost	Specify wood color number. Specify with <i>Customiz stain</i> .
Painted Glass Door(s) for Bookcases	Laminate bookcase case	See information at left +\$ 69 plus cost of laminate	Specify laminate color number. ▶ See <i>Surface Materials Reference Manual</i> .
	<ul style="list-style-type: none"> • Wood group 2 on wood fronts • Wood group 3 on wood fronts • Customiz stain 	Prices at right Prices at right No cost	Specify wood color number. Specify wood color number. Specify with <i>Customiz stain</i> .
	Non-locking glass door(s) for 36⁵/₈"H bookcases	<ul style="list-style-type: none"> • On 15"W +\$350 • On 18"W +\$387 • On 30"W +\$700 • On 36"W +\$774 	Specify with <i>glass door(s)</i> and select finish. Specify with <i>glass door(s)</i> and select finish. Specify with <i>glass door(s)</i> and select finish. Specify with <i>glass door(s)</i> and select finish.
Painted Glass Door(s) for Bookcases	Non-locking glass door(s) for 43¹/₂"H bookcases	<ul style="list-style-type: none"> • On 15"W +\$350 • On 18"W +\$387 • On 30"W +\$700 • On 36"W +\$774 	Specify with <i>glass door(s)</i> and select finish. Specify with <i>glass door(s)</i> and select finish. Specify with <i>glass door(s)</i> and select finish. Specify with <i>glass door(s)</i> and select finish.
	Non-locking glass door(s) for 48⁹/₁₆"H bookcases	<ul style="list-style-type: none"> • On 15"W +\$387 • On 18"W +\$436 • On 30"W +\$774 • On 36"W +\$872 	Specify with <i>glass door(s)</i> and select finish. Specify with <i>glass door(s)</i> and select finish. Specify with <i>glass door(s)</i> and select finish. Specify with <i>glass door(s)</i> and select finish.
	Frame	<ul style="list-style-type: none"> • Painted metal frame for glass doors 	No cost

▶ Options, continued on next page

For laminate price group 2 pricing, please refer to the electronic catalog or *SmartTools*.

Tip: Glass doors have a magnetic touch latch. They do not have pulls.

Tip: Double-door units with integral or beam pulls will have a single pull on the right-hand door.

F = Fixed shelf

► Options, continued from previous page

	Options	Price	Required to Specify
Mirrored Glass Door(s) for Bookcases	Non-locking glass door(s) for 36⁵/₈"H bookcases		
	• On 15"W	+\$ 488	Specify with mirrored glass door and select finish.
	• On 18"W	+\$ 543	Specify with mirrored glass door and select finish.
	• On 30"W	+\$ 976	Specify with mirrored glass door and select finish.
	• On 36"W	+\$1086	Specify with mirrored glass door and select finish.
	Non-locking glass door(s) for 43¹/₂"H bookcases		
	• On 15"W	+\$ 488	Specify with mirrored glass door and select finish.
	• On 18"W	+\$ 543	Specify with mirrored glass door and select finish.
	• On 30"W	+\$ 976	Specify with mirrored glass door and select finish.
	• On 36"W	+\$1086	Specify with mirrored glass door and select finish.
	Non-locking glass door(s) for 48⁹/₁₆"H bookcases		
	• On 15"W	+\$ 543	Specify with mirrored glass door and select finish.
	• On 18"W	+\$ 609	Specify with mirrored glass door and select finish.
	• On 30"W	+\$1086	Specify with mirrored glass door and select finish.
	• On 36"W	+\$1218	Specify with mirrored glass door and select finish.
	Frame		
• Painted metal frame for glass doors	No cost	Specify with frame and select paint color number.	
Finished Inset Back	• Laminate	+\$ 146	Specify with laminate finished inset back.
	• Wood	+\$ 288	Specify with wood finished inset back.
Shelves	Heavy load shelves		
	• On 36 ⁵ / ₈ "H and 43 ¹ / ₂ "H	+\$ 48	Specify with heavy load shelves.
	• On 48 ⁹ / ₁₆ "H	+\$ 70	Specify with heavy load shelves.
	• Metal shelf	-\$ 26 per shelf	Specify with metal shelves and select paint color number.
Related Products	• Single-high overhead cabinets		► Pages 484–490
	• Organizer, open, and accessory shelves		► Page 504
	• Suspension hardware kit		► Page 522
	• Finished back panels for stacking bookcases		► Page 324

► Specification Information, on next page

Tip: Specify optional 1¹/₈" thick heavy load shelves for heavy load conditions. Heavy load conditions are defined as loads of 100 pounds or greater. Heavy load shelves should be specified on wider units (30"W or 36"W) loaded with books or other heavy objects.

Tip: 7¹/₂"H shelves and single-high overhead cabinets can be suspended between stacking bookcases. Specify suspension hardware kit separately.

Elective Elements

Stacking Bookcases with Doors, Wood Veneer or Laminate, continued

SIN 711.2

► Options, on previous page

Specification Information

Dimensions			Style Number	Base Prices			Options (Add \$ to Base Price)				
D	W	H		Wood Group 1 Case	Laminate Price Group 1 Case	Wood Group 1 Front	Wood	Wood	Wood	Wood	
							Wood Case with Wood Front	Wood Group 2	Laminate Case with Wood Front	Wood Group 2	Wood Group 3

Stacking Bookcases

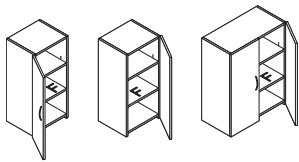

36⁵/₈"H Bookcases

Single Door Hinged Left, One Fixed Shelf, Two Adjustable Shelves

15 ⁷ / ₈ "	15"	36 ⁵ / ₈ "	E6BS151536L	\$1570	\$ 965	\$1207	+\$207	+\$725	+\$28	+\$ 94
15 ⁷ / ₈ "	18"	36 ⁵ / ₈ "	E6BS151836L	\$1673	\$1068	\$1310	+\$207	+\$725	+\$28	+\$ 94

Single Door Hinged Right, One Fixed Shelf, Two Adjustable Shelves

15 ⁷ / ₈ "	15"	36 ⁵ / ₈ "	E6BS151536R	\$1570	\$ 965	\$1207	+\$207	+\$725	+\$28	+\$ 94
15 ⁷ / ₈ "	18"	36 ⁵ / ₈ "	E6BS151836R	\$1673	\$1068	\$1310	+\$207	+\$725	+\$28	+\$ 94

Double Door, One Fixed Shelf, Two Adjustable Shelves

15 ⁷ / ₈ "	30"	36 ⁵ / ₈ "	E6BS153036D	\$2314	\$1709	\$2072	+\$224	+\$788	+\$47	+\$164
15 ⁷ / ₈ "	36"	36 ⁵ / ₈ "	E6BS153636D	\$2518	\$2053	\$2416	+\$224	+\$788	+\$47	+\$164

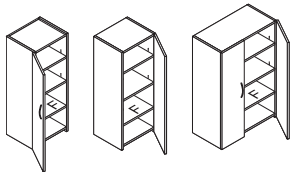

43¹/₂"H Bookcases

Single Door Hinged Left, One Fixed Shelf, Two Adjustable Shelves

15 ⁷ / ₈ "	15"	43 ¹ / ₂ "	E6BS151543L	\$1688	\$1083	\$1325	+\$207	+\$725	+\$28	+\$ 94
15 ⁷ / ₈ "	18"	43 ¹ / ₂ "	E6BS151843L	\$1790	\$1185	\$1427	+\$207	+\$725	+\$28	+\$ 94

Single Door Hinged Right, One Fixed Shelf, Two Adjustable Shelves

15 ⁷ / ₈ "	15"	43 ¹ / ₂ "	E6BS151543R	\$1688	\$1083	\$1325	+\$207	+\$725	+\$28	+\$ 94
15 ⁷ / ₈ "	18"	43 ¹ / ₂ "	E6BS151843R	\$1790	\$1185	\$1427	+\$207	+\$725	+\$28	+\$ 94

Double Door, One Fixed Shelf, Two Adjustable Shelves

15 ⁷ / ₈ "	30"	43 ¹ / ₂ "	E6BS153043D	\$2479	\$1874	\$2237	+\$224	+\$788	+\$47	+\$164
15 ⁷ / ₈ "	36"	43 ¹ / ₂ "	E6BS153643D	\$2680	\$2215	\$2578	+\$246	+\$866	+\$69	+\$242

► Specification Information, continued on next page

► Specification Information, continued from previous page

Specification Information										
Dimensions			Style Number	Base Prices			Options			
D	W	H		Wood Group 1 Case	Laminate Price Group 1 Case	Wood Group 1 Front	(Add \$ to Base Price)			
							Wood Case with Wood Front	Laminate Case with Wood Front	Wood Group 2	Wood Group 3

Stacking Bookcases

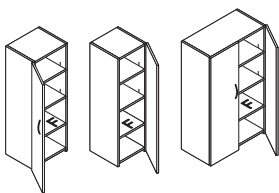

48⁹/₁₆"H Bookcases

Single Door Hinged Left, One Fixed Shelf, Three Adjustable Shelves

15 ⁷ / ₈ "	15"	48 ⁹ / ₁₆ "	E6BS151548L	\$1806	\$1201	\$1443	+\$360	+\$1257	+\$28	+\$ 94
15 ⁷ / ₈ "	18"	48 ⁹ / ₁₆ "	E6BS151848L	\$1907	\$1302	\$1544	+\$377	+\$1318	+\$47	+\$164

Single Door Hinged Right, One Fixed Shelf, Three Adjustable Shelves

15 ⁷ / ₈ "	15"	48 ⁹ / ₁₆ "	E6BS151548R	\$1806	\$1201	\$1443	+\$360	+\$1257	+\$28	+\$ 94
15 ⁷ / ₈ "	18"	48 ⁹ / ₁₆ "	E6BS151848R	\$1907	\$1302	\$1544	+\$377	+\$1318	+\$47	+\$164

Double Door, One Fixed Shelf, Three Adjustable Shelves

15 ⁷ / ₈ "	30"	48 ⁹ / ₁₆ "	E6BS153048D	\$2643	\$2038	\$2401	+\$399	+\$1396	+\$69	+\$242
15 ⁷ / ₈ "	36"	48 ⁹ / ₁₆ "	E6BS153648D	\$2841	\$2376	\$2739	+\$399	+\$1396	+\$69	+\$242

Finished Back Panels for Stacking Bookcases

Wood Veneer or Laminate

SIN 711.2

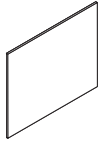

Tip: Specify finished back panels when back of components will be exposed.

Tip: Finished back panels are proud of the case.

For laminate price group 2 pricing, please refer to the electronic catalog or SmartTools.

Standard Includes	Required to Specify
<ul style="list-style-type: none"> Back panel: wood group 1 or laminate price group 1 Attachment hardware 	<ol style="list-style-type: none"> Style number Wood or laminate color number for back panel Options, if selected (see below) <p>▶ See <i>Surface Materials</i>, page 566.</p>

Surface Materials	Options	Price	Required to Specify
	Wood back panel <ul style="list-style-type: none"> Wood group 2 Wood group 3 Customiz stain 	Prices below Prices below No cost	Specify wood color number. Specify wood color number. Specify with <i>Customiz stain</i> .
	Laminate back panel <ul style="list-style-type: none"> Laminate price group 2 Open Line laminate 	See information at left +\$69 plus cost of laminate	Specify laminate color number. ▶ See <i>Surface Materials Reference Manual</i> .

Specification Information						
• Dimensions			• Style	• Base Prices		• Options
D	W	H	Number	Wood Group 1	Laminate Price Group 1	(Add \$ to Base Price)
						Wood
						Wood Group 2
						Wood Group 3

Back Panels

Finished Back Panels for Use with 36⁵/₈"H Stacking Bookcases

3/4"	15"	36 ⁵ / ₈ "	E6NB1536V	\$263	\$202	+\$28	+\$ 94
3/4"	18"	36 ⁵ / ₈ "	E6NB1836V	\$282	\$221	+\$28	+\$ 94
3/4"	30"	36 ⁵ / ₈ "	E6NB3036V	\$368	\$307	+\$47	+\$164
3/4"	36"	36 ⁵ / ₈ "	E6NB3636V	\$387	\$326	+\$47	+\$164

Finished Back Panels for Use with 43¹/₂"H Stacking Bookcases

3/4"	15"	43 ¹ / ₂ "	E6NB1543V	\$281	\$220	+\$28	+\$ 94
3/4"	18"	43 ¹ / ₂ "	E6NB1843V	\$294	\$233	+\$28	+\$ 94
3/4"	30"	43 ¹ / ₂ "	E6NB3043V	\$404	\$343	+\$47	+\$164
3/4"	36"	43 ¹ / ₂ "	E6NB3643V	\$422	\$361	+\$69	+\$242

Finished Back Panels for Use with 48⁹/₁₆"H Stacking Bookcases

3/4"	15"	48 ⁹ / ₁₆ "	E6NB1548V	\$300	\$239	+\$28	+\$ 94
3/4"	18"	48 ⁹ / ₁₆ "	E6NB1848V	\$305	\$244	+\$47	+\$164
3/4"	30"	48 ⁹ / ₁₆ "	E6NB3048V	\$439	\$378	+\$69	+\$242
3/4"	36"	48 ⁹ / ₁₆ "	E6NB3648V	\$456	\$395	+\$69	+\$242

Finished Back Panels for
Stacking Bookcases

SIN 711.2

Plinth Base Towers with Full-Height Doors

Wood Veneer or Laminate

SIN 711.2

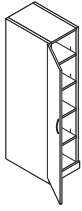

Standard Includes	Required to Specify
-------------------	---------------------

- Tower:
 - Wood group 1 case with wood group 1 front
 - Laminate price group 1 case with same or contrasting laminate front
 - Laminate price group 1 case with wood group 1 front
- Single door on 15½"W units
- Two doors on 24"W units:
 - Right-hand units: wardrobe on right, doors hinged right
 - Left-hand units: wardrobe on left, doors hinged left
- Finished inset back on 45"H, 55¼"H, 65⅝"H, and 72½"H towers
- Unfinished inset back on 77½"H towers
- Shelves: wood or laminate to match case
- Brackets for adjustable shelves: black only
- Two coat hooks in wardrobe: brushed nickel only
- Lock, keyed random

- 1 Style number
 - 2 Wood or laminate color number for tower
 - 3 Laminate color number for laminate fronts on laminate case, if selected
 - 4 Wood color number for wood fronts on laminate cases, if selected
 - 5 Pull shape (see below under Required Selections)
 - 6 Finish color number for pull
 - 7 Finish color number for lock
 - 8 Options, if selected (see below)
- ▶ See *Surface Materials*, page 566.

Required Selections

Pull Shape

Contemporary	Jazz	Bar	Nile	Integral*	Transitional	Inset	Beam
No cost	+\$19 each	+\$26 each	+\$26 each	+\$26 each	+\$26 each	+\$26 each	+\$37 each

*Not available on laminate or composite fronts.

Options	Price	Required to Specify
---------	-------	---------------------

Surface Materials	Wood tower case	Prices at right Prices at right No cost	Specify wood color number. Specify wood color number. Specify <i>with Customiz stain</i> .
	Laminate tower case	See information at left +\$ 69 plus cost of laminate Prices at right Prices at right No cost	Specify laminate color number. ▶ See <i>Surface Materials Reference Manual</i> . Specify wood color number. Specify wood color number. Specify <i>with Customiz stain</i> .
Lock and Keying	Lock	No cost No cost	Specify <i>with 9250 Ember Chrome lock</i> . Specify <i>with 9201 Polished Chrome lock</i> .
	Keying	Factory- and field-installed keying units	▶ Page 622
Shelves	• ¾" shelf • Metal shelf	No cost –\$ 26 per shelf	Specify <i>with ¾" shelf</i> . Specify <i>with metal shelves</i> and select paint color number.
Painted Glass Door for Towers	Non-locking glass door	+\$387 +\$436 +\$473 +\$508	Specify <i>with glass door</i> and select finish. Specify <i>with glass door</i> and select finish. Specify <i>with glass door</i> and select finish. Specify <i>with glass door</i> and select finish.
	Frame	• Painted metal frame for glass doors	No cost Specify <i>with frame</i> and select paint color number.

▶ Options, continued on next page

For laminate price group 2 pricing, please refer to the electronic catalog or SmartTools.

Tip: On units with two doors, only the wardrobe door locks.

Tip: Locks are not available on doors with integral pulls.

Tip: On 24"W towers specified with a glass door, only the 15"W door will be glass. The wardrobe door will be wood or laminate.

Tip: Glass doors have a magnetic touch latch. They do not have pulls.

► Options, continued from previous page

Options	Price	Required to Specify
Mirrored Glass Door(s) for Tower		
• Non-locking glass door		
• On 45"H wood towers	+\$543	Specify with <i>mirrored glass door</i> and select finish.
• On 55¼"H and 65⅝"H wood towers	+\$609	Specify with <i>mirrored glass door</i> and select finish.
• On 72½"H wood towers	+\$661	Specify with <i>mirrored glass door</i> and select finish.
• On 77½"H wood towers	+\$712	Specify with <i>mirrored glass door</i> and select finish.
Frame		
• Painted metal frame for glass doors	No cost	Specify with <i>frame</i> and select paint color number.

Tip: 7½"H shelves and overhead cabinets can be suspended between towers. Specify suspension hardware kit separately.

Related Products

- Single-high overhead cabinets
- Double-high overhead cabinets
- Organizer, open, and accessory shelves
- Suspension hardware kit

- Pages 484–490
- Page 494
- Page 504
- Page 522

Specification Information

Dimensions			Style Number	Base Prices			Options					
D	W	H		Wood Group 1 Case	Laminate Price Group 1 Front	Wood Group 1 Front	(Add \$ to Base Price)					
							Wood Case with Wood Front	Laminate Case with Wood Front	Wood Group 2	Wood Group 3	Wood Group 2	Wood Group 3

Plinth Base Towers

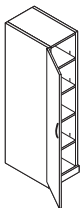

Tip: Specify a left-hand (hinged left) unit if the user is sitting to the right of the unit and a right-hand (hinged right) unit if the user is sitting to the left of the unit.

Towers with Door Hinged Left

One Adjustable Shelf, Two Fixed Shelves

18"	15½"	45"	E6TW181545L	\$1580	\$ 735	\$1217	+\$291	+\$1015	+\$47	+\$164
24"	15½"	45"	E6TW241545L	\$1924	\$1079	\$1561	+\$291	+\$1015	+\$47	+\$164

Two Adjustable Shelves, Two Fixed Shelves

18"	15½"	55¼"	E6TW181555L	\$1732	\$ 887	\$1369	+\$291	+\$1015	+\$47	+\$164
24"	15½"	55¼"	E6TW241555L	\$2076	\$1231	\$1713	+\$291	+\$1015	+\$47	+\$164

Three Adjustable Shelves, Two Fixed Shelves

24"	15½"	65⅝"	E6TW241565A	\$2228	\$1383	\$1865	+\$313	+\$1093	+\$69	+\$242
24"	15½"	72½"	E6TW241572A	\$2284	\$1439	\$1921	+\$313	+\$1093	+\$69	+\$242

Four Adjustable Shelves, Two Fixed Shelves

24"	15½"	77½"	E6TW241577A	\$2340	\$1495	\$1977	+\$313	+\$1093	+\$69	+\$242
-----	------	------	--------------------	--------	--------	--------	--------	---------	-------	--------

► Specification Information, continued on next page

Plinth Base Towers with Full-Height Doors, Wood Veneer or Laminate, continued

SIN 711.2

► Specification Information, continued from previous page

Specification Information										
Dimensions			Style Number	Base Prices			Options			
D	W	H		Wood Group 1 Case	Laminate Price Group 1 Case	Wood Group 1 Front	(Add \$ to Base Price)		Wood	
							Wood Case with Wood Front	Laminate Case with Wood Front	Wood Group 2	Wood Group 3
							Wood Group 2	Wood Group 3	Wood Group 2	Wood Group 3

Plinth Base Towers, continued

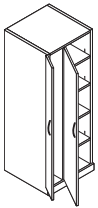

Tip: Specify a left-hand (hinged left) unit if the user is sitting to the right of the unit and a right-hand (hinged right) unit if the user is sitting to the left of the unit.

Towers with Doors Hinged Left, Wardrobe Left

Three Adjustable Shelves, Two Fixed Shelves										
24"	24"	65 ⁵ / ₈ "	E6TW242465C	\$2676	\$1831	\$2313	+\$362	+\$1272	+\$69	+\$242
30"	24"	65 ⁵ / ₈ "	E6TW302465C	\$3019	\$2174	\$2656	+\$362	+\$1272	+\$69	+\$242
24"	24"	72 ¹ / ₂ "	E6TW242472C	\$2741	\$1896	\$2378	+\$362	+\$1272	+\$69	+\$242
30"	24"	72 ¹ / ₂ "	E6TW302472C	\$3085	\$2240	\$2722	+\$362	+\$1272	+\$69	+\$242
Four Adjustable Shelves, Two Fixed Shelves										
24"	24"	77 ¹ / ₂ "	E6TW242477C	\$2807	\$1962	\$2444	+\$362	+\$1272	+\$69	+\$242
30"	24"	77 ¹ / ₂ "	E6TW302477C	\$3152	\$2307	\$2789	+\$362	+\$1272	+\$69	+\$242

► Specification Information, continued on next page

► Specification Information, continued from previous page

Specification Information										
Dimensions			Style Number	Base Prices			Options (Add \$ to Base Price)			
D	W	H		Wood Group 1 Case	Laminate Price Group 1 Case	Wood Group 1 Front	Wood	Wood	Wood	Wood
							Wood Case with Wood Front	Laminate Case with Wood Front	Wood Group 2	Wood Group 3

Plinth Base Towers, continued

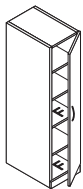

Towers with Door Hinged Right

One Adjustable Shelf, Two Fixed Shelves

18"	15½"	45"	E6TW181545R	\$1580	\$ 735	\$1217	+\$291	+\$1015	+\$47	+\$164
24"	15½"	45"	E6TW241545R	\$1924	\$1079	\$1561	+\$291	+\$1015	+\$47	+\$164

Two Adjustable Shelves, Two Fixed Shelves

18"	15½"	55¼"	E6TW181555R	\$1732	\$ 887	\$1369	+\$291	+\$1015	+\$47	+\$164
24"	15½"	55¼"	E6TW241555R	\$2076	\$1231	\$1713	+\$291	+\$1015	+\$47	+\$164

Three Adjustable Shelves, Two Fixed Shelves

24"	15½"	65⅝"	E6TW241565B	\$2228	\$1383	\$1865	+\$313	+\$1093	+\$69	+\$242
24"	15½"	72½"	E6TW241572B	\$2284	\$1439	\$1921	+\$313	+\$1093	+\$69	+\$242

Four Adjustable Shelves, Two Fixed Shelves

24"	15½"	77½"	E6TW241577B	\$2340	\$1495	\$1977	+\$313	+\$1093	+\$69	+\$242
-----	------	------	--------------------	--------	--------	--------	--------	---------	-------	--------

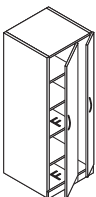

Tip: Specify a left-hand (hinged left) unit if the user is sitting to the right of the unit and a right-hand (hinged right) unit if the user is sitting to the left of the unit.

Towers with Doors Hinged Right, Wardrobe Right

Three Adjustable Shelves, Two Fixed Shelves

24"	24"	65⅝"	E6TW242465D	\$2676	\$1831	\$2313	+\$362	+\$1272	+\$69	+\$242
30"	24"	65⅝"	E6TW302465D	\$3019	\$2174	\$2656	+\$362	+\$1272	+\$69	+\$242
24"	24"	72½"	E6TW242472D	\$2741	\$1896	\$2378	+\$362	+\$1272	+\$69	+\$242
30"	24"	72½"	E6TW302472D	\$3085	\$2240	\$2722	+\$362	+\$1272	+\$69	+\$242

Four Adjustable Shelves, Two Fixed Shelves

24"	24"	77½"	E6TW242477D	\$2807	\$1962	\$2444	+\$362	+\$1272	+\$69	+\$242
30"	24"	77½"	E6TW302477D	\$3152	\$2307	\$2789	+\$362	+\$1272	+\$69	+\$242

Plinth Base Towers with Doors and Drawers

Wood Veneer or Laminate

SIN 711.2

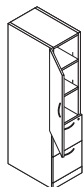

Standard Includes	Required to Specify
-------------------	---------------------

- | | |
|--|---|
| <ul style="list-style-type: none"> • Tower: <ul style="list-style-type: none"> –Wood group 1 case with wood group 1 front –Laminate price group 1 case with same or contrasting laminate front –Laminate price group 1 case with wood group 1 front • Single door on 15½"W units • Two doors on 24"W units: <ul style="list-style-type: none"> –Right-hand units: wardrobe on right, doors hinged right –Left-hand units: wardrobe on left, doors hinged left • Finished inset back on 45"H, 55¼"H, 65⅝"H, and 72½"H towers • Unfinished inset back on 77½"H towers • Dovetail drawer construction • Shelves: wood or laminate to match case • Brackets for adjustable shelves: black only • Two coat hooks in wardrobe: brushed nickel only • One fastened metal filing system per file drawer: black only • Lock, keyed random • Standard close drawer slides | <ul style="list-style-type: none"> 1 Style number 2 Wood or laminate color number for tower 3 Laminate color number for laminate fronts on laminate case, if selected 4 Wood color number for wood fronts on laminate cases, if selected 5 Pull shape (see below under Required Selections) 6 Finish color number for pull 7 Finish color number for lock 8 Options, if selected (see below) ▶ See <i>Surface Materials</i>, page 566. |
|--|---|

Required Selection

Pull Shape

Contemporary	Jazz	Bar	Nile	Integral*	Transitional	Inset	Beam
No cost	+\$19 each	+\$26 each	+\$26 each	+\$26 each	+\$26 each	+\$26 each	+\$37 each

*Not available on laminate or composite fronts.

Options	Price	Required to Specify
---------	-------	---------------------

<p>Surface Materials</p>	<p>Wood tower case</p> <ul style="list-style-type: none"> • Wood group 2 • Wood group 3 • Customiz stain <hr/> <p>Laminate tower case</p> <ul style="list-style-type: none"> • Laminate price group 2 • Open Line laminate <ul style="list-style-type: none"> • Wood group 2 on wood fronts • Wood group 3 on wood fronts • Customiz stain 	<p>Prices at right Prices at right No cost</p> <hr/> <p>See information at left +\$69 plus cost of laminate Prices at right Prices at right No cost</p>	<p>Specify wood color number. Specify wood color number. Specify <i>with Customiz stain</i>.</p> <hr/> <p>Specify laminate color number. ▶ See <i>Surface Materials Reference Manual</i>.</p> <p>Specify wood color number. Specify wood color number. Specify <i>with Customiz stain</i>.</p>
---------------------------------	--	---	--

<p>Drawer Slide</p>	<ul style="list-style-type: none"> • Soft close drawer slides 	<p>+\$30 per drawer</p>	<p>Specify <i>with soft close drawers</i>.</p>
----------------------------	--	-------------------------	--

▶ **Options, continued on next page**

For laminate price group 2 pricing, please refer to the electronic catalog or SmartTools.

Tip: Soft close drawer slides only apply to storage that have 15½"W drawers.

Tip: Soft close slides are available for both dovetail and miter fold construction.

► Options, continued from previous page

	Options	Price	Required to Specify
Lock and Keying	Lock		
	<ul style="list-style-type: none"> Ember Chrome Polished Chrome 	<ul style="list-style-type: none"> No cost No cost 	<ul style="list-style-type: none"> Specify with 9250 Ember Chrome lock. Specify with 9201 Polished Chrome lock.
	Keying		
	<ul style="list-style-type: none"> Factory- and field-installed keying units 		► Page 622
Shelves	<ul style="list-style-type: none"> ¾" shelf Metal shelf 	<ul style="list-style-type: none"> No cost -\$26 per shelf 	<ul style="list-style-type: none"> Specify with ¾" shelf. Specify with metal shelves and select paint color number.
	Painted Glass Door(s) for Towers	Non-locking glass door	
	<ul style="list-style-type: none"> On 45"H wood towers On 55¼"H and 65⅝"H wood towers On 72½"H wood towers On 77½"H wood towers 	<ul style="list-style-type: none"> +\$314 +\$350 +\$369 +\$387 	<ul style="list-style-type: none"> Specify with glass door and select finish. Specify with glass door and select finish. Specify with glass door and select finish. Specify with glass door and select finish.
	Frame		
	<ul style="list-style-type: none"> Painted metal frame for glass doors 	No cost	Specify with frame and select paint color number.
Mirrored Glass Door(s) for Tower	Non-locking glass door		
	<ul style="list-style-type: none"> On 45"H wood towers On 55¼"H and 65⅝"H wood towers On 72½"H wood towers On 77½"H wood towers 	<ul style="list-style-type: none"> +\$440 +\$488 +\$516 +\$543 	<ul style="list-style-type: none"> Specify with mirrored glass door and select finish. Specify with mirrored glass door and select finish. Specify with mirrored glass door and select finish. Specify with mirrored glass door and select finish.
	Frame		
	<ul style="list-style-type: none"> Painted metal frame for glass doors 	No cost	Specify with frame and select paint color number.
Miter Fold Drawer	(Not available on 18"D towers)		
	<ul style="list-style-type: none"> On 45"H towers (with one drawer) On 45"H towers (with two drawers) On 55¼"H towers On 65⅝"H towers On 72½"H towers On 77½"H towers 	<ul style="list-style-type: none"> -\$ 32 -\$ 64 -\$ 64 -\$ 64 -\$ 64 -\$ 64 	<ul style="list-style-type: none"> Specify with miter fold drawers. Specify with miter fold drawers. Specify with miter fold drawers. Specify with miter fold drawers. Specify with miter fold drawers. Specify with miter fold drawers.
Related Products	<ul style="list-style-type: none"> Single-high overhead cabinets Double-high overhead cabinets Organizer, open, and accessory shelves Suspension hardware kit 		<ul style="list-style-type: none"> ► Pages 484–490 ► Page 494 ► Page 504 ► Page 522

► Specification Information, on next page

Tip: Locks are not available on doors with integral pulls. Drawers with integral pulls always lock.

Tip: When integral pull is specified with a 9250 Ember Chrome lock, the lock housing is black. When 9201 Polished Chrome lock is specified, the lock housing is nickel.

Tip: On units with two doors, only the wardrobe door locks. Drawers always lock. Tip: On 24"W towers specified with a glass door, only the 15"W door will be glass. The wardrobe door will be wood or laminate.

Tip: Glass doors have a magnetic touch latch. They do not have pulls.

Tip: Soft close slides are available for both dovetail and miter fold construction.

Tip: Organizer and open shelves and overhead cabinets can be suspended between 65⅝"H, 72½"H, and 77½"H towers. Specify suspension hardware kit separately.

Plinth Base Towers with Doors and Drawers, Wood Veneer or Laminate, continued

SIN 711.2

► Options, on previous page

Specification Information										
Dimensions			Style Number	Base Prices			Options (Add \$ to Base Price)			
D	W	H		Wood Group 1 Case	Laminate Price Group 1 Case	Wood Group 1 Front	Wood Group 2	Wood Group 3	Laminate Case with Wood Front	Wood Group 2

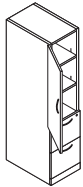

Tip: Specify a left-hand (hinged left) unit if the user is sitting to the right of the unit and a right-hand (hinged right) unit if the user is sitting to the left of the unit.

Plinth Base Towers with Door Hinged Left

One Adjustable Shelf, One File Drawer on Bottom

24"	15½"	45"	E6TW241545E	\$2777	\$1932	\$2414	+\$261	+\$ 913	+\$47	+\$164
-----	------	-----	--------------------	--------	--------	--------	--------	---------	-------	--------

Two Adjustable Shelves, Two File Drawers on Bottom

24"	15½"	65⅝"	E6TW241565E	\$3103	\$2258	\$2740	+\$313	+\$1093	+\$69	+\$242
-----	------	------	--------------------	--------	--------	--------	--------	---------	-------	--------

24"	15½"	72½"	E6TW241572E	\$3179	\$2334	\$2816	+\$313	+\$1093	+\$69	+\$242
-----	------	------	--------------------	--------	--------	--------	--------	---------	-------	--------

Three Adjustable Shelves, Two File Drawers on Bottom

24"	15½"	77½"	E6TW241577E	\$3253	\$2408	\$2890	+\$313	+\$1093	+\$69	+\$242
-----	------	------	--------------------	--------	--------	--------	--------	---------	-------	--------

Plinth Base Towers with Doors Hinged Left, Wardrobe Left

One Adjustable Shelf, One Box and One File Drawer on Bottom

18"	24"	45"	E6TW182445T	\$3084	\$2239	\$2721	+\$312	+\$1093	+\$47	+\$164
-----	-----	-----	--------------------	--------	--------	--------	--------	---------	-------	--------

Two Adjustable Shelves, One Box and One File Drawer on Bottom

18"	24"	55¼"	E6TW182455T	\$3130	\$2285	\$2767	+\$312	+\$1093	+\$47	+\$164
-----	-----	------	--------------------	--------	--------	--------	--------	---------	-------	--------

One Adjustable Shelf, One Box and One File Drawer on Bottom

24"	24"	45"	E6TW242445T	\$3130	\$2285	\$2767	+\$312	+\$1093	+\$47	+\$164
-----	-----	-----	--------------------	--------	--------	--------	--------	---------	-------	--------

Two Adjustable Shelves, One Box and One File Drawer on Bottom

24"	24"	55¼"	E6TW242455T	\$3175	\$2330	\$2812	+\$312	+\$1093	+\$47	+\$164
-----	-----	------	--------------------	--------	--------	--------	--------	---------	-------	--------

One Adjustable Shelf, One File Drawer on Bottom

24"	24"	45"	E6TW242445G	\$3084	\$2239	\$2721	+\$312	+\$1093	+\$47	+\$164
-----	-----	-----	--------------------	--------	--------	--------	--------	---------	-------	--------

Two Adjustable Shelves, Two File Drawers on Bottom

24"	24"	65⅝"	E6TW242465G	\$3265	\$2420	\$2902	+\$362	+\$1272	+\$69	+\$242
-----	-----	------	--------------------	--------	--------	--------	--------	---------	-------	--------

24"	24"	72½"	E6TW242472G	\$3344	\$2499	\$2981	+\$362	+\$1272	+\$69	+\$242
-----	-----	------	--------------------	--------	--------	--------	--------	---------	-------	--------

Three Adjustable Shelves, Two File Drawers on Bottom

24"	24"	77½"	E6TW242477G	\$3426	\$2581	\$3063	+\$362	+\$1272	+\$69	+\$242
-----	-----	------	--------------------	--------	--------	--------	--------	---------	-------	--------

► Specification Information, continued on next page

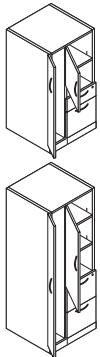

Tip: Specify a left-hand (hinged left) unit if the user is sitting to the right of the unit and a right-hand (hinged right) unit if the user is sitting to the left of the unit.

► Specification Information, continued from previous page

Specification Information											
Dimensions			Style Number	Base Prices			Options (Add \$ to Base Price)				
D	W	H		Wood Group 1 Case	Laminate Price Group 1 Case	Wood Group 1 Front	Wood Group 1 Front	Wood Group 2	Wood Group 3	Laminate Case with Wood Front	Wood Group 2

Plinth Base Towers with Door Hinged Right

One Adjustable Shelf, One File Drawer on Bottom

24"	15½"	45"	E6TW241545F	\$2777	\$1932	\$2414	+\$261	+\$ 913	+\$47	+\$164
-----	------	-----	--------------------	--------	--------	--------	--------	---------	-------	--------

Two Adjustable Shelves, Two File Drawers on Bottom

24"	15½"	65⅝"	E6TW241565F	\$3103	\$2258	\$2740	+\$313	+\$1093	+\$69	+\$242
-----	------	------	--------------------	--------	--------	--------	--------	---------	-------	--------

24"	15½"	72½"	E6TW241572F	\$3179	\$2334	\$2816	+\$313	+\$1093	+\$69	+\$242
-----	------	------	--------------------	--------	--------	--------	--------	---------	-------	--------

Three Adjustable Shelves, Two File Drawers on Bottom

24"	15½"	77½"	E6TW241577F	\$3253	\$2408	\$2890	+\$313	+\$1093	+\$69	+\$242
-----	------	------	--------------------	--------	--------	--------	--------	---------	-------	--------

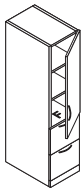

Tip: Specify a left-hand (hinged left) unit if the user is sitting to the right of the unit and a right-hand (hinged right) unit if the user is sitting to the left of the unit.

Plinth Base Towers with Doors Hinged Right, Wardrobe Right

One Adjustable Shelf, One Box and One File Drawer on Bottom

18"	24"	45"	E6TW182445W	\$3084	\$2239	\$2721	+\$312	+\$1093	+\$47	+\$164
-----	-----	-----	--------------------	--------	--------	--------	--------	---------	-------	--------

Two Adjustable Shelves, One Box and One File Drawer on Bottom

18"	24"	55¼"	E6TW182455W	\$3130	\$2285	\$2767	+\$312	+\$1093	+\$47	+\$164
-----	-----	------	--------------------	--------	--------	--------	--------	---------	-------	--------

One Adjustable Shelf, One Box and One File Drawer on Bottom

24"	24"	45"	E6TW242445W	\$3130	\$2285	\$2767	+\$312	+\$1093	+\$47	+\$164
-----	-----	-----	--------------------	--------	--------	--------	--------	---------	-------	--------

Two Adjustable Shelves, One Box and One File Drawer on Bottom

24"	24"	55¼"	E6TW242455W	\$3175	\$2330	\$2812	+\$312	+\$1093	+\$47	+\$164
-----	-----	------	--------------------	--------	--------	--------	--------	---------	-------	--------

One Adjustable Shelf, One File Drawer on Bottom

24"	24"	45"	E6TW242445H	\$3084	\$2239	\$2721	+\$312	+\$1093	+\$47	+\$164
-----	-----	-----	--------------------	--------	--------	--------	--------	---------	-------	--------

Two Adjustable Shelves, Two File Drawers on Bottom

24"	24"	65⅝"	E6TW242465H	\$3265	\$2420	\$2902	+\$362	+\$1272	+\$69	+\$242
-----	-----	------	--------------------	--------	--------	--------	--------	---------	-------	--------

24"	24"	72½"	E6TW242472H	\$3344	\$2499	\$2981	+\$362	+\$1272	+\$69	+\$242
-----	-----	------	--------------------	--------	--------	--------	--------	---------	-------	--------

Three Adjustable Shelves, Two File Drawers on Bottom

24"	24"	77½"	E6TW242477H	\$3426	\$2581	\$3063	+\$362	+\$1272	+\$69	+\$242
-----	-----	------	--------------------	--------	--------	--------	--------	---------	-------	--------

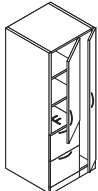
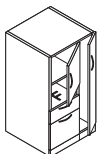

Tip: Specify a left-hand (hinged left) unit if the user is sitting to the right of the unit and a right-hand (hinged right) unit if the user is sitting to the left of the unit.

Plinth Base Towers with Open Shelves and Drawers

Wood Veneer or Laminate

SIN 711.2

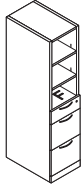

Standard Includes	Required to Specify
<ul style="list-style-type: none"> • Tower: <ul style="list-style-type: none"> –Wood group 1 case with wood group 1 front –Laminate price group 1 case with same or contrasting laminate front –Laminate price group 1 case with wood group 1 front • Wardrobe on 24"W units: <ul style="list-style-type: none"> –Right-hand units: wardrobe on right, doors hinged right –Left-hand units: wardrobe on left, doors hinged left • Finished inset back on 45"H, 55¼"H, 65⅝"H, and 72½"H towers • Unfinished inset back on 77½"H towers • Dovetail drawer construction • Shelves: wood or laminate to match case • Brackets for adjustable shelves: black only • Two coat hooks in wardrobe: brushed nickel only • One fastened metal filing system per file drawer: black only • Lock, keyed random • Standard close drawer slides 	<ol style="list-style-type: none"> 1 Style number 2 Wood or laminate color number for tower 3 Laminate color number for laminate fronts on laminate case, if selected 4 Wood color number for wood fronts on laminate cases, if selected 5 Pull shape (see below under Required Selections) 6 Finish color number for pull 7 Finish color number for lock 8 Options, if selected (see below) <p>▶ See <i>Surface Materials</i>, page 566.</p>

Required Selection							
Pull Shape							
Contemporary	Jazz	Bar	Nile	Integral*	Transitional	Inset	Beam
No cost	+\$19 each	+\$26 each	+\$26 each	+\$26 each	+\$26 each	+\$26 each	+\$37 each

*Not available on laminate or composite fronts.

Options	Price	Required to Specify
Surface Materials <ul style="list-style-type: none"> • Wood tower case <ul style="list-style-type: none"> • Wood group 2 • Wood group 3 • Customiz stain • Laminate tower case <ul style="list-style-type: none"> • Laminate price group 2 • Open Line laminate • Wood group 2 on wood fronts • Wood group 3 on wood fronts • Customiz stain 	Prices at right Prices at right No cost See information at left +\$69 plus cost of laminate Prices at right Prices at right No cost	Specify wood color number. Specify wood color number. Specify with <i>Customiz stain</i> . Specify laminate color number. ▶ See <i>Surface Materials Reference Manual</i> . Specify wood color number. Specify wood color number. Specify with <i>Customiz stain</i> .
Drawer Slide <ul style="list-style-type: none"> • Soft close drawer slides 	+\$30 per drawer	Specify with <i>soft close drawers</i> .
Lock and Keying <ul style="list-style-type: none"> • Lock <ul style="list-style-type: none"> • Ember Chrome • Polished Chrome • Keying <ul style="list-style-type: none"> • Factory- and field-installed keying units 	No cost No cost ▶ Page 622	Specify with <i>9250 Ember Chrome lock</i> . Specify with <i>9201 Polished Chrome lock</i> .
Shelves <ul style="list-style-type: none"> • ¾" shelf • Metal shelf 	No cost –\$26 per shelf	Specify with <i>¾" shelf</i> . Specify with <i>metal shelves</i> and select paint color number.

▶ Options, continued on next page

For laminate price group 2 pricing, please refer to the electronic catalog or SmartTools.

Tip: Soft close drawer slides only apply to storage that have 15½"W drawers.

Tip: Soft close slides are available for both dovetail and miter fold construction.

Tip: Locks are not available on doors with integral pulls. Drawers with integral pulls always lock.

F = Fixed shelf

► Options, continued from previous page

Options	Price	Required to Specify
Miter Fold Drawer	(Not available on 18"D towers)	
• On 45"H towers	-\$64	Specify with miter fold drawers.
• On 55¼"H towers	-\$64	Specify with miter fold drawers.
• On 65⅝"H towers	-\$64	Specify with miter fold drawers.
• On 72½"H towers	-\$64	Specify with miter fold drawers.
• On 77½"H towers	-\$64	Specify with miter fold drawers.
Related Products	• Single-high overhead cabinets • Double-high overhead cabinets • Organizer, open, and accessory shelves • Suspension hardware kit	► Pages 484–490 ► Page 494 ► Page 504 ► Page 522

Tip: Organizer and open shelves and overhead cabinets can be suspended between 65⅝"H, 72½"H, and 77½"H towers. Specify suspension hardware kit separately.

Specification Information										
Dimensions			Style Number	Base Prices			Options			
D	W	H		Wood Case	Laminate Price Group 1	Wood Case	(Add \$ to Base Price)			
				Wood Group 1	Laminate Price Group 1	Wood Group 1	Wood Case with Wood Front	Wood	Wood	Wood
				Front	Front	Front	Wood Group 2	Wood Group 3	Wood Group 2	Wood Group 3
							Laminate Case with Wood Front	Wood	Wood	Wood

Plinth Base Towers

Open Shelves

One Adjustable Shelf, One Box and One File Drawer on Bottom

18"	15½"	45"	E6TW181545J	\$2388	\$1783	\$2086	+\$262	+\$ 912	+\$28	+\$94
24"	15½"	45"	E6TW241545J	\$2734	\$2129	\$2432	+\$262	+\$ 912	+\$28	+\$94

Two Adjustable Shelves, One Box and One File Drawers on Bottom

18"	15½"	55¼"	E6TW181555J	\$2542	\$1937	\$2240	+\$262	+\$ 912	+\$28	+\$94
24"	15½"	55¼"	E6TW241555J	\$2887	\$2282	\$2585	+\$262	+\$ 912	+\$28	+\$94

Two Adjustable Shelves, One Box and Two File Drawers on Bottom

24"	15½"	65⅝"	E6TW241565J	\$3059	\$2454	\$2757	+\$313	+\$1093	+\$28	+\$94
24"	15½"	72½"	E6TW241572J	\$3134	\$2529	\$2832	+\$313	+\$1093	+\$28	+\$94

Three Adjustable Shelves, One Box and Two File Drawers on Bottom

24"	15½"	77½"	E6TW241577J	\$3212	\$2607	\$2910	+\$313	+\$1093	+\$28	+\$94
-----	------	------	--------------------	--------	--------	--------	--------	---------	-------	-------

► Specification Information, continued on next page

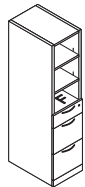

F = Fixed shelf

Plinth Base Towers with Open Shelves and Drawers, Wood Veneer or Laminate, continued

SIN 711.2

► Specification Information, continued from previous page

Specification Information														
Dimensions			Style Number	Base Prices			Options							
D	W	H		Wood Group 1 Case	Laminate Price Group 1 Case	Wood Group 1 Front	Wood			Wood				
							Wood Case with Wood Front	Laminate Case with Wood Front	Wood	Wood	Wood	Wood	Wood	Wood
							Group 2	Group 3	Group 2	Group 3	Group 2	Group 3	Group 2	Group 3

Plinth Base Towers, continued

Open Shelves with Door Hinged Left, Wardrobe Left

One Adjustable Shelf, One Box and One File Drawer on Bottom

24"	24"	45"	E6TW242445K	\$3086	\$2437	\$2740	+\$312	+\$1093	+\$47	+\$164
-----	-----	-----	--------------------	--------	--------	--------	--------	---------	-------	--------

Two Adjustable Shelves, One Box and Two File Drawers on Bottom

24"	24"	65 ⁵ / ₈ "	E6TW242465K	\$3237	\$2632	\$2935	+\$364	+\$1272	+\$47	+\$164
-----	-----	----------------------------------	--------------------	--------	--------	--------	--------	---------	-------	--------

24"	24"	72 ¹ / ₂ "	E6TW242472K	\$3317	\$2712	\$3015	+\$364	+\$1272	+\$47	+\$164
-----	-----	----------------------------------	--------------------	--------	--------	--------	--------	---------	-------	--------

Three Adjustable Shelves, One Box and Two File Drawers on Bottom

24"	24"	77 ¹ / ₂ "	E6TW242477K	\$3396	\$2791	\$3094	+\$364	+\$1272	+\$47	+\$164
-----	-----	----------------------------------	--------------------	--------	--------	--------	--------	---------	-------	--------

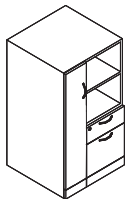

Tip: Specify a left-hand (hinged left) unit if the user is sitting to the right of the unit and a right-hand (hinged right) unit if the user is sitting to the left of the unit.

Open Shelves with Door Hinged Right, Wardrobe Right

One Adjustable Shelf, One Box and One File Drawer on Bottom

24"	24"	45"	E6TW242445L	\$3086	\$2437	\$2740	+\$312	+\$1093	+\$47	+\$164
-----	-----	-----	--------------------	--------	--------	--------	--------	---------	-------	--------

Two Adjustable Shelves, One Box and Two File Drawers on Bottom

24"	24"	65 ⁵ / ₈ "	E6TW242465L	\$3237	\$2632	\$2935	+\$364	+\$1272	+\$47	+\$164
-----	-----	----------------------------------	--------------------	--------	--------	--------	--------	---------	-------	--------

24"	24"	72 ¹ / ₂ "	E6TW242472L	\$3317	\$2712	\$3015	+\$364	+\$1272	+\$47	+\$164
-----	-----	----------------------------------	--------------------	--------	--------	--------	--------	---------	-------	--------

Three Adjustable Shelves, One Box and Two File Drawers on Bottom

24"	24"	77 ¹ / ₂ "	E6TW242477L	\$3396	\$2791	\$3094	+\$364	+\$1272	+\$47	+\$164
-----	-----	----------------------------------	--------------------	--------	--------	--------	--------	---------	-------	--------

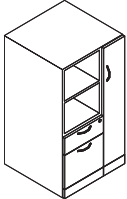

Open Side Bookshelf on Right with Door Hinged Left, Wardrobe Left

Two Adjustable Shelves, One Box and Two File Drawers on Bottom

24"	24"	65 ⁵ / ₈ "	E6TW242465M	\$3237	\$2632	\$2935	+\$364	+\$1272	+\$47	+\$164
-----	-----	----------------------------------	--------------------	--------	--------	--------	--------	---------	-------	--------

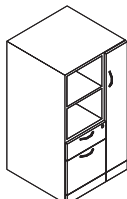

Tip: Specify a left-hand (hinged left) unit if the user is sitting to the right of the unit and a right-hand (hinged right) unit if the user is sitting to the left of the unit.

Open Side Bookshelf on Left with Door Hinged Right, Wardrobe Right

Two Adjustable Shelves, One Box and Two File Drawers on Bottom

24"	24"	65 ⁵ / ₈ "	E6TW242465N	\$3237	\$2632	\$2935	+\$364	+\$1272	+\$47	+\$164
-----	-----	----------------------------------	--------------------	--------	--------	--------	--------	---------	-------	--------

Plinth Base Towers with
Open Shelves and Drawers

SIN 711.2

Plinth Base Vertical Cabinets

Wood Veneer or Laminate

SIN 711.2

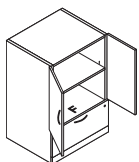

Standard Includes	Required to Specify
-------------------	---------------------

- Vertical cabinet:
 - Wood group 1 case with wood group 1 front
 - Laminate price group 1 case with same or contrasting laminate front
 - Laminate price group 1 case with wood group 1 front
- Shelves: wood or laminate to match case
- Finished inset back on 45"H, 65⁵/₈"H, and 72¹/₂"H vertical cabinets
- Unfinished inset back on 77¹/₂"H vertical cabinets
- Dovetail drawer construction
- Brackets for adjustable shelves: black only
- One fastened metal filing system per file drawer: black only
- Lock, keyed random
- Standard close drawers

- 1 Style number
 - 2 Wood or laminate color number for vertical cabinet
 - 3 Laminate color number for laminate fronts on laminate case, if selected
 - 4 Wood color number for wood fronts on laminate cases, if selected
 - 5 Pull shape (see below under Required Selections)
 - 6 Finish color number for pull
 - 7 Finish color number for lock
 - 8 Options, if selected (see below)
- ▶ See *Surface Materials*, page 566.

Required Selection

Pull Shape

Contemporary	Jazz	Bar	Nile	Integral*	Transitional	Inset	Beam
No cost	+\$19 each	+\$26 each	+\$26 each	+\$26 each	+\$26 each	+\$26 each	+\$37 each

*Not available on laminate or composite fronts.

Options	Price	Required to Specify
---------	-------	---------------------

Surface Materials	Wood tower case	Prices at right Prices at right No cost	Specify wood color number. Specify wood color number. Specify <i>with Customiz stain</i> .
	Laminate tower case	See information at left +\$ 69 plus cost of laminate Prices at right Prices at right No cost	Specify laminate color number. ▶ See <i>Surface Materials Reference Manual</i> . Specify wood color number. Specify wood color number. Specify <i>with Customiz stain</i> .
Lock and Keying	Lock	No cost No cost	Specify <i>with 9250 Ember Chrome lock</i> . Specify <i>with 9201 Polished Chrome lock</i> .
	Keying	Factory- and field-installed keying units	▶ Page 622
Shelves	• 3/4" shelf • Metal shelf	No cost –\$ 26 per shelf	Specify <i>with 3/4" shelf</i> . Specify <i>with metal shelves</i> and select paint color number.
Painted Glass Doors for Vertical Cabinets	Non-locking glass doors	• On 45"H wood vertical cabinets +\$628 • On 65 ⁵ / ₈ "H wood vertical cabinets +\$700 • On 72 ¹ / ₂ "H wood vertical cabinets +\$738 • On 77 ¹ / ₂ "H wood vertical cabinets +\$774	Specify <i>with glass doors</i> and select finish. Specify <i>with glass doors</i> and select finish. Specify <i>with glass doors</i> and select finish. Specify <i>with glass doors</i> and select finish.
	Frame	• Painted metal frame for glass doors No cost	Specify <i>with frame</i> and select paint color number.

▶ Options, continued on next page

For laminate price group 2 pricing, please refer to the electronic catalog or SmartTools.

Tip: Locks are not available on doors with integral pulls.

Tip: When integral pull is specified with a 9250 Ember Chrome lock, the lock housing is black. When 9201 Polished Chrome lock is specified, the lock housing is nickel.

Tip: Doors open from the center out (one door hinged right, one door hinged left).

Tip: Glass doors have a magnetic touch latch. They do not have pulls.

Tip: Double-door units with integral or beam pulls will have a single pull on the right-hand door.

SIN 711.2

► Options, continued from previous page

Options	Price	Required to Specify
Mirrored Glass Door(s) for Vertical Cabinets	Non-locking glass door • On 45"H wood vertical cabinets	+\$ 880 Specify with <i>mirrored glass door</i> and select finish.
	• On 65 ⁵ / ₈ "H wood vertical cabinets	+\$ 970 Specify with <i>mirrored glass door</i> and select finish.
	• On 72 ¹ / ₂ "H wood vertical cabinets	+\$1032 Specify with <i>mirrored glass door</i> and select finish.
	• On 77 ¹ / ₂ "H wood vertical cabinets	+\$1086 Specify with <i>mirrored glass door</i> and select finish.
Frame • Painted metal frame for glass doors	No cost	Specify with <i>frame</i> and select paint color number.
Miter Fold Drawer	• For one drawer	-\$ 53
	• For two drawers	-\$ 106
	• For four drawers	-\$ 212
Related Products	• Single-high overhead cabinets	► Pages 484–490
	• Double-high overhead cabinets	► Page 494
	• Organizer, open, and accessory shelves	► Page 504
	• Suspension hardware kit	► Page 522

Tip: Organizer and open shelves and overhead cabinets can be suspended between 65⁵/₈"H, 72¹/₂"H, and 77¹/₂"H towers. Specify suspension hardware kit separately.

Specification Information

Dimensions			Style Number	Base Prices			Options					
D	W	H		Wood Case	Laminate Price Group 1	Wood Case	(Add \$ to Base Price)					
				Wood Group 1 Front	Laminate Price Group 1 Front	Wood Group 1 Front	Wood Case with Wood Front	Wood Group 2	Wood Group 3	Laminate Case with Wood Front	Wood Group 2	Wood Group 3

Plinth Base Vertical Cabinets

45"H Vertical Cabinets

Hinged Doors with One Adjustable Shelf and One 12"H Drawer

24"	30"	45"	E6KV243045A	\$3864	\$2775	\$3501	+\$364	+\$1272	+\$47	+\$164

65⁵/₈"H Vertical Cabinets

Hinged Doors with Two Adjustable Shelves and Two 12"H Drawers

24"	30"	65 ⁵ / ₈ "	E6KV243065B	\$4372	\$3283	\$4009	+\$511	+\$1787	+\$69	+\$242

Hinged Doors and Four 12"H Drawers

24"	30"	65 ⁵ / ₈ "	E6KV243065D	\$5422	\$4333	\$5059	+\$511	+\$1786	+\$96	+\$335

► Specification Information, continued on next page

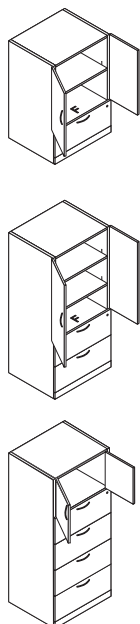

Elective Elements

Plinth Base Vertical Cabinets, Wood Veneer or Laminate, continued

SIN 711.2

► Specification Information, continued from previous page

Specification Information														
Dimensions			Style Number	Base Prices			Options							
D	W	H		Wood Group 1 Case	Laminate Price Group 1 Case	Wood Group 1 Front	(Add \$ to Base Price)							
							Wood Case with Wood Front	Wood	Wood	Wood	Wood	Laminate Case with Wood Front	Wood	Wood
							Group 2	Group 3	Group 2	Group 3	Group 2	Group 3	Group 2	Group 3

Plinth Base Vertical Cabinets, continued

72½"H Vertical Cabinets

Hinged Doors with Three Adjustable Shelves and Two 12"H Drawers

24"	30"	72½"	E6KV243072B	\$4480	\$3391	\$4117	+\$511	+\$1786	+\$96	+\$335
:	:	:	:	:	:	:	:	:	:	:

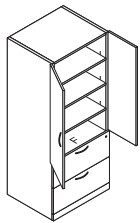

77½"H Vertical Cabinets

Hinged Doors with Three Adjustable Shelves and Two 12"H Drawers

24"	30"	77½"	E6KV243077B	\$4588	\$3499	\$4225	+\$511	+\$1786	+\$96	+\$335
:	:	:	:	:	:	:	:	:	:	:

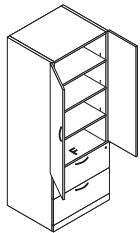

Plinth Base
Vertical Cabinets

SIN 711.2

Plinth Base Wardrobes

Wood Veneer or Laminate

SIN 711.2

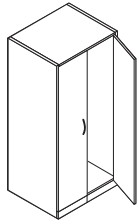

Standard Includes	Required to Specify
<ul style="list-style-type: none"> • Wardrobes: <ul style="list-style-type: none"> –Wood group 1 case with wood group 1 front –Laminate price group 1 case with laminate front –Laminate price group 1 case with wood group 1 front • Finished inset back on 45"H, 55¼"H, 65⅝"H, and 72⅝"H wardrobes • Unfinished inset back on 77½"H wardrobes • Full coat rod on 65⅝"H, 72⅝"H, and 77½"H (wider than 12"W) wardrobes only • Two hooks on 45"H and 55¼"H wardrobes • Lock, keyed random 	<ol style="list-style-type: none"> 1 Style number 2 Wood or laminate color number for wardrobe 3 Wood color number for wood fronts on laminate cases, if selected 4 Pull shape (see below under Required Selections) 5 Finish color number for pull 6 Finish color number for lock 7 Options, if selected (see below) <p>▶ See <i>Surface Materials</i>, page 566.</p>

Required Selection

Pull Shape

Contemporary	Jazz	Bar	Nile	Integral*	Transitional	Inset	Beam
No cost	+\$19 each	+\$26 each	+\$26 each	+\$26 each	+\$26 each	+\$26 each	+\$37 each

*Not available on laminate or composite fronts.

Options

Options	Price	Required to Specify
<p>Surface Materials</p> <p>Wood wardrobe case</p> <ul style="list-style-type: none"> • Wood group 2 • Wood group 3 • Customiz stain 	<p>Prices at right</p> <p>Prices at right</p> <p>No cost</p>	<p>Specify wood color number.</p> <p>Specify wood color number.</p> <p>Specify <i>with Customiz stain</i>.</p>
<p>Laminate wardrobe case</p> <ul style="list-style-type: none"> • Laminate price group 2 • Open Line laminate <p>• Wood group 2 on wood fronts</p> <p>• Wood group 3 on wood fronts</p> <p>• Customiz stain</p>	<p>See information at left</p> <p>+\$ 69 plus cost of laminate</p> <p>Prices at right</p> <p>Prices at right</p> <p>No cost</p>	<p>Specify laminate color number.</p> <p>▶ See <i>Surface Materials Reference Manual</i>.</p> <p>Specify wood color number.</p> <p>Specify wood color number.</p> <p>Specify <i>with Customiz stain</i>.</p>
<p>Lock and Keying</p> <p>Lock</p> <ul style="list-style-type: none"> • Ember Chrome • Polished Chrome <p>Keying</p> <ul style="list-style-type: none"> • Factory- and field-installed keying units 	<p>No cost</p> <p>No cost</p>	<p>Specify <i>with 9250 Ember Chrome lock</i>.</p> <p>Specify <i>with 9201 Polished Chrome lock</i>.</p> <p>▶ Page 622</p>
<p>Painted Glass Door(s) for Wardrobes</p> <p>Non-locking glass doors on 45"H wardrobes</p> <ul style="list-style-type: none"> • 12"W +\$ 350 <p>Non-locking glass doors on 55¼"H wardrobes</p> <ul style="list-style-type: none"> • 12"W +\$ 387 <p>Non-locking glass doors on 65⅝"H wardrobes</p> <ul style="list-style-type: none"> • 12"W +\$ 412 • 15½"W +\$ 436 • 30"W +\$ 869 <p>Non-locking glass doors on 72⅝"H wardrobes</p> <ul style="list-style-type: none"> • 12"W +\$ 431 • 15½"W +\$ 473 • 30"W +\$ 944 <p>Non-locking glass doors on 77½"H wardrobes</p> <ul style="list-style-type: none"> • 12"W +\$ 448 • 15½"W +\$ 508 • 30"W +\$1016 <p>Frame</p> <ul style="list-style-type: none"> • Painted metal frame for glass doors 	<p>No cost</p>	<p>Specify <i>with glass doors</i> and select finish.</p> <p>Specify <i>with glass doors</i> and select finish.</p> <p>Specify <i>with glass doors</i> and select finish.</p> <p>Specify <i>with glass doors</i> and select finish.</p> <p>Specify <i>with glass doors</i> and select finish.</p> <p>Specify <i>with glass doors</i> and select finish.</p> <p>Specify <i>with glass doors</i> and select finish.</p> <p>Specify <i>with frame</i> and select paint color number.</p>

▶ Options, continued on next page

For laminate price group 2 pricing, please refer to the electronic catalog or SmartTools.

Tip: Locks are not available on doors with integral pulls.

Tip: Doors open from the center out (one door hinged right, one door hinged left).

Tip: Glass doors have a magnetic touch latch. They do not have pulls.

Tip: Double-door units with integral or beam pulls will have a single pull on the right-hand door.

SIN 711.2

► Options, continued from previous page

Options	Price	Required to Specify	
Mirrored Glass Door(s) for Wardrobes	Non-locking glass doors on 45"H wardrobes		
	• 12"W	+\$ 488	Specify with mirrored glass doors and select finish.
	Non-locking glass doors on 55 1/4"H wardrobes		
	• 12"W	+\$ 543	Specify with mirrored glass doors and select finish.
	Non-locking glass doors on 65 5/8"H wardrobes		
	• 12"W	+\$ 609	Specify with mirrored glass doors and select finish.
	• 15 1/2"W	+\$ 609	Specify with mirrored glass doors and select finish.
	• 30"W	+\$1218	Specify with mirrored glass doors and select finish.
	Non-locking glass doors on 72 5/8"H wardrobes		
	• 12"W	+\$ 602	Specify with mirrored glass doors and select finish.
	• 15 1/2"W	+\$ 661	Specify with mirrored glass doors and select finish.
	• 30"W	+\$1322	Specify with mirrored glass doors and select finish.
	Non-locking glass doors on 77 1/2"H wardrobes		
	• 12"W	+\$ 627	Specify with mirrored glass doors and select finish.
	• 15 1/2"W	+\$ 712	Specify with mirrored glass doors and select finish.
• 30"W	+\$1424	Specify with mirrored glass doors and select finish.	
Frame			
• Painted metal frame for glass doors	No cost	Specify with frame and select paint color number.	

Related Products		
• Single-high overhead cabinets		► Pages 484–490
• Double-high overhead cabinets		► Page 494
• Organizer, open, and accessory shelves		► Page 504
• Suspension hardware kit		► Page 522

Tip: Organizer and open shelves and overhead cabinets can be suspended between 65 5/8"H, 72 5/8"H, and 77 1/2"H wardrobes. Specify suspension hardware kit separately.

Specification Information										
Dimensions			Style Number	Base Prices			Options			
D	W	H		Wood Group 1 Case	Laminate Price Group 1 Case	Wood Group 1 Front	Wood			
							Wood Case with	Wood	Wood	
							Wood Front	Group 2	Group 3	
							Laminate Case with Wood Front	Wood	Wood	
								Group 2	Group 3	

Elective Elements

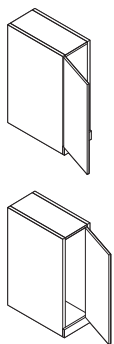

Tip: 12"W personal wardrobes must attach to an adjacent end panel or storage unit for proper stability.

Plinth Base Wardrobes

45"H Wardrobes

Door Hinged Left-Hand

Dimensions	Style Number	Wood Case	Laminate Case	Wood Front	Options
18" 12" 45"	E6KW181245L	\$1426	\$581	\$1063	+\$291 +\$1015 +\$47 +\$164
24" 12" 45"	E6KW241245L	\$1771	\$926	\$1408	+\$291 +\$1015 +\$47 +\$164

Door Hinged Right-Hand

Dimensions	Style Number	Wood Case	Laminate Case	Wood Front	Options
18" 12" 45"	E6KW181245R	\$1426	\$581	\$1063	+\$291 +\$1015 +\$47 +\$164
24" 12" 45"	E6KW241245R	\$1771	\$926	\$1408	+\$291 +\$1015 +\$47 +\$164

► Specification Information, continued on next page

Plinth Base Wardrobes, Wood Veneer or Laminate, continued

SIN 711.2

► Specification Information, continued from previous page

Specification Information														
Dimensions			Style Number	Base Prices			Options (Add \$ to Base Price)							
D	W	H		Wood Group 1 Case	Laminate Price Group 1 Case	Wood Group 1 Front	Wood	Wood	Wood	Wood	Wood			
							Wood Case with Wood Front	Wood	Wood	Laminate Case with Wood Front	Wood	Wood	Wood	Wood
								Group 2	Group 3	Group 2	Group 3	Group 2	Group 3	Group 3

Plinth Base Wardrobes

55"H Wardrobes

Door Hinged Left-Hand

18"	12"	55¼"	E6KW181255L	\$1580	\$ 735	\$1217	+\$291	+\$1015	+\$47	+\$164
24"	12"	55¼"	E6KW241255L	\$1991	\$1146	\$1628	+\$291	+\$1015	+\$47	+\$164

Door Hinged Right-Hand

18"	12"	55¼"	E6KW181255R	\$1580	\$ 735	\$1217	+\$291	+\$1015	+\$47	+\$164
24"	12"	55¼"	E6KW241255R	\$1991	\$1146	\$1628	+\$291	+\$1015	+\$47	+\$164

65⅝"H Wardrobes

Hinged Doors with Full Coat Rod

24"	30"	65⅝"	E6KW243065	\$2981	\$2112	\$2609	+\$511	+\$1787	+\$69	+\$242
-----	-----	------	-------------------	--------	--------	--------	--------	---------	-------	--------

Door Hinged Left-Hand

18"	12"	65⅝"	E6KW181265L	\$1734	\$ 889	\$1371	+\$291	+\$1015	+\$47	+\$164
24"	12"	65⅝"	E6KW241265L	\$2210	\$1365	\$1847	+\$291	+\$1015	+\$47	+\$164
24"	15½"	65⅝"	E6KW241565L	\$2228	\$1383	\$1865	+\$313	+\$1093	+\$69	+\$242

Door Hinged Right-Hand

18"	12"	65⅝"	E6KW181265R	\$1734	\$ 889	\$1371	+\$291	+\$1015	+\$47	+\$164
24"	12"	65⅝"	E6KW241265R	\$2210	\$1365	\$1847	+\$291	+\$1015	+\$47	+\$164
24"	15½"	65⅝"	E6KW241565R	\$2228	\$1383	\$1865	+\$313	+\$1093	+\$69	+\$242

► Specification Information, continued on next page

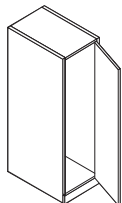
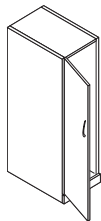
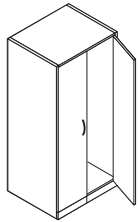
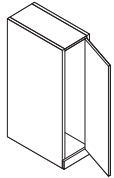
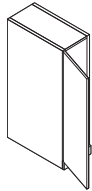

► Specification Information, continued from previous page

Specification Information											
Dimensions			Style Number	Base Prices			Options (Add \$ to Base Price)				
D	W	H		Wood Group 1 Case	Laminate Price Group 1 Case	Wood Group 1 Front	Wood Case with Wood Front	Wood Group 2	Wood Group 3	Laminate Case with Wood Front	Wood Group 2

Plinth Base Wardrobes

72⁵/₈"H Wardrobes

Hinged Doors with Full Coat Rod

24"	30"	72 ⁵ / ₈ "	E6KW243072	\$3050	\$2181	\$2678	+\$511	+\$1786	+\$96	+\$335
-----	-----	----------------------------------	-------------------	--------	--------	--------	--------	---------	-------	--------

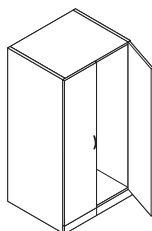

Door Hinged Left-Hand

18"	12"	72 ⁵ / ₈ "	E6KW181272L	\$1810	\$ 965	\$1447	+\$291	+\$1015	+\$47	+\$164
24"	12"	72 ⁵ / ₈ "	E6KW241272L	\$2266	\$1421	\$1903	+\$291	+\$1015	+\$47	+\$164
24"	15 ¹ / ₂ "	72 ⁵ / ₈ "	E6KW241572L	\$2284	\$1439	\$1921	+\$313	+\$1093	+\$69	+\$242

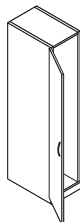

Door Hinged Right-Hand

18"	12"	72 ⁵ / ₈ "	E6KW181272R	\$1810	\$ 965	\$1447	+\$291	+\$1015	+\$47	+\$164
24"	12"	72 ⁵ / ₈ "	E6KW241272R	\$2266	\$1421	\$1903	+\$291	+\$1015	+\$47	+\$164
24"	15 ¹ / ₂ "	72 ⁵ / ₈ "	E6KW241572R	\$2284	\$1439	\$1921	+\$313	+\$1093	+\$69	+\$242

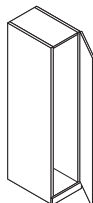

► Specification Information, continued on next page

Elective Elements

Plinth Base Wardrobes, Wood Veneer or Laminate, continued

SIN 711.2

► Specification Information, continued from previous page

Specification Information										
Dimensions			Style Number	Base Prices			Options (Add \$ to Base Price)			
D	W	H		Wood Group 1 Case	Laminate Price Group 1 Case	Wood Group 1 Front	Wood	Wood	Wood	Wood
							Wood Case with Wood Front	Wood	Wood	Laminate Case with Wood Front
							Wood Group 2	Wood Group 3	Wood Group 2	Wood Group 3

Plinth Base Wardrobes

77½"H Wardrobes

Hinged Doors with Full Coat Rod and One Fixed Shelf

24"	30"	77½"	E6KW243077	\$3119	\$2250	\$2747	+\$511	+\$1786	+\$96	+\$335
-----	-----	------	-------------------	--------	--------	--------	--------	---------	-------	--------

Door Hinged Left-Hand with One Fixed Shelf

18"	12"	77½"	E6KW181277L	\$1888	\$1043	\$1525	+\$291	+\$1015	+\$47	+\$164
24"	12"	77½"	E6KW241277L	\$2322	\$1477	\$1959	+\$291	+\$1015	+\$47	+\$164
24"	15½"	77½"	E6KW241577L	\$2340	\$1495	\$1977	+\$313	+\$1093	+\$69	+\$242

Door Hinged Right-Hand with One Fixed Shelf

18"	12"	77½"	E6KW181277R	\$1888	\$1043	\$1525	+\$291	+\$1015	+\$47	+\$164
24"	12"	77½"	E6KW241277R	\$2322	\$1477	\$1959	+\$291	+\$1015	+\$47	+\$164
24"	15½"	77½"	E6KW241577R	\$2340	\$1495	\$1977	+\$313	+\$1093	+\$69	+\$242

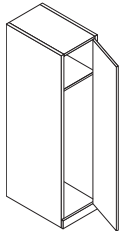
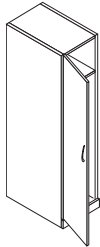
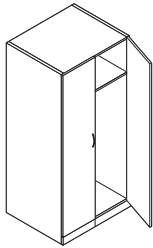

Specifying Leg Base Storage

Leg Base Storage and Lateral Files

Leg Base 21½"H Storage (SIN 711.2)	348
Leg Base 27½"H Storage (SIN 711.2)	
18"D Storage (SIN 711.2)	350
24"D Storage (SIN 711.2)	352
Cable Access Cover (SIN 711.2)	355
High Pedestals (SIN 711.2)	356
Lateral Files—Freestanding 3-High (SIN 711.2)	358

Leg Base Return Credenzas **360**

Leg Base 21½"H Credenzas

60"W Credenzas (SIN 711.2)	364
66"W Credenzas (SIN 711.2)	366
72"W Credenzas (SIN 711.2)	368
90"W Credenzas (SIN 711.2)	370
96"W Credenzas (SIN 711.2)	372

Leg Base 27½"H Credenzas

18"D Credenzas

60"W Credenzas (SIN 711.2)	374
72"W Credenzas (SIN 711.2)	376
90"W Credenzas (SIN 711.2)	378
96"W Credenzas (SIN 711.2)	380

24"D Credenzas

45"W Credenzas (SIN 711.2)	382
48"W Credenzas (SIN 711.2)	384
54"W Credenzas (SIN 711.2)	386
60"W Credenzas (SIN 711.2)	388
66"W Credenzas (SIN 711.2)	392
72"W Credenzas (SIN 711.2)	398
78"W Credenzas (SIN 711.2)	402
84"W Credenzas (SIN 711.2)	406
90"W Credenzas (SIN 711.2)	412
96"W Credenzas (SIN 711.2)	420
102"W Credenzas (SIN 711.2)	434
108"W Credenzas (SIN 711.2)	446
Kneewells (SIN 711.2)	454

Leg Base Bookcases

Freestanding Bookcases—Open (SIN 711.2)	456
Freestanding Bookcases with Doors (SIN 711.2)	458
Stacking Bookcases—Open (SIN 711.2)	460
Stacking Bookcases with Doors (SIN 711.2)	462
Finished Back Panels for Stacking Bookcases (SIN 711.2)	466

Leg Base Towers and Wardrobes

Towers with Full-Height Doors (SIN 711.2)	468
Towers with Doors and Drawers (SIN 711.2)	472
Towers with Open Shelves and Drawers (SIN 711.2)	476
Wardrobes (SIN 711.2)	480

Leg Base 21½"H Storage

Wood Veneer or Laminate

SIN 711.2

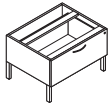

Tip: When ordering single 21½"H storage units through SmartTools, see leg base credenzas.

Tip: When storage legs are shared between two units, the extra legs should be saved for later use, such as reconfiguration.

Standard Includes	Required to Specify
-------------------	---------------------

- | | |
|--|--|
| <ul style="list-style-type: none"> Underworksurface storage: <ul style="list-style-type: none"> – Wood group 1 case with wood group 1 front – Laminate price group 1 case with same or contrasting laminate front – Laminate price group 1 case with wood group 1 front Unfinished, inset back panel spanning full credenza Unfinished open top Storage leg; paint or metal Dovetail drawer construction Lock, keyed random Counterweight package Standard close drawers | <ol style="list-style-type: none"> Style number Wood or laminate color number for underworksurface storage Pull shape (see below under Required Selections) Paint or metal color number for storage leg Finish color number for pull Finish color number for lock Options, if selected (see below) <p>▶ See <i>Surface Materials</i>, page 566.</p> |
|--|--|

Required Selections

Pull Shape							
Contemporary	Jazz	Bar	Nile	Integral*	Transitional	Inset	Beam
No cost	+\$19 each	+\$26 each	+\$26 each	+\$26 each	+\$26 each	+\$26 each	+\$37 each

*Not available on laminate or composite fronts.

Options	Price	Required to Specify
---------	-------	---------------------

Surface Materials	Wood underworksurface storage case	<ul style="list-style-type: none"> Wood group 2 Wood group 3 Customiz stain 	Prices at right Prices at right No cost	Specify wood color number. Specify wood color number. Specify with <i>Customiz stain</i> .
	Laminate underworksurface storage case	<ul style="list-style-type: none"> Laminate price group 2 Open Line laminate Wood group 2 on wood fronts Wood group 3 on wood fronts Customiz stain 	See information at left +\$ 69 plus cost of laminate Prices at right Prices at right No cost	Specify laminate color number. ▶ See <i>Surface Materials Reference Manual</i> . Specify wood color number. Specify wood color number. Specify with <i>Customiz stain</i> .
Lock and Keying	Lock	<ul style="list-style-type: none"> Ember chrome Polished chrome 	No cost No cost	Specify with <i>9250 Ember Chrome lock</i> . Specify with <i>9201 Polished Chrome lock</i> .
	Keying	<ul style="list-style-type: none"> Factory- and field-installed keying units 		▶ Page 622
Counterweight Package	<ul style="list-style-type: none"> Counterweight package Omit counterweight package 	No cost –\$ 65 each		Specify with <i>counterweight package</i> . Specify with <i>no counterweight package</i> .
Back Panel	<ul style="list-style-type: none"> Unfinished full length back panel 	No cost		Specify with <i>unfinished back panel</i> .
	<ul style="list-style-type: none"> Laminate full length back panel 			Specify with <i>laminate finished back panel</i> .
	<ul style="list-style-type: none"> – 30"W Laminate back panel – 36"W Laminate back panel 	+\$ 78 +\$ 93		
	<ul style="list-style-type: none"> Wood full length back panel 			Specify with <i>wood finished back panel</i> .
	<ul style="list-style-type: none"> – 30"W Wood back panel – 36"W Wood back panel 	+\$156 +\$187		

Tip: Back panel is inset and spans entire width of credenza.

Specification Information

Dimension			Style Number	Counter-weight Package	Base Prices			Options (Add \$ to Base Price)			
D	W	H			Wood Group 1 Case	Laminate Price Group 1 Case	Wood Group 1 Front or Open Front	Wood Case with Wood Front	Wood Group 2	Wood Group 3	Laminate Case with Wood Front

Leg Base 21 1/2"H Storage

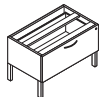

18"D File

18"	30"	21 1/2"	E6C1830M	1	\$2012	\$1406	\$1762	+\$87	+\$305	+\$28	+\$94
18"	36"	21 1/2"	E6C1836P	1	\$2207	\$1601	\$1957	+\$87	+\$305	+\$28	+\$94

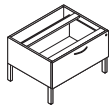

24"D File

24"	30"	21 1/2"	E6C2430N	1	\$2100	\$1494	\$1850	+\$87	+\$305	+\$28	+\$94
24"	36"	21 1/2"	E6C2436Q	1	\$2317	\$1711	\$2067	+\$87	+\$305	+\$28	+\$94

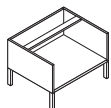

23 1/16"D Open

23 1/16"	30"	21 1/2"	E6C2330O	N.A.	\$1846	N.A.	\$1490	+\$69	+\$242	N.A.	N.A.
23 1/16"	36"	21 1/2"	E6C2336R	N.A.	\$2012	N.A.	\$1656	+\$69	+\$242	N.A.	N.A.

Tip: Storage with open components have a 23 in the depth location of the style number instead of a 24 due to the dimensional change with the lack of a headset.

18"D Leg Base 27½"H Storage

Wood Veneer or Laminate

SIN 711.2

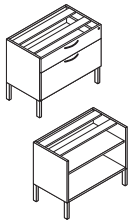

Tip: When ordering single 27½"H storage units through SmartTools, see leg base credenzas.

Tip: When storage legs are shared between two units, the extra legs should be saved for later use, such as reconfiguration.

Standard Includes	Required to Specify
<ul style="list-style-type: none"> Underworksurface storage: <ul style="list-style-type: none"> – Wood group 1 case with wood group 1 front – Laminate price group 1 case with same or contrasting laminate front – Laminate price group 1 case with wood group 1 front Unfinished, inset back panel spanning full credenza Unfinished open top Storage leg: paint or metal Dovetail drawer construction Lock, keyed random Counterweight package Standard close drawers 	<ol style="list-style-type: none"> Style number Wood or laminate color number for underworksurface storage Pull shape (see below under Required Selections) Paint or metal color number for storage leg Finish color number for pull Finish color number for lock Options, if selected (see below) <p>▶ See <i>Surface Materials</i>, page 566.</p>

Required Selections							
Pull Shape							
Contemporary	Jazz	Bar	Nile	Integral*	Transitional	Inset	Beam
No cost	+\$19 each	+\$26 each	+\$26 each	+\$26 each	+\$26 each	+\$26 each	+\$37 each

*Not available on laminate or composite fronts.

Options	Price	Required to Specify
Surface Materials <ul style="list-style-type: none"> Wood group 2 Wood group 3 Customiz stain 	Wood underworksurface storage case <ul style="list-style-type: none"> Prices at right Prices at right No cost 	<ul style="list-style-type: none"> Specify wood color number. Specify wood color number. Specify <i>with Customiz stain</i>.
For laminate price group 2 pricing, please refer to the electronic catalog or SmartTools.	Laminate underworksurface storage case <ul style="list-style-type: none"> Laminate price group 2 Open Line laminate Wood group 2 on wood fronts Wood group 3 on wood fronts Customiz stain 	<ul style="list-style-type: none"> See information at left +\$ 69 plus cost of laminate Prices at right Prices at right No cost <ul style="list-style-type: none"> Specify laminate color number. ▶ See <i>Surface Materials Reference Manual</i>. Specify wood color number. Specify wood color number. Specify <i>with Customiz stain</i>.
Lock and Keying <ul style="list-style-type: none"> Ember chrome Polished chrome 	Lock <ul style="list-style-type: none"> No cost No cost 	<ul style="list-style-type: none"> Specify <i>with 9250 Ember Chrome lock</i>. Specify <i>with 9201 Polished Chrome lock</i>.
	Keying <ul style="list-style-type: none"> Factory- and field-installed keying units 	<ul style="list-style-type: none"> ▶ Page 622
Shelves <ul style="list-style-type: none"> ¾" shelf Metal shelf 	<ul style="list-style-type: none"> No cost –\$ 26 per shelf 	<ul style="list-style-type: none"> Specify <i>with ¾" shelf</i>. Specify <i>with metal shelf</i> and select paint color number.
Counterweight Package <ul style="list-style-type: none"> Counterweight package Omit counterweight package 	<ul style="list-style-type: none"> No cost –\$ 65 each 	<ul style="list-style-type: none"> Specify <i>with counterweight package</i>. Specify <i>with no counterweight package</i>.
Back Panel <ul style="list-style-type: none"> Unfinished full length back panel Laminate full length back panel <ul style="list-style-type: none"> – 30"W Laminate back panel – 36"W Laminate back panel Wood full length back panel <ul style="list-style-type: none"> – 30"W Wood back panel – 36"W Wood back panel 	<ul style="list-style-type: none"> No cost +\$ 78 +\$ 93 +\$156 +\$187 	<ul style="list-style-type: none"> Specify <i>with unfinished back panel</i>. Specify <i>with laminate finished back panel</i>. Specify <i>with wood finished back panel</i>.
Technology Trough <ul style="list-style-type: none"> Technology trough for power and data routing: black 	<ul style="list-style-type: none"> +\$ 57 each 	<ul style="list-style-type: none"> Specify <i>with technology trough</i>.

▶ Options, continued on next page

Tip: Metal shelves only available in open or hinged door components.

Tip: Back panel is inset and spans entire width of credenza.

Tip: Technology trough is only available in open/file for 18"D.

► Options, continued from previous page

Options	Price	Required to Specify
Cut-Out		
• Right side only	No cost	Specify with <i>right cut-out</i> .
• Left side only	No cost	Specify with <i>left cut-out</i> .
• Both sides	No cost	Specify with <i>both cut-outs</i> .
• No cut-outs	No cost	Specify with <i>no cut-outs</i> .

Specification Information												
Dimension			Style Number	Number Of Tech Troughs	Counter-weight Package	Base Prices			Options			
D	W	H				Wood Group 1 Case	Laminate Price Group 1 Case	Wood Group 1 Front	Laminate Price Group 1 Front	Wood Group 1 Front or Open Front	Wood Case with Wood Front	Laminate Case with Wood Front

Leg Base 27 1/2"H Storage

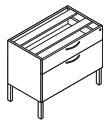

Box/Lateral File

18"	30"	27 1/2"	E6C1830C	N.A.	2	\$2373	\$1674	\$2030	+\$87	+\$305	+\$28	+\$94
18"	36"	27 1/2"	E6C1836K	N.A.	2	\$2848	\$2149	\$2505	+\$87	+\$305	+\$28	+\$94

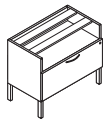

Open/Lateral File

18"	30"	27 1/2"	E6C1830U	1	2	\$2107	\$1408	\$1764	+\$117	+\$406	+\$28	+\$94
18"	36"	27 1/2"	E6C1836V	1	2	\$2420	\$1721	\$2077	+\$117	+\$406	+\$28	+\$94

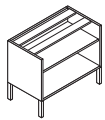

Open

18"	30"	27 1/2"	E6C1830F	N.A.	N.A.	\$1843	N.A.	\$1487	+\$69	+\$242	N.A.	N.A.
18"	36"	27 1/2"	E6C1836S	N.A.	N.A.	\$1992	N.A.	\$1636	+\$69	+\$242	N.A.	N.A.

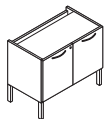

Tip: If inset pull is selected, the pulls are on the door seam vertically.

Hinged Doors

18"	30"	27 1/2"	E6C1830H	N.A.	N.A.	\$2319	\$1637	\$1976	+\$87	+\$305	+\$28	+\$94
18"	36"	27 1/2"	E6C1836T	N.A.	N.A.	\$2437	\$1755	\$2094	+\$87	+\$305	+\$28	+\$94

24"D Leg Base 27½"H Storage

Wood Veneer or Laminate

SIN 711.2

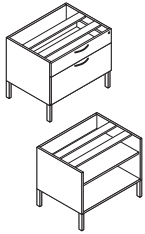

Tip: When ordering single 27½"H storage units through SmartTools, see leg base credenzas.

Tip: When storage legs are shared between two units, the extra legs should be saved for later use, such as reconfiguration.

For laminate price group 2 pricing, please refer to the electronic catalog or SmartTools.

Tip: Soft close drawer slides only apply to storage that has 15"W and 18"W drawers.

Tip: Soft close slides are available for both dovetail and miter fold construction.

Tip: Metal shelves only available in open or hinged door components.

Tip: Back panel is inset and spans entire width of credenza.

Standard Includes	Required to Specify
-------------------	---------------------

- Underworksurface storage:
 - Wood group 1 case with wood group 1 front
 - Laminate price group 1 case with same or contrasting laminate front
 - Laminate price group 1 case with wood group 1 front
- Unfinished, inset back panel spanning full credenza
- Unfinished open top
- Storage leg: paint or metal
- Dovetail drawer construction
- Lock, keyed random
- Counterweight package
- Standard close drawer slides

- 1 Style number
 - 2 Wood or laminate color number for underworksurface storage
 - 3 Pull shape (see below under Required Selections)
 - 4 Paint or metal color number for storage leg
 - 5 Finish color number for pull
 - 6 Finish color number for lock
 - 7 Options, if selected (see below)
- ▶ See *Surface Materials*, page 566.

Required Selections

Pull Shape

Contemporary	Jazz	Bar	Nile	Integral*	Transitional	Inset	Beam
No cost	+\$19 each	+\$26 each	+\$26 each	+\$26 each	+\$26 each	+\$26 each	+\$37 each

*Not available on laminate or composite fronts.

Options	Price	Required to Specify
---------	-------	---------------------

Surface Materials	Wood underworksurface storage case	Prices at right	Specify wood color number.
	<ul style="list-style-type: none"> • Wood group 2 • Wood group 3 • Customiz stain 	Prices at right No cost	Specify wood color number. Specify with <i>Customiz stain</i> .
	Laminate underworksurface storage case	See information at left	Specify laminate color number.
	<ul style="list-style-type: none"> • Laminate price group 2 • Open Line laminate • Wood group 2 on wood fronts • Wood group 3 on wood fronts • Customiz stain 	+\$ 69 plus cost of laminate Prices at right Prices at right No cost	▶ See <i>Surface Materials Reference Manual</i> . Specify wood color number. Specify wood color number. Specify with <i>Customiz stain</i> .
Drawer Slide	• Soft close drawer slides	+\$ 30 per drawer	Specify with <i>soft close drawers</i> .
Lock and Keying	Lock	No cost	Specify with <i>9250 Ember Chrome lock</i> .
	<ul style="list-style-type: none"> • Ember chrome • Polished chrome 	No cost	Specify with <i>9201 Polished Chrome lock</i> .
	Keying		▶ Page 622
Shelves	• ¾" shelf	No cost	Specify with <i>¾" shelf</i> .
	• Metal shelf	–\$ 26 per shelf	Specify with <i>metal shelf</i> and select paint color number.
Counterweight Package	<ul style="list-style-type: none"> • Counterweight package • Omit counterweight package 	No cost –\$ 65 each	Specify with <i>counterweight package</i> . Specify with <i>no counterweight package</i> .
Back Panel	• Unfinished full length back panel	No cost	Specify with <i>unfinished back panel</i> .
	• Laminate full length back panel		Specify with <i>laminate finished back panel</i> .
	– 15"W Laminate back panel	+\$ 39	
	– 18"W Laminate back panel	+\$ 47	
	– 30"W Laminate back panel	+\$ 78	
	– 36"W Laminate back panel	+\$ 93	
	• Wood full length back panel		Specify with <i>wood finished back panel</i> .
– 15"W Wood back panel	+\$ 79		
– 18"W Wood back panel	+\$ 93		
– 30"W Wood back panel	+\$156		
– 36"W Wood back panel	+\$187		

▶ Options, continued on next page

► Options, continued from previous page

Tip: Technology trough not available in hinged door components.

Options	Price	Required to Specify
Technology Trough	• Technology trough for power and data routing: black +\$57 each	Specify with technology trough.
Cut-Out	• Right side only • Left side only • Both sides • No cut-outs	No cost No cost No cost No cost
		Specify with right cut-out. Specify with left cut-out. Specify with both cut-outs. Specify with no cut-outs.

Specification Information												
Dimension			Style Number	Number Of Tech Troughs	Counter-weight Package	Base Prices			Options (Add \$ to Base Price)			
D	W	H				Wood Case	Laminate Price Group 1 Case	Wood Group 1 Front	Laminate Price Group 1 Front	Wood Group 1 Front or Open Front	Wood Case with Wood Front	Laminate Case with Wood Front

Leg Base 27 1/2"H Storage



Box/File												
24"	15"	27 1/2"	E6C2415A	1	1	\$1815	\$1342	\$1572	+\$ 71	+\$244	+\$28	+\$ 94
24"	18"	27 1/2"	E6C2418B	1	1	\$1992	\$1519	\$1749	+\$ 71	+\$244	+\$28	+\$ 94

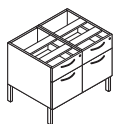

Two - Box/File												
24"	30"	27 1/2"	E6C2430AA	2	2	\$3526	\$2581	\$3041	+\$140	+\$488	+\$54	+\$190
24"	36"	27 1/2"	E6C2436BB	2	2	\$3880	\$2935	\$3395	+\$140	+\$488	+\$54	+\$190

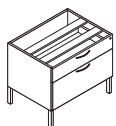

Box/Lateral File												
24"	30"	27 1/2"	E6C2430D	1	2	\$2528	\$1829	\$2185	+\$ 87	+\$305	+\$28	+\$ 94
24"	36"	27 1/2"	E6C2436I	1	2	\$3003	\$2304	\$2660	+\$ 87	+\$305	+\$28	+\$ 94

Tip: Single 15"W or 18"W leg base storage cannot accept technology zone.
If ganged with another unit technology is specifiable, order the suspension/ganging hardware kit separately.

► Specification Information, continued on next page

Elective Elements

24"D Leg Base 27½"H Storage, Wood Veneer or Laminate, continued

SIN 711.2

► **Specification Information, continued from previous page**

Specification Information													
Dimension			Style Number	Number Of Tech Troughs	Counter-weight Package	Base Prices			Options				
D	W	H				Wood Group 1 Case	Laminate Price Group 1 Case	Wood Group 1 Front	Wood Group 1 or Open Front	(Add \$ to Base Price)			
									Wood Case with Wood Front	Wood Case	Laminate Case with Wood Front	Wood Group 2	Wood Group 3

Leg Base 27½"H Storage, continued

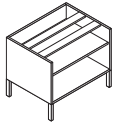

Open

24"	30"	27½"	E6C2430E	1	N.A.	\$2090	N.A.	\$1734	+\$69	+\$242	N.A.	N.A.
24"	36"	27½"	E6C2436J	1	N.A.	\$2243	N.A.	\$1887	+\$69	+\$242	N.A.	N.A.

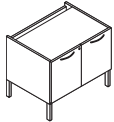

Hinged Doors

24"	30"	27½"	E6C2430G	N.A.	N.A.	\$2399	\$1717	\$2056	+\$87	+\$305	+\$28	+\$94
24"	36"	27½"	E6C2436L	N.A.	N.A.	\$2519	\$1837	\$2176	+\$87	+\$305	+\$28	+\$94

Cable Access Cover

SIN 711.2



Tip: Specify a cable access cover to enclose the unfinished cut-out in a leg base 27 1/2" storage unit when exposed at the end of a run. Side panels with no cut-outs are also available as an option.

Standard Includes	Required to Specify
-------------------	---------------------

- Cable access cover: 8043 Clear Anodized Aluminum or 7278 Dark Bronze

- 1 Style number
- 2 Color number for cover

Specification Information			
• Dimensions		• Style	• Price
D	W	Number	

4 7/8"	5 7/8"	E6AJ45	\$173
--------	--------	---------------	-------

Leg Base High Pedestals

Wood Veneer or Laminate

SIN 711.2



Hinged right shown

Tip: High pedestals are only available with a hinged door.

Tip: When storage legs are shared between two units, the extra legs should be saved for later use, such as reconfiguration.

Standard Includes	Required to Specify
-------------------	---------------------

- High pedestal:
 - Wood group 1 case with wood group 1 front
 - Laminate price group 1 case with same or contrasting laminate front
 - Laminate price group 1 case with wood group 1 front
- Unfinished back
- Unfinished open top
- Storage leg: paint or metal
- Lock, keyed random

- 1 Style number
 - 2 Wood or laminate color number for high pedestal
 - 3 Laminate color number for laminate fronts on laminate case, if selected
 - 4 Wood color number for wood fronts on laminate cases, if selected
 - 5 Pull shape (see below under Required Selections)
 - 6 Finish color number for pull
 - 7 Finish color number for lock
 - 8 Paint or metal color number for storage leg
 - 9 Options, if selected (see below)
- ▶ See *Surface Materials*, page 566.

Required Selections

Pull Shape

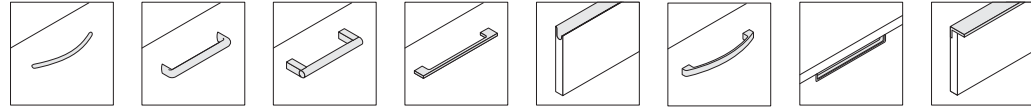

Contemporary	Jazz	Bar	Nile	Integral*	Transitional	Inset	Beam
No cost	+\$19 each	+\$26 each	+\$26 each	+\$26 each	+\$26 each	+\$26 each	+\$37 each

*Not available on laminate or composite fronts.

Options	Price	Required to Specify
---------	-------	---------------------

Surface Materials	Wood high pedestal case	Prices at right Prices at right No cost	Specify wood color number. Specify wood color number. Specify <i>with Customiz stain</i> .
	Laminate high pedestal case	See information at left +\$69 plus cost of laminate Prices at right Prices at right No cost	Specify laminate color number. ▶ See <i>Surface Materials Reference Manual</i> . Specify wood color number. Specify wood color number. Specify <i>with Customiz stain</i> .
Lock and Keying	Lock	No cost No cost	Specify <i>with 9250 Ember Chrome lock</i> . Specify <i>with 9201 Polished Chrome lock</i> .
	Keying		▶ Page 622
Shelves	• 3/4" shelf • Metal shelf	No cost –\$26 per shelf	Specify <i>with 3/4" shelf</i> . Specify <i>with metal shelf</i> and select paint color number.
Related Products	• Back panels for use with high pedestals • Single-high overhead cabinets • Side support frame		▶ Page 262 ▶ Pages 484–490 ▶ Page 522

For laminate price group 2 pricing, please refer to the electronic catalog or SmartTools.

Tip: When integral pull is specified with a 9250 Ember Chrome lock, the lock housing is black. When 9201 Polished Chrome lock is specified, the lock housing is nickel.

Tip: Locks not available on high pedestals with doors specified with integral or beam pulls.

Specification Information

Dimensions			Style Number	Base Prices		Options (Add \$ to Base Price)					
D	W	H		Wood Group 1 Case	Laminate Price Group 1 Case	Wood Group 1 Front		Wood			
						Wood Case with Wood Front	Laminate Case with Wood Front	Wood Group 2	Wood Group 3	Wood Group 2	Wood Group 3

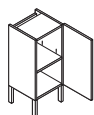

Hinged right shown

Hinged Door with One Adjustable Shelf

Hinged Left

15¾"	15"	35⅞"	E6PHL151535L	\$1986	\$1515	\$1738	+\$71	+\$244	+\$28	+\$94
------	-----	------	---------------------	--------	--------	--------	-------	--------	-------	-------

Hinged Right

15¾"	15"	35⅞"	E6PHL151535R	\$1986	\$1515	\$1738	+\$71	+\$244	+\$28	+\$94
------	-----	------	---------------------	--------	--------	--------	-------	--------	-------	-------

Leg Base Lateral Files—Freestanding 3-High

Wood Veneer or Laminate

SIN 711.2



Tip: When specifying an all laminate case, if the fronts have a contrasting laminate the laminate top will match the case.

Standard Includes	Required to Specify
<ul style="list-style-type: none"> Lateral file: <ul style="list-style-type: none"> – Wood group 1 case with wood group 1 front – Laminate price group 1 case with same or contrasting laminate front – Laminate price group 1 case with wood group 1 front Finished inset top and back panel Storage leg: paint or metal One fastened metal filing system per file drawer: <ul style="list-style-type: none"> black only Lock, keyed random Counterweight package Standard close drawers 	<ol style="list-style-type: none"> Style number Wood or laminate color number for lateral file Laminate color number for laminate fronts on laminate case, if selected Wood color number for wood fronts on laminate cases, if selected Pull shape (see below under Required Selections) Finish color number for pull Finish color number for lock Paint or metal color number for storage leg Options, if selected (see below) <p>▶ See <i>Surface Materials</i>, page 566 .</p>

Required Selections

Pull Shape

Contemporary	Jazz	Bar	Nile	Integral*	Transitional	Inset	Beam
No cost	+\$19 each	+\$26 each	+\$26 each	+\$26 each	+\$26 each	+\$26 each	+\$37 each

*Not available on laminate or composite fronts.

Options	Price	Required to Specify
Surface Materials <ul style="list-style-type: none"> Wood lateral file <ul style="list-style-type: none"> • Wood group 2 • Wood group 3 • Customiz stain Laminate lateral file <ul style="list-style-type: none"> • Laminate price group 2 • Open Line laminate • Wood group 2 on wood fronts • Wood group 3 on wood fronts • Customiz stain 	Prices at right Prices at right No cost See information at left +\$69 plus cost of laminate Prices at right Prices at right No cost	Specify wood color number. Specify wood color number. Specify with <i>Customiz stain</i> . Specify laminate color number. ▶ See <i>Surface Materials Reference Manual</i> . Specify wood color number. Specify wood color number. Specify with <i>Customiz stain</i> .
Lock and Keying <ul style="list-style-type: none"> Lock <ul style="list-style-type: none"> • Ember Chrome • Polished Chrome Keying <ul style="list-style-type: none"> • Factory- and field-installed keying 	No cost No cost	Specify with 9250 <i>Ember Chrome lock</i> . Specify with 9201 <i>Polished Chrome lock</i> . ▶ Page 622

For laminate price group 2 pricing, please refer to the electronic catalog or SmartTools.

Tip: When integral pull is specified with a 9250 Ember Chrome lock, the lock housing is black. When 9201 Polished Chrome lock is specified, the lock housing is nickel.

Specification Information

Dimensions			Style Number	Base Prices			Options (Add \$ to Base Price)				
D	W	H		Wood Group 1 Case	Laminate Price Group 1 Case	Wood Group 1 Front	Laminate Price Group 1 Front	Wood Group 1 Front	Wood Case with Wood Front	Laminate Case with Wood Front	Wood Group 2



24"	30"	45 ³ / ₈ "	E6LFL243045E	\$3483	\$2432	\$3035	+\$242	+\$850	+\$69	+\$242
24"	36"	45 ³ / ₈ "	E6LFL243645E	\$3713	\$2593	\$3226	+\$242	+\$850	+\$69	+\$242

Return Credenzas

Wood Veneer or Laminate

SIN 711.2

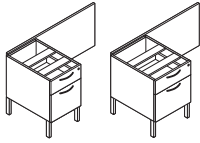

Standard Includes	Required to Specify
<ul style="list-style-type: none"> Return credenzas: <ul style="list-style-type: none"> – Wood group 1 case with wood group 1 front – Laminate price group 1 case with same or contrasting laminate front – Laminate price group 1 case with wood group 1 front Unfinished, inset back panel spanning full credenza 15"W or 18"W box/file pedestal with unfinished open top Storage leg; paint or metal Dovetail drawer construction Lock, keyed random Storage brace Standard close drawer slides 	<ol style="list-style-type: none"> Style number Wood or laminate color number for underworksurface storage Pull shape (see below under Required Selections) Paint or metal color number for storage leg Finish color number for pull Finish color number for lock Options, if selected (see below) <p>▶ See <i>Surface Materials</i>, page 566 .</p>

Required Selections

Pull Shape

Contemporary	Jazz	Bar	Nile	Integral*	Transitional	Inset	Beam
No cost	+\$19 each	+\$26 each	+\$26 each	+\$26 each	+\$26 each	+\$26 each	+\$37 each

*Not available on laminate or composite fronts.

Tip: Back panel spans past integrated pedestal in 42", 48", and 60" widths.

For laminate price group 2 pricing, please refer to the electronic catalog or SmartTools.

Options	Price	Required to Specify
Surface Materials <ul style="list-style-type: none"> Wood underworksurface storage case <ul style="list-style-type: none"> Wood group 2 Wood group 3 Customiz stain Laminate underworksurface storage case <ul style="list-style-type: none"> Laminate price group 2 Open Line laminate Wood group 2 on wood fronts Wood group 3 on wood fronts Customiz stain 	<ul style="list-style-type: none"> Prices at right Prices at right No cost See information at left +\$69 plus cost of laminate Prices at right Prices at right No cost 	<ul style="list-style-type: none"> Specify wood color number. Specify wood color number. Specify <i>with Customiz stain</i>. Specify laminate color number. ▶ See <i>Surface Materials Reference Manual</i>. Specify wood color number. Specify wood color number. Specify <i>with Customiz stain</i>.
Finished Back Panel <ul style="list-style-type: none"> Laminate Wood 	<ul style="list-style-type: none"> Prices at right Prices at right 	<ul style="list-style-type: none"> Specify <i>with finished back panel</i> and select laminate color number. Specify <i>with finished back panel</i> and select wood color number.
Drawer Slide <ul style="list-style-type: none"> Soft close drawer slides 	<ul style="list-style-type: none"> +\$30 per drawer 	<ul style="list-style-type: none"> Specify <i>with soft close drawers</i>.
Lock and Keying <ul style="list-style-type: none"> Lock <ul style="list-style-type: none"> Ember chrome Polished chrome Keying <ul style="list-style-type: none"> Factory- and field-installed keying 	<ul style="list-style-type: none"> No cost No cost 	<ul style="list-style-type: none"> Specify <i>with 9250 Ember Chrome lock</i>. Specify <i>with 9201 Polished Chrome lock</i>. ▶ Page 622
Related Products <ul style="list-style-type: none"> Worksurfaces 		<ul style="list-style-type: none"> ▶ Page 209

Tip: Soft close drawer slides only apply to storage that has 15"W and 18"W drawers.

Tip: Soft close slides are available for both dovetail and miter fold construction.

Specification Information

Dimension			Style Number	Base Prices			Options (Add \$ to Base Price)								
D	W	H		Wood Group 1 Case	Laminate Price Group 1 Case	Wood Group 1 Front	Wood Case with Wood Front	Laminate Case with Wood Front	Wood Group 2	Wood Group 3	Wood Group 2	Wood Group 3	Finished Back Panel		

18"D x 15"W Box/File Pedestal on Legs, Pedestal Left

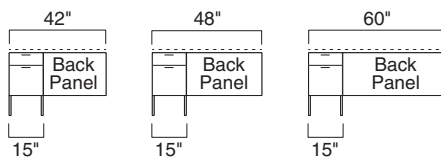

18"	42"	27½"	E6RN184227BL	\$2194	\$1600	\$1834	+\$140	+\$485	+\$28	+\$94	+\$109	+\$217
18"	48"	27½"	E6RN184827BL	\$2232	\$1638	\$1872	+\$167	+\$579	+\$28	+\$94	+\$124	+\$249
18"	60"	27½"	E6RN186027BL	\$2309	\$1715	\$1949	+\$195	+\$679	+\$28	+\$94	+\$139	+\$280

18"D x 15"W Box/File Pedestal on Legs, Pedestal Right

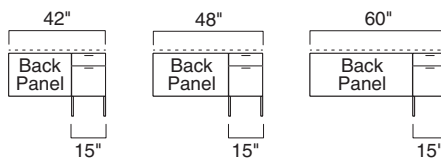

18"	42"	27½"	E6RN184227BR	\$2194	\$1600	\$1834	+\$140	+\$485	+\$28	+\$94	+\$109	+\$217
18"	48"	27½"	E6RN184827BR	\$2232	\$1638	\$1872	+\$167	+\$579	+\$28	+\$94	+\$124	+\$249
18"	60"	27½"	E6RN186027BR	\$2309	\$1715	\$1949	+\$195	+\$679	+\$28	+\$94	+\$139	+\$280

► **Specification Information, continued on next page**

Elective Elements

Return Credenzas, Wood Veneer or Laminate, continued

SIN 711.2

► Specification Information, continued from previous page

Specification Information													
Dimension			Style Number	Base Prices			Options (Add \$ to Base Price)						
D	W	H		Wood Group 1 Case	Laminate Price Group 1 Case	Wood Group 1 Front	Wood Case with Wood Front	Laminate Case with Wood Front	Wood Group 2	Wood Group 3	Wood Group 2	Wood Group 3	
							Wood Case with Wood Front	Laminate Case with Wood Front	Wood Group 2	Wood Group 3	Wood Group 2	Wood Group 3	Finished Back Panel Laminate Wood Group 1

18"D x 18"W Box/File Pedestal on Legs, Pedestal Left

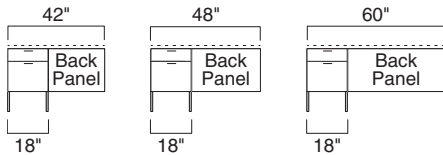

18"	42"	27½"	E6RN184227CL	\$2458	\$1864	\$2098	+\$140	+\$485	+\$28	+\$94	+\$109	+\$217
18"	48"	27½"	E6RN184827CL	\$2496	\$1902	\$2136	+\$167	+\$579	+\$28	+\$94	+\$124	+\$249
18"	60"	27½"	E6RN186027CL	\$2574	\$1980	\$2214	+\$195	+\$679	+\$28	+\$94	+\$139	+\$280

18"D x 18"W Box/File Pedestal on Legs, Pedestal Right

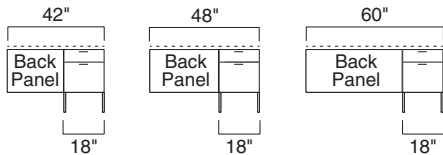

18"	42"	27½"	E6RN184227CR	\$2458	\$1864	\$2098	+\$140	+\$485	+\$28	+\$94	+\$109	+\$217
18"	48"	27½"	E6RN184827CR	\$2496	\$1902	\$2136	+\$167	+\$579	+\$28	+\$94	+\$124	+\$249
18"	60"	27½"	E6RN186027CR	\$2574	\$1980	\$2214	+\$195	+\$679	+\$28	+\$94	+\$139	+\$280

24"D x 15"W Box/File Pedestal on Legs, Pedestal Left

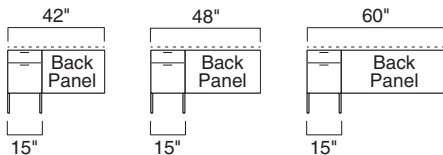

24"	42"	27½"	E6RN244227BL	\$2194	\$1600	\$1834	+\$140	+\$485	+\$28	+\$94	+\$109	+\$217
24"	48"	27½"	E6RN244827BL	\$2232	\$1638	\$1872	+\$167	+\$579	+\$28	+\$94	+\$124	+\$249
24"	60"	27½"	E6RN246027BL	\$2309	\$1715	\$1949	+\$195	+\$679	+\$28	+\$94	+\$139	+\$280

► Specification Information, continued on next page

► Specification Information, continued from previous page

Specification Information													
Dimension			Style Number	Base Prices			Options (Add \$ to Base Price)						
D	W	H		Wood Group 1 Case	Laminate Price Group 1 Case	Wood Group 1 Front	Wood Case with Wood Front	Laminate Case with Wood Front	Wood Group 2	Wood Group 3	Wood Group 2	Wood Group 3	
												Finished Back Panel	
												Laminate	
												Wood Group 1	

24"D x 15"W Box/File Pedestal on Legs, Pedestal Right

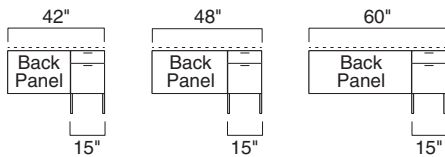

24"	42"	27 1/2"	E6RN244227BR	\$2194	\$1600	\$1834	+\$140	+\$485	+\$28	+\$94	+\$109	+\$217
24"	48"	27 1/2"	E6RN244827BR	\$2232	\$1638	\$1872	+\$167	+\$579	+\$28	+\$94	+\$124	+\$249
24"	60"	27 1/2"	E6RN246027BR	\$2309	\$1715	\$1949	+\$195	+\$679	+\$28	+\$94	+\$139	+\$280

24"D x 18"W Box/File Pedestal on Legs, Pedestal Left

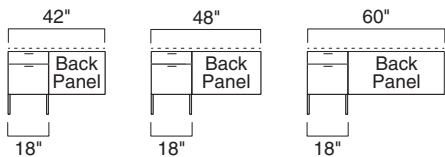

24"	42"	27 1/2"	E6RN244227CL	\$2458	\$1864	\$2098	+\$140	+\$485	+\$28	+\$94	+\$109	+\$217
24"	48"	27 1/2"	E6RN244827CL	\$2496	\$1902	\$2136	+\$167	+\$579	+\$28	+\$94	+\$124	+\$249
24"	60"	27 1/2"	E6RN246027CL	\$2574	\$1980	\$2214	+\$195	+\$679	+\$28	+\$94	+\$139	+\$280

24"D x 18"W Box/File Pedestal on Legs, Pedestal Right

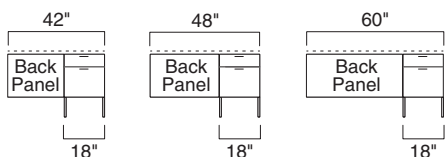

24"	42"	27 1/2"	E6RN244227CR	\$2458	\$1864	\$2098	+\$140	+\$485	+\$28	+\$94	+\$109	+\$217
24"	48"	27 1/2"	E6RN244827CR	\$2496	\$1902	\$2136	+\$167	+\$579	+\$28	+\$94	+\$124	+\$249
24"	60"	27 1/2"	E6RN246027CR	\$2574	\$1980	\$2214	+\$195	+\$679	+\$28	+\$94	+\$139	+\$280

60"W Leg Base 21½"H Credenzas

Wood Veneer or Laminate

SIN 711.2

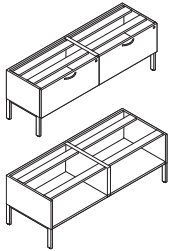

Tip: Storage legs may be shared with another leg base storage unit of the same depth.

Tip: When storage legs are shared between two units, the extra legs should be saved for later use, such as reconfiguration.

Standard Includes	Required to Specify
<ul style="list-style-type: none"> Underworksurface storage: <ul style="list-style-type: none"> – Wood group 1 case with wood group 1 front – Laminate price group 1 case with same or contrasting laminate front – Laminate price group 1 case with wood group 1 front Unfinished, inset back panel spanning full credenza Unfinished open top Storage leg; paint or metal Dovetail drawer construction Lock, keyed random Counterweight package Storage brace Standard close drawers 	<ol style="list-style-type: none"> Style number with appropriate suffix to indicate location of storage units Wood or laminate color number for underworksurface storage Laminate color number for laminate fronts on laminate case, if selected Wood color number for wood fronts on laminate cases, if selected Pull shape (see below under Required Selections) Paint or metal color number for storage leg Finish color number for pull Finish color number for lock Options, if selected (see below) <p>▶ See <i>Surface Materials</i>, page 566.</p>

Required Selections							
Pull Shape							
Contemporary	Jazz	Bar	Nile	Integral*	Transitional	Inset	Beam
No cost	+\$19 each	+\$26 each	+\$26 each	+\$26 each	+\$26 each	+\$26 each	+\$37 each

*Not available on laminate or composite fronts.

Options	Price	Required to Specify
Surface Materials	Wood underworksurface storage case <ul style="list-style-type: none"> Wood group 2: Prices at right Wood group 3: Prices at right Customiz stain: No cost 	Specify wood color number. Specify wood color number. Specify with <i>Customiz stain</i> .
For laminate price group 2 pricing, please refer to the electronic catalog or SmartTools.	Laminate underworksurface storage case <ul style="list-style-type: none"> Laminate price group 2: See information at left Open Line laminate: +\$ 69 plus cost of laminate Wood group 2 on wood fronts: Prices at right Wood group 3 on wood fronts: Prices at right Customiz stain: No cost 	Specify laminate color number. ▶ See <i>Surface Materials Reference Manual</i> . Specify wood color number. Specify wood color number. Specify with <i>Customiz stain</i> .
Lock and Keying	Lock <ul style="list-style-type: none"> Ember chrome: No cost Polished chrome: No cost 	Specify with <i>9250 Ember Chrome lock</i> . Specify with <i>9201 Polished Chrome lock</i> .
	Keying <ul style="list-style-type: none"> Factory- and field-installed keying units 	▶ Page 622
Counterweight Package	<ul style="list-style-type: none"> Counterweight package: No cost Omit counterweight package: –\$ 65 each 	Specify with <i>counterweight package</i> . Specify with <i>no counterweight package</i> .
Back Panel	<ul style="list-style-type: none"> Unfinished full length back panel: No cost Laminate full length back panel: +\$156 Wood full length back panel: +\$311 	Specify with <i>unfinished back panel</i> . Specify with <i>laminate finished back panel</i> . Specify with <i>wood finished back panel</i> .

Tip: Back panel is inset and spans entire width of credenza.

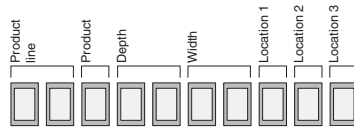

Tip: The location of the suffix within the style number determines the location of the storage unit within the credenza.

Tip: Credenzas with all open components have a 23 in the depth location of the style number instead of a 24 due to the dimensional change with the lack of a headset.

Specification Information



18" x 30" File 24" x 30" File 24" x 30" Open

Style Number	Counter-weight Package	Base Prices		Options (Add \$ to Base Price)				
		Wood Group 1 Case	Laminate Price Group 1 Case	Wood Case with Wood Front	Laminate Case with Wood Front	Wood Group 2	Wood Group 3	
		Wood Group 1 Front	Laminate Price Group 1 Front	Wood Group 1 Open Front	Wood	Wood Group 3	Wood Group 2	Wood Group 3

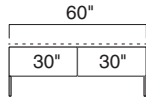

Full Storage: 18"D x 60"W

E6C1860MM	2	\$3922	\$2713	\$3423	+\$174	+\$612	+\$54	+\$190
------------------	---	--------	--------	--------	--------	--------	-------	--------

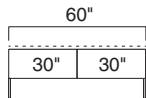

Full Storage: 24"D x 60"W

E6C2460NN	2	\$4098	\$2889	\$3599	+\$174	+\$612	+\$54	+\$190
E6C2360OO	N.A.	\$3589	N.A.	\$2878	+\$136	+\$484	N.A.	N.A.
E6C2460ON	1	\$3843	\$2882	\$3238	+\$156	+\$547	+\$28	+\$ 94
E6C2460NO	1	\$3843	\$2882	\$3238	+\$156	+\$547	+\$28	+\$ 94

66"W Leg Base 21½"H Credenzas

Wood Veneer or Laminate

SIN 711.2

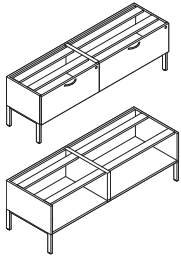

Tip: Storage legs may be shared with another leg base storage unit of the same depth.

Tip: When storage legs are shared between two units, the extra legs should be saved for later use, such as reconfiguration.

Standard Includes	Required to Specify
<ul style="list-style-type: none"> Underworksurface storage: <ul style="list-style-type: none"> – Wood group 1 case with wood group 1 front – Laminate price group 1 case with same or contrasting laminate front – Laminate price group 1 case with wood group 1 front Unfinished, inset back panel spanning full credenza Unfinished open top Storage leg; paint or metal Dovetail drawer construction Lock, keyed random Counterweight package Storage brace Standard close drawers 	<ol style="list-style-type: none"> Style number with appropriate suffix to indicate location of storage units Wood or laminate color number for underworksurface storage Laminate color number for laminate fronts on laminate case, if selected Wood color number for wood fronts on laminate cases, if selected Pull shape (see below under Required Selections) Paint or metal color number for storage leg Finish color number for pull Finish color number for lock Options, if selected (see below) <p>▶ See <i>Surface Materials</i>, page 566.</p>

Required Selections								
Pull Shape								
Contemporary	Jazz	Bar	Nile	Integral*	Transitional	Inset	Beam	
No cost	+\$19 each	+\$26 each	+\$26 each	+\$26 each	+\$26 each	+\$26 each	+\$37 each	

*Not available on laminate or composite fronts.

	Options	Price	Required to Specify
Surface Materials	Wood underworksurface storage case		
	<ul style="list-style-type: none"> Wood group 2 Wood group 3 Customiz stain 	Prices at right Prices at right No cost	Specify wood color number. Specify wood color number. Specify with <i>Customiz stain</i> .
	Laminate underworksurface storage case		
	<ul style="list-style-type: none"> Laminate price group 2 Open Line laminate 	See information at left +\$ 69 plus cost of laminate	Specify laminate color number. ▶ See <i>Surface Materials Reference Manual</i> .
	<ul style="list-style-type: none"> Wood group 2 on wood fronts Wood group 3 on wood fronts Customiz stain 	Prices at right Prices at right No cost	Specify wood color number. Specify wood color number. Specify with <i>Customiz stain</i> .
Lock and Keying	Lock		
	<ul style="list-style-type: none"> Ember chrome Polished chrome 	No cost No cost	Specify with <i>9250 Ember Chrome lock</i> . Specify with <i>9201 Polished Chrome lock</i> .
	Keying		
	<ul style="list-style-type: none"> Factory- and field-installed keying units 		▶ Page 622
Counterweight Package	<ul style="list-style-type: none"> Counterweight package Omit counterweight package 	No cost –\$ 65 each	Specify with <i>counterweight package</i> . Specify with <i>no counterweight package</i> .
Back Panel	<ul style="list-style-type: none"> Unfinished full length back panel Laminate full length back panel Wood full length back panel 	No cost +\$171 +\$342	Specify with <i>unfinished back panel</i> . Specify with <i>laminate finished back panel</i> . Specify with <i>wood finished back panel</i> .

For laminate price group 2 pricing, please refer to the electronic catalog or SmartTools.

Tip: Back panel is inset and spans entire width of credenza.

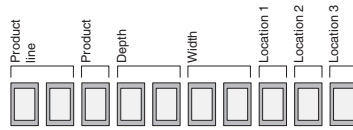

Tip: The location of the suffix within the style number determines the location of the storage unit within the credenza.

Tip: Credenzas with all open components have a 23 in the depth location of the style number instead of a 24 due to the dimensional change with the lack of a headset.

Specification Information

Suffix M	Suffix N	Suffix O	Suffix P	Suffix Q	Suffix R
18" x 30" File	24" x 30" File	24" x 30" Open	18" x 36" File	24" x 36" File	24" x 36" Open

Style Number	Counter-weight Package	Base Prices	Laminate Price	Options
		Wood Group 1 Case Wood Group 1 Front	Laminate Price Group 1 Case Laminate Price Group 1 Front	Options (Add \$ to Base Price) Wood Case with Wood Front Wood Group 2 Wood Case with Laminate Wood Front Wood Group 3 Wood Group 2 Wood Group 3

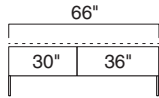

Full Storage: 18"D x 66"W

Style	Qty	Case	Front	Case	Front	Case	Front	Case	Front
E6C1866MP	2	\$4116	\$2907	\$3617	+\$174	+\$612	+\$54	+\$190	
E6C1866PM	2	\$4116	\$2907	\$3617	+\$174	+\$612	+\$54	+\$190	

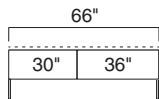

Full Storage: 24"D x 66"W

Style	Qty	Case	Front	Case	Front	Case	Front	Case	Front
E6C2466NQ	2	\$4314	\$3105	\$3815	+\$174	+\$612	+\$54	+\$190	
E6C2466NR	1	\$4010	\$3049	\$3405	+\$156	+\$547	+\$28	+\$ 94	
E6C2366OR	N.A.	\$3755	N.A.	\$3044	+\$136	+\$484	N.A.	N.A.	
E6C2466OQ	1	\$4059	\$3098	\$3454	+\$156	+\$547	+\$28	+\$ 94	
E6C2466QN	2	\$4314	\$3105	\$3815	+\$174	+\$612	+\$54	+\$190	
E6C2466QO	1	\$4059	\$3098	\$3454	+\$156	+\$547	+\$28	+\$ 94	
E6C2366RO	N.A.	\$3755	N.A.	\$3044	+\$136	+\$484	N.A.	N.A.	
E6C2466RN	1	\$4010	\$3049	\$3405	+\$156	+\$547	+\$28	+\$ 94	

Elective Elements

72"W Leg Base 21½"H Credenzas

Wood Veneer or Laminate

SIN 711.2

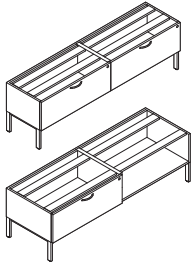

Tip: Storage legs may be shared with another leg base storage unit of the same depth.

Tip: When storage legs are shared between two units, the extra legs should be saved for later use, such as reconfiguration.

Standard Includes

- Underworksurface storage:
 - Wood group 1 case with wood group 1 front
 - Laminate price group 1 case with same or contrasting laminate front
 - Laminate price group 1 case with wood group 1 front
- Unfinished, inset back panel spanning full credenza
- Unfinished open top
- Storage leg; paint or metal
- Dovetail drawer construction
- Lock, keyed random
- Counterweight package
- Storage brace
- Standard close drawers

Required to Specify

- 1 Style number with appropriate suffix to indicate location of storage units
 - 2 Wood or laminate color number for underworksurface storage
 - 3 Laminate color number for laminate fronts on laminate case, if selected
 - 4 Wood color number for wood fronts on laminate cases, if selected
 - 5 Pull shape (see below under Required Selections)
 - 6 Paint or metal color number for storage leg
 - 7 Finish color number for pull
 - 8 Finish color number for lock
 - 9 Options, if selected (see below)
- ▶ See *Surface Materials*, page 566.

Required Selections

Pull Shape

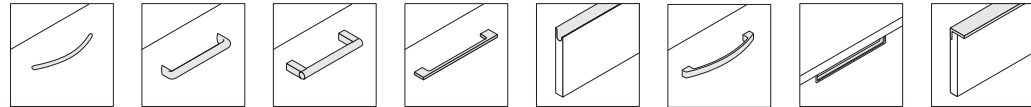

Contemporary	Jazz	Bar	Nile	Integral*	Transitional	Inset	Beam
No cost	+\$19 each	+\$26 each	+\$26 each	+\$26 each	+\$26 each	+\$26 each	+\$37 each

*Not available on laminate or composite fronts.

Options

Options	Price	Required to Specify
Surface Materials <ul style="list-style-type: none"> • Wood group 2 • Wood group 3 • Customiz stain 	Wood underworksurface storage case Prices at right Prices at right No cost	Specify wood color number. Specify wood color number. Specify with <i>Customiz stain</i> .
<ul style="list-style-type: none"> • Laminate price group 2 • Open Line laminate 	Laminate underworksurface storage case See information at left +\$ 69 plus cost of laminate Prices at right Prices at right No cost	Specify laminate color number. ▶ See <i>Surface Materials Reference Manual</i> . Specify wood color number. Specify wood color number. Specify with <i>Customiz stain</i> .
Lock and Keying <ul style="list-style-type: none"> • Ember chrome • Polished chrome 	Lock No cost No cost	Specify with <i>9250 Ember Chrome lock</i> . Specify with <i>9201 Polished Chrome lock</i> .
	Keying <ul style="list-style-type: none"> • Factory- and field-installed keying units 	▶ Page 622
Counterweight Package <ul style="list-style-type: none"> • Counterweight package • Omit counterweight package 	No cost –\$ 65 each	Specify with <i>counterweight package</i> . Specify with <i>no counterweight package</i> .
Back Panel <ul style="list-style-type: none"> • Unfinished full length back panel • Laminate full length back panel • Wood full length back panel 	No cost +\$187 +\$373	Specify with <i>unfinished back panel</i> . Specify with <i>laminate finished back panel</i> . Specify with <i>wood finished back panel</i> .

For laminate price group 2 pricing, please refer to the electronic catalog or SmartTools.

Tip: Back panel is inset and spans entire width of credenza.

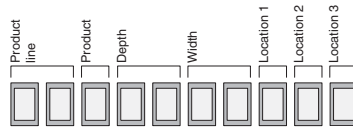

Tip: The location of the suffix within the style number determines the location of the storage unit within the credenza.

Tip: Credenzas with all open components have a 23 in the depth location of the style number instead of a 24 due to the dimensional change with the lack of a headset.

Specification Information

Suffix P **Suffix Q** **Suffix R**

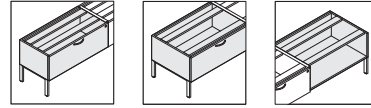

18" x 36" File 24" x 36" File 24" x 36" Open

Style Number

Counter-weight Package

Base Prices

Wood Group 1 Case

Laminate Price Group 1 Case

Wood Group 1 Front

Laminate Price Group 1 Front

Wood Group 1 Front or Open Front

Options

(Add \$ to Base Price)

Wood

Wood Case with Wood Front

Laminate Case with Wood Front

Wood Group 2

Wood Group 3

Wood Group 2

Wood Group 3

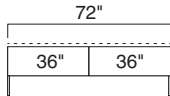

Full Storage: 18"D x 72"W

E6C1872PP	2	\$4311	\$3102	\$3812	+\$174	+\$612	+\$54	+\$190
------------------	---	--------	--------	--------	--------	--------	-------	--------

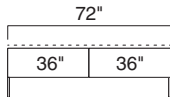

Full Storage: 24"D x 72"W

E6C2472QQ	2	\$4531	\$3322	\$4032	+\$174	+\$612	+\$54	+\$190
E6C2472QR	1	\$4226	\$3265	\$3621	+\$156	+\$547	+\$28	+\$ 94
E6C2372RR	N.A.	\$3922	N.A.	\$3211	+\$136	+\$484	N.A.	N.A.
E6C2472RQ	1	\$4226	\$3265	\$3621	+\$156	+\$547	+\$28	+\$ 94

90"W Leg Base 21½"H Credenzas

Wood Veneer or Laminate

SIN 711.2

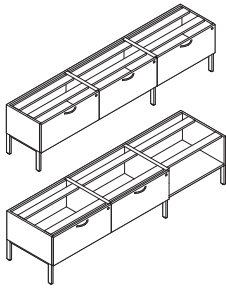

Tip: Storage legs may be shared with another leg base storage unit of the same depth.

Tip: When storage legs are shared between two units, the extra legs should be saved for later use, such as reconfiguration.

Standard Includes	Required to Specify
-------------------	---------------------

- Underworksurface storage:
 - Wood group 1 case with wood group 1 front
 - Laminate price group 1 case with same or contrasting laminate front
 - Laminate price group 1 case with wood group 1 front
- Unfinished, inset back panel spanning full credenza
- Unfinished open top
- Storage leg: paint or metal
- Dovetail drawer construction
- Lock, keyed random
- Counterweight package
- Storage brace
- Standard close drawers

- 1 Style number with appropriate suffix to indicate location of storage units
 - 2 Wood or laminate color number for underworksurface storage
 - 3 Laminate color number for laminate fronts on laminate case, if selected
 - 4 Wood color number for wood fronts on laminate cases, if selected
 - 5 Pull shape (see below under Required Selections)
 - 6 Paint or metal color number for storage leg
 - 7 Finish color number for pull
 - 8 Finish color number for lock
 - 9 Options, if selected (see below)
- ▶ See *Surface Materials*, page 566.

Required Selections	
---------------------	--

Pull Shape

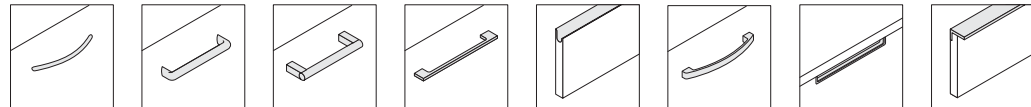

- | | | | | | | | |
|--------------|------------|------------|------------|------------|--------------|------------|------------|
| Contemporary | Jazz | Bar | Nile | Integral* | Transitional | Inset | Beam |
| No cost | +\$19 each | +\$26 each | +\$26 each | +\$26 each | +\$26 each | +\$26 each | +\$37 each |

*Not available on laminate or composite fronts.

Options	Price	Required to Specify
---------	-------	---------------------

Surface Materials

Wood underworksurface storage case

- Wood group 2 Prices at right
- Wood group 3 Prices at right
- Customiz stain No cost

Specify wood color number.
Specify wood color number.
Specify with *Customiz stain*.

Laminate underworksurface storage case

- Laminate price group 2 See information at left
- Open Line laminate +\$ 69 plus cost of laminate
- Wood group 2 on wood fronts Prices at right
- Wood group 3 on wood fronts Prices at right
- Customiz stain No cost

Specify laminate color number.
▶ See *Surface Materials Reference Manual*.
Specify wood color number.
Specify wood color number.
Specify with *Customiz stain*.

Lock and Keying

Lock

- Ember chrome No cost
- Polished chrome No cost

Specify with *9250 Ember Chrome lock*.
Specify with *9201 Polished Chrome lock*.

Keying

- Factory- and field-installed keying units

▶ Page 622

Counterweight Package

- Counterweight package No cost
- Omit counterweight package -\$ 65 each

Specify with *counterweight package*.
Specify with *no counterweight package*.

Back Panel

- Unfinished full length back panel No cost
- Laminate full length back panel +\$233
- Wood full length back panel +\$466

Specify with *unfinished back panel*.
Specify with *laminate finished back panel*.
Specify with *wood finished back panel*.

For laminate price group 2 pricing, please refer to the electronic catalog or SmartTools.

Tip: Back panel is inset and spans entire width of credenza.

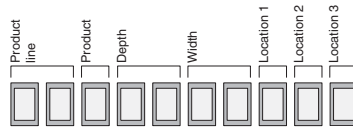

Tip: The location of the suffix within the style number determines the location of the storage unit within the credenza.

Tip: Credenzas with all open components have a 23 in the depth location of the style number instead of a 24 due to the dimensional change with the lack of a headset.

Specification Information

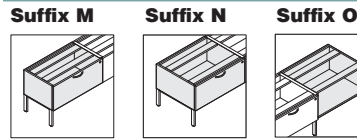

18" x 30" File 24" x 30" File 24" x 30" Open

Style Number	Counter-weight Package	Base Prices		Options (Add \$ to Base Price)			
		Wood Group 1 Case	Laminate Price Group 1 Case	Wood Case with Wood Front	Laminate Case with Wood Front	Wood Group 2	Wood Group 3
		Wood Group 1 Front	Laminate Price Group 1 Front	Wood Group 1 Front or Open Front	Wood	Wood Group 2	Wood Group 3

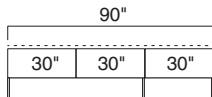
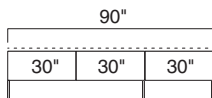

Full Storage: 18"D x 90"W

E6C1890MMM	3	\$5882	\$4067	\$5133	+\$261	+\$917	+\$82	+\$284
-------------------	---	--------	--------	--------	--------	--------	-------	--------

Full Storage: 24"D x 90"W

E6C2490NNN	3	\$6146	\$4331	\$5397	+\$261	+\$917	+\$82	+\$284
E6C2390OOO	N.A.	\$5382	N.A.	\$4316	+\$205	+\$725	N.A.	N.A.
E6C2490NNO	2	\$5892	\$4327	\$5037	+\$242	+\$854	+\$54	+\$190
E6C2490NOO	1	\$5636	\$4320	\$4676	+\$225	+\$789	+\$28	+\$ 94
E6C2490OON	2	\$5892	\$4327	\$5037	+\$242	+\$854	+\$54	+\$190
E6C2490OON	1	\$5636	\$4320	\$4676	+\$225	+\$789	+\$28	+\$ 94

96"W Leg Base 21½"H Credenzas

Wood Veneer or Laminate

SIN 711.2

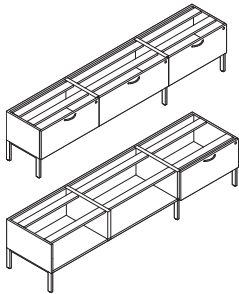

Tip: Storage legs may be shared with another leg base storage unit of the same depth.

Tip: When storage legs are shared between two units, the extra legs should be saved for later use, such as reconfiguration.

Standard Includes

- Underworksurface storage:
 - Wood group 1 case with wood group 1 front
 - Laminate price group 1 case with same or contrasting laminate front
 - Laminate price group 1 case with wood group 1 front
- Unfinished, inset back panel spanning full credenza
- Unfinished open top
- Storage leg: paint or metal
- Dovetail drawer construction
- Lock, keyed random
- Counterweight package
- Storage brace
- Standard close drawers

Required to Specify

- 1 Style number with appropriate suffix to indicate location of storage units
 - 2 Wood or laminate color number for underworksurface storage
 - 3 Laminate color number for laminate fronts on laminate case, if selected
 - 4 Wood color number for wood fronts on laminate cases, if selected
 - 5 Pull shape (see below under Required Selections)
 - 6 Paint or metal color number for storage leg
 - 7 Finish color number for pull
 - 8 Finish color number for lock
 - 9 Options, if selected (see below)
- ▶ See *Surface Materials*, page 566.

Required Selections

Pull Shape

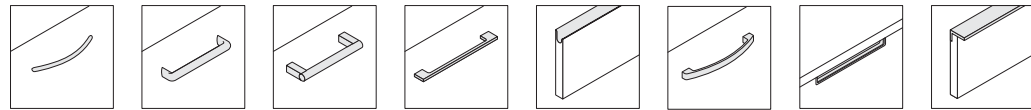

Contemporary	Jazz	Bar	Nile	Integral*	Transitional	Inset	Beam
No cost	+\$19 each	+\$26 each	+\$26 each	+\$26 each	+\$26 each	+\$26 each	+\$37 each

*Not available on laminate or composite fronts.

Options

Options	Price	Required to Specify
Surface Materials <ul style="list-style-type: none"> • Wood group 2 • Wood group 3 • Customiz stain 	Wood underworksurface storage case Prices at right Prices at right No cost	Specify wood color number. Specify wood color number. Specify with <i>Customiz stain</i> .
<ul style="list-style-type: none"> • Laminate price group 2 • Open Line laminate 	Laminate underworksurface storage case See information at left +\$ 69 plus cost of laminate	Specify laminate color number. ▶ See <i>Surface Materials Reference Manual</i> .
<ul style="list-style-type: none"> • Wood group 2 on wood fronts • Wood group 3 on wood fronts • Customiz stain 	Prices at right Prices at right No cost	Specify wood color number. Specify wood color number. Specify with <i>Customiz stain</i> .
Lock and Keying <ul style="list-style-type: none"> • Ember chrome • Polished chrome 	Lock No cost No cost	Specify with <i>9250 Ember Chrome lock</i> . Specify with <i>9201 Polished Chrome lock</i> .
	Keying <ul style="list-style-type: none"> • Factory- and field-installed keying units 	▶ Page 622
Counterweight Package <ul style="list-style-type: none"> • Counterweight package • Omit counterweight package 	No cost –\$ 65 each	Specify with <i>counterweight package</i> . Specify with <i>no counterweight package</i> .
Back Panel <ul style="list-style-type: none"> • Unfinished full length back panel • Laminate full length back panel • Wood full length back panel 	No cost +\$249 +\$497	Specify with <i>unfinished back panel</i> . Specify with <i>laminate finished back panel</i> . Specify with <i>wood finished back panel</i> .

For laminate price group 2 pricing, please refer to the electronic catalog or SmartTools.

Tip: Back panel is inset and spans entire width of credenza.

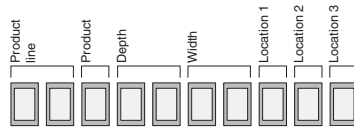

Tip: The location of the suffix within the style number determines the location of the storage unit within the credenza.

Tip: Credenzas with all open components have a 23 in the depth location of the style number instead of a 24 due to the dimensional change with the lack of a headset.

Specification Information

Suffix M	Suffix N	Suffix O	Suffix P	Suffix Q	Suffix R
18" x 30" File	24" x 30" File	24" x 30" Open	18" x 36" File	24" x 36" File	24" x 36" Open

Style Number	Counter-weight Package	Base Prices	Laminate Price	Options
		Wood Group 1 Case	Group 1 Case	(Add \$ to Base Price)
		Wood Group 1 Front	Laminate Price Group 1 Front	Wood Case with Wood Front
			Wood Group 1 Front or Open Front	Laminate Case with Wood Front
				Wood Group 2
				Wood Group 3
				Wood Group 2
				Wood Group 3

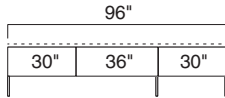

Full Storage: 18"D x 96"W

Style Number	Counter-weight Package	Base Price	Laminate Price	Options
E6C1896MPM	3	\$6077	\$4262	\$5328 +\$261 +\$917 +\$82 +\$284

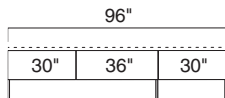

Full Storage: 24"D x 96"W

E6C2496NQN	3	\$6362	\$4547	\$5613 +\$261 +\$917 +\$82 +\$284
E6C2496NQO	2	\$6108	\$4543	\$5253 +\$242 +\$854 +\$54 +\$190
E6C2496NRO	1	\$5804	\$4488	\$4844 +\$225 +\$789 +\$28 +\$ 94
E6C2396ORO	N.A.	\$5549	N.A.	\$4483 +\$205 +\$725 N.A. N.A.
E6C2496OQN	2	\$6108	\$4543	\$5253 +\$242 +\$854 +\$54 +\$190
E6C2496ORN	1	\$5804	\$4488	\$4844 +\$225 +\$789 +\$28 +\$ 94

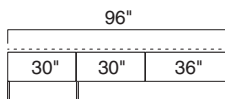

E6C2496NNR	2	\$6059	\$4494	\$5204 +\$242 +\$854 +\$54 +\$190
E6C2496OOQ	1	\$5854	\$4538	\$4894 +\$225 +\$789 +\$28 +\$ 94

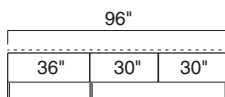

E6C2496RNN	2	\$6059	\$4494	\$5204 +\$242 +\$854 +\$54 +\$190
E6C2496QOO	1	\$5854	\$4538	\$4894 +\$225 +\$789 +\$28 +\$ 94

Elective Elements

18"D x 60"W Leg Base 27½"H Credenzas

Wood Veneer or Laminate

SIN 711.2

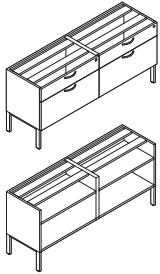

Tip: Storage legs may be shared with another leg base storage unit of the same depth.

Tip: When storage legs are shared between two units, the extra legs should be saved for later use, such as reconfiguration.

Standard Includes	Required to Specify
-------------------	---------------------

- Underworksurface storage:
 - Wood group 1 case with wood group 1 front
 - Laminate price group 1 case with same or contrasting laminate front
 - Laminate price group 1 case with wood group 1 front
- Unfinished, inset back panel spanning full credenza
- Unfinished open top
- Storage leg: paint or metal
- Dovetail drawer construction
- Lock, keyed random
- Counterweight package
- Storage brace
- Standard close drawers

- 1 Style number with appropriate suffix to indicate location of storage units
 - 2 Wood or laminate color number for underworksurface storage
 - 3 Laminate color number for laminate fronts on laminate case, if selected
 - 4 Wood color number for wood fronts on laminate cases, if selected
 - 5 Pull shape (see below under Required Selections)
 - 6 Paint or metal color number for storage leg
 - 7 Finish color number for pull
 - 8 Finish color number for lock
 - 9 Options, if selected (see below)
- ▶ See *Surface Materials*, page 566.

Required Selections	
---------------------	--

Pull Shape

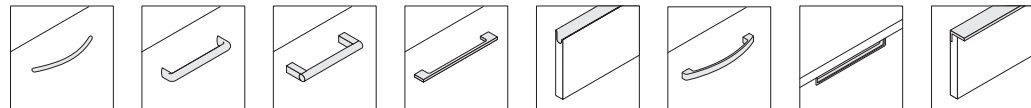

Contemporary	Jazz	Bar	Nile	Integral*	Transitional	Inset	Beam
No cost	+\$19 each	+\$26 each	+\$26 each	+\$26 each	+\$26 each	+\$26 each	+\$37 each

*Not available on laminate or composite fronts.

Options	Price	Required to Specify
---------	-------	---------------------

Surface Materials

Wood underworksurface storage case

- Wood group 2
- Wood group 3
- Customiz stain

Prices at right
Prices at right
No cost

Specify wood color number.
Specify wood color number.
Specify with *Customiz stain*.

Laminate underworksurface storage case

- Laminate price group 2
- Open Line laminate
- Wood group 2 on wood fronts
- Wood group 3 on wood fronts
- Customiz stain

See information at left
+\$ 69
plus cost of laminate
Prices at right
Prices at right
No cost

Specify laminate color number.
▶ See *Surface Materials Reference Manual*.
Specify wood color number.
Specify wood color number.
Specify with *Customiz stain*.

Lock and Keying

Lock

- Ember chrome
- Polished chrome

No cost
No cost

Specify with *9250 Ember Chrome lock*.
Specify with *9201 Polished Chrome lock*.

Keying

- Factory- and field-installed keying units

▶ Page 622

Shelves

- ¾" shelf
- Metal shelf

No cost
–\$ 26 per shelf

Specify with *¾" shelf*.
Specify with *metal shelf* and select paint color number.

Counterweight Package

- Counterweight package
- Omit counterweight package

No cost
–\$ 65 each

Specify with *counterweight package*.
Specify with *no counterweight package*.

Back Panel

- Laminate full length back panel
- Wood full length back panel

+\$156
+\$311

Specify with *laminate finished back panel*.
Specify with *wood finished back panel*.

Technology Trough

- Technology trough for power and data routing: black

+\$ 57 each

Specify with *technology trough*.

Cut-Out

- Right side only
- Left side only
- Both sides
- No cut-outs

No cost
No cost
No cost
No cost

Specify with *right cut-out*.
Specify with *left cut-out*.
Specify with *both cut-outs*.
Specify with *no cut-outs*.

For laminate price group 2 pricing, please refer to the electronic catalog or SmartTools.

Tip: Metal shelves only available in open or hinged door components.

Tip: Back panel is inset and spans entire width of credenza.

Tip: Technology trough is only available in open/file for 18"D.

Tip: Center or inside panels are always cut out if technology trough is specified to allow cords to pass between components.

18"D x 60"W Leg Base
27 1/2"H Credenzas

SIN 711.2

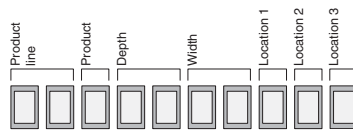

Tip: The location of the suffix within the style number determines the location of the storage unit within the credenza.

Specification Information

Suffix C	Suffix U	Suffix F	Suffix H
30" Box/ File	30" Open/ File	30" Open	30" Hinged Doors

Style Number	Number of Tech Troughs	Counter-weight Package	Base Prices		Options (Add \$ to Base Price)				
			Wood Group 1 Case	Laminate Price Group 1 Case	Wood Case with Wood Front	Laminate Case with Wood Front	Wood Group 2	Wood Group 3	
			Wood Group 1 Front	Laminate Price Group 1 Front	Wood Group 1 Front or Open Front	Wood Group 2	Wood Group 3	Wood Group 2	Wood Group 3

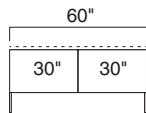

Full Storage: Two 30"W Positions

E6C1860CC	N.A.	4	\$4642	\$3246	\$3956	+\$174	+\$612	+\$54	+\$190
E6C1860CF	N.A.	2	\$4112	\$3058	\$3414	+\$156	+\$547	+\$28	+\$ 94
E6C1860UU	2	4	\$4112	\$2716	\$3426	+\$232	+\$814	+\$54	+\$190
E6C1860FC	N.A.	2	\$4112	\$3058	\$3414	+\$156	+\$547	+\$28	+\$ 94
E6C1860FF	N.A.	N.A.	\$3582	N.A.	\$2871	+\$136	+\$484	N.A.	N.A.
E6C1860HH	N.A.	N.A.	\$4535	\$3171	\$3849	+\$174	+\$612	+\$54	+\$190

18"D x 72"W Leg Base 27½"H Credenzas

Wood Veneer or Laminate

SIN 711.2

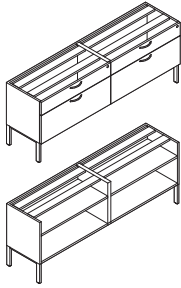

Tip: Storage legs may be shared with another leg base storage unit of the same depth.

Tip: When storage legs are shared between two units, the extra legs should be saved for later use, such as reconfiguration.

Standard Includes	Required to Specify
-------------------	---------------------

- Underworksurface storage:
 - Wood group 1 case with wood group 1 front
 - Laminate price group 1 case with same or contrasting laminate front
 - Laminate price group 1 case with wood group 1 front
- Unfinished, inset back panel spanning full credenza
- Unfinished open top
- Storage leg: paint or metal
- Dovetail drawer construction
- Lock, keyed random
- Counterweight package
- Storage brace
- Standard close drawers

- 1 Style number with appropriate suffix to indicate location of storage units
 - 2 Wood or laminate color number for underworksurface storage
 - 3 Laminate color number for laminate fronts on laminate case, if selected
 - 4 Wood color number for wood fronts on laminate cases, if selected
 - 5 Pull shape (see below under Required Selections)
 - 6 Paint or metal color number for storage leg
 - 7 Finish color number for pull
 - 8 Finish color number for lock
 - 9 Options, if selected (see below)
- ▶ See *Surface Materials*, page 566.

Required Selections

Pull Shape

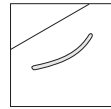

Contemporary

No cost

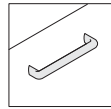

Jazz

+\$19 each

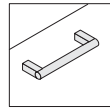

Bar

+\$26 each

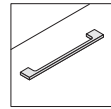

Nile

+\$26 each

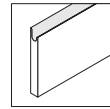

Integral*

+\$26 each

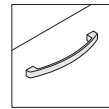

Transitional

+\$26 each

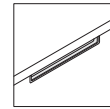

Inset

+\$26 each

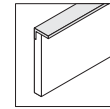

Beam

+\$37 each

*Not available on laminate or composite fronts.

Options	Price	Required to Specify
---------	-------	---------------------

Surface Materials

Wood underworksurface storage case

- Wood group 2
- Wood group 3
- Customiz stain

Prices at right
Prices at right
No cost

Specify wood color number.
Specify wood color number.
Specify *with Customiz stain*.

Laminate underworksurface storage case

- Laminate price group 2
- Open Line laminate
- Wood group 2 on wood fronts
- Wood group 3 on wood fronts
- Customiz stain

See information at left
+\$ 69
plus cost of laminate
Prices at right
Prices at right
No cost

Specify laminate color number.
▶ See *Surface Materials Reference Manual*.
Specify wood color number.
Specify wood color number.
Specify *with Customiz stain*.

Lock and Keying

Lock

- Ember chrome
- Polished chrome

No cost
No cost

Specify *with 9250 Ember Chrome lock*.
Specify *with 9201 Polished Chrome lock*.

Keying

- Factory- and field-installed keying units

▶ Page 622

Shelves

- ¾" shelf
- Metal shelf

No cost
–\$ 26 per shelf

Specify *with ¾" shelf*.
Specify *with metal shelf* and select paint color number.

Counterweight Package

- Counterweight package
- Omit counterweight package

No cost
–\$ 65 each

Specify *with counterweight package*.
Specify *with no counterweight package*.

Back Panel

- Laminate full length back panel
- Wood full length back panel

+\$187
+\$373

Specify *with laminate finished back panel*.
Specify *with wood finished back panel*.

Technology Trough

- Technology trough for power and data routing: black

+\$ 57 each

Specify *with technology trough*.

Cut-Out

- Right side only
- Left side only
- Both sides
- No cut-outs

No cost
No cost
No cost
No cost

Specify *with right cut-out*.
Specify *with left cut-out*.
Specify *with both cut-outs*.
Specify *with no cut-outs*.

For laminate price group 2 pricing, please refer to the electronic catalog or SmartTools.

Tip: Metal shelves only available in open or hinged door components.

Tip: Back panel is inset and spans entire width of credenza.

Tip: Technology trough is only available in open/file for 18"D.

Tip: Center or inside panels are always cut out if technology trough is specified to allow cords to pass between components.

18"D x 72"W Leg Base
27 1/2"H Credenzas

SIN 711.2

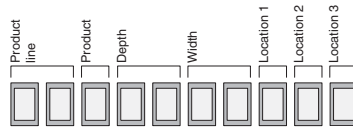

Tip: The location of the suffix within the style number determines the location of the storage unit within the credenza.

Specification Information

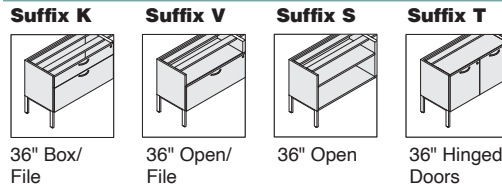

• Style Number	• Number of Tech Troughs	• Counter-weight Package	• Base Prices	• Options (Add \$ to Base Price)																						
			<table border="1"> <tr> <td>Wood Group 1 Case</td> <td>Laminate Price Group 1 Case</td> </tr> <tr> <td>Wood Group 1 Front</td> <td>Laminate Price Group 1 Front</td> </tr> <tr> <td></td> <td>Wood Group 1 Front or Open Front</td> </tr> </table>	Wood Group 1 Case	Laminate Price Group 1 Case	Wood Group 1 Front	Laminate Price Group 1 Front		Wood Group 1 Front or Open Front	<table border="1"> <tr> <td>Wood</td> <td>Wood</td> <td>Wood</td> <td>Wood</td> </tr> <tr> <td>Wood Case with Wood Front</td> <td>Wood Group 2</td> <td>Wood Group 3</td> <td>Laminate Case with Wood Front</td> </tr> <tr> <td></td> <td>Wood Group 2</td> <td>Wood Group 3</td> <td>Wood Group 2</td> </tr> <tr> <td></td> <td></td> <td></td> <td>Wood Group 3</td> </tr> </table>	Wood	Wood	Wood	Wood	Wood Case with Wood Front	Wood Group 2	Wood Group 3	Laminate Case with Wood Front		Wood Group 2	Wood Group 3	Wood Group 2				Wood Group 3
Wood Group 1 Case	Laminate Price Group 1 Case																									
Wood Group 1 Front	Laminate Price Group 1 Front																									
	Wood Group 1 Front or Open Front																									
Wood	Wood	Wood	Wood																							
Wood Case with Wood Front	Wood Group 2	Wood Group 3	Laminate Case with Wood Front																							
	Wood Group 2	Wood Group 3	Wood Group 2																							
			Wood Group 3																							

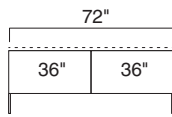

Full Storage: Two 36"W Positions

Style Number	Number of Tech Troughs	Counter-weight Package	Wood Group 1 Case	Laminate Price Group 1 Case	Wood Group 1 Front or Open Front	Wood Group 2	Wood Group 3	Wood Group 2	Wood Group 3
E6C1872KK	N.A.	4	\$5592	\$4196	\$4906	+\$174	+\$612	+\$54	+\$190
E6C1872VV	2	4	\$4738	\$3342	\$4052	+\$232	+\$814	+\$54	+\$190
E6C1872SS	N.A.	N.A.	\$3880	N.A.	\$3169	+\$136	+\$484	N.A.	N.A.
E6C1872TT	N.A.	N.A.	\$4770	\$3406	\$4084	+\$174	+\$612	+\$54	+\$190

18"D x 90"W Leg Base 27½"H Credenzas

Wood Veneer or Laminate

SIN 711.2

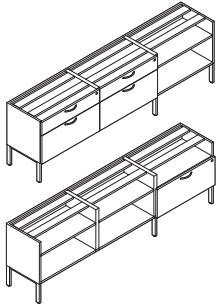

Tip: Storage legs may be shared with another leg base storage unit of the same depth.

Tip: When storage legs are shared between two units, the extra legs should be saved for later use, such as reconfiguration.

For laminate price group 2 pricing, please refer to the electronic catalog or SmartTools.

Tip: Metal shelves only available in open or hinged door components.

Tip: Back panel is inset and spans entire width of credenza.

Tip: Technology trough is only available in open/file for 18"D.

Tip: Center or inside panels are always cut out if technology trough is specified to allow cords to pass between components.

Standard Includes	Required to Specify
<ul style="list-style-type: none"> Underworksurface storage: <ul style="list-style-type: none"> – Wood group 1 case with wood group 1 front – Laminate price group 1 case with same or contrasting laminate front – Laminate price group 1 case with wood group 1 front Unfinished, inset back panel spanning full credenza Unfinished open top Storage leg: paint or metal Dovetail drawer construction Lock, keyed random Counterweight package Storage brace Standard close drawers 	<ol style="list-style-type: none"> Style number with appropriate suffix to indicate location of storage units Wood or laminate color number for underworksurface storage Laminate color number for laminate fronts on laminate case, if selected Wood color number for wood fronts on laminate cases, if selected Pull shape (see below under Required Selections) Paint or metal color number for storage leg Finish color number for pull Finish color number for lock Options, if selected (see below) <p>▶ See <i>Surface Materials</i>, page 566.</p>

Required Selections							
Pull Shape							
Contemporary	Jazz	Bar	Nile	Integral*	Transitional	Inset	Beam
No cost	+\$19 each	+\$26 each	+\$26 each	+\$26 each	+\$26 each	+\$26 each	+\$37 each

*Not available on laminate or composite fronts.

Options	Price	Required to Specify
Surface Materials <ul style="list-style-type: none"> Wood underworksurface storage case <ul style="list-style-type: none"> • Wood group 2 • Wood group 3 • Customiz stain Laminate underworksurface storage case <ul style="list-style-type: none"> • Laminate price group 2 • Open Line laminate • Wood group 2 on wood fronts • Wood group 3 on wood fronts • Customiz stain 	<ul style="list-style-type: none"> Prices at right Prices at right No cost See information at left +\$ 69 plus cost of laminate Prices at right Prices at right No cost 	<ul style="list-style-type: none"> Specify wood color number. Specify wood color number. Specify with <i>Customiz stain</i>. Specify laminate color number. ▶ See <i>Surface Materials Reference Manual</i>. Specify wood color number. Specify wood color number. Specify with <i>Customiz stain</i>.
Lock and Keying <ul style="list-style-type: none"> Lock <ul style="list-style-type: none"> • Ember chrome • Polished chrome Keying <ul style="list-style-type: none"> • Factory- and field-installed keying units 	<ul style="list-style-type: none"> No cost No cost 	<ul style="list-style-type: none"> Specify with <i>9250 Ember Chrome lock</i>. Specify with <i>9201 Polished Chrome lock</i>. ▶ Page 622
Shelves <ul style="list-style-type: none"> • ¾" shelf • Metal shelf 	<ul style="list-style-type: none"> No cost –\$ 26 per shelf 	<ul style="list-style-type: none"> Specify with <i>¾" shelf</i>. Specify with <i>metal shelf</i> and select paint color number.
Counterweight Package <ul style="list-style-type: none"> • Counterweight package • Omit counterweight package 	<ul style="list-style-type: none"> No cost –\$ 65 each 	<ul style="list-style-type: none"> Specify with <i>counterweight package</i>. Specify with <i>no counterweight package</i>.
Back Panel <ul style="list-style-type: none"> • Laminate full length back panel • Wood full length back panel 	<ul style="list-style-type: none"> +\$233 +\$466 	<ul style="list-style-type: none"> Specify with <i>laminate finished back panel</i>. Specify with <i>wood finished back panel</i>.
Technology Trough <ul style="list-style-type: none"> • Technology trough for power and data routing: black 	<ul style="list-style-type: none"> +\$ 57 each 	<ul style="list-style-type: none"> Specify with <i>technology trough</i>.
Cut-Out <ul style="list-style-type: none"> • Right side only • Left side only • Both sides • No cut-outs 	<ul style="list-style-type: none"> No cost No cost No cost No cost 	<ul style="list-style-type: none"> Specify with <i>right cut-out</i>. Specify with <i>left cut-out</i>. Specify with <i>both cut-outs</i>. Specify with <i>no cut-outs</i>.

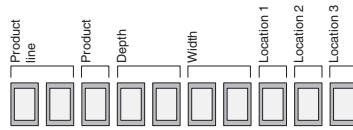

Tip: The location of the suffix within the style number determines the location of the storage unit within the credenza.

Specification Information

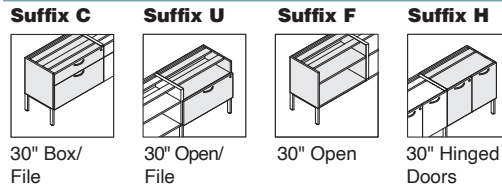

Style Number	Number of Tech Troughs	Counter-weight Package	Base Prices			Options (Add \$ to Base Price)			
			Wood Group 1 Case	Laminate Price Group 1 Case	Wood Group 1 Front or Open Front	Wood Case with Wood Front	Laminate Case with Wood Front	Wood Group 2	Wood Group 3

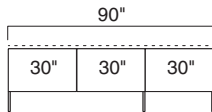

Full Storage: Three 30"W Positions

Style Number	Number of Tech Troughs	Counter-weight Package	Wood Group 1 Case	Laminate Price Group 1 Case	Wood Group 1 Front or Open Front	Wood Case with Wood Front	Laminate Case with Wood Front	Wood Group 2	Wood Group 3
E6C1890CCF	N.A.	4	\$6433	\$4683	\$5393	+\$242	+\$ 854	+\$54	+\$190
E6C1890CFF	N.A.	2	\$5903	\$4493	\$4849	+\$225	+\$ 789	+\$28	+\$ 94
E6C1890UUF	2	4	\$5903	\$4153	\$4863	+\$301	+\$1056	+\$54	+\$190
E6C1890UFF	1	2	\$5638	\$4228	\$4584	+\$254	+\$ 889	+\$28	+\$ 94
E6C1890FCC	N.A.	4	\$6433	\$4683	\$5393	+\$242	+\$ 854	+\$54	+\$190
E6C1890FUU	2	4	\$5903	\$4153	\$4863	+\$301	+\$1056	+\$54	+\$190
E6C1890FFC	N.A.	2	\$5903	\$4493	\$4849	+\$225	+\$ 789	+\$28	+\$ 94
E6C1890FFU	1	2	\$5638	\$4228	\$4584	+\$254	+\$ 889	+\$28	+\$ 94
E6C1890FHH	N.A.	N.A.	\$6325	\$4607	\$5285	+\$242	+\$ 854	+\$54	+\$190
E6C1890FFH	N.A.	N.A.	\$5850	\$4457	\$4796	+\$225	+\$ 789	+\$28	+\$ 94
E6C1890HHF	N.A.	N.A.	\$6325	\$4607	\$5285	+\$242	+\$ 854	+\$54	+\$190
E6C1890HFF	N.A.	N.A.	\$5850	\$4457	\$4796	+\$225	+\$ 789	+\$28	+\$ 94

18"D x 96"W Leg Base 27½"H Credenzas

Wood Veneer or Laminate

SIN 711.2

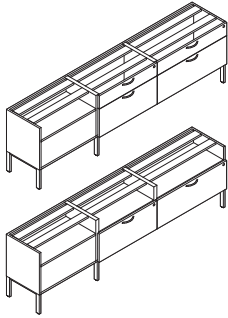

Tip: Storage legs may be shared with another leg base storage unit of the same depth.

Tip: When storage legs are shared between two units, the extra legs should be saved for later use, such as reconfiguration.

Standard Includes

- Underworksurface storage:
 - Wood group 1 case with wood group 1 front
 - Laminate price group 1 case with same or contrasting laminate front
 - Laminate price group 1 case with wood group 1 front
- Unfinished, inset back panel spanning full credenza
- Unfinished open top
- Storage leg: paint or metal
- Dovetail drawer construction
- Lock, keyed random
- Counterweight package
- Storage brace
- Standard close drawers

Required to Specify

- 1 Style number with appropriate suffix to indicate location of storage units
 - 2 Wood or laminate color number for underworksurface storage
 - 3 Laminate color number for laminate fronts on laminate case, if selected
 - 4 Wood color number for wood fronts on laminate cases, if selected
 - 5 Pull shape (see below under Required Selections)
 - 6 Paint or metal color number for storage leg
 - 7 Finish color number for pull
 - 8 Finish color number for lock
 - 9 Options, if selected (see below)
- ▶ See *Surface Materials*, page 566.

Required Selections

Pull Shape

Contemporary	Jazz	Bar	Nile	Integral*	Transitional	Inset	Beam
No cost	+\$19 each	+\$26 each	+\$26 each	+\$26 each	+\$26 each	+\$26 each	+\$37 each

*Not available on laminate or composite fronts.

Options

Options	Price	Required to Specify
Surface Materials	Wood underworksurface storage case	
	• Wood group 2	Prices at right
	• Wood group 3	Prices at right
	• Customiz stain	No cost
	Laminate underworksurface storage case	
	• Laminate price group 2	See information at left
	• Open Line laminate	+\$ 69 plus cost of laminate
	• Wood group 2 on wood fronts	Prices at right
	• Wood group 3 on wood fronts	Prices at right
	• Customiz stain	No cost
Lock and Keying	Lock	
	• Ember chrome	No cost
	• Polished chrome	No cost
	Keying	
	• Factory- and field-installed keying units	▶ Page 622
Shelves	• ¾" shelf	No cost
	• Metal shelf	–\$ 26 per shelf
Counterweight Package	• Counterweight package	No cost
	• Omit counterweight package	–\$ 65 each
Back Panel	• Laminate full length back panel	+\$249
	• Wood full length back panel	+\$497
Technology Trough	• Technology trough for power and data routing: black	+\$ 57 each
Cut-Out	• Right side only	No cost
	• Left side only	No cost
	• Both sides	No cost
	• No cut-outs	No cost

For laminate price group 2 pricing, please refer to the electronic catalog or SmartTools.

Tip: Metal shelves only available in open or hinged door components.

Tip: Back panel is inset and spans entire width of credenza.

Tip: Technology trough is only available in open/file for 18"D.

Tip: Center or inside panels are always cut out if technology trough is specified to allow cords to pass between components.

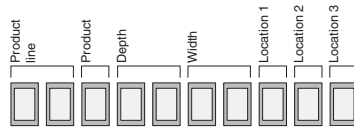

Tip: The location of the suffix within the style number determines the location of the storage unit within the credenza.

Specification Information

Suffix C	Suffix U	Suffix F	Suffix H	Suffix K	Suffix V	Suffix T
30" Box/File	30" Open/File	30" Open	30" Hinged Doors	36" Box/File	36" Open/File	36" Hinged Doors

Style Number	Number of Tech Troughs	Counter-weight Package	Base Prices			Options (Add \$ to Base Price)													
			Wood Group 1 Case	Laminate Price Group 1 Case	Wood Group 1 Front	Laminate Price Group 1 Front	Wood Group 1 Front or Open Front	Wood Case with Wood Front	Laminate Case with Wood Front	Wood Group 2	Wood Group 3	Wood Group 2	Wood Group 3						

Full Storage: Two 30"W Positions and One 36"W Position

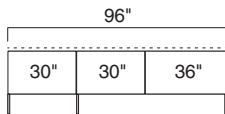

E6C1896FCK	N.A.	4	\$6909	\$5159	\$5869	+\$242	+\$ 854	+\$54	+\$190
E6C1896FUV	2	4	\$6216	\$4466	\$5176	+\$301	+\$1056	+\$54	+\$190
E6C1896FFK	N.A.	2	\$6379	\$4969	\$5325	+\$225	+\$ 789	+\$28	+\$ 94
E6C1896FFV	1	2	\$5950	\$4540	\$4896	+\$254	+\$ 889	+\$28	+\$ 94
E6C1896FHT	N.A.	N.A.	\$6443	\$4725	\$5403	+\$242	+\$ 854	+\$54	+\$190
E6C1896FFT	N.A.	N.A.	\$5968	\$4575	\$4914	+\$225	+\$ 789	+\$28	+\$ 94

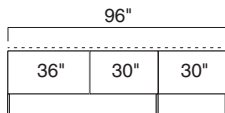

E6C1896KCF	N.A.	4	\$6909	\$5159	\$5869	+\$242	+\$ 854	+\$54	+\$190
E6C1896KFF	N.A.	2	\$6379	\$4969	\$5325	+\$225	+\$ 789	+\$28	+\$ 94
E6C1896TFF	N.A.	N.A.	\$5968	\$4575	\$4914	+\$225	+\$ 789	+\$28	+\$ 94
E6C1896VUF	2	4	\$6216	\$4466	\$5176	+\$301	+\$1056	+\$54	+\$190
E6C1896VFF	1	2	\$5950	\$4540	\$4896	+\$254	+\$ 889	+\$28	+\$ 94

24"D x 45"W Leg Base 27½"H Credenzas

Wood Veneer or Laminate

SIN 711.2

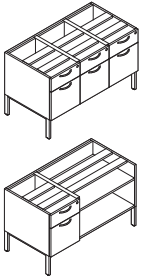

Tip: For 15"W to 36"W single leg base units, see page 352.

Tip: A 45"W credenza can only be used in an open kneewell setting (without a back panel). Order a leg base L-shape end panel separately. If a kneewell with a back panel is needed, order a built up credenza.

Tip: Storage legs may be shared with another leg base storage unit of the same depth.

Tip: When storage legs are shared between two units, the extra legs should be saved for later use, such as reconfiguration.

For laminate price group 2 pricing, please refer to the electronic catalog or SmartTools.

Tip: Soft close drawer slides only apply to storage that has 15"W drawers.

Tip: Soft close slides are available for both dovetail and miter fold construction.

Tip: Metal shelves only available in open or hinged door components.

Tip: Back panel is inset and spans entire width of credenza.

Tip: Technology trough is not available in hinged door components.

Tip: Center or inside panels are always cut out if technology trough is specified to allow cords to pass between components.

Standard Includes	Required to Specify
-------------------	---------------------

- Underworksurface storage:
 - Wood group 1 case with wood group 1 front
 - Laminate price group 1 case with same or contrasting laminate front
 - Laminate price group 1 case with wood group 1 front
- Unfinished, inset back panel spanning full credenza
- Unfinished open top
- Storage leg; paint or metal
- Dovetail drawer construction
- Lock, keyed random
- Counterweight package
- Storage brace
- Standard close drawer slides

- 1 Style number with appropriate suffix to indicate location of storage units
 - 2 Wood or laminate color number for underworksurface storage
 - 3 Laminate color number for laminate fronts on laminate case, if selected
 - 4 Wood color number for wood fronts on laminate cases, if selected
 - 5 Pull shape (see below under Required Selections)
 - 6 Paint or metal color number for storage leg
 - 7 Finish color number for pull
 - 8 Finish color number for lock
 - 9 Options, if selected (see below)
- ▶ See *Surface Materials*, page 566.

Required Selections

Pull Shape

Contemporary	Jazz	Bar	Nile	Integral*	Transitional	Inset	Beam
No cost	+\$19 each	+\$26 each	+\$26 each	+\$26 each	+\$26 each	+\$26 each	+\$37 each

*Not available on laminate or composite fronts.

Options	Price	Required to Specify
---------	-------	---------------------

Surface Materials	Wood underworksurface storage case		
	<ul style="list-style-type: none"> • Wood group 2 • Wood group 3 • Customiz stain 	Prices at right Prices at right No cost	Specify wood color number. Specify wood color number. Specify with <i>Customiz stain</i> .
	Laminate underworksurface storage case		
	<ul style="list-style-type: none"> • Laminate price group 2 • Open Line laminate 	See information at left +\$ 69 plus cost of laminate	Specify laminate color number. ▶ See <i>Surface Materials Reference Manual</i> .
	<ul style="list-style-type: none"> • Wood group 2 on wood fronts • Wood group 3 on wood fronts • Customiz stain 	Prices at right Prices at right No cost	Specify wood color number. Specify wood color number. Specify with <i>Customiz stain</i> .
Drawer Slide	• Soft close drawer slides	+\$ 30 per drawer	Specify with <i>soft close drawers</i> .
Lock and Keying	Lock		
	<ul style="list-style-type: none"> • Ember chrome • Polished chrome 	No cost No cost	Specify with <i>9250 Ember Chrome lock</i> . Specify with <i>9201 Polished Chrome lock</i> .
	Keying		
	• Factory- and field-installed keying units		▶ Page 622
Shelves	<ul style="list-style-type: none"> • ¾" shelf • Metal shelf 	No cost –\$ 26 per shelf	Specify with <i>¾" shelf</i> . Specify with <i>metal shelf</i> select and paint color number.
Counterweight Package	<ul style="list-style-type: none"> • Counterweight package • Omit counterweight package 	No cost –\$ 65 each	Specify with <i>counterweight package</i> . Specify with <i>no counterweight package</i> .
Back Panel	<ul style="list-style-type: none"> • Laminate full length back panel • Wood full length back panel 	+\$117 +\$234	Specify with <i>laminate finished back panel</i> . Specify with <i>wood finished back panel</i> .
Technology Trough	• Technology trough for power and data routing: black	+\$ 57 each	Specify with <i>technology trough</i> .
Cut-Out	<ul style="list-style-type: none"> • Right side only • Left side only • Both sides • No cut-outs 	No cost No cost No cost No cost	Specify with <i>right cut-out</i> . Specify with <i>left cut-out</i> . Specify with <i>both cut-outs</i> . Specify with <i>no cut-outs</i> .

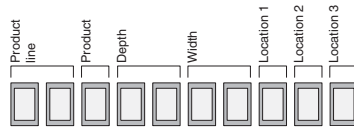

Tip: The location of the suffix within the style number determines the location of the storage unit within the credenza.

Specification Information

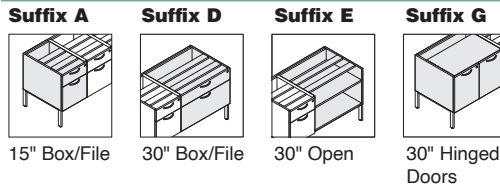

Style Number	Number of Tech Troughs	Counter-weight Package	Base Prices			Options (Add \$ to Base Price)			
			Wood Group 1 Case	Laminate Price Group 1 Case	Wood Group 1 Front	Wood Group 1 Front or Open Front	Wood Case with Wood Front	Laminate Case with Wood Front	Wood Group 2

Full Storage: Three 15"W Positions

E6C2445AAA	3	3	\$5238	\$3820	\$4510	+\$211	+\$732	+\$82	+\$284
-------------------	---	---	--------	--------	--------	--------	--------	-------	--------

Full Storage: One 15"W Position and One 30"W Position

E6C2445AD	2	3	\$4239	\$3069	\$3654	+\$157	+\$551	+\$54	+\$190
E6C2445AE	2	1	\$3802	\$2974	\$3204	+\$140	+\$485	+\$28	+\$ 94
E6C2445AG	N.A.	1	\$4110	\$2956	\$3525	+\$157	+\$551	+\$54	+\$190
E6C2445DA	2	3	\$4239	\$3069	\$3654	+\$157	+\$551	+\$54	+\$190
E6C2445EA	2	1	\$3802	\$2974	\$3204	+\$140	+\$485	+\$28	+\$ 94
E6C2445GA	N.A.	1	\$4110	\$2956	\$3525	+\$157	+\$551	+\$54	+\$190

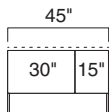
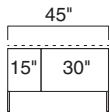
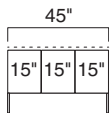

24"D x 48"W Leg Base 27½"H Credenzas

Wood Veneer or Laminate

SIN 711.2

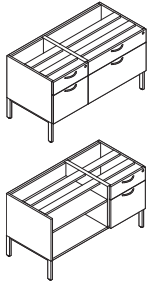

Tip: Storage legs may be shared with another leg base storage unit of the same depth.

Tip: When storage legs are shared between two units, the extra legs should be saved for later use, such as reconfiguration.

For laminate price group 2 pricing, please refer to the electronic catalog or SmartTools.

Tip: Soft close drawer slides only apply to storage that has 15"W drawers.

Tip: Soft close slides are available for both dovetail and miter fold construction.

Tip: Metal shelves only available in open or hinged door components.

Tip: Back panel is inset and spans entire width of credenza.

Tip: Technology trough not available in hinged door components.

Tip: Center or inside panels are always cut out if technology trough is specified to allow cords to pass between components.

Standard Includes	Required to Specify
-------------------	---------------------

- Underworksurface storage:
 - Wood group 1 case with wood group 1 front
 - Laminate price group 1 case with same or contrasting laminate front
 - Laminate price group 1 case with wood group 1 front
- Unfinished, inset back panel spanning full credenza
- Unfinished open top
- Storage leg; paint or metal
- Dovetail drawer construction
- Lock, keyed random
- Counterweight package
- Storage brace
- Standard close drawer slides

- 1 Style number with appropriate suffix to indicate location of storage units
 - 2 Wood or laminate color number for underworksurface storage
 - 3 Laminate color number for laminate fronts on laminate case, if selected
 - 4 Wood color number for wood fronts on laminate cases, if selected
 - 5 Pull shape (see below under Required Selections)
 - 6 Paint or metal color number for storage leg
 - 7 Finish color number for pull
 - 8 Finish color number for lock
 - 9 Options, if selected (see below)
- ▶ See *Surface Materials*, page 566.

Required Selections

Pull Shape

Contemporary	Jazz	Bar	Nile	Integral*	Transitional	Inset	Beam
No cost	+\$19 each	+\$26 each	+\$26 each	+\$26 each	+\$26 each	+\$26 each	+\$37 each

*Not available on laminate or composite fronts.

Options	Price	Required to Specify
---------	-------	---------------------

Surface Materials	Wood underworksurface storage case	<ul style="list-style-type: none"> • Wood group 2 • Wood group 3 • Customiz stain 	Prices at right Prices at right No cost	Specify wood color number. Specify wood color number. Specify with <i>Customiz stain</i> .
	Laminate underworksurface storage case	<ul style="list-style-type: none"> • Laminate price group 2 • Open Line laminate 	See information at left +\$ 69 plus cost of laminate	Specify laminate color number. ▶ See <i>Surface Materials Reference Manual</i> .
		<ul style="list-style-type: none"> • Wood group 2 on wood fronts • Wood group 3 on wood fronts • Customiz stain 	Prices at right Prices at right No cost	Specify wood color number. Specify wood color number. Specify with <i>Customiz stain</i> .
Drawer Slide	• Soft close drawer slides	+\$ 30 per drawer	Specify with <i>soft close drawers</i> .	
Lock and Keying	Lock	<ul style="list-style-type: none"> • Ember chrome • Polished chrome 	No cost No cost	Specify with <i>9250 Ember Chrome lock</i> . Specify with <i>9201 Polished Chrome lock</i> .
	Keying	• Factory- and field-installed keying units		▶ Page 622
Shelves	<ul style="list-style-type: none"> • ¾" shelf • Metal shelf 	No cost -\$ 26 per shelf	Specify with <i>¾" shelf</i> . Specify with <i>metal shelf</i> and select paint color number.	
Counterweight Package	<ul style="list-style-type: none"> • Counterweight package • Omit counterweight package 	No cost -\$ 65 each	Specify with <i>counterweight package</i> . Specify with <i>no counterweight package</i> .	
Back Panel	<ul style="list-style-type: none"> • Laminate full length back panel • Wood full length back panel 	+\$124 +\$249	Specify with <i>laminate finished back panel</i> . Specify with <i>wood finished back panel</i> .	
Technology Trough	• Technology trough for power and data routing; black	+\$ 57 each	Specify with <i>technology trough</i> .	
Cut-Out	<ul style="list-style-type: none"> • Right side only • Left side only • Both sides • No cut-outs 	No cost No cost No cost No cost	Specify with <i>right cut-out</i> . Specify with <i>left cut-out</i> . Specify with <i>both cut-outs</i> . Specify with <i>no cut-outs</i> .	

24"D x 48"W Leg Base
27½"H Credenzas

SIN 711.2

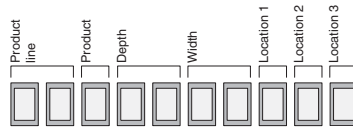

Tip: The location of the suffix within the style number determines the location of the storage unit within the credenza.

Specification Information

Suffix B	Suffix D	Suffix E	Suffix G
18" Box/File	30" Box/File	30" Open	30" Hinged Doors

Style Number	Number of Tech Troughs	Counter-weight Package	Base Prices			Options (Add \$ to Base Price)													
			Wood Group 1 Case	Laminate Price Group 1 Case	Wood Group 1 Front	Wood Group 1 Front or Open Front	Wood Case with Wood Front	Laminate Case with Wood Front	Wood Group 2	Wood Group 3									

Full Storage: One 18"W Position and One 30"W Position

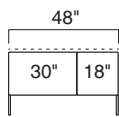
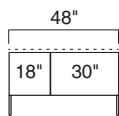

E6C2448BD	2	3	\$4417	\$3247	\$3832	+\$157	+\$551	+\$54	+\$190
E6C2448BE	2	1	\$3978	\$3150	\$3380	+\$140	+\$485	+\$28	+\$ 94
E6C2448BG	N.A.	1	\$4287	\$3133	\$3702	+\$157	+\$551	+\$54	+\$190
E6C2448DB	2	3	\$4417	\$3247	\$3832	+\$157	+\$551	+\$54	+\$190
E6C2448EB	2	1	\$3978	\$3150	\$3380	+\$140	+\$485	+\$28	+\$ 94
E6C2448GB	N.A.	1	\$4287	\$3133	\$3702	+\$157	+\$551	+\$54	+\$190

24"D x 54"W Leg Base 27½"H Credenzas

Wood Veneer or Laminate

SIN 711.2

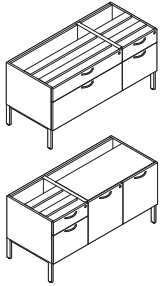

Tip: Storage legs may be shared with another leg base storage unit of the same depth.

Tip: When storage legs are shared between two units, the extra legs should be saved for later use, such as reconfiguration.

Standard Includes	Required to Specify
-------------------	---------------------

- Underworksurface storage:
 - Wood group 1 case with wood group 1 front
 - Laminate price group 1 case with same or contrasting laminate front
 - Laminate price group 1 case with wood group 1 front
- Unfinished, inset back panel spanning full credenza
- Unfinished open top
- Storage leg; paint or metal
- Dovetail drawer construction
- Lock, keyed random
- Counterweight package
- Storage brace
- Standard close drawer slides

- 1 Style number with appropriate suffix to indicate location of storage units
 - 2 Wood or laminate color number for underworksurface storage
 - 3 Laminate color number for laminate fronts on laminate case, if selected
 - 4 Wood color number for wood fronts on laminate cases, if selected
 - 5 Pull shape (see below under Required Selections)
 - 6 Paint or metal color number for storage leg
 - 7 Finish color number for pull
 - 8 Finish color number for lock
 - 9 Options, if selected (see below)
- ▶ See *Surface Materials*, page 566.

Required Selections

Pull Shape

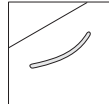

Contemporary

No cost

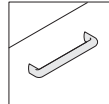

Jazz

+\$19 each

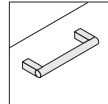

Bar

+\$26 each

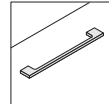

Nile

+\$26 each

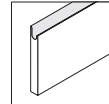

Integral*

+\$26 each

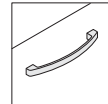

Transitional

+\$26 each

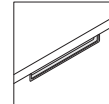

Inset

+\$26 each

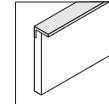

Beam

+\$37 each

*Not available on laminate or composite fronts.

Options	Price	Required to Specify
---------	-------	---------------------

Surface Materials

Wood underworksurface storage case

- Wood group 2 Prices at right
- Wood group 3 Prices at right
- Customiz stain No cost

Specify wood color number.
Specify wood color number.
Specify with *Customiz stain*.

Laminate underworksurface storage case

- Laminate price group 2 See information at left
- Open Line laminate +\$ 69 plus cost of laminate
- Wood group 2 on wood fronts Prices at right
- Wood group 3 on wood fronts Prices at right
- Customiz stain No cost

Specify laminate color number.
▶ See *Surface Materials Reference Manual*.

Specify wood color number.
Specify wood color number.
Specify with *Customiz stain*.

For laminate price group 2 pricing, please refer to the electronic catalog or SmartTools.

Drawer Slide

- Soft close drawer slides +\$ 30 per drawer

Specify with *soft close drawers*.

Tip: Soft close drawer slides only apply to storage that has 15"W drawers.

Lock and Keying

Lock

- Ember chrome No cost
- Polished chrome No cost

Specify with *9250 Ember Chrome lock*.
Specify with *9201 Polished Chrome lock*.

Keying

- Factory- and field-installed keying units

▶ Page 622

Tip: Soft close slides are available for both dovetail and miter fold construction.

Shelves

- ¾" shelf No cost
- Metal shelf -\$ 26 per shelf

Specify with *¾" shelf*.
Specify with *metal shelf* and select paint color number.

Tip: Metal shelves only available in open or hinged door components.

Counterweight Package

- Counterweight package No cost
- Omit counterweight package -\$ 65 each

Specify with *counterweight package*.
Specify with *no counterweight package*.

Tip: Back panel is inset and spans entire width of credenza.

Back Panel

- Laminate full length back panel +\$139
- Wood full length back panel +\$280

Specify with *laminate finished back panel*.
Specify with *wood finished back panel*.

Technology Trough

- Technology trough for power and data routing: black +\$ 57 each

Specify with *technology trough*.

Tip: Technology trough not available in hinged door components.

Cut-Out

- Right side only No cost
- Left side only No cost
- Both sides No cost
- No cut-outs No cost

Specify with *right cut-out*.
Specify with *left cut-out*.
Specify with *both cut-outs*.
Specify with *no cut-outs*.

Tip: Center or inside panels are always cut out if technology trough is specified to allow cords to pass between components.

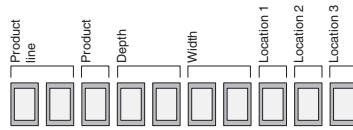

Tip: The location of the suffix within the style number determines the location of the storage unit within the credenza.

Specification Information

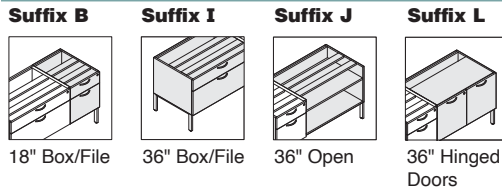

Style Number	Number of Tech Troughs	Counter-weight Package	Base Prices		Options (Add \$ to Base Price)				
			Wood Group 1 Case	Laminate Price Group 1 Case	Wood Case with Wood Front	Laminate Case with Wood Front	Wood Group 2	Wood Group 3	
			Wood Group 1 Front	Laminate Price Group 1 Front	Wood Group 1 Front or Open Front	Wood Group 2	Wood Group 3	Wood Group 2	Wood Group 3

Full Storage: One 18"W Position and One 36"W Position

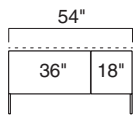
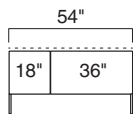

E6C2454BI	2	3	\$4891	\$3721	\$4306	+\$157	+\$551	+\$54	+\$190
E6C2454BJ	2	1	\$4131	\$3303	\$3533	+\$140	+\$485	+\$28	+\$ 94
E6C2454BL	N.A.	1	\$4409	\$3255	\$3824	+\$157	+\$551	+\$54	+\$190
E6C2454IB	2	3	\$4891	\$3721	\$4306	+\$157	+\$551	+\$54	+\$190
E6C2454JB	2	1	\$4131	\$3303	\$3533	+\$140	+\$485	+\$28	+\$ 94
E6C2454LB	N.A.	1	\$4409	\$3255	\$3824	+\$157	+\$551	+\$54	+\$190

24"D x 60"W Leg Base 27½"H Credenzas

Wood Veneer or Laminate

SIN 711.2

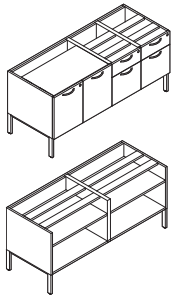

Tip: Storage legs may be shared with another leg base storage unit of the same depth.

Tip: When storage legs are shared between two units, the extra legs should be saved for later use, such as reconfiguration.

For laminate price group 2 pricing, please refer to the electronic catalog or SmartTools.

Tip: All credenzas with a kneewell ship knockdown.

Tip: Soft close drawer slides only apply to storage that has 15"W drawers.

Tip: Soft close slides are available for both dovetail and miter fold construction.

Tip: Metal shelves only available in open or hinged door components.

Tip: Back panel is inset and spans entire width of credenza.

Tip: Technology trough not available in hinged door components.

Tip: Center or inside panels are always cut out if technology trough is specified to allow cords to pass between components.

Standard Includes

- Underworksurface storage:
 - Wood group 1 case with wood group 1 front
 - Laminate price group 1 case with same or contrasting laminate front
 - Laminate price group 1 case with wood group 1 front
- Unfinished, inset back panel spanning full credenza
- Unfinished open top
- Storage leg; paint or metal
- Dovetail drawer construction
- Lock, keyed random
- Counterweight package
- Storage brace
- Standard close drawer slides

Required to Specify

- 1 Style number with appropriate suffix to indicate location of storage units
 - 2 Wood or laminate color number for underworksurface storage
 - 3 Laminate color number for laminate fronts on laminate case, if selected
 - 4 Wood color number for wood fronts on laminate cases, if selected
 - 5 Pull shape (see below under Required Selections)
 - 6 Paint or metal color number for storage leg
 - 7 Finish color number for pull
 - 8 Finish color number for lock
 - 9 Options, if selected (see below)
- ▶ See *Surface Materials*, page 566.

Required Selections

Pull Shape

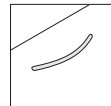

Contemporary

No cost

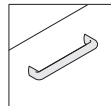

Jazz

+\$19 each

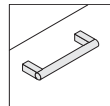

Bar

+\$26 each

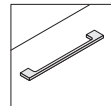

Nile

+\$26 each

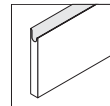

Integral*

+\$26 each

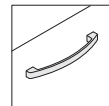

Transitional

+\$26 each

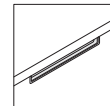

Inset

+\$26 each

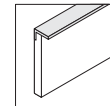

Beam

+\$37 each

*Not available on laminate or composite fronts.

Options

Options	Price	Required to Specify
Surface Materials <ul style="list-style-type: none"> • Wood group 2 • Wood group 3 • Customiz stain 	Wood underworksurface storage case <ul style="list-style-type: none"> Prices at right Prices at right No cost 	Specify wood color number. Specify wood color number. Specify with <i>Customiz stain</i> .
<ul style="list-style-type: none"> • Laminate price group 2 • Open Line laminate 	Laminate underworksurface storage case <ul style="list-style-type: none"> See information at left +\$ 69 plus cost of laminate Prices at right Prices at right No cost 	Specify laminate color number. ▶ See <i>Surface Materials Reference Manual</i> .
<ul style="list-style-type: none"> • Wood group 2 on wood fronts • Wood group 3 on wood fronts • Customiz stain 	<ul style="list-style-type: none"> • Soft close drawer slides 	Specify wood color number. Specify wood color number. Specify with <i>Customiz stain</i> .
Drawer Slide	+\$ 30 per drawer	Specify with <i>soft close drawers</i> .
Lock and Keying	Lock <ul style="list-style-type: none"> • Ember chrome • Polished chrome 	No cost No cost
	Keying <ul style="list-style-type: none"> • Factory- and field-installed keying units 	▶ Page 622
Shelves	<ul style="list-style-type: none"> • ¾" shelf • Metal shelf 	No cost -\$ 26 per shelf
	<ul style="list-style-type: none"> • Counterweight package • Omit counterweight package 	No cost -\$ 65 each
Counterweight Package		Specify with <i>counterweight package</i> . Specify with <i>no counterweight package</i> .
Back Panel	<ul style="list-style-type: none"> • Laminate full length back panel • Wood full length back panel 	+\$156 +\$311
	<ul style="list-style-type: none"> • Technology trough for power and data routing: black 	+\$ 57 each
Technology Trough		Specify with <i>technology trough</i> .
Cut-Out	<ul style="list-style-type: none"> • Right side only • Left side only • Both sides • No cut-outs • Kneewell 	No cost No cost No cost No cost No cost
		Specify with <i>right cut-out</i> . Specify with <i>left cut-out</i> . Specify with <i>both cut-outs</i> . Specify with <i>no cut-outs</i> . Specify with <i>kneewell cut-outs</i> .

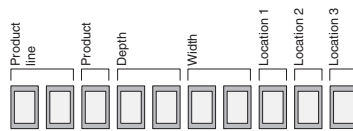

Tip: The location of the suffix within the style number determines the location of the storage unit within the credenza.

Specification Information

Suffix A	Suffix D	Suffix E	Suffix G
15" Box/File	30" Box/File	30" Open	30" Hinged Doors

Style Number	Number of Tech Troughs	Counter-weight Package	Base Prices			Options (Add \$ to Base Price)													
			Wood Group 1 Case	Laminate Price Group 1 Case	Wood Group 1 Front	Wood Group 1 Front or Open Front	Wood Case with Wood Front	Laminate Case with Wood Front	Wood Group 2	Wood Group 3									

Full Storage: Two 15"W Positions and One 30"W Position

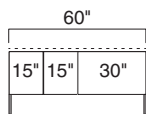

E6C2460AAD	3	4	\$5950	\$4306	\$5122	+\$228	+\$793	+\$82	+\$284
E6C2460AAE	3	2	\$5512	\$4212	\$4672	+\$209	+\$730	+\$54	+\$190
E6C2460AAG	2	2	\$5821	\$4195	\$4993	+\$228	+\$793	+\$82	+\$284

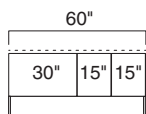

Full Storage: Two 30"W Positions

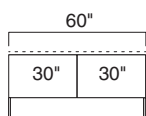

E6C2460DD	2	4	\$4953	\$3557	\$4267	+\$174	+\$612	+\$54	+\$190
E6C2460DE	2	2	\$4515	\$3461	\$3817	+\$156	+\$547	+\$28	+\$ 94
E6C2460DG	1	2	\$4824	\$3444	\$4138	+\$174	+\$612	+\$54	+\$190
E6C2460ED	2	2	\$4515	\$3461	\$3817	+\$156	+\$547	+\$28	+\$ 94
E6C2460EE	2	N.A.	\$4076	N.A.	\$3365	+\$136	+\$484	N.A.	N.A.
E6C2460EG	1	N.A.	\$4385	\$3348	\$3687	+\$156	+\$547	+\$28	+\$ 94
E6C2460GD	1	2	\$4824	\$3444	\$4138	+\$174	+\$612	+\$54	+\$190
E6C2460GE	1	N.A.	\$4385	\$3348	\$3687	+\$156	+\$547	+\$28	+\$ 94
E6C2460GG	N.A.	N.A.	\$4693	\$3329	\$4007	+\$174	+\$612	+\$54	+\$190

► Specification Information, continued on next page

24"D x 60"W Leg Base 27 1/2"H Credenzas, Wood Veneer or Laminate, continued

SIN 711.2

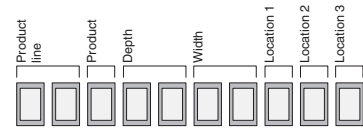

► Specification Information, continued from previous page

Specification Information

Tip: The location of the suffix within the style number determines the location of the storage unit within the credenza.

Suffix A	Suffix D	Suffix E	Suffix G	Suffix A1
15" Box/File	30" Box/File	30" Open	30" Hinged Doors	30" Kneewell

Style Number	Number of Tech Troughs	Counter-weight Package	Base Prices		Options (Add \$ to Base Price)				
			Wood Group 1 Case	Laminate Price Group 1 Case	Wood Case with Wood Front	Laminate Case with Wood Front	Wood Group 2	Wood Group 3	
			Wood Group 1 Front	Laminate Price Group 1 Front	Wood Group 1 Front or Open Front				

30"W Kneewell with Two 15"W Positions

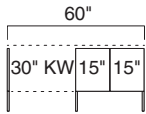

E6C2460A1AA	2	2	\$4242	\$3208	\$3668	+\$187	+\$652	+\$54	+\$190
--------------------	---	---	--------	--------	--------	--------	--------	-------	--------

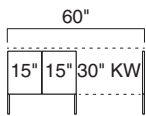

E6C2460AAA1	2	2	\$4242	\$3208	\$3668	+\$187	+\$652	+\$54	+\$190
--------------------	---	---	--------	--------	--------	--------	--------	-------	--------

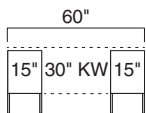

E6C2460AA1A	2	2	\$3940	\$2995	\$3455	+\$187	+\$652	+\$54	+\$190
--------------------	---	---	--------	--------	--------	--------	--------	-------	--------

30"W Kneewell with One 30"W Position

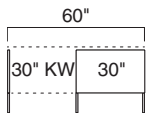

E6C2460A1D	1	2	\$3244	\$2455	\$2811	+\$136	+\$469	+\$28	+\$ 94
-------------------	---	---	--------	--------	--------	--------	--------	-------	--------

E6C2460A1E	1	N.A.	\$2806	N.A.	\$2361	+\$116	+\$406	N.A.	N.A.
-------------------	---	------	--------	------	--------	--------	--------	------	------

E6C2460A1G	N.A.	N.A.	\$3115	\$2343	\$2682	+\$136	+\$469	+\$28	+\$ 94
-------------------	------	------	--------	--------	--------	--------	--------	-------	--------

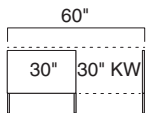

E6C2460DA1	1	2	\$3244	\$2455	\$2811	+\$136	+\$469	+\$28	+\$ 94
-------------------	---	---	--------	--------	--------	--------	--------	-------	--------

E6C2460EA1	1	N.A.	\$2806	N.A.	\$2361	+\$116	+\$406	N.A.	N.A.
-------------------	---	------	--------	------	--------	--------	--------	------	------

E6C2460GA1	N.A.	N.A.	\$3115	\$2343	\$2682	+\$136	+\$469	+\$28	+\$ 94
-------------------	------	------	--------	--------	--------	--------	--------	-------	--------

24"D x 60"W Leg Base
27½"H Credenzas

SIN 711.2

24"D x 66"W Leg Base 27½"H Credenzas

Wood Veneer or Laminate

SIN 711.2

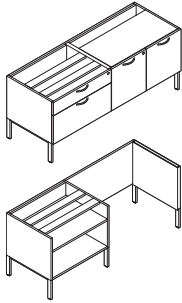

Tip: Storage legs may be shared with another leg base storage unit of the same depth.

Tip: When storage legs are shared between two units, the extra legs should be saved for later use, such as reconfiguration.

Tip: All credenzas with a kneewell ship knockdown.

For laminate price group 2 pricing, please refer to the electronic catalog or SmartTools.

Tip: Soft close drawer slides only apply to storage that has 15"W and 18"W drawers.

Tip: Soft close slides are available for both dovetail and miter fold construction.

Tip: Metal shelves only available in open or hinged door components.

Tip: Back panel is inset and spans entire width of credenza.

Tip: Technology trough not available in hinged door components.

Tip: Center or inside panels are always cut out if technology trough is specified to allow cords to pass between components

Standard Includes	Required to Specify
-------------------	---------------------

- Underworksurface storage:
 - Wood group 1 case with wood group 1 front
 - Laminate price group 1 case with same or contrasting laminate front
 - Laminate price group 1 case with wood group 1 front
- Unfinished, inset back panel spanning full credenza
- Unfinished open top
- Storage leg; paint or metal
- Dovetail drawer construction
- Lock, keyed random
- Counterweight package
- Storage brace
- Standard close drawer slides

- 1 Style number with appropriate suffix to indicate location of storage units
 - 2 Wood or laminate color number for underworksurface storage
 - 3 Laminate color number for laminate fronts on laminate case, if selected
 - 4 Wood color number for wood fronts on laminate cases, if selected
 - 5 Pull shape (see below under Required Selections)
 - 6 Paint or metal color number for storage leg
 - 7 Finish color number for pull
 - 8 Finish color number for lock
 - 9 Options, if selected (see below)
- ▶ See *Surface Materials*, page 566.

Required Selections

Pull Shape

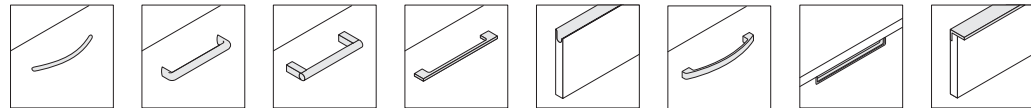

Contemporary	Jazz	Bar	Nile	Integral*	Transitional	Inset	Beam
No cost	+\$19 each	+\$26 each	+\$26 each	+\$26 each	+\$26 each	+\$26 each	+\$37 each

*Not available on laminate or composite fronts.

Options	Price	Required to Specify
---------	-------	---------------------

Surface Materials	Wood underworksurface storage case	Prices at right	Specify wood color number.
	<ul style="list-style-type: none"> • Wood group 2 • Wood group 3 • Customiz stain 	Prices at right No cost	Specify wood color number. Specify with <i>Customiz stain</i> .
	Laminate underworksurface storage case	See information at left	Specify laminate color number.
	<ul style="list-style-type: none"> • Laminate price group 2 • Open Line laminate • Wood group 2 on wood fronts • Wood group 3 on wood fronts • Customiz stain 	+\$ 69 plus cost of laminate Prices at right Prices at right No cost	▶ See <i>Surface Materials Reference Manual</i> . Specify wood color number. Specify wood color number. Specify with <i>Customiz stain</i> .
Drawer Slide	• Soft close drawer slides	+\$ 30 per drawer	Specify with <i>soft close drawers</i> .
Lock and Keying	Lock	No cost	Specify with <i>9250 Ember Chrome lock</i> .
	<ul style="list-style-type: none"> • Ember chrome • Polished chrome 	No cost	Specify with <i>9201 Polished Chrome lock</i> .
	Keying		▶ Page 622
	<ul style="list-style-type: none"> • Factory- and field-installed keying units 		
Shelves	• ¾" shelf	No cost	Specify with <i>¾" shelf</i> .
	• Metal shelf	–\$ 26 per shelf	Specify with <i>metal shelf</i> and select paint color number.
Counterweight Package	• Counterweight package	No cost	Specify with <i>counterweight package</i> .
	• Omit counterweight package	–\$ 65 each	Specify with <i>no counterweight package</i> .
Back Panel	• Laminate full length back panel	+\$171	Specify with <i>laminate finished back panel</i> .
	• Wood full length back panel	+\$342	Specify with <i>wood finished back panel</i> .
Technology Trough	• Technology trough for power and data routing: black	+\$ 57 each	Specify with <i>technology trough</i> .
Cut-Out	• Right side only	No cost	Specify with <i>right cut-out</i> .
	• Left side only	No cost	Specify with <i>left cut-out</i> .
	• Both sides	No cost	Specify with <i>both cut-outs</i> .
	• No cut-outs	No cost	Specify with <i>no cut-outs</i> .
	• Kneewell	No cost	Specify with <i>kneewell cut-outs</i> .

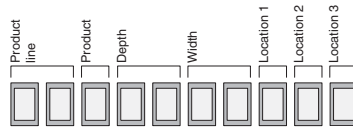

Tip: The location of the suffix within the style number determines the location of the storage unit within the credenza.

Specification Information

Suffix A	Suffix B	Suffix D	Suffix E	Suffix G	Suffix I	Suffix J	Suffix L
15" Box/File	18" Box/File	30" Box/File	30" Open	30" Hinged Doors	36" Box/File	36" Open	36" Hinged Doors

Style Number	Number of Tech Troughs	Counter-weight Package	Base Prices		Options (Add \$ to Base Price)				
			Wood Group 1 Case	Laminate Price Group 1 Case	Wood Case with Wood Front	Laminate Case with Wood Front	Wood Group 2	Wood Group 3	
			Wood Group 1 Front	Laminate Price Group 1 Front	Wood Group 1 Front or Open Front	Wood Group 2	Wood Group 3	Wood Group 2	Wood Group 3

Full Storage: Two 15"W Positions and One 36"W Position

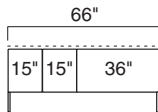

E6C2466AAI	3	4	\$6426	\$4782	\$5598	+\$228	+\$793	+\$82	+\$284
E6C2466AAJ	3	2	\$5665	\$4365	\$4825	+\$209	+\$730	+\$54	+\$190
E6C2466AAL	2	2	\$5942	\$4316	\$5114	+\$228	+\$793	+\$82	+\$284

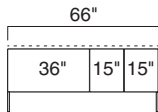

E6C2466IAA	3	4	\$6426	\$4782	\$5598	+\$228	+\$793	+\$82	+\$284
E6C2466JAA	3	2	\$5665	\$4365	\$4825	+\$209	+\$730	+\$54	+\$190
E6C2466LAA	2	2	\$5942	\$4316	\$5114	+\$228	+\$793	+\$82	+\$284

Full Storage: Two 18"W Positions and One 30"W Position

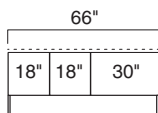

E6C2466BBD	3	4	\$6305	\$4661	\$5477	+\$228	+\$793	+\$82	+\$284
E6C2466BBE	3	2	\$5867	\$4567	\$5027	+\$209	+\$730	+\$54	+\$190
E6C2466BBG	2	2	\$6176	\$4550	\$5348	+\$228	+\$793	+\$82	+\$284

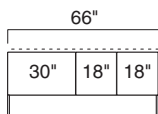

E6C2466DBB	3	4	\$6305	\$4661	\$5477	+\$228	+\$793	+\$82	+\$284
E6C2466EBB	3	2	\$5867	\$4567	\$5027	+\$209	+\$730	+\$54	+\$190
E6C2466GBB	2	2	\$6176	\$4550	\$5348	+\$228	+\$793	+\$82	+\$284

► Specification Information, continued on next page

24"D x 66"W Leg Base 27 1/2"H Credenzas, Wood Veneer or Laminate, continued

SIN 711.2

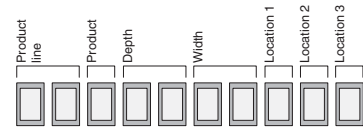

► Specification Information, continued from previous page

Specification Information

Tip: The location of the suffix within the style number determines the location of the storage unit within the credenza.

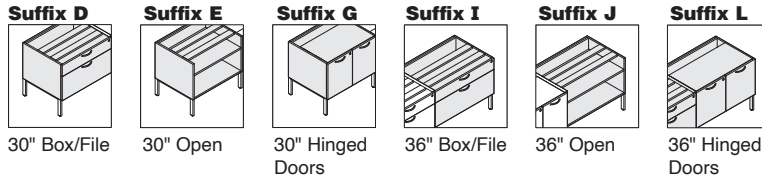

Style Number	Number of Tech Troughs	Counter-weight Package	Base Prices		Options (Add \$ to Base Price)				
			Wood Group 1 Case	Laminate Price Group 1 Case	Wood Case with Wood Front	Laminate Case with Wood Front	Wood Group 2	Wood Group 3	
			Wood Group 1 Front	Laminate Price Group 1 Front	Wood Group 1 Front or Open Front	Wood Group 2	Wood Group 3	Wood Group 2	Wood Group 3

Full Storage: One 30"W Position and One 36"W Position

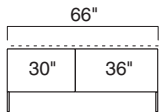

Style Number	Number of Tech Troughs	Counter-weight Package	Wood Group 1 Case	Laminate Price Group 1 Case	Wood Group 1 Front or Open Front	Wood Case with Wood Front	Laminate Case with Wood Front	Wood Group 2	Wood Group 3
E6C2466DI	2	4	\$5427	\$4031	\$4741	+\$174	+\$612	+\$54	+\$190
E6C2466DJ	2	2	\$4667	\$3613	\$3969	+\$156	+\$547	+\$28	+\$ 94
E6C2466DL	1	2	\$4945	\$3565	\$4259	+\$174	+\$612	+\$54	+\$190
E6C2466EI	2	2	\$4990	\$3936	\$4292	+\$156	+\$547	+\$28	+\$ 94
E6C2466EJ	2	N.A.	\$4229	N.A.	\$3518	+\$136	+\$484	N.A.	N.A.
E6C2466EL	1	N.A.	\$4507	\$3470	\$3809	+\$156	+\$547	+\$28	+\$ 94
E6C2466GI	1	2	\$5298	\$3918	\$4612	+\$174	+\$612	+\$54	+\$190
E6C2466GJ	1	N.A.	\$4538	\$3501	\$3840	+\$156	+\$547	+\$28	+\$ 94
E6C2466GL	N.A.	N.A.	\$4815	\$3451	\$4129	+\$174	+\$612	+\$54	+\$190

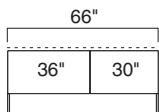

Style Number	Number of Tech Troughs	Counter-weight Package	Wood Group 1 Case	Laminate Price Group 1 Case	Wood Group 1 Front or Open Front	Wood Case with Wood Front	Laminate Case with Wood Front	Wood Group 2	Wood Group 3
E6C2466ID	2	4	\$5427	\$4031	\$4741	+\$174	+\$612	+\$54	+\$190
E6C2466IE	2	2	\$4990	\$3936	\$4292	+\$156	+\$547	+\$28	+\$ 94
E6C2466IG	1	2	\$5298	\$3918	\$4612	+\$174	+\$612	+\$54	+\$190
E6C2466JD	2	2	\$4667	\$3613	\$3969	+\$156	+\$547	+\$28	+\$ 94
E6C2466JE	2	N.A.	\$4229	N.A.	\$3518	+\$136	+\$484	N.A.	N.A.
E6C2466JG	1	N.A.	\$4538	\$3501	\$3840	+\$156	+\$547	+\$28	+\$ 94
E6C2466LD	1	2	\$4945	\$3565	\$4259	+\$174	+\$612	+\$54	+\$190
E6C2466LE	1	N.A.	\$4507	\$3470	\$3809	+\$156	+\$547	+\$28	+\$ 94
E6C2466LG	N.A.	N.A.	\$4815	\$3451	\$4129	+\$174	+\$612	+\$54	+\$190

► Specification Information, continued on next page

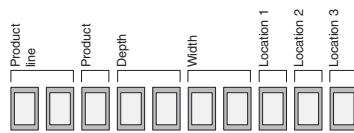

► Specification Information, continued from previous page

Specification Information

Tip: The location of the suffix within the style number determines the location of the storage unit within the credenza.

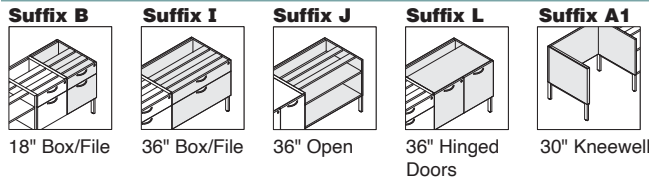

Style Number	Number of Tech Troughs	Counter-weight Package	Base Prices			Options (Add \$ to Base Price)				
			Wood Group 1 Case	Laminate Price Group 1 Case	Wood Group 1 Front	Laminate Price Group 1 Front	Wood Group 1 Front or Open Front	Wood Case with Wood Front	Laminate Case with Wood Front	Wood Group 2

30"W Kneewell with Two 18"W Positions

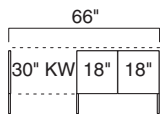

E6C2466A1BB	2	2	\$4596	\$3562	\$4022	+\$187	+\$652	+\$54	+\$190
--------------------	---	---	--------	--------	--------	--------	--------	-------	--------

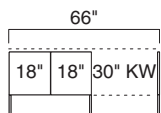

E6C2466BBA1	2	2	\$4596	\$3562	\$4022	+\$187	+\$652	+\$54	+\$190
--------------------	---	---	--------	--------	--------	--------	--------	-------	--------

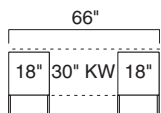

E6C2466BA1B	2	2	\$4294	\$3349	\$3809	+\$187	+\$652	+\$54	+\$190
--------------------	---	---	--------	--------	--------	--------	--------	-------	--------

30"W Kneewell with One 36"W Position

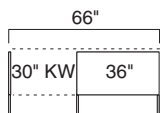

E6C2466A1I	1	2	\$3720	\$2931	\$3287	+\$136	+\$469	+\$28	+\$ 94
-------------------	---	---	--------	--------	--------	--------	--------	-------	--------

E6C2466A1J	1	N.A.	\$2959	N.A.	\$2514	+\$116	+\$406	N.A.	N.A.
-------------------	---	------	--------	------	--------	--------	--------	------	------

E6C2466A1L	N.A.	N.A.	\$3236	\$2464	\$2803	+\$136	+\$469	+\$28	+\$ 94
-------------------	------	------	--------	--------	--------	--------	--------	-------	--------

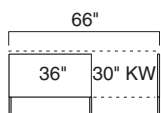

E6C2466IA1	1	2	\$3720	\$2931	\$3287	+\$136	+\$469	+\$28	+\$ 94
-------------------	---	---	--------	--------	--------	--------	--------	-------	--------

E6C2466JA1	1	N.A.	\$2959	N.A.	\$2514	+\$116	+\$406	N.A.	N.A.
-------------------	---	------	--------	------	--------	--------	--------	------	------

E6C2466LA1	N.A.	N.A.	\$3236	\$2464	\$2803	+\$136	+\$469	+\$28	+\$ 94
-------------------	------	------	--------	--------	--------	--------	--------	-------	--------

► Specification Information, continued on next page

24"D x 66"W Leg Base 27 1/2"H Credenzas, Wood Veneer or Laminate, continued

SIN 711.2

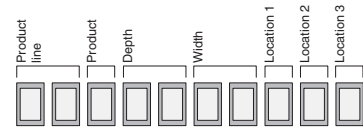

► Specification Information, continued from previous page

Specification Information

Tip: The location of the suffix within the style number determines the location of the storage unit within the credenza.

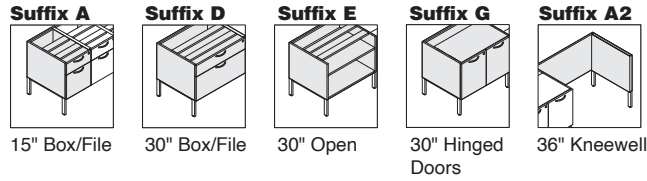

Style Number	Number of Tech Troughs	Counter-weight Package	Base Prices		Options (Add \$ to Base Price)					
			Wood Group 1 Case	Laminate Price Group 1 Case	Wood Case with Wood Front	Laminate Case with Wood Front	Wood Group 2	Wood Group 3	Wood Group 2	Wood Group 3
			Wood Group 1 Front	Laminate Price Group 1 Front	Wood Group 1 Front or Open Front					

36"W Kneewell with Two 15"W Positions

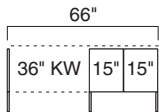

E6C2466A2AA	2	2	\$4305	\$3271	\$3731	+\$187	+\$652	+\$54	+\$190
--------------------	---	---	--------	--------	--------	--------	--------	-------	--------

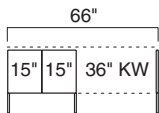

E6C2466AAA2	2	2	\$4305	\$3271	\$3731	+\$187	+\$652	+\$54	+\$190
--------------------	---	---	--------	--------	--------	--------	--------	-------	--------

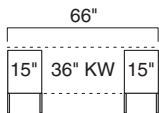

E6C2466AA2A	2	2	\$3950	\$3005	\$3465	+\$187	+\$652	+\$54	+\$190
--------------------	---	---	--------	--------	--------	--------	--------	-------	--------

36"W Kneewell with One 30"W Position

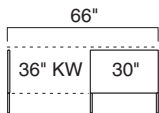

E6C2466A2D	1	2	\$3307	\$2518	\$2874	+\$136	+\$469	+\$28	+\$ 94
-------------------	---	---	--------	--------	--------	--------	--------	-------	--------

E6C2466A2E	1	N.A.	\$2869	N.A.	\$2424	+\$116	+\$406	N.A.	N.A.
-------------------	---	------	--------	------	--------	--------	--------	------	------

E6C2466A2G	N.A.	N.A.	\$3178	\$2406	\$2745	+\$136	+\$469	+\$28	+\$ 94
-------------------	------	------	--------	--------	--------	--------	--------	-------	--------

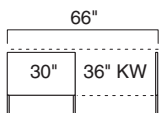

E6C2466DA2	1	2	\$3307	\$2518	\$2874	+\$136	+\$469	+\$28	+\$ 94
-------------------	---	---	--------	--------	--------	--------	--------	-------	--------

E6C2466EA2	1	N.A.	\$2869	N.A.	\$2424	+\$116	+\$406	N.A.	N.A.
-------------------	---	------	--------	------	--------	--------	--------	------	------

E6C2466GA2	N.A.	N.A.	\$3178	\$2406	\$2745	+\$136	+\$469	+\$28	+\$ 94
-------------------	------	------	--------	--------	--------	--------	--------	-------	--------

24"D x 66"W Leg Base
27½"H Credenzas

SIN 711.2

24"D x 72"W Leg Base 27½"H Credenzas

Wood Veneer or Laminate

SIN 711.2

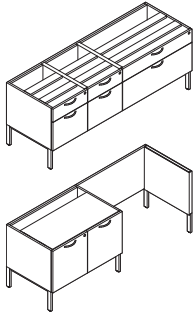

Tip: Storage legs may be shared with another leg base storage unit of the same depth.

Tip: When storage legs are shared between two units, the extra legs should be saved for later use, such as reconfiguration.

Tip: All credenzas with a kneewell ship knockdown.

For laminate price group 2 pricing, please refer to the electronic catalog or SmartTools.

Tip: Soft close drawer slides only apply to storage that has 15"W and 18"W drawers.

Tip: Soft close slides are available for both dovetail and miter fold construction.

Tip: Metal shelves only available in open or hinged door components.

Tip: Back panel is inset and spans entire width of credenza.

Tip: Center or inside panels are always cut out if technology trough is specified to allow cords to pass between components.

Tip: Technology trough not available in hinged door components.

Tip: Storage legs may be shared with another leg base storage unit of the same depth.

Standard Includes	Required to Specify
-------------------	---------------------

<ul style="list-style-type: none"> Underworksurface storage: <ul style="list-style-type: none"> Wood group 1 case with wood group 1 front Laminate price group 1 case with same or contrasting laminate front Laminate price group 1 case with wood group 1 front Unfinished, inset back panel spanning full credenza Unfinished open top Storage leg: paint or metal Dovetail drawer construction Lock, keyed random Counterweight package Storage brace Standard close drawer slides 	<ol style="list-style-type: none"> Style number with appropriate suffix to indicate location of storage units Wood or laminate color number for underworksurface storage Laminate color number for laminate fronts on laminate case, if selected Wood color number for wood fronts on laminate cases, if selected Pull shape (see below under Required Selections) Paint or metal color number for storage leg Finish color number for pull Finish color number for lock Options, if selected (see below) <p>▶ See <i>Surface Materials</i>, page 566.</p>
---	---

Required Selections

Pull Shape							
Contemporary	Jazz	Bar	Nile	Integral*	Transitional	Inset	Beam
No cost	+\$19 each	+\$26 each	+\$26 each	+\$26 each	+\$26 each	+\$26 each	+\$37 each

*Not available on laminate or composite fronts.

Options	Price	Required to Specify
---------	-------	---------------------

Surface Materials	Wood underworksurface storage case <ul style="list-style-type: none"> Wood group 2 Wood group 3 Customiz stain Laminate underworksurface storage case <ul style="list-style-type: none"> Laminate price group 2 Open Line laminate Wood group 2 on wood fronts Wood group 3 on wood fronts Customiz stain 	Prices at right Prices at right No cost See information at left +\$ 69 plus cost of laminate Prices at right Prices at right No cost Specify wood color number. Specify wood color number. Specify with <i>Customiz stain</i> .
Drawer Slide	<ul style="list-style-type: none"> Soft close drawer slides 	+\$ 30 per drawer Specify with <i>soft close drawers</i> .
Lock and Keying	Lock <ul style="list-style-type: none"> Ember chrome Polished chrome Keying <ul style="list-style-type: none"> Factory- and field-installed keying units 	No cost No cost ▶ Page 622 Specify with <i>9250 Ember Chrome lock</i> . Specify with <i>9201 Polished Chrome lock</i> .
Shelves	<ul style="list-style-type: none"> ¾" shelf Metal shelf 	No cost -\$ 26 per shelf Specify with <i>¾" shelf</i> . Specify with <i>metal shelf</i> and select paint color number.
Counterweight Package	<ul style="list-style-type: none"> Counterweight package Omit counterweight package 	No cost -\$ 65 each Specify with <i>counterweight package</i> . Specify with <i>no counterweight package</i> .
Back Panel	<ul style="list-style-type: none"> Laminate full length back panel Wood full length back panel 	+\$187 +\$373 Specify with <i>laminate finished back panel</i> . Specify with <i>wood finished back panel</i> .
Technology Trough	<ul style="list-style-type: none"> Technology trough for power and data routing: black 	+\$ 57 each Specify with <i>technology trough</i> .
Cut-Out	<ul style="list-style-type: none"> Right side only Left side only Both sides No cut-outs Kneewell 	No cost No cost No cost No cost No cost Specify with <i>right cut-out</i> . Specify with <i>left cut-out</i> . Specify with <i>both cut-outs</i> . Specify with <i>no cut-outs</i> . Specify with <i>kneewell cut-outs</i> .

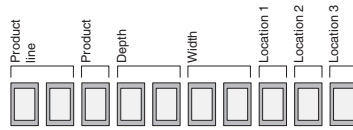

Tip: The location of the suffix within the style number determines the location of the storage unit within the credenza.

Specification Information

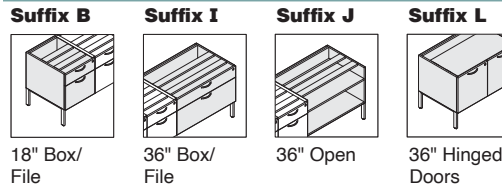

Style Number	Number of Tech Troughs	Counter-weight Package	Base Prices		Options (Add \$ to Base Price)				
			Wood Group 1 Case	Laminate Price Group 1 Case	Wood Case with Wood Front	Laminate Case with Wood Front	Wood Group 2	Wood Group 3	Wood Group 2

Full Storage: Two 18"W Positions and One 36"W Position

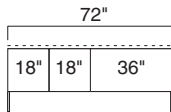

E6C2472BBI	3	4	\$6779	\$5135	\$5951	+\$228	+\$793	+\$82	+\$284
E6C2472BBJ	3	2	\$6019	\$4719	\$5179	+\$209	+\$730	+\$54	+\$190
E6C2472BBL	2	2	\$6297	\$4671	\$5469	+\$228	+\$793	+\$82	+\$284

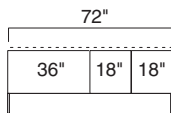

E6C2472IBB	3	4	\$6779	\$5135	\$5951	+\$228	+\$793	+\$82	+\$284
E6C2472JBB	3	2	\$6019	\$4719	\$5179	+\$209	+\$730	+\$54	+\$190
E6C2472LBB	2	2	\$6297	\$4671	\$5469	+\$228	+\$793	+\$82	+\$284

Full Storage: Two 36"W Positions

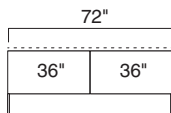

E6C2472II	2	4	\$5903	\$4507	\$5217	+\$174	+\$612	+\$54	+\$190
E6C2472IJ	2	2	\$5142	\$4088	\$4444	+\$156	+\$547	+\$28	+\$ 94
E6C2472IL	1	2	\$5419	\$4039	\$4733	+\$174	+\$612	+\$54	+\$190
E6C2472JI	2	2	\$5142	\$4088	\$4444	+\$156	+\$547	+\$28	+\$ 94
E6C2472JJ	2	N.A.	\$4381	N.A.	\$3670	+\$136	+\$484	N.A.	N.A.
E6C2472JL	1	N.A.	\$4659	\$3622	\$3961	+\$156	+\$547	+\$28	+\$ 94
E6C2472LI	1	2	\$5419	\$4039	\$4733	+\$174	+\$612	+\$54	+\$190
E6C2472LJ	1	N.A.	\$4659	\$3622	\$3961	+\$156	+\$547	+\$28	+\$ 94
E6C2472LL	N.A.	N.A.	\$4936	\$3572	\$4250	+\$174	+\$612	+\$54	+\$190

► Specification Information, continued on next page

24"D x 72"W Leg Base 27½"H Credenzas, Wood Veneer or Laminate, continued

SIN 711.2

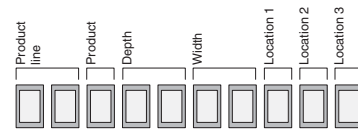

► Specification Information, continued from previous page

Specification Information

Tip: The location of the suffix within the style number determines the location of the storage unit within the credenza.

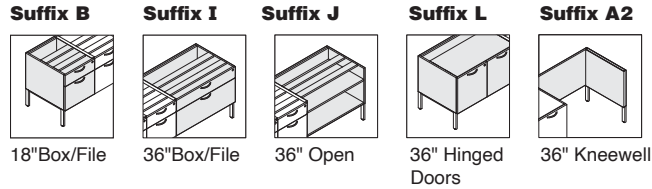

Style Number	Number of Tech Troughs	Counter-weight Package	Base Prices			Options (Add \$ to Base Price)			
			Wood Group 1 Case	Laminate Price Group 1 Case	Wood Group 1 Front	Laminate Price Group 1 Front	Wood Group 1 Front or Open Front	Wood Case with Wood Front	Laminate Case with Wood Front

36"W Kneewell with Two 18"W Positions

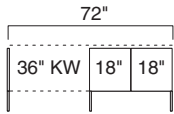

E6C2472A2BB	2	2	\$4659	\$3625	\$4085	+\$187	+\$652	+\$54	+\$190
--------------------	---	---	--------	--------	--------	--------	--------	-------	--------

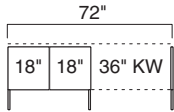

E6C2472BBA2	2	2	\$4659	\$3625	\$4085	+\$187	+\$652	+\$54	+\$190
--------------------	---	---	--------	--------	--------	--------	--------	-------	--------

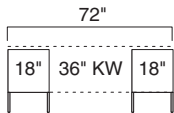

E6C2472BA2B	2	2	\$4356	\$3411	\$3871	+\$187	+\$652	+\$54	+\$190
--------------------	---	---	--------	--------	--------	--------	--------	-------	--------

36"W Kneewell with One 36"W Position

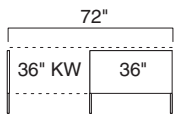

E6C2472A2I	1	2	\$3782	\$2993	\$3349	+\$136	+\$469	+\$28	+\$ 94
-------------------	---	---	--------	--------	--------	--------	--------	-------	--------

E6C2472A2J	1	N.A.	\$3021	N.A.	\$2576	+\$116	+\$406	N.A.	N.A.
-------------------	---	------	--------	------	--------	--------	--------	------	------

E6C2472A2L	N.A.	N.A.	\$3298	\$2526	\$2865	+\$136	+\$469	+\$28	+\$ 94
-------------------	------	------	--------	--------	--------	--------	--------	-------	--------

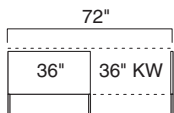

E6C2472IA2	1	2	\$3782	\$2993	\$3349	+\$136	+\$469	+\$28	+\$ 94
-------------------	---	---	--------	--------	--------	--------	--------	-------	--------

E6C2472JA2	1	N.A.	\$3021	N.A.	\$2576	+\$116	+\$406	N.A.	N.A.
-------------------	---	------	--------	------	--------	--------	--------	------	------

E6C2472LA2	N.A.	N.A.	\$3298	\$2526	\$2865	+\$136	+\$469	+\$28	+\$ 94
-------------------	------	------	--------	--------	--------	--------	--------	-------	--------

► Specification Information, continued on next page

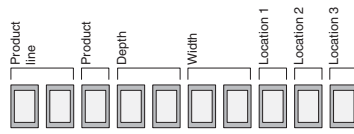

► Specification Information, continued from previous page

Specification Information

Tip: The location of the suffix within the style number determines the location of the storage unit within the credenza.

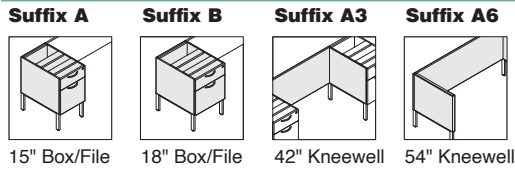

Style Number	Number of Tech Troughs	Counter-weight Package	Base Prices		Options (Add \$ to Base Price)					
			Wood Group 1 Case	Laminate Price Group 1 Case	Wood Group 1 Front	Wood Group 1 Front or Open Front	Wood Case with Wood Front	Laminate Case with Wood Front	Wood Group 2	Wood Group 3

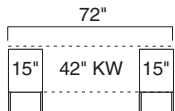

Tip: 42"W kneewell will always be centered within a 72"W credenza.

42"W Kneewell with Two 15"W Positions

E6C2472AA3A	2	2	\$4064	\$3119	\$3579	+\$187	+\$652	+\$54	+\$190
--------------------	---	---	--------	--------	--------	--------	--------	-------	--------

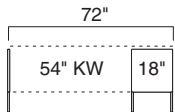

54"W Kneewell with One 18"W Position

E6C2472A6B	1	1	\$2957	\$2395	\$2625	+\$118	+\$407	+\$28	+\$ 94
-------------------	---	---	--------	--------	--------	--------	--------	-------	--------

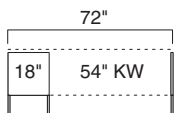

E6C2472BA6	1	1	\$2957	\$2395	\$2625	+\$118	+\$407	+\$28	+\$ 94
-------------------	---	---	--------	--------	--------	--------	--------	-------	--------

24"D x 78"W Leg Base 27½"H Credenzas

Wood Veneer or Laminate

SIN 711.2

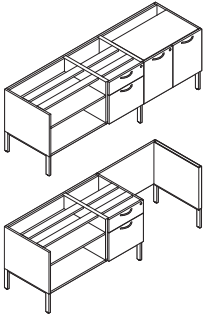

Tip: Storage legs may be shared with another leg base storage unit of the same depth.

Tip: When storage legs are shared between two units, the extra legs should be saved for later use, such as reconfiguration.

Tip: All credenzas with a kneewell ship knockdown.

For laminate price group 2 pricing, please refer to the electronic catalog or SmartTools.

Tip: Soft close drawer slides only apply to storage that has 15"W and 18"W drawers.

Tip: Soft close slides are available for both dovetail and miter fold construction.

Tip: Metal shelves only available in open or hinged door components.

Tip: Back panel is inset and spans entire width of credenza.

Tip: Technology trough not available in hinged door components.

Tip: Center or inside panels are always cut out if technology trough is specified to allow cords to pass between components.

Standard Includes	Required to Specify
-------------------	---------------------

- Underworksurface storage:
 - Wood group 1 case with wood group 1 front
 - Laminate price group 1 case with same or contrasting laminate front
 - Laminate price group 1 case with wood group 1 front
- Unfinished, inset back panel spanning full credenza
- Unfinished open top
- Storage leg; paint or metal
- Dovetail drawer construction
- Lock, keyed random
- Counterweight package
- Storage brace
- Standard close drawer slides

- 1 Style number with appropriate suffix to indicate location of storage units
 - 2 Wood or laminate color number for underworksurface storage
 - 3 Laminate color number for laminate fronts on laminate case, if selected
 - 4 Wood color number for wood fronts on laminate cases, if selected
 - 5 Pull shape (see below under Required Selections)
 - 6 Paint or metal color number for storage leg
 - 7 Finish color number for pull
 - 8 Finish color number for lock
 - 9 Options, if selected (see below)
- ▶ See *Surface Materials*, page 566.

Required Selections

Pull Shape

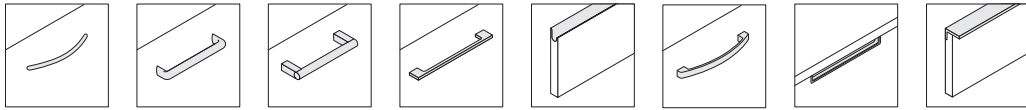

Contemporary	Jazz	Bar	Nile	Integral*	Transitional	Inset	Beam
No cost	+\$19 each	+\$26 each	+\$26 each	+\$26 each	+\$26 each	+\$26 each	+\$37 each

*Not available on laminate or composite fronts.

Options	Price	Required to Specify
---------	-------	---------------------

Surface Materials	Wood underworksurface storage case	Prices at right	Specify wood color number.
	<ul style="list-style-type: none"> • Wood group 2 • Wood group 3 • Customiz stain 	Prices at right No cost	Specify wood color number. Specify with <i>Customiz stain</i> .
	Laminate underworksurface storage case	See information at left	Specify laminate color number.
	<ul style="list-style-type: none"> • Laminate price group 2 • Open Line laminate • Wood group 2 on wood fronts • Wood group 3 on wood fronts • Customiz stain 	plus cost of laminate Prices at right Prices at right No cost	▶ See <i>Surface Materials Reference Manual</i> . Specify wood color number. Specify wood color number. Specify with <i>Customiz stain</i> .
Drawer Slide	• Soft close drawer slides	+\$ 30 per drawer	Specify with <i>soft close drawers</i> .
Lock and Keying	Lock	No cost	Specify with <i>9250 Ember Chrome lock</i> .
	• Polished chrome	No cost	Specify with <i>9201 Polished Chrome lock</i> .
	Keying		▶ Page 622
Shelves	• ¾" shelf	No cost	Specify with <i>¾" shelf</i> .
	• Metal shelf	–\$ 26 per shelf	Specify with <i>metal shelf</i> and select paint color number.
Counterweight Package	<ul style="list-style-type: none"> • Counterweight package • Omit counterweight package 	No cost –\$ 65 each	Specify with <i>counterweight package</i> . Specify with <i>no counterweight package</i> .
Back Panel	• Laminate full length back panel	+\$202	Specify with <i>laminate finished back panel</i> .
	• Wood full length back panel	+\$404	Specify with <i>wood finished back panel</i> .
Technology Trough	• Technology trough for power and data routing: black	+\$ 57 each	Specify with <i>technology trough</i> .
Cut-Out	• Right side only	No cost	Specify with <i>right cut-out</i> .
	• Left side only	No cost	Specify with <i>left cut-out</i> .
	• Both sides	No cost	Specify with <i>both cut-outs</i> .
	• No cut-outs	No cost	Specify with <i>no cut-outs</i> .
	• Kneewell	No cost	Specify with <i>kneewell cut-outs</i> .

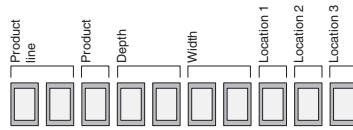

Tip: The location of the suffix within the style number determines the location of the storage unit within the credenza.

Specification Information

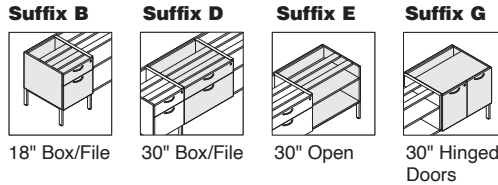

Style Number	Number of Tech Troughs	Counter-weight Package	Base Prices		Options (Add \$ to Base Price)				
			Wood Group 1 Case	Laminate Price Group 1 Case	Wood Group 1 Wood Case with Wood Front	Laminate Case with Wood Front	Wood Group 2	Wood Group 3	Wood Group 2

Full Storage: One 18"W Position and Two 30"W Positions

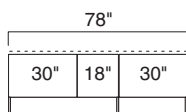
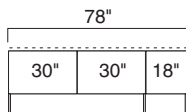
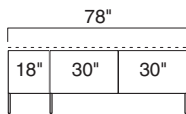

E6C2478BDD	3	5	\$6893	\$5023	\$5964	+\$245	+\$856	+\$82	+\$284
E6C2478BDE	3	3	\$6454	\$4928	\$5513	+\$225	+\$792	+\$54	+\$190
E6C2478BDG	2	3	\$6763	\$4909	\$5834	+\$245	+\$856	+\$82	+\$284
E6C2478BED	3	3	\$6454	\$4928	\$5513	+\$225	+\$792	+\$54	+\$190
E6C2478BEE	3	1	\$6017	\$4834	\$5064	+\$207	+\$726	+\$28	+\$ 94
E6C2478BEG	2	1	\$6325	\$4815	\$5384	+\$225	+\$792	+\$54	+\$190
E6C2478BGD	1	3	\$6763	\$4909	\$5834	+\$245	+\$856	+\$82	+\$284
E6C2478BGE	1	1	\$6325	\$4815	\$5384	+\$225	+\$792	+\$54	+\$190
E6C2478BGG	N.A.	1	\$6634	\$4797	\$5705	+\$245	+\$856	+\$82	+\$284
E6C2478DDB	3	5	\$6893	\$5023	\$5964	+\$245	+\$856	+\$82	+\$284
E6C2478DEB	3	3	\$6454	\$4928	\$5513	+\$225	+\$792	+\$54	+\$190
E6C2478DGB	1	3	\$6763	\$4909	\$5834	+\$245	+\$856	+\$82	+\$284
E6C2478EDB	3	3	\$6454	\$4928	\$5513	+\$225	+\$792	+\$54	+\$190
E6C2478EEB	3	1	\$6017	\$4834	\$5064	+\$207	+\$726	+\$28	+\$ 94
E6C2478EGB	1	1	\$6325	\$4815	\$5384	+\$225	+\$792	+\$54	+\$190
E6C2478GDB	2	3	\$6763	\$4909	\$5834	+\$245	+\$856	+\$82	+\$284
E6C2478GEB	2	1	\$6325	\$4815	\$5384	+\$225	+\$792	+\$54	+\$190
E6C2478GGB	N.A.	1	\$6634	\$4797	\$5705	+\$245	+\$856	+\$82	+\$284
E6C2478DBE	3	3	\$6454	\$4928	\$5513	+\$225	+\$792	+\$54	+\$190
E6C2478DBG	2	3	\$6763	\$4909	\$5834	+\$245	+\$856	+\$82	+\$284
E6C2478EBD	3	3	\$6454	\$4928	\$5513	+\$225	+\$792	+\$54	+\$190
E6C2478EBG	2	1	\$6325	\$4815	\$5384	+\$225	+\$792	+\$54	+\$190
E6C2478GBD	2	3	\$6763	\$4909	\$5834	+\$245	+\$856	+\$82	+\$284
E6C2478GBE	2	1	\$6325	\$4815	\$5384	+\$225	+\$792	+\$54	+\$190

► Specification Information, continued on next page

24"D x 78"W Leg Base 27½"H Credenzas, Wood Veneer or Laminate, continued

SIN 711.2

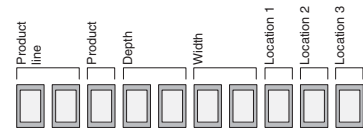

► Specification Information, continued from previous page

Specification Information

Tip: The location of the suffix within the style number determines the location of the storage unit within the credenza.

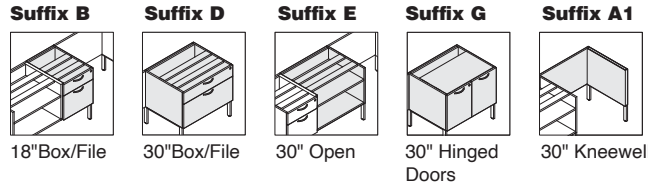

Style Number	Number of Tech Troughs	Counter-weight Package	Base Prices		Options (Add \$ to Base Price)				
			Wood Group 1 Case	Laminate Price Group 1 Case	Wood Case with Wood Front	Laminate Case with Wood Front	Wood Group 2	Wood Group 3	
			Wood Group 1 Front	Laminate Price Group 1 Front	Wood Group 1 Front or Open Front	Wood Group 2	Wood Group 3	Wood Group 2	Wood Group 3

30"W Kneewell with One 18"W Position and One 30"W Position

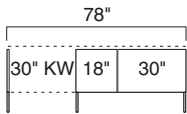

E6C2478A1BD	2	3	\$5133	\$3874	\$4459	+\$205	+\$714	+\$54	+\$190
E6C2478A1BE	2	1	\$4695	\$3778	\$4008	+\$187	+\$649	+\$28	+\$ 94
E6C2478A1BG	1	1	\$5003	\$3760	\$4329	+\$205	+\$714	+\$54	+\$190

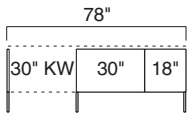

E6C2478A1DB	2	3	\$5133	\$3874	\$4459	+\$205	+\$714	+\$54	+\$190
E6C2478A1EB	2	1	\$4695	\$3778	\$4008	+\$187	+\$649	+\$28	+\$ 94
E6C2478A1GB	N.A.	1	\$5003	\$3760	\$4329	+\$205	+\$714	+\$54	+\$190

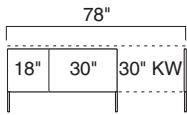

E6C2478BDA1	2	3	\$5133	\$3874	\$4459	+\$205	+\$714	+\$54	+\$190
E6C2478BEA1	2	1	\$4695	\$3778	\$4008	+\$187	+\$649	+\$28	+\$ 94
E6C2478BGA1	N.A.	1	\$5003	\$3760	\$4329	+\$205	+\$714	+\$54	+\$190

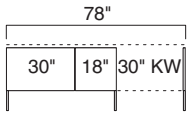

E6C2478DBA1	2	3	\$5133	\$3874	\$4459	+\$205	+\$714	+\$54	+\$190
E6C2478EBA1	2	1	\$4695	\$3778	\$4008	+\$187	+\$649	+\$28	+\$ 94
E6C2478GBA1	1	1	\$5003	\$3760	\$4329	+\$205	+\$714	+\$54	+\$190

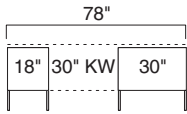

E6C2478BA1D	2	3	\$4831	\$3661	\$4246	+\$205	+\$714	+\$54	+\$190
E6C2478BA1E	2	1	\$4392	\$3564	\$3794	+\$187	+\$649	+\$28	+\$ 94
E6C2478BA1G	1	1	\$4701	\$3547	\$4116	+\$205	+\$714	+\$54	+\$190

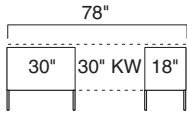

E6C2478DA1B	2	3	\$4831	\$3661	\$4246	+\$205	+\$714	+\$54	+\$190
E6C2478EA1B	2	1	\$4392	\$3564	\$3794	+\$187	+\$649	+\$28	+\$ 94
E6C2478GA1B	1	1	\$4701	\$3547	\$4116	+\$205	+\$714	+\$54	+\$190

► Specification Information, continued on next page

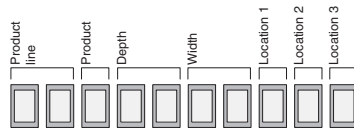

► Specification Information, continued from previous page

Specification Information

Tip: The location of the suffix within the style number determines the location of the storage unit within the credenza.

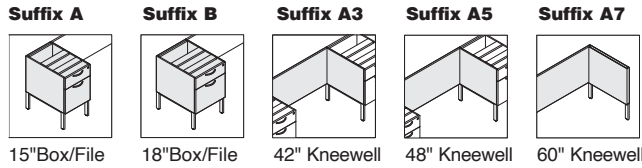

Style Number	Number of Tech Troughs	Counter-weight Package	Base Prices Wood Group 1 Case	Laminate Price Group 1 Case	Options (Add \$ to Base Price)
			Wood Group 1 Front	Laminate Price Group 1 Front	Wood Case with Wood Front
			Wood Group 2	Wood Group 3	Wood Group 2
					Laminate Case with Wood Front
					Wood Group 1 Front or Open Front
					Wood Group 3
					Wood Group 2
					Wood Group 3

Tip: 42"W and 48"W kneewell will always be centered within a 78"W credenza.

42"W Kneewell with Two 18"W Positions

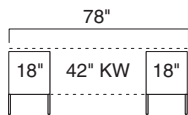

E6C2478BA3B	2	2	\$4419	\$3474	\$3934	+\$187	+\$652	+\$54	+\$190
--------------------	---	---	--------	--------	--------	--------	--------	-------	--------

48"W Kneewell with Two 15"W Positions

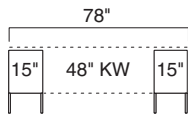

E6C2478AA5A	2	2	\$4127	\$3182	\$3642	+\$187	+\$652	+\$54	+\$190
--------------------	---	---	--------	--------	--------	--------	--------	-------	--------

60"W Kneewell with One 18"W Position

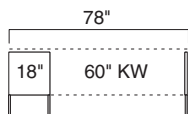

E6C2478BA7	1	1	\$3019	\$2457	\$2687	+\$118	+\$407	+\$28	+\$ 94
-------------------	---	---	--------	--------	--------	--------	--------	-------	--------

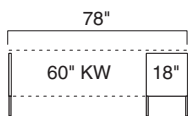

E6C2478A7B	1	1	\$3019	\$2457	\$2687	+\$118	+\$407	+\$28	+\$ 94
-------------------	---	---	--------	--------	--------	--------	--------	-------	--------

24"D x 84"W Leg Base 27½"H Credenzas

Wood Veneer or Laminate

SIN 711.2

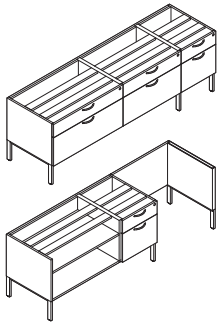

Tip: Storage legs may be shared with another leg base storage unit of the same depth.

Tip: When storage legs are shared between two units, the extra legs should be saved for later use, such as reconfiguration.

Tip: All credenzas with a kneewell ship knockdown.

For laminate price group 2 pricing, please refer to the electronic catalog or SmartTools.

Tip: Soft close drawer slides only apply to storage that has 15"W and 18"W drawers.

Tip: Soft close slides are available for both dovetail and miter fold construction.

Tip: Metal shelves only available in open or hinged door components.

Tip: Back panel is inset and spans entire width of credenza.

Tip: Technology trough not available in hinged door components.

Tip: Center or inside panels are always cut out if technology trough is specified to allow cords to pass between components.

Standard Includes	Required to Specify
-------------------	---------------------

- Underworksurface storage:
 - Wood group 1 case with wood group 1 front
 - Laminate price group 1 case with same or contrasting laminate front
 - Laminate price group 1 case with wood group 1 front
- Unfinished, inset back panel spanning full credenza
- Unfinished open top
- Storage leg; paint or metal
- Dovetail drawer construction
- Lock, keyed random
- Counterweight package
- Storage brace
- Standard close drawer slides

- 1 Style number with appropriate suffix to indicate location of storage units
 - 2 Wood or laminate color number for underworksurface storage
 - 3 Laminate color number for laminate fronts on laminate case, if selected
 - 4 Wood color number for wood fronts on laminate cases, if selected
 - 5 Pull shape (see below under Required Selections)
 - 6 Paint or metal color number for storage leg
 - 7 Finish color number for pull
 - 8 Finish color number for lock
 - 9 Options, if selected (see below)
- ▶ See *Surface Materials*, page 566.

Required Selections

Pull Shape

Contemporary	Jazz	Bar	Nile	Integral*	Transitional	Inset	Beam
No cost	+\$19 each	+\$26 each	+\$26 each	+\$26 each	+\$26 each	+\$26 each	+\$37 each

*Not available on laminate or composite fronts.

Options	Price	Required to Specify
---------	-------	---------------------

Surface Materials	Wood underworksurface storage case	<ul style="list-style-type: none"> • Wood group 2 • Wood group 3 • Customiz stain 	Prices at right Prices at right No cost	Specify wood color number. Specify wood color number. Specify with <i>Customiz stain</i> .
	Laminate underworksurface storage case	<ul style="list-style-type: none"> • Laminate price group 2 • Open Line laminate 	See information at left +\$ 69 plus cost of laminate	Specify laminate color number. ▶ See <i>Surface Materials Reference Manual</i> .
		<ul style="list-style-type: none"> • Wood group 2 on wood fronts • Wood group 3 on wood fronts • Customiz stain 	Prices at right Prices at right No cost	Specify wood color number. Specify wood color number. Specify with <i>Customiz stain</i> .
Drawer Slide	• Soft close drawer slides		+\$ 30 per drawer	Specify with <i>soft close drawers</i> .
Lock and Keying	Lock	<ul style="list-style-type: none"> • Ember chrome • Polished chrome 	No cost No cost	Specify with <i>9250 Ember Chrome lock</i> . Specify with <i>9201 Polished Chrome lock</i> .
	Keying	• Factory- and field-installed keying units		▶ Page 622
Shelves	<ul style="list-style-type: none"> • ¾" shelf • Metal shelf 		No cost –\$ 26 per shelf	Specify with <i>¾" shelf</i> . Specify with <i>metal shelf</i> and select paint color number.
Counterweight Package	<ul style="list-style-type: none"> • Counterweight package • Omit counterweight package 		No cost –\$ 65 each	Specify with <i>counterweight package</i> . Specify with <i>no counterweight package</i> .
Back Panel	• Laminate full length back panel		+\$217	Specify with <i>laminate finished back panel</i> .
	• Wood full length back panel		+\$436	Specify with <i>wood finished back panel</i> .
Technology Trough	• Technology trough for power and data routing: black		+\$ 57 each	Specify with <i>technology trough</i> .
Cut-Out	• Right side only		No cost	Specify with <i>right cut-out</i> .
	• Left side only		No cost	Specify with <i>left cut-out</i> .
	• Both sides		No cost	Specify with <i>both cut-outs</i> .
	• No cut-outs		No cost	Specify with <i>no cut-outs</i> .
	• Kneewell		No cost	Specify with <i>kneewell cut-outs</i> .

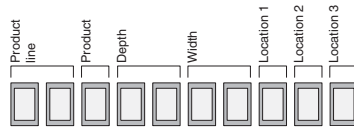

Tip: The location of the suffix within the style number determines the location of the storage unit within the credenza.

Specification Information

Suffix B	Suffix D	Suffix E	Suffix G	Suffix I	Suffix J	Suffix L
18" Box/File	30" Box/File	30" Open	30" Hinged Doors	36" Box/File	36" Open	36" Hinged Doors

Style Number	Number of Tech Troughs	Counter-weight Package	Base Prices		Options (Add \$ to Base Price)				
			Wood Group 1 Case	Laminate Price Group 1 Case	Wood Case with Wood Front	Laminate Case with Wood Front			
			Wood Group 1 Front	Laminate Price Group 1 Front	Wood Group 1 Front or Open Front	Wood Group 2	Wood Group 3	Wood Group 2	Wood Group 3

Full Storage: One 18"W Position, One 30"W Position, and One 36"W Position

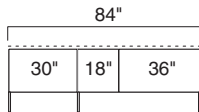
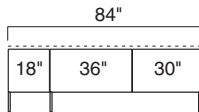
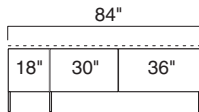

E6C2484BDI	3	5	\$7368	\$5498	\$6439	+\$245	+\$856	+\$82	+\$284
E6C2484BDJ	3	3	\$6607	\$5081	\$5666	+\$225	+\$792	+\$54	+\$190
E6C2484BDL	2	3	\$6885	\$5031	\$5956	+\$245	+\$856	+\$82	+\$284
E6C2484BEI	3	3	\$6930	\$5404	\$5989	+\$225	+\$792	+\$54	+\$190
E6C2484BEJ	3	1	\$6169	\$4986	\$5216	+\$207	+\$726	+\$28	+\$ 94
E6C2484BEL	2	1	\$6446	\$4936	\$5505	+\$225	+\$792	+\$54	+\$190
E6C2484BGI	1	3	\$7239	\$5385	\$6310	+\$245	+\$856	+\$82	+\$284
E6C2484BGJ	1	1	\$6478	\$4968	\$5537	+\$225	+\$792	+\$54	+\$190
E6C2484BGL	N.A.	1	\$6755	\$4918	\$5826	+\$245	+\$856	+\$82	+\$284
E6C2484BID	3	5	\$7368	\$5498	\$6439	+\$245	+\$856	+\$82	+\$284
E6C2484BIE	3	3	\$6930	\$5404	\$5989	+\$225	+\$792	+\$54	+\$190
E6C2484BIG	2	3	\$7239	\$5385	\$6310	+\$245	+\$856	+\$82	+\$284
E6C2484BJD	3	3	\$6607	\$5081	\$5666	+\$225	+\$792	+\$54	+\$190
E6C2484BJE	3	1	\$6169	\$4986	\$5216	+\$207	+\$726	+\$28	+\$ 94
E6C2484BJG	2	1	\$6478	\$4968	\$5537	+\$225	+\$792	+\$54	+\$190
E6C2484BLD	1	3	\$6885	\$5031	\$5956	+\$245	+\$856	+\$82	+\$284
E6C2484BLE	1	1	\$6446	\$4936	\$5505	+\$225	+\$792	+\$54	+\$190
E6C2484BLG	N.A.	1	\$6755	\$4918	\$5826	+\$245	+\$856	+\$82	+\$284
E6C2484DBJ	3	3	\$6607	\$5081	\$5666	+\$225	+\$792	+\$54	+\$190
E6C2484DBL	2	3	\$6885	\$5031	\$5956	+\$245	+\$856	+\$82	+\$284
E6C2484EBI	3	3	\$6930	\$5404	\$5989	+\$225	+\$792	+\$54	+\$190
E6C2484EBL	2	1	\$6446	\$4936	\$5505	+\$225	+\$792	+\$54	+\$190
E6C2484GBI	2	3	\$7239	\$5385	\$6310	+\$245	+\$856	+\$82	+\$284
E6C2484GBJ	2	1	\$6478	\$4968	\$5537	+\$225	+\$792	+\$54	+\$190

► Specification Information, continued on next page

24"D x 84"W Leg Base 27½"H Credenzas, Wood Veneer or Laminate, continued

SIN 711.2

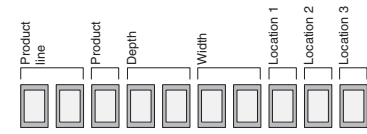

► Specification Information, continued from previous page

Specification Information

Tip: The location of the suffix within the style number determines the location of the storage unit within the credenza.

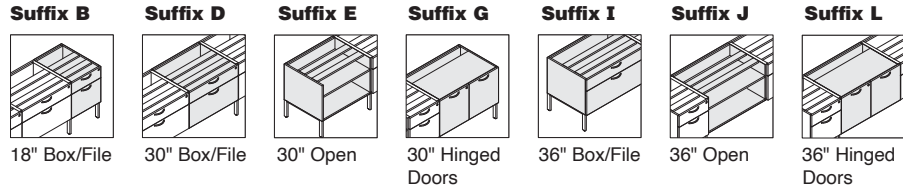

Style Number	Number of Tech Troughs	Counter-weight Package	Base Prices		Options (Add \$ to Base Price)			
			Wood Group 1 Case	Laminate Price Group 1 Case	Wood Group 1 Front or Open Front	Wood Case with Wood Front	Laminate Case with Wood Front	Wood Group 2

Full Storage: One 18"W Position, One 30"W Position, and One 36"W Position, continued

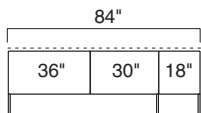
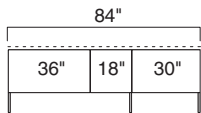
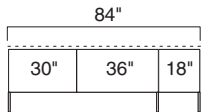

E6C2484DIB	3	5	\$7368	\$5498	\$6439	+\$245	+\$856	+\$82	+\$284
E6C2484DJB	3	3	\$6607	\$5081	\$5666	+\$225	+\$792	+\$54	+\$190
E6C2484DLB	1	3	\$6885	\$5031	\$5956	+\$245	+\$856	+\$82	+\$284
E6C2484EIB	3	3	\$6930	\$5404	\$5989	+\$225	+\$792	+\$54	+\$190
E6C2484EJB	3	1	\$6169	\$4986	\$5216	+\$207	+\$726	+\$28	+\$ 94
E6C2484ELB	1	1	\$6446	\$4936	\$5505	+\$225	+\$792	+\$54	+\$190
E6C2484GIB	2	3	\$7239	\$5385	\$6310	+\$245	+\$856	+\$82	+\$284
E6C2484GJB	2	1	\$6478	\$4968	\$5537	+\$225	+\$792	+\$54	+\$190
E6C2484GLB	N.A.	1	\$6755	\$4918	\$5826	+\$245	+\$856	+\$82	+\$284
E6C2484IBE	3	3	\$6930	\$5404	\$5989	+\$225	+\$792	+\$54	+\$190
E6C2484IBG	2	3	\$7239	\$5385	\$6310	+\$245	+\$856	+\$82	+\$284
E6C2484JBD	3	3	\$6607	\$5081	\$5666	+\$225	+\$792	+\$54	+\$190
E6C2484JBG	2	1	\$6478	\$4968	\$5537	+\$225	+\$792	+\$54	+\$190
E6C2484LBD	2	3	\$6885	\$5031	\$5956	+\$245	+\$856	+\$82	+\$284
E6C2484LBE	2	1	\$6446	\$4936	\$5505	+\$225	+\$792	+\$54	+\$190
E6C2484IDB	3	5	\$7368	\$5498	\$6439	+\$245	+\$856	+\$82	+\$284
E6C2484IEB	3	3	\$6930	\$5404	\$5989	+\$225	+\$792	+\$54	+\$190
E6C2484IGB	1	3	\$7239	\$5385	\$6310	+\$245	+\$856	+\$82	+\$284
E6C2484JDB	3	3	\$6607	\$5081	\$5666	+\$225	+\$792	+\$54	+\$190
E6C2484JEB	3	1	\$6169	\$4986	\$5216	+\$207	+\$726	+\$28	+\$ 94
E6C2484JGB	1	1	\$6478	\$4968	\$5537	+\$225	+\$792	+\$54	+\$190
E6C2484LDB	2	3	\$6885	\$5031	\$5956	+\$245	+\$856	+\$82	+\$284
E6C2484LEB	2	1	\$6446	\$4936	\$5505	+\$225	+\$792	+\$54	+\$190
E6C2484LGB	N.A.	1	\$6755	\$4918	\$5826	+\$245	+\$856	+\$82	+\$284

► Specification Information, continued on next page

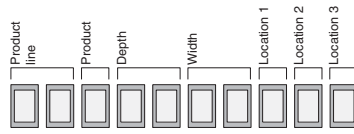

► Specification Information, continued from previous page

Specification Information

Suffix B	Suffix I	Suffix J	Suffix L	Suffix A1
18" Box/File	36" Box/File	36" Open	36" Hinged Doors	30" Kneewell

Tip: The location of the suffix within the style number determines the location of the storage unit within the credenza.

Style Number	Number of Tech Troughs	Counter-weight Package	Base Prices		Options (Add \$ to Base Price)				
			Wood Group 1 Case	Laminate Price Group 1 Case	Wood Case with Wood Front	Laminate Case with Wood Front			
			Wood Group 1 Front	Laminate Price Group 1 Front	Wood Group 1 Front or Open Front	Wood Group 2	Wood Group 3	Wood Group 2	Wood Group 3

30"W Kneewell with One 18"W Position and One 36"W Position

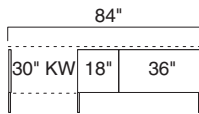

E6C2484A1BI	2	3	\$5608	\$4349	\$4934	+\$205	+\$714	+\$54	+\$190
E6C2484A1BJ	2	1	\$4847	\$3930	\$4160	+\$187	+\$649	+\$28	+\$ 94
E6C2484A1BL	1	1	\$5125	\$3882	\$4451	+\$205	+\$714	+\$54	+\$190

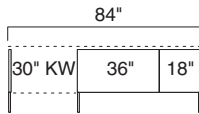

E6C2484A1IB	2	3	\$5608	\$4349	\$4934	+\$205	+\$714	+\$54	+\$190
E6C2484A1JB	2	1	\$4847	\$3930	\$4160	+\$187	+\$649	+\$28	+\$ 94
E6C2484A1LB	N.A.	1	\$5125	\$3882	\$4451	+\$205	+\$714	+\$54	+\$190

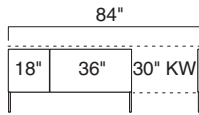

E6C2484BIA1	2	3	\$5608	\$4349	\$4934	+\$205	+\$714	+\$54	+\$190
E6C2484BJA1	2	1	\$4847	\$3930	\$4160	+\$187	+\$649	+\$28	+\$ 94
E6C2484BLA1	N.A.	1	\$5125	\$3882	\$4451	+\$205	+\$714	+\$54	+\$190

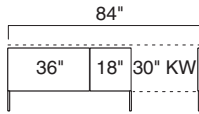

E6C2484IBA1	2	3	\$5608	\$4349	\$4934	+\$205	+\$714	+\$54	+\$190
E6C2484JBA1	2	1	\$4847	\$3930	\$4160	+\$187	+\$649	+\$28	+\$ 94
E6C2484LBA1	1	1	\$5125	\$3882	\$4451	+\$205	+\$714	+\$54	+\$190

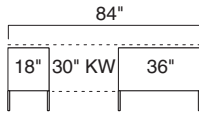

E6C2484BA1I	2	3	\$5305	\$4135	\$4720	+\$205	+\$714	+\$54	+\$190
E6C2484BA1J	2	1	\$4545	\$3717	\$3947	+\$187	+\$649	+\$28	+\$ 94
E6C2484BA1L	1	1	\$4823	\$3669	\$4238	+\$205	+\$714	+\$54	+\$190

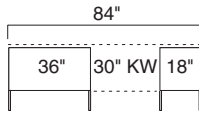

E6C2484IA1B	2	3	\$5305	\$4135	\$4720	+\$205	+\$714	+\$54	+\$190
E6C2484JA1B	2	1	\$4545	\$3717	\$3947	+\$187	+\$649	+\$28	+\$ 94
E6C2484LA1B	1	1	\$4823	\$3669	\$4238	+\$205	+\$714	+\$54	+\$190

► Specification Information, continued on next page

24"D x 84"W Leg Base 27½"H Credenzas, Wood Veneer or Laminate, continued

SIN 711.2

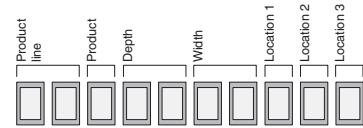

► Specification Information, continued from previous page

Specification Information

Tip: The location of the suffix within the style number determines the location of the storage unit within the credenza.

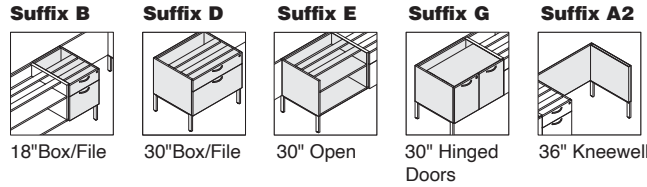

Style Number	Number of Tech Troughs	Counter-weight Package	Base Prices		Options (Add \$ to Base Price)				
			Wood Group 1 Case	Laminate Price Group 1 Case	Wood Case with Wood Front	Laminate Case with Wood Front	Wood Group 2	Wood Group 3	
			Wood Group 1 Front	Laminate Price Group 1 Front	Wood Group 1 Front or Open Front	Wood Group 2	Wood Group 3	Wood Group 2	Wood Group 3

36"W Kneewell with One 18"W Position and One 30"W Position

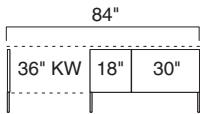

E6C2484A2BD	2	3	\$5195	\$3936	\$4521	+\$205	+\$714	+\$54	+\$190
E6C2484A2BE	2	1	\$4757	\$3840	\$4070	+\$187	+\$649	+\$28	+\$ 94
E6C2484A2BG	1	1	\$5066	\$3823	\$4392	+\$205	+\$714	+\$54	+\$190

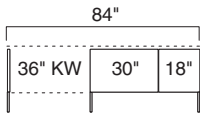

E6C2484A2DB	2	3	\$5195	\$3936	\$4521	+\$205	+\$714	+\$54	+\$190
E6C2484A2EB	2	1	\$4757	\$3840	\$4070	+\$187	+\$649	+\$28	+\$ 94
E6C2484A2GB	N.A.	1	\$5066	\$3823	\$4392	+\$205	+\$714	+\$54	+\$190

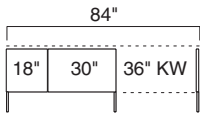

E6C2484BDA2	2	3	\$5195	\$3936	\$4521	+\$205	+\$714	+\$54	+\$190
E6C2484BEA2	2	1	\$4757	\$3840	\$4070	+\$187	+\$649	+\$28	+\$ 94
E6C2484BGA2	N.A.	1	\$5066	\$3823	\$4392	+\$205	+\$714	+\$54	+\$190

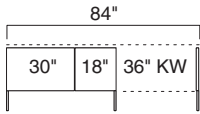

E6C2484DBA2	2	3	\$5195	\$3936	\$4521	+\$205	+\$714	+\$54	+\$190
E6C2484EBA2	2	1	\$4757	\$3840	\$4070	+\$187	+\$649	+\$28	+\$ 94
E6C2484GBA2	1	1	\$5066	\$3823	\$4392	+\$205	+\$714	+\$54	+\$190

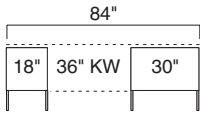

E6C2484BA2D	2	3	\$4892	\$3722	\$4307	+\$205	+\$714	+\$54	+\$190
E6C2484BA2E	2	1	\$4455	\$3627	\$3857	+\$187	+\$649	+\$28	+\$ 94
E6C2484BA2G	1	1	\$4763	\$3609	\$4178	+\$205	+\$714	+\$54	+\$190

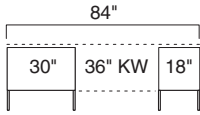

E6C2484DA2B	2	3	\$4892	\$3722	\$4307	+\$205	+\$714	+\$54	+\$190
E6C2484EA2B	2	1	\$4455	\$3627	\$3857	+\$187	+\$649	+\$28	+\$ 94
E6C2484GA2B	1	1	\$4763	\$3609	\$4178	+\$205	+\$714	+\$54	+\$190

► Specification Information, continued on next page

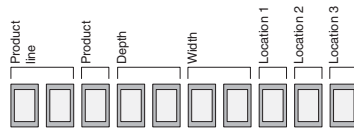

► Specification Information, continued from previous page

Specification Information

Suffix A	Suffix B	Suffix D	Suffix E	Suffix G	Suffix A5	Suffix A6	Suffix A8
15" Box/File	18" Box/File	30" Box/File	30" Open	30" Hinged Doors	48" Kneewell	54" Kneewell	66" Kneewell

Tip: The location of the suffix within the style number determines the location of the storage unit within the credenza.

Style Number	Number of Tech Troughs	Counter-weight Package	Base Prices			Options (Add \$ to Base Price)				
			Wood Group 1 Case	Laminate Price Group 1 Front	Wood Group 1 Front or Open Front	Wood Case with Wood Front	Laminate Case with Wood Front	Wood Group 2	Wood Group 3	

Tip: 48"W kneewell will always be centered within a 84"W credenza.

48"W Kneewell with Two 18"W Positions

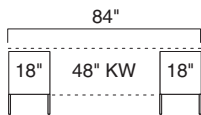

E6C2484BA5B	2	2	\$4480	\$3535	\$3995	+\$187	+\$652	+\$54	+\$190
--------------------	---	---	--------	--------	--------	--------	--------	-------	--------

54"W Kneewell with Two 15"W Positions

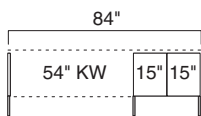

E6C2484A6AA	2	2	\$4491	\$3457	\$3917	+\$242	+\$842	+\$54	+\$190
--------------------	---	---	--------	--------	--------	--------	--------	-------	--------

E6C2484AAA6	2	2	\$4491	\$3457	\$3917	+\$242	+\$842	+\$54	+\$190
--------------------	---	---	--------	--------	--------	--------	--------	-------	--------

54"W Kneewell with One 30"W Position

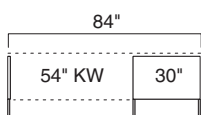

E6C2484A6D	1	2	\$3493	\$2704	\$3060	+\$162	+\$563	+\$28	+\$94
-------------------	---	---	--------	--------	--------	--------	--------	-------	-------

E6C2484A6E	1	N.A.	\$3056	N.A.	\$2611	+\$116	+\$406	N.A.	N.A.
-------------------	---	------	--------	------	--------	--------	--------	------	------

E6C2484A6G	N.A.	N.A.	\$3363	\$2591	\$2930	+\$162	+\$563	+\$28	+\$94
-------------------	------	------	--------	--------	--------	--------	--------	-------	-------

E6C2484DA6	1	2	\$3493	\$2704	\$3060	+\$162	+\$563	+\$28	+\$94
-------------------	---	---	--------	--------	--------	--------	--------	-------	-------

E6C2484EA6	1	N.A.	\$3056	N.A.	\$2611	+\$116	+\$406	N.A.	N.A.
-------------------	---	------	--------	------	--------	--------	--------	------	------

E6C2484GA6	N.A.	N.A.	\$3363	\$2591	\$2930	+\$162	+\$563	+\$28	+\$94
-------------------	------	------	--------	--------	--------	--------	--------	-------	-------

66"W Kneewell with One 18"W Position

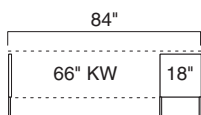

E6C2484A8B	1	1	\$3081	\$2519	\$2749	+\$118	+\$407	+\$28	+\$94
-------------------	---	---	--------	--------	--------	--------	--------	-------	-------

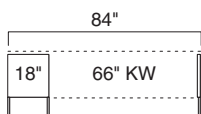

E6C2484BA8	1	1	\$3081	\$2519	\$2749	+\$118	+\$407	+\$28	+\$94
-------------------	---	---	--------	--------	--------	--------	--------	-------	-------

24"D x 90"W Leg Base 27½"H Credenzas

Wood Veneer or Laminate

SIN 711.2

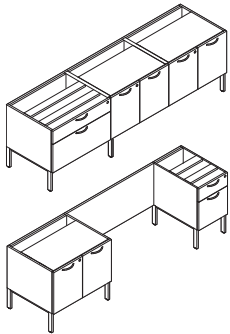

Tip: Storage legs may be shared with another leg base storage unit of the same depth.

Tip: When storage legs are shared between two units, the extra legs should be saved for later use, such as reconfiguration.

Tip: All credenzas with a kneewell ship knockdown.

For laminate price group 2 pricing, please refer to the electronic catalog or SmartTools.

Tip: Soft close drawer slides only apply to storage that has 15"W and 18"W drawers.

Tip: Soft close slides are available for both dovetail and miter fold construction.

Tip: Metal shelves only available in open or hinged door components.

Tip: Back panel is inset and spans entire width of credenza.

Tip: Technology trough not available in hinged door components.

Tip: Center or inside panels are always cut out if technology trough is specified to allow cords to pass between components.

Standard Includes	Required to Specify
<ul style="list-style-type: none"> Underworksurface storage: <ul style="list-style-type: none"> Wood group 1 case with wood group 1 front Laminate price group 1 case with same or contrasting laminate front Laminate price group 1 case with wood group 1 front Unfinished, inset back panel spanning full credenza Unfinished open top Storage leg; paint or metal Dovetail drawer construction Lock, keyed random Counterweight package Storage brace Standard close drawer slides 	<ol style="list-style-type: none"> Style number with appropriate suffix to indicate location of storage units Wood or laminate color number for underworksurface storage Laminate color number for laminate fronts on laminate case, if selected Wood color number for wood fronts on laminate cases, if selected Pull shape (see below under Required Selections) Paint or metal color number for storage leg Finish color number for pull Finish color number for lock Options, if selected (see below) <p>▶ See <i>Surface Materials</i>, page 566.</p>

Required Selections							
Pull Shape							
Contemporary	Jazz	Bar	Nile	Integral*	Transitional	Inset	Beam
No cost	+\$19 each	+\$26 each	+\$26 each	+\$26 each	+\$26 each	+\$26 each	+\$37 each

*Not available on laminate or composite fronts.

Options	Price	Required to Specify
Surface Materials <ul style="list-style-type: none"> Wood underworksurface storage case <ul style="list-style-type: none"> Wood group 2 Wood group 3 Customiz stain Laminate underworksurface storage case <ul style="list-style-type: none"> Laminate price group 2 Open Line laminate Wood group 2 on wood fronts Wood group 3 on wood fronts Customiz stain 	<ul style="list-style-type: none"> Prices at right Prices at right No cost See information at left +\$ 69 plus cost of laminate Prices at right Prices at right No cost 	<ul style="list-style-type: none"> Specify wood color number. Specify wood color number. Specify with <i>Customiz stain</i>. Specify laminate color number. ▶ See <i>Surface Materials Reference Manual</i>. Specify wood color number. Specify wood color number. Specify with <i>Customiz stain</i>.
Drawer Slide <ul style="list-style-type: none"> Soft close drawer slides 	<ul style="list-style-type: none"> +\$ 30 per drawer 	<ul style="list-style-type: none"> Specify with <i>soft close drawers</i>.
Lock and Keying <ul style="list-style-type: none"> Lock <ul style="list-style-type: none"> Ember chrome Polished chrome Keying <ul style="list-style-type: none"> Factory- and field-installed keying units 	<ul style="list-style-type: none"> No cost No cost 	<ul style="list-style-type: none"> Specify with <i>9250 Ember Chrome lock</i>. Specify with <i>9201 Polished Chrome lock</i>. ▶ Page 622
Shelves <ul style="list-style-type: none"> ¾" shelf Metal shelf 	<ul style="list-style-type: none"> No cost -\$ 26 per shelf 	<ul style="list-style-type: none"> Specify with <i>¾" shelf</i>. Specify with <i>metal shelf</i> and select paint color number.
Counterweight Package <ul style="list-style-type: none"> Counterweight package Omit counterweight package 	<ul style="list-style-type: none"> No cost -\$ 65 each 	<ul style="list-style-type: none"> Specify with <i>counterweight package</i>. Specify with <i>no counterweight package</i>.
Back Panel <ul style="list-style-type: none"> Laminate full length back panel Wood full length back panel 	<ul style="list-style-type: none"> +\$233 +\$466 	<ul style="list-style-type: none"> Specify with <i>laminate finished back panel</i>. Specify with <i>wood finished back panel</i>.
Technology Trough <ul style="list-style-type: none"> Technology trough for power and data routing: black 	<ul style="list-style-type: none"> +\$ 57 each 	<ul style="list-style-type: none"> Specify with <i>technology trough</i>.
Cut-Out <ul style="list-style-type: none"> Right side only Left side only Both sides No cut-outs Kneewell 	<ul style="list-style-type: none"> No cost No cost No cost No cost No cost 	<ul style="list-style-type: none"> Specify with <i>right cut-out</i>. Specify with <i>left cut-out</i>. Specify with <i>both cut-outs</i>. Specify with <i>no cut-outs</i>. Specify with <i>kneewell cut-outs</i>.

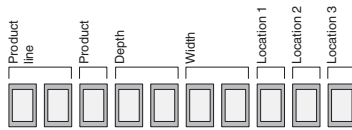

Tip: The location of the suffix within the style number determines the location of the storage unit within the credenza.

Specification Information

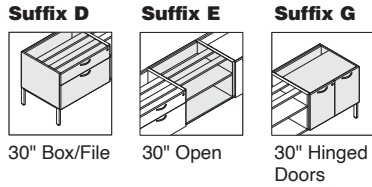

Style Number	Number of Tech Troughs	Counter-weight Package	Base Prices			Options (Add \$ to Base Price)				
			Wood Group 1 Case	Laminate Price Group 1 Case	Wood Group 1 Front	Laminate Price Group 1 Front	Wood Group 1 Front or Open Front	Wood Case with Wood Front	Laminate Case with Wood Front	Wood Group 2

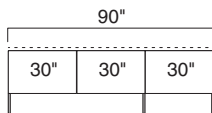

Full Storage: Three 30"W Positions

Style Number	Number of Tech Troughs	Counter-weight Package	Wood Group 1 Case	Laminate Price Group 1 Case	Wood Group 1 Front	Laminate Price Group 1 Front	Wood Group 1 Front or Open Front	Wood Case with Wood Front	Laminate Case with Wood Front	Wood Group 2	Wood Group 3
E6C2490DDD	3	6	\$7429	\$5334	\$6400	+\$261	+\$917	+\$82	+\$284		
E6C2490DDE	3	4	\$6992	\$5242	\$5952	+\$242	+\$854	+\$54	+\$190		
E6C2490DEE	3	2	\$6553	\$5143	\$5499	+\$225	+\$789	+\$28	+\$ 94		
E6C2490DGE	2	2	\$6861	\$5127	\$5821	+\$242	+\$854	+\$54	+\$190		
E6C2490DDG	2	4	\$7300	\$5221	\$6271	+\$261	+\$917	+\$82	+\$284		
E6C2490DEG	2	2	\$6861	\$5127	\$5821	+\$242	+\$854	+\$54	+\$190		
E6C2490DGG	1	2	\$7170	\$5108	\$6141	+\$261	+\$917	+\$82	+\$284		
E6C2490EDD	3	4	\$6992	\$5242	\$5952	+\$242	+\$854	+\$54	+\$190		
E6C2490EED	3	2	\$6553	\$5143	\$5499	+\$225	+\$789	+\$28	+\$ 94		
E6C2490EGD	2	2	\$6861	\$5127	\$5821	+\$242	+\$854	+\$54	+\$190		
E6C2490EEE	3	N.A.	\$6115	N.A.	\$5049	+\$205	+\$725	N.A.	N.A.		
E6C2490EDG	2	2	\$6861	\$5127	\$5821	+\$242	+\$854	+\$54	+\$190		
E6C2490EEG	2	N.A.	\$6424	\$5031	\$5370	+\$225	+\$789	+\$28	+\$ 94		
E6C2490EGG	1	N.A.	\$6732	\$5014	\$5692	+\$242	+\$854	+\$54	+\$190		
E6C2490GDD	2	4	\$7300	\$5221	\$6271	+\$261	+\$917	+\$82	+\$284		
E6C2490GED	2	2	\$6861	\$5127	\$5821	+\$242	+\$854	+\$54	+\$190		
E6C2490GGD	1	2	\$7170	\$5108	\$6141	+\$261	+\$917	+\$82	+\$284		
E6C2490GDE	2	2	\$6861	\$5127	\$5821	+\$242	+\$854	+\$54	+\$190		
E6C2490GEE	2	N.A.	\$6424	\$5031	\$5370	+\$225	+\$789	+\$28	+\$ 94		
E6C2490GGE	1	N.A.	\$6732	\$5014	\$5692	+\$242	+\$854	+\$54	+\$190		
E6C2490GGG	N.A.	N.A.	\$7041	\$4995	\$6012	+\$261	+\$917	+\$82	+\$284		

► Specification Information, continued on next page

24"D x 90"W Leg Base 27½"H Credenzas, Wood Veneer or Laminate, continued

SIN 711.2

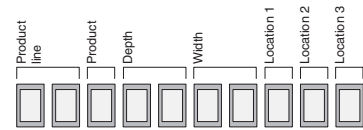

► Specification Information, continued from previous page

Specification Information

Tip: The location of the suffix within the style number determines the location of the storage unit within the credenza.

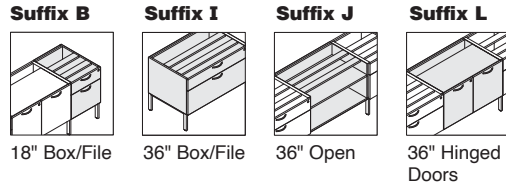

Style Number	Number of Tech Troughs	Counter-weight Package	Base Prices		Options (Add \$ to Base Price)			
			Wood Group 1 Case	Laminate Price Group 1 Case	Wood Case with Wood Front	Laminate Case with Wood Front	Wood Group 2	Wood Group 3

Full Storage: One 18"W Position and Two 36"W Positions

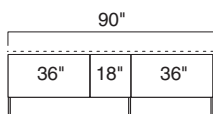
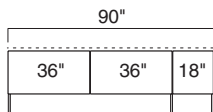
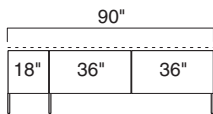

E6C2490BII	3	5	\$7843	\$5973	\$6914	+\$245	+\$856	+\$82	+\$284
E6C2490BIJ	3	3	\$7082	\$5556	\$6141	+\$225	+\$792	+\$54	+\$190
E6C2490BIL	2	3	\$7360	\$5506	\$6431	+\$245	+\$856	+\$82	+\$284
E6C2490BJI	3	3	\$7082	\$5556	\$6141	+\$225	+\$792	+\$54	+\$190
E6C2490BJJ	3	1	\$6321	\$5138	\$5368	+\$207	+\$726	+\$28	+\$ 94
E6C2490BJL	2	1	\$6599	\$5089	\$5658	+\$213	+\$745	+\$54	+\$190
E6C2490BLI	1	3	\$7360	\$5506	\$6431	+\$245	+\$856	+\$82	+\$284
E6C2490BLJ	1	1	\$6599	\$5089	\$5658	+\$213	+\$745	+\$54	+\$190
E6C2490BLL	N.A.	1	\$6876	\$5039	\$5947	+\$245	+\$856	+\$82	+\$284
E6C2490IIB	3	5	\$7843	\$5973	\$6914	+\$245	+\$856	+\$82	+\$284
E6C2490IJB	3	3	\$7082	\$5556	\$6141	+\$225	+\$792	+\$54	+\$190
E6C2490ILB	1	3	\$7360	\$5506	\$6431	+\$245	+\$856	+\$82	+\$284
E6C2490JIB	3	3	\$7082	\$5556	\$6141	+\$225	+\$792	+\$54	+\$190
E6C2490JJB	3	1	\$6321	\$5138	\$5368	+\$207	+\$726	+\$28	+\$ 94
E6C2490JLB	1	1	\$6599	\$5089	\$5658	+\$213	+\$745	+\$54	+\$190
E6C2490LIB	2	3	\$7360	\$5506	\$6431	+\$245	+\$856	+\$82	+\$284
E6C2490LJB	2	1	\$6599	\$5089	\$5658	+\$213	+\$745	+\$54	+\$190
E6C2490LLB	N.A.	1	\$6876	\$5039	\$5947	+\$245	+\$856	+\$82	+\$284
E6C2490IBJ	3	3	\$7082	\$5556	\$6141	+\$225	+\$792	+\$54	+\$190
E6C2490IBL	2	3	\$7360	\$5506	\$6431	+\$245	+\$856	+\$82	+\$284
E6C2490JBI	3	3	\$7082	\$5556	\$6141	+\$225	+\$792	+\$54	+\$190
E6C2490JBL	2	1	\$6599	\$5089	\$5658	+\$213	+\$745	+\$54	+\$190
E6C2490LBI	2	3	\$7360	\$5506	\$6431	+\$245	+\$856	+\$82	+\$284
E6C2490LBJ	2	1	\$6599	\$5089	\$5658	+\$213	+\$745	+\$54	+\$190

► Specification Information, continued on next page

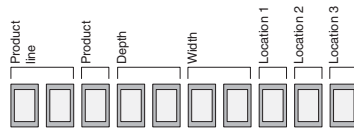

► Specification Information, continued from previous page

Specification Information

Tip: The location of the suffix within the style number determines the location of the storage unit within the credenza.

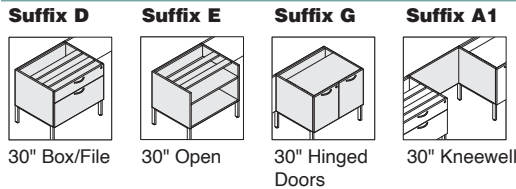

Style Number	Number of Tech Troughs	Counter-weight Package	Base Prices		Options (Add \$ to Base Price)				
			Wood Group 1 Case	Laminate Price Group 1 Case	Wood Case with Wood Front	Laminate Case with Wood Front			
			Wood Group 1 Front	Laminate Price Group 1 Front	Wood Group 1 Front or Open Front	Wood Group 2	Wood Group 3	Wood Group 2	Wood Group 3

30"W Kneewell with Two 30"W Positions

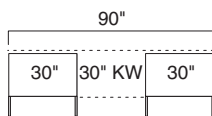
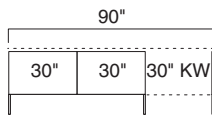
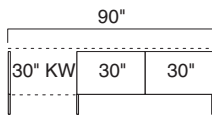

E6C2490A1DD	2	4	\$5669	\$4184	\$4894	+\$221	+\$776	+\$54	+\$190
E6C2490A1DE	2	2	\$5232	\$4089	\$4445	+\$203	+\$711	+\$28	+\$ 94
E6C2490A1DG	1	2	\$5540	\$4071	\$4765	+\$221	+\$776	+\$54	+\$190
E6C2490A1ED	2	2	\$5232	\$4089	\$4445	+\$203	+\$711	+\$28	+\$ 94
E6C2490A1EE	2	N.A.	\$4793	N.A.	\$4082	+\$183	+\$647	N.A.	N.A.
E6C2490A1EG	1	N.A.	\$5101	\$3975	\$4314	+\$203	+\$711	+\$28	+\$ 94
E6C2490A1GD	1	2	\$5540	\$4071	\$4765	+\$221	+\$776	+\$54	+\$190
E6C2490A1GE	1	N.A.	\$5101	\$3975	\$4314	+\$203	+\$711	+\$28	+\$ 94
E6C2490A1GG	N.A.	N.A.	\$5410	\$3957	\$4635	+\$221	+\$776	+\$54	+\$190
E6C2490DDA1	2	4	\$5669	\$4184	\$4894	+\$221	+\$776	+\$54	+\$190
E6C2490DEA1	2	2	\$5232	\$4089	\$4445	+\$203	+\$711	+\$28	+\$ 94
E6C2490DGA1	1	2	\$5540	\$4071	\$4765	+\$221	+\$776	+\$54	+\$190
E6C2490EDA1	2	2	\$5232	\$4089	\$4445	+\$203	+\$711	+\$28	+\$ 94
E6C2490EEA1	2	N.A.	\$4793	N.A.	\$4082	+\$183	+\$647	N.A.	N.A.
E6C2490EGA1	1	N.A.	\$5101	\$3975	\$4314	+\$203	+\$711	+\$28	+\$ 94
E6C2490GDA1	1	2	\$5540	\$4071	\$4765	+\$221	+\$776	+\$54	+\$190
E6C2490GEA1	1	N.A.	\$5101	\$3975	\$4314	+\$203	+\$711	+\$28	+\$ 94
E6C2490GGA1	N.A.	N.A.	\$5410	\$3957	\$4635	+\$221	+\$776	+\$54	+\$190
E6C2490DA1D	2	4	\$5367	\$3971	\$4681	+\$221	+\$776	+\$54	+\$190
E6C2490DA1E	2	2	\$4929	\$3875	\$4231	+\$203	+\$711	+\$28	+\$ 94
E6C2490DA1G	1	2	\$5238	\$3858	\$4552	+\$221	+\$776	+\$54	+\$190
E6C2490EA1D	2	2	\$4929	\$3875	\$4231	+\$203	+\$711	+\$28	+\$ 94
E6C2490EA1E	2	N.A.	\$4491	N.A.	\$3780	+\$183	+\$647	N.A.	N.A.
E6C2490EA1G	1	N.A.	\$4799	\$3762	\$4101	+\$203	+\$711	+\$28	+\$ 94
E6C2490GA1D	1	2	\$5238	\$3858	\$4552	+\$221	+\$776	+\$54	+\$190
E6C2490GA1E	1	N.A.	\$4799	\$3762	\$4101	+\$203	+\$711	+\$28	+\$ 94
E6C2490GA1G	N.A.	N.A.	\$5108	\$3744	\$4422	+\$221	+\$776	+\$54	+\$190

► Specification Information, continued on next page

24"D x 90"W Leg Base 27½"H Credenzas, Wood Veneer or Laminate, continued

SIN 711.2

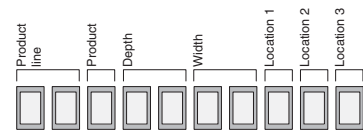

► Specification Information, continued from previous page

Specification Information

Tip: The location of the suffix within the style number determines the location of the storage unit within the credenza.

Suffix B	Suffix I	Suffix J	Suffix L	Suffix A2
18" Box/File	36" Box/File	36" Open	36" Hinged Doors	36" Kneewell

Style Number	Number of Tech Troughs	Counter-weight Package	Base Prices		Options (Add \$ to Base Price)					
			Wood Group 1 Case	Laminate Price Group 1 Case	Wood Case with Wood Front	Laminate Case with Wood Front	Wood Group 2	Wood Group 3	Wood Group 2	Wood Group 3
			Wood Group 1 Front	Laminate Price Group 1 Front	Wood Group 1 Front or Open Front					

36"W Kneewell with One 18"W Position and One 36"W Position

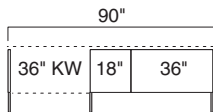

E6C2490A2BI	2	3	\$5670	\$4411	\$4996	+\$205	+\$714	+\$54	+\$190
E6C2490A2BJ	2	1	\$4909	\$3992	\$4222	+\$187	+\$649	+\$28	+\$ 94
E6C2490A2BL	1	1	\$5187	\$3944	\$4513	+\$205	+\$714	+\$54	+\$190

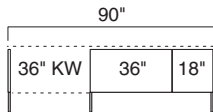

E6C2490A2IB	2	3	\$5670	\$4411	\$4996	+\$205	+\$714	+\$54	+\$190
E6C2490A2JB	2	1	\$4909	\$3992	\$4222	+\$187	+\$649	+\$28	+\$ 94
E6C2490A2LB	N.A.	1	\$5187	\$3944	\$4513	+\$205	+\$714	+\$54	+\$190

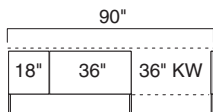

E6C2490BIA2	2	3	\$5670	\$4411	\$4996	+\$205	+\$714	+\$54	+\$190
E6C2490BJA2	2	1	\$4909	\$3992	\$4222	+\$187	+\$649	+\$28	+\$ 94
E6C2490BLA2	N.A.	1	\$5187	\$3944	\$4513	+\$205	+\$714	+\$54	+\$190

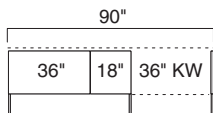

E6C2490IBA2	2	3	\$5670	\$4411	\$4996	+\$205	+\$714	+\$54	+\$190
E6C2490JBA2	2	1	\$4909	\$3992	\$4222	+\$187	+\$649	+\$28	+\$ 94
E6C2490LBA2	1	1	\$5187	\$3944	\$4513	+\$205	+\$714	+\$54	+\$190

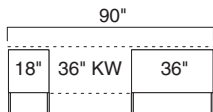

E6C2490BA2I	2	3	\$5368	\$4198	\$4783	+\$205	+\$714	+\$54	+\$190
E6C2490BA2J	2	1	\$4607	\$3779	\$4009	+\$187	+\$649	+\$28	+\$ 94
E6C2490BA2L	1	1	\$4884	\$3730	\$4299	+\$205	+\$714	+\$54	+\$190

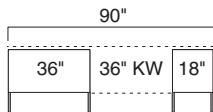

E6C2490IA2B	2	3	\$5368	\$4198	\$4783	+\$205	+\$714	+\$54	+\$190
E6C2490JA2B	2	1	\$4607	\$3779	\$4009	+\$187	+\$649	+\$28	+\$ 94
E6C2490LA2B	1	1	\$4884	\$3730	\$4299	+\$205	+\$714	+\$54	+\$190

► Specification Information, continued on next page

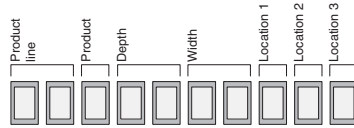

► Specification Information, continued from previous page

Specification Information

Suffix A	Suffix B	Suffix D	Suffix E	Suffix G	Suffix A4	Suffix A6
15" Box/File	18" Box/File	30" Box/File	30" Open	30" Hinged Doors	45" Kneewell	54" Kneewell

Tip: The location of the suffix within the style number determines the location of the storage unit within the credenza.

Style Number	Number of Tech Troughs	Counter-weight Package	Base Prices		Options (Add \$ to Base Price)				
			Wood Group 1 Case	Laminate Price Group 1 Case	Wood Case with Wood Front	Laminate Case with Wood Front			
			Wood Group 1 Front	Laminate Price Group 1 Front	Wood Group 1 Front or Open Front	Wood Group 2	Wood Group 3	Wood Group 2	Wood Group 3

Tip: 45"W kneewell will always be centered within 90"W credenza.

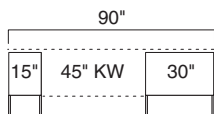

45"W Kneewell with One 15"W Position and One 30"W Position

E6C2490AA4D	2	3	\$4808	\$3638	\$4223	+\$205	+\$714	+\$54	+\$190
E6C2490AA4E	2	1	\$4371	\$3543	\$3773	+\$187	+\$649	+\$28	+\$ 94
E6C2490AA4G	1	1	\$4679	\$3525	\$4094	+\$205	+\$714	+\$54	+\$190

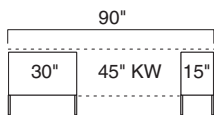

E6C2490DA4A	2	3	\$4808	\$3638	\$4223	+\$205	+\$714	+\$54	+\$190
E6C2490EA4A	2	1	\$4371	\$3543	\$3773	+\$187	+\$649	+\$28	+\$ 94
E6C2490GA4A	1	1	\$4679	\$3525	\$4094	+\$205	+\$714	+\$54	+\$190

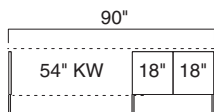

54"W Kneewell with Two 18"W Positions

E6C2490A6BB	2	2	\$4845	\$3811	\$4271	+\$187	+\$652	+\$54	+\$190
--------------------	---	---	--------	--------	--------	--------	--------	-------	--------

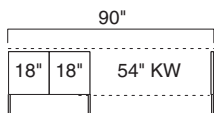

E6C2490BBA6	2	2	\$4845	\$3811	\$4271	+\$187	+\$652	+\$54	+\$190
--------------------	---	---	--------	--------	--------	--------	--------	-------	--------

► Specification Information, continued on next page

24"D x 90"W Leg Base 27½"H Credenzas, Wood Veneer or Laminate, continued

SIN 711.2

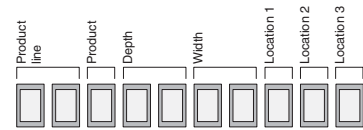

► Specification Information, continued from previous page

Specification Information

Tip: The location of the suffix within the style number determines the location of the storage unit within the credenza.

Suffix A	Suffix I	Suffix J	Suffix L	Suffix A6	Suffix A7
15" Box/File	36" Box/File	36" Open	36" Hinged Doors	54" Kneewell	60" Kneewell

Style Number	Number of Tech Troughs	Counter-weight Package	Base Prices		Options (Add \$ to Base Price)	
			Wood Group 1 Case	Laminate Price Group 1 Case	Wood Case with Wood Front	Laminate Case with Wood Front
			Wood Group 1 Front	Laminate Price Group 1 Front	Wood Group 1 Front or Open Front	Wood Group 2, Wood Group 3, Wood Group 2, Wood Group 3

54"W Kneewell with One 36"W Position

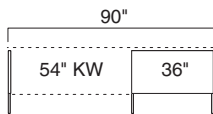

E6C2490A6I	1	2	\$3968	\$3179	\$3535	+\$136	+\$469	+\$28	+\$ 94
E6C2490A6J	1	N.A.	\$3207	N.A.	\$2762	+\$116	+\$406	N.A.	N.A.
E6C2490A6L	N.A.	N.A.	\$3485	\$2713	\$3052	+\$136	+\$469	+\$28	+\$ 94

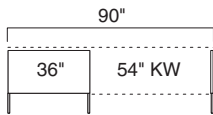

E6C2490IA6	1	2	\$3968	\$3179	\$3535	+\$136	+\$469	+\$28	+\$ 94
E6C2490JA6	1	N.A.	\$3207	N.A.	\$2762	+\$116	+\$406	N.A.	N.A.
E6C2490LA6	N.A.	N.A.	\$3485	\$2713	\$3052	+\$136	+\$469	+\$28	+\$ 94

60"W Kneewell with Two 15"W Positions

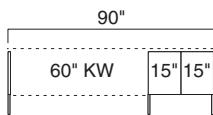

E6C2490A7AA	2	2	\$4553	\$3519	\$3979	+\$187	+\$652	+\$54	+\$190
--------------------	---	---	--------	--------	--------	--------	--------	-------	--------

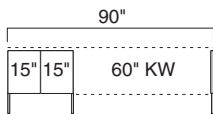

E6C2490AAA7	2	2	\$4553	\$3519	\$3979	+\$187	+\$652	+\$54	+\$190
--------------------	---	---	--------	--------	--------	--------	--------	-------	--------

► Specification Information, continued on next page

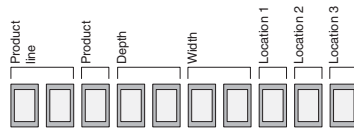

► Specification Information, continued from previous page

Specification Information

Tip: The location of the suffix within the style number determines the location of the storage unit within the credenza.

Suffix B	Suffix D	Suffix E	Suffix G	Suffix A7	Suffix A9
18" Box/File	30" Box/File	30" Open	30" Hinged Doors	60" Kneewell	72" Kneewell

Style Number	Number of Tech Troughs	Counter-weight Package	Base Prices		Options (Add \$ to Base Price)				
			Wood Group 1 Case	Laminate Price Group 1 Case	Wood Case with Wood Front	Laminate Case with Wood Front	Wood Group 2	Wood Group 3	
			Wood Group 1 Front	Laminate Price Group 1 Front	Wood Group 1 Front or Open Front	Wood Group 2	Wood Group 3	Wood Group 2	Wood Group 3

60"W Kneewell with One 30"W Position

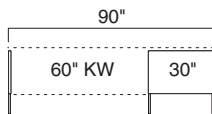

E6C2490A7D	1	2	\$3555	\$2766	\$3122	+\$136	+\$469	+\$28	+\$94
E6C2490A7E	1	N.A.	\$3117	N.A.	\$2672	+\$116	+\$406	N.A.	N.A.
E6C2490A7G	N.A.	N.A.	\$3426	\$2654	\$2993	+\$136	+\$469	+\$28	+\$94

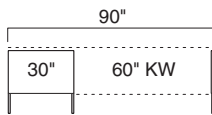

E6C2490DA7	1	2	\$3555	\$2766	\$3122	+\$136	+\$469	+\$28	+\$94
E6C2490EA7	1	N.A.	\$3117	N.A.	\$2672	+\$116	+\$406	N.A.	N.A.
E6C2490GA7	N.A.	N.A.	\$3426	\$2654	\$2993	+\$136	+\$469	+\$28	+\$94

72"W Kneewell with One 18"W Position

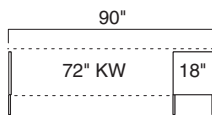

E6C2490A9B	1	1	\$3143	\$2581	\$2811	+\$118	+\$407	+\$28	+\$94
-------------------	---	---	--------	--------	--------	--------	--------	-------	-------

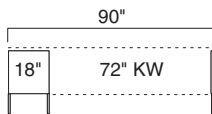

E6C2490BA9	1	1	\$3143	\$2581	\$2811	+\$118	+\$407	+\$28	+\$94
-------------------	---	---	--------	--------	--------	--------	--------	-------	-------

24"D x 96"W Leg Base 27½"H Credenzas

Wood Veneer or Laminate

SIN 711.2

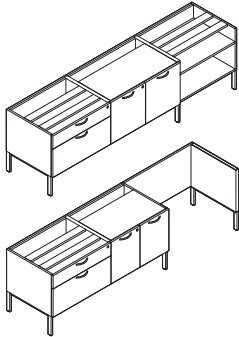

Tip: Storage legs may be shared with another leg base storage unit of the same depth.

Tip: When storage legs are shared between two units, the extra legs should be saved for later use, such as reconfiguration.

Tip: All credenzas with a kneewell ship knockdown.

For laminate price group 2 pricing, please refer to the electronic catalog or SmartTools.

Tip: Soft close drawer slides only apply to storage that has 15"W and 18"W drawers.

Tip: Soft close slides are available for both dovetail and miter fold construction.

Tip: Metal shelves only available in open or hinged door components.

Tip: Back panel is inset and spans entire width of credenza.

Tip: Technology trough not available in hinged door components.

Tip: Center or inside panels are always cut out if technology trough is specified to allow cords to pass between components.

Standard Includes	Required to Specify
-------------------	---------------------

- Underworksurface storage:
 - Wood group 1 case with wood group 1 front
 - Laminate price group 1 case with same or contrasting laminate front
 - Laminate price group 1 case with wood group 1 front
- Unfinished, inset back panel spanning full credenza
- Unfinished open top
- Storage leg; paint or metal
- Dovetail drawer construction
- Lock, keyed random
- Counterweight package
- Storage brace
- Standard close drawer slides

- 1 Style number with appropriate suffix to indicate location of storage units
 - 2 Wood or laminate color number for underworksurface storage
 - 3 Laminate color number for laminate fronts on laminate case, if selected
 - 4 Wood color number for wood fronts on laminate cases, if selected
 - 5 Pull shape (see below under Required Selections)
 - 6 Paint or metal color number for storage leg
 - 7 Finish color number for pull
 - 8 Finish color number for lock
 - 9 Options, if selected (see below)
- ▶ See *Surface Materials*, page 566.

Required Selections

Pull Shape

Contemporary	Jazz	Bar	Nile	Integral*	Transitional	Inset	Beam
No cost	+\$19 each	+\$26 each	+\$26 each	+\$26 each	+\$26 each	+\$26 each	+\$37 each

*Not available on laminate or composite fronts.

Options	Price	Required to Specify
---------	-------	---------------------

Surface Materials	Wood underworksurface storage case	Prices at right	Specify wood color number.
	<ul style="list-style-type: none"> • Wood group 2 • Wood group 3 • Customiz stain 	Prices at right No cost	Specify wood color number. Specify with <i>Customiz stain</i> .
	Laminate underworksurface storage case	See information at left	Specify laminate color number.
	<ul style="list-style-type: none"> • Laminate price group 2 • Open Line laminate • Wood group 2 on wood fronts • Wood group 3 on wood fronts • Customiz stain 	+\$ 69 plus cost of laminate Prices at right Prices at right No cost	▶ See <i>Surface Materials Reference Manual</i> . Specify wood color number. Specify wood color number. Specify with <i>Customiz stain</i> .
Drawer Slide	• Soft close drawer slides	+\$ 30 per drawer	Specify with <i>soft close drawers</i> .
Lock and Keying	Lock	No cost	Specify with <i>9250 Ember Chrome lock</i> .
	• Polished chrome	No cost	Specify with <i>9201 Polished Chrome lock</i> .
	Keying		▶ Page 622
Shelves	• ¾" shelf	No cost	Specify with <i>¾" shelf</i> .
	• Metal shelf	–\$ 26 per shelf	Specify with <i>metal shelf</i> and select paint color number.
Counterweight Package	• Counterweight package	No cost	Specify with <i>counterweight package</i> .
	• Omit counterweight package	–\$ 65 each	Specify with <i>no counterweight package</i> .
Back Panel	• Laminate full length back panel	+\$249	Specify with <i>laminate finished back panel</i> .
	• Wood full length back panel	+\$497	Specify with <i>wood finished back panel</i> .
Technology Trough	• Technology trough for power and data routing; black	+\$ 57 each	Specify with <i>technology trough</i> .
Cut-Out	• Right side only	No cost	Specify with <i>right cut-out</i> .
	• Left side only	No cost	Specify with <i>left cut-out</i> .
	• Both sides	No cost	Specify with <i>both cut-outs</i> .
	• No cut-outs	No cost	Specify with <i>no cut-outs</i> .
	• Kneewell	No cost	Specify with <i>kneewell cut-outs</i> .

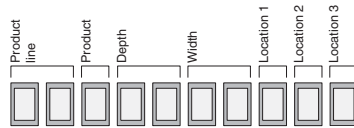

Tip: The location of the suffix within the style number determines the location of the storage unit within the credenza.

Specification Information

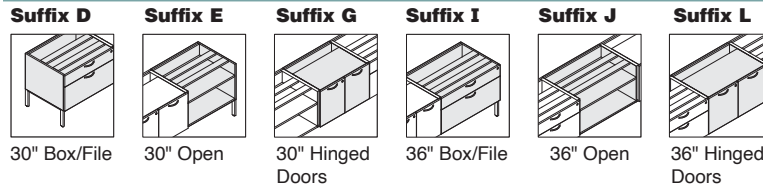

Style Number	Number of Tech Troughs	Counter-weight Package	Base Prices			Options (Add \$ to Base Price)			
			Wood Group 1 Case	Laminate Price Group 1 Case	Wood Group 1 Front or Front	Wood Case with Wood Front	Laminate Case with Wood Front	Wood Group 2	Wood Group 3

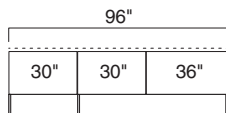

Full Storage: Two 30"W Positions and One 36"W Position

Style Number	Number of Tech Troughs	Counter-weight Package	Wood Group 1 Case	Laminate Price Group 1 Case	Wood Group 1 Front or Front	Wood Case with Wood Front	Laminate Case with Wood Front	Wood Group 2	Wood Group 3
E6C2496DDI	3	6	\$7904	\$5809	\$6875	+\$261	+\$917	+\$82	+\$284
E6C2496DDJ	3	4	\$7143	\$5393	\$6103	+\$242	+\$854	+\$54	+\$190
E6C2496DDL	2	4	\$7421	\$5342	\$6392	+\$261	+\$917	+\$82	+\$284
E6C2496DEJ	3	2	\$6706	\$5296	\$5652	+\$225	+\$789	+\$28	+\$ 94
E6C2496DEL	2	2	\$6982	\$5248	\$5942	+\$242	+\$854	+\$54	+\$190
E6C2496DGJ	2	2	\$7014	\$5280	\$5974	+\$242	+\$854	+\$54	+\$190
E6C2496DGL	1	2	\$7291	\$5229	\$6262	+\$261	+\$917	+\$82	+\$284
E6C2496EDI	3	4	\$7466	\$5716	\$6426	+\$242	+\$854	+\$54	+\$190
E6C2496EDL	2	2	\$6982	\$5248	\$5942	+\$242	+\$854	+\$54	+\$190
E6C2496EEI	3	2	\$7028	\$5618	\$5974	+\$225	+\$789	+\$28	+\$ 94
E6C2496EEJ	3	N.A.	\$6268	N.A.	\$5202	+\$205	+\$725	N.A.	N.A.
E6C2496EEL	2	N.A.	\$6545	\$5152	\$5491	+\$225	+\$789	+\$28	+\$ 94
E6C2496EGI	2	2	\$7337	\$5603	\$6297	+\$242	+\$854	+\$54	+\$190
E6C2496EGL	1	N.A.	\$6853	\$5135	\$5813	+\$242	+\$854	+\$54	+\$190
E6C2496GDI	2	4	\$7775	\$5696	\$6746	+\$261	+\$917	+\$82	+\$284
E6C2496GDJ	2	2	\$7014	\$5280	\$5974	+\$242	+\$854	+\$54	+\$190
E6C2496GEI	2	2	\$7337	\$5603	\$6297	+\$242	+\$854	+\$54	+\$190
E6C2496GEJ	2	N.A.	\$6576	\$5183	\$5522	+\$225	+\$789	+\$28	+\$ 94
E6C2496GGI	1	2	\$7645	\$5583	\$6616	+\$261	+\$917	+\$82	+\$284
E6C2496GGJ	1	N.A.	\$6885	\$5167	\$5845	+\$242	+\$854	+\$54	+\$190
E6C2496GGL	N.A.	N.A.	\$7162	\$5116	\$6133	+\$261	+\$917	+\$82	+\$284

► Specification Information, continued on next page

Elective Elements

24"D x 96"W Leg Base 27½"H Credenzas, Wood Veneer or Laminate, continued

SIN 711.2

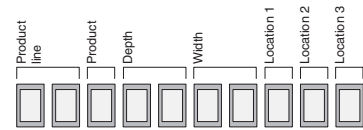

► Specification Information, continued from previous page

Specification Information

Tip: The location of the suffix within the style number determines the location of the storage unit within the credenza.

Suffix D	Suffix E	Suffix G	Suffix I	Suffix J	Suffix L
30" Box/File	30" Open	30" Hinged Doors	36" Box/File	36" Open	36" Hinged Doors

Style Number	Number of Tech Troughs	Counter-weight Package	Base Prices			Options (Add \$ to Base Price)				
			Wood Group 1 Case	Laminate Price Group 1 Case	Wood Group 1 Front	Laminate Price Group 1 Front	Wood Group 1 Front or Open Front	Wood Case with Wood Front	Laminate Case with Wood Front	Wood Group 2

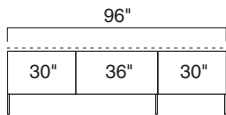

Full Storage: Two 30"W Positions and One 36"W Position, continued

Style Number	Number of Tech Troughs	Counter-weight Package	Wood Group 1 Case	Laminate Price Group 1 Case	Wood Group 1 Front	Laminate Price Group 1 Front	Wood Group 1 Front or Open Front	Wood Case with Wood Front	Laminate Case with Wood Front	Wood Group 2	Wood Group 3
E6C2496DIE	3	4	\$7466	\$5716	\$6426	+\$242	+\$854	+\$54	+\$190		
E6C2496DIG	2	4	\$7775	\$5696	\$6746	+\$261	+\$917	+\$82	+\$284		
E6C2496DJE	3	2	\$6706	\$5296	\$5652	+\$225	+\$789	+\$28	+\$ 94		
E6C2496DJG	2	2	\$7014	\$5280	\$5974	+\$242	+\$854	+\$54	+\$190		
E6C2496DLE	2	2	\$6982	\$5248	\$5942	+\$242	+\$854	+\$54	+\$190		
E6C2496DLG	1	2	\$7291	\$5229	\$6262	+\$261	+\$917	+\$82	+\$284		
E6C2496EID	3	4	\$7466	\$5716	\$6426	+\$242	+\$854	+\$54	+\$190		
E6C2496EIG	2	2	\$7337	\$5603	\$6297	+\$242	+\$854	+\$54	+\$190		
E6C2496EJD	3	2	\$6706	\$5296	\$5652	+\$225	+\$789	+\$28	+\$ 94		
E6C2496EJE	3	N.A.	\$6268	N.A.	\$5202	+\$205	+\$725	N.A.	N.A.		
E6C2496EJG	2	N.A.	\$6576	\$5183	\$5522	+\$225	+\$789	+\$28	+\$ 94		
E6C2496ELD	2	2	\$6982	\$5248	\$5942	+\$242	+\$854	+\$54	+\$190		
E6C2496ELG	1	N.A.	\$6853	\$5135	\$5813	+\$242	+\$854	+\$54	+\$190		
E6C2496GID	2	N.A.	\$7775	\$5696	\$6746	+\$261	+\$917	+\$82	+\$284		
E6C2496GIE	2	2	\$7337	\$5603	\$6297	+\$242	+\$854	+\$54	+\$190		
E6C2496GJD	2	2	\$7014	\$5280	\$5974	+\$242	+\$854	+\$54	+\$190		
E6C2496GJE	2	N.A.	\$6576	\$5183	\$5522	+\$225	+\$789	+\$28	+\$ 94		
E6C2496GLD	1	2	\$7291	\$5229	\$6262	+\$261	+\$917	+\$82	+\$284		
E6C2496GLE	1	N.A.	\$6853	\$5135	\$5813	+\$242	+\$854	+\$54	+\$190		
E6C2496GLG	N.A.	N.A.	\$7162	\$5116	\$6133	+\$261	+\$917	+\$82	+\$284		

► Specification Information, continued on next page

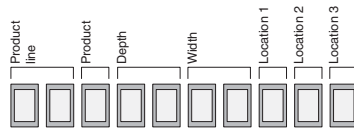

► Specification Information, continued from previous page

Specification Information

Tip: The location of the suffix within the style number determines the location of the storage unit within the credenza.

Suffix D	Suffix E	Suffix G	Suffix I	Suffix J	Suffix L
30" Box/File	30" Open	30" Hinged Doors	36" Box/File	36" Open	36" Hinged Doors

Style Number	Number of Tech Troughs	Counter-weight Package	Base Prices		Options (Add \$ to Base Price)				
			Wood Group 1 Case	Laminate Price Group 1 Case	Wood Group 1 Front	Wood Group 1 Front or Open Front	Wood Case with Wood Front	Laminate Case with Wood Front	Wood Group 2

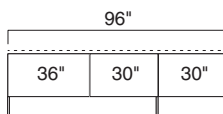

Full Storage: Two 30"W Positions and One 36"W Position, continued

E6C2496IDD	3	6	\$7904	\$5809	\$6875	+\$261	+\$917	+\$82	+\$284
E6C2496IDE	3	4	\$7466	\$5716	\$6426	+\$242	+\$854	+\$54	+\$190
E6C2496IDG	2	4	\$7775	\$5696	\$6746	+\$261	+\$917	+\$82	+\$284
E6C2496IEE	3	2	\$7028	\$5618	\$5974	+\$225	+\$789	+\$28	+\$ 94
E6C2496IEG	2	2	\$7337	\$5603	\$6297	+\$242	+\$854	+\$54	+\$190
E6C2496IGE	2	2	\$7337	\$5603	\$6297	+\$242	+\$854	+\$54	+\$190
E6C2496IGG	1	2	\$7645	\$5583	\$6616	+\$261	+\$917	+\$82	+\$284
E6C2496JDD	3	4	\$7143	\$5393	\$6103	+\$242	+\$854	+\$54	+\$190
E6C2496JDG	2	2	\$7014	\$5280	\$5974	+\$242	+\$854	+\$54	+\$190
E6C2496JED	3	2	\$6706	\$5296	\$5652	+\$225	+\$789	+\$28	+\$ 94
E6C2496JEE	3	N.A.	\$6268	N.A.	\$5202	+\$205	+\$725	N.A.	N.A.
E6C2496JEG	2	N.A.	\$6576	\$5183	\$5522	+\$225	+\$789	+\$28	+\$ 94
E6C2496JGD	2	2	\$7014	\$5280	\$5974	+\$242	+\$854	+\$54	+\$190
E6C2496JGG	1	N.A.	\$6885	\$5167	\$5845	+\$242	+\$854	+\$54	+\$190
E6C2496LDD	2	4	\$7421	\$5342	\$6392	+\$261	+\$917	+\$82	+\$284
E6C2496LDE	2	2	\$6982	\$5248	\$5942	+\$242	+\$854	+\$54	+\$190
E6C2496LED	2	2	\$6982	\$5248	\$5942	+\$242	+\$854	+\$54	+\$190
E6C2496LEE	2	N.A.	\$6545	\$5152	\$5491	+\$225	+\$789	+\$28	+\$ 94
E6C2496LGD	1	2	\$7291	\$5229	\$6262	+\$261	+\$917	+\$82	+\$284
E6C2496LGE	1	N.A.	\$6853	\$5135	\$5813	+\$242	+\$854	+\$54	+\$190
E6C2496LGG	N.A.	N.A.	\$7162	\$5116	\$6133	+\$261	+\$917	+\$82	+\$284

► Specification Information, continued on next page

Elective Elements

24"D x 96"W Leg Base 27½"H Credenzas, Wood Veneer or Laminate, continued

SIN 711.2

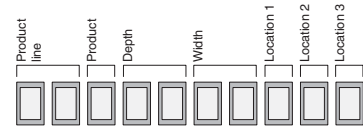

► Specification Information, continued from previous page

Specification Information

Tip: The location of the suffix within the style number determines the location of the storage unit within the credenza.

Suffix D	Suffix E	Suffix G	Suffix I	Suffix J	Suffix L	Suffix A1
30" Box/File	30" Open	30" Hinged Doors	36" Box/File	36" Open	36" Hinged Doors	30" Kneewell

Style Number	Number of Tech Troughs	Counter-weight Package	Base Prices		Options (Add \$ to Base Price)									
			Wood Group 1 Case	Laminate Price Group 1 Case	Wood Group 1 Front	Laminate Price Group 1 Front	Wood Group 1 Front or Open Front	Wood Case with Wood Front	Laminate Case with Wood Front	Wood Group 2	Wood Group 3	Wood Group 2	Wood Group 3	

30"W Kneewell with One 30"W Position and One 36"W Position

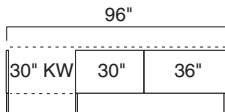

E6C2496A1DI	2	4	\$6144	\$4659	\$5369	+\$221	+\$776	+\$54	+\$190
E6C2496A1DJ	2	2	\$5383	\$4240	\$4596	+\$203	+\$711	+\$28	+\$ 94
E6C2496A1DL	1	2	\$5661	\$4192	\$4886	+\$221	+\$776	+\$54	+\$190
E6C2496A1EI	2	2	\$5706	\$4563	\$4919	+\$203	+\$711	+\$28	+\$ 94
E6C2496A1EJ	2	N.A.	\$4946	N.A.	\$4147	+\$183	+\$647	N.A.	N.A.
E6C2496A1EL	1	N.A.	\$5222	\$4096	\$4435	+\$203	+\$711	+\$28	+\$ 94
E6C2496A1GI	1	2	\$6015	\$4546	\$5240	+\$221	+\$776	+\$54	+\$190
E6C2496A1GJ	1	N.A.	\$5254	\$4128	\$4467	+\$203	+\$711	+\$28	+\$ 94
E6C2496A1GL	N.A.	N.A.	\$5531	\$4078	\$4756	+\$221	+\$776	+\$54	+\$190

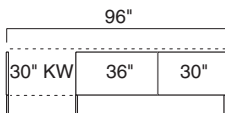

E6C2496A1ID	2	4	\$6144	\$4659	\$5369	+\$221	+\$776	+\$54	+\$190
E6C2496A1IE	2	2	\$5706	\$4563	\$4919	+\$203	+\$711	+\$28	+\$ 94
E6C2496A1IG	1	2	\$6015	\$4546	\$5240	+\$221	+\$776	+\$54	+\$190
E6C2496A1JD	2	2	\$5383	\$4240	\$4596	+\$203	+\$711	+\$28	+\$ 94
E6C2496A1JE	2	N.A.	\$4946	N.A.	\$4147	+\$183	+\$647	N.A.	N.A.
E6C2496A1JG	1	N.A.	\$5254	\$4128	\$4467	+\$203	+\$711	+\$28	+\$ 94
E6C2496A1LD	1	2	\$5661	\$4192	\$4886	+\$221	+\$776	+\$54	+\$190
E6C2496A1LE	1	N.A.	\$5222	\$4096	\$4435	+\$203	+\$711	+\$28	+\$ 94
E6C2496A1LG	N.A.	N.A.	\$5531	\$4078	\$4756	+\$221	+\$776	+\$54	+\$190

► Specification Information, continued on next page

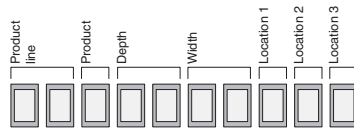

► Specification Information, continued from previous page

Specification Information

Tip: The location of the suffix within the style number determines the location of the storage unit within the credenza.

Suffix D	Suffix E	Suffix G	Suffix I	Suffix J	Suffix L	Suffix A1
30" Box/File	30" Open	30" Hinged Doors	36" Box/File	36" Open	36" Hinged Doors	30" Kneewell

Style Number	Number of Tech Troughs	Counter-weight Package	Base Prices		Options (Add \$ to Base Price)														
			Wood Group 1 Case	Laminate Price Group 1 Case	Wood Group 1 Front	Wood Case with Wood Front	Wood Group 2	Wood Group 3	Laminate Case with Wood Front	Wood Group 2	Wood Group 3								

30"W Kneewell with One 30"W Position and One 36"W Position, continued

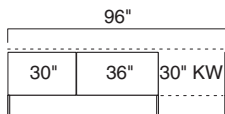

E6C2496DIA1	2	4	\$6144	\$4659	\$5369	+\$221	+\$776	+\$54	+\$190
E6C2496DJA1	2	2	\$5383	\$4240	\$4596	+\$203	+\$711	+\$28	+\$ 94
E6C2496DLA1	1	2	\$5661	\$4192	\$4886	+\$221	+\$776	+\$54	+\$190
E6C2496EIA1	2	2	\$5706	\$4563	\$4919	+\$203	+\$711	+\$28	+\$ 94
E6C2496EJA1	2	N.A.	\$4946	N.A.	\$4147	+\$183	+\$647	N.A.	N.A.
E6C2496ELA1	1	N.A.	\$5222	\$4096	\$4435	+\$203	+\$711	+\$28	+\$ 94
E6C2496GIA1	1	2	\$6015	\$4546	\$5240	+\$221	+\$776	+\$54	+\$190
E6C2496GJA1	1	N.A.	\$5254	\$4128	\$4467	+\$203	+\$711	+\$28	+\$ 94
E6C2496GLA1	N.A.	N.A.	\$5531	\$4078	\$4756	+\$221	+\$776	+\$54	+\$190

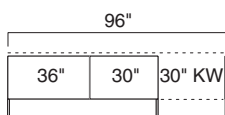

E6C2496IDA1	2	4	\$6144	\$4659	\$5369	+\$221	+\$776	+\$54	+\$190
E6C2496IEA1	2	2	\$5706	\$4563	\$4919	+\$203	+\$711	+\$28	+\$ 94
E6C2496IGA1	1	2	\$6015	\$4546	\$5240	+\$221	+\$776	+\$54	+\$190
E6C2496JDA1	2	2	\$5383	\$4240	\$4596	+\$203	+\$711	+\$28	+\$ 94
E6C2496JEA1	2	N.A.	\$4946	N.A.	\$4147	+\$183	+\$647	N.A.	N.A.
E6C2496JGA1	1	N.A.	\$5254	\$4128	\$4467	+\$203	+\$711	+\$28	+\$ 94
E6C2496LDA1	1	2	\$5661	\$4192	\$4886	+\$221	+\$776	+\$54	+\$190
E6C2496LEA1	1	N.A.	\$5222	\$4096	\$4435	+\$203	+\$711	+\$28	+\$ 94
E6C2496LGA1	N.A.	N.A.	\$5531	\$4078	\$4756	+\$221	+\$776	+\$54	+\$190

► Specification Information, continued on next page

24"D x 96"W Leg Base 27½"H Credenzas, Wood Veneer or Laminate, continued

SIN 711.2

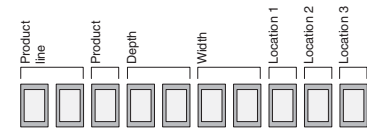

► Specification Information, continued from previous page

Specification Information

Tip: The location of the suffix within the style number determines the location of the storage unit within the credenza.

Suffix D	Suffix E	Suffix G	Suffix I	Suffix J	Suffix L	Suffix A1
30" Box/File	30" Open	30" Hinged Doors	36" Box/File	36" Open	36" Hinged Doors	30" Kneewell

Style Number	Number of Tech Troughs	Counter-weight Package	Base Prices			Options (Add \$ to Base Price)								
			Wood Group 1 Case	Laminate Price Group 1 Case	Wood Group 1 Front	Laminate Price Group 1 Front	Wood Group 1 Front or Open Front	Wood Case with Wood Front	Laminate Case with Wood Front	Wood Group 2	Wood Group 3	Wood Group 2	Wood Group 3	

30"W Kneewell with One 30"W Position and One 36"W Position, continued

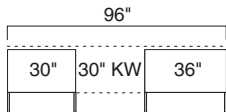

E6C2496DA1I	2	4	\$5841	\$4445	\$5155	+\$221	+\$776	+\$54	+\$190
E6C2496DA1J	2	2	\$5081	\$4027	\$4383	+\$203	+\$711	+\$28	+\$ 94
E6C2496DA1L	1	2	\$5359	\$3979	\$4673	+\$221	+\$776	+\$54	+\$190
E6C2496EA1I	2	2	\$5404	\$4350	\$4706	+\$203	+\$711	+\$28	+\$ 94
E6C2496EA1J	2	N.A.	\$4643	N.A.	\$3932	+\$183	+\$647	N.A.	N.A.
E6C2496EA1L	1	N.A.	\$4921	\$3884	\$4223	+\$203	+\$711	+\$28	+\$ 94
E6C2496GA1I	1	2	\$5712	\$4332	\$5026	+\$221	+\$776	+\$54	+\$190
E6C2496GA1J	1	N.A.	\$4952	\$3915	\$4254	+\$203	+\$711	+\$28	+\$ 94
E6C2496GA1L	N.A.	N.A.	\$5230	\$3866	\$4544	+\$221	+\$776	+\$54	+\$190

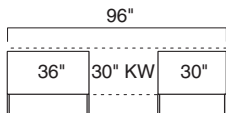

E6C2496IA1D	2	4	\$5841	\$4445	\$5155	+\$221	+\$776	+\$54	+\$190
E6C2496IA1E	2	2	\$5404	\$4350	\$4706	+\$203	+\$711	+\$28	+\$ 94
E6C2496IA1G	1	2	\$5712	\$4332	\$5026	+\$221	+\$776	+\$54	+\$190
E6C2496JA1D	2	2	\$5081	\$4027	\$4383	+\$203	+\$711	+\$28	+\$ 94
E6C2496JA1E	2	N.A.	\$4643	N.A.	\$3932	+\$183	+\$647	N.A.	N.A.
E6C2496JA1G	1	N.A.	\$4952	\$3915	\$4254	+\$203	+\$711	+\$28	+\$ 94
E6C2496LA1D	1	2	\$5359	\$3979	\$4673	+\$221	+\$776	+\$54	+\$190
E6C2496LA1E	1	N.A.	\$4921	\$3884	\$4223	+\$203	+\$711	+\$28	+\$ 94
E6C2496LA1G	N.A.	N.A.	\$5230	\$3866	\$4544	+\$221	+\$776	+\$54	+\$190

► Specification Information, continued on next page

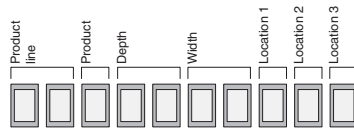

► Specification Information, continued from previous page

Specification Information

Tip: The location of the suffix within the style number determines the location of the storage unit within the credenza.

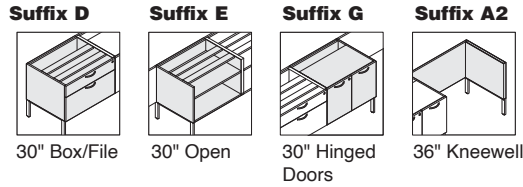

• Style Number	• Number of Tech Troughs	• Counter-weight Package	• Base Prices			• Options (Add \$ to Base Price)				
			Wood Group 1 Case	Laminate Price Group 1 Case	Wood Group 1 Front	Laminate Price Group 1 Front	Wood Group 1 Front or Open Front	Wood Case with Wood Front	Laminate Case with Wood Front	Wood Group 2

36"W Kneewell with Two 30"W Positions

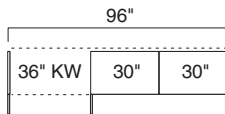

E6C2496A2DD	2	4	\$5731	\$4246	\$4956	+\$221	+\$776	+\$54	+\$190
E6C2496A2DE	2	2	\$5293	\$4150	\$4506	+\$203	+\$711	+\$28	+\$ 94
E6C2496A2DG	1	2	\$5602	\$4133	\$4827	+\$221	+\$776	+\$54	+\$190
E6C2496A2ED	2	2	\$5293	\$4150	\$4506	+\$203	+\$711	+\$28	+\$ 94
E6C2496A2EE	2	N.A.	\$4855	N.A.	\$4056	+\$183	+\$647	N.A.	N.A.
E6C2496A2EG	1	N.A.	\$5164	\$4038	\$4377	+\$203	+\$711	+\$28	+\$ 94
E6C2496A2GD	1	2	\$5602	\$4133	\$4827	+\$221	+\$776	+\$54	+\$190
E6C2496A2GE	1	N.A.	\$5164	\$4038	\$4377	+\$203	+\$711	+\$28	+\$ 94
E6C2496A2GG	N.A.	N.A.	\$5472	\$4019	\$4697	+\$221	+\$776	+\$54	+\$190

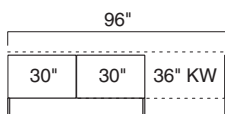

E6C2496DDA2	2	4	\$5731	\$4246	\$4956	+\$221	+\$776	+\$54	+\$190
E6C2496DEA2	2	2	\$5293	\$4150	\$4506	+\$203	+\$711	+\$28	+\$ 94
E6C2496DGA2	1	2	\$5602	\$4133	\$4827	+\$221	+\$776	+\$54	+\$190
E6C2496EDA2	2	2	\$5293	\$4150	\$4506	+\$203	+\$711	+\$28	+\$ 94
E6C2496EEA2	2	N.A.	\$4855	N.A.	\$4056	+\$183	+\$647	N.A.	N.A.
E6C2496EGA2	1	N.A.	\$5164	\$4038	\$4377	+\$203	+\$711	+\$28	+\$ 94
E6C2496GDA2	1	2	\$5602	\$4133	\$4827	+\$221	+\$776	+\$54	+\$190
E6C2496GEA2	1	N.A.	\$5164	\$4038	\$4377	+\$203	+\$711	+\$28	+\$ 94
E6C2496GGA2	N.A.	N.A.	\$5472	\$4019	\$4697	+\$221	+\$776	+\$54	+\$190

► Specification Information, continued on next page

24"D x 96"W Leg Base 27½"H Credenzas, Wood Veneer or Laminate, continued

SIN 711.2

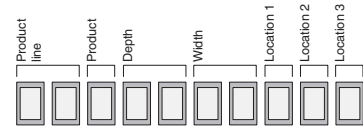

► Specification Information, continued from previous page

Specification Information

Tip: The location of the suffix within the style number determines the location of the storage unit within the credenza.

Suffix D	Suffix E	Suffix G	Suffix A2
30" Box/File	30" Open	30" Hinged Doors	36" Kneewell

Style Number	Number of Tech Troughs	Counter-weight Package	Base Prices		Options (Add \$ to Base Price)				
			Wood Group 1 Case	Laminate Price Group 1 Case	Wood Case with Wood Front	Laminate Case with Wood Front	Wood Group 2	Wood Group 3	
			Wood Group 1 Front	Laminate Price Group 1 Front	Wood Group 1 Front or Open Front				

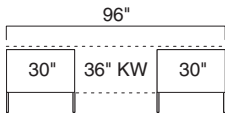

36"Kneewell with Two 30"W Positions, continued

E6C2496DA2D	2	4	\$5428	\$4032	+\$4742	+\$221	+\$776	+\$54	+\$190
E6C2496DA2E	2	2	\$4991	\$3937	+\$4293	+\$203	+\$711	+\$28	+\$ 94
E6C2496DA2G	1	2	\$5299	\$3919	+\$4613	+\$221	+\$776	+\$54	+\$190
E6C2496EA2D	2	2	\$4991	\$3937	+\$4293	+\$203	+\$711	+\$28	+\$ 94
E6C2496EA2E	2	N.A.	\$4553	N.A.	+\$3842	+\$183	+\$647	N.A.	N.A.
E6C2496EA2G	1	N.A.	\$4862	\$3825	+\$4164	+\$203	+\$711	+\$28	+\$ 94
E6C2496GA2D	1	2	\$5299	\$3919	+\$4613	+\$221	+\$776	+\$54	+\$190
E6C2496GA2E	1	N.A.	\$4862	\$3825	+\$4164	+\$203	+\$711	+\$28	+\$ 94
E6C2496GA2G	N.A.	N.A.	\$5170	\$3806	+\$4484	+\$221	+\$776	+\$54	+\$190

► Specification Information, continued on next page

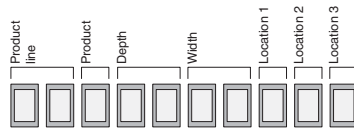

► Specification Information, continued from previous page

Specification Information

Tip: The location of the suffix within the style number determines the location of the storage unit within the credenza.

Suffix B	Suffix I	Suffix J	Suffix L	Suffix A3
18" Box/File	36" Box/File	36" Open	36" Hinged Doors	42" Kneewell

Style Number	Number of Tech Troughs	Counter-weight Package	Base Prices		Options (Add \$ to Base Price)				
			Wood Group 1 Case	Laminate Price Group 1 Case	Wood Case with Wood Front	Laminate Case with Wood Front	Wood Group 2	Wood Group 3	
			Wood Group 1 Front	Laminate Price Group 1 Front	Wood Group 1 Front or Open Front	Wood Group 2	Wood Group 3	Wood Group 2	Wood Group 3

Tip: 42" kneewell will always be centered within 96"W credenza unit.

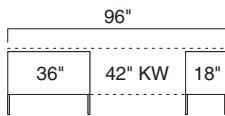
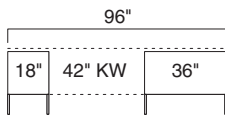

42"W Kneewell with One 18"W Position and One 36"W Position

E6C2496BA3I	2	3	\$5429	\$4259	\$4844	+\$205	+\$714	+\$54	+\$190
E6C2496BA3J	2	1	\$4669	\$3841	\$4071	+\$187	+\$649	+\$28	+\$ 94
E6C2496BA3L	1	1	\$4947	\$3793	\$4362	+\$205	+\$714	+\$54	+\$190
E6C2496IA3B	2	3	\$5429	\$4259	\$4844	+\$205	+\$714	+\$54	+\$190
E6C2496JA3B	2	1	\$4669	\$3841	\$4071	+\$187	+\$649	+\$28	+\$ 94
E6C2496LA3B	1	1	\$4947	\$3793	\$4362	+\$205	+\$714	+\$54	+\$190

► Specification Information, continued on next page

24"D x 96"W Leg Base 27½"H Credenzas, Wood Veneer or Laminate, continued

SIN 711.2

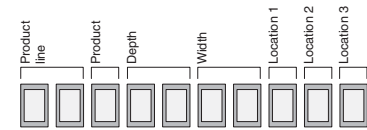

► Specification Information, continued from previous page

Specification Information

Tip: The location of the suffix within the style number determines the location of the storage unit within the credenza.

Suffix B	Suffix D	Suffix E	Suffix G	Suffix A5
18" Box/File	30" Box/File	30" Open	30" Hinged Doors	48" Kneewell

Style Number	Number of Tech Troughs	Counter-weight Package	Base Prices		Options (Add \$ to Base Price)	
			Wood Group 1 Case	Laminate Price Group 1 Case	Wood Case with Wood Front	Laminate Case with Wood Front
			Wood Group 1 Front	Laminate Price Group 1 Front	Wood Group 1 Front or Open Front	Wood Group 2, Wood Group 3, Wood Group 2, Wood Group 3

48"W Kneewell with One 18"W Position and One 30"W Position

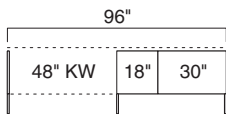

E6C2496A5BD	2	3	\$5319	\$4060	\$4645	+\$205	+\$714	+\$54	+\$190
E6C2496A5BE	2	1	\$4881	\$3964	\$4194	+\$187	+\$649	+\$28	+\$ 94
E6C2496A5BG	1	1	\$5190	\$3947	\$4516	+\$205	+\$714	+\$54	+\$190

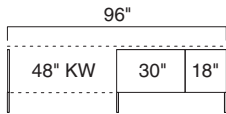

E6C2496A5DB	2	3	\$5319	\$4060	\$4645	+\$205	+\$714	+\$54	+\$190
E6C2496A5EB	2	1	\$4881	\$3964	\$4194	+\$187	+\$649	+\$28	+\$ 94
E6C2496A5GB	1	1	\$5190	\$3947	\$4516	+\$205	+\$714	+\$54	+\$190

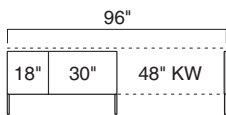

E6C2496BDA5	2	3	\$5319	\$4060	\$4645	+\$205	+\$714	+\$54	+\$190
E6C2496BEA5	2	1	\$4881	\$3964	\$4194	+\$187	+\$649	+\$28	+\$ 94
E6C2496BGA5	1	1	\$5190	\$3947	\$4516	+\$205	+\$714	+\$54	+\$190

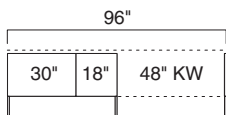

E6C2496DBA5	2	3	\$5319	\$4060	\$4645	+\$205	+\$714	+\$54	+\$190
E6C2496EBA5	2	1	\$4881	\$3964	\$4194	+\$187	+\$649	+\$28	+\$ 94
E6C2496GBA5	1	1	\$5190	\$3947	\$4516	+\$205	+\$714	+\$54	+\$190

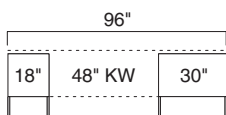

E6C2496BA5D	2	3	\$5016	\$3846	\$4431	+\$205	+\$714	+\$54	+\$190
E6C2496BA5E	2	1	\$4579	\$3751	\$3981	+\$187	+\$649	+\$28	+\$ 94
E6C2496BA5G	1	1	\$4887	\$3733	\$4302	+\$205	+\$714	+\$54	+\$190

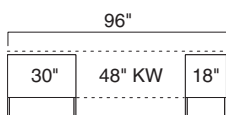

E6C2496DA5B	2	3	\$5016	\$3846	\$4431	+\$205	+\$714	+\$54	+\$190
E6C2496EA5B	2	1	\$4579	\$3751	\$3981	+\$187	+\$649	+\$28	+\$ 94
E6C2496GA5B	1	1	\$4887	\$3733	\$4302	+\$205	+\$714	+\$54	+\$190

► Specification Information, continued on next page

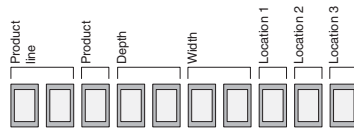

► Specification Information, continued from previous page

Specification Information

Tip: The location of the suffix within the style number determines the location of the storage unit within the credenza.

Suffix B	Suffix I	Suffix J	Suffix L	Suffix A7
18" Box/File	36" Box/File	36" Open	36" Hinged Doors	60" Kneewell

Style Number	Number of Tech Troughs	Counter-weight Package	Base Prices		Options (Add \$ to Base Price)				
			Wood Group 1 Case	Laminate Price Group 1 Case	Wood Group 1 Front	Wood Case with Wood Front	Laminate Case with Wood Front	Wood Group 2	Wood Group 3

60"W Kneewell with Two 18"W Positions

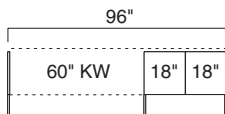

E6C2496A7BB	2	2	\$4907	\$3873	\$4333	+\$187	+\$652	+\$54	+\$190
--------------------	---	---	--------	--------	--------	--------	--------	-------	--------

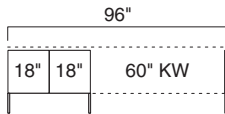

E6C2496BBA7	2	2	\$4907	\$3873	\$4333	+\$187	+\$652	+\$54	+\$190
--------------------	---	---	--------	--------	--------	--------	--------	-------	--------

60"W Kneewell with One 36"W Position

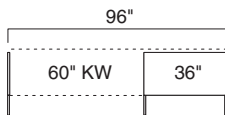

E6C2496A7I	1	2	\$4030	\$3241	\$3597	+\$136	+\$469	+\$28	+\$ 94
-------------------	---	---	--------	--------	--------	--------	--------	-------	--------

E6C2496A7J	1	N.A.	\$3270	N.A.	\$2825	+\$116	+\$406	N.A.	N.A.
-------------------	---	------	--------	------	--------	--------	--------	------	------

E6C2496A7L	N.A.	N.A.	\$3547	\$2775	\$3114	+\$136	+\$469	+\$28	+\$ 94
-------------------	------	------	--------	--------	--------	--------	--------	-------	--------

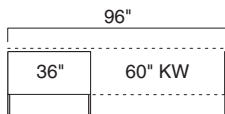

E6C2496IA7	1	2	\$4030	\$3241	\$3597	+\$136	+\$469	+\$28	+\$ 94
-------------------	---	---	--------	--------	--------	--------	--------	-------	--------

E6C2496JA7	1	N.A.	\$3270	N.A.	\$2825	+\$116	+\$406	N.A.	N.A.
-------------------	---	------	--------	------	--------	--------	--------	------	------

E6C2496LA7	N.A.	N.A.	\$3547	\$2775	\$3114	+\$136	+\$469	+\$28	+\$ 94
-------------------	------	------	--------	--------	--------	--------	--------	-------	--------

► Specification Information, continued on next page

24"D x 96"W Leg Base 27½"H Credenzas, Wood Veneer or Laminate, continued

SIN 711.2

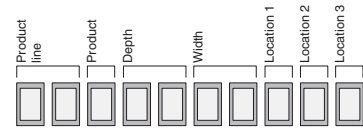

► Specification Information, continued from previous page

Specification Information

Tip: The location of the suffix within the style number determines the location of the storage unit within the credenza.

Suffix A	Suffix D	Suffix E	Suffix G	Suffix A8
15" Box/File	30" Box/File	30" Open	30" Hinged Doors	66" Kneewell

Style Number	Number of Tech Troughs	Counter-weight Package	Base Prices		Options (Add \$ to Base Price)				
			Wood Group 1 Case	Laminate Price Group 1 Case	Wood Case with Wood Front	Laminate Case with Wood Front	Wood Group 2	Wood Group 3	
			Wood Group 1 Front	Laminate Price Group 1 Front	Wood Group 1 Front or Open Front	Wood Group 2	Wood Group 3	Wood Group 2	Wood Group 3

66"W Kneewell with Two 15"W Positions

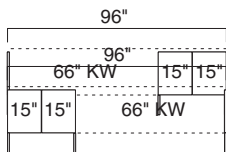

E6C2496A8AA	2	2	\$4616	\$3582	\$4042	+\$187	+\$652	+\$54	+\$190
E6C2496AAA8	2	2	\$4616	\$3582	\$4042	+\$187	+\$652	+\$54	+\$190

66"W Kneewell with One 30"W Position

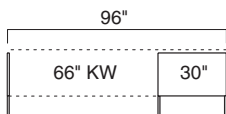

E6C2496A8D	1	2	\$3617	\$2828	\$3184	+\$136	+\$469	+\$28	+\$ 94
E6C2496A8E	1	N.A.	\$3180	N.A.	\$2735	+\$116	+\$406	N.A.	N.A.
E6C2496A8G	N.A.	N.A.	\$3488	\$2716	\$3055	+\$136	+\$469	+\$28	+\$ 94

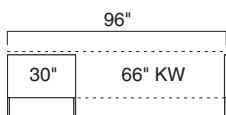

E6C2496DA8	1	2	\$3617	\$2828	\$3184	+\$136	+\$469	+\$28	+\$ 94
E6C2496EA8	1	N.A.	\$3180	N.A.	\$2735	+\$116	+\$406	N.A.	N.A.
E6C2496GA8	N.A.	N.A.	\$3488	\$2716	\$3055	+\$136	+\$469	+\$28	+\$ 94

24"D x 96"W Leg Base
27½"H Credenzas

SIN 711.2

24"D x 102"W Leg Base 27½"H Credenzas

Wood Veneer or Laminate

SIN 711.2

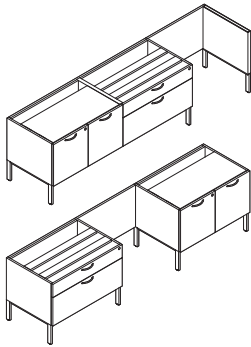

Tip: 102"W credenzas are only available with a kneewell and a combination of one or two storage components.

Tip: Storage legs may be shared with another leg base storage unit of the same depth.

Tip: When storage legs are shared between two units, the extra legs should be saved for later use, such as reconfiguration.

Tip: All credenzas with a kneewell ship knockdown.

For laminate price group 2 pricing, please refer to the electronic catalog or SmartTools.

Tip: Any credenza 102" or 108"W ships knockdown.

Tip: Soft close drawer slides only apply to storage that has 15"W and 18"W drawers.

Tip: Soft close slides are available for both dovetail and miter fold construction.

Tip: Metal shelves only available in open or hinged door components.

Tip: Back panel is inset and spans entire width of credenza.

Tip: Technology trough not available in hinged door components.

Tip: Center or inside panels are always cut out if technology trough is specified to allow cords to pass between components.

Standard Includes

- Underworksurface storage:
 - Wood group 1 case with wood group 1 front
 - Laminate price group 1 case with same or contrasting laminate front
 - Laminate price group 1 case with wood group 1 front
- Unfinished, inset back panel spanning full credenza
- Unfinished open top
- Storage leg; paint or metal
- Dovetail drawer construction
- Lock, keyed random
- Counterweight package
- Storage brace
- Standard close drawer slides

Required to Specify

- 1 Style number with appropriate suffix to indicate location of storage units
 - 2 Wood or laminate color number for underworksurface storage
 - 3 Laminate color number for laminate fronts on laminate case, if selected
 - 4 Wood color number for wood fronts on laminate cases, if selected
 - 5 Pull shape (see below under Required Selections)
 - 6 Paint or metal color number for storage leg
 - 7 Finish color number for pull
 - 8 Finish color number for lock
 - 9 Options, if selected (see below)
- ▶ See *Surface Materials*, page 566.

Required Selections

Pull Shape

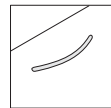

Contemporary

No cost

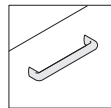

Jazz

+\$19 each

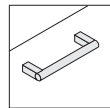

Bar

+\$26 each

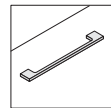

Nile

+\$26 each

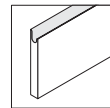

Integral*

+\$26 each

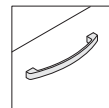

Transitional

+\$26 each

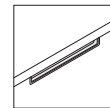

Inset

+\$26 each

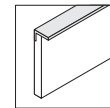

Beam

+\$37 each

*Not available on laminate or composite fronts.

	Options	Price	Required to Specify
Surface Materials	Wood underworksurface storage case		
	• Wood group 2	Prices at right	Specify wood color number.
	• Wood group 3	Prices at right	Specify wood color number.
	• Customiz stain	No cost	Specify with <i>Customiz stain</i> .
	Laminate underworksurface storage case		
	• Laminate price group 2	See information at left	Specify laminate color number.
	• Open Line laminate	+\$ 69 plus cost of laminate	▶ See <i>Surface Materials Reference Manual</i> .
	• Wood group 2 on wood fronts	Prices at right	Specify wood color number.
	• Wood group 3 on wood fronts	Prices at right	Specify wood color number.
	• Customiz stain	No cost	Specify with <i>Customiz stain</i> .
Drawer Slide	• Soft close drawer slides	+\$ 30 per drawer	Specify with <i>soft close drawers</i> .
Lock and Keying	Lock		
	• Ember chrome	No cost	Specify with <i>9250 Ember Chrome lock</i> .
	• Polished chrome	No cost	Specify with <i>9201 Polished Chrome lock</i> .
	Keying		
	• Factory- and field-installed keying units		▶ Page 622
Shelves	• ¾" shelf	No cost	Specify with <i>¾" shelf</i> .
	• Metal shelf	–\$ 26 per shelf	Specify with <i>metal shelf</i> and select paint color number.
Counterweight Package	• Counterweight package	No cost	Specify with <i>counterweight package</i> .
	• Omit counterweight package	–\$ 65 each	Specify with <i>no counterweight package</i> .
Back Panel	• Laminate full length back panel	+\$264	Specify with <i>laminate finished back panel</i> .
	• Wood full length back panel	+\$529	Specify with <i>wood finished back panel</i> .
Technology Trough	• Technology trough for power and data routing: black	+\$ 57 each	Specify with <i>technology trough</i> .
Cut-Out	• Right side only	No cost	Specify with <i>right cut-out</i> .
	• Left side only	No cost	Specify with <i>left cut-out</i> .
	• Both sides	No cost	Specify with <i>both cut-outs</i> .
	• No cut-outs	No cost	Specify with <i>no cut-outs</i> .
	• Kneewell	No cost	Specify with <i>kneewell cut-outs</i> .

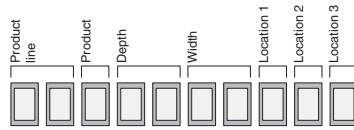

Tip: The location of the suffix within the style number determines the location of the storage unit within the credenza.

Specification Information

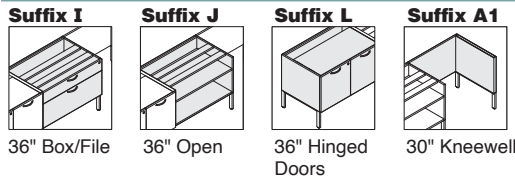

Style Number	Number of Tech Troughs	Counter-weight Package	Base Prices		Options (Add \$ to Base Price)				
			Wood Group 1 Case	Laminate Price Group 1 Case	Wood Group 1 Front or Open Front	Wood Case with Wood Front	Laminate Case with Wood Front	Wood Group 2	Wood Group 3
			Wood Group 1 Front	Laminate Price Group 1 Front	Wood Group 1 Front or Open Front	Wood Group 2	Wood Group 3	Wood Group 2	Wood Group 3

30"W Kneewell with Two 36"W Positions

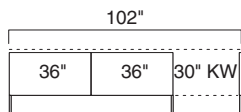
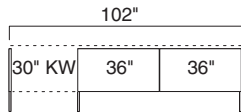

E6C24102A1II	2	4	\$6619	\$5134	\$5844	+\$221	+\$776	+\$54	+\$190
E6C24102A1IJ	2	2	\$5859	\$4716	\$5072	+\$203	+\$711	+\$28	+\$ 94
E6C24102A1IL	1	2	\$6136	\$4667	\$5361	+\$221	+\$776	+\$54	+\$190
E6C24102A1JI	2	2	\$5859	\$4716	\$5072	+\$203	+\$711	+\$28	+\$ 94
E6C24102A1JJ	2	N.A.	\$5097	N.A.	\$4298	+\$183	+\$647	N.A.	N.A.
E6C24102A1JL	1	N.A.	\$5375	\$4249	\$4588	+\$203	+\$711	+\$28	+\$ 94
E6C24102A1LI	1	2	\$6136	\$4667	\$5361	+\$221	+\$776	+\$54	+\$190
E6C24102A1LJ	1	N.A.	\$5375	\$4249	\$4588	+\$203	+\$711	+\$28	+\$ 94
E6C24102A1LL	N.A.	N.A.	\$5653	\$4200	\$4878	+\$221	+\$776	+\$54	+\$190
E6C24102IIA1	2	4	\$6619	\$5134	\$5844	+\$221	+\$776	+\$54	+\$190
E6C24102IJA1	2	2	\$5859	\$4716	\$5072	+\$203	+\$711	+\$28	+\$ 94
E6C24102ILA1	1	2	\$6136	\$4667	\$5361	+\$221	+\$776	+\$54	+\$190
E6C24102JIA1	2	2	\$5859	\$4716	\$5072	+\$203	+\$711	+\$28	+\$ 94
E6C24102JJA1	2	N.A.	\$5097	N.A.	\$4298	+\$183	+\$647	N.A.	N.A.
E6C24102JLA1	1	N.A.	\$5375	\$4249	\$4588	+\$203	+\$711	+\$28	+\$ 94
E6C24102LIA1	1	2	\$6136	\$4667	\$5361	+\$221	+\$776	+\$54	+\$190
E6C24102LJA1	1	N.A.	\$5375	\$4249	\$4588	+\$203	+\$711	+\$28	+\$ 94
E6C24102LLA1	N.A.	N.A.	\$5653	\$4200	\$4878	+\$221	+\$776	+\$54	+\$190

► Specification Information, continued on next page

24"D x 102"W Leg Base 27 1/2"H Credenzas, Wood Veneer or Laminate, continued

SIN 711.2

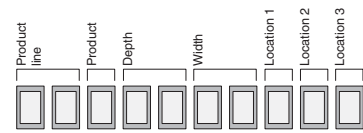

► Specification Information, continued from previous page

Specification Information

Tip: The location of the suffix within the style number determines the location of the storage unit within the credenza.

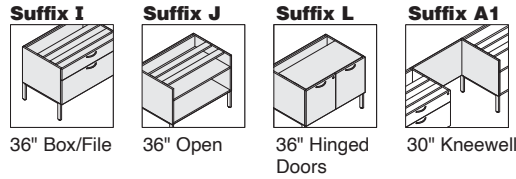

Style Number	Number of Tech Troughs	Counter-weight Package	Base Prices		Options (Add \$ to Base Price)			
			Wood Group 1 Case	Laminate Price Group 1 Case	Wood Group 1 Front	Wood Group 2	Wood Group 3	Laminate Case with Wood Front

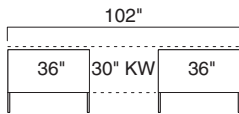

30"W Kneewell with Two 36"W Positions, continued

Style Number	Number of Tech Troughs	Counter-weight Package	Wood Group 1 Case	Laminate Price Group 1 Case	Wood Group 1 Front	Wood Group 2	Wood Group 3	Laminate Case with Wood Front	Wood Group 2	Wood Group 3
E6C24102IA1I	2	4	\$6317	\$4921	\$5631	+\$221	+\$776	+\$54	+\$190	
E6C24102IA1J	2	2	\$5557	\$4503	\$4859	+\$203	+\$711	+\$28	+\$ 94	
E6C24102IA1L	1	2	\$5833	\$4453	\$5147	+\$221	+\$776	+\$54	+\$190	
E6C24102JA1I	2	2	\$5557	\$4503	\$4859	+\$203	+\$711	+\$28	+\$ 94	
E6C24102JA1J	2	N.A.	\$4795	N.A.	\$4084	+\$183	+\$647	N.A.	N.A.	
E6C24102JA1L	1	N.A.	\$5073	\$4036	\$4375	+\$203	+\$711	+\$28	+\$ 94	
E6C24102LA1I	1	2	\$5833	\$4453	\$5147	+\$221	+\$776	+\$54	+\$190	
E6C24102LA1J	1	N.A.	\$5073	\$4036	\$4375	+\$203	+\$711	+\$28	+\$ 94	
E6C24102LA1L	N.A.	N.A.	\$5351	\$3987	\$4665	+\$221	+\$776	+\$54	+\$190	

► Specification Information, continued on next page

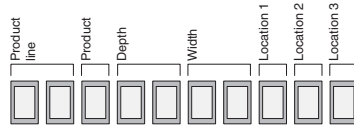

► Specification Information, continued from previous page

Specification Information

Tip: The location of the suffix within the style number determines the location of the storage unit within the credenza.

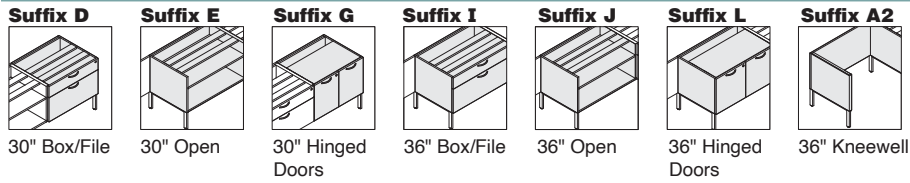

Style Number	Number of Tech Troughs	Counter-weight Package	Base Prices		Options (Add \$ to Base Price)				
			Wood Group 1 Case	Laminate Price Group 1 Case	Wood Case with Wood Front	Laminate Case with Wood Front	Wood Group 2	Wood Group 3	
			Wood Group 1 Front	Laminate Price Group 1 Front	Wood Group 1 Front or Open Front	Wood Group 2	Wood Group 3	Wood Group 2	Wood Group 3

36"W Kneewell with One 30"W Position and One 36"W Position

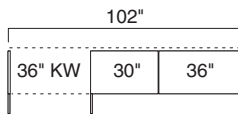

E6C24102A2DI	2	4	\$6206	\$4721	\$5431	+\$221	+\$776	+\$54	+\$190
E6C24102A2DJ	2	2	\$5446	\$4303	\$4659	+\$203	+\$711	+\$28	+\$ 94
E6C24102A2DL	1	2	\$5723	\$4254	\$4948	+\$221	+\$776	+\$54	+\$190
E6C24102A2EI	2	2	\$5769	\$4626	\$4982	+\$203	+\$711	+\$28	+\$ 94
E6C24102A2EJ	2	N.A.	\$5007	N.A.	\$4208	+\$183	+\$647	N.A.	N.A.
E6C24102A2EL	1	N.A.	\$5285	\$4159	\$4498	+\$203	+\$711	+\$28	+\$ 94
E6C24102A2GI	1	2	\$6077	\$4608	\$5302	+\$221	+\$776	+\$54	+\$190
E6C24102A2GJ	1	N.A.	\$5316	\$4190	\$4529	+\$203	+\$711	+\$28	+\$ 94
E6C24102A2GL	N.A.	N.A.	\$5593	\$4140	\$4818	+\$221	+\$776	+\$54	+\$190

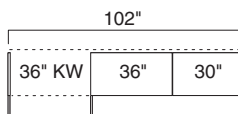

E6C24102A2ID	2	4	\$6206	\$4721	\$5431	+\$221	+\$776	+\$54	+\$190
E6C24102A2IE	2	2	\$5769	\$4626	\$4982	+\$203	+\$711	+\$28	+\$ 94
E6C24102A2IG	1	2	\$6077	\$4608	\$5302	+\$221	+\$776	+\$54	+\$190
E6C24102A2JD	2	2	\$5446	\$4303	\$4659	+\$203	+\$711	+\$28	+\$ 94
E6C24102A2JE	2	N.A.	\$5007	N.A.	\$4208	+\$183	+\$647	N.A.	N.A.
E6C24102A2JG	1	N.A.	\$5316	\$4190	\$4529	+\$203	+\$711	+\$28	+\$ 94
E6C24102A2LD	1	2	\$5723	\$4254	\$4948	+\$221	+\$776	+\$54	+\$190
E6C24102A2LE	1	N.A.	\$5285	\$4159	\$4498	+\$203	+\$711	+\$28	+\$ 94
E6C24102A2LG	N.A.	N.A.	\$5593	\$4140	\$4818	+\$221	+\$776	+\$54	+\$190

► Specification Information, continued on next page

Elective Elements

24"D x 102"W Leg Base 27½"H Credenzas, Wood Veneer or Laminate, continued

SIN 711.2

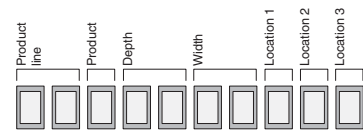

► Specification Information, continued from previous page

Specification Information

Tip: The location of the suffix within the style number determines the location of the storage unit within the credenza.

Suffix D	Suffix E	Suffix G	Suffix I	Suffix J	Suffix L	Suffix A2
30" Box/File	30" Open	30" Hinged Doors	36" Box/File	36" Open	36" Hinged Doors	36" Kneewell

Style Number	Number of Tech Troughs	Counter-weight Package	Base Prices		Options (Add \$ to Base Price)				
			Wood Group 1 Case	Laminate Price Group 1 Case	Wood Case with Wood Front	Laminate Case with Wood Front	Wood Group 2	Wood Group 3	
			Wood Group 1 Front	Laminate Price Group 1 Front	Wood Group 1 Front or Open Front	Wood Group 2	Wood Group 3	Wood Group 2	Wood Group 3

36"W Kneewell with One 30"W Position and One 36"W Position, continued

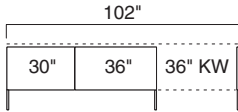

E6C24102DIA2	2	4	\$6206	\$4721	\$5431	+\$221	+\$776	+\$54	+\$190
E6C24102DJA2	2	2	\$5446	\$4303	\$4659	+\$203	+\$711	+\$28	\$ 94
E6C24102DLA2	1	2	\$5723	\$4254	\$4948	+\$221	+\$776	+\$54	+\$190
E6C24102EIA2	2	2	\$5769	\$4626	\$4982	+\$203	+\$711	+\$28	\$ 94
E6C24102EJA2	2	N.A.	\$5007	N.A.	\$4208	+\$183	+\$647	N.A.	N.A.
E6C24102ELA2	1	N.A.	\$5285	\$4159	\$4498	+\$203	+\$711	+\$28	\$ 94
E6C24102GIA2	1	2	\$6077	\$4608	\$5302	+\$221	+\$776	+\$54	+\$190
E6C24102GJA2	1	N.A.	\$5316	\$4190	\$4529	+\$203	+\$711	+\$28	\$ 94
E6C24102GLA2	N.A.	N.A.	\$5593	\$4140	\$4818	+\$221	+\$776	+\$54	+\$190

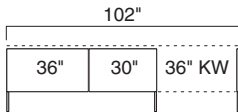

E6C24102IDA2	2	4	\$6206	\$4721	\$5431	+\$221	+\$776	+\$54	+\$190
E6C24102IEA2	2	2	\$5769	\$4626	\$4982	+\$203	+\$711	+\$28	\$ 94
E6C24102IGA2	1	2	\$6077	\$4608	\$5302	+\$221	+\$776	+\$54	+\$190
E6C24102JDA2	2	2	\$5446	\$4303	\$4659	+\$203	+\$711	+\$28	\$ 94
E6C24102JEA2	2	N.A.	\$5007	N.A.	\$4208	+\$183	+\$647	N.A.	N.A.
E6C24102JGA2	1	N.A.	\$5316	\$4190	\$4529	+\$203	+\$711	+\$28	\$ 94
E6C24102LDA2	1	2	\$5723	\$4254	\$4948	+\$221	+\$776	+\$54	+\$190
E6C24102LEA2	1	N.A.	\$5285	\$4159	\$4498	+\$203	+\$711	+\$28	\$ 94
E6C24102LGA2	N.A.	N.A.	\$5593	\$4140	\$4818	+\$221	+\$776	+\$54	+\$190

► Specification Information, continued on next page

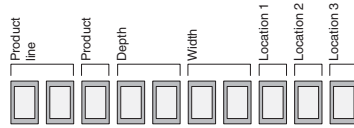

► Specification Information, continued from previous page

Specification Information

Tip: The location of the suffix within the style number determines the location of the storage unit within the credenza.

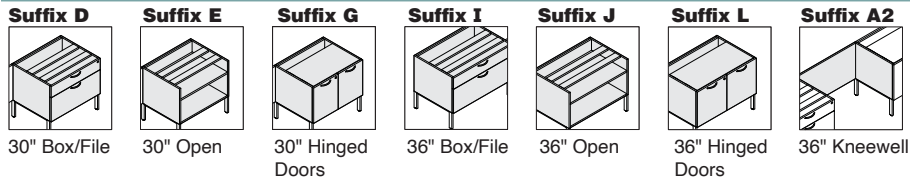

Style Number	Number of Tech Troughs	Counter-weight Package	Base Prices		Options (Add \$ to Base Price)			
			Wood Group 1 Case	Laminate Price Group 1 Case	Wood Group 1 Front	Wood Group 1 Front or Open Front	Wood Case with Wood Front	Laminate Case with Wood Front

36"W Kneewell with One 30"W Position and One 36"W Position, continued

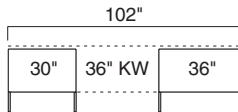

E6C24102DA2I	2	4	\$5904	\$4508	\$5218	+\$221	+\$776	+\$54	+\$190
E6C24102DA2J	2	2	\$5143	\$4089	\$4445	+\$203	+\$711	+\$28	+\$ 94
E6C24102DA2L	1	2	\$5420	\$4040	\$4734	+\$221	+\$776	+\$54	+\$190
E6C24102EA2I	2	2	\$5466	\$4412	\$4768	+\$203	+\$711	+\$28	+\$ 94
E6C24102EA2J	2	N.A.	\$4705	N.A.	\$3994	+\$183	+\$647	N.A.	N.A.
E6C24102EA2L	1	N.A.	\$4983	\$3946	\$4285	+\$203	+\$711	+\$28	+\$ 94
E6C24102GA2I	1	2	\$5775	\$4395	\$5089	+\$221	+\$776	+\$54	+\$190
E6C24102GA2J	1	N.A.	\$5013	\$3976	\$4315	+\$203	+\$711	+\$28	+\$ 94
E6C24102GA2L	N.A.	N.A.	\$5291	\$3927	\$4605	+\$221	+\$776	+\$54	+\$190

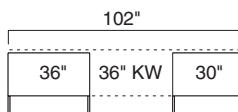

E6C24102IA2D	2	4	\$5904	\$4508	\$5218	+\$221	+\$776	+\$54	+\$190
E6C24102IA2E	2	2	\$5466	\$4412	\$4768	+\$203	+\$711	+\$28	+\$ 94
E6C24102IA2G	1	2	\$5775	\$4395	\$5089	+\$221	+\$776	+\$54	+\$190
E6C24102JA2D	2	2	\$5143	\$4089	\$4445	+\$203	+\$711	+\$28	+\$ 94
E6C24102JA2E	2	N.A.	\$4705	N.A.	\$3994	+\$183	+\$647	N.A.	N.A.
E6C24102JA2G	1	N.A.	\$5013	\$3976	\$4315	+\$203	+\$711	+\$28	+\$ 94
E6C24102LA2D	1	2	\$5420	\$4040	\$4734	+\$221	+\$776	+\$54	+\$190
E6C24102LA2E	1	N.A.	\$4983	\$3946	\$4285	+\$203	+\$711	+\$28	+\$ 94
E6C24102LA2G	N.A.	N.A.	\$5291	\$3927	\$4605	+\$221	+\$776	+\$54	+\$190

► Specification Information, continued on next page

24"D x 102"W Leg Base 27 1/2"H Credenzas, Wood Veneer or Laminate, continued

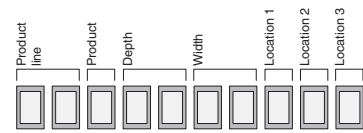

SIN 711.2

► Specification Information, continued from previous page

Specification Information

Tip: The location of the suffix within the style number determines the location of the storage unit within the credenza.

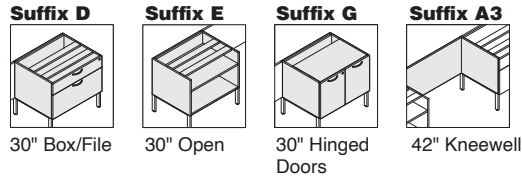

Tip: 42"W kneewell will always be centered within 102"W credenza.

Style Number	Number of Tech Troughs	Counter-weight Package	Base Prices		Options (Add \$ to Base Price)				
			Wood Group 1 Case	Laminate Price Group 1 Case	Wood		Wood		
			Wood Group 1 Front	Laminate Price Group 1 Front	Wood Group 1 Front or Open Front	Wood Case with Wood Front	Laminate Case with Wood Front	Wood Group 2	Wood Group 3

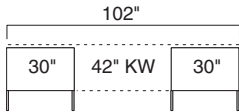

42"W Kneewell with Two 30"W Positions

Style Number	Number of Tech Troughs	Counter-weight Package	Wood Group 1 Case	Laminate Price Group 1 Case	Wood Group 1 Front or Open Front	Wood Case with Wood Front	Laminate Case with Wood Front	Wood Group 2	Wood Group 3
E6C24102DA3D	2	4	\$5491	\$4095	\$4805	+\$221	+\$776	+\$54	+\$190
E6C24102DA3E	2	2	\$5053	\$3999	\$4355	+\$203	+\$711	+\$28	+\$ 94
E6C24102DA3G	1	2	\$5362	\$3982	\$4676	+\$221	+\$776	+\$54	+\$190
E6C24102EA3D	2	2	\$5053	\$3999	\$4355	+\$203	+\$711	+\$28	+\$ 94
E6C24102EA3E	2	N.A.	\$4616	N.A.	\$3905	+\$183	+\$647	N.A.	N.A.
E6C24102EA3G	1	N.A.	\$4924	\$3887	\$4226	+\$203	+\$711	+\$28	+\$ 94
E6C24102GA3D	1	2	\$5362	\$3982	\$4676	+\$221	+\$776	+\$54	+\$190
E6C24102GA3E	1	N.A.	\$4924	\$3887	\$4226	+\$203	+\$711	+\$28	+\$ 94
E6C24102GA3G	N.A.	N.A.	\$5233	\$3869	\$4547	+\$221	+\$776	+\$54	+\$190

► Specification Information, continued on next page

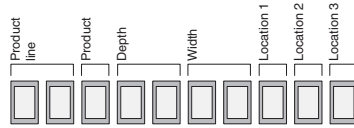

► Specification Information, continued from previous page

Specification Information

Tip: The location of the suffix within the style number determines the location of the storage unit within the credenza.

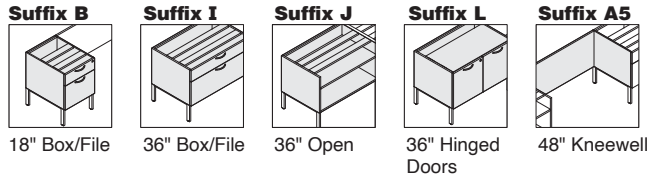

Style Number	Number of Tech Troughs	Counterweight Package	Base Prices		Options (Add \$ to Base Price)					
			Wood Group 1 Case	Laminate Price Group 1 Case	Wood Group 1 Front	Wood Group 1 Front or Open Front	Wood Case with Wood Front	Laminate Case with Wood Front	Wood Group 2	Wood Group 3
					Wood Group 2	Wood Group 3	Wood Group 2	Wood Group 3		

48"W Kneewell with One 18"W Position and One 36"W Position

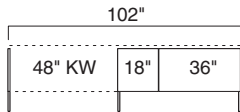

E6C24102A5BI	2	3	\$5794	\$4535	\$5120	+\$205	+\$714	+\$54	+\$190
E6C24102A5BJ	2	1	\$5034	\$4117	\$4347	+\$187	+\$649	+\$28	+\$ 94
E6C24102A5BL	1	1	\$5311	\$4068	\$4637	+\$205	+\$714	+\$54	+\$190

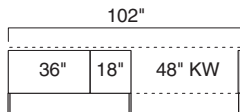

E6C24102IBA5	2	3	\$5794	\$4535	\$5120	+\$205	+\$714	+\$54	+\$190
E6C24102JBA5	2	1	\$5034	\$4117	\$4347	+\$187	+\$649	+\$28	+\$ 94
E6C24102LBA5	1	1	\$5311	\$4068	\$4637	+\$205	+\$714	+\$54	+\$190

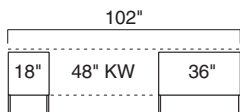

E6C24102BA5I	2	3	\$5492	\$4322	\$4907	+\$205	+\$714	+\$54	+\$190
E6C24102BA5J	2	1	\$4731	\$3903	\$4133	+\$187	+\$649	+\$28	+\$ 94
E6C24102BA5L	1	1	\$5008	\$3854	\$4423	+\$205	+\$714	+\$54	+\$190

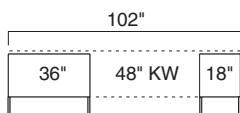

E6C24102IA5B	2	3	\$5492	\$4322	\$4907	+\$205	+\$714	+\$54	+\$190
E6C24102JA5B	2	1	\$4731	\$3903	\$4133	+\$187	+\$649	+\$28	+\$ 94
E6C24102LA5B	1	1	\$5008	\$3854	\$4423	+\$205	+\$714	+\$54	+\$190

► Specification Information, continued on next page

Elective Elements

24"D x 102"W Leg Base 27 1/2"H Credenzas, Wood Veneer or Laminate, continued

SIN 711.2

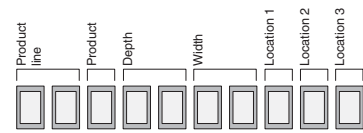

► Specification Information, continued from previous page

Specification Information

Tip: The location of the suffix within the style number determines the location of the storage unit within the credenza.

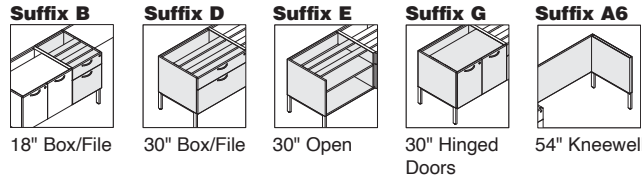

Style Number	Number of Tech Troughs	Counter-weight Package	Base Prices		Options (Add \$ to Base Price)				
			Wood Group 1 Case	Laminate Price Group 1 Case	Wood Case with Wood Front	Laminate Case with Wood Front	Wood Group 2	Wood Group 3	
			Wood Group 1 Front	Laminate Price Group 1 Front	Wood Group 1 Front or Open Front	Wood Group 2	Wood Group 3	Wood Group 2	Wood Group 3

54"W Kneewell with One 18"W Position and One 30"W Position

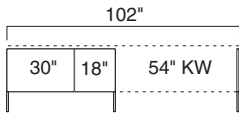
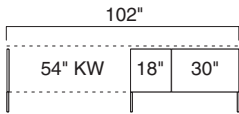

E6C24102A6BD	2	3	\$5381	\$4122	\$4707	+\$205	+\$714	+\$54	+\$190
E6C24102A6BE	2	1	\$4944	\$4027	\$4257	+\$187	+\$649	+\$28	+\$ 94
E6C24102A6BG	1	1	\$5252	\$4009	\$4578	+\$205	+\$714	+\$54	+\$190
E6C24102DBA6	2	3	\$5381	\$4122	\$4707	+\$205	+\$714	+\$54	+\$190
E6C24102EBA6	2	1	\$4944	\$4027	\$4257	+\$187	+\$649	+\$28	+\$ 94
E6C24102GBA6	1	1	\$5252	\$4009	\$4578	+\$205	+\$714	+\$54	+\$190

► Specification Information, continued on next page

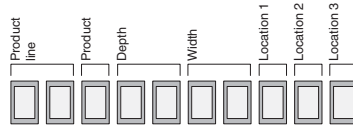

► Specification Information, continued from previous page

Specification Information

Tip: The location of the suffix within the style number determines the location of the storage unit within the credenza.

Suffix B	Suffix I	Suffix J	Suffix L	Suffix A8
18" Box/File	36" Box/File	36" Open	36" Hinged Doors	66" Kneewell

Style Number	Number of Tech Troughs	Counter-weight Package	Base Prices		Options (Add \$ to Base Price)									
			Wood Group 1 Case	Laminate Price Group 1 Case	Wood Group 1 Front	Wood Group 1 Front or Open Front	Wood Case with Wood Front	Laminate Case with Wood Front	Wood Group 2	Wood Group 3	Wood Group 2	Wood Group 3		

66"W Kneewell with Two 18"W Positions

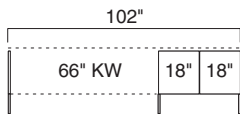

E6C24102A8BB	2	2	\$4969	\$3935	\$4395	+\$187	+\$652	+\$54	+\$190
---------------------	---	---	--------	--------	--------	--------	--------	-------	--------

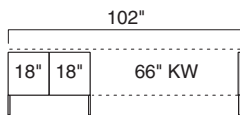

E6C24102BBA8	2	2	\$4969	\$3935	\$4395	+\$187	+\$652	+\$54	+\$190
---------------------	---	---	--------	--------	--------	--------	--------	-------	--------

66"W Kneewell with One 36"W Position

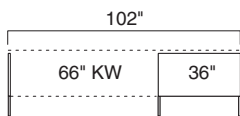

E6C24102A8I	1	2	\$4093	\$3304	\$3660	+\$136	+\$469	+\$28	+\$ 94
--------------------	---	---	--------	--------	--------	--------	--------	-------	--------

E6C24102A8J	1	N.A.	\$3331	N.A.	\$2886	+\$116	+\$406	N.A.	N.A.
--------------------	---	------	--------	------	--------	--------	--------	------	------

E6C24102A8L	N.A.	N.A.	\$3609	\$2837	\$3176	+\$136	+\$469	+\$28	+\$ 94
--------------------	------	------	--------	--------	--------	--------	--------	-------	--------

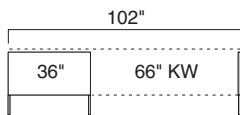

E6C24102IA8	1	2	\$4093	\$3304	\$3660	+\$136	+\$469	+\$28	+\$ 94
--------------------	---	---	--------	--------	--------	--------	--------	-------	--------

E6C24102JA8	1	N.A.	\$3331	N.A.	\$2886	+\$116	+\$406	N.A.	N.A.
--------------------	---	------	--------	------	--------	--------	--------	------	------

E6C24102LA8	N.A.	N.A.	\$3609	\$2837	\$3176	+\$136	+\$469	+\$28	+\$ 94
--------------------	------	------	--------	--------	--------	--------	--------	-------	--------

► Specification Information, continued on next page

Elective Elements

Elective Elements

24"D x 102"W Leg Base 27½"H Credenzas, Wood Veneer or Laminate, continued

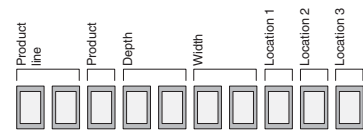

SIN 711.2

► **Specification Information, continued from previous page**

Specification Information

Tip: The location of the suffix within the style number determines the location of the storage unit within the credenza.

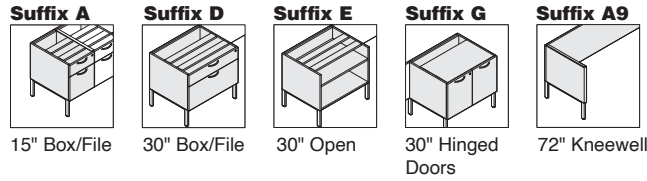

Style Number	Number of Tech Troughs	Counter-weight Package	Base Prices		Options (Add \$ to Base Price)						
			Wood Group 1 Case	Laminate Price Group 1 Case	Wood Case with Wood Front	Laminate Case with Wood Front	Wood Group 2	Wood Group 3	Wood Group 2	Wood Group 3	
			Wood Group 1 Front	Laminate Price Group 1 Front	Wood Group 1 Front or Open Front	Wood Case with Wood Front	Wood Group 2	Wood Group 3	Laminate Case with Wood Front	Wood Group 2	Wood Group 3

72"W Kneewell with Two 15"W Positions

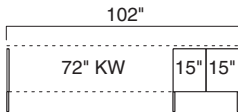

E6C24102A9AA	2	2	\$4677	\$3643	\$4103	+\$187	+\$652	+\$54	+\$190
---------------------	---	---	--------	--------	--------	--------	--------	-------	--------

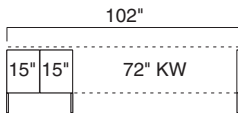

E6C24102AAA9	2	2	\$4677	\$3643	\$4103	+\$187	+\$652	+\$54	+\$190
---------------------	---	---	--------	--------	--------	--------	--------	-------	--------

72"W Kneewell with One 30"W Position

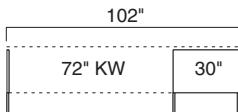

E6C24102A9D	1	2	\$3680	\$2891	\$3247	+\$136	+\$469	+\$28	+\$ 94
--------------------	---	---	--------	--------	--------	--------	--------	-------	--------

E6C24102A9E	1	N.A.	\$3241	N.A.	\$2796	+\$116	+\$406	N.A.	N.A.
--------------------	---	------	--------	------	--------	--------	--------	------	------

E6C24102A9G	N.A.	N.A.	\$3550	\$2778	\$3117	+\$136	+\$469	+\$28	+\$ 94
--------------------	------	------	--------	--------	--------	--------	--------	-------	--------

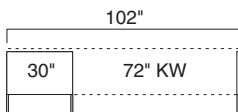

E6C24102DA9	1	2	\$3680	\$2891	\$3247	+\$136	+\$469	+\$28	+\$ 94
--------------------	---	---	--------	--------	--------	--------	--------	-------	--------

E6C24102EA9	1	N.A.	\$3241	N.A.	\$2796	+\$116	+\$406	N.A.	N.A.
--------------------	---	------	--------	------	--------	--------	--------	------	------

E6C24102GA9	N.A.	N.A.	\$3550	\$2778	\$3117	+\$136	+\$469	+\$28	+\$ 94
--------------------	------	------	--------	--------	--------	--------	--------	-------	--------

24"D x 102"W Leg Base
27½"H Credenzas

SIN 711.2

24"D x 108"W Leg Base 27½"H Credenzas

Wood Veneer or Laminate

SIN 711.2

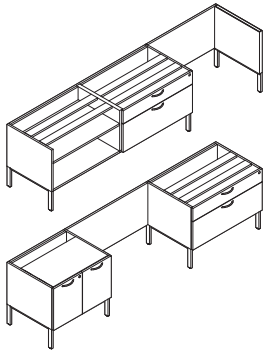

Tip: 108"W credenzas are only available with a kneewell and a combination of one or two storage components.

Tip: Storage legs may be shared with another leg base storage unit of the same depth.

Tip: When storage legs are shared between two units, the extra legs should be saved for later use, such as reconfiguration.

Tip: All credenzas with a kneewell ship knockdown.

For laminate price group 2 pricing, please refer to the electronic catalog or SmartTools.

Tip: Any credenza 102" or 108"W ships knockdown.

Tip: Soft close drawer slides only apply to storage that has 15"W drawers.

Tip: Soft close slides are available for both dovetail and miter fold construction.

Tip: Metal shelves only available in open or hinged door components.

Tip: Back panel is inset and spans entire width of credenza.

Tip: Technology trough not available in hinged door components.

Tip: Center or inside panels are always cut out if technology trough is specified to allow cords to pass between components.

Standard Includes	Required to Specify
<ul style="list-style-type: none"> Underworksurface storage: <ul style="list-style-type: none"> – Wood group 1 case with wood group 1 front – Laminate price group 1 case with same or contrasting laminate front – Laminate price group 1 case with wood group 1 front Unfinished, inset back panel spanning full credenza Unfinished open top Storage leg: paint or metal Dovetail drawer construction Lock, keyed random Counterweight package Storage brace Standard close drawer slides 	<ol style="list-style-type: none"> Style number with appropriate suffix to indicate location of storage units Wood or laminate color number for underworksurface storage Laminate color number for laminate fronts on laminate case, if selected Wood color number for wood fronts on laminate cases, if selected Pull shape (see below under Required Selections) Paint or metal color number for storage leg Finish color number for pull Finish color number for lock Options, if selected (see below) <p>▶ See <i>Surface Materials</i>, page 566.</p>

Required Selections	
Pull Shape	
Contemporary No cost	Jazz +\$19 each
Bar +\$26 each	Nile +\$26 each
Integral* +\$26 each	Transitional +\$26 each
Inset +\$26 each	Beam +\$37 each

*Not available on laminate or composite fronts.

Options	Price	Required to Specify
Surface Materials	Wood underworksurface storage case <ul style="list-style-type: none"> Wood group 2 Prices at right Wood group 3 Prices at right Customiz stain No cost 	Specify wood color number. Specify wood color number. Specify with <i>Customiz stain</i> .
	Laminate underworksurface storage case <ul style="list-style-type: none"> Laminate price group 2 See information at left Open Line laminate +\$ 69 plus cost of laminate Wood group 2 on wood fronts Prices at right Wood group 3 on wood fronts Prices at right Customiz stain No cost 	Specify laminate color number. ▶ See <i>Surface Materials Reference Manual</i> . Specify wood color number. Specify wood color number. Specify with <i>Customiz stain</i> .
Drawer Slide	<ul style="list-style-type: none"> Soft close drawer slides +\$ 30 per drawer 	Specify with <i>soft close drawers</i> .
Lock and Keying	Lock <ul style="list-style-type: none"> Ember chrome No cost Polished chrome No cost 	Specify with <i>9250 Ember Chrome lock</i> . Specify with <i>9201 Polished Chrome lock</i> .
	Keying <ul style="list-style-type: none"> Factory- and field-installed keying units 	▶ Page 622
Shelves	<ul style="list-style-type: none"> ¾" shelf No cost Metal shelf –\$ 26 per shelf 	Specify with <i>¾" shelf</i> . Specify with <i>metal shelf</i> and select paint color number.
Counterweight Package	<ul style="list-style-type: none"> Counterweight package No cost Omit counterweight package –\$ 65 each 	Specify with <i>counterweight package</i> . Specify with <i>no counterweight package</i> .
Back Panel	<ul style="list-style-type: none"> Laminate full length back panel +\$280 Wood full length back panel +\$560 	Specify with <i>laminate finished back panel</i> . Specify with <i>wood finished back panel</i> .
Technology Trough	<ul style="list-style-type: none"> Technology trough for power and data routing: black +\$ 57 each 	Specify with <i>technology trough</i> .
Cut-Out	<ul style="list-style-type: none"> Right side only No cost Left side only No cost Both sides No cost No cut-outs No cost Kneewell No cost 	Specify with <i>right cut-out</i> . Specify with <i>left cut-out</i> . Specify with <i>both cut-outs</i> . Specify with <i>no cut-outs</i> . Specify with <i>kneewell cut-outs</i> .

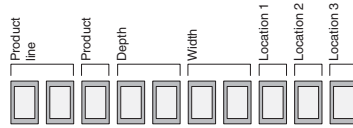

Tip: The location of the suffix within the style number determines the location of the storage unit within the credenza.

Specification Information

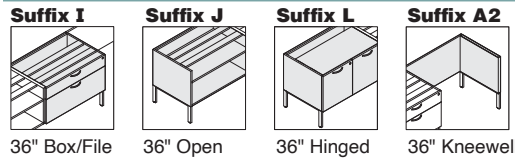

Style Number	Number of Tech Troughs	Counterweight Package	Base Prices		Options (Add \$ to Base Price)			
			Wood Group 1 Case	Laminate Price Group 1 Case	Wood Group 1 Front	Wood Group 1 Front or Open Front	Wood Case with Wood Front	Laminate Case with Wood Front

36"W Kneewell with Two 36"W Positions

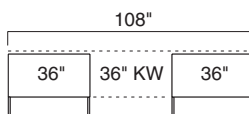
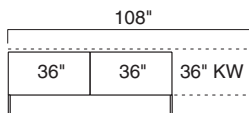
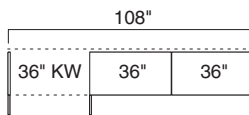

E6C24108A2II	2	4	\$6682	\$5197	\$5907	+\$221	+\$776	+\$54	+\$190
E6C24108A2IJ	2	2	\$5920	\$4777	\$5133	+\$203	+\$711	+\$28	+\$ 94
E6C24108A2IL	1	2	\$6198	\$4729	\$5423	+\$221	+\$776	+\$54	+\$190
E6C24108A2JI	2	2	\$5920	\$4777	\$5133	+\$203	+\$711	+\$28	+\$ 94
E6C24108A2JJ	2	N.A.	\$5160	N.A.	\$4361	+\$183	+\$647	N.A.	N.A.
E6C24108A2JL	1	N.A.	\$5438	\$4312	\$4651	+\$203	+\$711	+\$28	+\$ 94
E6C24108A2LI	1	2	\$6198	\$4729	\$5423	+\$221	+\$776	+\$54	+\$190
E6C24108A2LJ	1	N.A.	\$5438	\$4312	\$4651	+\$203	+\$711	+\$28	+\$ 94
E6C24108A2LL	N.A.	N.A.	\$5714	\$4261	\$4939	+\$229	+\$807	+\$54	+\$190
E6C24108IIA2	2	4	\$6682	\$5197	\$5907	+\$221	+\$776	+\$54	+\$190
E6C24108IJA2	2	2	\$5920	\$4777	\$5133	+\$203	+\$711	+\$28	+\$ 94
E6C24108ILA2	1	2	\$6198	\$4729	\$5423	+\$221	+\$776	+\$54	+\$190
E6C24108JIA2	2	2	\$5920	\$4777	\$5133	+\$203	+\$711	+\$28	+\$ 94
E6C24108JJA2	2	N.A.	\$5160	N.A.	\$4361	+\$183	+\$647	N.A.	N.A.
E6C24108JLA2	1	N.A.	\$5438	\$4312	\$4651	+\$203	+\$711	+\$28	+\$ 94
E6C24108LIA2	1	2	\$6198	\$4729	\$5423	+\$221	+\$776	+\$54	+\$190
E6C24108LJA2	1	N.A.	\$5438	\$4312	\$4651	+\$203	+\$711	+\$28	+\$ 94
E6C24108LLA2	N.A.	N.A.	\$5714	\$4261	\$4939	+\$221	+\$776	+\$54	+\$190
E6C24108IA2I	2	4	\$6380	\$4984	\$5694	+\$221	+\$776	+\$54	+\$190
E6C24108IA2J	2	2	\$5618	\$4564	\$4920	+\$203	+\$711	+\$28	+\$ 94
E6C24108IA2L	1	2	\$5896	\$4516	\$5210	+\$221	+\$776	+\$54	+\$190
E6C24108JA2I	2	2	\$5618	\$4564	\$4920	+\$203	+\$711	+\$28	+\$ 94
E6C24108JA2J	2	N.A.	\$4857	N.A.	\$4146	+\$183	+\$647	N.A.	N.A.
E6C24108JA2L	1	N.A.	\$5135	\$4098	\$4437	+\$203	+\$711	+\$28	+\$ 94
E6C24108LA2I	1	2	\$5896	\$4516	\$5210	+\$221	+\$776	+\$54	+\$190
E6C24108LA2J	1	N.A.	\$5135	\$4098	\$4437	+\$203	+\$711	+\$28	+\$ 94
E6C24108LA2L	N.A.	N.A.	\$5412	\$4048	\$4726	+\$221	+\$776	+\$54	+\$190

► Specification Information, continued on next page

24"D x 108"W Leg Base 27½"H Credenzas, Wood Veneer or Laminate, continued

SIN 711.2

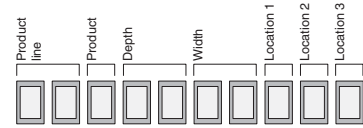

► Specification Information, continued from previous page

Specification Information

Tip: The location of the suffix within the style number determines the location of the storage unit within the credenza.

Suffix D	Suffix E	Suffix G	Suffix I	Suffix J	Suffix L	Suffix A3
30" Box/File	30" Open	30" Hinged Doors	36" Box/File	36" Open	36" Hinged Doors	42" Kneewell

Style Number	Number of Tech Troughs	Counter-weight Package	Base Prices		Options (Add \$ to Base Price)				
			Wood Group 1 Case	Laminate Price Group 1 Case	Wood Case with Wood Front	Laminate Case with Wood Front	Wood Group 2	Wood Group 3	
			Wood Group 1 Front	Laminate Price Group 1 Front	Wood Group 1 Front or Open Front	Wood Group 2	Wood Group 3	Wood Group 2	Wood Group 3

Tip: 42"W kneewell will always be centered within a 108"W credenza.

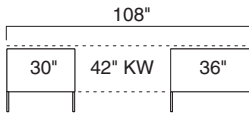

42"W Kneewell with One 30"W Position and One 36"W Position

E6C24108DA3I	2	4	\$5967	\$4571	\$5281	+\$221	+\$776	+\$54	+\$190
E6C24108DA3J	2	2	\$5205	\$4151	\$4507	+\$203	+\$711	+\$28	+\$ 94
E6C24108DA3L	1	2	\$5483	\$4103	\$4797	+\$221	+\$776	+\$54	+\$190
E6C24108EA3I	2	2	\$5528	\$4474	\$4830	+\$203	+\$711	+\$28	+\$ 94
E6C24108EA3J	2	N.A.	\$4767	N.A.	\$4056	+\$183	+\$647	N.A.	N.A.
E6C24108EA3L	1	N.A.	\$5045	\$4008	\$4347	+\$203	+\$711	+\$28	+\$ 94
E6C24108GA3I	1	2	\$5836	\$4456	\$5150	+\$221	+\$776	+\$54	+\$190
E6C24108GA3J	1	N.A.	\$5076	\$4039	\$4378	+\$203	+\$711	+\$28	+\$ 94
E6C24108GA3L	N.A.	N.A.	\$5354	\$3990	\$4668	+\$221	+\$776	+\$54	+\$190
E6C24108IA3D	2	4	\$5967	\$4571	\$5281	+\$221	+\$776	+\$54	+\$190
E6C24108IA3E	2	2	\$5528	\$4474	\$4830	+\$203	+\$711	+\$28	+\$ 94
E6C24108IA3G	1	2	\$5836	\$4456	\$5150	+\$221	+\$776	+\$54	+\$190
E6C24108JA3D	2	2	\$5205	\$4151	\$4507	+\$203	+\$711	+\$28	+\$ 94
E6C24108JA3E	2	N.A.	\$4767	N.A.	\$4056	+\$183	+\$647	N.A.	N.A.
E6C24108JA3G	1	N.A.	\$5076	\$4039	\$4378	+\$203	+\$711	+\$28	+\$ 94
E6C24108LA3D	1	2	\$5483	\$4103	\$4797	+\$221	+\$776	+\$54	+\$190
E6C24108LA3E	1	N.A.	\$5045	\$4008	\$4347	+\$203	+\$711	+\$28	+\$ 94
E6C24108LA3G	N.A.	N.A.	\$5354	\$3990	\$4668	+\$221	+\$776	+\$54	+\$190

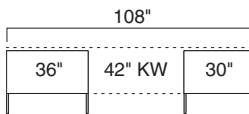

► Specification Information, continued on next page

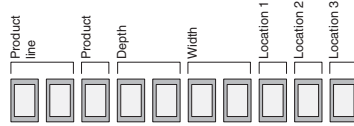

► Specification Information, continued from previous page

Specification Information

Tip: The location of the suffix within the style number determines the location of the storage unit within the credenza.

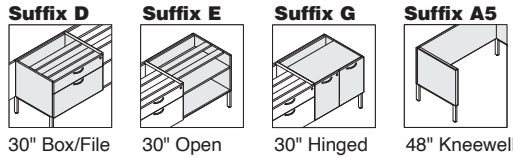

Style Number	Number of Tech Troughs	Counterweight Package	Base Prices		Options (Add \$ to Base Price)			
			Wood Group 1 Case	Laminate Price Group 1 Case	Wood Group 1 Front	Wood Group 1 Open Front	Wood Case with Wood Front	Laminate Case with Wood Front

48"W Kneewell with Two 30"W Positions

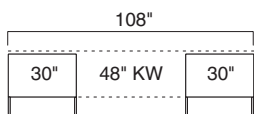
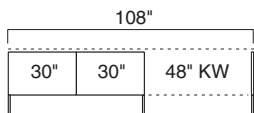
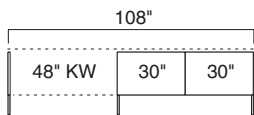

E6C24108A5DD	2	4	\$5856	\$4371	\$5081	+\$221	+\$776	+\$54	+\$190
E6C24108A5DE	2	2	\$5417	\$4274	\$4630	+\$203	+\$711	+\$28	+\$ 94
E6C24108A5DG	1	2	\$5726	\$4257	\$4951	+\$221	+\$776	+\$54	+\$190
E6C24108A5ED	2	2	\$5417	\$4274	\$4630	+\$203	+\$711	+\$28	+\$ 94
E6C24108A5EE	2	N.A.	\$4979	N.A.	\$4180	+\$183	+\$647	N.A.	N.A.
E6C24108A5EG	1	N.A.	\$5288	\$4162	\$4501	+\$203	+\$711	+\$28	+\$ 94
E6C24108A5GD	1	2	\$5726	\$4257	\$4951	+\$221	+\$776	+\$54	+\$190
E6C24108A5GE	1	N.A.	\$5288	\$4162	\$4501	+\$203	+\$711	+\$28	+\$ 94
E6C24108A5GG	N.A.	N.A.	\$5597	\$4144	\$4822	+\$221	+\$776	+\$54	+\$190
E6C24108DDA5	2	4	\$5856	\$4371	\$5081	+\$221	+\$776	+\$54	+\$190
E6C24108DEA5	2	2	\$5417	\$4274	\$4630	+\$203	+\$711	+\$28	+\$ 94
E6C24108DGA5	1	2	\$5726	\$4257	\$4951	+\$221	+\$776	+\$54	+\$190
E6C24108EDA5	2	2	\$5417	\$4274	\$4630	+\$203	+\$711	+\$28	+\$ 94
E6C24108EEA5	2	N.A.	\$4979	N.A.	\$4180	+\$183	+\$647	N.A.	N.A.
E6C24108EGA5	1	N.A.	\$5288	\$4162	\$4501	+\$203	+\$711	+\$28	+\$ 94
E6C24108GDA5	1	2	\$5726	\$4257	\$4951	+\$221	+\$776	+\$54	+\$190
E6C24108GEA5	1	N.A.	\$5288	\$4162	\$4501	+\$203	+\$711	+\$28	+\$ 94
E6C24108GGA5	N.A.	N.A.	\$5597	\$4144	\$4822	+\$221	+\$776	+\$54	+\$190
E6C24108DA5D	2	4	\$5553	\$4157	\$4867	+\$221	+\$776	+\$54	+\$190
E6C24108DA5E	2	2	\$5115	\$4061	\$4417	+\$203	+\$711	+\$28	+\$ 94
E6C24108DA5G	1	2	\$5423	\$4043	\$4737	+\$221	+\$776	+\$54	+\$190
E6C24108EA5D	2	2	\$5115	\$4061	\$4417	+\$203	+\$711	+\$28	+\$ 94
E6C24108EA5E	2	N.A.	\$4677	N.A.	\$3966	+\$183	+\$647	N.A.	N.A.
E6C24108EA5G	1	N.A.	\$4986	\$3949	\$4288	+\$203	+\$711	+\$28	+\$ 94
E6C24108GA5D	1	2	\$5423	\$4043	\$4737	+\$221	+\$776	+\$54	+\$190
E6C24108GA5E	1	N.A.	\$4986	\$3949	\$4288	+\$203	+\$711	+\$28	+\$ 94
E6C24108GA5G	N.A.	N.A.	\$5294	\$3930	\$4608	+\$221	+\$776	+\$54	+\$190

► Specification Information, continued on next page

24"D x 108"W Leg Base 27 1/2"H Credenzas, Wood Veneer or Laminate, continued

SIN 711.2

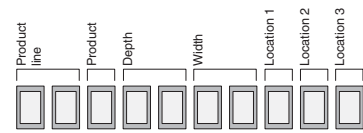

► Specification Information, continued from previous page

Specification Information

Tip: The location of the suffix within the style number determines the location of the storage unit within the credenza.

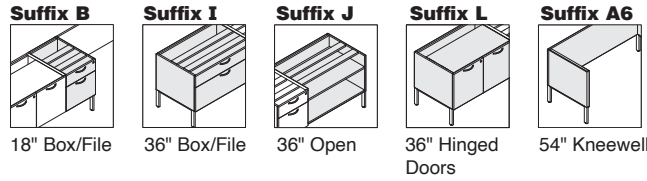

Style Number	Number of Tech Troughs	Counter-weight Package	Base Prices		Options (Add \$ to Base Price)				
			Wood Group 1 Case	Laminate Price Group 1 Case	Wood Case with Wood Front	Laminate Case with Wood Front	Wood Group 2	Wood Group 3	
			Wood Group 1 Front	Laminate Price Group 1 Front	Wood Group 1 Front or Open Front	Wood Group 2	Wood Group 3	Wood Group 2	Wood Group 3

54"W Kneewell with One 18"W Position and One 36"W Position

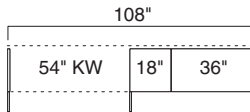

E6C24108A6BI	2	3	\$5857	\$4598	\$5183	+\$205	+\$714	+\$54	+\$190
E6C24108A6BJ	2	1	\$5095	\$4178	\$4408	+\$187	+\$649	+\$28	+\$ 94
E6C24108A6BL	1	1	\$5373	\$4130	\$4699	+\$205	+\$714	+\$54	+\$190

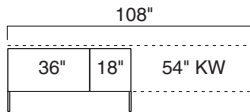

E6C24108IBA6	2	3	\$5857	\$4598	\$5183	+\$205	+\$714	+\$54	+\$190
E6C24108JBA6	2	1	\$5095	\$4178	\$4408	+\$187	+\$649	+\$28	+\$ 94
E6C24108LBA6	1	1	\$5373	\$4130	\$4699	+\$205	+\$714	+\$54	+\$190

► Specification Information, continued on next page

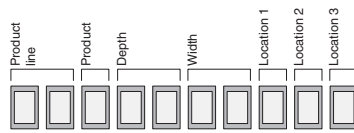

► Specification Information, continued from previous page

Specification Information

Tip: The location of the suffix within the style number determines the location of the storage unit within the credenza.

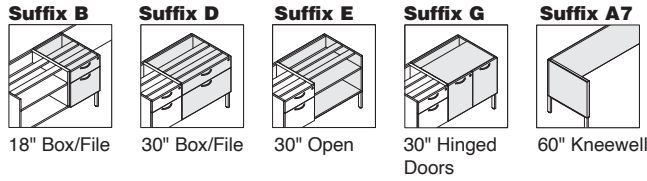

Style Number	Number of Tech Troughs	Counter-weight Package	Base Prices		Options (Add \$ to Base Price)				
			Wood Group 1 Case	Laminate Price Group 1 Case	Wood Case with Wood Front	Laminate Case with Wood Front	Wood Group 2	Wood Group 3	
			Wood Group 1 Front	Laminate Price Group 1 Front	Wood Group 1 Front or Open Front	Wood Group 2	Wood Group 3	Wood Group 2	Wood Group 3

60"W Kneewell with One 18"W Position and One 30"W Position

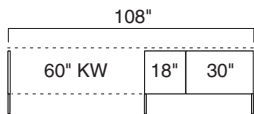

E6C24108A7BD	2	3	\$5444	\$4185	\$4770	+\$205	+\$714	+\$54	+\$190
E6C24108A7BE	2	1	\$5005	\$4088	\$4318	+\$187	+\$649	+\$28	+\$ 94
E6C24108A7BG	1	1	\$5314	\$4071	\$4640	+\$205	+\$714	+\$54	+\$190

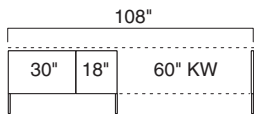

E6C24108DBA7	2	3	\$5444	\$4185	\$4770	+\$205	+\$714	+\$54	+\$190
E6C24108EBA7	2	1	\$5005	\$4088	\$4318	+\$187	+\$649	+\$28	+\$ 94
E6C24108GBA7	1	1	\$5314	\$4071	\$4640	+\$205	+\$714	+\$54	+\$190

► Specification Information, continued on next page

Elective Elements

24"D x 108"W Leg Base 27 1/2"H Credenzas, Wood Veneer or Laminate, continued

SIN 711.2

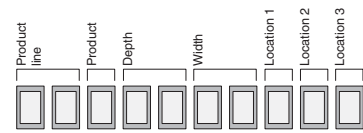

► **Specification Information, continued from previous page**

Specification Information

Tip: The location of the suffix within the style number determines the location of the storage unit within the credenza.

Suffix B	Suffix I	Suffix J	Suffix L	Suffix A9
18" Box/File	36" Box/File	36" Open	36" Hinged Doors	72" Kneewell

Style Number	Number of Tech Troughs	Counter-weight Package	Base Prices			Options (Add \$ to Base Price)				
			Wood Group 1 Case	Laminate Price Group 1 Case	Wood Group 1 Front	Laminate Price Group 1 Front	Wood Group 1 Front or Open Front	Wood Case with Wood Front	Laminate Case with Wood Front	Wood Group 2

72"W Kneewell with Two 18"W Positions

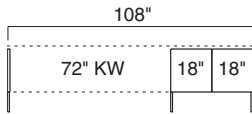

E6C24108A9BB	2	2	\$5032	\$3998	\$4458	+\$187	+\$652	+\$54	+\$190
---------------------	---	---	--------	--------	--------	--------	--------	-------	--------

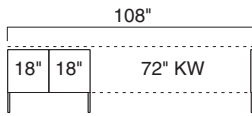

E6C24108BBA9	2	2	\$5032	\$3998	\$4458	+\$187	+\$652	+\$54	+\$190
---------------------	---	---	--------	--------	--------	--------	--------	-------	--------

72"W Kneewell with One 36"W Position

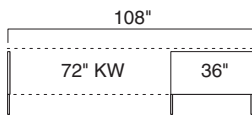

E6C24108A9I	1	2	\$4154	\$3365	\$3721	+\$136	+\$469	+\$28	+\$ 94
--------------------	---	---	--------	--------	--------	--------	--------	-------	--------

E6C24108A9J	1	N.A.	\$3394	N.A.	\$2961	+\$116	+\$406	N.A.	N.A.
--------------------	---	------	--------	------	--------	--------	--------	------	------

E6C24108A9L	N.A.	N.A.	\$3671	\$2899	\$3238	+\$136	+\$469	+\$28	+\$ 94
--------------------	------	------	--------	--------	--------	--------	--------	-------	--------

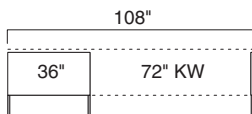

E6C24108IA9	1	2	\$4154	\$3365	\$3721	+\$136	+\$469	+\$28	+\$ 94
--------------------	---	---	--------	--------	--------	--------	--------	-------	--------

E6C24108JA9	1	N.A.	\$3394	N.A.	\$2961	+\$116	+\$406	N.A.	N.A.
--------------------	---	------	--------	------	--------	--------	--------	------	------

E6C24108LA9	N.A.	N.A.	\$3671	\$2899	\$3238	+\$136	+\$469	+\$28	+\$ 94
--------------------	------	------	--------	--------	--------	--------	--------	-------	--------

24"D x 108"W Leg Base
27½"H Credenzas

SIN 711.2

Kneewells

Wood Veneer or Laminate
SIN 711.2

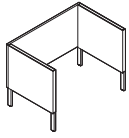

Tip: Worksurface not included in kneewell style number, order separately.

Tip: A single kneewell ships knocked down.

Tip: A kneewell cannot share its storage legs with other leg base units as its storage legs have a different plate.

For laminate price group 2 pricing, please refer to the electronic catalog or SmartTools.

Tip: Back panel is inset and spans entire width of kneewell.

Standard Includes	Required to Specify
<ul style="list-style-type: none"> Kneewell: <ul style="list-style-type: none"> Wood group 1 case Laminate price group 1 case Unfinished, inset back panel spanning full credenza Unfinished open top Storage leg: paint or metal 	<ol style="list-style-type: none"> Style number Wood or laminate color number for kneewell Paint or metal color number for storage leg Options, if selected (see below) <p>▶ See <i>Surface Materials</i>, page 566.</p>

Options	Price	Required to Specify
Surface Materials Wood kneewell <ul style="list-style-type: none"> Wood group 2 Wood group 3 Customiz stain Laminate kneewell <ul style="list-style-type: none"> Laminate price group 2 Open Line laminate 	Prices below and at right Prices below and at right No cost See information at left +\$69 plus cost of laminate	Specify wood color number. Specify wood color number. Specify with <i>Customiz stain</i> . Specify laminate color number. ▶ See <i>Surface Materials Reference Manual</i> .
Back Panel <ul style="list-style-type: none"> Unfinished full length back panel Laminate full length back panel Wood full length back panel 	No cost Prices below and at right Prices below and at right	Specify with <i>unfinished back panel</i> . Specify with <i>laminate finished back panel</i> . Specify with <i>wood finished back panel</i> .

Specification Information									
Dimensions			Style Number	Base Prices		Options (Add \$ to Base Price)			
D	W	H		Wood Group 1 Case	Laminate Price Group 1 Case	Wood Case		Finished Back Panel	
				Wood Front	Wood Front	Wood Group 2	Wood Group 3	Laminate	Wood

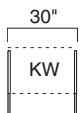

30"W Kneewell

24"	30"	27½"	E6C2430A1	\$1122	\$ 944	+\$47	+\$164	+\$ 78	+\$156
-----	-----	------	------------------	--------	--------	-------	--------	--------	--------

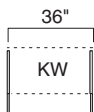

36"W Kneewell

24"	36"	27½"	E6C2436A2	\$1184	\$1006	+\$47	+\$164	+\$ 93	+\$187
-----	-----	------	------------------	--------	--------	-------	--------	--------	--------

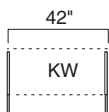

42"W Kneewell

24"	42"	27½"	E6C2442A3	\$1246	\$1068	+\$47	+\$164	+\$109	+\$217
-----	-----	------	------------------	--------	--------	-------	--------	--------	--------

▶ Specification Information, continued on next page

► Specification Information, continued from previous page

Specification Information									
Dimensions			Style Number	Base Prices		Options (Add \$ to Base Price)			
D	W	H		Wood Group 1 Case	Laminate Price Group 1 Case	Wood Case		Finished Back Panel	
				Wood Front	Wood Front	Wood Group 2	Wood Group 3	Laminate	Wood

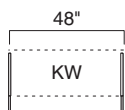

48"W Kneewell

24"	48"	27 1/2"	E6C2448A5	\$1309	\$1131	+\$47	+\$164	+\$124	+\$249
-----	-----	---------	------------------	--------	--------	-------	--------	--------	--------

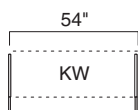

54"W Kneewell

24"	54"	27 1/2"	E6C2454A6	\$1370	\$1192	+\$47	+\$164	+\$139	+\$280
-----	-----	---------	------------------	--------	--------	-------	--------	--------	--------

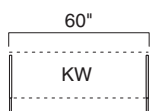

60"W Kneewell

24"	60"	27 1/2"	E6C2460A7	\$1433	\$1255	+\$47	+\$164	+\$156	+\$311
-----	-----	---------	------------------	--------	--------	-------	--------	--------	--------

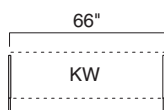

66"W Kneewell

24"	66"	27 1/2"	E6C2466A8	\$1494	\$1316	+\$47	+\$164	+\$171	+\$342
-----	-----	---------	------------------	--------	--------	-------	--------	--------	--------

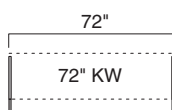

72"W Kneewell

24"	72"	27 1/2"	E6C2472A9	\$1557	\$1379	+\$47	+\$164	+\$187	+\$373
-----	-----	---------	------------------	--------	--------	-------	--------	--------	--------

Elective Elements

Leg Base Freestanding Bookcases—Open

Wood Veneer or Laminate

SIN 711.2

Tip: Freestanding bookcases that are 65⁵/₈" or 72¹/₂"H have an unfinished back and must be placed up against a wall or back-to-back.

Tip: Leg base freestanding bookcases may be ganged when a suspension/ganging hardware kit is used, and share legs at the seam. Note: The exteriors of each will be defaced.

Tip: When storage legs are shared between two units, the extra legs should be saved for later use, such as reconfiguration.

Tip: Shelves with less than 12" of clearance height will not hold some binders in the vertical orientation.

Tip: Specify optional 1¹/₈" thick heavy load shelves for heavy load conditions. Heavy load conditions are defined as loads of 100 lbs or greater. Heavy load shelves should be specified on wider units (30"W or 36"W) loaded with books or other heavy objects. Metal shelves also support heavy loads.

For laminate price group 2 pricing, please refer to the electronic catalog or SmartTools.

Standard Includes	Required to Specify
<ul style="list-style-type: none"> Open bookcase –Wood group 1 or laminate price group 1 Storage leg: paint or metal Shelves: wood, laminate, or metal 	<ol style="list-style-type: none"> Style number Wood or laminate color number for bookcase Paint or metal color number for storage leg Options, if selected (see below) <p>▶ See <i>Surface Materials</i>, page 566.</p>

Options	Price	Required to Specify
Surface Materials Wood bookcase <ul style="list-style-type: none"> Wood group 2 Wood group 3 Customiz stain Laminate bookcase <ul style="list-style-type: none"> Laminate price group 2 Open Line laminate 	Prices below and at right Prices below and at right No cost See information at left +\$ 69 plus cost of laminate	Specify wood color number. Specify wood color number. Specify with <i>Customiz stain</i> . Specify laminate color number. ▶ See <i>Surface Materials Reference Manual</i> .
Shelves Heavy load shelves <ul style="list-style-type: none"> On 45"H and 65⁵/₈"H bookcases On 72¹/₂"H bookcases Metal shelves <ul style="list-style-type: none"> Metal shelf 	+\$ 48 +\$117 –\$ 26 per shelf	Specify with <i>heavy load shelves</i> . Specify with <i>heavy load shelves</i> . Specify with <i>metal shelves</i> and select paint color number.

Specification Information							
Dimensions			Style	Base Prices		Options	
D	W	H	Number	Wood Group 1 Case	Laminate Price Group 1 Case	(Add \$ to Base Price)	
				Open Front	Open Front	Wood	
						Wood Case with Open Front	
						Wood Group 2	Wood Group 3

Leg Base Freestanding Bookcases

Open

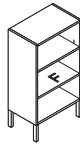

45"H Bookcases

15"	30"	45"	E6BFL153045P	\$2195	\$1713	+\$177	+\$624
15"	36"	45"	E6BFL153645P	\$2298	\$1816	+\$177	+\$624

▶ **Specification Information, continued on next page**

F=Fixed Shelf

► Specification Information, continued from previous page

Specification Information							
Dimensions			Style Number	Base Prices		Options	
D	W	H		Wood Group 1 Case	Laminate Price Group 1 Case	(Add \$ to Base Price)	Wood
				Open Front	Open Front		Wood Case with Open Front
							Wood : Wood Group 2 : Group 3

Leg Base Freestanding Bookcases

Open

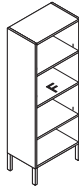

65 5/8"H Bookcases

15"	30"	65 5/8"	E6BFL153065P	\$2590	\$2108	+\$330	+\$1154
15"	36"	65 5/8"	E6BFL153665P	\$2713	\$2231	+\$330	+\$1154

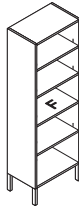

72 1/2"H Bookcases

15"	30"	72 1/2"	E6BFL153072P	\$2776	\$2294	+\$330	+\$1154
15"	36"	72 1/2"	E6BFL153672P	\$2909	\$2427	+\$330	+\$1154

F=Fixed Shelf

Leg Base Freestanding Bookcases with Doors

Wood Veneer or Laminate

SIN 711.2

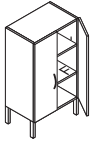

Tip: Freestanding bookcases that are 65⁵/₈" or 72¹/₂"H have an unfinished back and must be placed up against a wall or back-to-back.

Tip: Hinged-door units with integral or beam pulls will have a single pull on the right-hand door.

Tip: When storage legs are shared between two units, be sure to keep the extras for later use, such as reconfiguration.

Standard Includes	Required to Specify
-------------------	---------------------

- Bookcase with hinged doors:
 - Wood group 1 case with wood group 1 front
 - Laminate price group 1 case with same or contrasting laminate front
 - Laminate price group 1 case with wood group 1 front
- Storage leg: paint or metal
- Shelves: wood, laminate, or metal

- 1 Style number
 - 2 Wood or laminate color number for bookcase
 - 3 Laminate color number for laminate fronts on laminate case, if selected
 - 4 Wood color number for wood fronts on laminate cases, if selected
 - 5 Pull shape (see below under Required Selections)
 - 6 Finish color number for pull
 - 7 Paint or metal color number for storage leg
 - 8 Options, if selected (see below)
- ▶ See *Surface Materials*, page 566.

Required Selections	
---------------------	--

Pull Shape

Contemporary	Jazz	Bar	Nile	Integral*	Transitional	Inset	Beam
No cost	+\$19 each	+\$26 each	+\$26 each	+\$26 each	+\$26 each	+\$26 each	+\$37 each

*Not available on laminate or composite fronts.

Options	Price	Required to Specify
---------	-------	---------------------

Surface Materials

Wood bookcase case

- Wood group 2
- Wood group 3
- Customiz stain

Prices at right
Prices at right
No cost

Specify wood color number.
Specify wood color number.
Specify with *Customiz stain*.

Laminate bookcase case

- Laminate price group 2
- Open Line laminate

See information at left
+\$ 69 plus cost of laminate
Prices at right
Prices at right
No cost

Specify laminate color number.
▶ See *Surface Materials Reference Manual*.
Specify wood color number.
Specify wood color number.
Specify with *Customiz stain*.

Painted Glass Doors for Bookcases

Non-locking glass doors

- On 30"W x 45"H bookcases
- On 36"W x 45"H bookcases
- On 30"W x 65⁵/₈"H bookcases
- On 36"W x 65⁵/₈"H bookcases
- On 30"W x 72¹/₂"H bookcases
- On 36"W x 72¹/₂"H bookcases

+\$ 704 per door
+\$ 775 per door
+\$ 870 per door
+\$1018 per door
+\$ 945 per door
+\$1058 per door

Specify with *glass doors* and select finish.
Specify with *glass doors* and select finish.
Specify with *glass doors* and select finish.
Specify with *glass doors* and select finish.
Specify with *glass doors* and select finish.
Specify with *glass doors* and select finish.

Frame

- Painted metal frame for glass doors

No cost

Specify with *frame* and select paint color number.

Mirrored Glass Doors for Bookcases

Non-locking glass doors

- On 30"W x 45"H bookcases
- On 36"W x 45"H bookcases
- On 30"W x 65⁵/₈"H bookcases
- On 36"W x 65⁵/₈"H bookcases
- On 30"W x 72¹/₂"H bookcases
- On 36"W x 72¹/₂"H bookcases

+\$ 986 per door
+\$1085 per door
+\$1220 per door
+\$1425 per door
+\$1323 per door
+\$1474 per door

Specify with *mirrored glass doors* and select finish.
Specify with *mirrored glass doors* and select finish.
Specify with *mirrored glass doors* and select finish.
Specify with *mirrored glass doors* and select finish.
Specify with *mirrored glass doors* and select finish.
Specify with *mirrored glass doors* and select finish.

Frame

- Painted metal frame for glass doors

No cost

Specify with *frame* and select paint color number.

▶ Options, continued on next page

For laminate price group 2 pricing, please refer to the electronic catalog or SmartTools.

Tip: Glass doors have a magnetic touch latch. They do not have pulls.

Tip: Specify optional 1¹/₈" thick heavy load shelves for heavy load conditions. Heavy load conditions are defined as loads of 100 lbs or greater. Heavy load shelves should be specified on wider units (30"W or 36"W) loaded with books or other heavy objects. Metal shelves also support heavy loads.

► Options, continued from previous page

Tip: Shelves with less than 12" of clearance height will not hold some binders in the vertical orientation.

Options	Price	Required to Specify
Shelves		
Heavy load shelves		
• On 45"H and 65 ⁵ / ₈ "H bookcases	+\$ 48	Specify with heavy load shelves.
• On 72 ¹ / ₂ "H bookcases	+\$117	Specify with heavy load shelves.
Metal shelves		
• Metal shelf	-\$ 26 per shelf	Specify with metal shelves and select paint color number.

Specification Information

Dimensions			Style	Base Prices			Options					
D	W	H	Number	Wood Group 1 Case	Laminate Price Group 1 Case	Wood Group 1 Front	Laminate Price Group 1 Front	Wood Group 1 Front	Wood	Wood	Wood	Wood
									Wood Case with Wood Front	Laminate Case with Wood Front	Wood Group 2	Wood Group 3
									Wood Group 2	Wood Group 3	Wood Group 2	Wood Group 3

Leg Base Freestanding Bookcases

With Two Doors

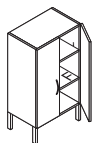

45"H Bookcases

15 ⁷ / ₈ "	30"	45"	E6BFL153045D	\$2845	\$2120	\$2573	+\$224	+\$ 788	+\$47	+\$164
15 ⁷ / ₈ "	36"	45"	E6BFL153645D	\$2951	\$2226	\$2679	+\$246	+\$ 866	+\$69	+\$242

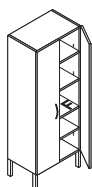

65⁵/₈"H Bookcases

15 ⁷ / ₈ "	30"	65 ⁵ / ₈ "	E6BFL153065D	\$3240	\$2515	\$2968	+\$399	+\$1396	+\$69	+\$242
15 ⁷ / ₈ "	36"	65 ⁵ / ₈ "	E6BFL153665D	\$3363	\$2638	\$3091	+\$428	+\$1498	+\$96	+\$335

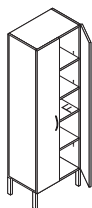

72¹/₂"H Bookcases

15 ⁷ / ₈ "	30"	72 ¹ / ₂ "	E6BFL153072D	\$3427	\$2702	\$3155	+\$428	+\$1498	+\$96	+\$335
15 ⁷ / ₈ "	36"	72 ¹ / ₂ "	E6BFL153672D	\$3559	\$2834	\$3287	+\$428	+\$1498	+\$96	+\$335

F=Fixed Shelf

Stacking Bookcases—Open

Wood Veneer or Laminate

SIN 711.2

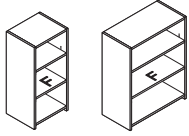

Tip: Shelves with less than 12" of clearance height will not hold some binders in the vertical orientation.

Tip: Specify optional 1 1/8" thick heavy load shelves for heavy load conditions. Heavy load conditions are defined as loads of 100 lbs or greater. Heavy load shelves should be specified on wider units (30"W or 36"W) loaded with books or other heavy objects. Metal shelves also support heavy loads.

For laminate price group 2 pricing, please refer to the electronic catalog or SmartTools.

Tip: 7 1/2"H shelves and single- or double-high overhead cabinets can be suspended between stacking bookcases. Specify suspension/ganging hardware kit separately.

Tip: 36 5/8"H stacking bookcases align with 65 5/8"H freestanding storage when mounted at standard work-surfaces height of 29". 43 1/2"H stacking bookcases align with 72 1/2"H freestanding storage when mounted at standard work-surfaces height of 29". 48 9/16"H align with 77 1/2"H storage.

F= Fixed shelf

Standard Includes	Required to Specify
<ul style="list-style-type: none"> Open bookcase: <ul style="list-style-type: none"> —wood group 1 or laminate price group 1 Unfinished inset back Shelves: wood, laminate, or metal 	<ol style="list-style-type: none"> Style number Wood or laminate color number for bookcase Options, if selected (see below) <ul style="list-style-type: none"> ▶ See <i>Surface Materials</i>, page 566.

Options	Price	Required to Specify
Surface Materials <ul style="list-style-type: none"> Wood bookcase <ul style="list-style-type: none"> Wood group 2 Wood group 3 Customiz stain Laminate bookcase <ul style="list-style-type: none"> Laminate price group 2 Open Line laminate 	<ul style="list-style-type: none"> Prices at right Prices at right No cost <hr/> <ul style="list-style-type: none"> See information at left +\$ 69 plus cost of laminate 	<ul style="list-style-type: none"> Specify wood color number. Specify wood color number. Specify with <i>Customiz stain</i>. <hr/> <ul style="list-style-type: none"> Specify laminate color number. ▶ See <i>Surface Materials Reference Manual</i>.
Finished Inset Back <ul style="list-style-type: none"> Laminate Wood 	<ul style="list-style-type: none"> +\$146 +\$288 	<ul style="list-style-type: none"> Specify with <i>laminate finished inset back</i>. Specify with <i>wood finished inset back</i>.
Shelves <ul style="list-style-type: none"> Heavy load shelves <ul style="list-style-type: none"> On 36 5/8"H and 43 1/2"H bookcases On 48 9/16"H bookcases Metal shelves <ul style="list-style-type: none"> Metal shelf 	<ul style="list-style-type: none"> +\$ 48 +\$ 70 –\$ 26 per shelf 	<ul style="list-style-type: none"> Specify with <i>heavy load shelves</i>. Specify with <i>heavy load shelves</i>. Specify with <i>metal shelves</i> and select paint color number.
Related Products <ul style="list-style-type: none"> Single-high overhead cabinets Organizer, open, and accessory shelves Suspension/ganging hardware kit Finished back panels for stacking bookcases 		<ul style="list-style-type: none"> ▶ Pages 484–490 ▶ Page 504 ▶ Page 522 ▶ Page 466

Specification Information

Dimensions			Style Number	Base Prices		Options (Add \$ to Base Price)	
D	W	H		Wood Group 1 Case	Laminate Price Group 1 Case	Wood	
				Open Front	Open Front	Wood Group 2	Wood Case with Open Front Wood Group 3

Stacking Bookcases

Open Bookcases

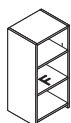

F=Fixed shelf

36⁵/₈"H Bookcases

Open, One Fixed Shelf, Two Adjustable Shelves

Dimensions (D x W x H)	Style Number	Wood Group 1 Case	Laminate Price Group 1 Case	Options (Add \$ to Base Price)
15" x 15" x 36 ⁵ / ₈ "	E6BS151536P	\$1178	\$ 757	+\$177 +\$ 624
15" x 18" x 36 ⁵ / ₈ "	E6BS151836P	\$1280	\$ 859	+\$177 +\$ 624
15" x 30" x 36 ⁵ / ₈ "	E6BS153036P	\$1650	\$1229	+\$177 +\$ 624
15" x 36" x 36 ⁵ / ₈ "	E6BS153636P	\$1753	\$1332	+\$177 +\$ 624

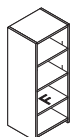

F=Fixed shelf

43¹/₂"H Bookcases

Open, One Fixed Shelf, Three Adjustable Shelves

Dimensions (D x W x H)	Style Number	Wood Group 1 Case	Laminate Price Group 1 Case	Options (Add \$ to Base Price)
15" x 15" x 43 ¹ / ₂ "	E6BS151543P	\$1298	\$ 877	+\$177 +\$ 624
15" x 18" x 43 ¹ / ₂ "	E6BS151843P	\$1398	\$ 977	+\$177 +\$ 624
15" x 30" x 43 ¹ / ₂ "	E6BS153043P	\$1814	\$1393	+\$177 +\$ 624
15" x 36" x 43 ¹ / ₂ "	E6BS153643P	\$1918	\$1497	+\$177 +\$ 624

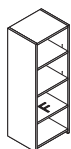

F=Fixed shelf

48⁹/₁₆"H Bookcases

Open, One Fixed Shelf, Three Adjustable Shelves

Dimensions (D x W x H)	Style Number	Wood Group 1 Case	Laminate Price Group 1 Case	Options (Add \$ to Base Price)
15" x 15" x 48 ⁹ / ₁₆ "	E6BS151548P	\$1415	\$ 994	+\$330 +\$1154
15" x 18" x 48 ⁹ / ₁₆ "	E6BS151848P	\$1517	\$1096	+\$330 +\$1154
15" x 30" x 48 ⁹ / ₁₆ "	E6BS153048P	\$1978	\$1557	+\$330 +\$1154
15" x 36" x 48 ⁹ / ₁₆ "	E6BS153648P	\$2083	\$1662	+\$330 +\$1154

Stacking Bookcases with Doors

Wood Veneer or Laminate

SIN 711.2

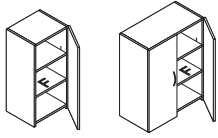

Tip: 36⁵/₈"H stacking bookcases align with 65⁵/₈"H freestanding storage when mounted at standard worksurfaces height of 29". 43¹/₂"H stacking bookcases align with 72¹/₂"H freestanding storage when mounted at standard worksurfaces height of 29". 48⁹/₁₆"H align with 77¹/₂"H.

Tip: Hinged door units with integral or beam pulls will have a single pull on the right-hand door.

For laminate price group 2 pricing, please refer to the electronic catalog or SmartTools.

Tip: Glass doors have a magnetic touch latch. They do not have pulls.

Standard Includes	Required to Specify
<ul style="list-style-type: none"> Bookcase with door(s), if selected: <ul style="list-style-type: none"> –Wood group 1 case with wood group 1 front –Laminate price group 1 case with same or contrasting laminate front –Laminate price group 1 case with wood group 1 front Single door on 15"W and 18"W units Two doors on 30"W and 36"W units Unfinished inset back Shelves: wood, laminate, or metal 	<ol style="list-style-type: none"> Style number Wood or laminate color number for bookcase Laminate color number for laminate fronts on laminate case, if selected Wood color number for wood fronts on laminate cases, if selected Pull shape (see below under Required Selections) Finish color number for pull Options, if selected (see below) <p>▶ See <i>Surface Materials</i>, page 566.</p>

Required Selections							
Pull Shape							
Contemporary	Jazz	Bar	Nile	Integral*	Transitional	Inset	Beam
No cost	+\$19 each	+\$26 each	+\$26 each	+\$26 each	+\$26 each	+\$26 each	+\$37 each
*Not available on laminate or composite fronts.							

Options	Price	Required to Specify
Surface Materials <ul style="list-style-type: none"> Wood bookcase case <ul style="list-style-type: none"> Wood group 2 Wood group 3 Customiz stain Laminate bookcase case <ul style="list-style-type: none"> Laminate price group 2 Open Line laminate Wood group 2 on wood fronts Wood group 3 on wood fronts Customiz stain 	Prices at right Prices at right No cost See information at left +\$ 69 plus cost of laminate Prices at right Prices at right No cost	Specify wood color number. Specify wood color number. Specify with <i>Customiz stain</i> . Specify laminate color number. ▶ See <i>Surface Materials Reference Manual</i> . Specify wood color number. Specify wood color number. Specify with <i>Customiz stain</i> .
Painted Glass Door(s) for Bookcases	Non-locking glass door(s) for 36⁵/₈"H and 43¹/₂"H bookcases <ul style="list-style-type: none"> On 15"W +\$ 350 On 18"W +\$ 387 On 30"W +\$ 700 On 36"W +\$ 774 Non-locking glass door(s) for 48⁹/₁₆"H bookcases <ul style="list-style-type: none"> On 15"W +\$ 387 On 18"W +\$ 436 On 30"W +\$ 774 On 36"W +\$ 872 	Specify with <i>glass door(s)</i> and select finish. Specify with <i>glass door(s)</i> and select finish. Specify with <i>glass door(s)</i> and select finish. Specify with <i>glass door(s)</i> and select finish. Specify with <i>glass door(s)</i> and select finish. Specify with <i>glass door(s)</i> and select finish. Specify with <i>glass door(s)</i> and select finish. Specify with <i>glass door(s)</i> and select finish.
Frame <ul style="list-style-type: none"> Painted metal frame for glass doors 	No cost	Specify with <i>frame</i> and select paint color number.
Mirrored Glass Door(s) for Bookcases	Non-locking glass door(s) for 36⁵/₈"H and 43¹/₂"H bookcases <ul style="list-style-type: none"> On 15"W +\$ 488 On 18"W +\$ 543 On 30"W +\$ 976 On 36"W +\$1086 Non-locking glass door(s) for 48⁹/₁₆"H bookcases <ul style="list-style-type: none"> On 15"W +\$ 543 On 18"W +\$ 609 On 30"W +\$1086 On 36"W +\$1218 	Specify with <i>mirrored glass door(s)</i> and select finish. Specify with <i>mirrored glass door(s)</i> and select finish. Specify with <i>mirrored glass door(s)</i> and select finish. Specify with <i>mirrored glass door(s)</i> and select finish. Specify with <i>mirrored glass door(s)</i> and select finish. Specify with <i>mirrored glass door(s)</i> and select finish. Specify with <i>mirrored glass door(s)</i> and select finish. Specify with <i>mirrored glass door(s)</i> and select finish.

▶ Options, continued on next page

F= Fixed shelf

► Options, continued from previous page

Tip: Specify optional 1 1/8" thick heavy load shelves for heavy load conditions. Heavy load conditions are defined as loads of 100 lbs or greater. Heavy load shelves should be specified on wider units (30"W or 36"W) loaded with books or other heavy objects. Metal shelves also support heavy loads.

Tip: 7 1/2"H shelves and single- and double-high overhead cabinets can be suspended between stacking bookcases. Specify suspension/ganging hardware kit separately.

Tip: Shelves with less than 12" of clearance height will not hold some binders in the vertical orientation.

Options	Price	Required to Specify
Mirrored Glass Door(s) for Bookcases, continued		
Frame • Painted metal frame for glass doors	No cost	Specify with frame and select paint color number.
Finished Inset Back • Laminate • Wood	+\$146 +\$283	Specify with laminate finished inset back. Specify with wood finished inset back.
Shelves		
Heavy load shelves • On 36 5/8"H and 43 1/2"H • On 48 9/16"H	+\$ 48 +\$ 70	Specify with heavy load shelves. Specify with heavy load shelves.
Metal shelves • Metal shelf	-\$ 26 per shelf	Specify with metal shelves and select paint color number.
Related Products	• Single-high overhead cabinets • Organizer, open, and accessory shelves • Suspension/ganging hardware kit • Finished back panels for stacking bookcases	► Pages 484–490 ► Page 504 ► Page 522 ► Page 466

Specification Information

Dimensions			Style	Base Prices			Options					
D	W	H	Number	Wood Group 1 Case	Laminate Price Group 1 Case	Wood Group 1 Front	Wood Group 1	Wood	Wood	Wood	Wood	
							Wood Case with Wood Front	Laminate Case with Wood Front	Wood Group 2	Wood Group 3	Wood Group 2	Wood Group 3

Stacking Bookcases

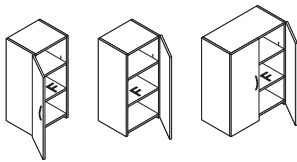

F= Fixed shelf

36 5/8"H Bookcases

Single Door Hinged Left, One Fixed Shelf, Two Adjustable Shelves

15 7/8"	15"	36 5/8"	E6BS151536L	\$1570	\$ 965	\$1207	+\$207	+\$725	+\$28	+\$ 94
15 7/8"	18"	36 5/8"	E6BS151836L	\$1673	\$1068	\$1310	+\$207	+\$725	+\$28	+\$ 94

Single Door Hinged Right, One Fixed Shelf, Two Adjustable Shelves

15 7/8"	15"	36 5/8"	E6BS151536R	\$1570	\$ 965	\$1207	+\$207	+\$725	+\$28	+\$ 94
15 7/8"	18"	36 5/8"	E6BS151836R	\$1673	\$1068	\$1310	+\$207	+\$725	+\$28	+\$ 94

Double Door, One Fixed Shelf, Two Adjustable Shelves

15 7/8"	30"	36 5/8"	E6BS153036D	\$2314	\$1709	\$2072	+\$224	+\$788	+\$47	+\$164
15 7/8"	36"	36 5/8"	E6BS153636D	\$2518	\$2053	\$2416	+\$224	+\$788	+\$47	+\$164

► Specification Information, continued on next page

Stacking Bookcases with Doors, Wood Veneer or Laminate, continued

SIN 711.2

► Specification Information, continued from previous page

Specification Information										
Dimensions			Style Number	Base Prices			Options			
D	W	H		Wood Group 1 Case	Laminate Price Group 1 Case	(Add \$ to Base Price)				
				Wood Group 1 Front	Laminate Price Group 1 Front	Wood Group 1 Front	Wood	Wood Case with Wood Front	Laminate Case with Wood Front	
							Wood Group 2	Wood Group 3	Wood Group 2	Wood Group 3

Stacking Bookcases

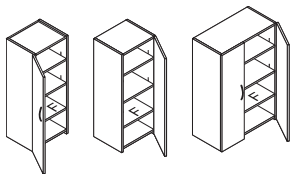

F= Fixed shelf

43 1/2"H Bookcases

Single Door Hinged Left, One Fixed Shelf, Three Adjustable Shelves

15 7/8"	15"	43 1/2"	E6BS151543L	\$1688	\$1083	\$1325	+\$207	+\$ 725	+\$28	+\$ 94
15 7/8"	18"	43 1/2"	E6BS151843L	\$1790	\$1185	\$1427	+\$207	+\$ 725	+\$28	+\$ 94

Single Door Hinged Right, One Fixed Shelf, Three Adjustable Shelves

15 7/8"	15"	43 1/2"	E6BS151543R	\$1688	\$1083	\$1325	+\$207	+\$ 725	+\$28	+\$ 94
15 7/8"	18"	43 1/2"	E6BS151843R	\$1790	\$1185	\$1427	+\$207	+\$ 725	+\$28	+\$ 94

Double Door, One Fixed Shelf, Three Adjustable Shelves

15 7/8"	30"	43 1/2"	E6BS153043D	\$2479	\$1874	\$2237	+\$224	+\$ 788	+\$47	+\$164
15 7/8"	36"	43 1/2"	E6BS153643D	\$2680	\$2215	\$2578	+\$246	+\$ 866	+\$69	+\$242

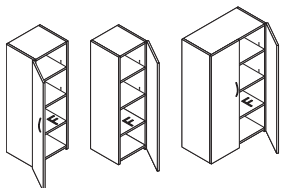

F= Fixed shelf

48 9/16"H Bookcases

Single Door Hinged Left, One Fixed Shelf, Three Adjustable Shelves

15 7/8"	15"	48 9/16"	E6BS151548L	\$1806	\$1201	\$1443	+\$360	+\$1257	+\$28	+\$ 94
15 7/8"	18"	48 9/16"	E6BS151848L	\$1907	\$1302	\$1544	+\$377	+\$1318	+\$47	+\$164

Single Door Hinged Right, One Fixed Shelf, Three Adjustable Shelves

15 7/8"	15"	48 9/16"	E6BS151548R	\$1806	\$1201	\$1443	+\$360	+\$1257	+\$28	+\$ 94
15 7/8"	18"	48 9/16"	E6BS151848R	\$1907	\$1302	\$1544	+\$377	+\$1318	+\$47	+\$164

Double Door, One Fixed Shelf, Three Adjustable Shelves

15 7/8"	30"	48 9/16"	E6BS153048D	\$2643	\$2038	\$2401	+\$399	+\$1396	+\$69	+\$242
15 7/8"	36"	48 9/16"	E6BS153648D	\$2841	\$2376	\$2739	+\$399	+\$1396	+\$69	+\$242

Stacking Bookcases
with Doors

SIN 711.2

Finished Back Panels for Stacking Bookcases

Wood Veneer or Laminate

SIN 711.2

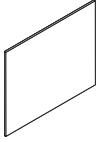

Tip: Specify finished back panels when back of components will be exposed.

Tip: Finished back panels are proud of the case. Finished inset backs are also available. Specify the stacking bookcase with finished inset back.

For laminate price group 2 pricing, please refer to the electronic catalog or SmartTools.

Standard Includes	Required to Specify
<ul style="list-style-type: none"> Back panel: wood group 1 veneer or laminate price group 1 Attachment hardware 	<ol style="list-style-type: none"> Style number Wood or laminate color number for back panel Options, if selected (see below) <p>▶ See <i>Surface Materials</i>, page 566.</p>

Surface Materials	Options	Price	Required to Specify
	Wood back panel <ul style="list-style-type: none"> Wood group 2 Wood group 3 Customiz stain 	Prices below Prices below No cost	Specify wood color number. Specify wood color number. Specify with <i>Customiz stain</i> .
	Laminate back panel <ul style="list-style-type: none"> Laminate price group 2 Open line laminate 	See information at left +\$69 plus cost of laminate	Specify laminate color number. ▶ See <i>Surface Materials Reference Manual</i> .

Specification Information						
Dimensions			Style Number	Base Prices		Options
D	W	H		Wood Group 1	Laminate Price Group 1	(Add \$ to Base Price)
:	:	:	:	:	:	:
:	:	:	:	:	:	:
:	:	:	:	:	:	:
:	:	:	:	:	:	:
:	:	:	:	:	:	:
:	:	:	:	:	:	:
:	:	:	:	:	:	:

Back Panel							
Finished Back Panels for Use with 36 ⁵ / ₈ "H Stacking Bookcases							
3/4"	15"	36 ⁵ / ₈ "	E6NB1536V	\$263	\$202	+\$28	+\$ 94
3/4"	18"	36 ⁵ / ₈ "	E6NB1836V	\$282	\$221	+\$28	+\$ 94
3/4"	30"	36 ⁵ / ₈ "	E6NB3036V	\$368	\$307	+\$47	+\$164
3/4"	36"	36 ⁵ / ₈ "	E6NB3636V	\$387	\$326	+\$47	+\$164
Finished Back Panels for Use with 43 ¹ / ₂ "H Stacking Bookcases							
3/4"	15"	43 ¹ / ₂ "	E6NB1543V	\$281	\$220	+\$28	+\$ 94
3/4"	18"	43 ¹ / ₂ "	E6NB1843V	\$294	\$233	+\$28	+\$ 94
3/4"	30"	43 ¹ / ₂ "	E6NB3043V	\$404	\$343	+\$47	+\$164
3/4"	36"	43 ¹ / ₂ "	E6NB3643V	\$422	\$361	+\$69	+\$242
Finished Back Panels for Use with 48 ⁹ / ₁₆ "H Stacking Bookcases							
3/4"	15"	48 ⁹ / ₁₆ "	E6NB1548V	\$300	\$239	+\$28	+\$ 94
3/4"	18"	48 ⁹ / ₁₆ "	E6NB1848V	\$305	\$244	+\$47	+\$164
3/4"	30"	48 ⁹ / ₁₆ "	E6NB3048V	\$439	\$378	+\$69	+\$242
3/4"	36"	48 ⁹ / ₁₆ "	E6NB3648V	\$456	\$395	+\$69	+\$242

Finished Back Panels for
Stacking Bookcases

SIN 711.2

Leg Base Towers with Full-Height Doors

Wood Veneer or Laminate

SIN 711.2

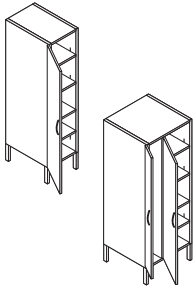

Tip: When storage legs are shared between two units, the extra legs should be saved for later use, such as reconfiguration.

Tip: Two 15"W towers can share four legs at the corners if a tower brace is used. Specify the tower brace separately as well as the suspension/ganging hardware kit.

For laminate price group 2 pricing, please refer to the electronic catalog or SmartTools.

Tip: On units with two doors, only the wardrobe door locks.

Tip: Locks are not available on doors with integral pulls.

Tip: On 24"W towers specified with a glass door, only the 15"W door will be glass. The wardrobe door will be wood or laminate.

Tip: Glass doors have a magnetic touch latch. They do not have pulls.

Tip: 7 1/2"H shelves and overhead cabinets can be suspended between towers. Specify suspension/ganging hardware kit separately.

Standard Includes	Required to Specify
<ul style="list-style-type: none"> • Tower: <ul style="list-style-type: none"> – Wood group 1 case with wood group 1 front – Laminate price group 1 case with same or contrasting laminate front – Laminate price group 1 case with wood group 1 front • Single door on 15 1/2"W units • Two doors on 24"W units: <ul style="list-style-type: none"> – Right-hand units: wardrobe on right, doors hinged right – Left-hand units: wardrobe on left, doors hinged left • Shelves: wood, laminate, or metal • Storage leg: paint or metal • Brackets for adjustable shelves: black only • Two coat hooks in wardrobe: brushed nickel only • Lock, keyed random 	<ol style="list-style-type: none"> 1 Style number 2 Wood or laminate color number for tower 3 Laminate color number for laminate fronts on laminate case, if selected 4 Wood color number for wood fronts on laminate cases, if selected 5 Pull shape (see below under Required Selections) 6 Finish color number for pull 7 Finish color number for lock 8 Paint or metal color number for storage leg 9 Options, if selected (see below) <p>▶ See <i>Surface Materials</i>, page 566.</p>

Required Selections							
Pull Shape							
Contemporary	Jazz	Bar	Nile	Integral*	Transitional	Inset	Beam
No cost	+\$19 each	+\$26 each	+\$26 each	+\$26 each	+\$26 each	+\$26 each	+\$37 each

*Not available on laminate or composite fronts.

	Options	Price	Required to Specify
Surface Materials	Wood tower case <ul style="list-style-type: none"> • Wood group 2 • Wood group 3 • Customiz stain 	Prices at right Prices at right No cost	Specify wood color number. Specify wood color number. Specify <i>with Customiz stain</i> .
	Laminate tower case <ul style="list-style-type: none"> • Laminate price group 2 • Open Line laminate • Wood group 2 on wood fronts • Wood group 3 on wood fronts • Customiz stain 	See information at left +\$ 69 plus cost of laminate Prices at right Prices at right No cost	Specify laminate color number. ▶ See <i>Surface Materials Reference Manual</i> . Specify wood color number. Specify wood color number. Specify <i>with Customiz stain</i> .
Lock and Keying	Lock <ul style="list-style-type: none"> • Ember Chrome • Polished Chrome 	No cost No cost	Specify <i>with 9250 Ember Chrome lock</i> . Specify <i>with 9201 Polished Chrome lock</i> .
	Keying <ul style="list-style-type: none"> • Factory- and field-installed keying 		▶ Page 622
Shelves	<ul style="list-style-type: none"> • 3/4" shelf • Metal shelf 	No cost –\$ 26 per shelf	Specify <i>with 3/4" shelf</i> . Specify <i>with metal shelves</i> and select paint color number.
Painted Glass Door for Towers	Non-locking glass door <ul style="list-style-type: none"> • On 55 1/4"H and 65 5/8"H wood towers • On 72 1/2"H wood towers 	+\$436 +\$473	Specify <i>with glass door</i> and select finish. Specify <i>with glass door</i> and select finish.
	Frame <ul style="list-style-type: none"> • Painted metal frame for glass doors 	No cost	Specify <i>with frame</i> and select paint color number.

▶ Options, continued on next page

► Options, continued from previous page

Options	Price	Required to Specify
Mirrored Glass Door for Towers	Non-locking glass door	
	<ul style="list-style-type: none"> On 55¼"H and 65⅝"H wood towers +\$609 On 72½"H wood towers +\$661 	Specify with <i>mirrored glass door</i> and select finish. Specify with <i>mirrored glass door</i> and select finish.
Related Products	Frame	
	<ul style="list-style-type: none"> Painted metal frame for glass doors No cost 	Specify with <i>frame</i> and select paint color number.
	<ul style="list-style-type: none"> Single-high overhead cabinets Double-high overhead cabinets Organizer, open, and accessory shelves Suspension/ganging hardware kit 	<ul style="list-style-type: none"> ► Pages 484–490 ► Page 494 ► Page 504 ► Page 522

Specification Information

Dimensions			Style Number	Base Prices		Options				
D	W	H		Wood Group 1 Case	Laminate Price Group 1 Case	(Add \$ to Base Price)				
				Wood Group 1 Front	Laminate Price Group 1 Front	Wood Group 1	Wood	Wood	Wood	Wood
						Wood Case with Wood Front	Laminate Case with Wood Front	Wood Group 2	Wood Group 3	Wood Group 2
								Wood Group 3	Wood Group 2	Wood Group 3

Leg Base Towers

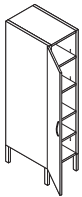

Towers with Door Hinged Left

Two Adjustable Shelves, Two Fixed Shelves

18"	15½"	55¼"	E6TWL181555L	\$2068	\$1223	\$1705	+\$291	+\$1015	+\$47	+\$164
24"	15½"	55¼"	E6TWL241555L	\$2412	\$1567	\$2049	+\$291	+\$1015	+\$47	+\$164

Three Adjustable Shelves, Two Fixed Shelves

24"	15½"	65⅝"	E6TWL241565A	\$2565	\$1720	\$2202	+\$313	+\$1093	+\$69	+\$242
-----	------	------	---------------------	--------	--------	--------	--------	---------	-------	--------

Four Adjustable Shelves, Two Fixed Shelves

24"	15½"	72½"	E6TWL241572A	\$2620	\$1775	\$2257	+\$313	+\$1093	+\$69	+\$242
-----	------	------	---------------------	--------	--------	--------	--------	---------	-------	--------

► Specification Information, continued on next page

Elective Elements

Leg Base Towers with Full-Height Doors, Wood Veneer or Laminate, continued

SIN 711.2

► **Specification Information, continued from previous page**

Specification Information										
Dimensions			Style Number	Base Prices			Options (Add \$ to Base Price)			
D	W	H		Wood Group 1 Case	Laminate Price Group 1 Case	Wood Group 1 Front	Wood Group 1 Front	Wood Case with Wood Front	Laminate Case with Wood Front	Wood Group 2

Leg Base Towers, continued

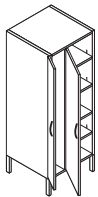

Towers with Doors Hinged Left, Wardrobe Left

Three Adjustable Shelves, Two Fixed Shelves

24"	24"	65 ⁵ / ₈ "	E6TWL242465C	\$2960	\$2115	\$2597	+\$362	+\$1272	+\$69	+\$242
-----	-----	----------------------------------	---------------------	--------	--------	--------	--------	---------	-------	--------

Four Adjustable Shelves, Two Fixed Shelves

24"	24"	72 ¹ / ₂ "	E6TWL242472C	\$3024	\$2179	\$2661	+\$362	+\$1272	+\$69	+\$242
-----	-----	----------------------------------	---------------------	--------	--------	--------	--------	---------	-------	--------

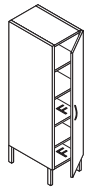

F= Fixed shelf

Towers with Door Hinged Right

Two Adjustable Shelves, Two Fixed Shelves

18"	15 ¹ / ₂ "	55 ¹ / ₄ "	E6TWL181555R	\$2068	\$1223	\$1705	+\$291	+\$1015	+\$47	+\$164
-----	----------------------------------	----------------------------------	---------------------	--------	--------	--------	--------	---------	-------	--------

24"	15 ¹ / ₂ "	55 ¹ / ₄ "	E6TWL241555R	\$2412	\$1567	\$2049	+\$291	+\$1015	+\$47	+\$164
-----	----------------------------------	----------------------------------	---------------------	--------	--------	--------	--------	---------	-------	--------

Three Adjustable Shelves, Two Fixed Shelves

24"	15 ¹ / ₂ "	65 ⁵ / ₈ "	E6TWL241565B	\$2565	\$1720	\$2202	+\$313	+\$1093	+\$69	+\$242
-----	----------------------------------	----------------------------------	---------------------	--------	--------	--------	--------	---------	-------	--------

Four Adjustable Shelves, Two Fixed Shelves

24"	15 ¹ / ₂ "	72 ¹ / ₂ "	E6TWL241572B	\$2620	\$1775	\$2257	+\$313	+\$1093	+\$69	+\$242
-----	----------------------------------	----------------------------------	---------------------	--------	--------	--------	--------	---------	-------	--------

► **Specification Information, continued on next page**

► Specification Information, continued from previous page

Specification Information											
Dimensions			Style Number	Base Prices			Options				
D	W	H		Wood Group 1 Case	Laminate Price Group 1 Case	(Add \$ to Base Price)					
			Wood Group 1 Front	Laminate Price Group 1 Front	Wood Group 1 Front	Wood					
						Wood Case with Wood Front	Laminate Case with Wood Front	Wood Group 2	Wood Group 3	Wood Group 2	Wood Group 3

Leg Base Towers, continued

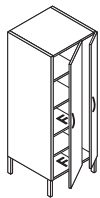

F= Fixed shelf

Towers with Doors Hinged Right, Wardrobe Right

Three Adjustable Shelves, Two Fixed Shelves

24"	24"	65 ⁵ / ₈ "	E6TWL242465D	\$2960	\$2115	\$2597	+\$362	+\$1272	+\$69	+\$242
-----	-----	----------------------------------	---------------------	--------	--------	--------	--------	---------	-------	--------

Four Adjustable Shelves, Two Fixed Shelves

24"	24"	72 ¹ / ₂ "	E6TWL242472D	\$3024	\$2179	\$2661	+\$362	+\$1272	+\$69	+\$242
-----	-----	----------------------------------	---------------------	--------	--------	--------	--------	---------	-------	--------

Tip: Specify a left-hand (hinged left) unit if the user is sitting to the right of the unit and a right-hand (hinged right) unit if the user is sitting to the left of the unit.

Leg Base Towers with Doors and Drawers

Wood Veneer or Laminate

SIN 711.2

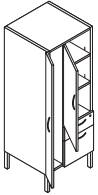

Tip: Organizer and open shelves and overhead cabinets can be suspended between 65⁵/₈"H and 72¹/₂"H. Specify suspension/ganging hardware kit separately.

Tip: When storage legs are shared between two units, the extra legs should be saved for later use, such as reconfiguration.

Tip: When specifying glass doors and beam pulls, the frame finish must match the pull.

Tip: Soft close drawer slides only apply to storage that has 15"W drawers.

For laminate price group 2 pricing, please refer to the electronic catalog or SmartTools.

Tip: Soft close slides are available for both dovetail and miter fold construction.

Tip: Locks are not available on doors with integral pulls. Drawers with integral pulls always lock.

Tip: When integral pull is specified with a 9250 Ember Chrome lock, the lock housing is black. When 9201 Polished Chrome lock is specified, the lock housing is nickel.

Tip: On units with two doors, only the wardrobe door locks. Drawers always lock.

Tip: On 24"W towers specified with a glass door, only the 15"W door will be glass. The wardrobe door will be wood or laminate.

Tip: Glass doors have a magnetic touch latch. They do not have pulls.

Standard Includes	Required to Specify
-------------------	---------------------

- Tower:
 - Wood group 1 case with wood group 1 front
 - Laminate price group 1 case with same or contrasting laminate front
 - Laminate price group 1 case with wood group 1 front
- Single door on 15¹/₂"W units
- Two doors on 24"W units:
 - Right-hand units: wardrobe on right, doors hinged right
 - Left-hand units: wardrobe on left, doors hinged left
- Finished inset back on 55¹/₄", 65⁵/₈", and 72¹/₂"H towers
- Dovetail drawer construction
- Shelves: wood, laminate, or metal
- Storage leg: paint or metal
- Brackets for adjustable shelves: black only
- Two coat hooks in wardrobe: brushed nickel only
- One fastened metal filing system per file drawer: black only
- Lock, keyed random
- Standard close drawer slides

- 1 Style number
 - 2 Wood or laminate color number for tower
 - 3 Laminate color number for laminate fronts on laminate case, if selected
 - 4 Wood color number for wood fronts on laminate cases, if selected
 - 5 Pull shape (see below under Required Selections)
 - 6 Finish color number for pull
 - 7 Finish color number for lock
 - 8 Paint or metal color number for storage leg
 - 9 Options, if selected (see below)
- ▶ See *Surface Materials*, page 566.

Required Selections

Pull Shape

Contemporary	Jazz	Bar	Nile	Integral*	Transitional	Inset	Beam
No cost	+\$19 each	+\$26 each	+\$26 each	+\$26 each	+\$26 each	+\$26 each	+\$37 each

*Not available on laminate or composite fronts.

Options	Price	Required to Specify
---------	-------	---------------------

Surface Materials	Wood tower case	Prices at right Prices at right No cost	Specify wood color number. Specify wood color number. Specify with <i>Customiz stain</i> .
	Laminate tower case	See information at left +\$ 69 plus cost of laminate Prices at right Prices at right No cost	Specify laminate color number. ▶ See <i>Surface Materials Reference Manual</i> . Specify wood color number. Specify wood color number. Specify with <i>Customiz stain</i> .
Drawer Slide	• Soft close drawer slides	+\$ 30 per drawer	Specify with <i>soft close drawers</i> .
Lock and Keying	Lock	• Ember Chrome • Polished Chrome	No cost No cost Specify with <i>9250 Ember Chrome lock</i> . Specify with <i>9201 Polished Chrome lock</i> .
	Keying	• Factory- and field-installed keying	▶ Page 622
Shelves	• 3/4" shelf • Metal shelf	No cost –\$ 26 per shelf	Specify with <i>3/4" shelf</i> . Specify with <i>metal shelves</i> and select paint color number.
Painted Glass Door for Towers	Non-locking glass door	• On 55 ¹ / ₄ "H and 65 ⁵ / ₈ "H wood towers • On 72 ¹ / ₂ "H wood towers	+\$350 +\$369 Specify with <i>glass door</i> and select finish. Specify with <i>glass door</i> and select finish.
	Frame	• Painted metal frame for glass doors	No cost Specify with <i>frame</i> and select paint color number.

▶ Options, continued on next page

► Options, continued from previous page

Options	Price	Required to Specify
Mirrored Glass Door for Towers	Non-locking glass door • On 55 ¹ / ₄ "H and 65 ⁵ / ₈ "H	+\$488
	• On 72 ¹ / ₂ "H wood towers	+\$516
Related Products	Frame • Painted metal frame for glass doors	No cost
	• Single-high overhead cabinets • Double-high overhead cabinets • Organizer, open, and accessory shelves • Suspension/ganging hardware kit	

Specify with *mirrored glass door* and select finish.
Specify with *mirrored glass door* and select finish.

Specify with *frame* and select paint color number.

► Pages 484–490
► Page 494
► Page 504
► Page 522

Specification Information

Dimensions D W H			Style Number	Base Prices		Options (Add \$ to Base Price)					
				Wood Group 1 Case	Laminate Price Group 1 Case						
				Wood Group 1 Front	Laminate Price Group 1 Front	Wood Group 1 Front	Wood	Wood	Wood	Wood	
						Wood Case with Wood Front	Laminate Case with Wood Front	Wood Group 2	Wood Group 3	Wood Group 2	Wood Group 3

Leg Base Towers

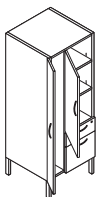

Towers with Doors Hinged Left, Wardrobe Left

Two Adjustable Shelves, and One File Drawer on Bottom

18"	24"	55 ¹ / ₄ "	E6TWL182455T	\$3467	\$2622	\$3104	+\$312	+\$1093	+\$47	+\$164
-----	-----	----------------------------------	---------------------	--------	--------	--------	--------	---------	-------	--------

Two Adjustable Shelves, and One File Drawer on Bottom

24"	24"	55 ¹ / ₄ "	E6TWL242455T	\$3512	\$2667	\$3149	+\$312	+\$1093	+\$47	+\$164
-----	-----	----------------------------------	---------------------	--------	--------	--------	--------	---------	-------	--------

Two Adjustable Shelves, One Box and One File Drawer on Bottom

24"	24"	65 ⁵ / ₈ "	E6TWL242465G	\$3601	\$2756	\$3238	+\$362	+\$1272	+\$69	+\$242
-----	-----	----------------------------------	---------------------	--------	--------	--------	--------	---------	-------	--------

24"	24"	72 ¹ / ₂ "	E6TWL242472G	\$3681	\$2836	\$3318	+\$362	+\$1272	+\$69	+\$242
-----	-----	----------------------------------	---------------------	--------	--------	--------	--------	---------	-------	--------

Tip: Specify a left-hand (hinged left) unit if the user is sitting to the right of the unit and a right-hand (hinged right) unit if the user is sitting to the left of the unit.

► Specification Information, continued on next page

Elective Elements

Leg Base Towers with Doors and Drawers, Wood Veneer or Laminate, continued

SIN 711.2

► **Specification Information, continued from previous page**

Specification Information											
Dimensions			Style Number	Base Prices			Options (Add \$ to Base Price)				
D	W	H		Wood Group 1 Case	Laminate Price Group 1 Case	Wood Group 1 Front	Wood Group 1 Front	Wood Group 1 Front	Wood Group 2	Wood Group 3	Wood Group 3
								Wood Case with Wood Front	Laminate Case with Wood Front		
								Wood Group 2	Wood Group 3	Wood Group 2	Wood Group 3

Leg Base Towers

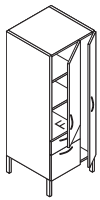

F= Fixed shelf

Towers with Doors Hinged Right, Wardrobe Right

Two Adjustable Shelves, and One File Drawer on Bottom

18"	24"	55¼"	E6TWL182455W	\$3467	\$2622	\$3104	+\$312	+\$1093	+\$47	+\$164
-----	-----	------	---------------------	--------	--------	--------	--------	---------	-------	--------

Two Adjustable Shelves, and One File Drawer on Bottom

24"	24"	55¼"	E6TWL242455W	\$3512	\$2667	\$3149	+\$312	+\$1093	+\$47	+\$164
-----	-----	------	---------------------	--------	--------	--------	--------	---------	-------	--------

Two Adjustable Shelves, One Box and One File Drawer on Bottom

24"	24"	65⅝"	E6TWL242465H	\$3601	\$2756	\$3238	+\$362	+\$1272	+\$69	+\$242
-----	-----	------	---------------------	--------	--------	--------	--------	---------	-------	--------

24"	24"	72½"	E6TWL242472H	\$3681	\$2897	\$3379	+\$362	+\$1272	+\$69	+\$242
-----	-----	------	---------------------	--------	--------	--------	--------	---------	-------	--------

F= Fixed Shel

Leg Base Towers
with Doors and Drawers

SIN 711.2

Leg Base Towers with Open Shelves and Drawers

Wood Veneer or Laminate

SIN 711.2

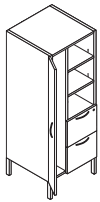

Tip: When storage legs are shared between two units, the extra legs should be saved for later use, such as reconfiguration.

For laminate price group 2 pricing, please refer to the electronic catalog or SmartTools.

Tip: Soft close drawer slides only apply to storage that have 15½"W drawers.

Tip: Soft close slides are available for both dovetail and miter fold construction.

Tip: Locks are not available on doors with integral pulls. Drawers with integral pulls always lock.

Tip: Organizer and open shelves and overhead cabinets can be suspended between towers. Specify suspension/ganging hardware kit separately.

Standard Includes	Required to Specify
<ul style="list-style-type: none"> • Tower: <ul style="list-style-type: none"> – Wood group 1 case with wood group 1 front – Laminate price group 1 case with same or contrasting laminate front – Laminate price group 1 case with wood group 1 front • Wardrobe on 24"W units: <ul style="list-style-type: none"> – Right-hand units: wardrobe on right, doors hinged right – Left-hand units: wardrobe on left, doors hinged left • Finished inset back on 55¼", 65⅝", and 72½"H towers • Dovetail drawer construction • Shelves: wood, laminate, or metal • Storage leg: paint or metal • Brackets for adjustable shelves: black only • Two coat hooks in wardrobe: brushed nickel only • One fastened metal filing system per file drawer: black only • Lock, keyed random • Standard close drawer slides 	<ol style="list-style-type: none"> 1 Style number 2 Wood or laminate color number for tower 3 Laminate color number for laminate fronts on laminate case, if selected 4 Wood color number for wood fronts on laminate cases, if selected 5 Pull shape (see below under Required Selections) 6 Finish color number for pull 7 Finish color number for lock 8 Paint or metal color number for storage leg 9 Options, if selected (see below) <p>▶ See <i>Surface Materials</i>, page 566.</p>

Required Selections							
Pull Shape							
Contemporary	Jazz	Bar	Nile	Integral*	Transitional	Inset	Beam
No cost	+\$19 each	+\$26 each	+\$26 each	+\$26 each	+\$26 each	+\$26 each	+\$37 each

*Not available on laminate or composite fronts.

Options	Price	Required to Specify
Surface Materials <ul style="list-style-type: none"> • Wood tower case <ul style="list-style-type: none"> • Wood group 2 • Wood group 3 • Customiz stain • Laminate tower case <ul style="list-style-type: none"> • Laminate price group 2 • Open Line laminate • Wood group 2 on wood fronts • Wood group 3 on wood fronts • Customiz stain 	Prices at right Prices at right No cost See information at left +\$69 plus cost of laminate Prices at right Prices at right No cost	Specify wood color number. Specify wood color number. Specify with <i>Customiz stain</i> . Specify laminate color number. ▶ See <i>Surface Materials Reference Manual</i> . Specify wood color number. Specify wood color number. Specify with <i>Customiz stain</i> .
Drawer Slide <ul style="list-style-type: none"> • Soft close drawer slides 	+\$30 per drawer	Specify with <i>soft close drawers</i> .
Lock and Keying <ul style="list-style-type: none"> • Lock <ul style="list-style-type: none"> • Ember Chrome • Polished Chrome • Keying <ul style="list-style-type: none"> • Factory- and field-installed keying 	No cost No cost ▶ Page 622	Specify with <i>9250 Ember Chrome lock</i> . Specify with <i>9201 Polished Chrome lock</i> . ▶ Page 622
Shelves <ul style="list-style-type: none"> • ¾" shelf • Metal shelf 	No cost -\$26 per shelf	Specify with <i>¾" shelf</i> . Specify with <i>metal shelves</i> and select paint color number.
Related Products <ul style="list-style-type: none"> • Single-high overhead cabinets • Double-high overhead cabinets • Organizer, open, and accessory shelves • Suspension/ganging hardware kit 	▶ Pages 484–490 ▶ Page 494 ▶ Page 504 ▶ Page 522	

Specification Information

Dimensions			Style Number	Base Prices			Options (Add \$ to Base Price)				
D	W	H		Wood Group 1 Case	Laminate Price Group 1 Case	Wood Group 1 Front	Wood Group 1 Front	Wood Case with Wood Front	Laminate Case with Wood Front	Wood Group 2	Wood Group 3

Leg Base Towers

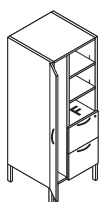

Open Shelves with Door Hinged Left and Wardrobe Left

Two Adjustable Shelves, Two File Drawers on Bottom

24"	24"	65 ⁵ / ₈ "	E6TWL242465K	\$3574	\$2969	\$3272	+\$364	+\$1272	+\$47	+\$164
24"	24"	72 ¹ / ₂ "	E6TWL242472K	\$3653	\$3048	\$3351	+\$364	+\$1272	+\$47	+\$164

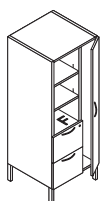

Open Shelves with Door Hinged Right and Wardrobe Right

Two Adjustable Shelves, Two File Drawers on Bottom

24"	24"	65 ⁵ / ₈ "	E6TWL242465L	\$3574	\$2969	\$3272	+\$364	+\$1272	+\$47	+\$164
24"	24"	72 ¹ / ₂ "	E6TWL242472L	\$3653	\$3048	\$3351	+\$364	+\$1272	+\$47	+\$164

F= Fixed Shelf

► **Specification Information, continued on next page**

Elective Elements

Leg Base Towers with Open Shelves and Drawers, Wood Veneer or Laminate, continued

SIN 711.2

► **Specification Information, continued from previous page**

Specification Information											
Dimensions			Style Number	Base Prices			Options				
D	W	H		Wood Group 1 Case	Laminate Price Group 1 Case	Wood Group 1 Front	Laminate Price Group 1 Front	Wood Group 1 Front	Wood	(Add \$ to Base Price)	
									Wood Case with Wood Front	Laminate Case with Wood Front	
									Wood Group 2	Wood Group 3	Wood Group 2
									Wood Group 3		Wood Group 3

Leg Base Towers

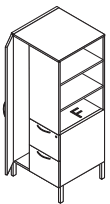

Open Side Bookshelf on Right with Door Hinged Left and Wardrobe Left

Two Adjustable Shelves, Two File Drawers on Bottom

24"	24"	65 ⁵ / ₈ "	E6TWL242465M	\$3574	\$2969	\$3272	+\$364	+\$1272	+\$47	+\$164
-----	-----	----------------------------------	---------------------	--------	--------	--------	--------	---------	-------	--------

Open Side Bookshelf on Left with Door Hinged Right and Wardrobe Right

Two Adjustable Shelves, Two File Drawers on Bottom

24"	24"	65 ⁵ / ₈ "	E6TWL242465N	\$3574	\$2969	\$3272	+\$364	+\$1272	+\$47	+\$164
-----	-----	----------------------------------	---------------------	--------	--------	--------	--------	---------	-------	--------

Tip: Specify a left-hand (hinged left) unit if the user is sitting to the right of the unit and a right-hand (hinged right) unit if the user is sitting to the left of the unit.

Leg Base Towers with Open
Shelves and Drawers

SIN 711.2

Leg Base Wardrobes

Wood Veneer or Laminate

SIN 711.2

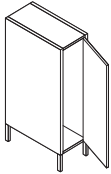

Tip: To ensure proper stability, 12"W wardrobes must attach to building wall or to adjacent furniture.

Tip: When storage legs are shared between two units, the extra legs should be saved for later use, such as reconfiguration.

For laminate price group 2 pricing, please refer to the electronic catalog or SmartTools.

Tip: Locks are not available on doors with integral pulls.

Tip: Doors open from the center out (one door hinged right, one door hinged left).

Tip: Glass doors have a magnetic touch latch. They do not have pulls.

Tip: Hinged door units with integral or beam pulls will have a single pull on the right-hand door.

Tip: Organizer and open shelves and overhead cabinets can be suspended between 65⁵/₈"H, 72¹/₂"H, wardrobes. Specify suspension/ganging hardware kit separately.

Standard Includes	Required to Specify
-------------------	---------------------

- Wardrobes:
 - Wood group 1 case with wood group 1 front
 - Laminate price group 1 case with same or contrasting laminate front
 - Laminate price group 1 case with wood group 1 front
- Storage leg: paint or metal
- Two hooks on 12"W wardrobes
- Lock, keyed random

- 1 Style number
 - 2 Wood or laminate color number for wardrobe
 - 3 Laminate color number for laminate fronts on laminate case, if selected
 - 4 Wood color number for wood fronts on laminate cases, if selected
 - 5 Pull shape (see below under Required Selections)
 - 6 Finish color number for pull
 - 7 Finish color number for lock
 - 8 Paint or metal color number for storage leg
 - 9 Options, if selected (see below)
- ▶ See *Surface Materials*, page 566.

Required Selections

Pull Shape

Contemporary	Jazz	Bar	Nile	Integral*	Transitional	Inset	Beam
No cost	+\$19 each	+\$26 each	+\$26 each	+\$26 each	+\$26 each	+\$26 each	+\$37 each

*Not available on laminate or composite fronts.

Options	Price	Required to Specify
---------	-------	---------------------

Surface Materials	Wood wardrobe case	Prices at right Prices at right No cost	Specify wood color number. Specify wood color number. Specify with <i>Customiz stain</i> .
	Laminate wardrobe case	See information at left +\$ 69 plus cost of laminate Prices at right Prices at right No cost	Specify laminate color number. ▶ See <i>Surface Materials Reference Manual</i> . Specify wood color number. Specify wood color number. Specify with <i>Customiz stain</i> .
Lock and Keying	Lock	No cost No cost	Specify with 9250 <i>Ember Chrome lock</i> . Specify with 9201 <i>Polished Chrome lock</i> .
	Keying	Factory- and field-installed keying	▶ Page 622
Painted Glass Doors for Wardrobe	Non-locking glass doors on 55¹/₄"H wardrobes	12"W +\$387	Specify with <i>glass doors</i> and select finish.
	Non-locking glass doors on 65⁵/₈"H wardrobes	12"W +\$412	Specify with <i>glass doors</i> and select finish.
	Non-locking glass doors on 72¹/₂"H wardrobes	12"W +\$431	Specify with <i>glass doors</i> and select finish.
	Frame	Painted metal frame for glass doors No cost	Specify with <i>frame</i> and select paint color number.

▶ Options, continued on next page

SIN 711.2

► Options, continued from previous page

Options	Price	Required to Specify
Mirrored Glass Doors for Wardrobe	Non-locking glass doors on 55¹/₄"H wardrobes • 12"W +\$543	Specify with <i>mirrored glass doors</i> and select finish.
	Non-locking glass doors on 65⁵/₈"H wardrobes • 12"W +\$577	Specify with <i>mirrored glass doors</i> and select finish.
	Non-locking glass doors on 72¹/₂"H wardrobes • 12"W +\$602	Specify with <i>mirrored glass doors</i> and select finish.
Frame		
• Painted metal frame for glass doors	No cost	Specify with <i>frame</i> and select paint color number.
Related Products	<ul style="list-style-type: none"> • Single-high overhead cabinets • Double-high overhead cabinets • Organizer, open, and accessory shelves • Suspension/ganging hardware kit 	<ul style="list-style-type: none"> ► Pages 484–490 ► Page 494 ► Page 504 ► Page 522

Specification Information											
Dimensions			Style Number	Base Prices			Options				
D	W	H		Wood Group 1 Case	Laminate Price Group 1 Case	Wood Group 1 Front	Wood Group 1 Front	Wood Group 2	Wood Group 3	Wood Group 2	Wood Group 3
							Wood Case with Wood Front		Laminate Case with Wood Front		
							Wood Group 2	Wood Group 3	Wood Group 2	Wood Group 3	

Leg Base Wardrobes

55¹/₄"H Wardrobes

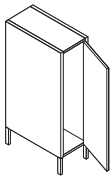

24"	12"	55 ¹ / ₄ "	E6KWL241255L	\$2327	\$1482	\$1964	+\$291	+\$1015	+\$47	+\$164
24"	12"	55 ¹ / ₄ "	E6KWL241255R	\$2327	\$1482	\$1964	+\$291	+\$1015	+\$47	+\$164

65⁵/₈"H Wardrobes

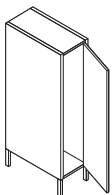

24"	12"	65 ⁵ / ₈ "	E6KWL241265L	\$2547	\$1702	\$2184	+\$291	+\$1015	+\$47	+\$164
24"	12"	65 ⁵ / ₈ "	E6KWL241265R	\$2547	\$1702	\$2184	+\$291	+\$1015	+\$47	+\$164

Tip: 12"W personal wardrobes must attach to an adjacent end panel or storage unit for proper stability.

► Specification Information, continued on next page

Elective Elements

Leg Base Wardrobes, Wood Veneer or Laminate, continued

SIN 711.2

► **Specification Information, continued from previous page**

Specification Information											
Dimensions			Style Number	Base Prices			Options				
D	W	H		Wood Group 1 Case	Laminate Price Group 1 Case	Wood Group 1 Front	Wood Group 1 Front	Wood Group 2	Wood Group 3	Wood Group 2	Wood Group 3
								Wood Case with Wood Front	Laminate Case with Wood Front		
								Wood Group 2	Wood Group 3	Wood Group 2	Wood Group 3

Leg Base Wardrobes

72¹/₂"H Wardrobes

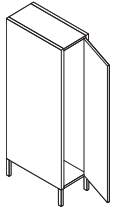

24"	12"	72 ¹ / ₂ "	E6KWL241272L	\$2602	\$1757	\$2239	+\$291	+\$1015	+\$47	+\$164
24"	12"	72 ¹ / ₂ "	E6KWL241272R	\$2602	\$1757	\$2239	+\$291	+\$1015	+\$47	+\$164
:	:	:	:	:	:	:	:	:	:	:

Tip: 12"W personal wardrobes must attach to an adjacent end panel or storage unit for proper stability.

Specifying Above Worksurface Storage

Overhead Cabinets, Shelves, Hutch Kits, Wall-Mounted Tackboards, Tackboard with Slatwall, and Wood Panels with Slatwall

15"H Single-High Overhead Cabinets (SIN 711.2)	484
22"H Single-High Overhead Cabinets (SIN 711.2)	490
Double-High Overhead Cabinets (SIN 711.2)	494
Floating Shelf with Shelf Back Panel (SIN 711.2)	498
Floating Back Panel (SIN 711.2)	502
Organizer, Open, and Accessory Shelves (SIN 711.2)	504
Blade Accessory Shelves (SIN 711.2)	508
Desktop Organizers (SIN 711.2)	510
Insert Back Panels for Overhead Storage (SIN 711.2)	512
Finished Back Panels for Overhead Storage and Desktop Organizers (SIN 711.2)	514
Hutch Kits with Tackboard (SIN 711.2)	518
Hutch Kits—Open (SIN 711.2)	521
Accessories (SIN 711.2)	522
Wall-Mounted Tackboards, Tackboards with Slatwall, Wood Panels with Slatwall, and End Covers (SIN 711.2)	524
Light Valance for Overheads (SIN 711.2)	530
Magnetic Back Painted Glass (SIN 711.2)	532

Service Modules

32 ¹ / ₄ "H Single-High Service Modules (SIN 711.2)	536
36 ⁵ / ₈ "H Single-High Service Modules (SIN 711.2)	540
43 ¹ / ₂ "H Single-High Service Modules (SIN 711.2)	542
Double-High Service Modules (SIN 711.2)	546
Tackboards and Wood Panels with Slatwall—For Use with Service Modules (SIN 711.2)	550
Light Valances for Service Modules (SIN 711.2)	553

15"H Single-High Overhead Cabinets

Wood Veneer or Laminate

SIN 711.2

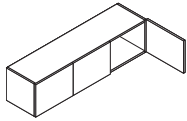

Tip: 15"H single-high overhead cabinets align with 65⁵/₈"H plinth and leg base storage.

Tip: Overhead cabinets cannot attach to 45"H or 55"H Montage panels using back-mount brackets.

Tip: Overhead cabinets can attach to Enhanced Montage off-module panels using end mount brackets.

For laminate price group 2 pricing, please refer to the electronic catalog or SmartTools.

Tip: Glass doors feature self-close hinges and are not available with soft-close hinges. Glass doors are not available with locks.

Tip: Sliding doors only cover 1/2 of the opening. Sliding doors do not lock.

Tip: Cabinet-to-cabinet attachment kits are used to provide rigidity between cabinets mounted side by side in a panel- or wall-mounted application.

Tip: Mounting hardware to suspend overhead cabinets between towers and stacking bookcases is ordered separately.

▶ See *Elective Elements Wood Systems Furniture Specification Guide*.

Standard Includes	Required to Specify
<ul style="list-style-type: none"> Overhead cabinet: <ul style="list-style-type: none"> –Wood group 1 case with wood group 1 front –Laminate price group 1 case with same or contrasting laminate front –Laminate price group 1 case with wood group 1 front Unfinished back Wood and laminate hinged doors have soft-close hinges Glass hinged doors have self-close hinges ADA opening/closing option, if selected Sliding doors have safety stops 	<ol style="list-style-type: none"> Style number Wood or laminate color number for overhead cabinet Laminate color number for laminate fronts on laminate case, if selected Wood color number for wood fronts on laminate cases, if selected Bracket selection (see below) Options, if selected (see below) <p>▶ See <i>Surface Materials</i>, page 566.</p>

Surface Materials	Options	Price	Required to Specify
	Wood overhead cabinet case		
	<ul style="list-style-type: none"> Wood group 2 Wood group 3 Customiz stain 	Prices at right Prices at right No cost	Specify wood color number. Specify wood color number. Specify with <i>Customiz stain</i> .
	Laminate overhead cabinet case		
	<ul style="list-style-type: none"> Laminate price group 2 Open Line laminate 	See information at left +\$ 69 plus cost of laminate	Specify laminate color number. ▶ See <i>Surface Materials Reference Manual</i> .
	<ul style="list-style-type: none"> Wood group 2 on wood fronts Wood group 3 on wood fronts Customiz stain 	Prices at right Prices at right No cost	Specify wood color number. Specify wood color number. Specify with <i>Customiz stain</i> .
	Painted Glass Door(s) for Overhead Cabinets	Non-locking glass door for hinged doors	
	<ul style="list-style-type: none"> On 60"W, 66"W, 72"W, 78"W, 84"W, 90"W, and 96"W hinged door units 	+\$314 per door	Specify with <i>glass door</i> and select finish.
	Non-locking glass door for sliding doors		
	<ul style="list-style-type: none"> On 36"W, 42"W, 48"W, 54"W, and 60"W sliding door units On 66"W, 72"W, 78"W, and 84"W sliding door units On 90"W and 96"W sliding door units 	+\$314 +\$350 +\$387	Specify with <i>glass door</i> and select finish. Specify with <i>glass door</i> and select finish. Specify with <i>glass door</i> and select finish.
	Frame		
	<ul style="list-style-type: none"> Painted metal frame on glass glass door 	No cost	Specify with <i>frame</i> and selected paint color number.
Mirrored Glass Door(s) for Overhead Cabinets	Non-locking glass door for hinged doors		
	<ul style="list-style-type: none"> On 60"W, 66"W, 72"W, 78"W, 84"W, 90"W, and 96"W hinged door units 	+\$440 per door	Specify with <i>mirrored glass door</i> and select finish.
	Non-locking glass door for sliding doors		
	<ul style="list-style-type: none"> On 36"W, 42"W, 48"W, 54"W, and 60"W sliding door units On 66"W, 72"W, 78"W, and 84"W sliding door units On 90"W and 96"W sliding door units 	+\$440 +\$488 +\$543	Specify with <i>mirrored glass door</i> and select finish. Specify with <i>mirrored glass door</i> and select finish. Specify with <i>mirrored glass door</i> and select finish.
	Frame		
	<ul style="list-style-type: none"> Painted metal frame for sliding glass door 	No cost	Specify with <i>frame</i> and select paint color number.

▶ Options, continued on next page

SIN 711.2

► Options, continued from previous page

	Options	Price	Required to Specify
Brackets	Available on all depths		
	• No brackets	No cost	Specify with no brackets.
	• For use with Montage—only available for 72"W and less, on-module	+\$ 31	Specify with Montage back-mount brackets.
	• For use with Montage—end mount brackets	+\$ 31	Specify with Montage end-mount brackets and select finish.
	• Wall-mounted (horizontal cleat)—66"W and smaller	+\$ 94	Specify with wall-mounted brackets.
	• —72"W and larger	+\$128	Specify with wall-mounted brackets.
	Available only on 15⁷/₈"D and 15"D units: Answer and Privacy Wall		
	• For use with Answer—only available for 48"W and less, on-module	+\$ 31	Specify with Answer brackets.
	• For use with Privacy Wall solid wall panels—only available for 72"W and less, on-module	+\$ 31	Specify with Privacy Wall brackets.
ADA on Hinged Doors	• ADA opening/closing on hinged doors	No cost	Specify with ADA opening.
Lock and Keying	Lock		
	• On 30"W and 36"W hinged doors	+\$ 64	Specify with 9250 Ember Chrome lock or 9201 Polished Chrome lock.
	• On 42"W, 48"W, 54"W, 60"W, 66"W, 72"W, and 78"W hinged doors	+\$128	Specify with 9250 Ember Chrome lock or 9201 Polished Chrome lock.
	• On 84"W, 90"W, and 96"W hinged doors	+\$192	Specify with 9250 Ember Chrome lock or 9201 Polished Chrome lock.
	Keying		
	• Factory- and field-installed keying units		► Page 622
Related Products	• Plinth base and leg base high pedestals		► Pages 302 and 356
	• Finished back panels for overhead storage		► Page 514
	• Hutch kits		► Pages 518–521
	• Side support frames and suspension/ganging hardware kit		► Page 522
	• Wall-mounted tackboards, wood panels with slatwall, and end covers		► Page 524
	• Light valance		► Page 530
	• Blade accessory shelf		► Page 508
	• Stacking bookcases		► Pages 318–320 and 460–462
	• Plinth base and leg base towers		► Pages 326–334 and 468–476
	• Underline lighting		► See Storage Specification Guide
	• Metal light housing		► Page 564

Tip: Cabinet-to-cabinet attachment kits are used to provide rigidity between cabinets mounted side by side in a panel- or wall-mounted application.

Tip: Suspension/ganging hardware to suspend overhead cabinets between towers and stacking bookcases is ordered separately.

Tip: Single-high overhead cabinets cannot be mounted on Montage, Answer, or Privacy Walls lower than 38"H. They are not designed to function as a seat.

Tip: ADA opening/closing option features a magnetic touch latch and neutral hinge.

Tip: When stacking single-high overhead cabinets with hinged doors, the ADA option should be selected.

Tip: Finished proud back panels or inserts can be specified separately if the back of the cabinet is visible.

► See Elective Elements Wood Systems Furniture Specification Guide.

Tip: Suspension/ganging hardware to attach overhead cabinets to hutch is included with the hutch kit.

► Specification Information, on next page

Elective Elements

15"H Single-High Overhead Cabinets, Wood Veneer or Laminate, continued

SIN 711.2

► **Options, on previous page**

Specification Information											
Dimensions		Style Number	Number of Doors	Base Prices			Options				
D	W			Wood Group 1 Case	Laminate Price Group 1 Case	Wood Group 1 Front	(Add \$ to Base Price)				
							Wood Case with Wood Front	Wood Group 2	Laminate Case with Wood Front	Wood Group 2	Wood Group 3

Single-High Overheads-15" High

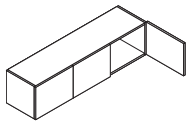

With Hinged Doors

15 7/8"	30"	E6OS153015H	2	\$1464	\$ 860	\$1192	+\$ 97	+\$336	+\$28	+\$ 94
15 7/8"	36"	E6OS153615H	2	\$1565	\$ 961	\$1293	+\$ 97	+\$336	+\$28	+\$ 94
15 7/8"	42"	E6OS154215H	3	\$1646	\$1042	\$1374	+\$ 97	+\$336	+\$28	+\$ 94
15 7/8"	48"	E6OS154815H	3	\$1725	\$1121	\$1453	+\$ 97	+\$336	+\$28	+\$ 94
15 7/8"	54"	E6OS155415H	3	\$1840	\$1236	\$1568	+\$ 97	+\$336	+\$28	+\$ 94
15 7/8"	60"	E6OS156015H	3	\$1954	\$1350	\$1682	+\$ 97	+\$336	+\$28	+\$ 94
15 7/8"	66"	E6OS156615H	4	\$2053	\$1385	\$1717	+\$ 97	+\$336	+\$28	+\$ 94
15 7/8"	72"	E6OS157215H	4	\$2149	\$1417	\$1749	+\$116	+\$406	+\$47	+\$164
15 7/8"	78"	E6OS157815H	4	\$2218	\$1438	\$1770	+\$116	+\$406	+\$47	+\$164
15 7/8"	84"	E6OS158415H	5	\$2292	\$1464	\$1796	+\$116	+\$406	+\$47	+\$164
15 7/8"	90"	E6OS159015H	5	\$2365	\$1490	\$1822	+\$116	+\$406	+\$47	+\$164
15 7/8"	96"	E6OS159615H	5	\$2599	\$1635	\$1967	+\$116	+\$406	+\$47	+\$164

► **Specification Information, continued on next page**

► Specification Information, continued from previous page

Specification Information																					
Dimensions		Style Number	Number of Doors	Base Prices			Options														
D	W			Wood Group 1 Case	Laminate Price Group 1 Case	Wood Group 1 Front	Wood Case with Wood Front	Laminate Case with Wood Front	Wood Group 2	Wood Group 3	Wood Group 2	Wood Group 3									

Single-High Overheads-15" High, continued

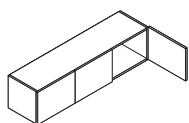

With Hinged Doors, continued

18"	30"	E6OS183015H	2	\$1612	\$1008	\$1340	+\$ 97	+\$336	+\$28	+\$ 94
18"	36"	E6OS183615H	2	\$1723	\$1119	\$1451	+\$ 97	+\$336	+\$28	+\$ 94
18"	42"	E6OS184215H	3	\$1810	\$1206	\$1538	+\$ 97	+\$336	+\$28	+\$ 94
18"	48"	E6OS184815H	3	\$1895	\$1291	\$1623	+\$ 97	+\$336	+\$28	+\$ 94
18"	54"	E6OS185415H	3	\$2024	\$1420	\$1752	+\$ 97	+\$336	+\$28	+\$ 94
18"	60"	E6OS186015H	3	\$2149	\$1545	\$1877	+\$ 97	+\$336	+\$28	+\$ 94
18"	66"	E6OS186615H	4	\$2258	\$1590	\$1922	+\$ 97	+\$336	+\$28	+\$ 94
18"	72"	E6OS187215H	4	\$2365	\$1633	\$1965	+\$116	+\$406	+\$47	+\$164
18"	78"	E6OS187815H	4	\$2441	\$1661	\$1993	+\$116	+\$406	+\$47	+\$164
18"	84"	E6OS188415H	5	\$2522	\$1694	\$2026	+\$116	+\$406	+\$47	+\$164
18"	90"	E6OS189015H	5	\$2599	\$1724	\$2056	+\$116	+\$406	+\$47	+\$164
18"	96"	E6OS189615H	5	\$2860	\$1896	\$2228	+\$116	+\$406	+\$47	+\$164

► Specification Information, continued on next page

Elective Elements

15"H Single-High Overhead Cabinets, Wood Veneer or Laminate, continued

SIN 711.2

► Specification Information, continued from previous page

Specification Information											
• Dimensions		• Style Number	• Number of Doors	• Base Prices			• Options				
D	W			Wood Group 1 Case	Laminate Price Group 1 Case	Wood Group 1 Front	(Add \$ to Base Price)				
				Wood Group 1 Case	Laminate Price Group 1 Case	Wood Group 1 Front	Wood		Laminate Case with Wood Front		
							Wood Case with Wood Front	Wood	Wood	Wood	Wood
							Group 2	Group 3	Group 2	Group 3	Group 3

Single-High Overheads-15" High, continued

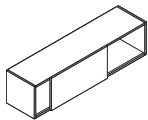

With Sliding Doors

15 7/8"	36"	E6OS153615S	1	\$1565	\$ 961	\$1293	+\$ 97	+\$336	+\$28	+\$94
15 7/8"	42"	E6OS154215S	1	\$1646	\$1042	\$1374	+\$ 97	+\$336	+\$28	+\$94
15 7/8"	48"	E6OS154815S	1	\$1725	\$1121	\$1453	+\$ 79	+\$336	+\$28	+\$94
15 7/8"	54"	E6OS155415S	1	\$1840	\$1236	\$1568	+\$ 97	+\$336	+\$28	+\$94
15 7/8"	60"	E6OS156015S	1	\$1954	\$1350	\$1682	+\$ 97	+\$336	+\$28	+\$94
15 7/8"	66"	E6OS156615S	1	\$2053	\$1385	\$1717	+\$ 97	+\$336	+\$28	+\$94
15 7/8"	72"	E6OS157215S	1	\$2149	\$1417	\$1749	+\$117	+\$406	+\$28	+\$94
15 7/8"	78"	E6OS157815S	1	\$2218	\$1438	\$1770	+\$117	+\$406	+\$28	+\$94
15 7/8"	84"	E6OS158415S	1	\$2292	\$1464	\$1796	+\$117	+\$406	+\$28	+\$94
15 7/8"	90"	E6OS159015S	1	\$2365	\$1490	\$1822	+\$117	+\$406	+\$28	+\$94
15 7/8"	96"	E6OS159615S	1	\$2599	\$1635	\$1967	+\$117	+\$406	+\$28	+\$94
18"	36"	E6OS183615S	1	\$1723	\$1119	\$1451	+\$ 97	+\$336	+\$28	+\$94
18"	42"	E6OS184215S	1	\$1810	\$1206	\$1538	+\$ 97	+\$336	+\$28	+\$94
18"	48"	E6OS184815S	1	\$1895	\$1291	\$1623	+\$ 97	+\$336	+\$28	+\$94
18"	54"	E6OS185415S	1	\$2024	\$1420	\$1752	+\$ 97	+\$336	+\$28	+\$94
18"	60"	E6OS186015S	1	\$2149	\$1545	\$1877	+\$ 97	+\$336	+\$28	+\$94
18"	66"	E6OS186615S	1	\$2258	\$1590	\$1922	+\$ 97	+\$336	+\$28	+\$94
18"	72"	E6OS187215S	1	\$2365	\$1633	\$1965	+\$117	+\$406	+\$28	+\$94
18"	78"	E6OS187815S	1	\$2441	\$1661	\$1993	+\$117	+\$406	+\$28	+\$94
18"	84"	E6OS188415S	1	\$2522	\$1694	\$2026	+\$117	+\$406	+\$28	+\$94
18"	90"	E6OS189015S	1	\$2599	\$1724	\$2056	+\$117	+\$406	+\$28	+\$94
18"	96"	E6OS189615S	1	\$2860	\$1896	\$2228	+\$117	+\$406	+\$28	+\$94

► Specification Information, continued on next page

► Specification Information, continued from previous page

Specification Information							
Dimensions		Style Number	Number of Dividers	Base Prices		Options	
D	W			Wood Group 1 Case	Laminate Price Group 1 Case	(Add \$ to Base Price)	
				Open Front	Open Front	Wood	
						Wood Case with Open Front	
						Wood Group 2	Wood Group 3

Single-High Overheads-15" High, continued

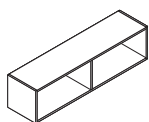

Open

15"	30"	E6OS153015P	0	\$1089	\$ 607	+\$ 59	+\$211
15"	36"	E6OS153615P	1	\$1173	\$ 691	+\$ 59	+\$211
15"	42"	E6OS154215P	1	\$1254	\$ 772	+\$ 59	+\$211
15"	48"	E6OS154815P	1	\$1406	\$ 924	+\$ 59	+\$211
15"	54"	E6OS155415P	1	\$1484	\$1002	+\$ 59	+\$211
15"	60"	E6OS156015P	1	\$1561	\$1079	+\$ 59	+\$211
15"	66"	E6OS156615P	1	\$1639	\$1157	+\$ 59	+\$211
15"	72"	E6OS157215P	3	\$1719	\$1237	+\$116	+\$407
15"	78"	E6OS157815P	3	\$1775	\$1293	+\$116	+\$407
15"	84"	E6OS158415P	3	\$1833	\$1351	+\$116	+\$407
15"	90"	E6OS159015P	3	\$1889	\$1407	+\$116	+\$407
15"	96"	E6OS159615P	3	\$2078	\$1596	+\$116	+\$407
17 1/4"	30"	E6OS173015P	0	\$1197	\$ 715	+\$ 59	+\$211
17 1/4"	36"	E6OS173615P	1	\$1290	\$ 808	+\$ 59	+\$211
17 1/4"	42"	E6OS174215P	1	\$1380	\$ 898	+\$ 59	+\$211
17 1/4"	48"	E6OS174815P	1	\$1547	\$1065	+\$ 59	+\$211
17 1/4"	54"	E6OS175415P	1	\$1633	\$1151	+\$ 59	+\$211
17 1/4"	60"	E6OS176015P	1	\$1719	\$1237	+\$ 59	+\$211
17 1/4"	66"	E6OS176615P	1	\$1804	\$1322	+\$ 59	+\$211
17 1/4"	72"	E6OS177215P	3	\$1889	\$1407	+\$116	+\$407
17 1/4"	78"	E6OS177815P	3	\$1953	\$1471	+\$116	+\$407
17 1/4"	84"	E6OS178415P	3	\$2014	\$1532	+\$116	+\$407
17 1/4"	90"	E6OS179015P	3	\$2078	\$1596	+\$116	+\$407
17 1/4"	96"	E6OS179615P	3	\$2286	\$1804	+\$116	+\$407

22"H Single-High Overhead Cabinets

Wood Veneer or Laminate

SIN 711.2

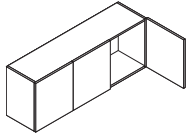

Tip: 22"H single-high overhead cabinets align with 72½"H plinth and leg base storage.

For laminate price group 2 pricing, please refer to the electronic catalog or SmartTools.

Tip: Glass doors feature self-close hinges and are not available with soft-close hinges. Glass doors are not available with locks.

Tip: Cabinet-to-cabinet attachment kits are used to provide rigidity between cabinets mounted side by side in a panel- or wall-mounted application.

Tip: Mounting hardware to suspend overhead cabinets between towers and stacking bookcases is ordered separately.
▶ Page 522

Tip: ADA opening/closing option features a magnetic touch latch and neutral hinge.

Tip: When stacking single-high overhead cabinets with hinged doors, the ADA option should be selected.

Tip: Finished proud back panels can be specified separately if the back of the cabinet is visible.
▶ Page 514

Tip: Mounting hardware to attach overhead cabinets to hutch is included with the hutch kit.

Standard Includes	Required to Specify
<ul style="list-style-type: none"> Overhead cabinet: <ul style="list-style-type: none"> –Wood group 1 case with wood group 1 front –Laminate price group 1 case with same or contrasting laminate front –Laminate price group 1 case with wood group 1 front Unfinished back Wood and laminate hinged doors have soft-close hinges Glass hinged doors have self-close hinges ADA opening/closing option, if selected Sliding doors have safety stops 	<ol style="list-style-type: none"> Style number Wood or laminate color number for overhead cabinet Laminate color number for laminate fronts on laminate case, if selected Wood color number for wood fronts on laminate cases, if selected Bracket selection (see below) Options, if selected (see below) <p>▶ See <i>Surface Materials</i>, page 566.</p>

Options	Price	Required to Specify
Surface Materials Wood overhead cabinet case <ul style="list-style-type: none"> Wood group 2 Wood group 3 Customiz stain 	Prices at right Prices at right No cost	Specify wood color number. Specify wood color number. Specify with <i>Customiz stain</i> .
Laminate overhead cabinet case <ul style="list-style-type: none"> Laminate price group 2 Open Line laminate 	See information at left +\$ 69 plus cost of laminate	Specify laminate color number. ▶ See <i>Surface Materials Reference Manual</i> .
<ul style="list-style-type: none"> Wood group 2 on wood fronts Wood group 3 on wood fronts Customiz stain 	Prices at right Prices at right No cost	Specify wood color number. Specify wood color number. Specify with <i>Customiz stain</i> .
Painted Glass Door(s) for Overhead Cabinets	Non-locking glass door for hinged doors <ul style="list-style-type: none"> On 60"W, 66"W, 72"W, 78"W, 84"W, 90"W, and 96"W hinged door units 	+\$314 per door Specify with <i>glass door</i> and select finish.
	Frame <ul style="list-style-type: none"> Painted metal frame for hinged glass door 	No cost Specify with <i>frame</i> and select paint color number.
Mirrored Glass Door(s) for Overhead Cabinets	Non-locking glass door for hinged doors <ul style="list-style-type: none"> On 60"W, 66"W, 72"W, 78"W, 84"W, 90"W, and 96"W hinged door units 	+\$440 per door Specify with <i>mirrored glass door</i> and select finish.
	Frame <ul style="list-style-type: none"> Painted metal frame for hinged glass door 	No cost Specify with <i>frame</i> and select paint color number.
Brackets	Available on all depths <ul style="list-style-type: none"> No brackets Wall-mounted (horizontal cleat) <ul style="list-style-type: none"> –66"W and smaller –72"W and larger 	No cost +\$ 94 +\$128 Specify with <i>no brackets</i> . Specify with <i>wall-mounted brackets</i> . Specify with <i>wall-mounted brackets</i> .
ADA on Hinged Doors	<ul style="list-style-type: none"> ADA opening/closing on hinged doors 	No cost Specify with <i>ADA opening</i> .
Lock and Keying	Lock <ul style="list-style-type: none"> On 30"W and 36"W hinged doors On 42"W, 48"W, 54"W, 60"W, 66"W, 72"W, and 78"W hinged doors On 84"W, 90"W and 96"W hinged doors 	+\$ 64 +\$128 +\$192 Specify with <i>9250 Ember Chrome lock</i> or <i>9201 Polished Chrome lock</i> . Specify with <i>9250 Ember Chrome lock</i> or <i>9201 Polished Chrome lock</i> . Specify with <i>9250 Ember Chrome lock</i> or <i>9201 Polished Chrome lock</i> .
	Keying <ul style="list-style-type: none"> Factory- and field-installed keying 	▶ Page 622

▶ Options, continued on next page

SIN 711.2

► Options, continued from previous page

Related Products

- | | | |
|-------------------------|--|--|
| Related Products | • Plinth base and leg base high pedestals | ► Pages 302 and 356 |
| | • Finished back panels for overhead storage | ► Page 514 |
| | • Hutch kits | ► Pages 518–521 |
| | • Side support frames and suspension/ganging hardware kit | ► Page 522 |
| | • Wall-mounted tackboards, wood panels with slatwall, and end covers | ► Page 524 |
| | • Light valance | ► Page 530 |
| | • Blade accessory shelf | ► Page 508 |
| | • Stacking bookcases | ► Pages 318–320 and 460–462 |
| | • Plinth base and leg base towers | ► Pages 326–334 and 468–476 |
| | • Underline lighting | ► See <i>Storage Specification Guide</i> |
| • Metal light housing | ► Page 564 | |

Specification Information

Dimensions D W	Style Number	Number of Doors	Base Prices		Options (Add \$ to Base Price)			
			Wood Group 1 Case	Laminate Price Group 1 Case	Wood Group 1 Front	Laminate Price Group 1 Front	Wood Group 2	Wood Group 3

Single-High Overheads-22" High

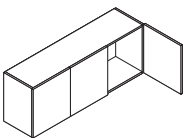

With Hinged Doors

15 7/8"	30"	E6OS153022H	2	\$2333	\$1729	\$2061	+\$ 97	+\$336	+\$28	+\$ 94
15 7/8"	36"	E6OS153622H	2	\$2383	\$1779	\$2111	+\$ 97	+\$336	+\$28	+\$ 94
15 7/8"	42"	E6OS154222H	3	\$2424	\$1820	\$2152	+\$ 97	+\$336	+\$28	+\$ 94
15 7/8"	48"	E6OS154822H	3	\$2464	\$1860	\$2192	+\$ 97	+\$336	+\$28	+\$ 94
15 7/8"	54"	E6OS155422H	3	\$2520	\$1916	\$2248	+\$ 97	+\$336	+\$28	+\$ 94
15 7/8"	60"	E6OS156022H	3	\$2686	\$2082	\$2414	+\$ 97	+\$336	+\$28	+\$ 94
15 7/8"	66"	E6OS156622H	4	\$2821	\$2153	\$2485	+\$ 97	+\$336	+\$28	+\$ 94
15 7/8"	72"	E6OS157222H	4	\$2955	\$2223	\$2555	+\$116	+\$406	+\$47	+\$164
15 7/8"	78"	E6OS157822H	4	\$3051	\$2271	\$2603	+\$116	+\$406	+\$47	+\$164
15 7/8"	84"	E6OS158422H	5	\$3152	\$2324	\$2656	+\$116	+\$406	+\$47	+\$164
15 7/8"	90"	E6OS159022H	5	\$3250	\$2375	\$2707	+\$116	+\$406	+\$47	+\$164
15 7/8"	96"	E6OS159622H	5	\$3575	\$2611	\$2943	+\$116	+\$406	+\$47	+\$164

► Specification Information, continued on next page

Elective Elements

Elective Elements

22"H Single-High Overhead Cabinets, Wood Veneer or Laminate, continued

SIN 711.2

► **Specification Information, continued from previous page**

Specification Information						
Dimensions		Style Number	Number of Dividers	Base Prices		Options (Add \$ to Base Price)
D	W			Wood Group 1 Case	Laminate Price Group 1 Case	
				Open Front	Open Front	Wood Wood Case with Open Front
						Wood Group 2 Wood Group 3

Single-High Overheads-22" High, continued

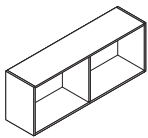

Open							
15"	30"	E6OS153022P	0	\$1799	\$1317	+\$ 59	+\$211
15"	36"	E6OS153622P	1	\$1843	\$1361	+\$ 59	+\$211
15"	42"	E6OS154222P	1	\$1883	\$1401	+\$ 59	+\$211
15"	48"	E6OS154822P	1	\$1959	\$1477	+\$ 59	+\$211
15"	54"	E6OS155422P	1	\$1998	\$1516	+\$ 59	+\$211
15"	60"	E6OS156022P	1	\$2123	\$1641	+\$ 59	+\$211
15"	66"	E6OS156622P	1	\$2248	\$1766	+\$ 59	+\$211
15"	72"	E6OS157222P	3	\$2372	\$1890	+\$116	+\$407
15"	78"	E6OS157822P	3	\$2464	\$1982	+\$116	+\$407
15"	84"	E6OS158422P	3	\$2554	\$2072	+\$116	+\$407
15"	90"	E6OS159022P	3	\$2646	\$2164	+\$116	+\$407
15"	96"	E6OS159622P	3	\$2946	\$2464	+\$116	+\$407

22"H Single-High
Overhead Cabinets

SIN 711.2

Double-High Overhead Cabinets

Wood Veneer or Laminate

SIN 711.2

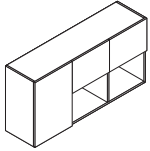

Left-Hand Unit

For laminate price group 2 pricing, please refer to the electronic catalog or SmartTools.

Tip: Glass doors feature self-close hinges and are not available with soft-close hinges. Glass doors are not available with locks.

Tip: Double-high units cannot be mounted on panels or suspended between freestanding or stacking bookcases.

Tip: ADA opening/closing option features a magnetic touch latch and neutral hinge.

Tip: The interior shelf behind the tall (large) door is fixed.

Tip: Only the tall (large) door(s) will lock if locking is specified on the combination units.

Tip: Mounting hardware to suspend overhead cabinets between towers is ordered separately.
▶ See Elective Elements Wood Systems Furniture Specification Guide.

Tip: Mounting hardware to attach overhead cabinets to hutch is included with the hutch kit.

Tip: Double-high overheads line up with 77½"H towers and bookcases when mounted on 18⅞" hutch kits.

Standard Includes	Required to Specify
<ul style="list-style-type: none"> Overhead cabinet: <ul style="list-style-type: none"> –Wood group 1 case with wood group 1 front –Laminate price group 1 case with same or contrasting laminate front –Laminate price group 1 case with wood group 1 front Unfinished back Wood and laminate hinged doors have soft-close hinges Glass hinged doors have self-close hinges ADA opening/closing option, if selected 	<ol style="list-style-type: none"> Style number Wood or laminate color number for overhead cabinet Laminate color number for laminate fronts on laminate case, if selected Wood color number for wood fronts on laminate cases, if selected Bracket selection (see below) Options, if selected (see below) <p>▶ See <i>Surface Materials</i>, page 566.</p>

Options	Price	Required to Specify
Surface Materials Wood overhead cabinet case <ul style="list-style-type: none"> Wood group 2 Wood group 3 Customiz stain 	Prices at right Prices at right No cost	Specify wood color number. Specify wood color number. Specify with <i>Customiz stain</i> .
Laminate overhead cabinet case <ul style="list-style-type: none"> Laminate price group 2 Open Line laminate 	See information at left +\$ 69 plus cost of laminate Prices at right Prices at right No cost	Specify laminate color number. ▶ See <i>Surface Materials Reference Manual</i> . Specify wood color number. Specify wood color number. Specify with <i>Customiz stain</i> .
Painted Glass Doors for Overhead Cabinets Non-locking glass doors <ul style="list-style-type: none"> Small door Large door 	+\$314 per door +\$350 per door	Specify with <i>glass doors</i> and select finish. Specify with <i>glass doors</i> and select finish.
Frame <ul style="list-style-type: none"> Painted metal frame for hinged glass door 	No cost	Specify with <i>frame</i> and select paint color number.
Mirrored Glass Door(s) for Overhead Cabinets Non-locking glass doors <ul style="list-style-type: none"> Small door Large door 	+\$440 per door +\$488 per door	Specify with <i>mirrored glass door</i> and select finish. Specify with <i>mirrored glass door</i> and select finish.
Frame <ul style="list-style-type: none"> Painted metal frame for hinged glass door 	No cost	Specify with <i>frame</i> and select paint color number.
Brackets <ul style="list-style-type: none"> No brackets Wall-mounted (horizontal cleat) <ul style="list-style-type: none"> –66"W and smaller –72"W and larger 	No cost +\$ 94 +\$128	Specify with <i>no brackets</i> . Specify with <i>wall-mounted brackets</i> . Specify with <i>wall-mounted brackets</i> .
ADA on Hinged Doors <ul style="list-style-type: none"> ADA opening/closing on hinged doors 	No cost	Specify with <i>ADA opening</i> .
Lock and Keying Lock <ul style="list-style-type: none"> On combination units On 60"W, 66"W, 72"W, and 78"W all closed units On 84"W, 90"W, and 96"W all closed units 	+\$ 64 +\$128 +\$192	Specify with <i>9250 Ember Chrome lock</i> or <i>9201 Polished Chrome lock</i> . Specify with <i>9250 Ember Chrome lock</i> or <i>9201 Polished Chrome lock</i> . Specify with <i>9250 Ember Chrome lock</i> or <i>9201 Polished Chrome lock</i> .
Keying <ul style="list-style-type: none"> Factory- and field-installed keying units 		▶ Page 622
Shelves <ul style="list-style-type: none"> ¾" shelf Metal shelf 	No cost –\$ 26 per shelf	Specify with <i>¾" shelf</i> . Specify with <i>metal shelves</i> and select paint color number.

▶ Options, continued on next page

► Options, continued from previous page

Related Products

- Finished back panels for overhead storage ► Page 514
- Hutch kits ► Pages 518–521
- Suspension/ganging hardware kit ► Page 522
- Wall-Mounted tackboards, wood panels with with slatwall, and end covers ► Page 524
- Light valance ► Page 530
- Blade accessory shelf ► Page 508
- Plinth base and leg base towers ► Pages 326–334 and 468–476
- Underline lighting ► See *Storage Specification Guide*
- Metal light housing ► Page 564

Specification Information

• Dimensions D W	• Style Number	• Number of Doors	• Base Prices		• Options (Add \$ to Base Price)					
			Wood Group 1 Case	Laminate Price Group 1 Case	Wood Group 1 Front	Laminate Price Group 1 Front	Wood Group 1 Front	Wood Group 2	Wood Group 3	
		Small Large			Wood Case with Wood Front	Laminate Case with Wood Front	Wood Group 2	Wood Group 3	Wood Group 2	Wood Group 3

Double-High Overheads-30" High

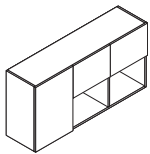

Left-Hand Unit

Left-Hand Combination

Dimensions	Style Number	Number of Doors	Small	Large	Wood Case with Wood Front	Laminate Case with Wood Front	Wood Group 1 Front	Laminate Price Group 1 Front	Wood Group 2	Wood Group 3	Wood Group 2	Wood Group 3
15 7/8" 60"	E6OD156030L	2	1		\$3329	\$2484	\$3118	+\$ 97	+\$336	+\$69	+\$242	
15 7/8" 66"	E6OD156630L	3	1		\$3499	\$2654	\$3288	+\$ 97	+\$336	+\$69	+\$242	
15 7/8" 72"	E6OD157230L	3	1		\$3671	\$2826	\$3460	+\$116	+\$406	+\$69	+\$242	
15 7/8" 78"	E6OD157830L	3	1		\$3796	\$2951	\$3585	+\$117	+\$406	+\$96	+\$335	
15 7/8" 84"	E6OD158430L	3	2		\$3921	\$3076	\$3710	+\$117	+\$406	+\$96	+\$335	
15 7/8" 90"	E6OD159030L	3	2		\$4046	\$3201	\$3835	+\$117	+\$406	+\$96	+\$335	
15 7/8" 96"	E6OD159630L	3	2		\$4459	\$3614	\$4248	+\$117	+\$406	+\$96	+\$335	

► Specification Information, continued on next page

Elective Elements

Double-High Overhead Cabinets, Wood Veneer or Laminate, continued

SIN 711.2

► **Specification Information, continued from previous page**

Specification Information

• Dimensions D W	• Style Number	• Number of Doors	• Base Prices			• Options (Add \$ to Base Price)				
			Wood Group 1 Case	Laminate Price Group 1 Case	Wood Group 1 Front	Wood Group 2	Wood Group 3	Laminate Case with Wood Front	Wood Group 2	Wood Group 3
		Small Large								

Double-High Overheads-30" High, continued

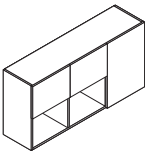

Right-Hand Unit

Right-Hand Combination

157/8" 60"	E6OD156030R	2	1	\$3329	\$2484	\$3118	+\$ 97	+\$336	+\$69	+\$242
157/8" 66"	E6OD156630R	3	1	\$3499	\$2654	\$3288	+\$ 97	+\$336	+\$69	+\$242
157/8" 72"	E6OD157230R	3	1	\$3671	\$2826	\$3460	+\$116	+\$406	+\$69	+\$242
157/8" 78"	E6OD157830R	3	1	\$3796	\$2951	\$3585	+\$117	+\$406	+\$96	+\$335
157/8" 84"	E6OD158430R	3	2	\$3921	\$3076	\$3710	+\$117	+\$406	+\$96	+\$335
157/8" 90"	E6OD159030R	3	2	\$4046	\$3201	\$3835	+\$117	+\$406	+\$96	+\$335
157/8" 96"	E6OD159630R	3	2	\$4459	\$3614	\$4248	+\$117	+\$406	+\$96	+\$335

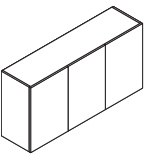

All Closed

157/8" 60"	E6OD156030C	N.A.	3	\$3417	\$2572	\$3238	+\$ 97	+\$336	+\$69	+\$242
157/8" 66"	E6OD156630C	N.A.	4	\$3591	\$2746	\$3412	+\$ 97	+\$336	+\$69	+\$242
157/8" 72"	E6OD157230C	N.A.	4	\$3761	\$2916	\$3582	+\$116	+\$406	+\$69	+\$242
157/8" 78"	E6OD157830C	N.A.	4	\$3886	\$3041	\$3707	+\$117	+\$406	+\$96	+\$335
157/8" 84"	E6OD158430C	N.A.	5	\$4013	\$3168	\$3834	+\$117	+\$406	+\$96	+\$335
157/8" 90"	E6OD159030C	N.A.	5	\$4136	\$3291	\$3957	+\$117	+\$406	+\$96	+\$335
157/8" 96"	E6OD159630C	N.A.	5	\$4549	\$3704	\$4370	+\$117	+\$406	+\$96	+\$335

► **Specification Information, continued on next page**

► Specification Information, continued from previous page

Specification Information								
Dimensions			Style Number	Number of Dividers	Base Prices		Options	
D	W	H			Wood Group 1 Case	Laminate Price Group 1 Case	(Add \$ to Base Price)	
					Open Front	Open Front	Wood	
							Wood Case with Open Front	
							Wood Group 2	Wood Group 3

Double-High Overheads-30" High, continued

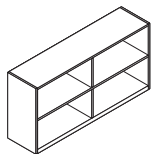

Open								
D	W	H	Style Number	Number of Dividers	Wood Group 1 Case	Laminate Price Group 1 Case	Options (Add \$ to Base Price)	Options (Add \$ to Base Price)
15"	60"	30"	E6OD156030P	1	\$2684	\$1837	+\$ 96	+\$335
15"	66"	30"	E6OD156630P	1	\$2855	\$2008	+\$ 96	+\$335
15"	72"	30"	E6OD157230P	3	\$3025	\$2178	+\$116	+\$407
15"	78"	30"	E6OD157830P	3	\$3152	\$2305	+\$116	+\$407
15"	84"	30"	E6OD158430P	3	\$3277	\$2430	+\$116	+\$407
15"	90"	30"	E6OD159030P	3	\$3401	\$2554	+\$116	+\$407
15"	96"	30"	E6OD159630P	3	\$3815	\$2968	+\$116	+\$407

Floating Shelf with Shelf Back Panel

SIN 711.2

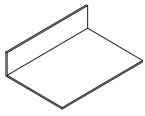

Standard Includes	Required to Specify
<ul style="list-style-type: none"> Floating shelf: 3/4" thick wood veneer with matching edge Shelf back panel: 3/4" thick wood veneer with matching edge Attachment brackets 	<ol style="list-style-type: none"> Style number Size option (see below under Required Selections) Shelf back panel height (see below under Required Selections) Floating shelf depth (see below under Required Selections) Floating shelf with shelf back panel width (see below under Required Selections) Color scheme (see below under Required Selections) Wood veneer color number for floating shelf Wood veneer color number for shelf back panel Options, if selected (see below) <p>▶ See <i>Surface Materials</i>, page 565.</p>

Tip: Refer to SmartTools for parametric pricing upcharges and sizes, available in 1/16" increments.

Tip: Not all modular sizes are represented here. Please refer to SmartTools for all available sizes.

Size Option	Required Selections	Price	Required to Specify
	<ul style="list-style-type: none"> Modular Parametric 	No cost No cost	Specify with <i>modular</i> . Specify with <i>parametric</i> .
Shelf Back Panel Height	<ul style="list-style-type: none"> 15"H 22"H 30"H 	Prices at right Prices at right Prices at right	Specify with <i>15"H</i> . Specify with <i>22"H</i> . Specify with <i>30"H</i> .
Floating Shelf Depth	<ul style="list-style-type: none"> 6"D 12"D 	Prices at right Prices at right	Specify with <i>6"D</i> . Specify with <i>12"D</i> .
Floating Shelf with Shelf Back Panel Width	<ul style="list-style-type: none"> 36"W 54"W 72"W 90"W 	Prices at right Prices at right Prices at right Prices at right	Specify with <i>36"W</i> . Specify with <i>54"W</i> . Specify with <i>72"W</i> . Specify with <i>90"W</i> .
Color Scheme	<ul style="list-style-type: none"> Single finish Multiple laminates Laminate/veneer mix 	No cost No cost No cost	Specify with <i>single finish</i> . Specify with <i>multiple laminates</i> . Specify with <i>laminate/veneer mix</i> .

Options	Price	Required to Specify	
Surface Materials			
Single finish floating shelf and shelf back panel			
<ul style="list-style-type: none"> Laminate Open Line laminate (OLL) 	Prices at right +\$69	Specify laminate finish number. ▶ See <i>Surface Materials Reference Manual</i> .	
<ul style="list-style-type: none"> Wood group 2 Wood group 3 	plus cost of laminate Prices at right Prices at right	Specify wood color number. Specify wood color number.	
Multiple laminates floating shelf and shelf back panel			
<ul style="list-style-type: none"> Laminate Open Line laminate (OLL) 	Prices at right +\$69	Specify laminate finish number. ▶ See <i>Surface Materials Reference Manual</i> .	
	plus cost of laminate		
Laminate/veneer mix floating shelf and shelf back panel			
<ul style="list-style-type: none"> Laminate Open Line laminate (OLL) 	Prices at right +\$69	Specify laminate finish number. ▶ See <i>Surface Materials Reference Manual</i> .	
	plus cost of laminate		
<ul style="list-style-type: none"> Wood group 2 Wood group 3 	Prices at right Prices at right	Specify wood color number. Specify wood color number.	
Shelf Back Panel Thickness	<ul style="list-style-type: none"> 3/4" thick 1" thick 	No cost Prices at right	Specify with <i>3/4" back panel thickness</i> . Specify with <i>1" back panel thickness</i> .

	Defaulted Components	Price	Condition
Attachment Brackets	• Two brackets	+\$100 Included in Base Price	Number of brackets will be automatically applied based on dimensions of shelf.
	• Three brackets	+\$150 Included in Base Price	
	• Four brackets	+\$200 Included in Base Price	
	• Five brackets	+\$250 Included in Base Price	
	• Six brackets	+\$300 Included in Base Price	

Related Products • Floating back panel ▶ Page 502

Shelf Back Panel 1" Thickness Upcharges

• Dimensions		• Modular Width			
D	H	36"W	54"W	72"W	90"W
:	:	:	:	:	:
:	:	:	:	:	:

6"D Shelf Back Panel

6"D	15"H	+\$22.68	+\$34.02	+\$45.36	+\$ 56.70
6"D	22"H	+\$30.24	+\$45.36	+\$60.48	+\$ 75.60
6"D	30"H	+\$38.88	+\$58.32	+\$77.76	+\$ 97.20
:	:	:	:	:	:

12"D Shelf Back Panel

12"D	15"H	+\$29.16	+\$43.74	+\$58.32	+\$ 72.90
12"D	22"H	+\$36.72	+\$55.08	+\$73.44	+\$ 91.80
12"D	30"H	+\$45.36	+\$68.04	+\$90.72	+\$113.40
:	:	:	:	:	:

▶ **Specification Information, on next page**

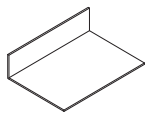
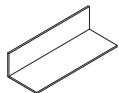

Floating Shelf with Shelf Back Panel, continued

SIN 711.2

► Options, on previous page

Specification Information

Style Number	Dimensions Height	Base Prices (with Bracket Attachments)			
		36"W	54"W	72"W	90"W

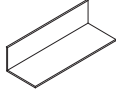

6"D Floating Shelf

Wood Group 1

E6FSH	Height	36"W	54"W	72"W	90"W
	15"H	\$ 750.16	\$1011.84	\$1167.68	\$1384.00
	22"H	\$ 866.08	\$1117.68	\$1349.12	\$1560.40
	30"H	\$ 994.24	\$1316.40	\$1547.84	\$1740.40

Laminate

E6FSH	Height	36"W	54"W	72"W	90"W
	15"H	\$ 614.08	\$ 807.72	\$ 895.52	\$1043.80
	22"H	\$ 684.64	\$ 845.52	\$ 986.24	\$1132.00
	30"H	\$ 760.96	\$ 966.48	\$1107.20	\$1189.60

Wood Group 2

E6FSH	Height	36"W	54"W	72"W	90"W
	15"H	\$ 856.00	\$1170.60	\$1379.36	\$1648.60
	22"H	\$ 1007.20	\$1329.36	\$1631.36	\$1862.80
	30"H	\$ 1175.68	\$1588.56	\$1858.88	\$2129.20

Wood Group 3

E6FSH	Height	36"W	54"W	72"W	90"W
	15"H	\$ 931.60	\$1284.00	\$1530.56	\$1837.60
	22"H	\$ 1108.00	\$1480.56	\$1832.96	\$2114.80
	30"H	\$ 1305.28	\$1782.96	\$2118.08	\$2453.20

Laminate/Wood Mix

E6FSH	Height	36"W	54"W	72"W	90"W
	15"H	\$ 682.12	\$ 909.78	\$1031.60	\$1213.90
	22"H	\$ 775.36	\$ 981.60	\$1167.68	\$1358.80
	30"H	\$ 877.60	\$1141.44	\$1340.48	\$1481.20

Tip: 3" clearance is required from the ceiling to the top of the back panel.

► Specification Information, continued on next page

► Specification Information, continued from previous page

Specification Information

Style Number	Dimensions Height	Base Prices (with Bracket Attachments)			
		36"W	54"W	72"W	90"W

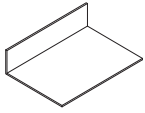

12"D Floating Shelf

Wood Group 1

E6FSH	Height	36"W	54"W	72"W	90"W
	15"H	\$ 838.72	\$1156.02	\$1366.40	\$1513.60
	22"H	\$ 944.56	\$1251.60	\$1472.96	\$1657.60
	30"H	\$1067.68	\$1329.36	\$1591.04	\$1988.80

Laminate

E6FSH	Height	36"W	54"W	72"W	90"W
	15"H	\$ 663.76	\$ 893.58	\$1016.48	\$1100.50
	22"H	\$ 724.24	\$ 921.12	\$1056.80	\$1137.40
	30"H	\$ 795.52	\$ 921.12	\$1076.96	\$1346.20

Wood Group 2

E6FSH	Height	36"W	54"W	72"W	90"W
	15"H	\$ 974.80	\$1360.14	\$1638.56	\$1805.20
	22"H	\$1115.92	\$1508.64	\$1766.72	\$2024.80
	30"H	\$1279.36	\$1646.88	\$1953.92	\$2442.40

Wood Group 3

E6FSH	Height	36"W	54"W	72"W	90"W
	15"H	\$1072.00	\$1505.94	\$1832.96	\$2048.20
	22"H	\$1238.32	\$1692.24	\$2011.52	\$2330.80
	30"H	\$1430.56	\$1873.68	\$2256.32	\$2820.40

Laminate/Wood Mix

E6FSH	Height	36"W	54"W	72"W	90"W
	15"H	\$ 751.24	\$1024.80	\$1191.44	\$1319.20
	22"H	\$ 834.40	\$1086.36	\$1277.12	\$1412.80
	30"H	\$ 931.60	\$1125.24	\$1349.12	\$1686.40

Tip: 3" clearance is required from the ceiling to the top of the back panel.



Floating Back Panel

SIN 711.2

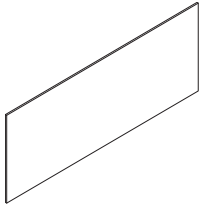

Tip: Refer to SmartTools for parametric pricing upcharges and sizes, available in 1/16" increments.

Tip: Not all modular sizes are represented here. Please refer to SmartTools for all available sizes.

For laminate price group 2 pricing, please refer to the electronic catalog or SmartTools.

Tip: Vertical grain direction is only allowed on widths of 60" or less.

Standard Includes	Required to Specify
-------------------	---------------------

- Back panel: 3/4" thick wood group 1 veneer with matching edge
- Attachment brackets

- 1 Style number
 - 2 Size option (see below under Required Selections)
 - 3 Height (see below under Required Selections)
 - 4 Width (see below under Required Selections)
 - 5 Wood veneer color number
 - 6 Options, if selected (see below)
- ▶ See *Surface Materials*, page 565.

Size Option	Required Selections	Price	Required to Specify
-------------	---------------------	-------	---------------------

Size Option	• Modular	No cost	Specify with modular.
	• Parametric	No cost	Specify with parametric.
Height	• 8"H	Prices at right	Specify with 8"H.
	• 15"H	Prices at right	Specify with 15"H.
	• 22"H	Prices at right	Specify with 22"H.
	• 36"H	Prices at right	Specify with 36"H.
	• 48"H	Prices at right	Specify with 48"H.
Width	• 36"W	Prices at right	Specify with 36"W.
	• 54"W	Prices at right	Specify with 54"W.
	• 72"W	Prices at right	Specify with 72"W.
	• 90"W	Prices at right	Specify with 90"W.

Surface Materials	Options	Price	Required to Specify
-------------------	---------	-------	---------------------

Surface Materials	• Laminate price group 1	Prices at right	Specify laminate color number.
	• Laminate price group 2	See information at left	Specify laminate color number.
	• Open Line laminate (OLL)	+\$ 69 plus cost of laminate	▶ See <i>Surface Materials Reference Manual</i> .
	• Wood group 2	Prices at right	Specify wood color number.
	• Wood group 3	Prices at right	Specify wood color number.

Thickness	• 3/4" thick	No cost	Specify with 3/4" back panel thickness.
	• 1" thick	Prices below	Specify with 1" back panel thickness.

Grain Direction	• Vertical	No cost	Specify with vertical grain direction.
	• Horizontal	No cost	Specify with horizontal grain direction.

Attachment Brackets	Defaulted Components	Price	Condition
---------------------	----------------------	-------	-----------

Attachment Brackets	• Two brackets	+\$100 Included in Base Price	Number of brackets will be automatically applied based on dimensions of shelf.
	• Three brackets	+\$150 Included in Base Price	
	• Four brackets	+\$200 Included in Base Price	
	• Five brackets	+\$250 Included in Base Price	
	• Six brackets	+\$300 Included in Base Price	

Related Products	• Floating shelf with shelf back panel	▶ Page 498
-------------------------	--	------------

1" Thickness Upcharges

Dimensions Height	Modular Width			
	36"W	54"W	72"W	90"W
8"	+\$ 8.64	+\$12.96	+\$ 17.28	+\$ 21.60
15"	+\$16.20	+\$24.30	+\$ 32.40	+\$ 40.50
22"	+\$23.76	+\$35.64	+\$ 47.52	+\$ 59.40
36"	+\$38.88	+\$58.32	+\$ 77.76	+\$ 97.20
48"	+\$51.84	+\$77.76	+\$103.68	+\$129.60

Specification Information

Style Number	Dimensions Height	Base Prices (with Bracket Attachments)			
		36"W	54"W	72"W	90"W

Floating Back Panel

Wood Veneer

E6LBPSH	Height	36"W	54"W	72"W	90"W
	8"	\$ 451.36	\$ 582.00	\$ 695.36	\$ 790.00
	15"	\$ 564.40	\$ 757.50	\$ 880.40	\$1100.50
	22"	\$ 694.00	\$ 898.44	\$1072.20	\$1339.00
	36"	\$ 916.48	\$1219.20	\$1470.08	\$1837.60
	48"	\$1050.40	\$1420.08	\$1893.44	\$2280.40

Laminate

E6LBPSH	Height	36"W	54"W	72"W	90"W
	8"	\$ 425.44	\$ 543.12	\$ 643.52	\$ 725.20
	15"	\$ 515.80	\$ 684.60	\$ 783.20	\$ 979.00
	22"	\$ 622.72	\$ 791.52	\$ 944.48	\$1180.60
	36"	\$ 799.84	\$1063.68	\$1262.72	\$1578.40
	48"	\$ 912.16	\$1212.72	\$1616.96	\$1978.00

Wood Group 2

E6LBPSH	Height	36"W	54"W	72"W	90"W
	8"	\$ 471.52	\$ 612.24	\$ 735.68	\$ 840.40
	15"	\$ 602.20	\$ 814.20	\$ 956.00	\$1195.00
	22"	\$ 749.44	\$ 981.60	\$1166.24	\$1457.80
	36"	\$1007.20	\$1335.84	\$1625.60	\$2032.00
	48"	\$1154.08	\$1575.60	\$2100.80	\$2496.40

Wood Group 3

E6LBPSH	Height	36"W	54"W	72"W	90"W
	8"	\$ 485.92	\$ 633.84	\$ 764.48	\$ 876.40
	15"	\$ 629.20	\$ 854.70	\$1010.00	\$1262.50
	22"	\$ 789.04	\$1041.00	\$1245.44	\$1556.80
	36"	\$1072.00	\$1433.04	\$1755.20	\$2194.00
	48"	\$1240.48	\$1705.20	\$2273.60	\$2712.40

Tip: 3" clearance is required from the ceiling to the top of the back panel.

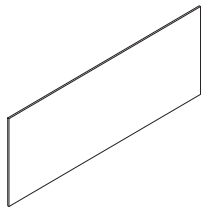

Organizer, Open, and Accessory Shelves

Wood Veneer or Laminate

SIN 711.2

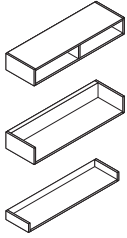

For laminate price group 2 pricing, please refer to the electronic catalog or SmartTools.

Tip: When back mounting 7½"H shelves on Montage panels, approximately 4" of the mounting bracket will be visible above the shelf.

Tip: Open shelves are not recommended for use as bookshelves.

Tip: Open and organizer shelves can attach to Enhanced Montage off-module panels using end-mount brackets.

Tip: Open shelves and organizer shelves should not be wall-mounted on Montage, Answer, or Privacy Wall below 38". They are not designed to function as a seat, or for heavy, bulk storage such as books.

Standard Includes	Required to Specify
<ul style="list-style-type: none"> Shelf: wood group 1 veneer or laminate price group 1 Organizer or open shelf: unfinished back Accessory shelf back: 4799 Platinum Metallic only 	<ol style="list-style-type: none"> Style number Wood or laminate color number for shelf Bracket selection (see below) Options, if selected (see below) <p>▶ See <i>Surface Materials</i>, page 566.</p>

Options	Price	Required to Specify
Surface Materials <ul style="list-style-type: none"> Wood group 2 Wood group 3 Customiz stain 	<ul style="list-style-type: none"> Prices at right Prices at right No cost 	<ul style="list-style-type: none"> Specify wood color number. Specify wood color number. Specify <i>with Customiz stain</i>.

Laminate organizer, open, or accessory shelf <ul style="list-style-type: none"> Laminate price group 2 Open Line laminate 	<ul style="list-style-type: none"> See information at left +\$ 69 plus cost of laminate 	<ul style="list-style-type: none"> Specify laminate color number. <p>▶ See <i>Surface Materials Reference Manual</i>.</p>
--	--	--

Brackets for Organizer and Open Shelves	Available on 15"D and 17¼"D units	Price	Required to Specify
	No brackets	No cost	Specify <i>with no brackets</i> .
	For use with Montage—only available for 72"W and less, on-module	+\$ 31	Specify <i>with Montage back-mount brackets</i> and select finish.
	For use with Montage—end mount brackets	+\$ 31	Specify <i>with Montage end-mount brackets</i> and select finish.
	Wall-mounted (horizontal cleat)		
	—66"W and smaller	+\$ 94	Specify <i>with wall-mounted brackets</i> .
	—72"W and larger	+\$128	Specify <i>with wall-mounted brackets</i> .

Available only on 15"D units: Answer and Privacy Wall			
	For use with Answer—only available for 48"W and less, on-module	+\$ 31	Specify <i>with Answer brackets</i> .
	For use with Privacy Wall solid wall panels—only available for 72"W and less, on-module	+\$ 31	Specify <i>with Privacy Wall brackets</i> .

Related Products	Options	Price	Required to Specify
	Plinth base and leg base high pedestals		▶ Pages 302 and 356
	Finished back panels for overhead storage		▶ Page 514
	Hutch kits		▶ Pages 518–521
	Side support frames and suspension/ganging hardware kit		▶ Page 522
	Wall-mounted tackboards, wood panels with slatwall, and end covers		▶ Page 524
	Light valance		▶ Page 530
	Blade accessory shelf		▶ Page 508
	Stacking bookcases		▶ Pages 318–320 and 460–462
	Plinth base and leg base towers		▶ Pages 326–334 and 468–476
	Underline lighting		▶ See <i>Storage Specification Guide</i>
	Metal light housing		▶ Page 564

Specification Information

Dimensions			Style Number	Number of Dividers	Base Prices		Options	
D	W	H			Wood Group 1 Case	Laminate Price Group 1 Case	Wood (Add \$ Base Price)	
							Wood	Wood
							Group 2	Group 3

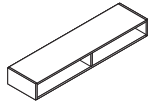

Organizer Shelves with Dividers

15"	30"	7½"	E60015307	0	\$1123	\$ 851	+\$ 59	+\$211
15"	36"	7½"	E60015367	1	\$1153	\$ 881	+\$ 59	+\$211
15"	42"	7½"	E60015427	1	\$1208	\$ 942	+\$ 59	+\$211
15"	48"	7½"	E60015487	1	\$1264	\$ 993	+\$ 59	+\$211
15"	54"	7½"	E60015547	1	\$1281	\$1010	+\$ 59	+\$211
15"	60"	7½"	E60015607	1	\$1302	\$1031	+\$ 59	+\$211
15"	66"	7½"	E60015667	1	\$1333	\$1062	+\$ 59	+\$211
15"	72"	7½"	E60015727	1	\$1364	\$1092	+\$116	+\$407
15"	78"	7½"	E60015787	1	\$1420	\$1149	+\$116	+\$407
15"	84"	7½"	E60015847	3	\$1474	\$1203	+\$116	+\$407
15"	90"	7½"	E60015907	3	\$1529	\$1257	+\$116	+\$407
15"	96"	7½"	E60015967	3	\$1681	\$1318	+\$116	+\$407
17¼"	30"	7½"	E60017307	0	\$1235	\$ 963	+\$ 59	+\$211
17¼"	36"	7½"	E60017367	1	\$1269	\$ 997	+\$ 59	+\$211
17¼"	42"	7½"	E60017427	1	\$1329	\$1057	+\$ 59	+\$211
17¼"	48"	7½"	E60017487	1	\$1389	\$1117	+\$ 59	+\$211
17¼"	54"	7½"	E60017547	1	\$1410	\$1138	+\$ 59	+\$211
17¼"	60"	7½"	E60017607	1	\$1432	\$1160	+\$ 59	+\$211
17¼"	66"	7½"	E60017667	1	\$1465	\$1193	+\$ 59	+\$211
17¼"	72"	7½"	E60017727	1	\$1500	\$1228	+\$116	+\$407
17¼"	78"	7½"	E60017787	1	\$1561	\$1289	+\$116	+\$407
17¼"	84"	7½"	E60017847	3	\$1622	\$1350	+\$116	+\$407
17¼"	90"	7½"	E60017907	3	\$1680	\$1408	+\$116	+\$407
17¼"	96"	7½"	E60017967	3	\$1850	\$1487	+\$116	+\$407

► **Specification Information, continued on next page**

Organizer, Open, and Accessory Shelves, Wood Veneer or Laminate, continued

SIN 711.2

► Specification Information, continued from previous page

Specification Information								
Dimensions			Style Number	Number of Dividers	Base Prices		Options	
D	W	H			Wood Group 1 Case	Laminate Price Group 1 Case	Wood (Add \$ Base Price)	
							Wood Group 2	Wood Group 3

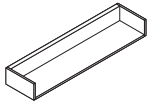

Open Shelves with No Dividers

15"	30"	7½"	E6OF15307	N.A.	\$817	\$546	+\$59	+\$211
15"	36"	7½"	E6OF15367	N.A.	\$846	\$575	+\$59	+\$211
15"	42"	7½"	E6OF15427	N.A.	\$902	\$631	+\$59	+\$211
15"	48"	7½"	E6OF15487	N.A.	\$920	\$649	+\$59	+\$211
15"	54"	7½"	E6OF15547	N.A.	\$953	\$682	+\$59	+\$211
15"	60"	7½"	E6OF15607	N.A.	\$984	\$713	+\$59	+\$211

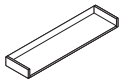

Accessory Shelves

12"	30¾"	3¾"	E6AS12303	N.A.	\$783	\$511	+\$28	+\$94
12"	36¾"	3¾"	E6AS12363	N.A.	\$808	\$536	+\$28	+\$94
12"	45¾"	3¾"	E6AS12453	N.A.	\$865	\$593	+\$28	+\$94
12"	48¾"	3¾"	E6AS12483	N.A.	\$884	\$612	+\$28	+\$94

Tip: Accessory shelves mount below overhead cabinets or service modules. They do not mount to walls or panels.

Tip: Accessory shelves must be aligned with a partition or end panel at each end.

Organizer, Open, and
Accessory Shelves

SIN 711.2

Blade Accessory Shelves

For Use with Overheads, Side Support, and Hutch Kit

SIN 711.2

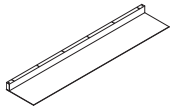

Tip: Blade accessory shelves mount below overhead cabinets or service modules. They do not mount to walls or panels.

Tip: Blade accessory shelf is aluminum. It is not magnetic.

Standard Includes

- Metal blade shelf: paint
- Attachment hardware
- Two end caps

Required to Specify

- 1 Style number
- 2 Paint color number for shelf
- ▶ See *Surface Materials*, page 566.

Related Products

- Finished back panels for overhead storage
- Hutch kits
- Side support frames and suspension/ganging hardware kit
- Wall-mounted tackboards, wood panels with slatwall, and end covers
- Underline lighting
- Metal light housing

- ▶ Page 514
- ▶ Pages 518–521
- ▶ Page 522
- ▶ Page 524
- ▶ See *Storage Specification Guide*
- ▶ Page 564

Specification Information

Dimensions			Style	Price
D	W	H	Number	

For Use with Overhead Applications

14 1/8"	47 3/4"	3 3/16"	E6BA144830	\$ 813
14 1/8"	53 3/4"	3 3/16"	E6BA145430	\$ 921
14 1/8"	59 3/4"	3 3/16"	E6BA146030	\$1029
14 1/8"	65 3/4"	3 3/16"	E6BA146630	\$1138
14 1/8"	71 3/4"	3 3/16"	E6BA147230	\$1245
14 1/8"	77 3/4"	3 3/16"	E6BA147830	\$1354
14 1/8"	83 3/4"	3 3/16"	E6BA148430	\$1462
14 1/8"	89 3/4"	3 3/16"	E6BA149030	\$1570
14 1/8"	95 3/4"	3 3/16"	E6BA149630	\$1678

For Use with Single Side Support or Single Hutch Kit

14 1/8"	47 1/16"	3 3/16"	E6BA14473S	\$ 813
14 1/8"	53 1/16"	3 3/16"	E6BA14533S	\$ 921
14 1/8"	59 1/16"	3 3/16"	E6BA14593S	\$1029
14 1/8"	65 1/16"	3 3/16"	E6BA14653S	\$1138
14 1/8"	71 1/16"	3 3/16"	E6BA14713S	\$1245
14 1/8"	77 1/16"	3 3/16"	E6BA14773S	\$1354
14 1/8"	83 1/16"	3 3/16"	E6BA14833S	\$1462
14 1/8"	89 1/16"	3 3/16"	E6BA14893S	\$1570
14 1/8"	95 1/16"	3 3/16"	E6BA14953S	\$1678

▶ **Specification Information, continued on next page**

SIN 711.2

► Specification Information, continued from previous page

Specification Information

Dimensions			Style Number	Price
D	W	H		
For Use with Two Sided Hutch Kits				
14 ¹ / ₈ "	46 ⁵ / ₁₆ "	3 ³ / ₁₆ "	E6BA14463M	\$ 813
14 ¹ / ₈ "	52 ⁵ / ₁₆ "	3 ³ / ₁₆ "	E6BA14523M	\$ 921
14 ¹ / ₈ "	58 ⁵ / ₁₆ "	3 ³ / ₁₆ "	E6BA14583M	\$1029
14 ¹ / ₈ "	64 ⁵ / ₁₆ "	3 ³ / ₁₆ "	E6BA14643M	\$1138
14 ¹ / ₈ "	70 ⁵ / ₁₆ "	3 ³ / ₁₆ "	E6BA14703M	\$1245
14 ¹ / ₈ "	76 ⁵ / ₁₆ "	3 ³ / ₁₆ "	E6BA14763M	\$1354
14 ¹ / ₈ "	82 ⁵ / ₁₆ "	3 ³ / ₁₆ "	E6BA14823M	\$1462
14 ¹ / ₈ "	88 ⁵ / ₁₆ "	3 ³ / ₁₆ "	E6BA14883M	\$1570
14 ¹ / ₈ "	94 ⁵ / ₁₆ "	3 ³ / ₁₆ "	E6BA14943M	\$1678

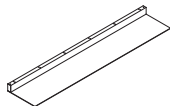

Desktop Organizers

Wood Veneer or Laminate

SIN 711.2

Caution: Vertical organizer must be used against a wall with a service module or a hutch kit with a full back. A hutch kit with a partial back can be used if the vertical organizer is placed in the corner of the hutch kit.

Tip: If there is a need to support an overhead, use a stacking paper organizer rather than a vertical organizer. The vertical organizer fits under an overhead, but does not attach.
 ▶ Page 523

For laminate price group 2 pricing, please refer to the electronic catalog or SmartTools.

Tip: When a vertical desktop organizer is used, there is not enough depth for both a tackboard and a standard light valance. Consider an LED shelf light with or without a metal light housing.

Tip: The vertical desktop organizer must be used under a shelf, service module, or overhead, even though it does not attach, to limit the weight placed on its shelves.

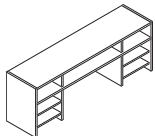

Standard Includes		Required to Specify	
<ul style="list-style-type: none"> Organizer: wood group 1 veneer or laminate price group 1 Shelves: 4799 Platinum Metallic only 		<ol style="list-style-type: none"> Style number Wood or laminate color number for organizer Options, if selected (see below) ▶ See <i>Surface Materials</i> , page 566.	
Options		Price	Required to Specify
Surface Materials	Wood desktop organizer		
	<ul style="list-style-type: none"> Wood group 2 Wood group 3 Customiz stain 	+\$ 47 +\$164 No cost	Specify wood color number. Specify wood color number. Specify with <i>Customiz stain</i> .
	Laminate desktop organizer		
	<ul style="list-style-type: none"> Laminate price group 2 Open Line laminate 	See information at left +\$ 69 plus cost of laminate	Specify laminate color number. ▶ See <i>Surface Materials Reference Manual</i> .
Related Products	<ul style="list-style-type: none"> Back panel for desktop organizers 		▶ Page 514

Specification Information					
Dimensions			Style	Base Prices	
D	W	H	Number	Wood Group 1 Case	Laminate Price Group 1 Case

Desktop Organizers

Combo Organizers

15"	60"	21 ⁵ / ₈ "	AWAO156021C	\$2555	\$1882
15"	72"	21 ⁵ / ₈ "	AWAO157221C	\$3115	\$2290

Vertical Organizer

12 ³ / ₈ "	14 ³ / ₈ "	21 ¹ / ₂ "	AWAO141421V	\$865	\$597
----------------------------------	----------------------------------	----------------------------------	--------------------	-------	-------

SIN 711.2

Insert Back Panels for Overhead Storage

SIN 711.2

Standard Includes	Required to Specify
<ul style="list-style-type: none"> Tackboard insert, if selected: vertical surface fabric price group 1 Wood or laminate back insert, if selected: wood group 1 or laminate price group 1 Attachment hardware: black paint only 	<ol style="list-style-type: none"> Style number Fabric color number for tackboard insert, if selected Wood or laminate color number for back insert, if selected Options, if selected (see below) <p>▶ See <i>Surface Materials</i>, page 566.</p>

Tip: The use of insert panels creates a 3 mm reveal around all edges of the insert.

Surface Materials	Options	Price	Required to Specify
	Tackboard insert		
	• Fabric price group 1	No cost	Specify fabric color number.
	• Fabric price group 2	+\$ 12	Specify fabric color number.
	• Fabric price group 3	+\$ 55	Specify fabric color number.
	• Fabric price group 4	+\$ 75	Specify fabric color number.
	• Fabric price group 5	+\$120	Specify fabric color number.
	• Fabric price group COM	+\$ 16	▶ See <i>Surface Materials Reference Manual</i> .
	Wood back insert		
	• Wood group 2	Prices at right	Specify wood color number.
	• Wood group 3	Prices at right	Specify wood color number.
	• Customiz stain on wood	No cost	Specify with <i>Customiz stain</i> .
	Laminate back insert		
• Laminate price group 2	See information at left	Specify laminate color number.	
• Open Line laminate	+\$ 69	▶ See <i>Surface Materials Reference Manual</i> .	

For laminate price group 2 pricing, please refer to the electronic catalog or SmartTools.



Specification Information

Dimensions	Style	Base
W	H	Number
		Price

Tackable Insert Back Panels

Single-High Cabinet Application

28¼"	13¼"	E6IT2813C	\$207
34¼"	13¼"	E6IT3413C	\$223
40¼"	13¼"	E6IT4013C	\$241
46¼"	13¼"	E6IT4613C	\$257
52¼"	13¼"	E6IT5213C	\$277
58¼"	13¼"	E6IT5813C	\$293
64¼"	13¼"	E6IT6413C	\$326
70¼"	13¼"	E6IT7013C	\$357
76¼"	13¼"	E6IT7613C	\$373
82¼"	13¼"	E6IT8213C	\$393
88¼"	13¼"	E6IT8813C	\$410
94¼"	13¼"	E6IT9413C	\$452

▶ **Specification Information, continued on next page**

► Specification Information, continued from previous page

Specification Information

• Dimensions		• Style Number	• Base Prices		• Options (Add \$ to Base Price)	
W	H		Wood Group 1	Laminate Price Group 1	Wood Group 2	Wood Group 3

Insert Back Panels

Single-High Cabinet Application

28¼"	13¼"	E6IH2813C	\$245	\$184	+\$28	+\$ 94
34¼"	13¼"	E6IH3413C	\$263	\$202	+\$28	+\$ 94
40¼"	13¼"	E6IH4013C	\$282	\$221	+\$28	+\$ 94
46¼"	13¼"	E6IH4613C	\$300	\$239	+\$28	+\$ 94
52¼"	13¼"	E6IH5213C	\$309	\$248	+\$28	+\$ 94
58¼"	13¼"	E6IH5813C	\$318	\$257	+\$47	+\$164
64¼"	13¼"	E6IH6413C	\$335	\$274	+\$47	+\$164
70¼"	13¼"	E6IH7013C	\$355	\$294	+\$47	+\$164
76¼"	13¼"	E6IH7613C	\$371	\$310	+\$47	+\$164
82¼"	13¼"	E6IH8213C	\$391	\$330	+\$47	+\$164
88¼"	13¼"	E6IH8813C	\$408	\$347	+\$47	+\$164
94¼"	13¼"	E6IH9413C	\$461	\$400	+\$47	+\$164

For Use with Organizer Shelves

28¼"	5¾"	E6IH285S	\$138	\$102	+\$28	+\$ 94
34¼"	5¾"	E6IH345S	\$147	\$111	+\$28	+\$ 94
40¼"	5¾"	E6IH405S	\$154	\$118	+\$28	+\$ 94
46¼"	5¾"	E6IH465S	\$164	\$128	+\$28	+\$ 94
52¼"	5¾"	E6IH525S	\$171	\$135	+\$28	+\$ 94
58¼"	5¾"	E6IH585S	\$178	\$142	+\$28	+\$ 94
64¼"	5¾"	E6IH645S	\$188	\$152	+\$28	+\$ 94
70¼"	5¾"	E6IH705S	\$196	\$160	+\$28	+\$ 94
76¼"	5¾"	E6IH765S	\$204	\$168	+\$28	+\$ 94
82¼"	5¾"	E6IH825S	\$211	\$175	+\$28	+\$ 94
88¼"	5¾"	E6IH885S	\$219	\$183	+\$28	+\$ 94
94¼"	5¾"	E6IH945S	\$227	\$191	+\$28	+\$ 94

Finished Back Panels for Overhead Storage and Desktop Organizers

Wood Veneer or Laminate

SIN 711.2

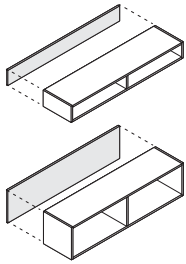

Tip: Specify finished back panels when back of components will be exposed.

Tip: Finished back panels are proud of the case.

For laminate price group 2 pricing, please refer to the electronic catalog or SmartTools.

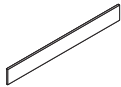

Standard Includes	Required to Specify
<ul style="list-style-type: none"> Back panel: wood group 1 veneer or laminate price group 1 Attachment hardware 	<ol style="list-style-type: none"> Style number Wood or laminate color number for back panel Options, if selected (see below) <p>▶ See <i>Surface Materials</i>, page 566.</p>

Options	Price	Required to Specify
Surface Materials Wood back panel <ul style="list-style-type: none"> Wood group 2 Wood group 3 Customiz stain 	Prices below and at right Prices below and at right No cost	Specify wood color number. Specify wood color number. Specify with <i>Customiz stain</i> .
Laminate back panel <ul style="list-style-type: none"> Laminate price group 2 Open Line laminate 	See information at left +\$69 plus cost of laminate	Specify laminate color number. ▶ See <i>Surface Materials Reference Manual</i> .

Specification Information						
• Dimensions			• Style Number	• Base Prices		• Options
D	W	H		Wood Group 1	Laminate Price Group 1	(Add \$ to Base Price)
						Wood _____ Wood Group 2 : Wood Group 3

Finished Back Panel

Finished Back Panels for Use with 7 1/2" H Shelves

Depth	Width	Height	Style Number	Wood Price	Laminate Price	Wood Option	Laminate Option
3/4"	30"	7 1/2"	E6NB307S	\$148	\$112	+\$28	+\$94
3/4"	36"	7 1/2"	E6NB367S	\$159	\$123	+\$28	+\$94
3/4"	42"	7 1/2"	E6NB427S	\$169	\$133	+\$28	+\$94
3/4"	48"	7 1/2"	E6NB487S	\$178	\$142	+\$28	+\$94
3/4"	54"	7 1/2"	E6NB547S	\$186	\$150	+\$28	+\$94
3/4"	60"	7 1/2"	E6NB607S	\$192	\$156	+\$28	+\$94
3/4"	66"	7 1/2"	E6NB667S	\$203	\$167	+\$28	+\$94
3/4"	72"	7 1/2"	E6NB727S	\$213	\$177	+\$28	+\$94
3/4"	78"	7 1/2"	E6NB787S	\$222	\$186	+\$28	+\$94
3/4"	84"	7 1/2"	E6NB847S	\$233	\$197	+\$28	+\$94
3/4"	90"	7 1/2"	E6NB907S	\$245	\$209	+\$28	+\$94
3/4"	96"	7 1/2"	E6NB967S	\$279	\$243	+\$28	+\$94

▶ Specification Information, continued on next page

► Specification Information, continued from previous page

Specification Information							
Dimensions			Style Number	Base Prices		Options (Add \$ to Base Price)	
D	W	H		Wood Group 1	Laminate Price Group 1	Wood	
						Wood Group 2	Wood Group 3

Finished Back Panel, continued

Finished Back Panels for Use with 15"H Overhead Storage

3/4"	30"	15"	E6NB3015C	\$245	\$184	+\$28	+\$ 94
3/4"	36"	15"	E6NB3615C	\$263	\$202	+\$28	+\$ 94
3/4"	42"	15"	E6NB4215C	\$289	\$228	+\$28	+\$ 94
3/4"	48"	15"	E6NB4815C	\$300	\$239	+\$28	+\$ 94
3/4"	54"	15"	E6NB5415C	\$309	\$248	+\$28	+\$ 94
3/4"	60"	15"	E6NB6015C	\$318	\$257	+\$47	+\$164
3/4"	66"	15"	E6NB6615C	\$335	\$274	+\$47	+\$164
3/4"	72"	15"	E6NB7215C	\$355	\$294	+\$47	+\$164
3/4"	78"	15"	E6NB7815C	\$371	\$310	+\$47	+\$164
3/4"	84"	15"	E6NB8415C	\$391	\$330	+\$47	+\$164
3/4"	90"	15"	E6NB9015C	\$408	\$347	+\$47	+\$164
3/4"	96"	15"	E6NB9615C	\$461	\$400	+\$47	+\$164

Finished Back Panels for Use with Open or Organizer Shelves on 6⁵/₈"H Hutch

3/4"	30"	14 ¹ / ₈ "	E6NB3014V	\$245	\$184	+\$28	+\$ 94
3/4"	36"	14 ¹ / ₈ "	E6NB3614V	\$263	\$202	+\$28	+\$ 94
3/4"	42"	14 ¹ / ₈ "	E6NB4214V	\$289	\$228	+\$28	+\$ 94
3/4"	48"	14 ¹ / ₈ "	E6NB4814V	\$300	\$239	+\$28	+\$ 94
3/4"	54"	14 ¹ / ₈ "	E6NB5414V	\$309	\$248	+\$28	+\$ 94
3/4"	60"	14 ¹ / ₈ "	E6NB6014V	\$318	\$257	+\$47	+\$164
3/4"	66"	14 ¹ / ₈ "	E6NB6614V	\$335	\$274	+\$47	+\$164
3/4"	72"	14 ¹ / ₈ "	E6NB7214V	\$355	\$294	+\$47	+\$164
3/4"	78"	14 ¹ / ₈ "	E6NB7814V	\$371	\$310	+\$47	+\$164
3/4"	84"	14 ¹ / ₈ "	E6NB8414V	\$391	\$330	+\$47	+\$164
3/4"	90"	14 ¹ / ₈ "	E6NB9014V	\$408	\$347	+\$47	+\$164
3/4"	96"	14 ¹ / ₈ "	E6NB9614V	\$461	\$400	+\$47	+\$164

► Specification Information, continued on next page

Finished Back Panels for Overhead Storage and Desktop Organizers, Wood Veneer or Laminate, continued

SIN 711.2

► Specification Information, continued from previous page

Specification Information							
Dimensions			Style Number	Base Prices		Options (Add \$ to Base Price)	
D	W	H		Wood Group 1	Laminate Price Group 1	Wood	
						Wood Group 2	Wood Group 3

Finished Back Panels for Use with 22" H Overheads

3/4"	30"	22"	E6NB3022C	\$286	\$225	+\$28	+\$ 94
3/4"	36"	22"	E6NB3622C	\$305	\$244	+\$28	+\$ 94
3/4"	42"	22"	E6NB4222C	\$330	\$269	+\$47	+\$164
3/4"	48"	22"	E6NB4822C	\$338	\$277	+\$47	+\$164
3/4"	54"	22"	E6NB5422C	\$349	\$288	+\$47	+\$164
3/4"	60"	22"	E6NB6022C	\$359	\$298	+\$47	+\$164
3/4"	66"	22"	E6NB6622C	\$377	\$316	+\$47	+\$164
3/4"	72"	22"	E6NB7222C	\$395	\$334	+\$69	+\$242
3/4"	78"	22"	E6NB7822C	\$414	\$353	+\$69	+\$242
3/4"	84"	22"	E6NB8422C	\$431	\$370	+\$69	+\$242
3/4"	90"	22"	E6NB9022C	\$449	\$388	+\$69	+\$242
3/4"	96"	22"	E6NB9622C	\$503	\$442	+\$69	+\$242

Finished Back Panels for Use with Single-High Overheads on 6⁵/₈" H Hutch and Desktop Organizers

3/4"	30"	21 ⁵ / ₈ "	E6NB3021V	\$286	\$225	+\$28	+\$ 94
3/4"	36"	21 ⁵ / ₈ "	E6NB3621V	\$305	\$244	+\$28	+\$ 94
3/4"	42"	21 ⁵ / ₈ "	E6NB4221V	\$330	\$269	+\$47	+\$164
3/4"	48"	21 ⁵ / ₈ "	E6NB4821V	\$338	\$277	+\$47	+\$164
3/4"	54"	21 ⁵ / ₈ "	E6NB5421V	\$349	\$288	+\$47	+\$164
3/4"	60"	21 ⁵ / ₈ "	E6NB6021V	\$359	\$298	+\$47	+\$164
3/4"	66"	21 ⁵ / ₈ "	E6NB6621V	\$377	\$316	+\$47	+\$164
3/4"	72"	21 ⁵ / ₈ "	E6NB7221V	\$395	\$334	+\$69	+\$242
3/4"	78"	21 ⁵ / ₈ "	E6NB7821V	\$414	\$353	+\$69	+\$242
3/4"	84"	21 ⁵ / ₈ "	E6NB8421V	\$431	\$370	+\$69	+\$242
3/4"	90"	21 ⁵ / ₈ "	E6NB9021V	\$449	\$388	+\$69	+\$242
3/4"	96"	21 ⁵ / ₈ "	E6NB9621V	\$503	\$442	+\$69	+\$242

► Specification Information, continued on next page

► Specification Information, continued from previous page

Specification Information

Dimensions			Style Number	Base Prices		Options (Add \$ to Base Price)	
D	W	H		Wood Group 1	Laminate Price Group 1	Wood Group 2	Wood Group 3

Finished Back Panels for Use with Double-High Overhead on 6⁵/₈"H Hutch, Single-High Overhead on 21⁵/₈"H Hutch, and Single-High Service Modules

3/4"	30"	36 ⁵ / ₈ "	E6NB3036V	\$368	\$307	+\$ 47	+\$164
3/4"	36"	36 ⁵ / ₈ "	E6NB3636V	\$387	\$326	+\$ 47	+\$164
3/4"	42"	36 ⁵ / ₈ "	E6NB4236V	\$413	\$352	+\$ 69	+\$242
3/4"	48"	36 ⁵ / ₈ "	E6NB4836V	\$421	\$360	+\$ 69	+\$242
3/4"	54"	36 ⁵ / ₈ "	E6NB5436V	\$431	\$370	+\$ 69	+\$242
3/4"	60"	36 ⁵ / ₈ "	E6NB6036V	\$441	\$380	+\$ 69	+\$242
3/4"	66"	36 ⁵ / ₈ "	E6NB6636V	\$459	\$398	+\$ 69	+\$242
3/4"	72"	36 ⁵ / ₈ "	E6NB7236V	\$477	\$416	+\$ 96	+\$335
3/4"	78"	36 ⁵ / ₈ "	E6NB7836V	\$496	\$435	+\$ 96	+\$335
3/4"	84"	36 ⁵ / ₈ "	E6NB8436V	\$515	\$454	+\$ 96	+\$335
3/4"	90"	36 ⁵ / ₈ "	E6NB9036V	\$531	\$470	+\$124	+\$436
3/4"	96"	36 ⁵ / ₈ "	E6NB9636V	\$584	\$523	+\$124	+\$436

Finished Back Panels for Use with 43¹/₂"H Single-High Service Modules

3/4"	60"	43 ¹ / ₂ "	E6NB6043V	\$477	\$416	+\$ 96	+\$335
3/4"	66"	43 ¹ / ₂ "	E6NB6643V	\$494	\$433	+\$ 96	+\$335
3/4"	72"	43 ¹ / ₂ "	E6NB7243V	\$511	\$450	+\$ 96	+\$335
3/4"	78"	43 ¹ / ₂ "	E6NB7843V	\$531	\$470	+\$124	+\$436
3/4"	84"	43 ¹ / ₂ "	E6NB8443V	\$548	\$487	+\$124	+\$436
3/4"	90"	43 ¹ / ₂ "	E6NB9043V	\$566	\$505	+\$124	+\$436
3/4"	96"	43 ¹ / ₂ "	E6NB9643V	\$619	\$558	+\$153	+\$531

Finished Back Panels for Use with Double-High Overheads on 18⁹/₁₆"H Hutch and Double-High Service Modules

3/4"	60"	48 ⁹ / ₁₆ "	E6NB6048V	\$513	\$452	+\$ 96	+\$335
3/4"	66"	48 ⁹ / ₁₆ "	E6NB6648V	\$530	\$469	+\$ 96	+\$335
3/4"	72"	48 ⁹ / ₁₆ "	E6NB7248V	\$545	\$484	+\$124	+\$436
3/4"	78"	48 ⁹ / ₁₆ "	E6NB7848V	\$566	\$505	+\$124	+\$436
3/4"	84"	48 ⁹ / ₁₆ "	E6NB8448V	\$584	\$523	+\$124	+\$436
3/4"	90"	48 ⁹ / ₁₆ "	E6NB9048V	\$601	\$540	+\$153	+\$531
3/4"	96"	48 ⁹ / ₁₆ "	E6NB9648V	\$653	\$592	+\$153	+\$531

Hutch Kits with Tackboard

SIN 711.2

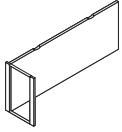

Tip: Because tackboard is one-piece design, fabric will be railroaded for consistent application.

Tip: Overhead cabinets mounted on one-sided hutch kits attach to a tower or stacking bookcase on the other side. Specify suspension hardware kit separately.

Tip: Backs of hutch kit tackboards are unfinished.

Tip: When specifying a single-high overhead cabinet supported by a hutch kit adjacent to a stacking bookcase, use a one support hutch kit and suspend the other end of the overhead from the bookcase. This will allow for precise alignment.

Tip: Tackboards are 3" shorter when used in conjunction with a blade accessory shelf.

Tip: When tackboards are used with a blade accessory shelf, the side supports are unchanged. The tackboard is reduced approximately 3" in height to accommodate the blade accessory shelf.

Standard Includes	Required to Specify
<ul style="list-style-type: none"> • Side support(s): paint • Tackboard with cable scallops, if selected: vertical surface fabric: price group 1 • Attachment hardware: black paint only • End cover, if selected: 0835 Black paint or 8043 Clear Anodized Aluminum 	<ol style="list-style-type: none"> 1 Style number 2 Fabric color number for tackboard, if selected 3 Color number for side supports and end cover, if selected 4 Options, if selected (see below) <p>▶ See <i>Surface Materials</i>, page 566.</p>

Options	Price	Required to Specify
Surface Materials <ul style="list-style-type: none"> • Tackboard • Fabric price group 1 • Fabric price group 2 • Fabric price group 3 • Fabric price group 4 • Fabric price group 5 • Fabric price group COM 	<ul style="list-style-type: none"> No cost +\$ 12 +\$ 55 +\$ 75 +\$120 +\$ 16 	<ul style="list-style-type: none"> Specify fabric color number. Specify fabric color number. Specify fabric color number. Specify fabric color number. Specify fabric color number. <p>▶ See <i>Surface Materials Reference Manual</i>.</p>

Related Products <ul style="list-style-type: none"> • Single-high overhead cabinets • Double-high overhead cabinets • Organizer, open, and accessory shelves • Worktools for slatwall 	<ul style="list-style-type: none"> ▶ Pages 484–490 ▶ Page 494 ▶ Page 504 ▶ See <i>Steelcase Worktools Specification Guide</i>.
--	--

Specification Information

Dimensions			Style Number	Base Price	Dimensions			Style Number	Base Price
D	W	H			D	W	H		

For Single-High Overhead Cabinets, Organizer Shelves, and Open Shelves

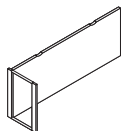

One Support Hutch Kit

15"	30"	21 ⁵ / ₈ "	E6HO153021T	\$1181
15"	36"	21 ⁵ / ₈ "	E6HO153621T	\$1241
15"	42"	21 ⁵ / ₈ "	E6HO154221T	\$1301
15"	48"	21 ⁵ / ₈ "	E6HO154821T	\$1358
15"	54"	21 ⁵ / ₈ "	E6HO155421T	\$1425
15"	60"	21 ⁵ / ₈ "	E6HO156021T	\$1491
15"	66"	21 ⁵ / ₈ "	E6HO156621T	\$1564
15"	72"	21 ⁵ / ₈ "	E6HO157221T	\$1637
15"	78"	21 ⁵ / ₈ "	E6HO157821T	\$1713
15"	84"	21 ⁵ / ₈ "	E6HO158421T	\$1785
15"	90"	21 ⁵ / ₈ "	E6HO159021T	\$1858
15"	96"	21 ⁵ / ₈ "	E6HO159621T	\$2003

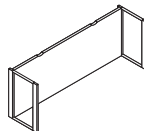

Two Support Hutch Kits

15"	30"	21 ⁵ / ₈ "	E6HT153021T	\$1545
15"	36"	21 ⁵ / ₈ "	E6HT153621T	\$1603
15"	42"	21 ⁵ / ₈ "	E6HT154221T	\$1661
15"	48"	21 ⁵ / ₈ "	E6HT154821T	\$1722
15"	54"	21 ⁵ / ₈ "	E6HT155421T	\$1787
15"	60"	21 ⁵ / ₈ "	E6HT156021T	\$1853
15"	66"	21 ⁵ / ₈ "	E6HT156621T	\$1928
15"	72"	21 ⁵ / ₈ "	E6HT157221T	\$2000
15"	78"	21 ⁵ / ₈ "	E6HT157821T	\$2072
15"	84"	21 ⁵ / ₈ "	E6HT158421T	\$2146
15"	90"	21 ⁵ / ₈ "	E6HT159021T	\$2217
15"	96"	21 ⁵ / ₈ "	E6HT159621T	\$2366

For Double-High Overhead Cabinets

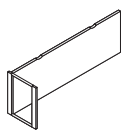

One Support Hutch Kits

15"	60"	18 ⁹ / ₁₆ "	E6HO156018T	\$1370
15"	66"	18 ⁹ / ₁₆ "	E6HO156618T	\$1443
15"	72"	18 ⁹ / ₁₆ "	E6HO157218T	\$1517
15"	78"	18 ⁹ / ₁₆ "	E6HO157818T	\$1591
15"	84"	18 ⁹ / ₁₆ "	E6HO158418T	\$1665
15"	90"	18 ⁹ / ₁₆ "	E6HO159018T	\$1736
15"	96"	18 ⁹ / ₁₆ "	E6HO159618T	\$1883

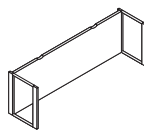

Two Support Hutch Kits

15"	60"	18 ⁹ / ₁₆ "	E6HT156018T	\$1732
15"	66"	18 ⁹ / ₁₆ "	E6HT156618T	\$1806
15"	72"	18 ⁹ / ₁₆ "	E6HT157218T	\$1879
15"	78"	18 ⁹ / ₁₆ "	E6HT157818T	\$1953
15"	84"	18 ⁹ / ₁₆ "	E6HT158418T	\$2027
15"	90"	18 ⁹ / ₁₆ "	E6HT159018T	\$2098
15"	96"	18 ⁹ / ₁₆ "	E6HT159618T	\$2246

► Specification Information, continued on next page

Hutch Kits with Tackboard, continued

SIN 711.2

► Specification Information, continued from previous page

Specification Information

Dimensions			Style Number	Base Price	Dimensions			Style Number	Base Price
D	W	H			D	W	H		

For Single-High Overhead Cabinets, Organizer Shelves, and Open Shelves

Tip: When tackboards or wood panels with or without slatwall are used with a blade accessory shelf, the side supports are unchanged. The tackboard or panel is reduced approximately 3" in height to accommodate the blade accessory shelf.

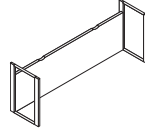
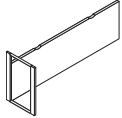

One Support Hutch Kit for Use with Blade Accessory Shelf

15"	48"	18½"	E6HO154818TB	\$1358
15"	60"	18½"	E6HO156018TB	\$1491
15"	72"	18½"	E6HO157218TB	\$1637
15"	84"	18½"	E6HO158418TB	\$1785
15"	96"	18½"	E6HO159618TB	\$2003

Two Support Hutch Kits for Use with Blade Accessory Shelf

15"	48"	18½"	E6HT154818TB	\$1722
15"	60"	18½"	E6HT156018TB	\$1853
15"	72"	18½"	E6HT157218TB	\$2000
15"	84"	18½"	E6HT158418TB	\$2146
15"	96"	18½"	E6HT159618TB	\$2366

Hutch Kits—Open

SIN 711.2

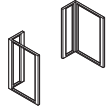

Tip: Open hutch kits support single-high cabinets, open and organizer shelves. They do not support double-high overhead cabinets.

Standard Includes	Required to Specify
-------------------	---------------------

- Two side supports, non-handed: paint
- Attachment hardware: black paint only

- 1 Style number
- 2 Color number for side supports
- ▶ See *Surface Materials*, page 566.

Related Products

- Single-high overhead cabinets
- Organizer, open, and accessory shelves

- ▶ Pages 484–490
- ▶ Page 504

Specification Information				
---------------------------	--	--	--	--

• Dimensions			• Style	• Price
D	W	H	Number	

Two Support Hutch Kits

Open				
15"	7"	7"	E6HT157P	\$ 830
15"	7"	14½"	E6HT1514P	\$ 923
15"	7"	17¼"	E6HT1517P	\$ 969
15"	7"	21⅝"	E6HT1521P	\$1039
17¼"	7"	7"	E6HT177P	\$ 908
17¼"	7"	14½"	E6HT1714P	\$1011
17¼"	7"	17¼"	E6HT1717P	\$1060
17¼"	7"	21⅝"	E6HT1721P	\$1137

Accessories

SIN 711.2

Side Support Frames

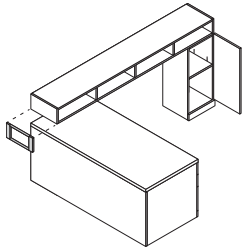

Tip: Use 6⁵/₈"H side support frame when overhead cabinet or shelf is used with a plinth base or leg base high pedestal.

Standard Includes	Required to Specify
<ul style="list-style-type: none"> • Side support frame: paint • Attachment hardware 	1 Style number 2 Color number for side supports ▶ See <i>Surface Materials</i> , page 566.

Related Products
<ul style="list-style-type: none"> • Single-high overhead cabinets ▶ Pages 484–490 • Double-high overhead cabinets ▶ Page 494 • Organizer and open shelves ▶ Page 504

Specification Information				
• Dimensions			• Style	• Price
D	W	H	Number	
15"	3/4"	6 ⁵ / ₈ "	E6AB156S	\$376
15"	3/4"	7"	E6AB157	\$387
15"	3/4"	14 ¹ / ₂ "	E6AB1514	\$433
15"	3/4"	17 ¹ / ₄ "	E6AB1517	\$455
15"	3/4"	21 ⁵ / ₈ "	E6AB1521	\$491
17 ¹ / ₄ "	3/4"	7"	E6AB177	\$425
17 ¹ / ₄ "	3/4"	14 ¹ / ₂ "	E6AB1714	\$477
17 ¹ / ₄ "	3/4"	17 ¹ / ₄ "	E6AB1717	\$503
17 ¹ / ₄ "	3/4"	21 ⁵ / ₈ "	E6AB1721	\$539

Suspension/Ganging Hardware Kit

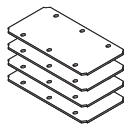

Tip: Use to suspend single-high overhead cabinets and organizer and open shelves between stacking bookcases, towers, and vertical cabinets. Use to suspend double-high overhead cabinets between towers and vertical cabinets.

Tip: If suspension hardware kits are used with cabinets without doors, hardware will be visible.

Standard Includes	Required to Specify
<ul style="list-style-type: none"> • Hardware kit: black paint only 	Style number

Related Products
<ul style="list-style-type: none"> • Single-high overhead cabinets ▶ Pages 484–490 • Double-high overhead cabinets ▶ Page 494 • Organizer, open, and accessory shelves ▶ Page 504 • Stacking bookcases ▶ Pages 318–320 and 460–462 • Plinth base and leg base towers ▶ Pages 326–334 and 468–476 • Plinth base vertical cabinets ▶ Page 338

Specification Information	
• Style	• Price
Number	
AWAH	\$31

Cabinet-to-Cabinet Attachment Kit

Standard Includes	Required to Specify
<ul style="list-style-type: none"> Attachment kit: Bronze only Four bolts per kit 	Style number

Tip: Cabinet-to-cabinet attachment kit is used to provide rigidity between cabinets mounted side by side in a panel- or wall-mounted application.

Specification Information		
• Style Number	• Quantity of Kits	• Price
AWAK	1	\$31

Stacking Paper Organizers



Standard Includes	Required to Specify
<ul style="list-style-type: none"> Stacking paper organizer: wood group 1 veneer or laminate price group 1 Metal shelves: 4799 Platinum only 	1 Style number 2 Wood veneer or laminate color number for organizer ▶ See <i>Surface Materials</i> , page 566.

Surface Materials	Options	Price	Required to Specify
	Wood organizer <ul style="list-style-type: none"> Wood group 2 Wood group 3 Customiz stain on wood 	Prices below Prices below No cost	Specify wood color number. Specify wood color number. Specify with <i>Customiz stain</i> .
	Laminate organizer <ul style="list-style-type: none"> Laminate price group 2 Open Line laminate 	See information at left +\$69	Specify laminate color number. ▶ See <i>Surface Materials Reference Manual</i> .

For laminate price group 2 pricing, please refer to the electronic catalog or SmartTools.

Specification Information						
• Dimensions			• Style	• Base Prices		• Options
D	W	H	Number	Wood Group 1	Laminate Price Group 1	(Add \$ to Base Price)
						Wood _____ Wood Group 2 : Wood Group 3

Stacking Paper Organizers

15"	15"	17¼"	E6AO151517S	\$923	\$655	+\$28	+\$94
17¼"	15"	17¼"	E6AO171517S	\$1016	\$748	+\$28	+\$94

Elective Elements

Wall-Mounted Tackboards, Tackboards with Slatwall, Wood Panels with Slatwall, and End Covers

SIN 711.2

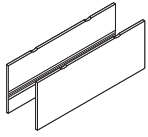

Standard Includes	Required to Specify
<ul style="list-style-type: none"> • Tackboard, if selected: vertical surface fabric price group 1 • Wood panel, if selected: wood group 1 • Slatwall on wood panel, if selected: 0835 Black paint or 8043 Clear Anodized Aluminum • Cable routing scallop(s) on top edge • Attachment hardware: black paint only • End cover, if selected: 0835 Black paint or 8043 Clear Anodized Aluminum 	<ol style="list-style-type: none"> 1 Style number 2 Fabric color number for tackboard, if selected 3 Wood color number and slatwall color number for wood panel, if selected 4 Color number for end cover, if selected 5 Options, if selected (see below) <p>▶ See <i>Surface Materials</i>, page 566.</p>

Options	Price	Required to Specify
<p>Surface Materials</p> <p>Tackboard</p> <ul style="list-style-type: none"> • Fabric price group 1 • Fabric price group 2 • Fabric price group 3 • Fabric price group 4 • Fabric price group 5 • Fabric price group COM 	<p>No cost</p> <p>+\$ 12</p> <p>+\$ 55</p> <p>+\$ 75</p> <p>+\$120</p> <p>+\$ 16</p>	<p>Specify fabric color number.</p> <p>Specify fabric color number.</p> <p>Specify fabric color number.</p> <p>Specify fabric color number.</p> <p>Specify fabric color number.</p> <p>▶ See <i>Surface Materials Reference Manual</i>.</p>
<p>Wood panel</p> <ul style="list-style-type: none"> • Wood group 2 • Wood group 3 • Customiz stain on wood 	<p>Prices at right</p> <p>Prices at right</p> <p>No cost</p>	<p>Specify wood color number.</p> <p>Specify wood color number.</p> <p>Specify with <i>Customiz stain</i>.</p>

<p>Related Products</p> <ul style="list-style-type: none"> • Single-high overhead cabinets • Double-high overhead cabinets • Organizer, open, and accessory shelves • Worktools for slatwall 	<p>▶ Pages 484–490</p> <p>▶ Page 494</p> <p>▶ Page 504</p> <p>▶ See <i>Steelcase Worktools Specification Guide</i>.</p>
---	---

Tip: One scallop centered comes standard on 30"W–48"W tackboards and wood panels. Two scallops come standard left and right on tackboards and wood panels 60"W and wider.

Tip: When wall-mounted, cords and cables can be routed behind the tackboards or wood panels. Daisy chain option is not recommended.

Tip: Check with local building code official for proper application.

Specification Information

• Dimensions		• Style Number	• Base Price	• Options (Add \$ to Base Price)	
W	H			Wood	
				Wood	Wood
				Group 2	Group 3

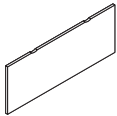

Tip: Because tackboard is one-piece design, fabric will be railroaded for consistent application.

Wall-Mounted Tackboards

For Use with Double-High Overhead

60"	18½"	E6IT6018M	\$331	N.A.	N.A.
66"	18½"	E6IT6618M	\$353	N.A.	N.A.
72"	18½"	E6IT7218M	\$373	N.A.	N.A.
78"	18½"	E6IT7818M	\$398	N.A.	N.A.
84"	18½"	E6IT8418M	\$420	N.A.	N.A.
90"	18½"	E6IT9018M	\$444	N.A.	N.A.
96"	18½"	E6IT9618M	\$472	N.A.	N.A.

For Use with Single-High Overhead

30"	21½"	E6IT3021M	\$234	N.A.	N.A.
36"	21½"	E6IT3621M	\$257	N.A.	N.A.
42"	21½"	E6IT4221M	\$284	N.A.	N.A.
48"	21½"	E6IT4821M	\$309	N.A.	N.A.
54"	21½"	E6IT5421M	\$320	N.A.	N.A.
60"	21½"	E6IT6021M	\$331	N.A.	N.A.
66"	21½"	E6IT6621M	\$353	N.A.	N.A.
72"	21½"	E6IT7221M	\$373	N.A.	N.A.
78"	21½"	E6IT7821M	\$398	N.A.	N.A.
84"	21½"	E6IT8421M	\$420	N.A.	N.A.
90"	21½"	E6IT9021M	\$444	N.A.	N.A.
96"	21½"	E6IT9621M	\$472	N.A.	N.A.

► **Specification Information, continued on next page**

Wall-Mounted Tackboards, Tackboards with Slatwall, Wood Panels with Slatwall, and End Covers, continued

SIN 711.2

► Specification Information, continued from previous page

Specification Information

• Dimensions		• Style Number	• Base Price	• Options (Add \$ to Base Price)	
W	H			Wood	Wood
:	:	:	:	Wood	Wood
:	:	:	:	Group 2	Group 3

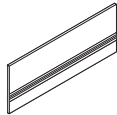

Wall-Mounted Tackboards with Slatwall

For Use with Double-High Overhead

60"	18½"	E6IT6018W	\$ 802	N.A.	N.A.
66"	18½"	E6IT6618W	\$ 841	N.A.	N.A.
72"	18½"	E6IT7218W	\$ 874	N.A.	N.A.
78"	18½"	E6IT7818W	\$ 910	N.A.	N.A.
84"	18½"	E6IT8418W	\$ 946	N.A.	N.A.
90"	18½"	E6IT9018W	\$ 984	N.A.	N.A.
96"	18½"	E6IT9618W	\$1019	N.A.	N.A.

For Use with Single-High Overhead

30"	21½"	E6IT3021W	\$ 705	N.A.	N.A.
36"	21½"	E6IT3621W	\$ 731	N.A.	N.A.
42"	21½"	E6IT4221W	\$ 754	N.A.	N.A.
48"	21½"	E6IT4821W	\$ 777	N.A.	N.A.
54"	21½"	E6IT5421W	\$ 791	N.A.	N.A.
60"	21½"	E6IT6021W	\$ 802	N.A.	N.A.
66"	21½"	E6IT6621W	\$ 841	N.A.	N.A.
72"	21½"	E6IT7221W	\$ 874	N.A.	N.A.
78"	21½"	E6IT7821W	\$ 910	N.A.	N.A.
84"	21½"	E6IT8421W	\$ 946	N.A.	N.A.
90"	21½"	E6IT9021W	\$ 984	N.A.	N.A.
96"	21½"	E6IT9621W	\$1019	N.A.	N.A.

► Specification Information, continued on next page

► Specification Information, continued from previous page

Specification Information

Dimensions		Style Number	Base Price	Options	
W	H			(Add \$ to Base Price)	
				Wood	
				Wood	Wood
				Group 2	Group 3

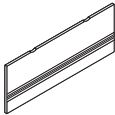

Wall-Mounted Wood Panels with Slatwall

For Use with Double-High Overhead

60"	18½"	E6IS6018M	\$ 802	+\$28	+\$ 94
66"	18½"	E6IS6618M	\$ 841	+\$28	+\$ 94
72"	18½"	E6IS7218M	\$ 874	+\$28	+\$ 94
78"	18½"	E6IS7818M	\$ 910	+\$28	+\$ 94
84"	18½"	E6IS8418M	\$ 946	+\$47	+\$164
90"	18½"	E6IS9018M	\$ 984	+\$47	+\$164
96"	18½"	E6IS9618M	\$1019	+\$47	+\$164

For Use with Single-High Overhead

30"	21½"	E6IS3021M	\$ 705	+\$28	+\$ 94
36"	21½"	E6IS3621M	\$ 731	+\$28	+\$ 94
42"	21½"	E6IS4221M	\$ 754	+\$28	+\$ 94
48"	21½"	E6IS4821M	\$ 777	+\$28	+\$ 94
54"	21½"	E6IS5421M	\$ 791	+\$28	+\$ 94
60"	21½"	E6IS6021M	\$ 802	+\$28	+\$ 94
66"	21½"	E6IS6621M	\$ 841	+\$28	+\$ 94
72"	21½"	E6IS7221M	\$ 874	+\$28	+\$ 94
78"	21½"	E6IS7821M	\$ 910	+\$28	+\$ 94
84"	21½"	E6IS8421M	\$ 946	+\$47	+\$164
90"	21½"	E6IS9021M	\$ 984	+\$47	+\$164
96"	21½"	E6IS9621M	\$1019	+\$47	+\$164

End Covers for Wall-Mounted Wood Panels with Slatwall

15¾"	E6AE15B	\$ 115	N.A.	N.A.
18½"	E6AE18	\$ 139	N.A.	N.A.
21½"	E6AE21	\$ 164	N.A.	N.A.



Tip: Specify end covers for wood panels with slatwall when ends will be visible. End covers are available in black and anodized aluminum.

► Specification Information, continued on next page

Wall-Mounted Tackboards, Tackboards with Slatwall, Wood Panels with Slatwall, and End Covers, continued

SIN 711.2

► Specification Information, continued from previous page

Specification Information					
Dimensions		Style Number	Base Price	Options	
W	H			(Add \$ to Base Price)	
				Wood	
				Wood	Wood
				Group 2	Group 3

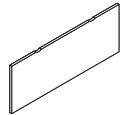

Tip: Because tackboard is one-piece design, fabric will be railroaded for consistent application.

Tackboards

Wall-Mounted Tackboards for Use with Blade Accessory Shelf

For Use with Double-High Overhead and Blade Accessory Shelf

Dimensions	Style Number	Base Price	Options	Options
60" 15 3/8"	E6IT6015B	\$ 331	N.A.	N.A.
72" 15 3/8"	E6IT7215B	\$ 373	N.A.	N.A.
84" 15 3/8"	E6IT8415B	\$ 420	N.A.	N.A.
96" 15 3/8"	E6IT9615B	\$ 472	N.A.	N.A.

For Use with Single-High Overhead and Blade Accessory Shelf

Dimensions	Style Number	Base Price	Options	Options
48" 18 1/2"	E6IT4818B	\$ 309	N.A.	N.A.
60" 18 1/2"	E6IT6018M	\$ 331	N.A.	N.A.
66" 18 1/2"	E6IT6618M	\$ 353	N.A.	N.A.
72" 18 1/2"	E6IT7218M	\$ 373	N.A.	N.A.
78" 18 1/2"	E6IT7818M	\$ 398	N.A.	N.A.
84" 18 1/2"	E6IT8418M	\$ 420	N.A.	N.A.
90" 18 1/2"	E6IT9018M	\$ 444	N.A.	N.A.
96" 18 1/2"	E6IT9618M	\$ 472	N.A.	N.A.

Tackboards with Slatwall

Wall-Mounted Tackboards with Slatwall for Use with Blade Accessory Shelf

For Use with Single-High Overhead and Blade Accessory Shelf

Dimensions	Style Number	Base Price	Options	Options
48" 18 1/2"	E6IT4818WB	\$ 777	N.A.	N.A.
60" 18 1/2"	E6IT6018W	\$ 802	N.A.	N.A.
72" 18 1/2"	E6IT7218W	\$ 874	N.A.	N.A.
84" 18 1/2"	E6IT8418W	\$ 946	N.A.	N.A.
96" 18 1/2"	E6IT9618W	\$1019	N.A.	N.A.

► Specification Information, continued on next page

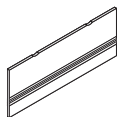

Tip: Due to dimensional capability, style numbers ending in different suffixes within this section are also for use with blade accessory shelf.



Tip: Specify end covers for tackboards with slatwall when ends will be visible. End covers are available in black and anodized aluminum.

Wall-Mounted Tackboards,
Tackboards with Slatwall,
Wood Panels with Slatwall,
and End Covers

SIN 711.2

► **Specification Information, continued from previous page**

Specification Information

• Dimensions		• Style Number	• Base Price	• Options (Add \$ to Base Price)	
W	H			• Wood	
				Wood	Wood
				Group 2	Group 3

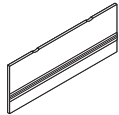

Wood Panels with Slatwall

Wall-Mounted Wood Panels with Slatwall for Use with Blade Accessory Shelf

For Use with Double-High Overhead and Blade Accessory Shelf

60"	15 ³ / ₈ "	E6IS6015B	\$ 802	+\$28	+\$ 94
72"	15 ³ / ₈ "	E6IS7215B	\$ 874	+\$28	+\$ 94
84"	15 ³ / ₈ "	E6IS8415B	\$ 946	+\$47	+\$164
96"	15 ³ / ₈ "	E6IS9615B	\$1019	+\$47	+\$164

For Use with Single-High Overhead and Blade Accessory Shelf

48"	18 ¹ / ₂ "	E6IS4818B	\$ 777	+\$28	+\$ 94
60"	18 ¹ / ₂ "	E6IS6018M	\$ 802	+\$28	+\$ 94
72"	18 ¹ / ₂ "	E6IS7218M	\$ 874	+\$28	+\$ 94
84"	18 ¹ / ₂ "	E6IS7218M	\$ 874	+\$28	+\$ 94
96"	18 ¹ / ₂ "	E6IS9618M	\$1019	+\$47	+\$164

Light Valances for Overheads

Wood Veneer or Laminate

SIN 711.2

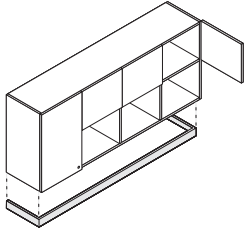

For laminate price group 2 pricing, please refer to the electronic catalog or SmartTools.

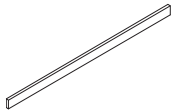

Standard Includes	Required to Specify
<ul style="list-style-type: none"> Light valance: wood group 1 veneer or laminate price group 1 Attachment hardware 	<ol style="list-style-type: none"> Style number Wood or laminate color number for light valance Options, if selected (see below) <p>▶ See <i>Surface Materials</i>, page 566.</p>

Options	Price	Required to Specify
Surface Materials Wood light valance <ul style="list-style-type: none"> Wood group 2 Wood group 3 Customiz stain 	<ul style="list-style-type: none"> +\$28 +\$94 No cost 	<ul style="list-style-type: none"> Specify wood color number. Specify wood color number. Specify <i>with Customiz stain</i>.
Laminate light valance <ul style="list-style-type: none"> Laminate price group 2 Open Line laminate 	<ul style="list-style-type: none"> See information at left +\$69 	<ul style="list-style-type: none"> Specify laminate color number. ▶ See <i>Surface Materials Reference Manual</i>.

Specification Information					
Dimensions			Style Number	Base Prices	
D	W	H		Wood Group 1	Laminate Price Group 1

Light Valances

For Use with Overhead Hutch Application

3/4"	28 ⁵ / ₁₆ "	2"	E6AL28V	\$207	\$170
3/4"	34 ⁵ / ₁₆ "	2"	E6AL34V	\$217	\$180
3/4"	40 ⁵ / ₁₆ "	2"	E6AL40V	\$227	\$190
3/4"	46 ⁵ / ₁₆ "	2"	E6AL46V	\$236	\$199
3/4"	52 ⁵ / ₁₆ "	2"	E6AL52V	\$244	\$207
3/4"	58 ⁵ / ₁₆ "	2"	E6AL58V	\$249	\$212
3/4"	64 ⁵ / ₁₆ "	2"	E6AL64V	\$260	\$223
3/4"	70 ⁵ / ₁₆ "	2"	E6AL70V	\$271	\$234
3/4"	76 ⁵ / ₁₆ "	2"	E6AL76V	\$282	\$245
3/4"	82 ⁵ / ₁₆ "	2"	E6AL82V	\$293	\$256
3/4"	88 ⁵ / ₁₆ "	2"	E6AL88V	\$304	\$267
3/4"	94 ⁵ / ₁₆ "	2"	E6AL94V	\$335	\$298

▶ **Specification Information, continued on next page**

► Specification Information, continued from previous page

Specification Information

• Dimensions			• Style Number	• Base Prices	
D	W	H		Wood Group 1	Laminate Price Group 1

Light Valances, continued

For Use with Wall-Mounted Overhead Application

12 ³ / ₅ "	28 ³ / ₄ "	2"	E6AL30W	\$249	\$212
12 ³ / ₅ "	34 ³ / ₄ "	2"	E6AL36W	\$260	\$223
12 ³ / ₅ "	40 ³ / ₄ "	2"	E6AL42W	\$271	\$234
12 ³ / ₅ "	46 ³ / ₄ "	2"	E6AL48W	\$281	\$244
12 ³ / ₅ "	52 ³ / ₄ "	2"	E6AL54W	\$286	\$249
12 ³ / ₅ "	58 ³ / ₄ "	2"	E6AL60W	\$292	\$255
12 ³ / ₅ "	64 ³ / ₄ "	2"	E6AL66W	\$303	\$266
12 ³ / ₅ "	70 ³ / ₄ "	2"	E6AL72W	\$313	\$276
12 ³ / ₅ "	76 ³ / ₄ "	2"	E6AL78W	\$323	\$286
12 ³ / ₅ "	82 ³ / ₄ "	2"	E6AL84W	\$333	\$296
12 ³ / ₅ "	88 ³ / ₄ "	2"	E6AL90W	\$344	\$307
12 ³ / ₅ "	94 ³ / ₄ "	2"	E6AL96W	\$384	\$347

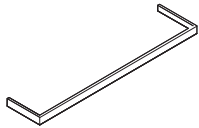

Tip: Valances for use with wall-mounted overhead cabinets do not match the width of the cabinet. They are inset from the ends approximately 5/8".

Magnetic Back Painted Glass

SIN 711.2

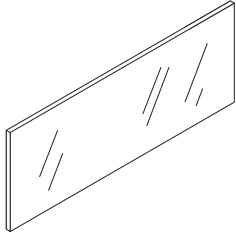

Tip: Modular selections account for the height needed to install, and offer a way to run low-voltage wires along the top.

Tip: Application only applies when modular size option is selected.

Tip: Only rare earth magnets may be used with magnetic back painted glass. Such items can be purchased at most office supply outlets online or in-store.

Tip: Spacers for cord management can also be used to align depth of magnetic back painted glass with depth of fabric tackboard. Spacers are always included with the mounting hardware.

Tip: Mirrored bronze is not offered in magnetic back painted glass, due to the extreme difficulty in completely erasing any writing.

Tip: Specifying with cord management makes the glass panel 3/8" shorter to allow room for cords. Cord management may only be selected when an overhead application is specified and may be chosen with all overhead options.

Standard Includes	Required to Specify
<ul style="list-style-type: none"> • Frame: paint price groups 1 and 2 • Glass: back painted glass • Attachment hardware: black paint 	<ol style="list-style-type: none"> 1 Style number 2 Paint color number for frame 3 Back painted glass color number for glass 4 Size option (see below under Required Selections) 5 Application, if modular size selected (see below under Required Selections) 6 Service module, if service module application selected (see below under Required Selections) 7 Overhead, if overhead application selected (see below under Required Selections) 8 Options, if selected (see below) <p>▶ See <i>Surface Materials</i>, page 566.</p>

Size Option	Required Selections	Price	Required to Specify
	<ul style="list-style-type: none"> • Modular • Parametric 	<p>Prices at right</p> <p>Prices at right</p>	<p>Specify with modular.</p> <p>Specify with parametric.</p>
	<p>Application</p> <p>For modular sizes</p> <ul style="list-style-type: none"> • Service module • Overhead 	<p>Prices at right</p> <p>Prices at right</p>	<p>Specify with service module application.</p> <p>Specify with overhead application.</p>
	<p>Service Module</p> <p>For modular sizes with service module application</p> <ul style="list-style-type: none"> • Organizer • Organizer with blade accessory shelf • Single-high 32 1/4"H service module • Single-high 32 1/4"H service module with blade accessory shelf • Single-high 36 5/8"H or 43 1/2"H service module • Single-high 36 5/8"H or 43 1/2"H service module with blade accessory shelf • Double-high service module • Double-high service module with blade accessory shelf 	<p>Prices at right</p> <p>Prices at right</p> <p>Prices at right</p> <p>Prices at right</p> <p>Prices at right</p> <p>Prices at right</p> <p>Prices at right</p> <p>Prices at right</p>	<p>Specify with organizer.</p> <p>Specify with organizer with blade accessory shelf.</p> <p>Specify with single-high 32 1/4"H service module.</p> <p>Specify with single-high 32 1/4"H service module with blade accessory shelf.</p> <p>Specify with single-high 36 5/8"H or 43 1/2"H service module.</p> <p>Specify with single-high 36 5/8"H or 43 1/2"H service module with blade accessory shelf.</p> <p>Specify with double-high service module.</p> <p>Specify with double-high service module with blade accessory shelf.</p>
	<p>Overhead</p> <p>For modular sizes with overhead application</p> <ul style="list-style-type: none"> • Single-high overhead • Single-high overhead with blade accessory shelf • Double-high overhead • Double-high overhead with blade accessory shelf 	<p>Prices at right</p> <p>Prices at right</p> <p>Prices at right</p> <p>Prices at right</p>	<p>Specify with single-high overhead.</p> <p>Specify with single-high overhead with blade accessory shelf.</p> <p>Specify with double-high overhead.</p> <p>Specify with double-high overhead with blade accessory shelf.</p>

Surface Materials	Options	Price	Required to Specify
	<p>Frame</p> <ul style="list-style-type: none"> • Paint price groups 1 and 2 <p>Glass</p> <ul style="list-style-type: none"> • Back painted glass 	<p>No cost</p> <p>No cost</p>	<p>Specify paint color number.</p> <p>Specify back painted glass color number.</p>
	<p>Cord Management</p> <p>For modular sizes with overhead application</p> <ul style="list-style-type: none"> • No cord management • With cord management 	<p>No cost</p> <p>No cost</p>	<p>Specify with no cord management.</p> <p>Specify with cord management.</p>

Related Products

- Single-high service modules ▶ Page 536
- Double-high service modules ▶ Page 546
- Blade accessory shelves ▶ Page 508
- Desktop organizers ▶ Page 510
- Single-high overheads ▶ Page 484
- Double-high overheads ▶ Page 494
- Worksurface accessories ▶ Page 504

Specification Information

Style Number	Dimensions H	Base Prices											
		30"W	36"W	42"W	48"W	54"W	60"W	66"W	72"W	78"W	84"W	90"W	96"W

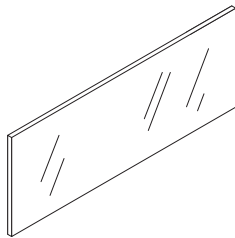

Tip: Nominal widths are shown.

Modular Sizes

For Use with Single-High Overhead

E6GBP	21½"	\$1345	\$1578	\$1811	\$2043	\$2276	\$2509	\$2741	\$2974	\$3207	\$3439	\$3672	\$3905
--------------	------	--------	--------	--------	--------	--------	--------	--------	--------	--------	--------	--------	--------

For Use with Single-High Overhead with Blade Accessory Shelf

E6GBP	18¾"	N.A.	N.A.	N.A.	\$1796	N.A.	\$2203	N.A.	\$2610	N.A.	\$3017	N.A.	\$3424
--------------	------	------	------	------	--------	------	--------	------	--------	------	--------	------	--------

For Use with Single-High Service Module with Organizer

E6GBP	13 ¹⁵ / ₁₆ "	N.A.	N.A.	N.A.	N.A.	N.A.	\$1598	\$1743	\$1889	\$2035	\$2181	\$2327	\$2472
--------------	------------------------------------	------	------	------	------	------	--------	--------	--------	--------	--------	--------	--------

For Use with Single-High Service Module with Organizer and Blade Accessory Shelf

E6GBP	10 ⁷ / ₈ "	N.A.	N.A.	N.A.	N.A.	N.A.	\$1598	N.A.	\$1889	N.A.	\$2181	N.A.	\$2472
--------------	----------------------------------	------	------	------	------	------	--------	------	--------	------	--------	------	--------

For Use with Single-High 32¼"H Service Module and Blade Accessory Shelf

E6GBP	13 ⁵ / ₈ "	N.A.	N.A.	N.A.	N.A.	N.A.	\$1598	N.A.	\$1889	N.A.	\$2181	N.A.	\$2472
--------------	----------------------------------	------	------	------	------	------	--------	------	--------	------	--------	------	--------

For Use with Single-High 32¼"H Service Module

E6GBP	16¾"	N.A.	N.A.	N.A.	N.A.	N.A.	\$1897	\$2071	\$2246	\$2420	\$2594	\$2769	\$2943
--------------	------	------	------	------	------	------	--------	--------	--------	--------	--------	--------	--------

For Use with Single-High 36⁵/₈"H and 43½"H Service Module

E6GBP	21 ¹ / ₁₆ "	N.A.	N.A.	N.A.	N.A.	N.A.	\$2509	\$2741	\$2974	\$3207	\$3439	\$3672	\$3905
--------------	-----------------------------------	------	------	------	------	------	--------	--------	--------	--------	--------	--------	--------

For Use with Single-High 36⁵/₈"H and 43½"H Service Module and Blade Accessory Shelf

E6GBP	18"	N.A.	N.A.	N.A.	N.A.	N.A.	\$2203	\$2406	\$2610	\$2813	\$3017	\$3220	\$3424
--------------	-----	------	------	------	------	------	--------	--------	--------	--------	--------	--------	--------

For Use with Double-High Service Module and Blade Accessory Shelf

E6GBP	14 ⁷ / ₈ "	N.A.	N.A.	N.A.	N.A.	N.A.	\$1598	N.A.	\$1889	N.A.	\$2181	N.A.	\$2472
--------------	----------------------------------	------	------	------	------	------	--------	------	--------	------	--------	------	--------

For Use with Double-High Overhead with Blade Accessory Shelf

E6GBP	15 ³ / ₁₆ "	N.A.	N.A.	N.A.	N.A.	N.A.	\$1897	N.A.	\$2246	N.A.	\$2594	N.A.	\$2943
--------------	-----------------------------------	------	------	------	------	------	--------	------	--------	------	--------	------	--------

For Use with Double-High Service Module

E6GBP	18"	N.A.	N.A.	N.A.	N.A.	N.A.	\$2203	\$2406	\$2610	\$2813	\$3017	\$3220	\$3424
--------------	-----	------	------	------	------	------	--------	--------	--------	--------	--------	--------	--------

For Use with Double-High Overhead

E6GBP	18 ³ / ₈ "	N.A.	N.A.	N.A.	N.A.	N.A.	\$2203	\$2406	\$2610	\$2813	\$3017	\$3220	\$3424
--------------	----------------------------------	------	------	------	------	------	--------	--------	--------	--------	--------	--------	--------

▶ Specification Information, continued on next page

Magnetic Back Painted Glass, continued

SIN 711.2

► Specification Information, continued from previous page

Specification Information

Style Number	Dimensions H	Prices										
		<30"W	30"W-	33"W-	36"W-	39"W-	42"W-	45"W-	48"W-	51"W-	54"W-	57"W-
		32 ¹⁵ / ₁₆ "W	35 ¹⁵ / ₁₆ "W	38 ¹⁵ / ₁₆ "W	41 ¹⁵ / ₁₆ "W	44 ¹⁵ / ₁₆ "W	47 ¹⁵ / ₁₆ "W	50 ¹⁵ / ₁₆ "W	53 ¹⁵ / ₁₆ "W	56 ¹⁵ / ₁₆ "W	59 ¹⁵ / ₁₆ "W	

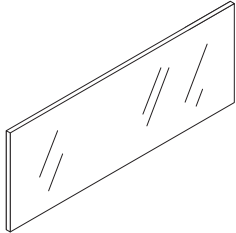

Parametric Sizes

E6GBP	Dimensions	<30"W	30"W-	33"W-	36"W-	39"W-	42"W-	45"W-	48"W-	51"W-	54"W-	57"W-
	<15"H	\$ 797	\$ 869	\$ 941	\$1014	\$1087	\$1160	\$1233	\$1306	\$1379	\$1452	\$1525
	15"H-17 ¹⁵ / ₁₆ "H	\$ 940	\$1025	\$1112	\$1200	\$1287	\$1374	\$1461	\$1548	\$1636	\$1723	\$1810
	18"H-20 ¹⁵ / ₁₆ "H	\$1086	\$1185	\$1287	\$1389	\$1491	\$1592	\$1694	\$1796	\$1898	\$1999	\$2101
	21"H-23 ¹⁵ / ₁₆ "H	\$1232	\$1345	\$1462	\$1578	\$1694	\$1811	\$1927	\$2043	\$2160	\$2276	\$2392
	24"H-26 ¹⁵ / ₁₆ "H	\$1377	\$1506	\$1636	\$1767	\$1898	\$2029	\$2160	\$2291	\$2422	\$2553	\$2684
	27"H-29 ¹⁵ / ₁₆ "H	\$1523	\$1666	\$1811	\$1957	\$2102	\$2248	\$2393	\$2539	\$2684	\$2830	\$2975
	30"H-32 ¹⁵ / ₁₆ "H	\$1669	\$1826	\$1986	\$2146	\$2306	\$2466	\$2626	\$2786	\$2946	\$3106	\$3266
	33"H-35 ¹⁵ / ₁₆ "H	\$1815	\$1986	\$2160	\$2335	\$2510	\$2684	\$2859	\$3034	\$3208	\$3383	\$3558
	36"H-38 ¹⁵ / ₁₆ "H	\$1961	\$2146	\$2335	\$2524	\$2714	\$2903	\$3092	\$3281	\$3470	\$3660	\$3849
	39"H-41 ¹⁵ / ₁₆ "H	\$2106	\$2306	\$2510	\$2714	\$2917	\$3121	\$3325	\$3529	\$3733	\$3936	\$4140
	42"H-44 ¹⁵ / ₁₆ "H	\$2252	\$2466	\$2684	\$2903	\$3121	\$3340	\$3558	\$3776	\$3995	\$4213	\$4432
	45"H-48"H	\$2401	\$2629	\$2863	\$3096	\$3329	\$3563	\$3796	\$4029	\$4262	\$4496	\$4729

Tip: The minimum parametric size is 14"W X 6"H. The maximum parametric size is 102"W X 48"H.

Tip: If using parametric sizing with an overhead, subtract 3/8" from the height for cord management.

► Specification Information, continued on next page

► Specification Information, continued from previous page

60"W- 63"W- 66"W- 69"W- 72"W- 75"W- 78"W- 81"W- 84"W- 87"W- 90"W- 93"W- 96"W- 99"W-
62¹⁵/₁₆"W- 65¹⁵/₁₆"W- 68¹⁵/₁₆"W- 71¹⁵/₁₆"W- 74¹⁵/₁₆"W- 77¹⁵/₁₆"W- 80¹⁵/₁₆"W- 83¹⁵/₁₆"W- 86¹⁵/₁₆"W- 89¹⁵/₁₆"W- 92¹⁵/₁₆"W- 95¹⁵/₁₆"W- 98¹⁵/₁₆"W- 102"W

\$1598	\$1670	\$1743	\$1816	\$1889	\$1962	\$2035	\$2108	\$2181	\$2254	\$2327	\$2399	\$2472	\$2547
\$1897	\$1984	\$2071	\$2159	\$2246	\$2333	\$2420	\$2507	\$2594	\$2682	\$2769	\$2856	\$2943	\$3032
\$2203	\$2305	\$2406	\$2508	\$2610	\$2712	\$2813	\$2915	\$3017	\$3119	\$3220	\$3322	\$3424	\$3528
\$2509	\$2625	\$2741	\$2858	\$2974	\$3090	\$3207	\$3323	\$3439	\$3556	\$3672	\$3788	\$3905	\$4024
\$2815	\$2946	\$3077	\$3207	\$3338	\$3469	\$3600	\$3731	\$3862	\$3993	\$4124	\$4255	\$4386	\$4519
\$3121	\$3266	\$3412	\$3557	\$3703	\$3848	\$3994	\$4139	\$4285	\$4430	\$4576	\$4721	\$4867	\$5015
\$3426	\$3587	\$3747	\$3907	\$4067	\$4227	\$4387	\$4547	\$4707	\$4867	\$5027	\$5187	\$5347	\$5511
\$3732	\$3907	\$4082	\$4256	\$4431	\$4606	\$4780	\$4955	\$5130	\$5304	\$5479	\$5654	\$5828	\$6006
\$4038	\$4227	\$4417	\$4606	\$4795	\$4984	\$5174	\$5363	\$5552	\$5741	\$5931	\$6120	\$6309	\$6502
\$4344	\$4548	\$4752	\$4956	\$5159	\$5363	\$5567	\$5771	\$5975	\$6178	\$6382	\$6586	\$6790	\$6998
\$4650	\$4868	\$5087	\$5305	\$5524	\$5742	\$5960	\$6179	\$6397	\$6615	\$6834	\$7052	\$7271	\$7494
\$4962	\$5195	\$5429	\$5662	\$5895	\$6129	\$6362	\$6595	\$6828	\$7062	\$7295	\$7528	\$7762	\$8000

32¼" Single-High Service Modules

Wood Veneer or Laminate

SIN 711.2

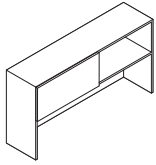

Tip: 32¼"H single-high service modules align with 55"H Montage panels and freestanding storage when mounted on plinth base 1.5 high or leg base 21½"H storage.

For laminate price group 2 pricing, please refer to the electronic catalog or SmartTools.

Tip: Glass doors do not lock.

Standard Includes		Required to Specify	
<ul style="list-style-type: none"> Service module: <ul style="list-style-type: none"> –Wood group 1 case with wood group 1 front –Laminate price group 1 case with same or contrasting laminate front –Laminate price group 1 case with wood front Unfinished price group 1 back Attachment hardware: black paint only 		<ol style="list-style-type: none"> Style number Wood or laminate color number for service module Laminate color number for laminate fronts on laminate case, if selected Wood color number for wood fronts on laminate cases, if selected Options, if selected (see below) <p>▶ See <i>Surface Materials</i>, page 566.</p>	
Options	Price	Required to Specify	
Surface Materials	Wood service module case		
<ul style="list-style-type: none"> Wood group 2 Wood group 3 Customiz stain 	<ul style="list-style-type: none"> Prices at right Prices at right No cost 	<ul style="list-style-type: none"> Specify wood color number. Specify wood color number. Specify with <i>Customiz stain</i>. 	
	Laminate service module case		
<ul style="list-style-type: none"> Laminate price group 2 Open Line laminate Wood group 2 on wood fronts Wood group 3 on wood fronts Customiz stain 	<ul style="list-style-type: none"> See information at left +\$ 69 plus cost of laminate Prices at right Prices at right No cost 	<ul style="list-style-type: none"> Specify laminate color number. ▶ See <i>Surface Materials Reference Manual</i>. Specify wood color number. Specify wood color number. Specify with <i>Customiz stain</i>. 	
Finished Inset Back	Finished inset back		
<ul style="list-style-type: none"> Laminate Wood 	<ul style="list-style-type: none"> +\$173 +\$346 	<ul style="list-style-type: none"> Specify with <i>laminate finished inset back</i> and select laminate finish number. Specify with <i>wood finished inset back</i> and select laminate finish number. 	
Painted Glass Door(s) for Service Modules	Non-locking sliding glass door		
	<ul style="list-style-type: none"> On 60"W On 66"W, 72"W, 78"W, and 84"W On 90"W and 96"W 	<ul style="list-style-type: none"> +\$314 +\$350 +\$387 	<ul style="list-style-type: none"> Specify with <i>glass doors</i> and select finish. Specify with <i>glass doors</i> and select finish. Specify with <i>glass doors</i> and select finish.
	Frame		
	<ul style="list-style-type: none"> Painted metal frame for glass doors 	No cost	Specify with <i>frame</i> and select paint color number.
Mirrored Glass Door(s) for Service Modules	Non-locking sliding glass doors		
	<ul style="list-style-type: none"> On 60"W On 66"W, 72"W, 78"W, and 84"W On 90"W and 96"W 	<ul style="list-style-type: none"> +\$440 +\$488 +\$543 	<ul style="list-style-type: none"> Specify with <i>mirrored glass door</i> and select finish. Specify with <i>mirrored glass door</i> and select finish. Specify with <i>mirrored glass door</i> and select finish.
	Frame		
	<ul style="list-style-type: none"> Painted metal frame for glass doors 	No cost	Specify with <i>frame</i> and select paint color number.
Related Products	<ul style="list-style-type: none"> Tackboards for use with service modules 		▶ Page 550

Specification Information

Dimensions		Style Number	Base Prices			Options (Add \$ to Base Price)			
D	W		Wood Group 1 Case	Laminate Price Group 1 Case	Wood Group 1 Front	Wood Case with Wood Front	Laminate Case with Wood Front	Wood Group 2	Wood Group 3

Single-High Service Modules-32 1/4" High

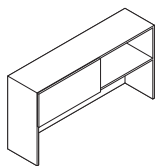

Sliding Door

15"	60"	E6MS156032S	\$3073	\$2438	\$2770	+\$252	+\$ 882	+\$28	+\$94
15"	66"	E6MS156632S	\$3328	\$2693	\$3025	+\$252	+\$ 882	+\$28	+\$94
15"	72"	E6MS157232S	\$3582	\$2947	\$3279	+\$252	+\$ 882	+\$28	+\$94
15"	78"	E6MS157832S	\$3749	\$3114	\$3446	+\$252	+\$ 882	+\$28	+\$94
15"	84"	E6MS158432S	\$3920	\$3285	\$3617	+\$252	+\$ 882	+\$28	+\$94
15"	90"	E6MS159032S	\$4088	\$3453	\$3785	+\$386	+\$1342	+\$28	+\$94
15"	96"	E6MS159632S	\$4291	\$3656	\$3988	+\$386	+\$1342	+\$28	+\$94

► Specification Information, continued on next page

Elective Elements

32 1/4" Single-High Service Modules, Wood Veneer or Laminate, continued

SIN 711.2

► **Specification Information, continued from previous page**

Specification Information

• Dimensions		• Style Number	• Base Prices		• Options (Add \$ to Base Price)	
D	W		Wood Group 1 Case	Laminate Price Group 1 Case	Wood	
			Open Front	Open Front	Wood Case with Open Front	Wood : Wood Group 2 : Group 3

Single-High Service Modules-32 1/4" High, continued

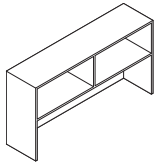

Open

15"	60"	E6MS156032P	\$2684	\$2202	+\$224	+\$ 788
15"	66"	E6MS156632P	\$2855	\$2373	+\$224	+\$ 788
15"	72"	E6MS157232P	\$3025	\$2543	+\$224	+\$ 788
15"	78"	E6MS157832P	\$3152	\$2670	+\$224	+\$ 788
15"	84"	E6MS158432P	\$3277	\$2795	+\$224	+\$ 788
15"	90"	E6MS159032P	\$3401	\$2919	+\$358	+\$1248
15"	96"	E6MS159632P	\$3815	\$3333	+\$358	+\$1248
:	:	:	:	:	:	:

32 1/4" Single-High
Service Modules

SIN 711.2

36⁵/₈" Single-High Service Modules

Wood Veneer or Laminate

SIN 711.2

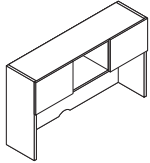

Tip: Single-high service modules align with the top of 65⁵/₈"H towers and bookcases.

For laminate price group 2 pricing, please refer to the electronic catalog or SmartTools.

Tip: Glass doors feature self-close hinges and are not available with soft-close hinges. Glass doors are not available with locks.

Tip: ADA opening/closing option features a magnetic touch latch and neutral hinge.

Tip: If using a modesty panel on a worksurface below a service module, order a cable pass-through in the modesty panel to facilitate cable routing.

Tip: Specify an optional tackboard or wood panel with slatwall to cover unfinished cable pass-through if desired.

Tip: Side panels for 32¹/₄"H single-high service modules are 3/4" thick. Side panels for 36⁵/₈"H single-high service modules are 1¹/₈" thick.

Standard Includes	Required to Specify
<ul style="list-style-type: none"> Service module: <ul style="list-style-type: none"> –Wood group 1 case with wood group 1 front –Laminate price group 1 case with same or contrasting laminate front –Laminate price group 1 case with wood group 1 front Unfinished back Hinged doors have soft-close hinges Cable pass-through on bottom edge of back panel Attachment hardware: black paint only 	<ol style="list-style-type: none"> Style number Wood or laminate color number for service module Laminate color number for laminate fronts on laminate case, if selected Wood color number for wood fronts on laminate cases, if selected Options, if selected (see below) <p>▶ See <i>Surface Materials</i>, page 566.</p>

Options	Price	Required to Specify
Surface Materials <ul style="list-style-type: none"> Wood service module case <ul style="list-style-type: none"> Wood group 2 Wood group 3 Customiz stain Laminate service module case <ul style="list-style-type: none"> Laminate price group 2 Open Line laminate Wood group 2 on wood fronts Wood group 3 on wood fronts Customiz stain 	<ul style="list-style-type: none"> Prices at right Prices at right No cost See information at left +\$ 69 plus cost of laminate Prices at right Prices at right No cost 	<ul style="list-style-type: none"> Specify wood color number. Specify wood color number. Specify with <i>Customiz stain</i>. Specify laminate color number. ▶ See <i>Surface Materials Reference Manual</i>. Specify wood color number. Specify wood color number. Specify with <i>Customiz stain</i>.
Painted Glass Door(s) for Service Modules <ul style="list-style-type: none"> Non-locking glass doors <ul style="list-style-type: none"> Door Frame <ul style="list-style-type: none"> Painted metal frame for glass doors 	<ul style="list-style-type: none"> +\$314 per door No cost 	<ul style="list-style-type: none"> Specify with <i>glass doors</i> and select finish. Specify with <i>frame</i> and select paint color number.
Mirrored Glass Door(s) for Service Modules <ul style="list-style-type: none"> Non-locking glass doors <ul style="list-style-type: none"> Door Frame <ul style="list-style-type: none"> Painted metal frame for glass doors 	<ul style="list-style-type: none"> +\$440 per door No cost 	<ul style="list-style-type: none"> Specify with <i>mirrored glass door</i> and select finish. Specify with <i>frame</i> and select paint color number.
ADA on Hinged Doors <ul style="list-style-type: none"> ADA opening/closing on hinged doors 	<ul style="list-style-type: none"> No cost 	<ul style="list-style-type: none"> Specify with <i>ADA opening</i>.
Lock and Keying <ul style="list-style-type: none"> Lock <ul style="list-style-type: none"> On combination units On 60"W, 66"W, 72"W, and 78"W all closed units On 84"W, 90"W, and 96"W all closed units Keying <ul style="list-style-type: none"> Factory- and field-installed keying units 	<ul style="list-style-type: none"> +\$128 +\$128 +\$192 	<ul style="list-style-type: none"> Specify with <i>9250 Ember Chrome lock</i> or <i>9201 Polished Chrome lock</i>. Specify with <i>9250 Ember Chrome lock</i> or <i>9201 Polished Chrome lock</i>. Specify with <i>9250 Ember Chrome lock</i> or <i>9201 Polished Chrome lock</i>. ▶ Page 622
Related Products <ul style="list-style-type: none"> Finished back panels for overhead storage Tackboards and wood panels with slatwall for use with service modules Light valance Underline lighting 		<ul style="list-style-type: none"> ▶ Page 514 ▶ Page 550 ▶ Page 553 ▶ See <i>Steelcase Worktools Specification Guide</i>.

Specification Information

Dimensions D W	Style Number	Number of Doors	Base Prices			Options (Add \$ to Base Price)			
			Wood Group 1 Case	Laminate Price Group 1 Case	Wood Group 1 Front	Wood Group 2	Wood Group 3	Wood Case with Wood Front	Laminate Case with Wood Front

Single-High Service Modules—36⁵/₈" High

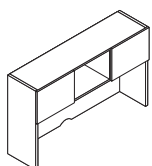

Combination Open and Closed

Dimensions	Style Number	Number of Doors	Wood Group 1 Case	Laminate Price Group 1 Case	Wood Group 1 Front	Wood Group 2	Wood Group 3	Wood Case with Wood Front	Laminate Case with Wood Front	Wood Group 2	Wood Group 3
15 ³ / ₄ " 60"	E6MST156036M	2	\$2953	\$2318	\$2650	+\$271	+\$ 952	+\$47	+\$164		
15 ³ / ₄ " 66"	E6MST156636M	2	\$3207	\$2572	\$2904	+\$271	+\$ 952	+\$47	+\$164		
15 ³ / ₄ " 72"	E6MST157236M	2	\$3459	\$2824	\$3156	+\$271	+\$ 952	+\$47	+\$164		
15 ³ / ₄ " 78"	E6MST157836M	2	\$3629	\$2994	\$3326	+\$271	+\$ 952	+\$47	+\$164		
15 ³ / ₄ " 84"	E6MST158436M	4	\$3799	\$3164	\$3496	+\$271	+\$ 952	+\$47	+\$164		
15 ³ / ₄ " 90"	E6MST159036M	4	\$3967	\$3332	\$3664	+\$405	+\$1412	+\$47	+\$164		
15 ³ / ₄ " 96"	E6MST159636M	4	\$4169	\$3534	\$3866	+\$405	+\$1412	+\$47	+\$164		

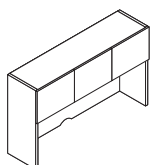

All Closed

Dimensions	Style Number	Number of Doors	Wood Group 1 Case	Laminate Price Group 1 Case	Wood Group 1 Front	Wood Group 2	Wood Group 3	Wood Case with Wood Front	Laminate Case with Wood Front	Wood Group 2	Wood Group 3
15 ³ / ₄ " 60"	E6MST156036C	3	\$3073	\$2438	\$2770	+\$271	+\$ 952	+\$47	+\$164		
15 ³ / ₄ " 66"	E6MST156636C	4	\$3328	\$2693	\$3025	+\$271	+\$ 952	+\$47	+\$164		
15 ³ / ₄ " 72"	E6MST157236C	4	\$3582	\$2947	\$3279	+\$271	+\$ 952	+\$47	+\$164		
15 ³ / ₄ " 78"	E6MST157836C	4	\$3749	\$3114	\$3446	+\$271	+\$ 952	+\$47	+\$164		
15 ³ / ₄ " 84"	E6MST158436C	5	\$3920	\$3285	\$3617	+\$271	+\$ 952	+\$47	+\$164		
15 ³ / ₄ " 90"	E6MST159036C	5	\$4088	\$3453	\$3785	+\$405	+\$1412	+\$47	+\$164		
15 ³ / ₄ " 96"	E6MST159636C	5	\$4291	\$3656	\$3988	+\$405	+\$1412	+\$47	+\$164		

Elective Elements

43½" Single-High Service Modules

Wood Veneer or Laminate

SIN 711.2

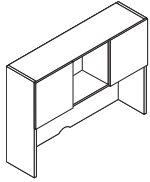

Tip: 43½"H single-high service modules align with the top of 72½"H towers and bookcases when mounted at 29"H.

For laminate price group 2 pricing, please refer to the electronic catalog or SmartTools.

Tip: Glass doors feature self-close hinges and are not available with soft-close hinges. Glass doors are not available with locks.

Tip: ADA opening/closing option features a magnetic touch latch and neutral hinge.

Tip: If using a modesty panel on a worksurface below a service module, order a cable pass-through in the modesty panel to facilitate cable routing.

Tip: Specify an optional tackboard or wood panel with slatwall to cover unfinished cable pass-through if desired.

Tip: Side panels for 32¼"H single-high service modules are ¾" thick. Side panels for 36⅝"H and 43½"H single-high service modules are 1⅝" thick.

Standard Includes	Required to Specify
<ul style="list-style-type: none"> Service module: <ul style="list-style-type: none"> –Wood group 1 case with wood group 1 front –Laminate price group 1 case with same or contrasting laminate front –Laminate price group 1 case with wood group 1 front Unfinished back Hinged doors have soft-close hinges Cable pass-through on bottom edge of back panel Attachment hardware: black paint only 	<ol style="list-style-type: none"> Style number Wood or laminate color number for service module Laminate color number for laminate fronts on laminate case, if selected Wood color number for wood fronts on laminate cases, if selected Options, if selected (see below) <p>▶ See <i>Surface Materials</i>, page 566.</p>

Options	Price	Required to Specify
Surface Materials <ul style="list-style-type: none"> Wood service module case <ul style="list-style-type: none"> Wood group 2 Wood group 3 Customiz stain Laminate service module case <ul style="list-style-type: none"> Laminate price group 2 Open Line laminate Wood group 2 on wood fronts Wood group 3 on wood fronts Customiz stain 	<ul style="list-style-type: none"> Prices at right Prices at right No cost See information at left +\$ 69 plus cost of laminate Prices at right Prices at right No cost 	<ul style="list-style-type: none"> Specify wood color number. Specify wood color number. Specify <i>with Customiz stain</i>. Specify laminate color number. ▶ See <i>Surface Materials Reference Manual</i>. Specify wood color number. Specify wood color number. Specify <i>with Customiz stain</i>.
Painted Glass Door(s) for Service Modules <ul style="list-style-type: none"> Non-locking glass doors <ul style="list-style-type: none"> Door Frame <ul style="list-style-type: none"> Painted metal frame for glass doors 	<ul style="list-style-type: none"> +\$314 per door No cost 	<ul style="list-style-type: none"> Specify <i>with glass doors</i> and select finish. Specify <i>with frame</i> and select paint color number.
Mirrored Glass Door(s) for Service Modules <ul style="list-style-type: none"> Non-locking glass doors <ul style="list-style-type: none"> Door Frame <ul style="list-style-type: none"> Painted metal frame for glass doors 	<ul style="list-style-type: none"> +\$440 per door No cost 	<ul style="list-style-type: none"> Specify <i>with mirrored glass door</i> and select finish. Specify <i>with frame</i> and select paint color number.
ADA on Hinged Doors <ul style="list-style-type: none"> ADA opening/closing on hinged doors 	<ul style="list-style-type: none"> No cost 	<ul style="list-style-type: none"> Specify <i>with ADA opening</i>.
Lock and Keying <ul style="list-style-type: none"> Lock <ul style="list-style-type: none"> On combination units On 60"W, 66"W, 72"W, and 78"W all closed units On 84"W, 90"W, and 96"W all closed units Keying <ul style="list-style-type: none"> Factory- and field-installed keying units 	<ul style="list-style-type: none"> +\$128 +\$128 +\$192 	<ul style="list-style-type: none"> Specify <i>with 9250 Ember Chrome lock</i> or <i>9201 Polished Chrome lock</i>. Specify <i>with 9250 Ember Chrome lock</i> or <i>9201 Polished Chrome lock</i>. Specify <i>with 9250 Ember Chrome lock</i> or <i>9201 Polished Chrome lock</i>. ▶ Page 622
Related Products <ul style="list-style-type: none"> Finished back panels for overhead storage Tackboards and wood panels with slatwall for use with service modules Light Valance Underline lighting 		<ul style="list-style-type: none"> ▶ Page 514 ▶ Page 550 ▶ Page 553 ▶ See <i>Steelcase Worktools Specification Guide</i>.

Specification Information

• Dimensions D W	• Style Number	• Number of Doors	• Base Prices			• Options (Add \$ to Base Price)					
			Wood Group 1 Case	Laminate Price Group 1 Case	Wood Group 1 Front	Wood Group 1 Front	Wood Group 2	Wood Group 3	Wood Group 2	Wood Group 3	
						Wood Case with Wood Front	Laminate Case with Wood Front	Wood Group 2	Wood Group 3	Wood Group 2	Wood Group 3

Single-High Service Modules—43 1/2" High

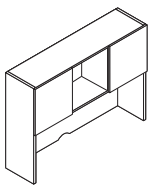

Combination Open and Closed

15 3/4" 60"	E6MST156043M	2	\$3644	\$3009	\$3341	+\$271	+\$ 952	+\$47	+\$164
15 3/4" 66"	E6MST156643M	2	\$3954	\$3319	\$3651	+\$271	+\$ 952	+\$47	+\$164
15 3/4" 72"	E6MST157243M	2	\$4265	\$3630	\$3962	+\$271	+\$ 952	+\$47	+\$164
15 3/4" 78"	E6MST157843M	2	\$4472	\$3837	\$4169	+\$271	+\$ 952	+\$47	+\$164
15 3/4" 84"	E6MST158443M	4	\$4679	\$4044	\$4376	+\$271	+\$ 952	+\$47	+\$164
15 3/4" 90"	E6MST159043M	4	\$4886	\$4251	\$4583	+\$405	+\$1412	+\$47	+\$164
15 3/4" 96"	E6MST159643M	4	\$5136	\$4501	\$4833	+\$405	+\$1412	+\$47	+\$164

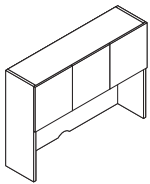

All Closed

15 3/4" 60"	E6MST156043C	3	\$3764	\$3129	\$3461	+\$271	+\$ 952	+\$47	+\$164
15 3/4" 66"	E6MST156643C	4	\$4075	\$3440	\$3772	+\$271	+\$ 952	+\$47	+\$164
15 3/4" 72"	E6MST157243C	4	\$4386	\$3751	\$4083	+\$271	+\$ 952	+\$47	+\$164
15 3/4" 78"	E6MST157843C	4	\$4592	\$3957	\$4289	+\$271	+\$ 952	+\$47	+\$164
15 3/4" 84"	E6MST158443C	5	\$4800	\$4165	\$4497	+\$271	+\$ 952	+\$47	+\$164
15 3/4" 90"	E6MST159043C	5	\$5007	\$4372	\$4704	+\$405	+\$1412	+\$47	+\$164
15 3/4" 96"	E6MST159643C	5	\$5258	\$4623	\$4955	+\$405	+\$1412	+\$47	+\$164

► Specification Information, continued on next page

Elective Elements

43½" Single-High Service Modules, Wood Veneer or Laminate, continued

SIN 711.2

► **Specification Information, continued from previous page**

Specification Information

Dimensions		Style Number	Number of Dividers	Base Prices		Options	
D	W			Wood Group 1 Case	Laminate Price Group 1 Case	(Add \$ to Base Price)	
				Open Front	Open Front	Wood	
						Wood Case with Open Front	
						Wood Group 2	Wood Group 3

Single-High Service Modules—43½" High, continued

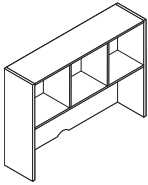

Open

15"	60"	E6MST156043P	1	\$3188	\$2706	+\$224	+\$ 788
15"	66"	E6MST156643P	3	\$3456	\$2974	+\$224	+\$ 788
15"	72"	E6MST157243P	3	\$3727	\$3245	+\$224	+\$ 788
15"	78"	E6MST157843P	3	\$3911	\$3429	+\$224	+\$ 788
15"	84"	E6MST158443P	3	\$4097	\$3615	+\$224	+\$ 788
15"	90"	E6MST159043P	3	\$4279	\$3797	+\$358	+\$1248
15"	96"	E6MST159643P	3	\$4637	\$4155	+\$358	+\$1248

Double-High Service Modules

Wood Veneer or Laminate

SIN 711.2

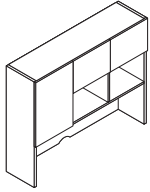

Left-Hand Unit

Tip: Double-high service modules align with the top of 77½"H towers and bookcases.

For laminate price group 2 pricing, please refer to the electronic catalog or SmartTools.

Tip: Glass doors feature self-close hinges and are not available with soft-close hinges. Glass doors are not available with locks.

Tip: ADA opening/closing option features a magnetic touch latch and neutral hinge.

Tip: Only the tall door will lock if locking is specified on the combination units.

Tip: If using a modesty panel on worksurface below a service module, order a cable pass-through in the modesty panel to facilitate cable routing.

Tip: Shelves are not adjustable.

Tip: Specify an optional tackboard or wood panel with slatwall to cover unfinished cable pass-through if desired.

Standard Includes		Required to Specify	
<ul style="list-style-type: none"> Service Module: <ul style="list-style-type: none"> –Wood group 1 case with wood group 1 front –Laminate price group 1 case with same or contrasting laminate front –Laminate price group 1 case with wood group 1 front Unfinished back Hinged doors have soft-close hinges Cable pass-through on bottom edge of back panel Attachment hardware: black paint only 		<ol style="list-style-type: none"> Style number Wood or laminate color number for service module Laminate color number for laminate fronts on laminate case, if selected Wood color number for wood fronts on laminate cases, if selected Options, if selected (see below) <p>▶ See <i>Surface Materials</i>, page 566.</p>	
Options	Price	Required to Specify	
Surface Materials	Wood service module case		
<ul style="list-style-type: none"> Wood group 2 Wood group 3 Customiz stain 	<ul style="list-style-type: none"> Prices at right Prices at right No cost 	<ul style="list-style-type: none"> Specify wood color number. Specify wood color number. Specify with <i>Customiz stain</i>. 	
	Laminate service module case		
<ul style="list-style-type: none"> Laminate price group 2 Open Line laminate 	<ul style="list-style-type: none"> See information at left +\$ 69 plus cost of laminate Prices at right Prices at right No cost 	<ul style="list-style-type: none"> Specify laminate color number. ▶ See <i>Surface Materials Reference Manual</i>. Specify wood color number. Specify wood color number. Specify with <i>Customiz stain</i>. 	
	Wood group 2 on wood fronts	Specify wood color number.	
	Wood group 3 on wood fronts	Specify wood color number.	
	Customiz stain	Specify with <i>Customiz stain</i> .	
Painted Glass Door(s) for Service Modules	Non-locking glass doors		
	<ul style="list-style-type: none"> Small door Large door 	<ul style="list-style-type: none"> +\$314 per door +\$350 per door 	<ul style="list-style-type: none"> Specify with <i>glass doors</i> and select finish. Specify with <i>glass doors</i> and select finish.
	Frame		
	<ul style="list-style-type: none"> Painted metal frame for glass doors 	No cost	Specify with <i>frame</i> and select paint color number.
Mirrored Glass Door(s) for Service Modules	Non-locking glass doors		
	<ul style="list-style-type: none"> Small door Large door 	<ul style="list-style-type: none"> +\$440 per door +\$488 per door 	<ul style="list-style-type: none"> Specify with <i>mirrored glass door</i> and select finish. Specify with <i>mirrored glass door</i> and select finish.
	Frame		
	<ul style="list-style-type: none"> Painted metal frame for glass doors 	No cost	Specify with <i>frame</i> and select paint color number.
ADA on Hinged Doors	<ul style="list-style-type: none"> ADA opening/closing on hinged doors 	No cost	Specify with <i>ADA opening</i> .
Lock and Keying	Lock		
	<ul style="list-style-type: none"> On combination units On 60"W, 66"W, 72"W, and 78"W all closed units On 84"W, 90"W, and 96"W all closed units 	<ul style="list-style-type: none"> +\$ 64 +\$128 +\$192 	<ul style="list-style-type: none"> Specify with <i>9250 Ember Chrome lock</i> or <i>9201 Polished Chrome lock</i>. Specify with <i>9250 Ember Chrome lock</i> or <i>9201 Polished Chrome lock</i>. Specify with <i>9250 Ember Chrome lock</i> or <i>9201 Polished Chrome lock</i>.
	Keying		
	<ul style="list-style-type: none"> Factory- and field-installed keying units 		▶ Page 622
Shelves	<ul style="list-style-type: none"> ¾" shelf Metal shelf 	<ul style="list-style-type: none"> No cost –\$ 26 per shelf 	<ul style="list-style-type: none"> Specify with <i>¾" shelf</i>. Specify with <i>metal shelves</i> and select paint color number.
Related Products	<ul style="list-style-type: none"> Finished back panels for overhead storage Tackboards and wood panels with slatwall for use with service modules Light Valance Underline lighting 		<ul style="list-style-type: none"> ▶ Page 514 ▶ Page 550 ▶ Page 553 ▶ See <i>Steelcase Worktools Specification Guide</i>.

Specification Information

• Dimensions D W	• Style Number	• Number of Doors	• Base Prices		• Options (Add \$ to Base Price)					
			Wood Group 1 Case	Laminate Price Group 1 Case	Wood Group 1 Front	Wood Group 1 Front	Wood Group 2 Group 3	Wood Group 2 Group 3		
		Small Large			Wood Case with Wood Front	Laminate Case with Wood Front	Wood Group 2	Wood Group 3	Wood Group 2	Wood Group 3

Double-High Service Modules—48⁹/₁₆" High

Combination Open and Closed

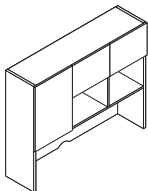

Left-Hand

15 ³ / ₄ " 60"	E6MDT156048L	2	1	\$4337	\$3492	\$3974	+\$272	+\$ 951	+\$69	+\$242
15 ³ / ₄ " 66"	E6MDT156648L	3	1	\$4703	\$3858	\$4340	+\$272	+\$ 951	+\$69	+\$242
15 ³ / ₄ " 72"	E6MDT157248L	3	1	\$5071	\$4226	\$4708	+\$272	+\$ 951	+\$69	+\$242
15 ³ / ₄ " 78"	E6MDT157848L	3	1	\$5316	\$4471	\$4953	+\$272	+\$ 951	+\$69	+\$242
15 ³ / ₄ " 84"	E6MDT158448L	3	2	\$5560	\$4715	\$5197	+\$272	+\$ 951	+\$69	+\$242
15 ³ / ₄ " 90"	E6MDT159048L	3	2	\$5805	\$4960	\$5442	+\$404	+\$1412	+\$96	+\$335
15 ³ / ₄ " 96"	E6MDT159648L	3	2	\$6103	\$5258	\$5740	+\$404	+\$1412	+\$96	+\$335

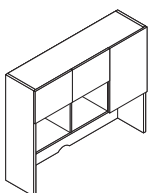

Right-Hand

15 ³ / ₄ " 60"	E6MDT156048R	2	1	\$4337	\$3492	\$3974	+\$272	+\$ 951	+\$69	+\$242
15 ³ / ₄ " 66"	E6MDT156648R	3	1	\$4703	\$3858	\$4340	+\$272	+\$ 951	+\$69	+\$242
15 ³ / ₄ " 72"	E6MDT157248R	3	1	\$5071	\$4226	\$4708	+\$272	+\$ 951	+\$69	+\$242
15 ³ / ₄ " 78"	E6MDT157848R	3	1	\$5316	\$4471	\$4953	+\$272	+\$ 951	+\$69	+\$242
15 ³ / ₄ " 84"	E6MDT158448R	3	2	\$5560	\$4715	\$5197	+\$272	+\$ 951	+\$69	+\$242
15 ³ / ₄ " 90"	E6MDT159048R	3	2	\$5805	\$4960	\$5442	+\$404	+\$1412	+\$96	+\$335
15 ³ / ₄ " 96"	E6MDT159648R	3	2	\$6103	\$5258	\$5740	+\$404	+\$1412	+\$96	+\$335

► Specification Information, continued on next page

► Specification Information, continued from previous page

Specification Information						
Dimensions		Style Number	Number of Dividers	Base Prices		Options (Add \$ to Base Price)
D	W			Wood Group 1 Case	Laminate Price Group 1 Case	
				Open Front	Open Front	Wood Wood Case with Open Front Wood Group 2 : Wood Group 3

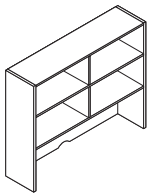

Open						
D	W	Style Number	Number of Dividers	Wood Group 1 Case	Laminate Price Group 1 Case	Options (Add \$ to Base Price)
15"	60"	E6MDT156048P	1	\$3693	\$2846	+\$272 +\$ 952
15"	66"	E6MDT156648P	3	\$4059	\$3212	+\$272 +\$ 952
15"	72"	E6MDT157248P	3	\$4428	\$3581	+\$272 +\$ 952
15"	78"	E6MDT157848P	3	\$4671	\$3824	+\$272 +\$ 952
15"	84"	E6MDT158448P	3	\$4915	\$4068	+\$272 +\$ 952
15"	90"	E6MDT159048P	3	\$5160	\$4313	+\$404 +\$1411
15"	96"	E6MDT159648P	3	\$5458	\$4611	+\$404 +\$1411

Tackboards and Wood Panels with Slatwall

For Use with Service Modules

SIN 711.2

Tip: Tackboards and wood panels with slatwall feature two scallops along the top edge to facilitate task light cord routing.

Tip: Because tackboard is one-piece design, fabric will be railroaded for consistent application.

Standard Includes		Required to Specify	
	<ul style="list-style-type: none"> Tackboard, if selected: vertical surface fabric price group 1 Wood panel, if selected: wood group 1 Slatwall on wood panel, if selected: 0835 Black Paint or 8043 Clear Anodized Aluminum Cable routing scallop(s) on top edge Attachment hardware: black paint only 		<ol style="list-style-type: none"> Style number Fabric color number for tackboard, if selected Wood color number and slatwall color number for wood panel, if selected Options, if selected (see below) <p>▶ See <i>Surface Materials</i>, page 566.</p>
Options	Price	Required to Specify	
Surface Materials	Tackboard		
	<ul style="list-style-type: none"> Fabric price group 1 Fabric price group 2 Fabric price group 3 Fabric price group 4 Fabric price group 5 Fabric price group COM 	No cost +\$ 12 +\$ 55 +\$ 75 +\$120 +\$ 16	Specify fabric color number. Specify fabric color number. Specify fabric color number. Specify fabric color number. Specify fabric color number. ▶ See <i>Surface Materials Reference Manual</i> .
	Wood panel		
	<ul style="list-style-type: none"> Wood group 2 Wood group 3 Customiz stain on wood 	Prices at right Prices at right No cost	Specify wood color number. Specify wood color number. Specify <i>with Customiz stain</i> .
Related Products	<ul style="list-style-type: none"> Single-high service modules Double-high service modules Worktools for slatwall 		▶ Pages 484–490 ▶ Page 546 ▶ See <i>Steelcase Worktools Specification Guide</i> .

Specification Information							
Dimensions W H	Service Module Width	Tackboard Style Number	Base Price	Wood Panel with Slatwall Style Number	Base Price	Option (Add \$ to Base Price)	
						Wood Group 2	Wood Group 3

Tackboards and Wood Panels with Slatwall

For Use with 32¼"H Single-High Service Modules

58½"	17¼"	60"	E6IT5817S	\$293	N.A.	N.A.	N.A.	N.A.
64½"	17¼"	66"	E6IT6417S	\$326	N.A.	N.A.	N.A.	N.A.
70½"	17¼"	72"	E6IT7017S	\$357	N.A.	N.A.	N.A.	N.A.
76½"	17¼"	78"	E6IT7617S	\$373	N.A.	N.A.	N.A.	N.A.
82½"	17¼"	84"	E6IT8217S	\$393	N.A.	N.A.	N.A.	N.A.
88½"	17¼"	90"	E6IT8817S	\$410	N.A.	N.A.	N.A.	N.A.
94½"	17¼"	96"	E6IT9417S	\$452	N.A.	N.A.	N.A.	N.A.

▶ Specification Information, continued on next page

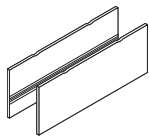

► Specification Information, continued from previous page

Specification Information								
Dimensions		Service Module Width	Tackboard Style Number	Base Price	Wood Panel with Slatwall Style Number	Base Price	Option (Add \$ to Base Price)	
W	H						Wood	Wood
							Group 2	Group 3

Tackboards and Wood Panels with Slatwall, continued

For Use with 36⁵/₈"H and 43¹/₂"H Single-High Service Modules

58 ³ / ₈ "	21 ¹ / ₂ "	60"	E6ITT5821S	\$293	E6IST5821S	\$ 802	+\$28	+\$ 94
64 ³ / ₈ "	21 ¹ / ₂ "	66"	E6ITT6421S	\$326	E6IST6421S	\$ 841	+\$28	+\$ 94
70 ³ / ₈ "	21 ¹ / ₂ "	72"	E6ITT7021S	\$357	E6IST7021S	\$ 874	+\$47	+\$164
76 ³ / ₈ "	21 ¹ / ₂ "	78"	E6ITT7621S	\$373	E6IST7621S	\$ 900	+\$47	+\$164
82 ³ / ₈ "	21 ¹ / ₂ "	84"	E6ITT8221S	\$393	E6IST8221S	\$ 923	+\$47	+\$164
88 ³ / ₈ "	21 ¹ / ₂ "	90"	E6ITT8821S	\$410	E6IST8821S	\$ 947	+\$47	+\$164
94 ³ / ₈ "	21 ¹ / ₂ "	96"	E6ITT9421S	\$452	E6IST9421S	\$1019	+\$47	+\$164

For Use with 36⁵/₈"H and 43¹/₂"H Single-High Service Modules and Blade Accessory Shelf

58 ³ / ₈ "	18 ¹ / ₂ "	60"	E6ITT5818S	\$293	E6IST5818S	\$ 802	+\$28	+\$ 94
64 ³ / ₈ "	18 ¹ / ₂ "	66"	E6ITT6418S	\$326	E6IST6418S	\$ 841	+\$28	+\$ 94
70 ³ / ₈ "	18 ¹ / ₂ "	72"	E6ITT7018S	\$357	E6IST7018S	\$ 874	+\$28	+\$ 94
76 ³ / ₈ "	18 ¹ / ₂ "	78"	E6ITT7618S	\$373	E6IST7618S	\$ 900	+\$47	+\$164
82 ³ / ₈ "	18 ¹ / ₂ "	84"	E6ITT8218S	\$393	E6IST8218S	\$ 923	+\$47	+\$164
88 ³ / ₈ "	18 ¹ / ₂ "	90"	E6ITT8818S	\$410	E6IST8818S	\$ 947	+\$47	+\$164
94 ³ / ₈ "	18 ¹ / ₂ "	96"	E6ITT9418S	\$452	E6IST9418S	\$1019	+\$47	+\$164

For Use with Double-High Service Modules

58 ³ / ₈ "	18 ¹ / ₂ "	60"	E6ITT5818S	\$293	E6IST5818S	\$ 802	+\$28	+\$ 94
64 ³ / ₈ "	18 ¹ / ₂ "	66"	E6ITT6418S	\$326	E6IST6418S	\$ 841	+\$28	+\$ 94
70 ³ / ₈ "	18 ¹ / ₂ "	72"	E6ITT7018S	\$357	E6IST7018S	\$ 874	+\$28	+\$ 94
76 ³ / ₈ "	18 ¹ / ₂ "	78"	E6ITT7618S	\$373	E6IST7618S	\$ 900	+\$47	+\$164
82 ³ / ₈ "	18 ¹ / ₂ "	84"	E6ITT8218S	\$393	E6IST8218S	\$ 923	+\$47	+\$164
88 ³ / ₈ "	18 ¹ / ₂ "	90"	E6ITT8818S	\$410	E6IST8818S	\$ 947	+\$47	+\$164
94 ³ / ₈ "	18 ¹ / ₂ "	96"	E6ITT9418S	\$452	E6IST9418S	\$1019	+\$47	+\$164

► Specification Information, continued on next page

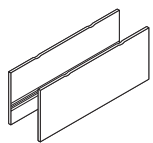
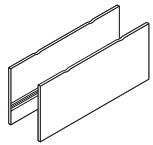

Tackboards and Wood Panels with Slatwall, For Use with Service Modules, continued

SIN 711.2

► Specification Information, continued from previous page

Specification Information						
• Dimensions			• Style • Number	• Base • Price	• Options (Add \$ to Base Price)	
W	H	Service Module Width			Wood	Wood
:	:	:	:	:	:	:
:	:	:	:	:	Wood	Wood
:	:	:	:	:	Group 2	Group 3

Tackboards

For Use with 32 1/4" H Single-High Service Modules and Blade Accessory Shelf

58 1/2"	14 3/8"	60"	E6IT5814B	\$293	N.A.	N.A.
70 1/2"	14 3/8"	72"	E6IT7014B	\$357	N.A.	N.A.
82 1/2"	14 3/8"	84"	E6IT8214B	\$393	N.A.	N.A.
94 1/2"	14 3/8"	96"	E6IT9414B	\$452	N.A.	N.A.

For Use with Double-High Service Modules and Blade Accessory Shelf

58 1/2"	15 3/8"	60"	E6IT5815B	\$293	N.A.	N.A.
70 1/2"	15 3/8"	72"	E6IT7015B	\$357	N.A.	N.A.
82 1/2"	15 3/8"	84"	E6IT8215B	\$393	N.A.	N.A.
94 1/2"	15 3/8"	96"	E6IT9415B	\$452	N.A.	N.A.

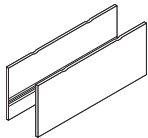
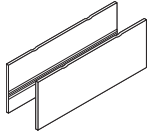

Light Valances for Service Modules

Wood Veneer or Laminate

SIN 711.2

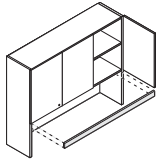

For laminate price group 2 pricing, please refer to the electronic catalog or SmartTools.

Standard Includes	Required to Specify
<ul style="list-style-type: none"> Light valance: wood group 1 veneer or laminate price group 1 Attachment hardware 	<ol style="list-style-type: none"> Style number Wood or laminate color number for light valance Options, if selected (see below) <ul style="list-style-type: none"> ▶ See <i>Surface Materials</i>, page 566.

Options	Price	Required to Specify
Surface Materials <ul style="list-style-type: none"> Wood light valance <ul style="list-style-type: none"> Wood group 2 Wood group 3 Customiz stain Laminate light valance <ul style="list-style-type: none"> Laminate price group 2 Open Line laminate 	<ul style="list-style-type: none"> +\$28 +\$94 No cost See information at left +\$69 	<ul style="list-style-type: none"> Specify wood color number. Specify wood color number. Specify <i>with Customiz stain</i>. Specify laminate color number. ▶ See <i>Surface Materials Reference Manual</i>.

Specification Information					
Dimensions			Style Number	Base Prices	
D	W	H		Wood Group 1	Laminate Price Group 1

Light Valances

For Use with Service Module

Depth	Width	Height	Style Number	Wood Price	Laminate Price
3/4"	58 5/16"	2"	E6AL58V	\$249	\$212
3/4"	64 5/16"	2"	E6AL64V	\$260	\$223
3/4"	70 5/16"	2"	E6AL70V	\$271	\$234
3/4"	76 5/16"	2"	E6AL76V	\$282	\$245
3/4"	82 5/16"	2"	E6AL82V	\$293	\$256
3/4"	88 5/16"	2"	E6AL88V	\$304	\$267
3/4"	94 5/16"	2"	E6AL94V	\$335	\$298

Specifying Elective Elements Electrical and Cable Management

► For more detailed product information, see the *Elective Elements Wood Systems Furniture Specification Guide* or consult your Steelcase dealer.

Electrical and Cable Management

Technology Zones (SIN 711.2)	556
Power Units with Cord Pass-Through (SIN 711.2)	557
Flip Up Power Unit (SIN 711.2)	557
Power/Data Boxes (SIN 711.2)	558
Convenience Tri-Receptacle with Power Cord and Plug (SIN 711.2)	558
Convenience Communication Outlet Housing (SIN 711.2)	559
Above-Worksurface Clamp Kit (SIN 711.2)	559
Below-Worksurface Mounting Bracket (SIN 711.2)	560
Cable Tray (SIN 711.2)	560
2½" Round Grommet (SIN 711.2)	560
Wire Guide Clips (SIN 711.2)	561
Wire Clips (SIN 711.2)	561
Velcro Wire Clips (SIN 711.2)	561
Wire Manager (SIN 711.2)	562
Cord Reels (SIN 711.2)	562
Vertebral Cable Riser and Extension (SIN 711.2)	562
Skeleton Bone Wire Manager and Extension (SIN 711.2)	563
Cable and Fiber Reels (SIN 711.2)	563
Termination Plate (SIN 711.2)	563
Power Shroud (SIN 711.2)	564
Metal Light Housings (SIN 711.2)	564

Electrical and Cable Management

SIN 711.2

Technology Zones

Standard Includes	Required to Specify
<ul style="list-style-type: none"> Technology zones: paint 	1 Style number 2 Color number for technology zones 3 Power schematic and line type for modular technology zones 4 Options, if selected (see below) ▶ See <i>Surface Materials</i> , page 566.

Options	Price	Required to Specify
Power Schematics and Line Options for Modular 3+1 <ul style="list-style-type: none"> Line 2 Line 3 Line 4 2+2 <ul style="list-style-type: none"> Line 2 Line 3 Line 4 3SN <ul style="list-style-type: none"> Line 2 Line 3 	No cost No cost No cost No cost No cost No cost No cost No cost	Specify with 3+1, line 1, and line 2. Specify with 3+1, line 1, and line 3. Specify with 3+1, line 1, and line 4. Specify with 2+2, line 1, and line 2. Specify with 2+2, line 1, and line 3. Specify with 2+2, line 1, and line 4. Specify with 3SN, line 1, and line 2. Specify with 3SN, line 1, and line 3.

Specification Information		
Width	Style Number	Price

Technology Zones

Modular (42" Flexible Conduit)

24"	E6VZ24M	\$780
-----	----------------	-------

Corded (9' Power Cord)

24"	E6VZ24C	\$750
-----	----------------	-------

Hardwire (6' Flexible Conduit)

24"	E6VZ24H	\$780
-----	----------------	-------

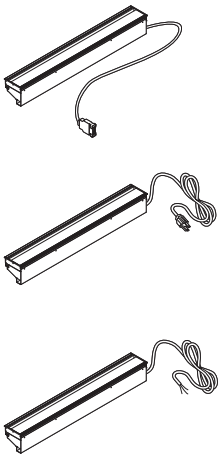

Power Units with Cord Pass-Through

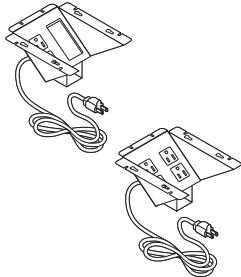

Tip: Power units are installed in locations below square grommets and extend below the worksurface.

Tip: Power units cannot be used over 15"W or 18"W underworksurface storage, but can be used over 30"W and 36"W 2-high lateral files that are 30"D.

Tip: Power units cannot be used over 1.5 high storage.

Standard Includes	Required to Specify
<ul style="list-style-type: none"> • Power unit: black textured paint only • Attachment hardware • 6' power cord with three-prong plug, when applicable: black plastic only 	Style number

Specification Information				
• Dimensions			• Style	• Price
D	W	H	Number	
:	:	:	:	:

Power Unit – Two Electrical Outlets

Corded				
6 ⁵ / ₆₄ "	6 ³ / ₃₂ "	4 ¹ / ₄ "	E6VPC	\$229
:	:	:	:	:
Hardwired				
6 ⁵ / ₆₄ "	6 ³ / ₃₂ "	4 ¹ / ₄ "	E6VPH	\$284
:	:	:	:	:

Power Unit–Four Electrical Outlets

Corded				
6 ⁵ / ₆₄ "	6 ³ / ₃₂ "	4 ¹ / ₄ "	E6VP4C	\$311
:	:	:	:	:
Hardwired				
6 ⁵ / ₆₄ "	6 ³ / ₃₂ "	4 ¹ / ₄ "	E6VP4H	\$418
:	:	:	:	:

Flip Up Power Unit



Tip: For installation purposes, actual hole size is 3³/₄" x 5".

Standard Includes	Required to Specify
<ul style="list-style-type: none"> • Power unit: 0835 black paint or 4799 Platinum paint • Two outlets: black plastic • Attachment hardware • 6' power cord with grounded plug: black plastic 	1 Style number 2 Paint color number for power unit

Specification Information				
• Dimensions			• Style	• Price
D	W	H	Number	
:	:	:	:	:

Flip Up Power Unit

4 ¹ / ₄ "	5 ¹ / ₂ "	2"	AWVFP	\$288
:	:	:	:	:

SIN 711.2

Power/Data Boxes

Standard Includes	Required to Specify
<ul style="list-style-type: none"> • Power/data box: black paint only • Power/power box: black paint only • Data/data box: black paint only • Attachment hardware 	Style number

Specification Information

• Dimensions	• Style	• Price
D W H	Number	:

Power Box

Power/Data Box					
3"	3"	1"	AWVBC		\$233

Power/Power Box					
3"	3"	1"	AWVBP		\$233

Data/Data Box					
3"	3"	1"	AWVBD		\$233

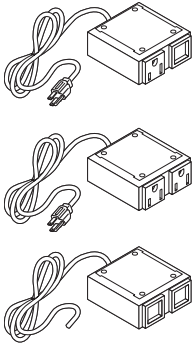

Convenience Tri-Receptacle with Power Cord and Plug

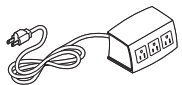

Tip: This unit does not include clamp kit.
▶ Page 559

Standard Includes	Required to Specify
<ul style="list-style-type: none"> • Convenience receptacle with three outlets: plastic • 8' power cord with grounded plug: black only 	1 Style number 2 Plastic color number for receptacle ▶ See <i>Surface Materials</i> , page 566.

Related Products

<ul style="list-style-type: none"> • Above-worksurface clamp kit • Below-worksurface mounting bracket 	<ul style="list-style-type: none"> ▶ Page 559 ▶ Page 560
---	--

Specification Information

• Dimensions	• Style	• Price		
D W H	Number	:		
2¾"	5¼"	2½"	GFUTP96	\$120

Convenience Communication Outlet Housing



Tip: This unit does not include clamp kit.

▶ See below.

Tip: Convenience communication outlet housing can be connected to convenience tri-receptacles side by side.

Standard Includes	Required to Specify
-------------------	---------------------

- Housing for field-installed modular communications faceplate: plastic

- 1 Style number
- 2 Plastic color number for housing
- ▶ See *Surface Materials*, page 566.

Related Products

- Above-worksurface clamp kit
- Below-worksurface mounting bracket

- ▶ See below
- ▶ Page 560

Specification Information				
• Dimensions			• Style	• Price
D	W	H	Number	

2 ³ / ₄ "	5 ¹ / ₄ "	2 ¹ / ₂ "	GFUCH	\$58
---------------------------------	---------------------------------	---------------------------------	--------------	------

Above-Worksurface Clamp Kit



Standard Includes	Required to Specify
-------------------	---------------------

- Mounting clamp to secure convenience tri-receptacle to worksurface: 6653 Solar Black only

- Style number

Related Products

- Convenience tri-receptacle with power cord and plug
- Convenience communication outlet housing

- ▶ Page 558
- ▶ See above

Specification Information	
• Style	• Price
Number	

GFUTMC	\$17
---------------	------

Electrical and Cable Management, continued

SIN 711.2

Below-Worksurface Mounting Bracket

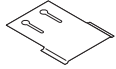

Tip: Mounting bracket supports convenience tri-receptacles and convenience communication outlet housing below the worksurface.

Tip: Each tri-receptacle, whether power or communications, should have its own mounting bracket for below-worksurface mounting applications.

Standard Includes	Required to Specify
<ul style="list-style-type: none"> • Mounting bracket: 4793 Solar Black only 	Style number

Related Products
<ul style="list-style-type: none"> • Convenience tri-receptacle with power cord and plug ▶ Page 558 • Convenience communication outlet housing ▶ Page 559

Specification Information	
• Style Number	• Price
GFUTMB	\$12
•	•

Cable Tray

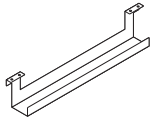

Tip: Cable tray can be mounted behind a Technology modesty panel.

Standard Includes	Required to Specify
<ul style="list-style-type: none"> • Cable tray: black paint only • Attachment hardware 	Style number

Specification Information				
• Dimensions			• Style Number	• Price
D	W	H	•	•
3"	32"	5 1/4"	AWAA	\$73
•	•	•	•	•

2 1/2" Round Grommet



Tip: Grommet AWAG2 is for use on worksurfaces only.

Tip: When using AWAG2 in the Universal parametric straight worksurface, specify the 2" grommet cutout option. Actual diameter of cutout is 2 1/4".

Standard Includes	Required to Specify
<ul style="list-style-type: none"> • Grommet: paint or metal • Installation instructions 	1 Style number 2 Paint or metal color number ▶ See <i>Surface Materials</i> , page 566.

Specification Information			
• Dimensions		• Style Number	• Price
D	W	•	•
2 1/2"	2 1/2"	AWAG2	\$68
•	•	•	•

Wire Guide Clips



Standard Includes	Required to Specify
<ul style="list-style-type: none"> • Carton of 20 adhesive-backed wire guide clips: black plastic only 	Style number

Specification Information

Style Number	Price
32WCP	\$33

Wire Clips



Standard Includes	Required to Specify
<ul style="list-style-type: none"> • Carton of six: black plastic only • Foam tape • Mounting screws 	Style number

Specification Information

Style Number	Price
999CHT	\$58

Velcro Wire Clips



Tip: Attaches under work-surfaces with screws or around leg.

Note: This product is turnstone, **NOT** Steelcase. It is included here to simplify your planning. Remember that Steelcase has different pricing terms than turnstone products.

Standard Includes	Required to Specify
<ul style="list-style-type: none"> • Package of four wire clips: black plastic only • Attachment hardware 	Style number

Specification Information

Dimensions			Style Number	Price
D	W	H		
1½"	8"	½"	TSSLEGCLP	\$49

Elective Elements

Electrical and Cable Management, continued

SIN 711.2

Wire Manager

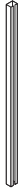

Standard Includes				Required to Specify
<ul style="list-style-type: none"> 25" wire manager with double-sided tape: black plastic only 				Style number
Specification Information				
Dimensions			Style	Price
D	W	H	Number	
1"	3/4"	25"	AWVW	\$15

Cord Reels

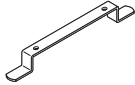

Standard Includes		Required to Specify
<ul style="list-style-type: none"> Carton of six cord reels: black paint only Attachment hardware 		Style number
Specification Information		
Style	Price	
Number		
98767	\$59	

Vertebral Cable Riser and Extension

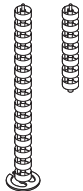

Standard Includes			Required to Specify
<ul style="list-style-type: none"> Vertebral cable riser: black plastic only Attachment hardware Floor plate: metallic aluminum only 			Style number
Specification Information			
Length	Style	Price	
	Number		
Vertebral Cable Riser			
31 1/2"	DAVC	\$134	
Vertebral Cable Riser Extension			
15 3/4"	DAVCE	\$ 39	

Tip: 15 3/4" L cable riser is an extension only. Extension does not include attachment hardware or floor plate.

Skeleton Bone Wire Manager and Extension

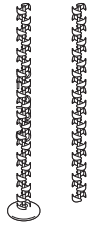

Note: This product is turnstone, **NOT** Steelcase. It is included here to simplify your planning. Remember that Steelcase has different pricing terms than turnstone products.

Standard Includes	Required to Specify
<ul style="list-style-type: none"> • Wire manager: black plastic only • Attachment hardware 	Style number

Specification Information

Dimensions			Style	Price
D	W	H	Number	
Skeleton Bone Wire Manager				
1½"	1¾"	38"	TS5SKLBNE	\$173
Skeleton Bone Wire Manager Extension				
1½"	1¾"	36"	TS5SKEXT	\$148

Cable and Fiber Reels



Standard Includes	Required to Specify
<ul style="list-style-type: none"> • Package of four reels: black plastic only • Attachment hardware 	Style number

Specification Information

Dimensions			Style	Price
D	W	H	Number	
1¼"	8"	8 ⁵ / ₁₆ "	98766	\$140

Termination Plate



Standard Includes	Required to Specify
<ul style="list-style-type: none"> • Termination plate: black paint only • Attachment hardware 	Style number

Specification Information

Dimensions			Style	Price
D	W	H	Number	
¾"	7 ¹ / ₈ "	7 ¹ / ₈ "	98765	\$21

Electrical and Cable Management, continued

SIN 711.2

Power Shroud

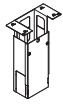

Tip: Power shroud can hold up to two standard cable bundles (whips).

Tip: Power shroud is available for installation anywhere under a leg base low storage unit.

Standard Includes		Required to Specify	
-------------------	--	---------------------	--

- Power shroud: paint
- Hardware kit

- 1 Style number
- 2 Paint color number for housing
- ▶ See *Surface Materials*, page 566

Surface Materials	Options	Price	Required to Specify
-------------------	---------	-------	---------------------

Surface Materials

- Metal

No cost

Specify paint color number.

Related Products

- Leg base storage
- Leg base credenzas

- ▶ Page 347
- ▶ Pages 360–446

Specification Information

Dimensions			Style Number	Price
D	W	H		
2"	3"	8¾"	E6PS238	\$95

Metal Light Housings

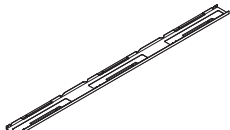

Tip: If the blade accessory shelf light is used, the metal light housing is required to mount the LED shelf light.

Tip: Maximum of three lights can be daisy-chained together within light valance housing.

Standard Includes		Required to Specify	
-------------------	--	---------------------	--

- Metal light housing: paint
 - 1 light (19"W)
 - 2 light (43½"W)
 - 3 light (68" W)
- Attachment kit

- 1 Style number
- 2 Paint color number for housing

Surface Materials	Options	Price	Required to Specify
-------------------	---------	-------	---------------------

Surface Materials

- Metal

No cost

Specify paint color number.

Related Products

- Blade accessory shelf

- ▶ Page 508

Specification Information

Dimensions			Style Number	Price
D	W	H		
3¾"	19"	¾"	E6LH19M	\$129
3¾"	43½"	¾"	E6LH43M	\$181
3¾"	68"	¾"	E6LH68M	\$233

Surface Materials

Surface Materials	566
Veneer Cut Guidelines	572
Metal and Accessory Paint Matrix	573
Open Line Laminate Edge Coordination Matrix	574
Specification Guidelines for Vertical Fabric Applications	575
Color Coordination Matrix	576

Surface Materials

This listing includes all the surface material choices that are available for the Elective Elements products in this specification guide.

Resources

For more information about surface materials, refer to the following resources:

Additional surface materials specification tools are available to assist you in the specification process—the Surface Materials Binders.

Surface Materials Binders include:

- Surface Materials Reference Manual
- A complete set of swatch cards for hard surfaces, vertical surface fabrics, and seating upholstery

Wood

Steelcase carefully selects veneer and solid wood for consistent color and grain structure. Wood is a natural material and variations will occur in color, grain and texture. These variations are part of the inherent natural beauty of wood and are not considered defects.

Forest Stewardship Council (FSC) certified wood (veneer and core) is available on most Steelcase wood products through the Specials RFQ process.

All wood products will darken with age and exposure to ultraviolet light. This is especially apparent with cherry and maple veneer. We recommend that desk accessories be rearranged periodically to ensure even aging of wood surfaces.

When storing your wood furniture, please follow the following guidelines:

- Do not store products in trailers
- Store products in areas that simulate office temperatures (60°F to 90°F)
- Store products in areas that maintain constant, office-like humidity levels
- Keep product away from light. Cover products to make sure they are not exposed to light.

Steelcase Surfaces

Veneer

Veneers are matched for proper balance and consistency. Veneers are available flat cut or quarter cut, except for Oak, which is rift cut.

▶ Refer to the *Veneer Cut Guidelines* on page 572 for descriptions of each cut.

Open-pore finish is a medium gloss finish that leaves the wood grain texture visible to the eye and distinguishable to the touch.

▶ See *Surface Materials Reference Manual* for a listing of available veneers for Victor2.

Flat-cut open-pore finish choices

Wood Group 1

3062	FC/OP Graphite Walnut
3402	FC/OP Clear Cherry (Aged)
3412	FC/OP Natural Cherry
3422	FC/OP Medium Cherry
3522	FC/OP Clear Maple*
3572	FC/OP Amber on Maple
3592	FC/OP Blonde on Maple
3702	FC/OP Clear Walnut
3712	FC/OP Natural Walnut
3722	FC/OP Dark Mahogany on Walnut
3752	FC/OP Medium Walnut
3762	FC/OP Dark Walnut
3772	FC/OP Medium Mahogany on Walnut

Quarter-cut open-pore finish choices

Wood Group 1

3042	QC/OP Ash*
3222	QC/OP Clear Maple*
3272	QC/OP Amber on Maple
3292	QC/OP Blonde on Maple
3302	QC/OP Clear Walnut
3312	QC/OP Natural Walnut
3322	QC/OP Dark Mahogany on Walnut
3352	QC/OP Medium Walnut
3362	QC/OP Dark Walnut
3372	QC/OP Medium Mahogany on Walnut
3382	QC/OP Graphite Walnut

Rift-cut open-pore finish choices

Wood Group 1

3602	RC/OP Desert Oak
3612	RC/OP Warm Oak
3692	RC/OP Espresso Oak

Full-fill finish is a medium-gloss finish that completely fills the grain texture, yet allows the grain pattern to be seen. The wood has a lustrous, satiny look, and it is smooth to the touch. This finish is available on the wood worksurface or top only.

Tip: For ease of specification, full-fill finish codes can be selected on other veneer components being used in settings with full-fill veneer worksurfaces. The other components will not have the final fill coat applied, but the finish color will be consistent with the full-fill worksurfaces.

Tip: Make sure to check the cut selection across the entire order. There is no prevention to mixing cuts on a product or an order.

Flat-cut full-fill finish choices

Wood Group 1

3064	FC/FF Graphite Walnut
3404	FC/FF Clear Cherry (Aged)
3414	FC/FF Natural Cherry
3424	FC/FF Medium Cherry
3524	FC/FF Clear Maple*
3544	FC/FF Blonde on Maple
3574	FC/FF Amber on Maple
3704	FC/FF Clear Walnut
3714	FC/FF Natural Walnut
3724	FC/FF Dark Mahogany on Walnut
3754	FC/FF Medium Walnut
3764	FC/FF Dark Walnut
3774	FC/FF Medium Mahogany on Walnut

Quarter-cut full-fill finish choices

Wood Group 1

3224	QC/FF Clear Maple*
3274	QC/FF Amber on Maple
3294	QC/FF Blonde on Maple
3304	QC/FF Clear Walnut
3314	QC/FF Natural Walnut
3324	QC/FF Dark Mahogany on Walnut
3354	QC/FF Medium Walnut
3364	QC/FF Dark Walnut
3374	QC/FF Medium Mahogany on Walnut
3384	QC/FF Graphite Walnut

Rift-cut full-fill finish choices

Wood Group 1

3604	RC/FF Desert Oak
3614	RC/FF Warm Oak
3694	RC/FF Espresso Oak

**To ensure an understanding of the color ranges and characteristic variations of natural veneer, a sign-off sheet is required prior to orders being accepted for this clear-coat finish. The sign-off sheet is available through Steelcase advertising stock. Please use form 09-0000756 for 3042, form number 05-0001370 for 3222 and 3224.*

Premium Veneers

A selection of Premium veneers in this collection are available on most Steelcase brand products. The collection will be available as close to standard leadtimes as possible. However, because adequate supplies of veneer and solids must be secured, all orders will be scheduled individually. Leadtimes will vary based on Premium veneer and Premium solids availability at the time the order is placed. The collection is Graded-In as Wood Group 2 and Wood Group 3, and supported like standard veneers to make ordering easy. Please see the Steelcase surface materials section on village.steelcase.com for sample information and product line availability. All premium veneers are in clear-coat.

Quarter-cut open-pore finish choices

Wood Group 2

3032	QC/OP Dark Thin Line Bamboo
3052	QC/OP Ribbon Sapele

Wood Group 3

3832	QC/OP Figured Anegre
3842	QC/OP Figured Makore

Tip: Full-fill finish is not available on Premium veneers as a standard.

To ensure an understanding of the color ranges and characteristic variations of natural veneer, a sign-off sheet is required prior to orders being accepted for this clear-coat finish. The sign-off sheet is available through Steelcase advertising stock. Please use form number 09-0000755 for 3032, form number 09-0000757 for 3052, form number 09-0000758 for 3832, and form number 09-0000759 for 3842.

Tip: 3032 Dark Thin Line Bamboo is only available with a square worksurface profile.

Select Surfaces

For information on products within Select Surfaces, including accent paints and fabrics from Designtex, Gabriel, Kvadrat, and Pollack, please refer to the Surface Materials Reference Manual or visit www.steelcase.com/surface-materials under the Select Surfaces section.

Composite Veneer

Composite veneers are an engineered wood intended to create specific grain patterns and characteristics. They are pre-stained and finished with Steelcase's Clarity water-borne UV topcoat, which protects the environment while providing durability and clarity. Only open-pore finishes are available on composite wood. Composite veneer and matching edge bands are available on most Steelcase brand products. Composites, for use as a solid nosing substitute, are not available. Steelcase does not recommend mixing composite veneers with natural solid nosings because composite and natural wood grain and color matching are rarely compatible. Composite veneers are Graded-In as Wood Group 1 pricing.

Flat-cut open-pore finish choices

Wood Group 1

3JDX FC/OP Oak Composite
3JFX FC/OP Maple Composite
3JHX FC/OP Cherry Composite
3JXX FC/OP Walnut Composite

Quarter-cut open-pore finish choices

Wood Group 1

3F8X QC/OP European Walnut Composite
3GAX QC/OP Gold Teak Composite
3GFX QC/OP Rosewood Composite
3GGX QC/OP Zebrano Composite
3HGX QC/OP Oak Composite
3HVX QC/OP Walnut Composite
3JEX QC/OP Maple Composite
3JGX QC/OP Cherry Composite
3ZNX QC/OP Night Cerused Oak Composite

Tip: Known for their color consistency, composite veneers feature a clear coat finish. Because the veneers are sourced in large lots, overall color within a specific purchase order should have minimal color inconsistency. However, composite customers should know that colors may vary slightly from dye lot to dye lot. This inconsistency may be noticed when replacement pieces are ordered that may be from different dye lots, or when a new project phase is installed. Also note that composite veneers tend to fade and lighten over time, especially with sun exposure.

Tip: Composite veneers are only available with a square worksurface profile, and wood integral pulls are not available.

Tip: Be conscious if mixing the flat cut and the quarter cut in composites, there may be large variation in color.

Natural Veneer

Natural veneer is available in the Select Surfaces offering. Natural veneer may have extended lead-times. Place your order as you normally would for any other finish, calling out the appropriate finish code.

The following finishes are available through the natural veneer offering:

Flat-cut open-pore finish choices

Wood Group 1

3342 FC/OP Black Walnut
35A2 FC/OP Blanch Maple
37A2 FC/OP Thunder Walnut

Wood Group 3

3082 FC/OP Washed Walnut

Flat-cut full-fill finish choices

Wood Group 1

3734 FC/FF Black Walnut

Wood Group 3

3084 FC/FF Washed Walnut

Quarter-cut open-pore finish choices

Wood Group 1

32A2 QC/OP Blanch Maple
33A2 QC/OP Thunder Walnut
3392 QC/OP Black Walnut

Quarter-cut full-fill finish choices

Wood Group 1

3394 QC/FF Black Walnut

Rift-cut open-pore finish choices

Wood Group 1

36A2 RC/OP Volcanic Oak

Planked Veneer

Planked veneer is available in the Select Surfaces offering. Planked veneer may have extended lead-times. Place your order as you normally would for any other finish, calling out the appropriate finish code.

The following finishes are available through the planked veneer offering:

Wood Group 1

3P41 OP Planked Cherry
3P51 OP Planked Maple
3P61 OP Planked Oak
3P71 OP Planked Walnut

Tip: Known for its uniqueness, planked veneer has intentional and natural variations that include, but are not limited to: character marks, grain pattern, color, and natural color aging.

Steelcase Surfaces

Premium Veneers

A selection of Premium veneers in this collection are available on most Steelcase brand products. The collection will be available as close to standard leadtimes as possible. However, because adequate supplies of veneer and solids must be secured, all orders will be scheduled individually. Leadtimes will vary based on Premium veneer and Premium solids availability at the time the order is placed. The collection is Graded-In as Wood Group 2 and Wood Group 3, and supported like standard veneers to make ordering easy. Please see the Steelcase surface materials section on village.steelcase.com for sample information and product line availability. All premium veneers are in clear-coat.

Quarter-cut open-pore finish choices

Wood Group 2

3032 QC/OP Dark Thin Line Bamboo
3052 QC/OP Ribbon Sapele

Wood Group 3

3832 QC/OP Figured Anegre
3842 QC/OP Figured Makore

Tip: Full-fill finish is not available on Premium veneers as a standard.

To ensure an understanding of the color ranges and characteristic variations of natural veneer, a sign-off sheet is required prior to orders being accepted for this clear-coat finish. The sign-off sheet is available through Steelcase advertising stock. Please use form number 09-0000755 for 3032, form number 09-0000757 for 3052, form number 09-0000758 for 3832, and form number 09-0000759 for 3842.

Tip: 3032 Dark Thin Line Bamboo is only available with a square worksurface profile.

Custom Surfaces

Customiz stain is a service that allows you to create your own stain colors and finishes on standard veneer. Customiz stain color is available on all product lines that offer wood veneer.

A \$500 stain-matching fee applies on CUSTOMIZ requests (Exception: The \$500 fee does not apply on matches to Coalesce standard finishes or for a low-gloss finish request on a standard color). The \$500 fee covers the cost of formulating the Customiz color finish and applies regardless of whether or not an order for product is placed.

In addition, an approval form must be signed to indicate customer acceptance of Customiz match. A \$1,500 initiation fee will be charged prior to first order entry. This initiation fee activates the finish for unlimited use on any Steelcase product for an 18 month time period. After the 18 month time period has lapsed, the Customiz finish may be reactivated for another 18 months for a \$1,000 fee at any point within five years after the \$1,500 initiation fee was paid. If the finish is not reactivated within five years after the \$1,500 initiation fee was paid, the finish will be culled and the customer will need to pay the \$1,500 initiation fee again. All style number related Customiz charges products are no cost as of April 2014. The matching and initiation fees are not discountable.

Surface Materials, continued

Customiz stain takes 10 days to formulate. Consult the Surface Materials Reference Manual for more information. Custom veneers are also available and must be quoted by Steelcase specials group. Customiz stain on custom veneers takes 2 to 4 weeks to formulate.

Requirements and information on ordering a Customiz stain color are found in the Surface Materials Reference Manual.

Low sheen wood finish top-coat, approximately 15 gloss level instead of standard 35 gloss level, is available through Specials at no additional cost.

Laminate

► See *Surface Materials Reference Manual* for a listing of available laminates for Victor2.

Steelcase Surfaces

High-Pressure Laminate

Price Group 1

Fiber Laminate

2850 Vanadium Fiber
2851 Rhyme Fiber
2852 Tungsten Fiber
2854 Vellum Fiber
2859 Novell Fiber
2860 Granite Fiber
2861 Coconut Fiber
2862 Stucco Fiber

Micro Laminate

2920 Marl Micro
2921 Gypsum Micro
2922 Clay Micro
2923 Shadow Micro

Patina Laminate

2870 Blonde Bronze Patina
2871 Blackened Bronze Patina
2873 Instant Iron Patina

Solid Laminate

2722 Cream
2730 Arctic White
2746 Black
2759 Warm White
2811 Mist
2883 Seagull
2884 Milk
2885 Dune
2HMG Merle

Speckle Laminate

2820 Coffee Speckle
2822 Woodrose Speckle
2823 Driftwood Speckle
2824 Smoke Speckle
2825 Vanadium Speckle

Tip: Some wood veneer finishes and woodgrain laminates share the same name. Because of the difference in materials, veneers and laminates of the same name are not an exact match but do coordinate with each other.

Woodgrain Laminate

2406 Clear Cherry
2409 Clear Maple
2410 Graphite Walnut
2412 Natural Cherry
2422 Medium Cherry
2511 Winter on Maple
2536 Blackwood
2538 Clear Walnut
2539 Warm Oak
2592 Blonde on Maple
2714 Natural Walnut
2772 Medium Mahogany on Walnut

2HAK Clear Oak
2HAN Ash Noce
2HAT Acacia
2HAW Ash Wenge
2HBN Bisque Noce
2HBW Bisque Wenge
2HCN Clay Noce
2HCW Clay Wenge
2HSN Storm Noce
2HSW Storm Wenge

turnstone Laminate Collection

2535 Virginia Walnut
2536 Blackwood
2614 Chocolate Walnut
Tip: When specifying a blade edge worksurface with a laminate, the underside of the blade edge will have an unstained surface. This is predominantly noticeable with darker laminates. In this case, a square worksurface is recommended. When specifying with a veneer, the underside is stained the same color as the worksurface.

Select Surfaces

High-Pressure Laminate

Price Group 1

Textured Woodgrain Laminate

2TH2 Fawn Cypress
2TH3 Weathered Char
2TH4 Saddle Oak
2TH5 Veranda Teak
2TH6 Persian Cherry
2TH7 Walnut Heights

Price Group 2

Textured Industrial Laminate

2UH1 Reclaimed Aggregate
2UH2 Reclaimed Gravel
2UH4 Cement
2UH6 Sheetrock

Custom Surfaces

Open Line Laminate (OLL)

This service allows you to order non-standard laminate at an additional processing fee of \$69 per unit, plus the cost of the laminate.

High-Pressure Laminate pricing does not include premium or digitally printed patterns from any suppliers. Laminate cost may also vary for basic or standard laminates from other suppliers. Please contact the OLL consultant at 616.475.2426 for pricing. The cost of the laminate will be added to your invoice as a separate line on the acknowledgement.

When processing orders for Open Line laminate, specify 2900 in the laminate finish field and enter the OLL manufacturer information. Specify appropriate 2K finish number for the edge finish.

To confirm whether a particular laminate has already been tested for use on a specific Steelcase product or to determine material square foot requirements:

- Visit www.steelcase.com

For additional information, refer to the *Steelcase Surface Materials Reference Manual*.

Paint

► See *Surface Materials Reference Manual* for a listing of available paints for Victor2.

Tip: Not every paint color is available on every painted component.

Steelcase Surfaces

Price Group 1

Smooth Paint

4242 Milk

Textured Paint

7207 Black
7225 Sand
7236 Fog
7237 Slate
7238 Fieldstone
7239 Midnight
7241 Arctic White
7243 Seagull
7278 Dark Bronze
7360 Merle

Price Group 2

Smooth Metallic Paint

4728 Nickel Metallic
4743 Mineral Metallic
4744 Pearl Metallic
4750 Champagne Metallic
4752 Steel Metallic
4788 Gold Dust Metallic
4798 Sterling Metallic
4799 Platinum Metallic
4803 Near Black Metallic

Textured Metallic Paint

7245 Carbon Metallic
7246 Midnight Metallic

Applies to:

- 2½" round grommet

Price Group 1

Smooth Paint

7241 Arctic White
7278 Dark Bronze

Price Group 2

Standard Paint

0835 Black

Smooth Metallic Paint

4799 Platinum Metallic

Plastic

Steelcase Surfaces

Applies to:

- Plastic edge on worksurfaces

6000 Black
6001 Coffee
6009 Arctic White
6034 Natural Cherry
6036 Medium Cherry
6037 Winter on Maple
6038 Blonde on Maple
6041 Natural Walnut
6045 Medium Mahogany on Walnut

6052 Milk
6053 Seagull
6213 Acacia
6219 Clear Oak
6231 Graphite Walnut
6234 Clear Cherry
6237 Clear Maple
6242 Virginia Walnut
6243 Blackwood
6245 Clear Walnut

6246 Warm Oak
6249 Platinum Solid

6271 Plywood

6527 Merle

6615 Grey V5

6619 Ice

6631 Cream

6635 Dawn

6636 Mist

6654 Sand

6655 Warm White

6677 Chocolate Walnut

6694 Slate

6695 Midnight

6697 Fog

6698 Fieldstone

6703 Ash Wenge

6704 Storm Wenge

6705 Bisque Wenge

6706 Clay Wenge

6707 Ash Noce

6708 Bisque Noce

6709 Clay Noce

6710 Storm Noce

Applies to:

- Convenience communication outlet housing

- Convenience tri-receptacle

6000 Black

6009 Arctic White

6249 Platinum Solid

6651 Tungsten

6652 Titanium

6654 Sand

6681 Grotto

Select Surfaces

Applies to:

- Plastic edge on worksurfaces
- 6T02 Fawn Cypress
- 6T03 Weathered Char
- 6T04 Saddle Oak
- 6T05 Veranda Teak
- 6T06 Persian Cherry
- 6T07 Walnut Heights
- 6T08 Aggregate
- 6T09 Gravel
- 6T10 Cement
- 6T12 Sheetrock

Plated Metal**Steelcase Surfaces**

- 9201 Polished Chrome
- 9211 Nickel
- 9212 Silver
- 9250 Ember Chrome

Applies to:

- 2 1/2" round grommet
- 9201 Polished Chrome
- 9211 Nickel

Metal**Steelcase Surfaces**

- 4799 Platinum Metallic
- 8043 Clear Anodized Aluminum
- 8044 Black Anodized Aluminum
- 8046 Polished Aluminum

Glass**Steelcase Surfaces****Glass**

- 6580 Ice White

Back Painted Glass

- 6509 Mirrored Bronze*
- 6521 Truffle
- 6571 Aubergine
- 6575 Peacock
- 6576 Jungle
- 6577 Merlot
- 6578 Lagoon
- 6579 Saffron
- 6581 Blue Jay
- 6582 Wasabi
- 6583 Rose
- 6584 Tangerine
- 6585 Fuchsia
- 6586 Citrus Green
- 6587 Gold
- 6588 Purple Berry
- 6589 Mercury
- 6590 Black
- 6591 Merle
- 6592 Asphalt
- 6593 Greyscale
- 6594 Tan
- 6595 Winter
- 6597 Honey
- * 6509 Mirrored Bronze is not available on magnetic back painted glass

Vertical Surface Fabric

► See *Surface Materials Reference Manual* for a listing of available fabrics for Divisio side screen.

Steelcase Surfaces**Price Group 1****Abacus**

- P122 Entasis
- P123 Portico
- P124 Opus
- P125 Cusp
- P126 Artifact
- P129 Atlas

Alloy

- P525 Polar
- P526 Skim
- P527 Bubbly
- P528 Tern
- P529 Shore
- P530 Asti
- P531 Silver
- P532 Oxide
- P533 Element
- P534 Construct
- P535 Currency
- P536 Iron

Boccie

- P200 New Rice
- P201 New Almond
- P202 New Nutmeg
- P203 New Camel
- P204 New Opal
- P205 New Mist
- P206 New Plum
- P207 New Lichen
- P208 New Spearmint
- P209 New Sky

Buzz2

- 5F03 Tomato
- 5F04 Red
- 5F05 Burgundy
- 5F06 Sky
- 5F07 Blue
- 5F08 Navy
- 5F10 Grape
- 5F11 Eggplant
- 5F15 Stone
- 5F16 Grey
- 5F17 Black
- 5G50 Dunegrass
- 5G51 Sable
- 5G52 Barley
- 5G53 Sunrise
- 5G54 Carrot
- 5G55 Pumpkin
- 5G56 Timber
- 5G57 Rouge
- 5G58 Chocolate
- 5G59 Meadow
- 5G60 Ivy
- 5G61 Cyan
- 5G62 Atlantic
- 5G63 Crocus
- 5G64 Alpine
- 5G65 Tornado

Charm

- P505 Shell
- P506 Mimosa
- P507 Birch
- P508 Sparkle
- P509 Ginkgo
- P510 Debut
- P511 Clover
- P512 Spicy
- P513 Twilight

Lapel

- P409 Cement
- P410 Pebble
- P411 Beech
- P412 Dune
- P413 Grain
- P414 Sprout
- P415 Misty Blue
- P416 Maple
- P417 Slate

Optic

- P540 Hazel
- P541 Twinkle
- P542 Orion
- P543 Seaglass
- P544 Shine
- P545 Halo
- P546 Whiskey
- P547 Bath
- P548 Whisper
- P549 Breezy
- P550 Wry
- P551 Glimmer

Pianista

- P420 Sand
- P421 Mist
- P422 Rain
- P423 Natural
- P424 Café
- P425 Denim
- P426 Carbon
- P427 Stone
- P428 Flax
- P429 Oat
- P430 Wheat
- P431 Maize

Rhythm

- P555 Allegro
- P556 Tempo
- P557 Refrain
- P558 Pitch
- P559 Harmony
- P560 Melody
- P561 Stanza
- P562 Opus

Tinsel

- P516 Lit
- P517 Ego
- P518 Fizz
- P519 Muse
- P520 Depth
- P521 Bliss
- P522 Grow
- P523 Dolce

Price Group 2**Bariolage**

- G200 New Etude
- G201 New Andante
- G202 New Cantata
- G203 New Adagio
- G204 New Melody
- G205 New Ballata
- G206 New Sonata

Bouquet

- P165 Hosta
- P166 Dundee
- P169 Argenta
- P170 Hoya
- P173 Camomile

Code

- 5FA1 Fossil
- 5FA2 Gabbro
- 5FA3 Reed
- 5FA4 Bluff
- 5FA5 Sea Salt
- 5FA6 Cannon
- 5FA7 Tussah
- 5FA8 Mica
- 5FA9 Ecrú
- 5FB1 Bamboo

Flip: Orbit

- 5F85 Mud Pie
- 5F86 Hummus
- 5F87 Petoskey
- 5F88 Pluto
- 5F89 Papyrus
- 5F91 Blizzard
- 5F92 Briquette

Flip: TexHex

- 5F75 Mud Pie
- 5F76 Hummus
- 5F77 Petoskey
- 5F78 Pluto
- 5F79 Papyrus
- 5F97 Blizzard
- 5F98 Briquette

Fresco

- G001 Sandrift
- G002 Mistiblu
- G003 Faon
- G006 Chamoline
- G007 Grapenut
- G017 Flint

Latch

- P600 Seashell
- P601 Clam
- P602 Eggshell
- P603 Zen
- P604 Cool Gray
- P605 Armor
- P606 Sentinel
- P607 Rye
- P608 Billow
- P609 Nimbus

Milano

- N002 Delft
- N003 Woodland
- N004 Sunshadow
- N005 Olivine
- N012 Teakwood

Price Group 3**Billiard Multi-Use by****DesignTex**

- 5H10 Bone
- 5H11 Poppy
- 5H12 Tangelo
- 5H13 Citron
- 5H14 Avocado
- 5H15 Hunter
- 5H16 Indigo
- 5H17 Mallard
- 5H18 Teak
- 5H19 Cumulus
- 5H20 Pewter
- 5H21 Gunmetal
- 5H22 Ink

Select Surfaces

For information on products within Select Surfaces, including accent paints and fabrics from DesignTex and Pollack, please refer to the *Surface Materials Reference Manual* or visit www.steelcase.com/surface-materials under the Select Surface section.

Surface Materials, continued

Custom Surfaces

Price Group COM (Customer's Own Material)

Fabric Approval and Yardage

To confirm whether a particular COM material has already been tested for use on a specific Steelcase product or to determine actual yardage requirements:

- Visit www.steelcase.com

For additional information regarding Customer's Own Material, call 1.888.STEELCASE (1.888.783.3522) or send an e-mail to lineone@steelcase.com.

Seating Upholstery

▶ See *Surface Materials Reference Manual* for a listing of available fabrics for Divisio side screen.

▶ See *Surface Materials Reference Manual* for a listing of available upholstery colors.

Steelcase Surfaces

Price Group 1

- Buzz2
- Era
- Jacks
- Link
- Playground

Price Group 2

- Chainmail
- Cogent: Connect
- Cogent: Trails
- Nitelights
- Seating Vinyl
- Spyder
- Stand In

Price Group 3

- Billiard Multi-Use by Designtex
- Gaja – Cradle to Cradle Certified™ Silver
- Imperma
- Redeem
- Retrieve
- Texel

Price Group 5

- Bo Peep
- Remix
- Silk

Price Group 6

- Brisa

Price Group 7

- Steelcut Trio

Leather

- Steelcase Leather

Elmosoft Leather

- Elmosoft Leather

Select Surfaces

For information on products within Select Surfaces, including accent paints and fabrics from Designtex and Pollack, please refer to the *Surface Materials Reference Manual* or visit www.steelcase.com/surface-materials under the Select Surfaces section.

Custom Surfaces

Price Group COM (Customer's Own Material)

Fabric Approval and Yardage

To confirm whether a particular COM material has already been tested for use on a specific Steelcase product or to determine actual yardage requirements:

- Visit www.steelcase.com

For additional information regarding Customer's Own Material, call

1.888.STEELCASE (1.888.783.3522) or send an e-mail to lineone@steelcase.com.

Veneer Cut Guidelines

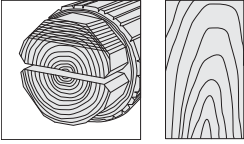

Flat Cut

Veneer is cut parallel to the flat side of the cant at a tangent to the growth rings of the tree. This produces a cathedral or oval pattern. On average, there is a 6-8" wide leaf width. On an 18" wide surface, there will likely be three leaves showing a repeated pattern.

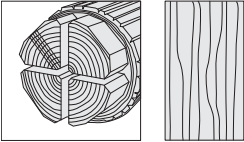

Quarter Cut

Veneer is cut from quarter sections of the log which are produced by cutting each cant in half. Cutting lines are at an angle of approximately 90 degrees to the growth rings at the center of the quarter. This produces a straight grain or ribbon pattern. On average, leaves are 2 1/2-4" wide.

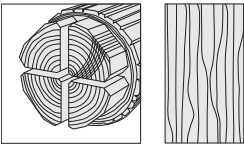

Rift Cut

This veneer cut is specifically for oak. Cutting lines are an arc approximately perpendicular to the growth rings. This produces a comb-like straight grain or ribbon pattern. On average, leaves are 2 1/2-4" wide.

Metal and Accessory Paint Matrix

Legend

- = Not available
- = Available
- = Available with exceptions
- ▶ See specification pages for details.

	Metal Finishes																
	0835 Black	4710 Low Gloss Black	4728 Nickel Metallic	4798 Sterling Metallic	4799 Platinum Metallic	4803 Near Black Metallic	7207 Black	7241 Arctic White	7243 Seagull	7278 Dark Bronze	7360 Merle	8043 Clear Anodized Aluminum	8044 Black Anodized Aluminum	9201 Polished Chrome	9211 Nickel	9212 Silver	9250 Ember Chrome
Locks	•	•	•	•	•	•	•	•	•	•	•	•	•	■	•	•	■
Contemporary pull	■	•	•	•	•	•	•	•	•	•	•	•	•	■	■	■	•
Jazz pull	■	•	•	•	■	•	•	•	•	•	•	•	•	■	■	■	•
Bar pull	■	•	•	•	•	•	•	•	•	•	•	•	•	■	■	■	•
Nile pull	■	•	•	•	■	•	•	•	•	■	•	•	•	■	■	•	•
Transitional pull	■	•	•	•	■	•	•	•	•	■	•	•	•	•	•	•	•
Inset pull	•	•	■	•	■	■	•	■	•	■	•	•	•	•	•	•	•
Beam pull	•	•	■	•	•	■	•	■	•	■	•	■	•	•	•	•	•
Round grommet	■	•	•	•	■	•	•	■	•	•	•	•	•	■	■	•	•
Square grommet	•	•	•	•	•	•	•	•	•	■	•	■	■	•	•	•	•
Square glass grommet frame	•	•	•	•	•	•	•	•	•	■	•	■	■	•	•	•	•
Rectangular column	•	•	■	•	•	■	•	■	•	■	•	■	•	•	•	•	•
Column	■	•	■	■	■	■	■	■	•	■	■	•	•	■	•	•	•
Disk column	•	•	■	•	■	■	■	■	•	■	■	•	•	•	•	•	•
Gate leg	•	•	■	•	■	■	•	■	•	■	•	•	•	•	•	•	•
Adjustable-height legs (lower leg)	•	•	■	•	•	■	•	■	•	■	•	•	•	•	•	•	•
Freestanding table base	•	•	•	•	■	•	■	•	•	•	■	•	•	•	•	•	•
Parallel slip-fit support	•	•	■	•	•	■	•	■	•	■	•	■	•	•	•	•	•
Storage leg	•	•	■	•	■	■	•	■	•	■	•	•	•	•	•	•	•
Side support frames	•	•	■	•	•	■	•	■	•	■	•	■	•	•	•	•	•
Hutch kits	•	•	■	•	•	■	•	■	•	■	•	■	•	•	•	•	•
Slatwall	■	•	•	•	•	•	•	■	•	•	•	■	•	•	•	•	•
Montage bracket for shelves and single-high overheads	•	■	•	■	■	•	•	•	•	•	•	•	•	•	•	•	•
Modesty hanging brackets	■	•	•	•	■	•	•	•	•	•	•	•	•	•	•	•	•
Steel back on glass modesty panel	•	•	■	•	■	■	•	■	•	■	•	•	•	•	•	•	•
Frame for glass doors	•	•	■	•	•	■	•	■	•	■	•	■	•	•	•	•	•
Blade accessory shelf	•	•	■	•	■	■	•	■	•	■	•	•	•	•	•	•	•
Metal shelf	•	•	■	•	■	■	•	■	•	■	•	•	•	•	•	•	•
Technology zone	•	•	■	•	•	■	•	■	•	■	•	■	•	•	•	•	•
Cable access cover	•	•	•	•	•	•	•	•	•	■	•	■	•	•	•	•	•
Power shroud	•	•	•	•	■	•	•	■	•	■	•	•	•	•	•	•	•
Metal light housing	•	•	•	•	•	•	■	■	•	•	•	•	•	•	•	•	•
Frame for magnetic back painted glass	•	•	■	•	•	■	•	■	•	■	•	■	•	•	•	•	•

Open Line Laminate Edge Coordination Matrix

For Plastic Edges

The colors of the plastic edges are determined by the 2K finish number selected.

2K Number Selection	Plastic Edge Color
2K00	6619 Ice
2K01	6245 Clear Walnut
2K03	6246 Warm Oak
2K04	6234 Clear Cherry
2K10	6041 Natural Walnut
2K15	6615 Grey V5
2K21	6036 Medium Cherry
2K22	6631 Cream
2K27	6034 Natural Cherry
2K28	Vellum Fiber Match
2K34	Novell Fiber Match
2K35	6697 Fog
2K36	6695 Midnight
2K37	6242 Virginia Walnut
2K38	6009 Arctic White
2K48	6654 Sand
2K49	6053 Seagull
2K50	6052 Milk
2K52	6249 Platinum Solid
2K59	6655 Warm White
2K60	Granite Fiber Match
2K65	6037 Winter on Maple
2K71	6045 Medium Mahogany on Walnut
2K73	Instant Iron Patina Match
2K74	6237 Clear Maple
2K75	6231 Graphite Walnut
2K78	6694 Slate
2K79	6698 Fieldstone
2K81	6038 Blonde on Maple
2K92	6000 Black
2K93	6001 Coffee
2K94	6635 Dawn
2K98	6636 Mist
2KAC	6213 Acacia
2KAK	6219 Clear Oak
2KAN	6707 Ash Noce
2KAW	6703 Ash Wenge
2KBL	6243 Blackwood
2KBN	6708 Bisque Noce
2KBW	6705 Bisque Wenge
2KCN	6709 Clay Noce

2K Number Selection	Plastic Edge Color
2KCW	6706 Clay Wenge
2KMI	6527 Merle
2KSN	6710 Storm Noce
2KSW	6704 Storm Wenge
Select Surfaces	
2KT2	6T02 Fawn Cypress
2KT3	6T03 Weathered Char
2KT4	6T04 Saddle Oak
2KT5	6T05 Veranda Teak
2KT6	6T06 Persian Cherry
2KT7	6T07 Walnut Heights
2KU1	6T08 Aggregate
2KU2	6T09 Gravel
2KU4	6T10 Cement
2KU6	6T12 Sheetrock

Tip: To improve consistency, default edge colors are now identified by 6000-series numbers; actual colors and defaults have not changed. Because default edge colors are not actually entered when specifying products, no specification changes are required. (Previous specification guides used 2000-series numbers to describe default edge colors, while 6000-series numbers were used for customer-specified edge colors, even though the edges were identical.)

▶ See the *Surface Materials Reference Manual* for more details.

Tip: Standard laminates being used in the Open Line laminate program to obtain a different edge detail will be charged the processing fee upcharge; however, no additional charges for the laminate will be applied.

Specification Guidelines for Vertical Fabric Applications

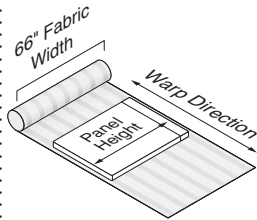

Warp horizontal means the height dimension of the tackboard is perpendicular to the warp of the fabric.

Application Topics

Tip: Fabric warp direction cannot be altered from standard on tackboards.

Customer's Own Material Yardage Requirements

Pre-approved fabrics are available. To determine if the fabric you want is on the pre-approved list, call a COM Consultant at 616.246.9822.

Surface Materials Representatives

are also available to answer your questions and to provide clarification. They can also help with situations where you are using fabrics under 66"W. Call 616.246.9822.

For further information regarding COM fabrics, refer to the *Steelcase Surface Materials Reference Manual*.

Additional fabric is required to accommodate flaws, wrinkles, and other imperfections.

Standard Warp Directions for Elective Elements Tackboards

Fabric	Storage	Tackboards
Abacus	D	H
Alloy	D	H
Bariolage	D	H
Billiard Multi-Use by Designtex	D	H
Boccie	D	H
Bouquet	D	H
Buzz2	D	H
Charm*	D	H
Flip: Orbit	D	HO
Flip: TexHex	D	HO
Fresco	D	H
Lapel	D	H
Latch	D	H
Milano	D	H
Optic	D	H
Pianista	D	HO
Rhythm	D	H
Tinsel*	D	H

- D = Directional
- H = Warp horizontal
- HO = Horizontal only
- ND = Non-directional

For Designtex Graded-In Cutting Direction, see *Surface Materials Reference Manual*.

*These fabrics have some color restrictions. Check the *Surface Materials Reference Manual* for color availability.

Color Coordination Matrix

1 mm plastic edge trim color

is defaulted and is determined by the laminate color you select for the worksurface. The edge trim color cannot be specified.

3 mm plastic edge trim color is specifiable. Refer to *Plastic* on page 568.

All laminates, except woodgrain laminates, will have solid color plastic edging.

Woodgrain laminates will have woodgrain plastic edges and the grain of the edges will be horizontal.

Laminate Color	Default 1 mm Plastic Color
Fiber	
2850 Vanadium Fiber	6654 Sand
2851 Rhyme Fiber	6631 Cream
2852 Tungsten Fiber	6636 Mist
2854 Vellum Fiber	Vellum Match
2859 Novell Fiber	Novell Match
2860 Granite Fiber	Granite Match
2861 Coconut Fiber	6654 Sand
2862 Stucco Fiber	6053 Seagull
Micro	
2920 Marl Micro	6053 Seagull
2921 Gypsum Micro	6654 Sand
2922 Clay Micro	6654 Sand
2923 Shadow Micro	6249 Platinum Solid
Patina	
2870 Blonde Bronze Patina	6654 Sand
2871 Blackened Bronze Patina	Blackened Bronze Match
2873 Instant Iron Patina	Instant Iron Match
Solid	
2722 Cream	6631 Cream
2730 Arctic White	6009 Arctic White
2746 Black	6000 Black
2759 Warm White	6655 Warm White
2811 Mist	6636 Mist
2883 Seagull	6053 Seagull
2884 Milk	6052 Milk
2885 Dune	6654 Sand
2HMG Merle	6527 Merle
Speckle	
2820 Coffee Speckle	6631 Cream
2822 Woodrose Speckle	6635 Dawn
2823 Driftwood Speckle	6631 Cream
2824 Smoke Speckle	6636 Mist
2825 Vanadium Speckle	6619 Ice

Tip: To improve consistency, default edge colors are now identified by 6000-series numbers; actual colors and defaults have not changed. Because default edge colors are not actually entered when specifying products, no specification changes are required. (Previous specification guides used 2000-series numbers to describe default edge colors, while 6000-series numbers were used for customer-specified edge colors, even though the edges were identical.)

► See the *Surface Materials Reference Manual* for more details.

1 mm plastic edge trim color

is defaulted and is determined by the laminate color you select for the worksurface. The edge trim color cannot be specified.

3 mm plastic edge trim color is specifiable. Refer to *Plastic* on page 568.

All laminates, except woodgrain laminates, will have solid color plastic edging.

Woodgrain laminates will have woodgrain plastic edges and the grain of the edges will be horizontal.

Laminate Color	Default 1 mm Plastic Color
Textured Woodgrain—Select Surfaces	
2TH2 Fawn Cypress	6T02 Fawn Cypress
2TH3 Weathered Char	6T03 Weathered Char
2TH4 Saddle Oak	6T04 Saddle Oak
2TH5 Veranda Teak	6T05 Veranda Teak
2TH6 Persian Cherry	6T06 Persian Cherry
2TH7 Walnut Heights	6T07 Walnut Heights
Textured Industrial—Select Surfaces	
2UH1 Reclaimed Aggregate	6T08 Aggregate
2UH2 Reclaimed Gravel	6T09 Gravel
2UH4 Cement	6T10 Cement
2UH6 Sheetrock	6T12 Sheetrock
Woodgrain	
2406 Clear Cherry	6234 Clear Cherry
2409 Clear Maple	6237 Clear Maple
2410 Graphite Walnut	6231 Graphite Walnut
2412 Natural Cherry	6034 Natural Cherry
2422 Medium Cherry	6036 Medium Cherry
2511 Winter on Maple	6037 Winter on Maple
2535 Virginia Walnut	6242 Virginia Walnut
2536 Blackwood	6243 Blackwood
2538 Clear Walnut	6245 Clear Walnut
2539 Warm Oak	6246 Warm Oak
2592 Blonde on Maple	6038 Blonde on Maple
2614 Chocolate Walnut	6677 Chocolate Walnut
2714 Natural Walnut	6041 Natural Walnut
2772 Medium Mahogany on Walnut	6045 Medium Mahogany on Walnut
2HAK Clear Oak	6219 Clear Oak
2HAN Ash Noce	6707 Ash Noce
2HAT Acacia	6213 Acacia
2HAW Ash Wenge	6703 Ash Wenge
2HBN Bisque Noce	6708 Bisque Noce
2HBW Bisque Wenge	6705 Bisque Wenge
2HCN Clay Noce	6709 Clay Noce
2HCW Clay Wenge	6706 Clay Wenge
2HSN Storm Noce	6710 Storm Noce
2HSW Storm Wenge	6704 Storm Wenge

Tip: To improve consistency, default edge colors are now identified by 6000-series numbers; actual colors and defaults have not changed. Because default edge colors are not actually entered when specifying products, no specification changes are required. (Previous specification guides used 2000-series numbers to describe default edge colors, while 6000-series numbers were used for customer-specified edge colors, even though the edges were identical.)

► See the *Surface Materials Reference Manual* for more details.

FlexFrame

► For more detailed product information, see the *FlexFrame Specification Guide*, or consult your Steelcase dealer.

Statement of Line	580
--------------------------	------------

Specifying

Configuration Options For Workwall Perimeter Frames	586
Workwall Perimeter Frames (SIN 711.1)	587
Inner Vertical Frame Pieces (SIN 711.1)	588
Double Shelves (SIN 711.1)	589
Single Shelves (SIN 711.1)	590
Bins and Drawers (SIN 711.1)	592
Skins (SIN 711.1)	594
Skins for Shelves and Bins (SIN 711.1)	596
TV Skins (SIN 711.1)	599
Cantilever Desk and Tables Attachment Skins (SIN 711.1)	600
Accessories (SIN 711.1)	602
Electrical (SIN 711.1)	603

Statement of Line

FlexFrame

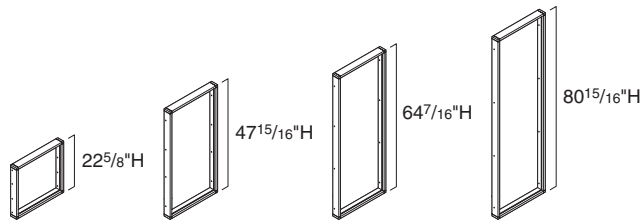

Specifying
▶ Page 587

Perimeter Frame Assemblies

	22 ⁵ / ₈ "H	47 ¹⁵ / ₁₆ "H	64 ⁷ / ₁₆ "H	80 ¹⁵ / ₁₆ "H
24 ⁷ / ₈ "W	●	●	●	●
30 ⁷ / ₈ "W	●	●	●	●
36 ⁷ / ₈ "W	●	●	●	●
48 ⁷ / ₈ "W	●	●	●	●
54 ⁷ / ₈ "W	●	●	●	●
60 ⁷ / ₈ "W	●	●	●	●
66 ⁷ / ₈ "W	●	●	●	●
72 ⁷ / ₈ "W	●	●	●	●
78 ⁷ / ₈ "W	●	●	●	●
84 ⁷ / ₈ "W	●	●	●	●
90 ⁷ / ₈ "W	●	●	●	●
96 ⁷ / ₈ "W	●	●	●	●
102 ⁷ / ₈ "W	●	●	●	●
108 ⁷ / ₈ "W	●	●	●	●
114 ⁷ / ₈ "W	●	●	●	●
120 ⁷ / ₈ "W	●	●	●	●
126 ⁷ / ₈ "W	●	●	●	●
132 ⁷ / ₈ "W	●	●	●	●
138 ⁷ / ₈ "W	●	●	●	●
144 ⁷ / ₈ "W	●	●	●	●

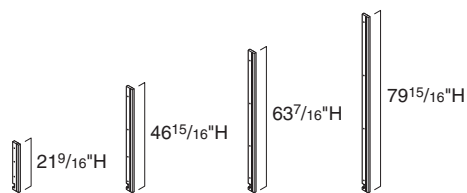

Specifying
▶ Page 588

Inner Vertical Frame Pieces

	21 ⁹ / ₁₆ "H	46 ¹⁵ / ₁₆ "H	63 ⁷ / ₁₆ "H	79 ¹⁵ / ₁₆ "H
7 ⁷ / ₈ "W	●	●	●	●

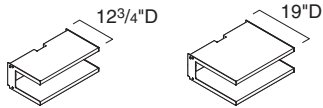

Specifying
▶ Page 589

8 1/4"H Double Shelves

	23 1/16"W	29 1/16"W	35 1/16"W
12 3/4"D	●	●	●
19"D	●	●	●

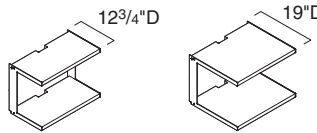

Specifying
▶ Page 589

16 1/2"H Double Shelves

	23 1/16"W	29 1/16"W	35 1/16"W
12 3/4"D	●	●	●
19"D	●	●	●

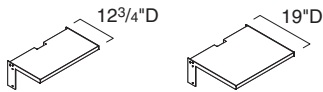

Specifying
▶ Page 590

8 1/4"H Upper Single Shelves

	23 1/16"W	29 1/16"W	35 1/16"W
12 3/4"D	●	●	●
19"D	●	●	●

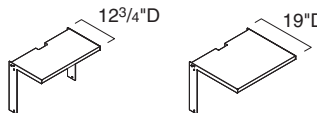

Specifying
▶ Page 590

16 1/2"H Upper Single Shelves

	23 1/16"W	29 1/16"W	35 1/16"W
12 3/4"D	●	●	●
19"D	●	●	●

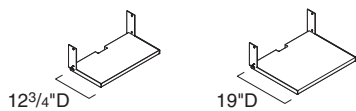

Specifying
▶ Page 590

8 1/4"H Lower Single Shelves

	23 1/16"W	29 1/16"W	35 1/16"W
12 3/4"D	●	●	●
19"D	●	●	●

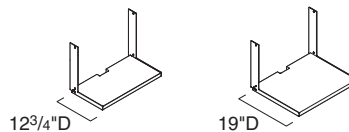

Specifying
▶ Page 590

16 1/2"H Lower Single Shelves

	23 1/16"W	29 1/16"W	35 1/16"W
12 3/4"D	●	●	●
19"D	●	●	●

Statement of Line, FlexFrame, continued

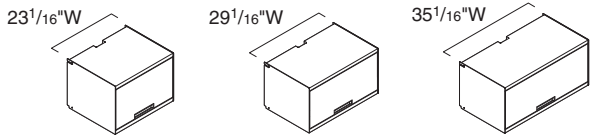

Specifying
▶ Page 592

16¹/₂"H Bins

	23 ¹ / ₁₆ "W	29 ¹ / ₁₆ "W	35 ¹ / ₁₆ "W
19"D	●	●	●

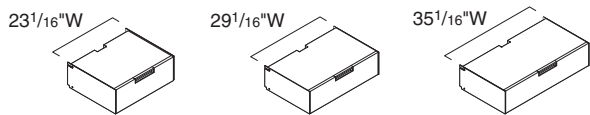

Specifying
▶ Page 592

8¹/₄"H Drawers

	23 ¹ / ₁₆ "W	29 ¹ / ₁₆ "W	35 ¹ / ₁₆ "W
19"D	●	●	●



Skin



Technology Skin



Cable Management Skin

Specifying
▶ Page 594

Skins

	23 ¹ / ₁₆ "W	29 ¹ / ₁₆ "W	35 ¹ / ₁₆ "W
8 ¹ / ₄ "H	●	●	●
16 ¹ / ₂ "H	● ▲ ■	● ▲ ■	● ▲ ■
33"H	●	●	●
49 ¹ / ₂ "H	●	●	●

- = Skin
- ▲ = Technology Skin
- = Cable Management Skin



Skin



Technology Skin



Cable Management Skin

Specifying
▶ Page 596

Skins for Double Shelves

	22 ¹¹ / ₁₆ "W	28 ¹¹ / ₁₆ "W	34 ¹¹ / ₁₆ "W
5 ³ / ₄ "H	●	●	●
14"H	● ▲ ■	● ▲ ■	● ▲ ■

- = Skin
- ▲ = Technology Skin
- = Cable Management Skin



Skin



Technology Skin



Cable Management Skin

Specifying
▶ Page 596

Skins for Single Shelves

	22 ¹¹ / ₁₆ "W	28 ¹¹ / ₁₆ "W	34 ¹¹ / ₁₆ "W
7"H	●	●	●
15 ¹ / ₄ "H	● ▲ ■	● ▲ ■	● ▲ ■

- = Skin
- ▲ = Technology Skin
- = Cable Management Skin



Skin



Cable Management Skin

Specifying
▶ Page 596

Skins for Bins

	22 ¹¹ / ₁₆ "W	28 ¹¹ / ₁₆ "W	34 ¹¹ / ₁₆ "W
14"H	● ■	● ■	● ■

- = Skin
- = Cable Management Skin



Specifying
▶ Page 599

TV Attachment Skin — Centered Application

	23 ¹ / ₁₆ "W	29 ¹ / ₁₆ "W	35 ¹ / ₁₆ "W
33"H	●	●	●

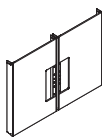

Specifying
▶ Page 599

TV Attachment Skin, Pair — Spanning Application

	23 ¹ / ₁₆ "W	29 ¹ / ₁₆ "W	35 ¹ / ₁₆ "W
33"H	●	●	●

Tip: Width dimension is per skin. Skins are sold in pairs.

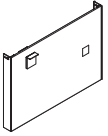

Specifying
▶ Page 600

Cantilever Desk Attachment Skins

35 $\frac{1}{16}$ "
24 $\frac{3}{4}$ "H ●

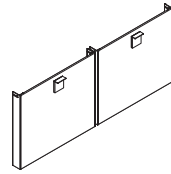

Specifying
▶ Page 600

Skin Pair for Cantilever Table Attachment

23 $\frac{1}{16}$ "	29 $\frac{1}{16}$ "	35 $\frac{1}{16}$ "
24 $\frac{3}{4}$ "H ●	●	●

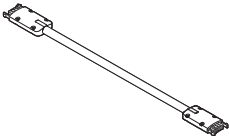

Modular Harness
Specifying
▶ Page 603

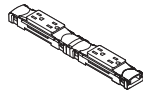

1-Circuit Receptacle Kit
Specifying
▶ Page 603

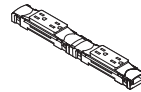

2-Circuit Receptacle Kit
Specifying
▶ Page 604

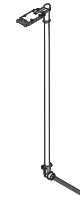

Hardwire Power Infeed
Specifying
▶ Page 604

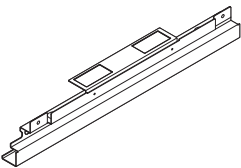

Workwall Base Power Tray
Specifying
▶ Page 604

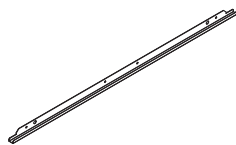

Workwall Wire Manager
Specifying
▶ Page 605

Configuration Options For Workwall Perimeter Frames



Legend

- = Not available
- = Available

▶ page 587 for specifying information.

Sections	Width of Perimeter Frames																			
	24 7/8"	30 7/8"	36 7/8"	48 7/8"	54 7/8"	60 7/8"	66 7/8"	72 7/8"	78 7/8"	84 7/8"	90 7/8"	96 7/8"	102 7/8"	108 7/8"	114 7/8"	120 7/8"	126 7/8"	132 7/8"	138 7/8"	144 7/8"
One 24"	■	•	•	•	•	•	•	•	•	•	•	•	•	•	•	•	•	•	•	•
One 30"	•	■	•	•	•	•	•	•	•	•	•	•	•	•	•	•	•	•	•	•
One 36"	•	•	■	•	•	•	•	•	•	•	•	•	•	•	•	•	•	•	•	•
Two 24"	•	•	•	■	•	•	•	•	•	•	•	•	•	•	•	•	•	•	•	•
One 24", one 30"	•	•	•	•	■	•	•	•	•	•	•	•	•	•	•	•	•	•	•	•
One 24", one 36"	•	•	•	•	•	■	•	•	•	•	•	•	•	•	•	•	•	•	•	•
Two 30"	•	•	•	•	•	•	■	•	•	•	•	•	•	•	•	•	•	•	•	•
One 30", one 36"	•	•	•	•	•	•	•	■	•	•	•	•	•	•	•	•	•	•	•	•
Two 36"	•	•	•	•	•	•	•	•	■	•	•	•	•	•	•	•	•	•	•	•
Three 24"	•	•	•	•	•	•	•	•	■	•	•	•	•	•	•	•	•	•	•	•
Two 24", one 30"	•	•	•	•	•	•	•	•	•	■	•	•	•	•	•	•	•	•	•	•
One 24", two 30"	•	•	•	•	•	•	•	•	•	•	■	•	•	•	•	•	•	•	•	•
Two 24", one 36"	•	•	•	•	•	•	•	•	•	•	■	•	•	•	•	•	•	•	•	•
Three 30"	•	•	•	•	•	•	•	•	•	•	•	■	•	•	•	•	•	•	•	•
One 24", one 30", one 36"	•	•	•	•	•	•	•	•	•	•	•	■	•	•	•	•	•	•	•	•
Two 30", one 36"	•	•	•	•	•	•	•	•	•	•	•	•	■	•	•	•	•	•	•	•
One 24", two 36"	•	•	•	•	•	•	•	•	•	•	•	•	•	■	•	•	•	•	•	•
One 30", two 36"	•	•	•	•	•	•	•	•	•	•	•	•	•	•	■	•	•	•	•	•
Three 36"	•	•	•	•	•	•	•	•	•	•	•	•	•	•	•	■	•	•	•	•
Four 24"	•	•	•	•	•	•	•	•	•	•	•	•	■	•	•	•	•	•	•	•
Three 24", one 30"	•	•	•	•	•	•	•	•	•	•	•	•	•	■	•	•	•	•	•	•
Three 24", one 36"	•	•	•	•	•	•	•	•	•	•	•	•	•	•	■	•	•	•	•	•
Two 24", two 30"	•	•	•	•	•	•	•	•	•	•	•	•	•	•	•	■	•	•	•	•
One 24", three 30"	•	•	•	•	•	•	•	•	•	•	•	•	•	•	•	•	■	•	•	•
Two 24", one 30", one 36"	•	•	•	•	•	•	•	•	•	•	•	•	•	•	•	•	■	•	•	•
Four 30"	•	•	•	•	•	•	•	•	•	•	•	•	•	•	•	•	•	■	•	•
Two 24", two 36"	•	•	•	•	•	•	•	•	•	•	•	•	•	•	•	•	•	■	•	•
One 24", two 30", one 36"	•	•	•	•	•	•	•	•	•	•	•	•	•	•	•	•	•	•	■	•
Three 30", one 36"	•	•	•	•	•	•	•	•	•	•	•	•	•	•	•	•	•	•	•	■
One 24", one 30", two 36"	•	•	•	•	•	•	•	•	•	•	•	•	•	•	•	•	•	•	•	■
One 24", three 36"	•	•	•	•	•	•	•	•	•	•	•	•	•	•	•	•	•	•	•	■
Two 30", two 36"	•	•	•	•	•	•	•	•	•	•	•	•	•	•	•	•	•	•	•	■
One 30", three 36"	•	•	•	•	•	•	•	•	•	•	•	•	•	•	•	•	•	•	•	■
Four 36"	•	•	•	•	•	•	•	•	•	•	•	•	•	•	•	•	•	•	•	■
Five 24"	•	•	•	•	•	•	•	•	•	•	•	•	■	•	•	•	•	•	•	•
Four 24", one 30"	•	•	•	•	•	•	•	•	•	•	•	•	•	•	•	■	•	•	•	•
Four 24", one 36"	•	•	•	•	•	•	•	•	•	•	•	•	•	•	•	•	■	•	•	•
Three 24", one 30", one 36"	•	•	•	•	•	•	•	•	•	•	•	•	•	•	•	•	•	■	•	•
Three 24", two 36"	•	•	•	•	•	•	•	•	•	•	•	•	•	•	•	•	•	•	■	•
One 24", four 30"	•	•	•	•	•	•	•	•	•	•	•	•	•	•	•	•	•	•	•	■
Six 24"	•	•	•	•	•	•	•	•	•	•	•	•	•	•	•	•	•	•	•	■

Workwall Perimeter Frames

SIN 711.1

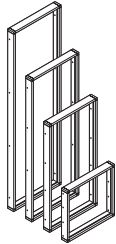

Standard Includes **Required to Specify**

- Workwall perimeter frame, 8043 Clear Anodized Aluminum 1 Style number
- Corner bracket: 4799 Platinum Metallic 2 Configuration option
- Wall attachment brackets

Required Selections (No Additional Cost) Required to Specify

- Configuration ▶ See Configuration Options, page 586.

Specification Information

Dimensions		22 ⁵ / ₈ "H		47 ¹⁵ / ₁₆ "H		64 ⁷ / ₁₆ "H		80 ¹⁵ / ₁₆ "H	
D	W	Style Number	Price	Style Number	Price	Style Number	Price	Style Number	Price

Workwall Perimeter Frames

3 ¹ / ₈ "	24 ⁷ / ₈ "	FFPF2224	\$ 722	FFPF4724	\$ 843	FFPF6424	\$ 995	FFPF8024	\$1146
3 ¹ / ₈ "	30 ⁷ / ₈ "	FFPF2230	\$ 744	FFPF4730	\$ 866	FFPF6430	\$1018	FFPF8030	\$1171
3 ¹ / ₈ "	36 ⁷ / ₈ "	FFPF2236	\$ 768	FFPF4736	\$ 889	FFPF6436	\$1042	FFPF8036	\$1193
3 ¹ / ₈ "	48 ⁷ / ₈ "	FFPF2248	\$ 791	FFPF4748	\$ 912	FFPF6448	\$1064	FFPF8048	\$1218
3 ¹ / ₈ "	54 ⁷ / ₈ "	FFPF2254	\$ 814	FFPF4754	\$ 936	FFPF6454	\$1088	FFPF8054	\$1240
3 ¹ / ₈ "	60 ⁷ / ₈ "	FFPF2260	\$ 838	FFPF4760	\$ 960	FFPF6460	\$1111	FFPF8060	\$1263
3 ¹ / ₈ "	66 ⁷ / ₈ "	FFPF2266	\$ 860	FFPF4766	\$ 983	FFPF6466	\$1135	FFPF8066	\$1287
3 ¹ / ₈ "	72 ⁷ / ₈ "	FFPF2272	\$ 885	FFPF4772	\$1007	FFPF6472	\$1160	FFPF8072	\$1310
3 ¹ / ₈ "	78 ⁷ / ₈ "	FFPF2278	\$ 908	FFPF4778	\$1030	FFPF6478	\$1182	FFPF8078	\$1336
3 ¹ / ₈ "	84 ⁷ / ₈ "	FFPF2284	\$ 932	FFPF4784	\$1054	FFPF6484	\$1205	FFPF8084	\$1357
3 ¹ / ₈ "	90 ⁷ / ₈ "	FFPF2290	\$ 955	FFPF4790	\$1077	FFPF6490	\$1229	FFPF8090	\$1382
3 ¹ / ₈ "	96 ⁷ / ₈ "	FFPF2296	\$ 977	FFPF4796	\$1101	FFPF6496	\$1253	FFPF8096	\$1404
3 ¹ / ₈ "	102 ⁷ / ₈ "	FFPF22102	\$1001	FFPF47102	\$1123	FFPF64102	\$1276	FFPF80102	\$1428
3 ¹ / ₈ "	108 ⁷ / ₈ "	FFPF22108	\$1024	FFPF47108	\$1146	FFPF64108	\$1299	FFPF80108	\$1452
3 ¹ / ₈ "	114 ⁷ / ₈ "	FFPF22114	\$1050	FFPF47114	\$1171	FFPF64114	\$1322	FFPF80114	\$1474
3 ¹ / ₈ "	120 ⁷ / ₈ "	FFPF22120	\$1073	FFPF47120	\$1193	FFPF64120	\$1346	FFPF80120	\$1499
3 ¹ / ₈ "	126 ⁷ / ₈ "	FFPF22126	\$1095	FFPF47126	\$1218	FFPF64126	\$1369	FFPF80126	\$1521
3 ¹ / ₈ "	132 ⁷ / ₈ "	FFPF22132	\$1119	FFPF47132	\$1240	FFPF64132	\$1393	FFPF80132	\$1545
3 ¹ / ₈ "	138 ⁷ / ₈ "	FFPF22138	\$1142	FFPF47138	\$1263	FFPF64138	\$1416	FFPF80138	\$1568
3 ¹ / ₈ "	144 ⁷ / ₈ "	FFPF22144	\$1166	FFPF47144	\$1287	FFPF64144	\$1439	FFPF80144	\$1591

Tip: Inner vertical frame pieces must be ordered separately to create sections within the workwall perimeter frame. The exception is 24⁷/₈", 30⁷/₈", and 36⁷/₈" do not use an inner vertical frame piece.

Tip: Spacer brackets are shipped with workwall perimeter frame to provide accurate spacing for inner vertical frame pieces.



Inner Vertical Frame Pieces

SIN 711.1

Tip: Height of inner vertical frame pieces must coincide with height of workwall perimeter frame.

Standard Includes	Required to Specify
-------------------	---------------------

- | | |
|---|--|
| <ul style="list-style-type: none"> • Inner vertical frame, 8043 Clear Anodized Aluminum • Attachment hardware | <ul style="list-style-type: none"> • Style number |
|---|--|

Specification Information

• Dimensions			• Style	• Price
D	W	H	Number	

For Use with 22⁵/₈"H Workwall Perimeter Frames

3 ¹ / ₈ "	7/8"	21 ⁹ / ₁₆ "	FFVF21	\$282
---------------------------------	------	-----------------------------------	---------------	-------

For Use with 47¹⁵/₁₆"H Workwall Perimeter Frames

3 ¹ / ₈ "	7/8"	46 ¹⁵ / ₁₆ "	FFVF46	\$351
---------------------------------	------	------------------------------------	---------------	-------

For Use with 64⁷/₁₆"H Workwall Perimeter Frames

3 ¹ / ₈ "	7/8"	63 ⁷ / ₁₆ "	FFVF63	\$439
---------------------------------	------	-----------------------------------	---------------	-------

For Use with 80¹⁵/₁₆"H Workwall Perimeter Frames

3 ¹ / ₈ "	7/8"	79 ¹⁵ / ₁₆ "	FFVF79	\$527
---------------------------------	------	------------------------------------	---------------	-------

Tip: Spacer brackets are shipped with workwall perimeter frame to provide accurate spacing for inner vertical frame pieces.

Tip: Number of inner vertical frame pieces needed is determined during specification of configurations for workwall perimeter frame.

Double Shelves

SIN 711.1

Tip: Skins can be applied between upper and lower shelves. Specify skins for use with double shelves.

Tip: Shelves are assembled in the field.

Tip: Specify a wire cut-out cover when a skin is not specified above the top shelf and between the shelves.

Standard Includes		Required to Specify	
	<ul style="list-style-type: none"> Shelf: Low-Pressure Laminate or wood group 1 Blades: painted metal Wire management cut-out 		<ul style="list-style-type: none"> 1 Style number 2 Finish color number for shelf 3 Paint color number for blades 4 Options, if selected (see below) ▶ See <i>Surface Materials</i>, page 608.
Options	Price	Required to Specify	
Surface Materials	<ul style="list-style-type: none"> Wood group 2 Wood group 3 Customiz stain 	Prices below Prices below No cost	Specify wood color number. Specify wood color number. Specify with <i>Customiz stain</i> . ▶ See <i>Surface Materials Reference Manual</i>
Wire Management Cut-out	<ul style="list-style-type: none"> Delete wire management cut-out 	No cost	Specify with <i>no cut-out</i> .
LED Lights	<ul style="list-style-type: none"> One shelf with lights Two shelves with lights 	Prices below Prices below	Specify with <i>1 shelf with lights</i> . Specify with <i>2 shelves with lights</i> .
Related Products	<ul style="list-style-type: none"> Skins for shelves Wire management cut-out cover 		▶ Page 596 ▶ Page 602

Specification Information									
Dimensions			Style Number	Base Prices		Options (Add \$ to Base Price)			
D	W	H		LPL	Wood Group 1	Wood Group 2	Wood Group 3	One Shelf With Lights	Two Shelves With Lights
12 ³ / ₄ "	23 ¹ / ₁₆ "	8 ¹ / ₄ "	FFSH12238C	\$445	\$638	+\$47	+\$164	+\$235	+\$470
12 ³ / ₄ "	29 ¹ / ₁₆ "	8 ¹ / ₄ "	FFSH12298C	\$470	\$673	+\$69	+\$242	+\$263	+\$526
12 ³ / ₄ "	35 ¹ / ₁₆ "	8 ¹ / ₄ "	FFSH12358C	\$495	\$708	+\$69	+\$242	+\$292	+\$584
12 ³ / ₄ "	23 ¹ / ₁₆ "	16 ¹ / ₂ "	FFSH122316C	\$509	\$726	+\$47	+\$164	+\$235	+\$470
12 ³ / ₄ "	29 ¹ / ₁₆ "	16 ¹ / ₂ "	FFSH122916C	\$534	\$762	+\$69	+\$242	+\$263	+\$526
12 ³ / ₄ "	35 ¹ / ₁₆ "	16 ¹ / ₂ "	FFSH123516C	\$556	\$795	+\$69	+\$242	+\$292	+\$584
19"	23 ¹ / ₁₆ "	8 ¹ / ₄ "	FFSH19238C	\$527	\$754	+\$69	+\$242	+\$235	+\$470
19"	29 ¹ / ₁₆ "	8 ¹ / ₄ "	FFSH19298C	\$552	\$790	+\$69	+\$242	+\$263	+\$526
19"	35 ¹ / ₁₆ "	8 ¹ / ₄ "	FFSH19358C	\$578	\$825	+\$96	+\$335	+\$292	+\$584
19"	23 ¹ / ₁₆ "	16 ¹ / ₂ "	FFSH192316C	\$591	\$843	+\$69	+\$242	+\$235	+\$470
19"	29 ¹ / ₁₆ "	16 ¹ / ₂ "	FFSH192916C	\$615	\$878	+\$69	+\$242	+\$263	+\$526
19"	35 ¹ / ₁₆ "	16 ¹ / ₂ "	FFSH193516C	\$639	\$912	+\$96	+\$335	+\$292	+\$584

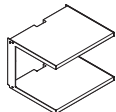
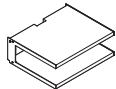
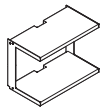
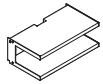

Single Shelves

SIN 711.1

Tip: Shelves are assembled in the field.

Standard Includes	Required to Specify
<ul style="list-style-type: none"> Shelf: Low-Pressure Laminate or wood group 1 Blades: painted metal Wire management cut-out 	<ul style="list-style-type: none"> 1 Style number 2 Finish color number for shelf 3 Paint color number for blades 4 Options, if selected (see below) ▶ See <i>Surface Materials</i>, page 608.

Options	Price	Required to Specify
Surface Materials <ul style="list-style-type: none"> Wood group 2 Wood group 3 Customiz stain 	Prices below and at right Prices below and at right No cost	Specify wood color number. Specify wood color number. Specify with <i>Customiz stain</i> . ▶ See <i>Surface Materials Reference Manual</i>
Wire Management Cut-out <ul style="list-style-type: none"> Delete wire management cut-out 	No cost	Specify with <i>no cut-out</i> .
LED Lights <ul style="list-style-type: none"> One shelf with lights 	Prices below and at right	Specify with <i>1 shelf with lights</i> .
Related Products <ul style="list-style-type: none"> Skins for shelves Wire management cut-out cover 		▶ Page 596 ▶ Page 602

Tip: A light kit must be specified when ordering lights.

Tip: Skins can be applied directly below shelf. Specify skin for use with single shelf.

Tip: Specify a wire cut-out cover when a skin is not specified above the shelf.

Specification Information								
Dimensions			Style Number	Base Prices		Options		
D	W	H		LPL	Wood Group 1	Wood Group 2	Wood Group 3	
								One Shelf With Lights

Upper Shelves

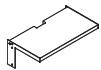

12 ³ / ₄ "	23 ¹ / ₁₆ "	8 ¹ / ₄ "	FFSH12238U	\$233	\$333	+\$28	+\$ 94	+\$235
12 ³ / ₄ "	29 ¹ / ₁₆ "	8 ¹ / ₄ "	FFSH12298U	\$244	\$351	+\$28	+\$ 94	+\$263
12 ³ / ₄ "	35 ¹ / ₁₆ "	8 ¹ / ₄ "	FFSH12358U	\$258	\$370	+\$47	+\$164	+\$292

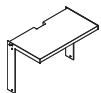

12 ³ / ₄ "	23 ¹ / ₁₆ "	16 ¹ / ₂ "	FFSH122316U	\$252	\$362	+\$28	+\$ 94	+\$235
12 ³ / ₄ "	29 ¹ / ₁₆ "	16 ¹ / ₂ "	FFSH122916U	\$265	\$380	+\$28	+\$ 94	+\$263
12 ³ / ₄ "	35 ¹ / ₁₆ "	16 ¹ / ₂ "	FFSH123516U	\$279	\$398	+\$47	+\$164	+\$292

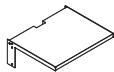

19"	23 ¹ / ₁₆ "	8 ¹ / ₄ "	FFSH19238U	\$274	\$392	+\$47	+\$164	+\$235
19"	29 ¹ / ₁₆ "	8 ¹ / ₄ "	FFSH19298U	\$287	\$410	+\$47	+\$164	+\$263
19"	35 ¹ / ₁₆ "	8 ¹ / ₄ "	FFSH19358U	\$299	\$427	+\$47	+\$164	+\$292

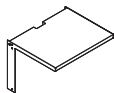

19"	23 ¹ / ₁₆ "	16 ¹ / ₂ "	FFSH192316U	\$294	\$420	+\$47	+\$164	+\$235
19"	29 ¹ / ₁₆ "	16 ¹ / ₂ "	FFSH192916U	\$307	\$439	+\$47	+\$164	+\$263
19"	35 ¹ / ₁₆ "	16 ¹ / ₂ "	FFSH193516U	\$321	\$457	+\$47	+\$164	+\$292

▶ Specification Information, continued on next page

► Specification Information, continued from previous page

Tip: Skins can be applied directly above shelf. Specify skin for use with single shelf.

Specification Information									
Dimensions			Style Number	Base Prices		Options (Add \$ to Base Price)			
D	W	H		LPL	Wood Group 1	Wood Group 2	Wood Group 3	One Shelf	With Lights

Lower Shelves

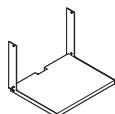
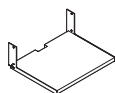
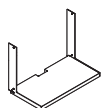
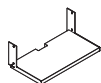

12 ³ / ₄ "	23 ¹ / ₁₆ "	8 ¹ / ₄ "	FFSH12238W	\$233	\$333	+\$28	+\$ 94	+\$235
12 ³ / ₄ "	29 ¹ / ₁₆ "	8 ¹ / ₄ "	FFSH12298W	\$244	\$351	+\$28	+\$ 94	+\$263
12 ³ / ₄ "	35 ¹ / ₁₆ "	8 ¹ / ₄ "	FFSH12358W	\$258	\$370	+\$47	+\$164	+\$292
12 ³ / ₄ "	23 ¹ / ₁₆ "	16 ¹ / ₂ "	FFSH122316W	\$252	\$362	+\$28	+\$ 94	+\$235
12 ³ / ₄ "	29 ¹ / ₁₆ "	16 ¹ / ₂ "	FFSH122916W	\$265	\$380	+\$28	+\$ 94	+\$263
12 ³ / ₄ "	35 ¹ / ₁₆ "	16 ¹ / ₂ "	FFSH123516W	\$279	\$398	+\$47	+\$164	+\$292
19"	23 ¹ / ₁₆ "	8 ¹ / ₄ "	FFSH19238W	\$274	\$392	+\$47	+\$164	+\$235
19"	29 ¹ / ₁₆ "	8 ¹ / ₄ "	FFSH19298W	\$287	\$410	+\$47	+\$164	+\$263
19"	35 ¹ / ₁₆ "	8 ¹ / ₄ "	FFSH19358W	\$299	\$427	+\$47	+\$164	+\$292
19"	23 ¹ / ₁₆ "	16 ¹ / ₂ "	FFSH192316W	\$294	\$420	+\$47	+\$164	+\$235
19"	29 ¹ / ₁₆ "	16 ¹ / ₂ "	FFSH192916W	\$307	\$439	+\$47	+\$164	+\$263
19"	35 ¹ / ₁₆ "	16 ¹ / ₂ "	FFSH193516W	\$321	\$457	+\$47	+\$164	+\$292

Bins and Drawers

SIN 711.1

Standard Includes	Required to Specify
-------------------	---------------------

- | | |
|--|---|
| <ul style="list-style-type: none"> • Bins or drawers: Low-Pressure Laminate or wood group 1 • Pull: painted metal • Blades: painted metal | <ol style="list-style-type: none"> 1 Style number 2 Finish color number for shelf 3 Paint color number for blades 4 Finish color number for pull <p>▶ See <i>Surface Materials</i>, page 608.</p> |
|--|---|

Options	Price	Required to Specify
---------	-------	---------------------

Surface Materials <ul style="list-style-type: none"> • Wood group 2 • Wood group 3 • Customiz stain 	Prices below Prices below No cost	Specify wood color number. Specify wood color number. Specify with <i>Customiz stain</i> . ▶ See <i>Surface Materials Reference Manual</i>
Wood Veneer Grain Direction <ul style="list-style-type: none"> • Horizontal grain direction on fronts • Vertical grain direction on fronts 	No cost No cost	Specify with <i>horizontal application</i> . Specify with <i>vertical application</i> .
Wire Management Cut-out <ul style="list-style-type: none"> • Delete wire management cut-out 	No cost	Specify with <i>no cut-out</i> .
LED Lights <ul style="list-style-type: none"> • One shelf light 	Prices below	Specify with <i>1 shelf with lights</i> .
Related Products <ul style="list-style-type: none"> • Skins for shelves • Wire management cut-out cover 		▶ Page 596 ▶ Page 602

Tip: A light kit must be specified when ordering lights.

Tip: Skins can be used in a bin. Specify skin for use with bin.

Tip: Specify a cable management skin when putting receptacles behind a bin.

Tip: Specify a wire cut-out cover when a skin is not specified above the shelf.

Specification Information

Dimensions			Style Number	Base Prices		Options		
D	W	H		LPL	Wood Group 1	Wood Group 2	Wood Group 3	
.....
.....

(Add \$ to Base Price)
 Wood : One Shelf
 Wood : With Lights

Bins

19"	23 ¹ / ₁₆ "	16 ¹ / ₂ "	FFSH192316B	\$ 978	\$1398	+\$ 69	+\$242	+\$235
19"	29 ¹ / ₁₆ "	16 ¹ / ₂ "	FFSH192916B	\$1001	\$1433	+\$ 96	+\$335	+\$263
19"	35 ¹ / ₁₆ "	16 ¹ / ₂ "	FFSH193516B	\$1030	\$1469	+\$124	+\$436	+\$292

Drawers

19"	23 ¹ / ₁₆ "	8 ¹ / ₄ "	FFSH19238D	\$610	\$873	+\$ 47	+\$164	+\$235
19"	29 ¹ / ₁₆ "	8 ¹ / ₄ "	FFSH19298D	\$635	\$907	+\$ 69	+\$242	+\$263
19"	35 ¹ / ₁₆ "	8 ¹ / ₄ "	FFSH19358D	\$660	\$942	+\$ 69	+\$242	+\$292

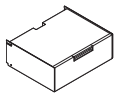
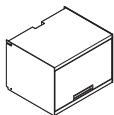

Tip: Receptacle kits can not be used behind a drawer.



Skins

SIN 711.1



Tip: These skins are not for use with shelves and bins. See skins for shelves and bins to specify, page 596.

Tip: Skins come standard with blades.

Standard Includes	Required to Specify
<ul style="list-style-type: none"> • Skin: fabric, Low-Pressure Laminate, glass, or wood group 1 • Blades: painted metal 	<ol style="list-style-type: none"> 1 Style number 2 Finish color number for skin 3 Paint color number for blades 4 Power unit configuration on technology skins, if selected 5 Power unit type on technology skins, if selected 6 Options, if selected (see below) <p>▶ See <i>Surface Materials</i>, page 608.</p>

Options	Price	Required to Specify
Surface Materials Horizontal or vertical application <ul style="list-style-type: none"> • Fabric price group A • Fabric price group 1 • Fabric price group 2 • Fabric price group 3 • Fabric price group 4 • Fabric price group 5 • Fabric price group 6 • Fabric price group 7 • Fabric price group COM • Wood group 2 • Wood group 3 • Customiz stain 	No cost No cost No cost +\$ 27 +\$ 48 +\$ 77 +\$120 +\$165 +\$208 +\$ 16 Prices at right Prices at right No cost	Specify <i>with horizontal or vertical application</i> . Specify fabric color number. Specify fabric color number. Specify fabric color number. Specify fabric color number. Specify fabric color number. Specify fabric color number. Specify fabric color number. Specify fabric color number. Specify fabric color number. Specify wood color number. Specify wood color number. Specify <i>with Customiz stain</i> . ▶ See <i>Surface Materials Reference Manual</i>
Wood Veneer Grain Direction <ul style="list-style-type: none"> • Horizontal grain direction • Vertical grain direction 	No cost No cost	Specify <i>with horizontal application</i> . Specify <i>with vertical application</i> .
Power Unit Configuration On Technology Skins <ul style="list-style-type: none"> • Data/Power/Power • Data/Power/Switch 	No cost No cost	Specify <i>with Data/Power/Power</i> . Specify <i>with Data/Power/Switch</i> .
Power Unit Type on Technology Skins <ul style="list-style-type: none"> • Corded • Hardwire • Modular 	No cost No cost No cost	Specify <i>with corded</i> . Specify <i>with hardwire</i> . Specify <i>with modular</i> .

SIN 711.1

Specification Information

Dimensions		Style Number	Base Prices				Options (Add \$ to Base Price)		
W	H		Fabric	LPL	Wood Group 1	Glass	Wood Group 2	Wood Group 3	

8 1/4" High Skins

23 1/16"	8 1/4"	FFKK238	\$220	\$237	\$338	N.A.	+\$55	+\$196
29 1/16"	8 1/4"	FFKK298	\$227	\$243	\$348	N.A.	+\$55	+\$196
35 1/16"	8 1/4"	FFKK358	\$235	\$251	\$360	N.A.	+\$55	+\$196

16 1/2" High Skins

23 1/16"	16 1/2"	FFKK2316	\$244	\$261	\$373	N.A.	+\$55	+\$196
29 1/16"	16 1/2"	FFKK2916	\$250	\$269	\$384	N.A.	+\$55	+\$196
35 1/16"	16 1/2"	FFKK3516	\$259	\$278	\$396	N.A.	+\$55	+\$196

33" High Skins

23 1/16"	33"	FFKK2333	\$264	\$285	\$406	\$ 732	+\$93	+\$328
29 1/16"	33"	FFKK2933	\$273	\$295	\$420	\$ 792	+\$93	+\$328
35 1/16"	33"	FFKK3533	\$279	\$302	\$431	\$ 847	+\$93	+\$328

49 1/2" High Skins

23 1/16"	49 1/2"	FFKK2349	\$285	\$308	\$440	\$ 866	+\$93	+\$328
29 1/16"	49 1/2"	FFKK2949	\$295	\$319	\$454	\$ 923	+\$93	+\$328
35 1/16"	49 1/2"	FFKK3549	\$303	\$328	\$467	\$1041	+\$93	+\$328

Technology Skins

23 1/16"	16 1/2"	FFKK2316T	\$595	\$612	\$724	N.A.	+\$55	+\$196
29 1/16"	16 1/2"	FFKK2916T	\$601	\$620	\$735	N.A.	+\$55	+\$196
35 1/16"	16 1/2"	FFKK3516T	\$610	\$629	\$747	N.A.	+\$55	+\$196

Cable Management Skins

23 1/16"	16 1/2"	FFKK2316M	\$361	\$378	\$490	N.A.	+\$55	+\$196
29 1/16"	16 1/2"	FFKK2916M	\$367	\$386	\$501	N.A.	+\$55	+\$196
35 1/16"	16 1/2"	FFKK3516M	\$376	\$395	\$513	N.A.	+\$55	+\$196

Skins For Shelves and Bins

SIN 711.1

Tip: These skins are only for use with shelves and bins.

Tip: Skins do not have blades. Blades are standard on shelves and bins.

Standard Includes	Required to Specify
<ul style="list-style-type: none"> • Skin: fabric, Low-Pressure Laminate, glass, or wood group 1 • Blades: painted metal 	<ol style="list-style-type: none"> 1 Style number 2 Finish color number for skin 3 Paint color number for blades 4 Power unit configuration on technology skins, if selected 5 Power unit type on technology skins, if selected 6 Options, if selected (see below) <p>▶ See <i>Surface Materials</i>, page 608.</p>

Options	Price	Required to Specify
Surface Materials Horizontal or vertical application <ul style="list-style-type: none"> • Fabric price group A • Fabric price group 1 • Fabric price group 2 • Fabric price group 3 • Fabric price group 4 • Fabric price group 5 • Fabric price group 6 • Fabric price group 7 • Fabric price group COM • Wood group 2 • Wood group 3 • Customiz stain 	No cost No cost No cost +\$ 27 +\$ 48 +\$ 77 +\$120 +\$165 +\$208 +\$ 16 Prices below and at right Prices below and at right No cost	Specify <i>with horizontal or vertical application</i> . Specify fabric color number. Specify fabric color number. Specify fabric color number. Specify fabric color number. Specify fabric color number. Specify fabric color number. Specify fabric color number. Specify fabric color number. Specify wood color number. Specify <i>with Customiz stain</i> . ▶ See <i>Surface Materials Reference Manual</i>
Wood Veneer Grain Direction <ul style="list-style-type: none"> • Horizontal grain direction • Vertical grain direction 	No cost No cost	Specify <i>with horizontal application</i> . Specify <i>with vertical application</i> .
Power Unit Configuration On Technology Skins <ul style="list-style-type: none"> • Data/Power/Power • Data/Power/Switch 	No cost No cost	Specify <i>with Data/Power/Power</i> . Specify <i>with Data/Power/Switch</i> .
Power Unit Type on Technology Skins <ul style="list-style-type: none"> • Corded • Hardwire • Modular 	No cost No cost No cost	Specify <i>with corded</i> . Specify <i>with hardwire</i> . Specify <i>with modular</i> .

Specification Information				
• Dimensions		• Style	• Base	• Options
W	H	Number	Prices	(Add \$ to Base Price)
.....
.....	Fabric : LPL : Wood : Wood	Wood
.....	Wood : Wood
.....	Group 1 : Group 2 : Group 3

Skins For 8¹/₄"H Double Shelves

22 ¹¹ / ₁₆ "	5 ³ / ₄ "	FFKD225	\$173	\$190	\$291	+\$55	+\$196
28 ¹¹ / ₁₆ "	5 ³ / ₄ "	FFKD285	\$180	\$196	\$301	+\$55	+\$196
34 ¹¹ / ₁₆ "	5 ³ / ₄ "	FFKD345	\$188	\$204	\$313	+\$55	+\$196

▶ **Specification Information, continued on next page**

► Specification Information, continued from previous page

Specification Information

Dimensions		Style Number	Base Prices			Options (Add \$ to Base Price)	
W	H		Fabric	LPL	Wood Group 1	Wood Group 2	Wood Group 3

Skins For 16¹/₂"H Double Shelves

22 ¹ / ₁₆ "	14"	FFKD2214	\$197	\$214	\$326	+\$55	+\$196
28 ¹ / ₁₆ "	14"	FFKD2814	\$203	\$222	\$337	+\$55	+\$196
34 ¹ / ₁₆ "	14"	FFKD3414	\$212	\$231	\$349	+\$55	+\$196

Technology Skins For 16¹/₂"H Double Shelves

22 ¹ / ₁₆ "	14"	FFKD2214T	\$548	\$565	\$677	+\$55	+\$196
28 ¹ / ₁₆ "	14"	FFKD2814T	\$554	\$573	\$688	+\$55	+\$196
34 ¹ / ₁₆ "	14"	FFKD3414T	\$563	\$582	\$700	+\$55	+\$196

Cable Management Skins For 16¹/₂"H Double Shelves

22 ¹ / ₁₆ "	14"	FFKD2214M	\$314	\$331	\$443	+\$55	+\$196
28 ¹ / ₁₆ "	14"	FFKD2814M	\$320	\$339	\$454	+\$55	+\$196
34 ¹ / ₁₆ "	14"	FFKD3414M	\$329	\$348	\$466	+\$55	+\$196

Skins For 8¹/₄"H Single Shelves

22 ¹ / ₁₆ "	7"	FFKS227	\$173	\$190	\$291	+\$55	+\$196
28 ¹ / ₁₆ "	7"	FFKS287	\$180	\$196	\$301	+\$55	+\$196
34 ¹ / ₁₆ "	7"	FFKS347	\$188	\$204	\$313	+\$55	+\$196

Skins For 16¹/₂"H Single Shelves

22 ¹ / ₁₆ "	15 ¹ / ₄ "	FFKS2215	\$197	\$214	\$326	+\$55	+\$196
28 ¹ / ₁₆ "	15 ¹ / ₄ "	FFKS2815	\$203	\$222	\$337	+\$55	+\$196
34 ¹ / ₁₆ "	15 ¹ / ₄ "	FFKS3415	\$212	\$231	\$349	+\$55	+\$196

Technology Skins For 16¹/₂"H Single Shelves

22 ¹ / ₁₆ "	15 ¹ / ₄ "	FFKS2215T	\$548	\$565	\$677	+\$55	+\$196
28 ¹ / ₁₆ "	15 ¹ / ₄ "	FFKS2815T	\$554	\$573	\$688	+\$55	+\$196
34 ¹ / ₁₆ "	15 ¹ / ₄ "	FFKS3415T	\$563	\$582	\$700	+\$55	+\$196

Cable Management Skins For 16¹/₂"H Single Shelves

22 ¹ / ₁₆ "	15 ¹ / ₄ "	FFKS2215M	\$314	\$331	\$443	+\$55	+\$196
28 ¹ / ₁₆ "	15 ¹ / ₄ "	FFKS2815M	\$320	\$339	\$454	+\$55	+\$196
34 ¹ / ₁₆ "	15 ¹ / ₄ "	FFKS3415M	\$329	\$348	\$466	+\$55	+\$196

► Specification Information, continued on next page

Skins For Shelves and Bins, continued

SIN 711.1

► Specification Information, continued from previous page

Specification Information							
Dimensions		Style Number	Base Prices			Options (Add \$ to Base Price)	
W	H		Fabric	LPL	Wood Group 1	Wood Group 2	Wood Group 3

Skins For Bins

22 ¹¹ / ₁₆ "	14"	FFKB2214	\$197	\$214	\$326	+\$55	+\$196
28 ¹¹ / ₁₆ "	14"	FFKB2814	\$203	\$222	\$337	+\$55	+\$196
34 ¹¹ / ₁₆ "	14"	FFKB3414	\$212	\$231	\$349	+\$55	+\$196
:	:	:	:	:	:	:	:

Cable Management Skins For Bins

22 ¹¹ / ₁₆ "	14"	FFKB2214M	\$314	\$331	\$443	+\$55	+\$196
28 ¹¹ / ₁₆ "	14"	FFKB2814M	\$321	\$340	\$455	+\$55	+\$196
34 ¹¹ / ₁₆ "	14"	FFKB3414M	\$328	\$347	\$465	+\$55	+\$196
:	:	:	:	:	:	:	:



Tip: Skins for bins are set back 1" from front edge of frame. Receptacle kits can not be placed behind skins for bins.



Tip: Specify a cable management skin when placing a receptacle kit behind the bin.

TV Skins

SIN 711.1

Standard Includes	Required to Specify
<ul style="list-style-type: none"> • Skin: fabric, Low-Pressure Laminate, glass, or wood group 1 • Blades: painted metal 	<ol style="list-style-type: none"> 1 Style number 2 Finish color number for skin 3 Paint color number for blades 4 Options, if selected (see below) <p>▶ See <i>Surface Materials</i>, page 608.</p>

Options	Price	Required to Specify
Surface Materials Horizontal or vertical application <ul style="list-style-type: none"> • Fabric price group A • Fabric price group 1 • Fabric price group 2 • Fabric price group 3 • Fabric price group 4 • Fabric price group 5 • Fabric price group 6 • Fabric price group 7 • Fabric price group COM • Wood group 2 • Wood group 3 • Customiz stain 	No cost No cost +\$ 27 +\$ 48 +\$ 77 +\$ 120 +\$ 165 +\$ 208 +\$ 16 Prices below Prices below No cost	Specify with <i>horizontal</i> or <i>vertical application</i> . Specify fabric color number. Specify fabric color number. Specify fabric color number. Specify fabric color number. Specify fabric color number. Specify fabric color number. Specify fabric color number. Specify fabric color number. Specify wood color number. Specify wood color number. Specify with <i>Customiz stain</i> . ▶ See <i>Surface Materials Reference Manual</i>
Wood Veneer Grain Direction <ul style="list-style-type: none"> • Horizontal grain direction • Vertical grain direction 	No cost No cost	Specify with <i>horizontal application</i> . Specify with <i>vertical application</i> .
Brackets with No Shroud <ul style="list-style-type: none"> • Bracket for 32" or smaller monitor • Bracket for larger than 32" monitor 	No cost No cost	Specify with <i>small bracket</i> . Specify with <i>large bracket</i> .
Brackets with Shroud <ul style="list-style-type: none"> • 32" shroud • 42" shroud • 46" shroud • 55" shroud • 65" shroud 	+\$1445 +\$1708 +\$1849 +\$2165 +\$2516	Specify with <i>32" shroud</i> . Specify with <i>42" shroud</i> . Specify with <i>46" shroud</i> . Specify with <i>55" shroud</i> . Specify with <i>65" shroud</i> .

Specification Information							
• Dimensions		• Style	• Base			• Options	
W	H	Number	Prices			(Add \$ to Base Price)	
•	•	•	• Fabric	• LPL	• Wood	• Wood	
•	•	•	•	•	• Group 1	• Group 2	• Group 3

Tip: TV attachment skins support monitors up to 65" and up to 200 pounds.

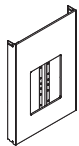

TV Attachment Skins — Centered Application

23 ¹ / ₁₆ "	33"	FFKT2333C	\$381	\$402	\$523	+\$ 93	+\$328
29 ¹ / ₁₆ "	33"	FFKT2933C	\$389	\$411	\$536	+\$ 93	+\$328
35 ¹ / ₁₆ "	33"	FFKT3533C	\$397	\$420	\$549	+\$ 93	+\$328

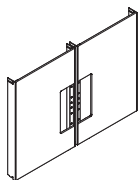

TV Attachment Skins, Pair — Spanning Application

23 ¹ / ₁₆ "	33"	FFKT2333S	\$646	\$688	\$931	+\$138	+\$485
29 ¹ / ₁₆ "	33"	FFKT2933S	\$662	\$704	\$955	+\$138	+\$485
35 ¹ / ₁₆ "	33"	FFKT3533S	\$677	\$719	\$978	+\$138	+\$485

Cantilever Desk and Tables Attachment Skins

SIN 711.1

Standard Includes	Required to Specify
<ul style="list-style-type: none"> • Skin: fabric, Low-Pressure Laminate, or wood group 1 • Brackets: painted metal 	<ol style="list-style-type: none"> 1 Style number 2 Finish color number for skin 3 Paint color number for brackets 4 Options, if selected (see below) <p>▶ See <i>Surface Materials</i>, page 608.</p>

Options	Price	Required to Specify
Surface Materials Horizontal or vertical application <ul style="list-style-type: none"> • Fabric price group A • Fabric price group 1 • Fabric price group 2 • Fabric price group 3 • Fabric price group 4 • Fabric price group 5 • Fabric price group 6 • Fabric price group 7 • Fabric price group COM • Wood group 2 • Wood group 3 • Customiz stain 	No cost No cost No cost +\$ 27 +\$ 48 +\$ 77 +\$120 +\$165 +\$208 +\$ 16 Prices below Prices below No cost	Specify with horizontal or vertical application. Specify fabric color number. Specify fabric color number. Specify fabric color number. Specify fabric color number. Specify fabric color number. Specify fabric color number. Specify fabric color number. Specify fabric color number. ▶ See <i>Surface Materials Reference Manual</i> . Specify wood color number. Specify wood color number. Specify with <i>Customiz stain</i> . ▶ See <i>Surface Materials Reference Manual</i> . Specify full-fill finish number.
Wood Veneer Grain Direction <ul style="list-style-type: none"> • Horizontal grain direction • Vertical grain direction 	No cost No cost	Specify with horizontal grain direction. Specify with vertical grain direction.

Specification Information						
Dimensions	Style Number	Base Prices			Options	
W H		Fabric	LPL	Wood Group 1	Wood Group 2	Wood Group 3

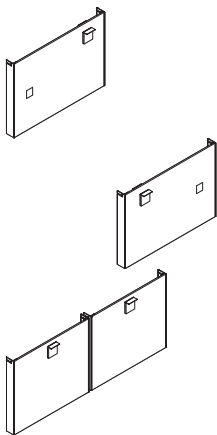

Left-Hand Cantilever Desk Attachment Skin							
35 ¹ / ₁₆ "	24 ³ / ₄ "	FFKQ3524L	\$ 506	\$ 522	\$ 627	+ \$93	+ \$328

Right-Hand Cantilever Desk Attachment Skin							
35 ¹ / ₁₆ "	24 ³ / ₄ "	FFKQ3524R	\$ 506	\$ 522	\$ 627	+ \$93	+ \$328

Skin Pair - Cantilever Table Attachment							
23 ¹ / ₁₆ "	24 ³ / ₄ "	FFKC2324	\$ 997	\$1027	\$1211	+ \$93	+ \$328
29 ¹ / ₁₆ "	24 ³ / ₄ "	FFKC2924	\$1023	\$1051	\$1242	+ \$93	+ \$328
35 ¹ / ₁₆ "	24 ³ / ₄ "	FFKC3524	\$1049	\$1077	\$1273	+ \$93	+ \$328

Accessories

SIN 711.1

Wire Management Cut-out Cover



Standard Includes	Required to Specify
<ul style="list-style-type: none"> Wire cut-out cover: paint 	<ul style="list-style-type: none"> 1 Style number 2 Paint color number for cover ▶ See <i>Surface Materials</i>, page 608.

Specification Information				
• Dimensions			• Style	• Price
D	W	H	Number	
1 1/8"	3 7/8"	1 1/8"	FFAC	\$47
:	:	:	:	:

Top Caps

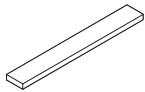

Standard Includes	Required to Specify
<ul style="list-style-type: none"> Top cap: paint 	<ul style="list-style-type: none"> 1 Style number 2 Paint color number for top cap ▶ See <i>Surface Materials</i>, page 608.

Specification Information			
• Dimensions		• Style	• Price
D	W	Number	
3 1/8"	23 1/16"	FFAT23	\$82
3 1/8"	29 1/16"	FFAT29	\$88
3 1/8"	35 1/16"	FFAT35	\$93
:	:	:	:

SIN 711.1

Modular Harnesses

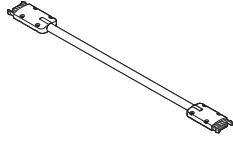

Standard Includes	Required to Specify
• Non-PVC modular harness	Style number

Specification Information

• Dimensions	• Style Number	• Price
W		
24"	FFVH24	\$175
30"	FFVH30	\$178
36"	FFVH36	\$181
42"	FFVH42	\$185
48"	FFVH48	\$190
54"	FFVH54	\$194
60"	FFVH60	\$198
66"	FFVH66	\$201
72"	FFVH72	\$204
78"	FFVH78	\$207
84"	FFVH84	\$211
90"	FFVH90	\$214
96"	FFVH96	\$217
102"	FFVH102	\$221
108"	FFVH108	\$224
114"	FFVH114	\$228
120"	FFVH120	\$233
.	.	.

1-Circuit Receptacle Kit

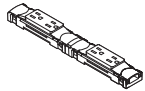

Tip: Specify a base power tray when using a receptacle kit.

Standard Includes	Required to Specify
• (2) duplex receptacles for Line 1: 6000 Black	Style number

Specification Information

• Dimensions	• Style Number	• Price
W		
11 ³ / ₄ "	FFVR1	\$70
.	.	.

SIN 711.1

2-Circuit Receptacle Kit

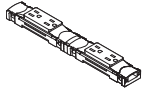

Tip: Specify a base power tray when using a receptacle kit.

Tip: For designation of controlled receptacles, order permanent ink stamp with controlled icon; service part (1063909001SR). It includes a pair of stamps, one white and one black. Appropriate receptacles can be stamped at the job site during installation.

Standard Includes	Required to Specify
-------------------	---------------------

- | | |
|---|--------------|
| <ul style="list-style-type: none"> (1) duplex receptacle for Line 1 and (1) duplex receptacle for Line 2: 6000 Black | Style number |
|---|--------------|

Specification Information		
• Dimensions	• Style	• Price
W	Number	

11 ³ / ₄ "	FFVR2	\$88
:	:	:

Hardwire Power Infeed

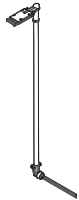

Standard Includes	Required to Specify
-------------------	---------------------

- | | |
|--|--------------|
| <ul style="list-style-type: none"> 1-circuit or 2-circuit hardwired, base power-in, 94" long x ³/₈" diameter flexible galvanized steel conduit. Male modular connector | Style number |
|--|--------------|

Specification Information		
• Dimensions	• Style	• Price
W	Number	

94"	FFVIH	\$117
:	:	:

Workwall Base Trays

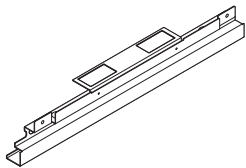

Standard Includes	Required to Specify
-------------------	---------------------

- | | |
|---|--------------|
| <ul style="list-style-type: none"> Metal: 7237 Slate | Style number |
|---|--------------|

Specification Information		
• Dimensions	• Style	• Price
W	Number	

23 ¹ / ₁₆ "	FFVT23	\$82
29 ¹ / ₁₆ "	FFVT29	\$88
35 ¹ / ₁₆ "	FFVT35	\$93
:	:	:

Workwall Wire Managers

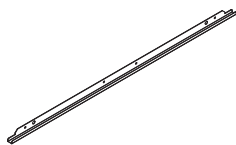

Standard Includes	Required to Specify
<ul style="list-style-type: none"> • Metal: 7237 Slate • Attachment hardware 	Style number

Specification Information		
• Dimensions W	• Style Number	• Price
23 ¹ / ₁₆ "	FFAA23	\$58
29 ¹ / ₁₆ "	FFAA29	\$65
35 ¹ / ₁₆ "	FFAA35	\$70
:	:	:



Surface Materials

Surface Materials	608
Specification Guidelines for Directional Fabrics	612
Wood Veneer Grain and Directional Laminate Application	613
Approved Fabrics that Meet DFAR 252.225-7012 Preference for Certain Domestic Commodities Used for Navy BPA	614

Surface Materials

This listing includes all the surface material choices that are available for the products in this specification guide.

Resources

For more information about surface materials, refer to the following resources:

Additional surface materials specification tools are available to assist you in the specification process — the Surface Materials Binders.

Surface Materials

Binders include:

- Surface Materials Reference Manual
- A complete set of swatch cards for hard surfaces, vertical surface fabrics, and seating upholstery

Paint

► See *Surface Materials Reference Manual* for a listing of available paints for Victor2.

Applies to:

- Blades on shelves, bins, drawers, and skins
- Wire cut-out cover
- Top caps

Steelcase Surfaces

Textured Paint

- 7207 Black
- 7241 Arctic White

Smooth Metallic Paint

- 4799 Platinum Metallic

Textured Metallic Paint

- 7246 Midnight Metallic

Applies to:

- Shrouds
- 4140 Arctic White Gloss
- 4799 Platinum Metallic
- 4803 Near Black Metallic
- 7245 Midnight Metallic

Laminate

► See *Surface Materials Reference Manual* for a listing of available laminates for Victor2.

Applies to:

- Shelves, bins, and drawers
- Laminate skins

Steelcase Surfaces

Low-Pressure Laminate

- 247L Black V2 LPL
 - 24L0 Graphite Walnut LPL
 - 25L1 Winter on Maple LPL
 - 25L5 Virginia Walnut LPL
 - 25L6 Blackwood LPL
 - 25L8 Clear Walnut LPL
 - 25L9 Warm Oak LPL
 - 262L Marbled Maple LPL
 - 264L Chocolate Walnut LPL
 - 267L Marbled Cherry V2 LPL
 - 26L1 Natural Cherry V2 LPL
 - 275L Warm White LPL
 - 2L03 Brushed Silver LPL
 - 2L09 Clear Maple LPL
 - 2L30 Arctic White LPL
 - 2L50 Vanadium Fiber LPL
 - 2L52 Tungsten Fiber LPL
 - 2L83 Seagull LPL
 - 2L85 Dune LPL
 - 2LAN Ash Noce LPL
 - 2LAW Ash Wenge LPL
 - 2LBN Bisque Noce LPL
 - 2LBW Bisque Wenge LPL
 - 2LCN Clay Noce LPL
 - 2LCW Clay Wenge LPL
 - 2LMG Merle LPL
 - 2LSN Storm Noce LPL
 - 2LSW Storm Wenge LPL
- Tip: Some wood veneer finishes and woodgrain laminates share the same name. Because of the difference in materials, veneers and laminates of the same name are not an exact match but do coordinate with each other.*

Plastic

Steelcase Surfaces

Applies to:

- Plastic edge on laminate worksurfaces
- 6000 Black
- 6001 Coffee
- 6009 Arctic White
- 6034 Natural Cherry
- 6036 Medium Cherry
- 6037 Winter on Maple
- 6038 Blonde on Maple
- 6041 Natural Walnut
- 6045 Medium Mahogany on Walnut
- 6052 Milk
- 6053 Seagull
- 6213 Acacia
- 6219 Clear Oak
- 6231 Graphite Walnut
- 6234 Clear Cherry
- 6237 Clear Maple
- 6242 Virginia Walnut
- 6243 Blackwood
- 6245 Clear Walnut
- 6246 Warm Oak
- 6249 Platinum Solid
- 6271 Plywood
- 6527 Merle
- 6615 Grey V5
- 6619 Ice
- 6631 Cream
- 6635 Dawn
- 6636 Mist
- 6654 Sand
- 6655 Warm White
- 6676 Marbled Maple
- 6677 Chocolate Walnut
- 6678 Marbled Cherry
- 6694 Slate
- 6695 Midnight
- 6697 Fog
- 6698 Fieldstone
- 6703 Ash Wenge
- 6704 Storm Wenge
- 6705 Bisque Wenge
- 6706 Clay Wenge
- 6707 Ash Noce
- 6708 Bisque Noce
- 6709 Clay Noce
- 6710 Storm Noce

Select Surfaces

- 6T02 Fawn Cypress
- 6T03 Weathered Char
- 6T04 Saddle Oak
- 6T05 Veranda Teak
- 6T06 Persian Cherry
- 6T07 Walnut Heights

Wood

Applies to:

- Wood skins
- Wood shelves
- Wood drawers
- Wood bins

Steelcase carefully selects veneer and solid wood for consistent color and grain structure. Wood is a natural material and variations will occur in color, grain and texture. These variations are part of the inherent natural beauty of wood and are not considered defects.

All wood products will darken with age and exposure to ultraviolet light. This is especially apparent with cherry and maple veneer. We recommend that desk accessories be rearranged periodically to ensure even aging of wood surfaces.

When storing your wood furniture, please follow the following guidelines:

- Do not store products in trailers
- Store products in areas that simulate office temperatures (60°F to 90°F)
- Store products in areas that maintain constant, office-like humidity levels
- Keep product away from light. Cover products to make sure they are not exposed to light.

Steelcase Surfaces

Veneer

Veneers are matched for proper balance and consistency. Veneers are available flat cut or quarter cut, except for Oak, which is rift cut. Refer to the *Surface Materials Reference Manual* for descriptions of each cut.

Open-pore finish is a medium gloss finish that leaves the wood grain texture visible to the eye and distinguishable to the touch.

► See *Surface Materials Reference Manual* for a listing of available veneers for Victor2.

Flat-cut open-pore finish choices**Wood Group 1**

- 3062 FC/OP Graphite Walnut
- 3402 FC/OP Clear Cherry (Aged)
- 3412 FC/OP Natural Cherry
- 3422 FC/OP Medium Cherry
- 3522 FC/OP Clear Maple*
- 3572 FC/OP Amber on Maple
- 3592 FC/OP Blonde on Maple
- 3702 FC/OP Clear Walnut
- 3712 FC/OP Natural Walnut
- 3722 FC/OP Dark Mahogany on Walnut
- 3752 FC/OP Medium Walnut
- 3762 FC/OP Dark Walnut
- 3772 FC/OP Medium Mahogany on Walnut

Quarter-cut open-pore finish choices**Wood Group 1**

- 3042 QC/OP Ash*
- 3222 QC/OP Clear Maple*
- 3272 QC/OP Amber on Maple
- 3292 QC/OP Blonde on Maple
- 3302 QC/OP Clear Walnut
- 3312 QC/OP Natural Walnut
- 3322 QC/OP Dark Mahogany on Walnut
- 3352 QC/OP Medium Walnut
- 3362 QC/OP Dark Walnut
- 3372 QC/OP Medium Mahogany on Walnut
- 3382 QC/OP Graphite Walnut

Rift-cut open-pore finish choices**Wood Group 1**

- 3602 RC/OP Desert Oak
- 3612 RC/OP Warm Oak
- 3692 RC/OP Espresso Oak

Full-fill finish is a medium-gloss finish that completely fills the grain texture, yet allows the grain pattern to be seen. The wood has a lustrous, satiny look, and it is smooth to the touch. This finish is available on the wood top only.

Flat-cut full-fill finish choices**Wood Group 1**

- 3064 FC/FF Graphite Walnut
- 3404 FC/FF Clear Cherry (Aged)
- 3414 FC/FF Natural Cherry
- 3424 FC/FF Medium Cherry
- 3524 FC/FF Clear Maple*
- 3544 FC/FF Blonde on Maple
- 3574 FC/FF Amber on Maple
- 3704 FC/FF Clear Walnut
- 3714 FC/FF Natural Walnut
- 3724 FC/FF Dark Mahogany on Walnut
- 3754 FC/FF Medium Walnut
- 3764 FC/FF Dark Walnut
- 3774 FC/FF Medium Mahogany on Walnut

Quarter-cut full-fill finish choices**Wood Group 1**

- 3224 QC/FF Clear Maple*
- 3274 QC/FF Amber on Maple
- 3294 QC/FF Blonde on Maple
- 3304 QC/FF Clear Walnut
- 3314 QC/FF Natural Walnut
- 3324 QC/FF Dark Mahogany on Walnut
- 3354 QC/FF Medium Walnut
- 3364 QC/FF Dark Walnut
- 3374 QC/FF Medium Mahogany on Walnut
- 3384 QC/FF Graphite Walnut

Rift-cut full-fill finish choices**Wood Group 1**

- 3604 RC/FF Desert Oak
- 3614 RC/FF Warm Oak
- 3694 RC/FF Espresso Oak

**To ensure an understanding of the color ranges and characteristic variations of natural veneer, a sign-off sheet is required prior to orders being accepted for this clear-coat finish. The sign-off sheet is available through Steelcase advertising stock. Please use form number 09-0000756 for 3042, form number 05-0001370 for 3222 and 3224.*

Premium Veneers

A selection of Premium veneers in this collection are available on most Steelcase brand products. The collection will be available as close to standard leadtimes as possible. However, because adequate supplies of veneer and solids must be secured, all orders will be scheduled individually. Leadtimes will vary based on Premium veneer and Premium solids availability at the time the order is placed. The collection is Graded-In as Wood Group 2 and Wood Group 3, and supported like standard veneers to make ordering easy. Please see the Steelcase surface materials section on village.steelcase.com for sample information and product line availability. All premium veneers are in clear-coat.

Quarter-cut open-pore finish choices**Wood Group 2**

- 3032 QC/OP Dark Thin Line Bamboo
- 3052 QC/OP Ribbon Sapele

Wood Group 3

- 3832 QC/OP Figured Anegre
- 3842 QC/OP Figured Makore

To ensure an understanding of the color ranges and characteristic variations of natural veneer, a sign-off sheet is required prior to orders being accepted for this clear-coat finish. The sign-off sheet is available through Steelcase advertising stock. Please use form number 09-0000755 for 3032, form number 09-0000757 for 3052, form number 09-0000758 for 3832, and form number 09-0000759 for 3842.

Select Surfaces

For information on products within Select Surfaces, including accent paints and fabrics from DesignTex, Gabriel, Kvadrat, and Pollack, please refer to the *Surface Materials Reference Manual* or visit steelcase.com/surface-materials under the Select Surfaces section.

Composite Veneer

Composite veneers are an engineered wood intended to create specific grain patterns and characteristics. They are pre-stained and finished with Steelcase's Clarity water-borne UV topcoat, which protects the environment while providing durability and clarity. Only open-pore finishes are available on composite wood. Composite veneer and matching edge bands are available on most Steelcase brand products. Composites, for us as a solid nosing substitute, are not available. Steelcase does not recommend mixing composite veneers with natural solid nosings because composite and natural wood grain and color matching are rarely compatible. Composite veneers are Graded-In as Wood Group 1 pricing.

Flat-cut open-pore finish choices**Wood Group 1**

- 3JDX FC/OP Oak Composite
- 3JFX FC/OP Maple Composite
- 3JHX FC/OP Cherry Composite
- 3JXX FC/OP Walnut Composite

Quarter-cut open-pore finish choices**Wood Group 1**

- 3F8X QC/OP European Walnut Composite
- 3GAX QC/OP Gold Teak Composite
- 3GFX QC/OP Rosewood Composite
- 3GGX QC/OP Zebrano Composite
- 3HGX QC/OP Oak Composite
- 3HVX QC/OP Walnut Composite
- 3JEX QC/OP Maple Composite
- 3JGX QC/OP Cherry Composite
- 3ZNX QC/OP Night Cerused Oak Composite

Natural Veneer

Natural veneer is available in the Select Surfaces offering. Natural veneer may have extended leadtimes. Place your order as you normally would for any other finish, calling out the appropriate finish code.

The following finishes are available through the natural veneer offering:

Flat-cut open-pore finish choices**Wood Group 1**

- 3342 FC/OP Black Walnut
- 35A2 FC/OP Blanch Maple
- 37A2 FC/OP Thunder Walnut

Wood Group 3

- 3082 FC/OP Washed Walnut

Flat-cut full-fill finish choices**Wood Group 1**

- 3734 FC/FF Black Walnut

Wood Group 3

- 3084 FC/FF Washed Walnut

Surface Materials, continued

Quarter-cut open-pore finish choices**Wood Group 1**

- 32A2 QC/OP Blanch Maple
- 33A2 QC/OP Thunder Walnut
- 3392 QC/OP Black Walnut

Quarter-cut full-fill finish choices**Wood Group 1**

- 3394 QC/FF Black Walnut

Rift-cut open-pore finish choices**Wood Group 1**

- 36A2 RC/OP Volcanic Oak

Planked Veneer

Planked veneer is available in the Select Surfaces offering. Planked veneer may have extended leadtimes. Place your order as you normally would for any other finish, calling out the appropriate finish code.

The following finishes are available through the planked veneer offering:

Wood Group 1

- 3P41 OP Planked Cherry
- 3P51 OP Planked Maple
- 3P61 OP Planked Oak
- 3P71 OP Planked Walnut

Tip: Known for its uniqueness, planked veneer has intentional and natural variations that include, but are not limited to: character marks, grain pattern, color, and natural color aging.

Custom Surfaces

Customiz stain is a service that allows you to create your own stain colors and finishes on standard veneer. Customiz stain color is available on all product lines that offer wood veneer.

A \$500 stain matching fee applies on all CUSTOMIZ requests. (Exception: The \$500 fee does not apply on matches to Coalesse standard finishes or for a log-gloss finish request on a standard color.) The \$500 fee covers the cost of formulating the Customiz color finish and applies regardless of whether or not an order for product is placed.

In addition, an approval form must be signed to indicate customer acceptance of Customiz match. A \$1,500 initiation fee will be charged prior to first order entry. This initiation fee activates the finish for unlimited use on any Steelcase product for an 18 month time period. After the 18 month time period has lapsed, the Customiz finish may be reactivated for another 18 months for a \$1,000 fee at any point within five years after the \$1,500 initiation fee was paid. If the finish is not reactivated within five years after the \$1,500 initiation fee was paid, the finish will be culled and the customer will need to pay the \$1,500 initiation fee again. All style number related Customiz charges products are no cost as of April 2014. The matching and initiation fees are not discountable.

Customize stain takes 10 days to formulate. Consult the *Surface Materials Reference Manual* for more information. Custom veneers are also available and must be quoted by Steelcase specials group. Customize stain on custom veneers takes 2 to 5 weeks to formulate. Requirements and information on ordering a Customiz stain color are found in the *Surface Materials Reference Manual*.

Glass**Steelcase Surfaces**

Applies to:

- Glass skins
- 6580 Ice White

Vertical Surface Fabric

Applies to:

- Fabric skins

Steelcase Surfaces**Price Group A****Sprite**

- 5540 Khaki
- 5541 Snow
- 5542 Butter
- 5543 Linen
- 5544 Sherbet
- 5545 Powder
- 5546 Harvest
- 5547 Sky
- 5548 Kiwi

Price Group 1**Abacus**

- P122 Entasis
- P123 Portico
- P124 Opus
- P125 Cusp
- P126 Artifact
- P129 Atlas

Alloy

- P525 Polar
- P526 Skim
- P527 Bubbly
- P528 Tern
- P529 Shore
- P530 Asti
- P531 Silver
- P532 Oxide
- P533 Element
- P534 Construct
- P535 Currency
- P536 Iron

Boccie

- P200 New Rice
- P201 New Almond
- P202 New Nutmeg
- P203 New Camel
- P204 New Opal
- P205 New Mist
- P206 New Plum
- P207 New Lichen
- P208 New Spearmint
- P209 New Sky

Buzz2

- 5F03 Tomato
- 5F04 Red
- 5F05 Burgundy
- 5F06 Sky
- 5F07 Blue
- 5F08 Navy
- 5F10 Grape
- 5F11 Eggplant
- 5F15 Stone
- 5F16 Grey
- 5F17 Black
- 5G50 Dunegrass
- 5G51 Sable
- 5G52 Barley
- 5G53 Sunrise
- 5G54 Carrot
- 5G55 Pumpkin
- 5G56 Timber
- 5G57 Rouge
- 5G58 Chocolate
- 5G59 Meadow
- 5G60 Ivy
- 5G61 Cyan
- 5G62 Atlantic
- 5G63 Crocus
- 5G64 Alpine
- 5G65 Tornado

Charm

- P504 Tint
- P505 Shell
- P506 Mimosa
- P507 Birch
- P508 Sparkle
- P509 Ginkgo
- P510 Debut
- P511 Clover
- P512 Spicy
- P513 Twilight

Lapel

- P409 Cement
- P410 Pebble
- P411 Beech
- P412 Dune
- P413 Grain
- P414 Sprout
- P415 Misty Blue
- P416 Maple
- P417 Slate

Optic

- P540 Hazel
- P541 Twinkle
- P542 Orion
- P543 Seaglass
- P544 Shine
- P545 Halo
- P546 Whiskey
- P547 Bath
- P548 Whisper
- P549 Breezy
- P550 Wry
- P551 Glimmer

Pianista

- P420 Sand
- P421 Mist
- P422 Rain
- P423 Natural
- P424 Café
- P425 Denim
- P426 Carbon
- P427 Stone
- P428 Flax
- P429 Oat
- P430 Wheat
- P431 Maize

Rhythm

- P555 Allegro
- P556 Tempo
- P557 Refrain
- P558 Pitch
- P559 Harmony
- P560 Melody
- P561 Stanza
- P562 Opus

Tinsel

- P515 Sugar
- P516 Lit
- P517 Ego
- P518 Fizz
- P519 Muse
- P520 Depth
- P521 Bliss
- P522 Grow
- P523 Dolce
- P524 Boost

Price Group 2**Bariolage**

- G200 New Etude
- G201 New Andante
- G202 New Cantata
- G203 New Adagio
- G205 New Ballata
- G206 New Sonata

Bouquet

- P165 Hosta
- P166 Dundee
- P169 Argenta
- P170 Hoya
- P173 Camomile

Code

- 5FA1 Fossil
- 5FA2 Gabbro
- 5FA3 Reed
- 5FA4 Bluff
- 5FA5 Sea Salt
- 5FA6 Cannon
- 5FA7 Tussah
- 5FA8 Mica
- 5FA9 Ecru
- 5FB1 Bamboo

Flip: Orbit

- 5F85 Mud Pie
- 5F86 Hummus
- 5F87 Petoskey
- 5F88 Pluto
- 5F89 Papyrus
- 5F91 Blizzard
- 5F92 Briquette

Flip: TexHex

- 5F75 Mud Pie
- 5F76 Hummus
- 5F77 Petoskey
- 5F78 Pluto
- 5F79 Papyrus
- 5F97 Blizzard
- 5F98 Briquette

Fresco

- G001 Sandrift
- G002 Mistiblu
- G003 Faon
- G006 Chamoline
- G007 Grapenut
- G017 Flint

Latch

- P600 Seashell
- P601 Clam
- P602 Eggshell
- P603 Zen
- P604 Cool Gray
- P605 Armor
- P606 Sentinel
- P607 Rye
- P608 Billow
- P609 Nimbus

Milano

- N002 Delft
- N003 Woodland
- N004 Sunshadow
- N005 Olivine
- N012 Teakwood

Price Group 3**Billiard Multi-Use by
Designtex**

- 5H10 Bone
- 5H11 Poppy
- 5H12 Tangelo
- 5H13 Citron
- 5H14 Avocado
- 5H15 Hunter
- 5H16 Indigo
- 5H17 Mallard
- 5H18 Teak
- 5H19 Cumulus
- 5H20 Pewter
- 5H21 Gunmetal
- 5H22 Ink

Select Surfaces

For information on products within Select Surfaces, including accent paints and fabrics from Designtex, Gabriel, Kvadrat, and Pollack, please refer to the *Surface Materials Reference Manual* or visit steelcase.com/surface-materials under the Select Surfaces section.

Custom Surfaces**Price Group COM
(Customer's Own
Material)****Fabric Approval and
Yardage**

To confirm whether a particular COM material has already been tested for use on a specific Steelcase product or to determine actual yardage requirements:

- Visit www.steelcase.com

For additional information regarding Customer's Own Material, call 1.888.STEELCASE (1.888.783.3522) or send an e-mail to lineone@steelcase.com.

► See *Surface Materials Reference Manual* for a listing of available seating upholstery colors.

Specification Guidelines for Directional Fabrics

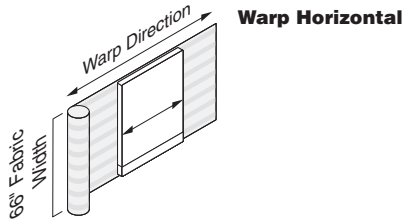

One application direction of fabric on FlexFrame skins is warp horizontal. Standard Steelcase fabrics were designed for this application direction.

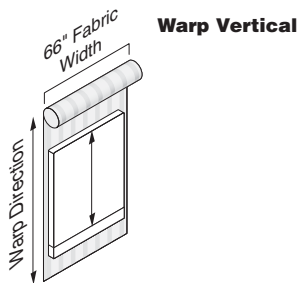

The other application direction of fabrics on FlexFrame skins is warp vertical. This is most commonly used on COMs designed for warp vertical application.

For more information about the warp direction of fabrics, see the *Surface Materials Reference Manual*.

Wood Veneer Grain and Directional Laminate Application

Wood Veneer Grain and Directional Laminate Application

Wood veneer and directional laminates are standard with the grain directions shown.

The appearance of wood veneer may change slightly depending on the angle from which it is viewed. The natural phenomenon is called polarization, and it can be seen on natural veneer, and to a lesser extent on composite veneer. Polarization is often noticed on surfaces installed at a 90° angle with each other.

Some wood veneer finishes and woodgrain laminates share the same name. Because of the difference in materials, veneers and laminates of the same name are not an exact match but do coordinate with each other.

TechBox can have directional change of horizontal and vertical.

Wood Veneer Grain

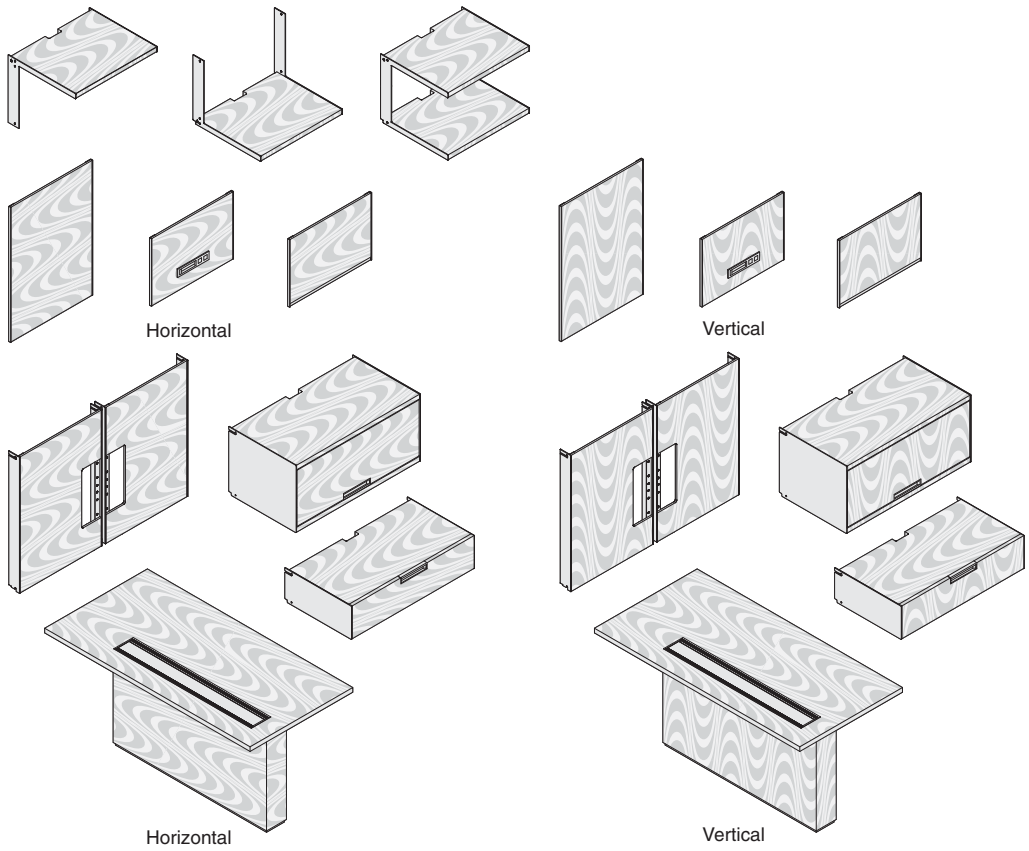

Directional Laminate

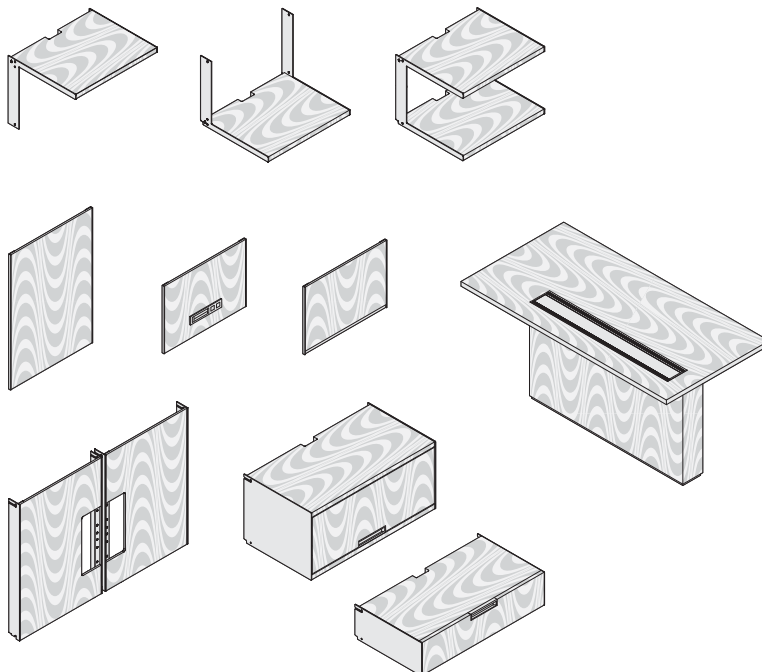

Approved Fabrics that Meet DFAR 252.225-7012 Preference for Certain Domestic Commodities Used for Navy BPA

Vertical Surfaces Fabric Applications

Legend



- = Not available
- = Available
- = Available with exceptions

	Price Group	Roll Width	Answer	Avenir	Brody Lounge Seating – Lower Surround	Brody Lounge Seating – Seat	Brody Lounge Seating – Screen	Brody Lounge Seating – Footrest	Divisio Side Screen	Flex Screens	FlexFrame	FrameOne	Groupwork Screens	Kick Panels	Montage	Ology Universal Screen	Privacy Wall	Sarto Screens	Umami Screens	Universal Privacy/Modesty Screens
Steelcase Fabrics																				
Alloy	1	66"	■	■	■	■	■	■	■	■	■	■	■	■	■	•	•	■	•	•
Bouquet	2	66"	■	■	■	■	■	■	■	■	■	•	■	■	■	•	■	■	•	•
Buzz2	1	54"	■	■	■	■	■	■	■	■	■	■	■	■	■	■	■	■	■	■
Code	2	66½"	■	■	•	•	•	•	■	■	■	■	■	■	■	■	■	■	■	■
Flip: Orbit	2	66"	■	■	■	■	■	■	■	■	■	•	■	•	■	•	■	■	•	•
Flip: TexHex	2	66"	■	■	■	■	■	■	■	•	■	•	■	•	■	•	■	•	•	•
Fresco	2	66"	■	■	■	■	■	■	■	■	■	•	■	■	■	•	■	■	•	•
Lapel	1	66"	■	■	■	■	■	■	■	■	■	•	■	■	■	•	■	■	•	•
Latch	2	66"	■	■	•	•	•	•	■	■	■	■	■	■	■	■	■	■	•	■
Milano	2	66"	■	■	■	■	■	■	■	■	■	•	■	■	■	•	■	■	•	•
Optic	1	66"	■	■	■	■	■	■	■	■	■	•	■	■	■	•	■	■	•	•
Rhythm	1	66"	■	■	■	■	■	■	■	■	■	•	■	■	■	•	■	■	•	•
Sprite	A	66"	■	•	■	■	■	■	•	■	•	•	■	■	•	•	■	■	•	•
DesignTex Fabrics																				
Appleseed Unfinished	-	-	•	•	•	•	•	•	•	•	■	•	•	•	•	•	•	•	■	•
Cesta	-	-	■	■	•	•	•	•	■	■	■	■	■	■	■	•	■	■	•	•
Clew	-	-	■	■	•	•	•	•	■	■	■	■	■	■	■	•	•	■	•	•
Decibel	-	-	■	■	•	•	•	•	■	■	■	■	■	■	■	■	■	■	•	■
Gamut Unfinished	-	-	■	■	•	•	•	•	■	■	■	■	■	■	■	■	■	■	■	•
Gravity	-	-	■	■	•	•	•	•	■	■	■	■	■	■	■	•	■	■	•	•
New Brunswick	-	-	■	■	•	■	•	■	•	■	■	■	■	■	■	•	•	■	•	•
Plateau	-	-	■	■	•	•	•	•	■	■	■	■	■	■	■	•	■	■	•	•
Rocket without Nanotex	-	-	■	•	•	•	•	•	■	•	■	■	■	■	■	•	•	•	■	•
Singing In The Rain	-	-	■	■	•	•	•	•	■	■	■	■	■	■	■	•	•	■	•	•
Vivid Unfinished	-	-	■	■	•	•	•	•	■	■	■	■	■	■	■	•	■	■	•	•

For information regarding DesignTex fabrics, please see steelcase.com/customersurface. Application direction may vary depending on roll width and pattern repeat.

Specifying Victor2 Products

► For more detailed product information, see the *Wood Casegoods and Tables Specification Guide*, or consult your Steelcase dealer.

	
Statement of Line	616
	
Mobile Unit (SIN 711.3)	617
Freestanding Units (SIN 711.3)	618
Tray Shelf and Display (SIN 711.3)	620

Statement of Line

Victor2

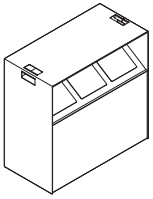

Specifying
▶ Page 617

Mobile Unit

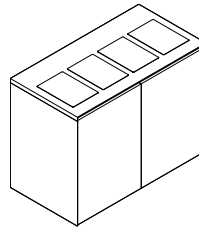

Specifying
▶ Page 618

Freestanding Unit



Specifying
▶ Page 620

Tray Shelf



Specifying
▶ Page 620

Display

Mobile Unit

SIN 711.3

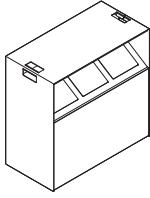

Tip: Acrylic inserts lift out without tools for ease of cleaning and changeability.

Tip: Verbiage on each insert comes standard and contains English, Spanish, and French.

Standard Includes

- Mobile unit:
 - Front and back: wood group 1
 - Sides and top: paint
 - Finished back hinged doors
 - Three slot opening with sloped receptacles and built in bag holding system
 - Acrylic inserts etched with recycling icons and wording
 - Three 100% recycled plastic rigid recycling bins - 12 gallon capacity each
 - Four non-locking black casters: two swivel/two fixed

Required to Specify

- 1 Style number
- 2 Wood color number for front and back
- 3 Paint color number for sides and top (case)
- 4 Three acrylic inserts (see below under Required Selections)
- 5 Options, if selected (see below)
 - ▶ See *Surface Materials Reference Manual*.

Required Selections

Acrylic Inserts (Pick three)



Plastic



Compost



Mixed



Waste



Paper



Aluminum



Returnables



Glass

Options

Surface Materials

Wood front and back

- Wood group 2 +\$ 69
- Wood group 3 +\$240
- Customiz stain No cost

Specify wood color number.
Specify wood color number.
Specify with *Customiz stain*.
▶ See *Surface Materials Reference Manual*.

Laminate front and back

- Laminate price group 1 -\$328
- Laminate price group 2 See information to left
- Open Line Laminate -\$259 plus cost of laminate

Specify laminate color number.
Specify laminate color number.
▶ See *Surface Materials Reference Manual*.

Paint on case

- Paint price group 1 No cost
- Paint price group 2 +\$ 75
- Paint price group 3 +\$128

Specify paint color number.
Specify paint color number.
Specify paint color number.

For laminate price group 2 pricing, please refer to the electronic catalog or SmartTools.

Specification Information

Dimensions			Style	Base
D	W	H	Number	Price

Mobile Unit - 3 Openings

18"	36"	36"	AWRM183636	\$3825
-----	-----	-----	-------------------	--------

Tip: Receptacle contains features to accommodate oversized bags.

Tip: Soft-touch integral handle allows easy movement from one location to another.

Freestanding Units

SIN 711.3

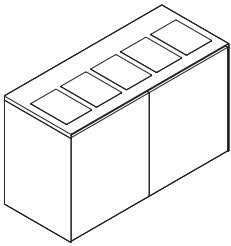
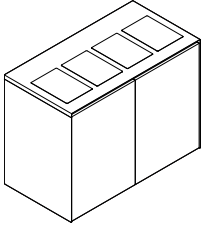









Tip: Tray shelf and display are ordered separately.

Tip: Acrylic inserts lift out without tools for ease of cleaning and changeability.

Tip: Verbiage on each insert contains English, Spanish, and French.

For laminate price group 2 pricing, please refer to the electronic catalog or SmartTools.

Standard Includes	Required to Specify
<ul style="list-style-type: none"> Freestanding unit: <ul style="list-style-type: none"> – Front and back: wood group 1 – Side and top: paint Finished back Four or five top slot openings with receptacles Acrylic inserts etched with recycling icons and wording Four or five recycling bins (capacity of 23 gallons in each receptacle), fits 30 gallon size bags and larger Leveling glides: black only 	<ol style="list-style-type: none"> Style number Wood color number for front and back Paint color number for sides and top (case) Four or five acrylic inserts (see below under Required Selections) Options, if selected (see below) <ul style="list-style-type: none"> ▶ See <i>Surface Materials Reference Manual</i>.

Required Selections	
Acrylic Inserts (Pick four or five)	
	
Plastic	Compost
	
Mixed	Waste
	
Paper	Aluminum
	
Returnables	Glass

Options	Price	Required to Specify
Surface Materials		
Wood front and back		
<ul style="list-style-type: none"> Wood group 2 Wood group 3 Customiz stain 	Prices at right Prices at right No cost	Specify wood color number. Specify wood color number. Specify <i>with Customiz stain</i> . ▶ See <i>Surface Materials Reference Manual</i> .
Laminate front and back		
<ul style="list-style-type: none"> Laminate price group 1 <ul style="list-style-type: none"> – Four opening – Five opening Laminate price group 2 <ul style="list-style-type: none"> – Four opening – Five opening Open Line Laminate <ul style="list-style-type: none"> – Four opening – Five opening 	–\$546 –\$765 See information to left See information to left –\$477 plus cost of laminate –\$696 plus cost of laminate	Specify laminate color number. Specify laminate color number. Specify laminate color number. Specify laminate color number. ▶ See <i>Surface Materials Reference Manual</i> . ▶ See <i>Surface Materials Reference Manual</i> .
Paint on case		
<ul style="list-style-type: none"> Paint price group 1 Paint price group 2 Paint price group 3 	No cost +\$ 75 +\$128	Specify paint color number. Specify paint color number. Specify paint color number.
Related Products	<ul style="list-style-type: none"> Tray Shelf Display 	▶ Page 620 ▶ Page 620

Specification Information

• Dimensions			• Style	• Base	• Options	
D	W	H	Number	Price	(Add \$ to Base Price)	
					Wood	
					Wood front and back	
					Wood	Wood
					Group 2	Group 3

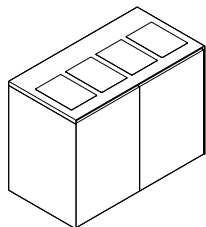

Freestanding Unit - 4 Openings

25"	48"	36"	AWRF254836	\$5465	+\$124	+\$435
:	:	:	:	:	:	:

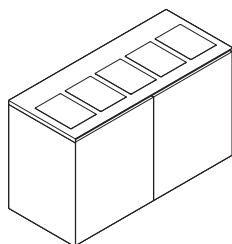

Freestanding Unit - 5 Openings

25"	60"	36"	AWRF256036	\$6887	+\$157	+\$547
:	:	:	:	:	:	:



Tray Shelf and Display

SIN 711.3

Tray Shelf



Tip: Tray shelf fits most trays up to 20³/₄" x 12".

Tip: Tray shelf cannot be used with the mobile unit.

Tip: Two tray shelves can be used on the freestanding 4 or 5 slot opening. A 15" gap will separate the two tray shelves if used on the freestanding 5 unit.

Tip: Maximum tray storage is 20 food trays.

Standard Includes	Required to Specify
-------------------	---------------------

- Tray shelf: paint

- 1 Style number
 - 2 Paint color number for tray
 - 3 Options, if selected (see below)
- ▶ See *Surface Materials Reference Manual*.

Options	Price	Required to Specify
---------	-------	---------------------

Surface Materials

- Paint price group 1
- Paint price group 2
- Paint price group 3

No cost
+\$11
+\$23

- Specify paint color number.
Specify paint color number.
Specify paint color number.

Related Products

- Freestanding units

▶ Page 618

Specification Information

Dimensions			Style Number	Base Price
D	W	H		
12 ³ / ₄ "	22 ¹ / ₄ "	9 ¹⁵ / ₁₆ "	AWTS	\$382

Display



Tip: Display holds two 8¹/₂" x 11" papers or one 11" x 17".

Tip: Display cannot be used with the mobile unit.

Tip: Two displays can be used on the freestanding 4 or 5 slot opening. A gap of 18¹/₂" will separate the two displays if used on the Freestanding 5 unit.

Tip: Paper is placed between the two acrylic plates.

Standard Includes	Required to Specify
-------------------	---------------------

- Display
- Attachment brackets: paint

- 1 Style number
 - 2 Paint color number for bracket
 - 3 Options, if selected (see below)
- ▶ See *Surface Materials Reference Manual*.

Options	Price	Required to Specify
---------	-------	---------------------

Surface Materials

- Paint price group 1
- Paint price group 2
- Paint price group 3

No cost
+\$11
+\$23

- Specify paint color number.
Specify paint color number.
Specify paint color number.

Related Products

- Freestanding units

▶ Page 618

Specification Information

Dimensions			Style Number	Base Price
D	W	H		
13 ¹ / ₁₆ "	20 ³ / ₄ "	15 ¹ / ₂ "	AWDR	\$382

Resources

Lock and Keying Walden, Convene, and Elective Elements	622
Style Number Index	624

Lock and Keying Walden, Convene, and Elective Elements

All locking products are standard with factory-installed, keyed-random locks. Consecutive, specific, and random keying are available as field-installed options.

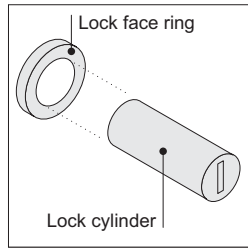

Locks consist of a factory- or field-installed lock cylinder and a factory-installed lock face ring.

Two types of locks are available — the standard keying system (FR series) and the master keying system (XF series). All the locks in the XF series can be opened with a single master key.

Factory-Installed Keying

Factory-installed locks are always key random (standard) or master key random (optional on some product lines). Key random means that the locks will be assigned arbitrarily at the factory with key numbers ranging from FR305 to FR454 (Master keying numbers: XF1001 to XF1150). All locks within a unit will be keyed alike.

Tip: Random keying can mean that different furniture units will have the same key number. If you must have all locks keyed differently, you should specify field-installed, key specific or key consecutive lock cylinders.

▶ See below.

Key Random

FR305

FR421

FR305

or

XF1011

XF1042

XF1011

XF
Master
Key

Required to Specify

Master key random	+\$24	Specify with master key random.
--------------------------	-------	---------------------------------

Field-Installed Keying

Field-installed locks are only available on products that include factory-installed lock mechanisms.

Specify "plug" when specifying furniture, and the product will ship with a plastic plug in place of the lock cylinder.

Front-removable lock cylinders must be specified separately. You must also order a special lock tool to install or remove lock cylinders in the field.

Tip: Lock tools are reusable. You do not need to order additional lock tools with every furniture order.

Lock cylinders will be shipped separately so that you can install the locks when you are ready.

Three keying choices are available for field installation—random (standard), specific, and consecutive. All three are also available with master keying, which means that all locks can be opened with a single master key.

Key random means that the locks will be assigned arbitrarily at the factory with key numbers ranging from FR305 to FR454 (Master keying numbers: XF1001 to XF1150).

Tip: Random keying can mean that different furniture units will have the same key number. If you must have all locks keyed differently, you should specify key specific or key consecutive lock cylinders.

Key Random

FR305

FR421

FR305

or

XF1011

XF1042

XF1011

XF
Master
Key

Key specific means that you can specify any key number from FR305 to FR454 (Master keying numbers: XF1001 to XF1150). This option can be used to key all the furniture units in a workstation or department the same.

Tip: Designate the quantity per key number in your specification.

▶ See example at right.

Key Specific

FR350

FR350

FR350

or

XF1020

XF1020

XF1020

XF
Master
Key

Key consecutive means that you can specify lock numbers in a consecutive order to ensure that no two locks have the same key number until the key sequence repeats. You must select a beginning key number from FR305 to FR454 (Master keying numbers: XF1001 to XF1150).

Example of a typical lock cylinder specification is shown below:

10	LOCK9201FR FR320
5	LOCK9201FR FR350
15	LOCK9201XF XF1100

30 Total

1 877102003SR standard lock tool

1 877102002SR master lock tool

Key Consecutive

FR350

FR351

FR352

or

XF1020

XF1021

XF1022

XF
Master
Key

Field-Installed Lock Cylinders

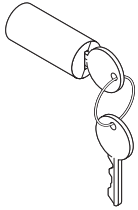

Tip: Lock price is included in price of furniture with locks.

Tip: For replacement lock cylinders, refer to Service Parts.

Standard Includes	Required to Specify
<ul style="list-style-type: none"> Lock cylinder, keyed random: 9201 Polished Chrome or 9250 Ember Chrome Two keys 	<ul style="list-style-type: none"> 1 Style number 2 Options, if selected (see below)

Options	Price	Required to Specify
Key specific	No cost	Select key number from FR305–FR454.
Key consecutive	No cost	Specify key consecutive and must select beginning key number from FR305–FR454.
Master key random	+\$24	Specify <i>master key random</i> . each
Master key specific	+\$24 each	Specify key number from XF1001–XF1150.
Master key consecutive	+\$24 each	Specify <i>master key consecutive</i> and must select beginning key number from XF1001–XF1150.

Specification Information		
Color	Style Number	Base Price

FR Series (Standard Keying System) – Lock Cylinder

Polished Chrome	LOCK9201FR	No cost
Ember Chrome	LOCK9250FR	No cost

Standard Lock Tool

	877102003SR	\$24
--	--------------------	------

XF Series (Master Keying System) – Lock Cylinder

Polished Chrome	LOCK9201XF	No additional cost. Price included in price of furniture with master-keyed locks.
Ember Chrome	LOCK9250XF	No additional cost. Price included in price of furniture with master-keyed locks.

Master Lock Tool

	877102002SR	\$24
--	--------------------	------

Tip: You can change lock cylinders in the field by using the appropriate lock tool.

Style Number Index

Style Number	Page	Description
32WCP	561	Wire Guide Clip
877102002SR	623	Master Lock Tool
877102003SR	623	Standard Lock Tool
98765	563	Termination Plate
98766	563	Cable/Fiber Reel
98767	562	Cord Reels
999CHT	561	Wire Clips
ASHC1921X1	246	Plastic Drawer
AWAA	560	Cable Tray
AWAC23212	70, 246	Wood Center Dwr
AWAD15B	290	Drawer Dividers
AWAD18B	290	Drawer Dividers
AWAF100	278	Felt Tape
AWAG2	70, 560	Round Grommet
AWAH	522	Suspn/Gang Hrdw Kit
AWAK	523	Cabinet Attachment Kit
AWAO141421V	510	Desktop Organizer
AWAO156021C	510	Desktop Organizer
AWAO157221C	510	Desktop Organizer
AWAP15B	290	Pencil Tray
AWAP18B	290	Pencil Tray
AWDR	620	Victor2 Display
AWNB6021V	64	Back Panel
AWNB7221V	64	Back Panel
AWQB	278	Bracket
AWQD422	276	Disk Column
AWQE45	274	WS Brace
AWQE51	274	WS Brace
AWQE57	274	WS Brace
AWQE69	274	WS Brace
AWQF	278	Bracket
AWQP4	276	Column
AWQT22	277	FS Table Bs
AWQT28	112, 277	FS Table Bs
AWRF254836	619	Victor2 Freestanding Unit
AWRF256036	619	Victor2 Freestanding Unit
AWRM183636	617	Victor2 Mobile Unit
AWTS	620	Victor2 Tray Shelf
AWVBC	558	Power/Data Box
AWVBD	558	Power/Power Box
AWVBP	558	Data/Data Box
AWVFP	70, 116, 557	Flip Up Power Unit
AWVW	562	Wire Mgr
CFLEXT24	108	Convvene; Metal Flex Base
CFLEXT30	108	Convvene; Metal Flex Base
CFLEXX24	108	Metal Flex Base
CFLEXX30	108	Metal Flex Base
CL_B3660	105	Convvene; Boat-Shape Lam Conf Tbl Top
CL_B3666	105	Convvene; Boat-Shape Lam Conf Tbl Top
CL_B3672	105	Convvene; Boat-Shape Lam Conf Tbl Top
CL_B3684	105	Convvene; Boat-Shape Lam Conf Tbl Top
CL_B42108	105	Convvene; Boat-Shape Lam Conf Tbl Top
CL_B4272	105	Convvene; Boat-Shape Lam Conf Tbl Top
CL_B4284	105	Convvene; Boat-Shape Lam Conf Tbl Top
CL_B4296	105	Convvene; Boat-Shape Lam Conf Tbl Top
CL_B48108	105	Convvene; Boat-Shape Lam Conf Tbl Top

Style Number	Page	Description
CL_B48120	105	Convvene; Boat-Shape Lam Conf Tbl Top
CL_B48144	105	Convvene; Boat-Shape Lam Conf Tbl Top
CL_B4884	105	Convvene; Boat-Shape Lam Conf Tbl Top
CL_B4896	105	Convvene; Boat-Shape Lam Conf Tbl Top
CL_B54108	105	Convvene; Boat-Shape Lam Conf Tbl Top
CL_B54120	105	Convvene; Boat-Shape Lam Conf Tbl Top
CL_B54144	105	Convvene; Boat-Shape Lam Conf Tbl Top
CL_B54168	105	Convvene; Boat-Shape Lam Conf Tbl Top
CL_B60120	105	Convvene; Boat-Shape Lam Conf Tbl Top
CL_B60144	105	Convvene; Boat-Shape Lam Conf Tbl Top
CL_B60168	105	Convvene; Boat-Shape Lam Conf Tbl Top
CL_B60192	105	Convvene; Boat-Shape Lam Conf Tbl Top
CL_B60216	105	Convvene; Boat-Shape Lam Conf Tbl Top
CL_B66144	105	Convvene; Boat-Shape Lam Conf Tbl Top
CL_B66168	105	Convvene; Boat-Shape Lam Conf Tbl Top
CL_B66192	105	Convvene; Boat-Shape Lam Conf Tbl Top
CL_B66216	105	Convvene; Boat-Shape Lam Conf Tbl Top
CL_B72168	105	Convvene; Boat-Shape Lam Conf Tbl Top
CL_B72192	105	Convvene; Boat-Shape Lam Conf Tbl Top
CL_B72216	105	Convvene; Boat-Shape Lam Conf Tbl Top
CL_C36	98	Convvene; Cushion Lam Conf Tbl Top
CL_C42	98	Convvene; Cushion Lam Conf Tbl Top
CL_C48	98	Convvene; Cushion Lam Conf Tbl Top
CL_C54	98	Convvene; Cushion Lam Conf Tbl Top
CL_C60	98	Convvene; Cushion Lam Conf Tbl Top
CL_J3660	101	Convvene; Oval Laminate Conf Tbl Top
CL_J3666	101	Convvene; Oval Laminate Conf Tbl Top
CL_J3672	101	Convvene; Oval Laminate Conf Tbl Top
CL_J3684	101	Convvene; Oval Laminate Conf Tbl Top
CL_J42108	101	Convvene; Oval Laminate Conf Tbl Top
CL_J4272	101	Convvene; Oval Laminate Conf Tbl Top
CL_J4284	101	Convvene; Oval Laminate Conf Tbl Top
CL_J4296	101	Convvene; Oval Laminate Conf Tbl Top
CL_J48108	101	Convvene; Oval Laminate Conf Tbl Top
CL_J48120	101	Convvene; Oval Laminate Conf Tbl Top
CL_J4884	101	Convvene; Oval Laminate Conf Tbl Top
CL_J4896	101	Convvene; Oval Laminate Conf Tbl Top
CL_J54108	101	Convvene; Oval Laminate Conf Tbl Top
CL_J54120	101	Convvene; Oval Laminate Conf Tbl Top
CL_J54144	101	Convvene; Oval Laminate Conf Tbl Top
CL_J60120	101	Convvene; Oval Laminate Conf Tbl Top
CL_J60144	101	Convvene; Oval Laminate Conf Tbl Top
CL_J60168	101	Convvene; Oval Laminate Conf Tbl Top
CL_J66144	101	Convvene; Oval Laminate Conf Tbl Top
CL_J66168	101	Convvene; Oval Laminate Conf Tbl Top
CL_J66192	101	Convvene; Oval Laminate Conf Tbl Top
CL_J72168	101	Convvene; Oval Laminate Conf Tbl Top
CL_J72192	101	Convvene; Oval Laminate Conf Tbl Top
CL_J72216	101	Convvene; Oval Laminate Conf Tbl Top
CL_K3660	107	Convvene; Racetrack Lam Conf Tbl Top
CL_K3666	107	Convvene; Racetrack Lam Conf Tbl Top
CL_K3672	107	Convvene; Racetrack Lam Conf Tbl Top
CL_K3684	107	Convvene; Racetrack Lam Conf Tbl Top
CL_K42108	107	Convvene; Racetrack Lam Conf Tbl Top
CL_K4272	107	Convvene; Racetrack Lam Conf Tbl Top
CL_K4284	107	Convvene; Racetrack Lam Conf Tbl Top

Style Number	Page	Description	Style Number	Page	Description
CL_K4296	107	Convener; Racetrack Lam Conf Tbl Top	CL_T66144	103	Convener; Rect Laminate Conf Tbl Top
CL_K48108	107	Convener; Racetrack Lam Conf Tbl Top	CL_T66168	103	Convener; Rect Laminate Conf Tbl Top
CL_K48120	107	Convener; Racetrack Lam Conf Tbl Top	CL_T66192	103	Convener; Rect Laminate Conf Tbl Top
CL_K48144	107	Convener; Racetrack Lam Conf Tbl Top	CL_T66216	103	Convener; Rect Laminate Conf Tbl Top
CL_K4884	107	Convener; Racetrack Lam Conf Tbl Top	CL_T72168	103	Convener; Rect Laminate Conf Tbl Top
CL_K4896	107	Convener; Racetrack Lam Conf Tbl Top	CL_T72192	103	Convener; Rect Laminate Conf Tbl Top
CL_K54108	107	Convener; Racetrack Lam Conf Tbl Top	CL_T72216	103	Convener; Rect Laminate Conf Tbl Top
CL_K54120	107	Convener; Racetrack Lam Conf Tbl Top	CW_B3660	93	Convener; Boat-Shape Wd Conf Tbl Top
CL_K54144	107	Convener; Racetrack Lam Conf Tbl Top	CW_B3666	93	Convener; Boat-Shape Wd Conf Tbl Top
CL_K54168	107	Convener; Racetrack Lam Conf Tbl Top	CW_B3672	93	Convener; Boat-Shape Wd Conf Tbl Top
CL_K60120	107	Convener; Racetrack Lam Conf Tbl Top	CW_B3684	93	Convener; Boat-Shape Wd Conf Tbl Top
CL_K60144	107	Convener; Racetrack Lam Conf Tbl Top	CW_B42108	93	Convener; Boat-Shape Wd Conf Tbl Top
CL_K60168	107	Convener; Racetrack Lam Conf Tbl Top	CW_B4272	93	Convener; Boat-Shape Wd Conf Tbl Top
CL_K60192	107	Convener; Racetrack Lam Conf Tbl Top	CW_B4284	93	Convener; Boat-Shape Wd Conf Tbl Top
CL_K60216	107	Convener; Racetrack Lam Conf Tbl Top	CW_B4296	93	Convener; Boat-Shape Wd Conf Tbl Top
CL_K66144	107	Convener; Racetrack Lam Conf Tbl Top	CW_B48108	93	Convener; Boat-Shape Wd Conf Tbl Top
CL_K66168	107	Convener; Racetrack Lam Conf Tbl Top	CW_B48120	93	Convener; Boat-Shape Wd Conf Tbl Top
CL_K66192	107	Convener; Racetrack Lam Conf Tbl Top	CW_B48144	93	Convener; Boat-Shape Wd Conf Tbl Top
CL_K66216	107	Convener; Racetrack Lam Conf Tbl Top	CW_B4884	93	Convener; Boat-Shape Wd Conf Tbl Top
CL_K72168	107	Convener; Racetrack Lam Conf Tbl Top	CW_B4896	93	Convener; Boat-Shape Wd Conf Tbl Top
CL_K72192	107	Convener; Racetrack Lam Conf Tbl Top	CW_B54108	93	Convener; Boat-Shape Wd Conf Tbl Top
CL_K72216	107	Convener; Racetrack Lam Conf Tbl Top	CW_B54120	93	Convener; Boat-Shape Wd Conf Tbl Top
CL_R36	96	Convener; Round Laminate Conf Tbl Top	CW_B54144	93	Convener; Boat-Shape Wd Conf Tbl Top
CL_R42	96	Convener; Round Laminate Conf Tbl Top	CW_B54168	93	Convener; Boat-Shape Wd Conf Tbl Top
CL_R48	96	Convener; Round Laminate Conf Tbl Top	CW_B60120	93	Convener; Boat-Shape Wd Conf Tbl Top
CL_R54	96	Convener; Round Laminate Conf Tbl Top	CW_B60144	93	Convener; Boat-Shape Wd Conf Tbl Top
CL_R60	96	Convener; Round Laminate Conf Tbl Top	CW_B60168	93	Convener; Boat-Shape Wd Conf Tbl Top
CL_R66	96	Convener; Round Laminate Conf Tbl Top	CW_B60192	93	Convener; Boat-Shape Wd Conf Tbl Top
CL_R72	96	Convener; Round Laminate Conf Tbl Top	CW_B60216	93	Convener; Boat-Shape Wd Conf Tbl Top
CL_S36	97	Convener; Sq Laminate Conf Table Top	CW_B66144	93	Convener; Boat-Shape Wd Conf Tbl Top
CL_S42	97	Convener; Sq Laminate Conf Table Top	CW_B66168	93	Convener; Boat-Shape Wd Conf Tbl Top
CL_S48	97	Convener; Sq Laminate Conf Table Top	CW_B66192	93	Convener; Boat-Shape Wd Conf Tbl Top
CL_S54	97	Convener; Sq Laminate Conf Table Top	CW_B66216	93	Convener; Boat-Shape Wd Conf Tbl Top
CL_S60	97	Convener; Sq Laminate Conf Table Top	CW_B72168	93	Convener; Boat-Shape Wd Conf Tbl Top
CL_T3660	103	Convener; Rect Laminate Conf Tbl Top	CW_B72192	93	Convener; Boat-Shape Wd Conf Tbl Top
CL_T3666	103	Convener; Rect Laminate Conf Tbl Top	CW_B72216	93	Convener; Boat-Shape Wd Conf Tbl Top
CL_T3672	103	Convener; Rect Laminate Conf Tbl Top	CW_C36	86	Convener; Cushion Wood Conf Table Top
CL_T3684	103	Convener; Rect Laminate Conf Tbl Top	CW_C42	86	Convener; Cushion Wood Conf Table Top
CL_T42108	103	Convener; Rect Laminate Conf Tbl Top	CW_C48	86	Convener; Cushion Wood Conf Table Top
CL_T4272	103	Convener; Rect Laminate Conf Tbl Top	CW_C54	86	Convener; Cushion Wood Conf Table Top
CL_T4284	103	Convener; Rect Laminate Conf Tbl Top	CW_C60	86	Convener; Cushion Wood Conf Table Top
CL_T4296	103	Convener; Rect Laminate Conf Tbl Top	CW_J3660	89	Convener; Oval Wood Conf Table Top
CL_T48108	103	Convener; Rect Laminate Conf Tbl Top	CW_J3666	89	Convener; Oval Wood Conf Table Top
CL_T48120	103	Convener; Rect Laminate Conf Tbl Top	CW_J3672	89	Convener; Oval Wood Conf Table Top
CL_T48144	103	Convener; Rect Laminate Conf Tbl Top	CW_J3684	89	Convener; Oval Wood Conf Table Top
CL_T4884	103	Convener; Rect Laminate Conf Tbl Top	CW_J42108	89	Convener; Oval Wood Conf Table Top
CL_T4896	103	Convener; Rect Laminate Conf Tbl Top	CW_J4272	89	Convener; Oval Wood Conf Table Top
CL_T54108	103	Convener; Rect Laminate Conf Tbl Top	CW_J4284	89	Convener; Oval Wood Conf Table Top
CL_T54120	103	Convener; Rect Laminate Conf Tbl Top	CW_J4296	89	Convener; Oval Wood Conf Table Top
CL_T54144	103	Convener; Rect Laminate Conf Tbl Top	CW_J48108	89	Convener; Oval Wood Conf Table Top
CL_T54168	103	Convener; Rect Laminate Conf Tbl Top	CW_J48120	89	Convener; Oval Wood Conf Table Top
CL_T60120	103	Convener; Rect Laminate Conf Tbl Top	CW_J4884	89	Convener; Oval Wood Conf Table Top
CL_T60144	103	Convener; Rect Laminate Conf Tbl Top	CW_J4896	89	Convener; Oval Wood Conf Table Top
CL_T60168	103	Convener; Rect Laminate Conf Tbl Top	CW_J54108	89	Convener; Oval Wood Conf Table Top
CL_T60192	103	Convener; Rect Laminate Conf Tbl Top	CW_J54120	89	Convener; Oval Wood Conf Table Top
CL_T60216	103	Convener; Rect Laminate Conf Tbl Top	CW_J54144	89	Convener; Oval Wood Conf Table Top

Style Number Index, continued

Style Number	Page	Description
CW_J60120	89	Convene; Oval Wood Conf Table Top
CW_J60144	89	Convene; Oval Wood Conf Table Top
CW_J60168	89	Convene; Oval Wood Conf Table Top
CW_J66144	89	Convene; Oval Wood Conf Table Top
CW_J66168	89	Convene; Oval Wood Conf Table Top
CW_J66192	89	Convene; Oval Wood Conf Table Top
CW_J72168	89	Convene; Oval Wood Conf Table Top
CW_J72192	89	Convene; Oval Wood Conf Table Top
CW_J72216	89	Convene; Oval Wood Conf Table Top
CW_K3660	95	Convene; Racetrack Wood Conf Tbl Top
CW_K3666	95	Convene; Racetrack Wood Conf Tbl Top
CW_K3672	95	Convene; Racetrack Wood Conf Tbl Top
CW_K3684	95	Convene; Racetrack Wood Conf Tbl Top
CW_K42108	95	Convene; Racetrack Wood Conf Tbl Top
CW_K4272	95	Convene; Racetrack Wood Conf Tbl Top
CW_K4284	95	Convene; Racetrack Wood Conf Tbl Top
CW_K4296	95	Convene; Racetrack Wood Conf Tbl Top
CW_K48108	95	Convene; Racetrack Wood Conf Tbl Top
CW_K48120	95	Convene; Racetrack Wood Conf Tbl Top
CW_K48144	95	Convene; Racetrack Wood Conf Tbl Top
CW_K4884	95	Convene; Racetrack Wood Conf Tbl Top
CW_K4896	95	Convene; Racetrack Wood Conf Tbl Top
CW_K54108	95	Convene; Racetrack Wood Conf Tbl Top
CW_K54120	95	Convene; Racetrack Wood Conf Tbl Top
CW_K54144	95	Convene; Racetrack Wood Conf Tbl Top
CW_K54168	95	Convene; Racetrack Wood Conf Tbl Top
CW_K60120	95	Convene; Racetrack Wood Conf Tbl Top
CW_K60144	95	Convene; Racetrack Wood Conf Tbl Top
CW_K60168	95	Convene; Racetrack Wood Conf Tbl Top
CW_K60192	95	Convene; Racetrack Wood Conf Tbl Top
CW_K60216	95	Convene; Racetrack Wood Conf Tbl Top
CW_K66144	95	Convene; Racetrack Wood Conf Tbl Top
CW_K66168	95	Convene; Racetrack Wood Conf Tbl Top
CW_K66192	95	Convene; Racetrack Wood Conf Tbl Top
CW_K66216	95	Convene; Racetrack Wood Conf Tbl Top
CW_K72168	95	Convene; Racetrack Wood Conf Tbl Top
CW_K72192	95	Convene; Racetrack Wood Conf Tbl Top
CW_K72216	95	Convene; Racetrack Wood Conf Tbl Top
CW_LEC	132	Convene; Lectern
CW_LECD	132	Convene; Lectern
CW_LECT	132	Convene; Lectern
CW_R36	84	Convene; Round Wood Conf Table Top
CW_R42	84	Convene; Round Wood Conf Table Top
CW_R48	84	Convene; Round Wood Conf Table Top
CW_R54	84	Convene; Round Wood Conf Table Top
CW_R60	84	Convene; Round Wood Conf Table Top
CW_R66	84	Convene; Round Wood Conf Table Top
CW_R72	84	Convene; Round Wood Conf Table Top
CW_S36	85	Convene; Square Wood Conf Table Top
CW_S42	85	Convene; Square Wood Conf Table Top
CW_S48	85	Convene; Square Wood Conf Table Top
CW_S54	85	Convene; Square Wood Conf Table Top
CW_S60	85	Convene; Square Wood Conf Table Top
CW_T3660	91	Convene; Rect Wood Conf Table Top
CW_T3666	91	Convene; Rect Wood Conf Table Top
CW_T3672	91	Convene; Rect Wood Conf Table Top

Style Number	Page	Description
CW_T3684	91	Convene; Rect Wood Conf Table Top
CW_T42108	91	Convene; Rect Wood Conf Table Top
CW_T4272	91	Convene; Rect Wood Conf Table Top
CW_T4284	91	Convene; Rect Wood Conf Table Top
CW_T4296	91	Convene; Rect Wood Conf Table Top
CW_T48108	91	Convene; Rect Wood Conf Table Top
CW_T48120	91	Convene; Rect Wood Conf Table Top
CW_T48144	91	Convene; Rect Wood Conf Table Top
CW_T4884	91	Convene; Rect Wood Conf Table Top
CW_T4896	91	Convene; Rect Wood Conf Table Top
CW_T54108	91	Convene; Rect Wood Conf Table Top
CW_T54120	91	Convene; Rect Wood Conf Table Top
CW_T54144	91	Convene; Rect Wood Conf Table Top
CW_T54168	91	Convene; Rect Wood Conf Table Top
CW_T60120	91	Convene; Rect Wood Conf Table Top
CW_T60144	91	Convene; Rect Wood Conf Table Top
CW_T60168	91	Convene; Rect Wood Conf Table Top
CW_T60192	91	Convene; Rect Wood Conf Table Top
CW_T60216	91	Convene; Rect Wood Conf Table Top
CW_T66144	91	Convene; Rect Wood Conf Table Top
CW_T66168	91	Convene; Rect Wood Conf Table Top
CW_T66192	91	Convene; Rect Wood Conf Table Top
CW_T66216	91	Convene; Rect Wood Conf Table Top
CW_T72168	91	Convene; Rect Wood Conf Table Top
CW_T72192	91	Convene; Rect Wood Conf Table Top
CW_T72216	91	Convene; Rect Wood Conf Table Top
CWADC6726	119	Convene; Storage Credenza
CWAWLB56	125, 133	Convene; Wallboard
CWAWLB70	125, 133	Convene; Wallboard
CWBD_3229	127	Convene; Storage Credenza
CWBD_3236	129	Convene; Buffet-Height Credenza
CWBD_6429	127	Convene; Storage Credenza
CWBD_6436	129	Convene; Buffet-Height Credenza
CWBD_8029	127	Convene; Storage Credenza
CWBD_8036	129	Convene; Buffet-Height Credenza
CWCDC6726	119	Convene; Storage Credenza
CWCIRC18	113	Convene; Circular Drum Base
CWCIRC24	113	Convene; Circular Drum Base
CWCIRC30	113	Convene; Circular Drum Base
CWCIRC36	113	Convene; Circular Drum Base
CWCIRT18	113	Convene; Circular Drum Base
CWCIRT24	113	Convene; Circular Drum Base
CWCIRT30	113	Convene; Circular Drum Base
CWCIRT36	113	Convene; Circular Drum Base
CWCLEC	124	Convene; Lectern
CWCLECD	124	Convene; Lectern
CWCLECDF	124	Convene; Lectern
CWCLECF	124	Convene; Lectern
CWCLECT	124	Convene; Lectern
CWDD_3229	127	Convene; Storage Credenza
CWDD_6429	127	Convene; Storage Credenza
CWDD_8029	127	Convene; Storage Credenza
CWDD_HP	131	Convene; Hospitality Cart
CWDD_MED	130	Convene; Media Cart
CWDDC4526	119	Convene; Storage Credenza
CWDDC4536	121	Convene; Buffet-Height Credenza

Style Number	Page	Description	Style Number	Page	Description
CWDDCHP	123	Convene; Hospitality Cart	CWUPC424	109	Convene; U-Panel Base
CWDL4526	119	Convene; Storage Credenza	CWUPC630	109	Convene; U-Panel Base
CWDL4536	121	Convene; Buffet-Height Credenza	CWUPC636	109	Convene; U-Panel Base
CWDL6726	119	Convene; Storage Credenza	CWXPC424	109	Convene; X-Panel Base
CWDL6736	121	Convene; Buffet-Height Credenza	CWXPC630	109	Convene; X-Panel Base
CWDR4526	119	Convene; Storage Credenza	CWXPC636	109	Convene; X-Panel Base
CWDR4536	121	Convene; Buffet-Height Credenza	DAC84	116	Technology Cover
CWDR6726	119	Convene; Storage Credenza	DAVC	562	Cable Riser
CWDR6736	121	Convene; Buffet-Height Credenza	DAVCE	562	Cable Riser Extn
CWDW_HP	131	Convene; Hospitality Cart	DAX84	116	Technology Cover
CWDW_MED	130	Convene; Media Cart	E6AB1514	522	Side Support Frame
CWDWC4526	119	Convene; Storage Credenza	E6AB1517	522	Side Support Frame
CWDWCHP	123	Convene; Hospitality Cart	E6AB1521	522	Side Support Frame
CWDWCMED	122	Convene; Media Cart	E6AB156S	522	Side Support Frame
CWDWCMEDF	122	Convene; Media Cart	E6AB157	522	Side Support Frame
CWELC24	115	Convene; Elliptical Drum Base	E6AB1714	522	Side Support Frame
CWELC30	115	Convene; Elliptical Drum Base	E6AB1717	522	Side Support Frame
CWELC36	115	Convene; Elliptical Drum Base	E6AB1721	522	Side Support Frame
CWELT24	115	Convene; Elliptical Drum Base	E6AB177	522	Side Support Frame
CWELT30	115	Convene; Elliptical Drum Base	E6AE15B	527	End Cover
CWELT36	115	Convene; Elliptical Drum Base	E6AE18	527	End Cover
CWHDC18	114	Convene; Half Drum Base	E6AE21	527	End Cover
CWHDC24	114	Convene; Half Drum Base	E6AJ45	295, 355	Cable Access Cover
CWHDC30	114	Convene; Half Drum Base	E6AL28V	530	Lgt. Valance
CWHDC36	114	Convene; Half Drum Base	E6AL30W	531	Lgt. Valance
CWHDT18	114	Convene; Half Drum Base	E6AL34V	530	Lgt. Valance
CWHDT24	114	Convene; Half Drum Base	E6AL36W	531	Lgt. Valance
CWHDT30	114	Convene; Half Drum Base	E6AL40V	530	Lgt. Valance
CWHDT36	114	Convene; Half Drum Base	E6AL42W	531	Lgt. Valance
CWLD_6429	127	Convene; Storage Credenza	E6AL46V	530	Light Valance
CWLD_8029	127	Convene; Storage Credenza	E6AL48W	531	Lgt. Valance
CWLF_3229	127	Convene; Storage Credenza	E6AL52V	530	Lgt. Valance
CWLL_6429	127	Convene; Storage Credenza	E6AL54W	531	Lgt. Valance
CWOD_3236	129	Convene; Buffet-Height Credenza	E6AL58V	530, 553	Lgt. Valance
CWOD_6436	129	Convene; Buffet-Height Credenza	E6AL60W	531	Lgt. Valance
CWOD_8036	129	Convene; Buffet-Height Credenza	E6AL64V	530, 553	Lgt. Valance
CWOS_HP	131	Convene; Hospitality Cart	E6AL66W	531	Lgt. Valance
CWOS_MED	130	Convene; Media Cart	E6AL70V	530, 553	Lgt. Valance
CWOSCHP	123	Convene; Hospitality Cart	E6AL72W	531	Lgt. Valance
CWOSCMED	122	Convene; Media Cart	E6AL76V	530, 553	Lgt. Valance
CWOSCMEDF	122	Convene; Media Cart	E6AL78W	531	Lgt. Valance
CWREC418	110	Convene; Rectangular Base	E6AL82V	530, 553	Lgt. Valance
CWREC424	110	Convene; Rectangular Base	E6AL84W	531	Lgt. Valance
CWREC630	110	Convene; Rectangular Base	E6AL88V	530, 553	Lgt. Valance
CWREC636	110	Convene; Rectangular Base	E6AL90W	531	Lgt. Valance
CWREF418	111	Convene; Rectangular Base	E6AL94V	530, 553	Lgt. Valance
CWREF424	111	Convene; Rectangular Base	E6AL96W	531	Lgt. Valance
CWREF630	111	Convene; Rectangular Base	E6AO151517S	523	Stacking Paper Orgzr
CWREF636	111	Convene; Rectangular Base	E6AO171517S	523	Stacking Paper Orgzr
CWRET418	110	Convene; Rectangular Base	E6AS12303	506	Accessory Shelf
CWRET424	110	Convene; Rectangular Base	E6AS12363	506	Accessory Shelf
CWRET630	110	Convene; Rectangular Base	E6AS12453	506	Accessory Shelf
CWRET636	110	Convene; Rectangular Base	E6AS12483	506	Accessory Shelf
CWTDC6726	119	Convene; Storage Credenza	E6AT1830	298	Cushion Top
CWTDC6736	121	Convene; Buffet-Height Credenza	E6AT1836	298	Cushion Top
CWUPC418	109	Convene; U-Panel Base	E6AT2430	298	Cushion Top

Style Number Index, continued

Style Number	Page	Description
E6AT2436	298	Cushion Top
E6BA14473S	508	Blade Accessory Shelf
E6BA14483O	508	Blade Accessory Shelf
E6BA14523M	509	Blade Accessory Shelf
E6BA14533S	508	Blade Accessory Shelf
E6BA14543O	508	Blade Accessory Shelf
E6BA14593S	508	Blade Accessory Shelf
E6BA14603O	508	Blade Accessory Shelf
E6BA14643M	509	Blade Accessory Shelf
E6BA14653S	508	Blade Accessory Shelf
E6BA14663O	508	Blade Accessory Shelf
E6BA14713S	508	Blade Accessory Shelf
E6BA14723O	508	Blade Accessory Shelf
E6BA14763M	509	Blade Accessory Shelf
E6BA14773S	508	Blade Accessory Shelf
E6BA14783O	508	Blade Accessory Shelf
E6BA14833S	508	Blade Accessory Shelf
E6BA14843O	508	Blade Accessory Shelf
E6BA14883M	509	Blade Accessory Shelf
E6BA14893S	508	Blade Accessory Shelf
E6BA14903O	508	Blade Accessory Shelf
E6BA14943M	509	Blade Accessory Shelf
E6BA14953S	508	Blade Accessory Shelf
E6BA14963O	508	Blade Accessory Shelf
E6BF152445D	316	Plinth Bs Bkcs
E6BF152445P	312	Plinth Bs Bkcs
E6BF152465D	316	Plinth Bs Bkcs
E6BF152465P	312	Plinth Bs Bkcs
E6BF152472D	317	Plinth Bs Bkcs
E6BF152472P	313	Plinth Bs Bkcs
E6BF152477D	317	Plinth Bs Bkcs
E6BF152477P	313	Plinth Bs Bkcs
E6BF153045D	316	Plinth Bs Bkcs
E6BF153045P	312	Plinth Bs Bkcs
E6BF153065D	316	Plinth Bs Bkcs
E6BF153065P	312	Plinth Bs Bkcs
E6BF153072D	317	Plinth Bs Bkcs
E6BF153072P	313	Plinth Bs Bkcs
E6BF153077D	317	Plinth Bs Bkcs
E6BF153077P	313	Plinth Bs Bkcs
E6BF153645D	316	Plinth Bs Bkcs
E6BF153645P	312	Plinth Bs Bkcs
E6BF153665D	316	Plinth Bs Bkcs
E6BF153665P	312	Plinth Bs Bkcs
E6BF153672D	317	Plinth Bs Bkcs
E6BF153672P	313	Plinth Bs Bkcs
E6BF153677D	317	Plinth Bs Bkcs
E6BF153677P	313	Plinth Bs Bkcs
E6BFL153045D	459	Leg Bs Bkcs
E6BFL153045P	456	Leg Bs Bkcs
E6BFL153065D	459	Leg Bs Bkcs
E6BFL153065P	457	Leg Bs Bkcs
E6BFL153072D	459	Leg Bs Bkcs
E6BFL153072P	457	Leg Bs Bkcs
E6BFL153645D	459	Leg Bs Bkcs
E6BFL153645P	456	Leg Bs Bkcs

Style Number	Page	Description
E6BFL153665D	459	Leg Bs Bkcs
E6BFL153665P	457	Leg Bs Bkcs
E6BFL153672D	459	Leg Bs Bkcs
E6BFL153672P	457	Leg Bs Bkcs
E6BR30	275	Tower Brace
E6BS151536L	322, 463	Stacking Bkcs
E6BS151536P	318, 461	Stacking Bkcs
E6BS151536R	322, 463	Stacking Bkcs
E6BS151543L	322, 464	Stacking Bkcs
E6BS151543P	319, 461	Stacking Bkcs
E6BS151543R	322, 464	Stacking Bkcs
E6BS151548L	323, 464	Stacking Bkcs
E6BS151548P	319, 461	Stacking Bkcs
E6BS151548R	323, 464	Stacking Bkcs
E6BS151836L	322, 463	Stacking Bkcs
E6BS151836P	318, 461	Stacking Bkcs
E6BS151836R	322, 463	Stacking Bkcs
E6BS151843L	322, 464	Stacking Bkcs
E6BS151843P	319, 461	Stacking Bkcs
E6BS151843R	322, 464	Stacking Bkcs
E6BS151848L	323, 464	Stacking Bkcs
E6BS151848P	319, 461	Stacking Bkcs
E6BS151848R	323, 464	Stacking Bkcs
E6BS153036D	322, 463	Stacking Bkcs
E6BS153036P	318, 461	Stacking Bkcs
E6BS153043D	322, 464	Stacking Bkcs
E6BS153043P	319, 461	Stacking Bkcs
E6BS153048D	323, 464	Stacking Bkcs
E6BS153048P	319, 461	Stacking Bkcs
E6BS153636D	322, 463	Stacking Bkcs
E6BS153636P	318, 461	Stacking Bkcs
E6BS153643D	322, 464	Stacking Bkcs
E6BS153643P	319, 461	Stacking Bkcs
E6BS153648D	323, 464	Stacking Bkcs
E6BS153648P	319, 461	Stacking Bkcs
E6C1830C	351	Leg Bs 27 1/2"H Stg
E6C1830F	351	Leg Bs 27 1/2"H Stg
E6C1830H	351	Leg Bs 27 1/2"H Stg
E6C1830M	349	Leg Bs 27 1/2"H Stg
E6C1830U	351	Leg Bs 27 1/2"H Stg
E6C1836K	351	Leg Bs 27 1/2"H Stg
E6C1836P	349	Leg Bs 27 1/2"H Stg
E6C1836S	351	Leg Bs 27 1/2"H Stg
E6C1836T	351	Leg Bs 27 1/2"H Stg
E6C1836V	351	Leg Bs 27 1/2"H Stg
E6C1860CC	375	60"W Lg Bs Cred
E6C1860CF	375	60"W Lg Bs Cred
E6C1860FC	375	60"W Lg Bs Cred
E6C1860FF	375	60"W Lg Bs Cred
E6C1860HH	375	60"W Lg Bs Cred
E6C1860MM	365	60"W Lg Bs Cred
E6C1860UU	375	60"W Lg Bs Cred
E6C1866MP	367	66"W Lg Bs Cred
E6C1866PM	367	66"W Lg Bs Cred
E6C1872KK	377	72"W Lg Bs Cred
E6C1872PP	369	72"W Lg Bs Cred

Style Number	Page	Description	Style Number	Page	Description
E6C1872SS	377	72"W Lg Bs Cred	E6C24102A2IG	437	102"W Lg Bs Cred
E6C1872TT	377	72"W Lg Bs Cred	E6C24102A2JD	437	102"W Lg Bs Cred
E6C1872VV	377	72"W Lg Bs Cred	E6C24102A2JE	437	102"W Lg Bs Cred
E6C1890CCF	379	90"W Lg Bs Cred	E6C24102A2JG	437	102"W Lg Bs Cred
E6C1890CFF	379	90"W Lg Bs Cred	E6C24102A2LD	437	102"W Lg Bs Cred
E6C1890FCC	379	90"W Lg Bs Cred	E6C24102A2LE	437	102"W Lg Bs Cred
E6C1890FFC	379	90"W Lg Bs Cred	E6C24102A2LG	437	102"W Lg Bs Cred
E6C1890FFH	379	90"W Lg Bs Cred	E6C24102A5BI	441	102"W Lg Bs Cred
E6C1890FFU	379	90"W Lg Bs Cred	E6C24102A5BJ	441	102"W Lg Bs Cred
E6C1890FHH	379	90"W Lg Bs Cred	E6C24102A5BL	441	102"W Lg Bs Cred
E6C1890FUU	379	90"W Lg Bs Cred	E6C24102A6BD	442	102"W Lg Bs Cred
E6C1890HFF	379	90"W Lg Bs Cred	E6C24102A6BE	442	102"W Lg Bs Cred
E6C1890HHF	379	90"W Lg Bs Cred	E6C24102A6BG	442	102"W Lg Bs Cred
E6C1890MMM	371	90"W Lg Bs Cred	E6C24102A6BB	443	102"W Lg Bs Cred
E6C1890UFF	379	90"W Lg Bs Cred	E6C24102A8I	443	102"W Lg Bs Cred
E6C1890UUF	379	90"W Lg Bs Cred	E6C24102A8J	443	102"W Lg Bs Cred
E6C1896FCK	381	96"W Lg Bs Cred	E6C24102A8L	443	102"W Lg Bs Cred
E6C1896FFK	381	96"W Lg Bs Cred	E6C24102A9AA	444	102"W Lg Bs Cred
E6C1896FFT	381	96"W Lg Bs Cred	E6C24102A9D	444	102"W Lg Bs Cred
E6C1896FFV	381	96"W Lg Bs Cred	E6C24102A9E	444	102"W Lg Bs Cred
E6C1896FHT	381	96"W Lg Bs Cred	E6C24102A9G	444	102"W Lg Bs Cred
E6C1896FUV	381	96"W Lg Bs Cred	E6C24102AAA9	444	102"W Lg Bs Cred
E6C1896KCF	381	96"W Lg Bs Cred	E6C24102BA5I	441	102"W Lg Bs Cred
E6C1896KFF	381	96"W Lg Bs Cred	E6C24102BA5J	441	102"W Lg Bs Cred
E6C1896MPM	373	96"W Lg Bs Cred	E6C24102BA5L	441	102"W Lg Bs Cred
E6C1896TFF	381	96"W Lg Bs Cred	E6C24102BBA8	443	102"W Lg Bs Cred
E6C1896VFF	381	96"W Lg Bs Cred	E6C24102DA2I	439	102"W Lg Bs Cred
E6C1896VUF	381	96"W Lg Bs Cred	E6C24102DA2J	439	102"W Lg Bs Cred
E6C23300	349	Leg Bs 21½"H Stg	E6C24102DA2L	439	102"W Lg Bs Cred
E6C2336R	349	Leg Bs 21½"H Stg	E6C24102DA3D	440	102"W Lg Bs Cred
E6C236000	365	Leg Bs 21½"H Stg	E6C24102DA3E	440	102"W Lg Bs Cred
E6C2366OR	367	Leg Bs 21½"H Stg	E6C24102DA3G	440	102"W Lg Bs Cred
E6C2366RO	367	Leg Bs 21½"H Stg	E6C24102DA9	444	102"W Lg Bs Cred
E6C2372RR	369	72"W Lg Bs Cred	E6C24102DBA6	442	102"W Lg Bs Cred
E6C2390000	371	Leg Bs 21½"H Stg	E6C24102DIA2	438	102"W Lg Bs Cred
E6C2396ORO	373	Leg Bs 21½"H Stg	E6C24102DJA2	438	102"W Lg Bs Cred
E6C24102A1II	435	102"W Lg Bs Cred	E6C24102DLA2	438	102"W Lg Bs Cred
E6C24102A1IJ	435	102"W Lg Bs Cred	E6C24102EA2I	439	102"W Lg Bs Cred
E6C24102A1IL	435	102"W Lg Bs Cred	E6C24102EA2J	439	102"W Lg Bs Cred
E6C24102A1JI	435	102"W Lg Bs Cred	E6C24102EA2L	439	102"W Lg Bs Cred
E6C24102A1JJ	435	102"W Lg Bs Cred	E6C24102EA3D	440	102"W Lg Bs Cred
E6C24102A1JL	435	102"W Lg Bs Cred	E6C24102EA3E	440	102"W Lg Bs Cred
E6C24102A1LI	435	102"W Lg Bs Cred	E6C24102EA3G	440	102"W Lg Bs Cred
E6C24102A1LJ	435	102"W Lg Bs Cred	E6C24102EA9	444	102"W Lg Bs Cred
E6C24102A1LL	435	102"W Lg Bs Cred	E6C24102EBA6	442	102"W Lg Bs Cred
E6C24102A2DI	437	102"W Lg Bs Cred	E6C24102EIA2	438	102"W Lg Bs Cred
E6C24102A2DJ	437	102"W Lg Bs Cred	E6C24102EJA2	438	102"W Lg Bs Cred
E6C24102A2DL	437	102"W Lg Bs Cred	E6C24102ELA2	438	102"W Lg Bs Cred
E6C24102A2EI	437	102"W Lg Bs Cred	E6C24102GA2I	439	102"W Lg Bs Cred
E6C24102A2EJ	437	102"W Lg Bs Cred	E6C24102GA2J	439	102"W Lg Bs Cred
E6C24102A2EL	437	102"W Lg Bs Cred	E6C24102GA2L	439	102"W Lg Bs Cred
E6C24102A2GI	437	102"W Lg Bs Cred	E6C24102GA3D	440	102"W Lg Bs Cred
E6C24102A2GJ	437	102"W Lg Bs Cred	E6C24102GA3E	440	102"W Lg Bs Cred
E6C24102A2GL	437	102"W Lg Bs Cred	E6C24102GA3G	440	102"W Lg Bs Cred
E6C24102A2ID	437	102"W Lg Bs Cred	E6C24102GA9	444	102"W Lg Bs Cred
E6C24102A2IE	437	102"W Lg Bs Cred	E6C24102GBA6	442	102"W Lg Bs Cred

Style Number Index, continued

Style Number	Page	Description
E6C24102GIA2	438	102"W Lg Bs Cred
E6C24102GJA2	438	102"W Lg Bs Cred
E6C24102GLA2	438	102"W Lg Bs Cred
E6C24102IA1I	436	102"W Lg Bs Cred
E6C24102IA1J	436	102"W Lg Bs Cred
E6C24102IA1L	436	102"W Lg Bs Cred
E6C24102IA2D	439	102"W Lg Bs Cred
E6C24102IA2E	439	102"W Lg Bs Cred
E6C24102IA2G	439	102"W Lg Bs Cred
E6C24102IA5B	441	102"W Lg Bs Cred
E6C24102IA8	443	102"W Lg Bs Cred
E6C24102IBA5	441	102"W Lg Bs Cred
E6C24102IDA2	438	102"W Lg Bs Cred
E6C24102IEA2	438	102"W Lg Bs Cred
E6C24102IGA2	438	102"W Lg Bs Cred
E6C24102IIA1	435	102"W Lg Bs Cred
E6C24102IJA1	435	102"W Lg Bs Cred
E6C24102ILA1	435	102"W Lg Bs Cred
E6C24102JA1I	436	102"W Lg Bs Cred
E6C24102JA1J	436	102"W Lg Bs Cred
E6C24102JA1L	436	102"W Lg Bs Cred
E6C24102JA2D	439	102"W Lg Bs Cred
E6C24102JA2E	439	102"W Lg Bs Cred
E6C24102JA2G	439	102"W Lg Bs Cred
E6C24102JA5B	441	102"W Lg Bs Cred
E6C24102JA8	443	102"W Lg Bs Cred
E6C24102JBA5	441	102"W Lg Bs Cred
E6C24102JDA2	438	102"W Lg Bs Cred
E6C24102JEA2	438	102"W Lg Bs Cred
E6C24102JGA2	438	102"W Lg Bs Cred
E6C24102JIA1	435	102"W Lg Bs Cred
E6C24102JJA1	435	102"W Lg Bs Cred
E6C24102JLA1	435	102"W Lg Bs Cred
E6C24102LA1I	436	102"W Lg Bs Cred
E6C24102LA1J	436	102"W Lg Bs Cred
E6C24102LA1L	436	102"W Lg Bs Cred
E6C24102LA2D	439	102"W Lg Bs Cred
E6C24102LA2E	439	102"W Lg Bs Cred
E6C24102LA2G	439	102"W Lg Bs Cred
E6C24102LA5B	441	102"W Lg Bs Cred
E6C24102LA8	443	102"W Lg Bs Cred
E6C24102LBA5	441	102"W Lg Bs Cred
E6C24102LDA2	438	102"W Lg Bs Cred
E6C24102LEA2	438	102"W Lg Bs Cred
E6C24102LGA2	438	102"W Lg Bs Cred
E6C24102LIA1	435	102"W Lg Bs Cred
E6C24102LJA1	435	102"W Lg Bs Cred
E6C24102LLA1	435	102"W Lg Bs Cred
E6C24108A2II	447	108"W Lg Bs Cred
E6C24108A2IJ	447	108"W Lg Bs Cred
E6C24108A2IL	447	108"W Lg Bs Cred
E6C24108A2JI	447	108"W Lg Bs Cred
E6C24108A2JJ	447	108"W Lg Bs Cred
E6C24108A2JL	447	108"W Lg Bs Cred
E6C24108A2LI	447	108"W Lg Bs Cred
E6C24108A2LJ	447	108"W Lg Bs Cred

Style Number	Page	Description
E6C24108A2LL	447	108"W Lg Bs Cred
E6C24108A5DD	449	108"W Lg Bs Cred
E6C24108A5DE	449	108"W Lg Bs Cred
E6C24108A5DG	449	108"W Lg Bs Cred
E6C24108A5ED	449	108"W Lg Bs Cred
E6C24108A5EE	449	108"W Lg Bs Cred
E6C24108A5EG	449	108"W Lg Bs Cred
E6C24108A5GD	449	108"W Lg Bs Cred
E6C24108A5GE	449	108"W Lg Bs Cred
E6C24108A5GG	449	108"W Lg Bs Cred
E6C24108A6BI	450	108"W Lg Bs Cred
E6C24108A6BJ	450	108"W Lg Bs Cred
E6C24108A6BL	450	108"W Lg Bs Cred
E6C24108A7BD	451	108"W Lg Bs Cred
E6C24108A7BE	451	108"W Lg Bs Cred
E6C24108A7BG	451	108"W Lg Bs Cred
E6C24108A9BB	452	108"W Lg Bs Cred
E6C24108A9I	452	108"W Lg Bs Cred
E6C24108A9J	452	108"W Lg Bs Cred
E6C24108A9L	452	108"W Lg Bs Cred
E6C24108BBA9	452	108"W Lg Bs Cred
E6C24108DA3I	448	108"W Lg Bs Cred
E6C24108DA3J	448	108"W Lg Bs Cred
E6C24108DA3L	448	108"W Lg Bs Cred
E6C24108DA5D	449	108"W Lg Bs Cred
E6C24108DA5E	449	108"W Lg Bs Cred
E6C24108DA5G	449	108"W Lg Bs Cred
E6C24108DBA7	451	108"W Lg Bs Cred
E6C24108DDA5	449	108"W Lg Bs Cred
E6C24108DEA5	449	108"W Lg Bs Cred
E6C24108DGA5	449	108"W Lg Bs Cred
E6C24108EA3I	448	108"W Lg Bs Cred
E6C24108EA3J	448	108"W Lg Bs Cred
E6C24108EA3L	448	108"W Lg Bs Cred
E6C24108EA5D	449	108"W Lg Bs Cred
E6C24108EA5E	449	108"W Lg Bs Cred
E6C24108EA5G	449	108"W Lg Bs Cred
E6C24108EBA7	451	108"W Lg Bs Cred
E6C24108EDA5	449	108"W Lg Bs Cred
E6C24108EEA5	449	108"W Lg Bs Cred
E6C24108EGA5	449	108"W Lg Bs Cred
E6C24108GA3I	448	108"W Lg Bs Cred
E6C24108GA3J	448	108"W Lg Bs Cred
E6C24108GA3L	448	108"W Lg Bs Cred
E6C24108GA5D	449	108"W Lg Bs Cred
E6C24108GA5E	449	108"W Lg Bs Cred
E6C24108GA5G	449	108"W Lg Bs Cred
E6C24108GBA7	451	108"W Lg Bs Cred
E6C24108GDA5	449	108"W Lg Bs Cred
E6C24108GEA5	449	108"W Lg Bs Cred
E6C24108GGA5	449	108"W Lg Bs Cred
E6C24108IA2I	447	108"W Lg Bs Cred
E6C24108IA2J	447	108"W Lg Bs Cred
E6C24108IA2L	447	108"W Lg Bs Cred
E6C24108IA3D	448	108"W Lg Bs Cred
E6C24108IA3E	448	108"W Lg Bs Cred

Style Number	Page	Description	Style Number	Page	Description
E6C24108IA3G	448	108"W Lg Bs Cred	E6C2448GB	385	48"W Leg Bs Cred
E6C24108IA9	452	108"W Lg Bs Cred	E6C2454A6	455	Kneewell
E6C24108IBA6	450	108"W Lg Bs Cred	E6C2454BI	387	54"W Leg Bs Cred
E6C24108IIA2	447	108"W Lg Bs Cred	E6C2454BJ	387	54"W Leg Bs Cred
E6C24108IJA2	447	108"W Lg Bs Cred	E6C2454BL	387	54"W Leg Bs Cred
E6C24108ILA2	447	108"W Lg Bs Cred	E6C2454IB	387	54"W Leg Bs Cred
E6C24108JA2I	447	108"W Lg Bs Cred	E6C2454JB	387	54"W Leg Bs Cred
E6C24108JA2J	447	108"W Lg Bs Cred	E6C2454LB	387	54"W Leg Bs Cred
E6C24108JA2L	447	108"W Lg Bs Cred	E6C2460A1AA	390	60"W Leg Bs Cred
E6C24108JA3D	448	108"W Lg Bs Cred	E6C2460A1D	390	60"W Leg Bs Cred
E6C24108JA3E	448	108"W Lg Bs Cred	E6C2460A1E	390	60"W Leg Bs Cred
E6C24108JA3G	448	108"W Lg Bs Cred	E6C2460A1G	390	60"W Leg Bs Cred
E6C24108JA9	452	108"W Lg Bs Cred	E6C2460A7	455	Kneewell
E6C24108JBA6	450	108"W Lg Bs Cred	E6C2460AA1A	390	60"W Leg Bs Cred
E6C24108JIA2	447	108"W Lg Bs Cred	E6C2460AAA1	390	60"W Leg Bs Cred
E6C24108JJA2	447	108"W Lg Bs Cred	E6C2460AAD	389	60"W Leg Bs Cred
E6C24108JLA2	447	108"W Lg Bs Cred	E6C2460AAE	389	60"W Leg Bs Cred
E6C24108LA2I	447	108"W Lg Bs Cred	E6C2460AAG	389	60"W Leg Bs Cred
E6C24108LA2J	447	108"W Lg Bs Cred	E6C2460DA1	390	60"W Leg Bs Cred
E6C24108LA2L	447	108"W Lg Bs Cred	E6C2460DAA	389	60"W Leg Bs Cred
E6C24108LA3D	448	108"W Lg Bs Cred	E6C2460DD	389	60"W Leg Bs Cred
E6C24108LA3E	448	108"W Lg Bs Cred	E6C2460DE	389	60"W Leg Bs Cred
E6C24108LA3G	448	108"W Lg Bs Cred	E6C2460DG	389	60"W Leg Bs Cred
E6C24108LA9	452	108"W Lg Bs Cred	E6C2460EA1	390	60"W Leg Bs Cred
E6C24108LBA6	450	108"W Lg Bs Cred	E6C2460EAA	389	60"W Leg Bs Cred
E6C24108LIA2	447	108"W Lg Bs Cred	E6C2460ED	389	60"W Leg Bs Cred
E6C24108LJA2	447	108"W Lg Bs Cred	E6C2460EE	389	60"W Leg Bs Cred
E6C24108LLA2	447	108"W Lg Bs Cred	E6C2460EG	389	60"W Leg Bs Cred
E6C2415A	353	24"D Leg Bs Stg	E6C2460GA1	390	60"W Leg Bs Cred
E6C2418B	353	24"D Leg Bs Stg	E6C2460GAA	389	60"W Leg Bs Cred
E6C2430A1	454	Kneewell	E6C2460GD	389	60"W Leg Bs Cred
E6C2430AA	353	24"D Leg Bs Stg	E6C2460GE	389	60"W Leg Bs Cred
E6C2430D	353	24"D Leg Bs Stg	E6C2460GG	389	60"W Leg Bs Cred
E6C2430E	354	24"D Leg Bs Stg	E6C2460NN	365	60"W Leg Bs Cred
E6C2430G	354	24"D Leg Bs Stg	E6C2460NO	365	60"W Leg Bs Cred
E6C2430N	349	24"D Leg Bs Stg	E6C2460ON	365	60"W Leg Bs Cred
E6C2436A2	454	Kneewell	E6C2466A1BB	395	66"W Leg Bs Cred
E6C2436BB	353	24"D Leg Bs Stg	E6C2466A1I	395	66"W Leg Bs Cred
E6C2436I	353	24"D Leg Bs Stg	E6C2466A1J	395	66"W Leg Bs Cred
E6C2436J	354	24"D Leg Bs Stg	E6C2466A1L	395	66"W Leg Bs Cred
E6C2436L	354	24"D Leg Bs Stg	E6C2466A2AA	396	66"W Leg Bs Cred
E6C2436Q	349	24"D Leg Bs Stg	E6C2466A2D	396	66"W Leg Bs Cred
E6C2442A3	454	Kneewell	E6C2466A2E	396	66"W Leg Bs Cred
E6C2445AAA	383	45"W Leg Bs Cred	E6C2466A2G	396	66"W Leg Bs Cred
E6C2445AD	383	45"W Leg Bs Cred	E6C2466A8	455	Kneewell
E6C2445AE	383	45"W Leg Bs Cred	E6C2466AA2A	396	66"W Leg Bs Cred
E6C2445AG	383	45"W Leg Bs Cred	E6C2466AAA2	396	66"W Leg Bs Cred
E6C2445DA	383	45"W Leg Bs Cred	E6C2466AAI	393	66"W Leg Bs Cred
E6C2445EA	383	45"W Leg Bs Cred	E6C2466AAJ	393	66"W Leg Bs Cred
E6C2445GA	383	45"W Leg Bs Cred	E6C2466AAL	393	66"W Leg Bs Cred
E6C2448A5	455	Kneewell	E6C2466BA1B	395	66"W Leg Bs Cred
E6C2448BD	385	48"W Leg Bs Cred	E6C2466BBA1	395	66"W Leg Bs Cred
E6C2448BE	385	48"W Leg Bs Cred	E6C2466BBD	393	66"W Leg Bs Cred
E6C2448BG	385	48"W Leg Bs Cred	E6C2466BBE	393	66"W Leg Bs Cred
E6C2448DB	385	48"W Leg Bs Cred	E6C2466BBG	393	66"W Leg Bs Cred
E6C2448EB	385	48"W Leg Bs Cred	E6C2466DA2	396	66"W Leg Bs Cred

Style Number Index, continued

Style Number	Page	Description
E6C2466DBB	393	66"W Leg Bs Cred
E6C2466DI	394	66"W Leg Bs Cred
E6C2466DJ	394	66"W Leg Bs Cred
E6C2466DL	394	66"W Leg Bs Cred
E6C2466EA2	396	66"W Leg Bs Cred
E6C2466EBB	393	66"W Leg Bs Cred
E6C2466EI	394	66"W Leg Bs Cred
E6C2466EJ	394	66"W Leg Bs Cred
E6C2466EL	394	66"W Leg Bs Cred
E6C2466GA2	396	66"W Leg Bs Cred
E6C2466GBB	393	66"W Leg Bs Cred
E6C2466GI	394	66"W Leg Bs Cred
E6C2466GJ	394	66"W Leg Bs Cred
E6C2466GL	394	66"W Leg Bs Cred
E6C2466IA1	395	66"W Leg Bs Cred
E6C2466IAA	393	66"W Leg Bs Cred
E6C2466ID	394	66"W Leg Bs Cred
E6C2466IE	394	66"W Leg Bs Cred
E6C2466IG	394	66"W Leg Bs Cred
E6C2466JA1	395	66"W Leg Bs Cred
E6C2466JAA	393	66"W Leg Bs Cred
E6C2466JD	394	66"W Leg Bs Cred
E6C2466JE	394	66"W Leg Bs Cred
E6C2466JG	394	66"W Leg Bs Cred
E6C2466LA1	395	66"W Leg Bs Cred
E6C2466LAA	393	66"W Leg Bs Cred
E6C2466LD	394	66"W Leg Bs Cred
E6C2466LE	394	66"W Leg Bs Cred
E6C2466LG	394	66"W Leg Bs Cred
E6C2466NQ	367	66"W Leg Bs Cred
E6C2466NR	367	66"W Leg Bs Cred
E6C2466OQ	367	66"W Leg Bs Cred
E6C2466QN	367	66"W Leg Bs Cred
E6C2466QO	367	66"W Leg Bs Cred
E6C2466RN	367	66"W Leg Bs Cred
E6C2472A2BB	400	72"W Leg Bs Cred
E6C2472A2I	400	72"W Leg Bs Cred
E6C2472A2J	400	72"W Leg Bs Cred
E6C2472A2L	400	72"W Leg Bs Cred
E6C2472A6B	401	72"W Leg Bs Cred
E6C2472A9	455	Kneewell
E6C2472AA3A	401	72"W Leg Bs Cred
E6C2472BA2B	400	72"W Leg Bs Cred
E6C2472BA6	401	72"W Leg Bs Cred
E6C2472BBA2	400	72"W Leg Bs Cred
E6C2472BBI	399	72"W Leg Bs Cred
E6C2472BBJ	399	72"W Leg Bs Cred
E6C2472BBL	399	72"W Leg Bs Cred
E6C2472IA2	400	72"W Leg Bs Cred
E6C2472IBB	399	72"W Leg Bs Cred
E6C2472II	399	72"W Leg Bs Cred
E6C2472IJ	399	72"W Leg Bs Cred
E6C2472IL	399	72"W Leg Bs Cred
E6C2472JA2	400	72"W Leg Bs Cred
E6C2472JBB	399	72"W Leg Bs Cred
E6C2472JI	399	72"W Leg Bs Cred

Style Number	Page	Description
E6C2472JJ	399	72"W Leg Bs Cred
E6C2472JL	399	72"W Leg Bs Cred
E6C2472LA2	400	72"W Leg Bs Cred
E6C2472LBB	399	72"W Leg Bs Cred
E6C2472LI	399	72"W Leg Bs Cred
E6C2472LJ	399	72"W Leg Bs Cred
E6C2472LL	399	72"W Leg Bs Cred
E6C2472QQ	369	72"W Leg Bs Cred
E6C2472QR	369	72"W Leg Bs Cred
E6C2472RQ	369	72"W Leg Bs Cred
E6C2478A1BD	404	78"W Leg Bs Cred
E6C2478A1BE	404	78"W Leg Bs Cred
E6C2478A1BG	404	78"W Leg Bs Cred
E6C2478A1DB	404	78"W Leg Bs Cred
E6C2478A1EB	404	78"W Leg Bs Cred
E6C2478A1GB	404	78"W Leg Bs Cred
E6C2478A7B	405	78"W Leg Bs Cred
E6C2478AA5A	405	78"W Leg Bs Cred
E6C2478BA1D	404	78"W Leg Bs Cred
E6C2478BA1E	404	78"W Leg Bs Cred
E6C2478BA1G	404	78"W Leg Bs Cred
E6C2478BA3B	405	78"W Leg Bs Cred
E6C2478BA7	405	78"W Leg Bs Cred
E6C2478BDA1	404	78"W Leg Bs Cred
E6C2478BDD	403	78"W Leg Bs Cred
E6C2478BDE	403	78"W Leg Bs Cred
E6C2478BDG	403	78"W Leg Bs Cred
E6C2478BEA1	404	78"W Leg Bs Cred
E6C2478BED	403	78"W Leg Bs Cred
E6C2478BEE	403	78"W Leg Bs Cred
E6C2478BEG	403	78"W Leg Bs Cred
E6C2478BGA1	404	78"W Leg Bs Cred
E6C2478BGD	403	78"W Leg Bs Cred
E6C2478BGE	403	78"W Leg Bs Cred
E6C2478BGG	403	78"W Leg Bs Cred
E6C2478DA1B	404	78"W Leg Bs Cred
E6C2478DBA1	404	78"W Leg Bs Cred
E6C2478DBE	403	78"W Leg Bs Cred
E6C2478DBG	403	78"W Leg Bs Cred
E6C2478DDB	403	78"W Leg Bs Cred
E6C2478DEB	403	78"W Leg Bs Cred
E6C2478DGB	403	78"W Leg Bs Cred
E6C2478EA1B	404	78"W Leg Bs Cred
E6C2478EBA1	404	78"W Leg Bs Cred
E6C2478EBD	403	78"W Leg Bs Cred
E6C2478EBG	403	78"W Leg Bs Cred
E6C2478EDB	403	78"W Leg Bs Cred
E6C2478EEB	403	78"W Leg Bs Cred
E6C2478EGB	403	78"W Leg Bs Cred
E6C2478GA1B	404	78"W Leg Bs Cred
E6C2478GBA1	404	78"W Leg Bs Cred
E6C2478GBD	403	78"W Leg Bs Cred
E6C2478GBE	403	78"W Leg Bs Cred
E6C2478GDB	403	78"W Leg Bs Cred
E6C2478GEB	403	78"W Leg Bs Cred
E6C2478GGB	403	78"W Leg Bs Cred

Style Number	Page	Description
E6C2484A1BI	409	84"W Leg Bs Cred
E6C2484A1BJ	409	84"W Leg Bs Cred
E6C2484A1BL	409	84"W Leg Bs Cred
E6C2484A1IB	409	84"W Leg Bs Cred
E6C2484A1JB	409	84"W Leg Bs Cred
E6C2484A1LB	409	84"W Leg Bs Cred
E6C2484A2BD	410	84"W Leg Bs Cred
E6C2484A2BE	410	84"W Leg Bs Cred
E6C2484A2BG	410	84"W Leg Bs Cred
E6C2484A2DB	410	84"W Leg Bs Cred
E6C2484A2EB	410	84"W Leg Bs Cred
E6C2484A2GB	410	84"W Leg Bs Cred
E6C2484A6AA	411	84"W Leg Bs Cred
E6C2484A6D	411	84"W Leg Bs Cred
E6C2484A6E	411	84"W Leg Bs Cred
E6C2484A6G	411	84"W Leg Bs Cred
E6C2484A8B	411	84"W Leg Bs Cred
E6C2484AAA6	411	84"W Leg Bs Cred
E6C2484BA1I	409	84"W Leg Bs Cred
E6C2484BA1J	409	84"W Leg Bs Cred
E6C2484BA1L	409	84"W Leg Bs Cred
E6C2484BA2D	410	84"W Leg Bs Cred
E6C2484BA2E	410	84"W Leg Bs Cred
E6C2484BA2G	410	84"W Leg Bs Cred
E6C2484BA5B	411	84"W Leg Bs Cred
E6C2484BA8	411	84"W Leg Bs Cred
E6C2484BDA2	410	84"W Leg Bs Cred
E6C2484BDI	407	84"W Leg Bs Cred
E6C2484BDJ	407	84"W Leg Bs Cred
E6C2484BDL	407	84"W Leg Bs Cred
E6C2484BEA2	410	84"W Leg Bs Cred
E6C2484BEI	407	84"W Leg Bs Cred
E6C2484BEJ	407	84"W Leg Bs Cred
E6C2484BEL	407	84"W Leg Bs Cred
E6C2484BGA2	410	84"W Leg Bs Cred
E6C2484BGI	407	84"W Leg Bs Cred
E6C2484BGJ	407	84"W Leg Bs Cred
E6C2484BGL	407	84"W Leg Bs Cred
E6C2484BIA1	409	84"W Leg Bs Cred
E6C2484BID	407	84"W Leg Bs Cred
E6C2484BIE	407	84"W Leg Bs Cred
E6C2484BIG	407	84"W Leg Bs Cred
E6C2484BJA1	409	84"W Leg Bs Cred
E6C2484BJD	407	84"W Leg Bs Cred
E6C2484BJE	407	84"W Leg Bs Cred
E6C2484BJG	407	84"W Leg Bs Cred
E6C2484BLA1	409	84"W Leg Bs Cred
E6C2484BLD	407	84"W Leg Bs Cred
E6C2484BLE	407	84"W Leg Bs Cred
E6C2484BLG	407	84"W Leg Bs Cred
E6C2484DA2B	410	84"W Leg Bs Cred
E6C2484DA6	411	84"W Leg Bs Cred
E6C2484DBA2	410	84"W Leg Bs Cred
E6C2484DBJ	407	84"W Leg Bs Cred
E6C2484DBL	407	84"W Leg Bs Cred
E6C2484DIB	408	84"W Leg Bs Cred

Style Number	Page	Description
E6C2484DJB	408	84"W Leg Bs Cred
E6C2484DLB	408	84"W Leg Bs Cred
E6C2484EA2B	410	84"W Leg Bs Cred
E6C2484EA6	411	84"W Leg Bs Cred
E6C2484EBA2	410	84"W Leg Bs Cred
E6C2484EBI	407	84"W Leg Bs Cred
E6C2484EBL	407	84"W Leg Bs Cred
E6C2484EIB	408	84"W Leg Bs Cred
E6C2484EJB	408	84"W Leg Bs Cred
E6C2484ELB	408	84"W Leg Bs Cred
E6C2484GA2B	410	84"W Leg Bs Cred
E6C2484GA6	411	84"W Leg Bs Cred
E6C2484GBA2	410	84"W Leg Bs Cred
E6C2484GBI	407	84"W Leg Bs Cred
E6C2484GBJ	407	84"W Leg Bs Cred
E6C2484GIB	408	84"W Leg Bs Cred
E6C2484GJB	408	84"W Leg Bs Cred
E6C2484GLB	408	84"W Leg Bs Cred
E6C2484IA1B	409	84"W Leg Bs Cred
E6C2484IBA1	409	84"W Leg Bs Cred
E6C2484IBE	408	84"W Leg Bs Cred
E6C2484IBG	408	84"W Leg Bs Cred
E6C2484IDB	408	84"W Leg Bs Cred
E6C2484IEB	408	84"W Leg Bs Cred
E6C2484IGB	408	84"W Leg Bs Cred
E6C2484JA1B	409	84"W Leg Bs Cred
E6C2484JBA1	409	84"W Leg Bs Cred
E6C2484JBD	408	84"W Leg Bs Cred
E6C2484JBG	408	84"W Leg Bs Cred
E6C2484JDB	408	84"W Leg Bs Cred
E6C2484JEB	408	84"W Leg Bs Cred
E6C2484JGB	408	84"W Leg Bs Cred
E6C2484LA1B	409	84"W Leg Bs Cred
E6C2484LBA1	409	84"W Leg Bs Cred
E6C2484LBD	408	84"W Leg Bs Cred
E6C2484LBE	408	84"W Leg Bs Cred
E6C2484LDB	408	84"W Leg Bs Cred
E6C2484LEB	408	84"W Leg Bs Cred
E6C2484LGB	408	84"W Leg Bs Cred
E6C2490A1DD	415	90"W Leg Bs Cred
E6C2490A1DE	415	90"W Leg Bs Cred
E6C2490A1DG	415	90"W Leg Bs Cred
E6C2490A1ED	415	90"W Leg Bs Cred
E6C2490A1EE	415	90"W Leg Bs Cred
E6C2490A1EG	415	90"W Leg Bs Cred
E6C2490A1GD	415	90"W Leg Bs Cred
E6C2490A1GE	415	90"W Leg Bs Cred
E6C2490A1GG	415	90"W Leg Bs Cred
E6C2490A2BI	416	90"W Leg Bs Cred
E6C2490A2BJ	416	90"W Leg Bs Cred
E6C2490A2BL	416	90"W Leg Bs Cred
E6C2490A2IB	416	90"W Leg Bs Cred
E6C2490A2JB	416	90"W Leg Bs Cred
E6C2490A2LB	416	90"W Leg Bs Cred
E6C2490A6BB	417	90"W Leg Bs Cred
E6C2490A6I	418	90"W Leg Bs Cred

Style Number Index, continued

Style Number	Page	Description
E6C2490A6J	418	90"W Leg Bs Cred
E6C2490A6L	418	90"W Leg Bs Cred
E6C2490A7AA	418	90"W Leg Bs Cred
E6C2490A7D	419	90"W Leg Bs Cred
E6C2490A7E	419	90"W Leg Bs Cred
E6C2490A7G	419	90"W Leg Bs Cred
E6C2490A9B	419	90"W Leg Bs Cred
E6C2490AA4D	417	90"W Leg Bs Cred
E6C2490AA4E	417	90"W Leg Bs Cred
E6C2490AA4G	417	90"W Leg Bs Cred
E6C2490AAA7	418	90"W Leg Bs Cred
E6C2490BA2I	416	90"W Leg Bs Cred
E6C2490BA2J	416	90"W Leg Bs Cred
E6C2490BA2L	416	90"W Leg Bs Cred
E6C2490BA9	419	90"W Leg Bs Cred
E6C2490BBA6	417	90"W Leg Bs Cred
E6C2490BIA2	416	90"W Leg Bs Cred
E6C2490BII	414	90"W Leg Bs Cred
E6C2490BIJ	414	90"W Leg Bs Cred
E6C2490BIL	414	90"W Leg Bs Cred
E6C2490BJA2	416	90"W Leg Bs Cred
E6C2490BJI	414	90"W Leg Bs Cred
E6C2490BJJ	414	90"W Leg Bs Cred
E6C2490BJL	414	90"W Leg Bs Cred
E6C2490BLA2	416	90"W Leg Bs Cred
E6C2490BLI	414	90"W Leg Bs Cred
E6C2490BLJ	414	90"W Leg Bs Cred
E6C2490BLL	414	90"W Leg Bs Cred
E6C2490DA1D	415	90"W Leg Bs Cred
E6C2490DA1E	415	90"W Leg Bs Cred
E6C2490DA1G	415	90"W Leg Bs Cred
E6C2490DA4A	417	90"W Leg Bs Cred
E6C2490DA7	419	90"W Leg Bs Cred
E6C2490DDA1	415	90"W Leg Bs Cred
E6C2490DDD	413	90"W Leg Bs Cred
E6C2490DDE	413	90"W Leg Bs Cred
E6C2490DDG	413	90"W Leg Bs Cred
E6C2490DEA1	415	90"W Leg Bs Cred
E6C2490DEE	413	90"W Leg Bs Cred
E6C2490DEG	413	90"W Leg Bs Cred
E6C2490DGA1	415	90"W Leg Bs Cred
E6C2490DGE	413	90"W Leg Bs Cred
E6C2490DGG	413	90"W Leg Bs Cred
E6C2490EA1D	415	90"W Leg Bs Cred
E6C2490EA1E	415	90"W Leg Bs Cred
E6C2490EA1G	415	90"W Leg Bs Cred
E6C2490EA4A	417	90"W Leg Bs Cred
E6C2490EA7	419	90"W Leg Bs Cred
E6C2490EDA1	415	90"W Leg Bs Cred
E6C2490EDD	413	90"W Leg Bs Cred
E6C2490EDG	413	90"W Leg Bs Cred
E6C2490EEA1	415	90"W Leg Bs Cred
E6C2490EED	413	90"W Leg Bs Cred
E6C2490EEE	413	90"W Leg Bs Cred
E6C2490EEG	413	90"W Leg Bs Cred
E6C2490EGA1	415	90"W Leg Bs Cred

Style Number	Page	Description
E6C2490EGD	413	90"W Leg Bs Cred
E6C2490EGG	413	90"W Leg Bs Cred
E6C2490GA1D	415	90"W Leg Bs Cred
E6C2490GA1E	415	90"W Leg Bs Cred
E6C2490GA1G	415	90"W Leg Bs Cred
E6C2490GA4A	417	90"W Leg Bs Cred
E6C2490GA7	419	90"W Leg Bs Cred
E6C2490GDA1	415	90"W Leg Bs Cred
E6C2490GDD	413	90"W Leg Bs Cred
E6C2490GDE	413	90"W Leg Bs Cred
E6C2490GEA1	415	90"W Leg Bs Cred
E6C2490GED	413	90"W Leg Bs Cred
E6C2490GEE	413	90"W Leg Bs Cred
E6C2490GGA1	415	90"W Leg Bs Cred
E6C2490GGD	413	90"W Leg Bs Cred
E6C2490GGE	413	90"W Leg Bs Cred
E6C2490GGG	413	90"W Leg Bs Cred
E6C2490IA2B	416	90"W Leg Bs Cred
E6C2490IA6	418	90"W Leg Bs Cred
E6C2490IBA2	416	90"W Leg Bs Cred
E6C2490IBJ	414	90"W Leg Bs Cred
E6C2490IBL	414	90"W Leg Bs Cred
E6C2490IIB	414	90"W Leg Bs Cred
E6C2490IJB	414	90"W Leg Bs Cred
E6C2490ILB	414	90"W Leg Bs Cred
E6C2490JA2B	416	90"W Leg Bs Cred
E6C2490JA6	418	90"W Leg Bs Cred
E6C2490JBA2	416	90"W Leg Bs Cred
E6C2490JBI	414	90"W Leg Bs Cred
E6C2490JBL	414	90"W Leg Bs Cred
E6C2490JIB	414	90"W Leg Bs Cred
E6C2490JJB	414	90"W Leg Bs Cred
E6C2490JLB	414	90"W Leg Bs Cred
E6C2490LA2B	416	90"W Leg Bs Cred
E6C2490LA6	418	90"W Leg Bs Cred
E6C2490LBA2	416	90"W Leg Bs Cred
E6C2490LBI	414	90"W Leg Bs Cred
E6C2490LBJ	414	90"W Leg Bs Cred
E6C2490LIB	414	90"W Leg Bs Cred
E6C2490LJB	414	90"W Leg Bs Cred
E6C2490LLB	414	90"W Leg Bs Cred
E6C2490NNN	371	90"W Leg Bs Cred
E6C2490NNO	371	90"W Leg Bs Cred
E6C2490NOO	371	90"W Leg Bs Cred
E6C2490ONN	371	90"W Leg Bs Cred
E6C2490OON	371	90"W Leg Bs Cred
E6C2496A1DI	424	96"W Leg Bs Cred
E6C2496A1DJ	424	96"W Leg Bs Cred
E6C2496A1DL	424	96"W Leg Bs Cred
E6C2496A1EI	424	96"W Leg Bs Cred
E6C2496A1EJ	424	96"W Leg Bs Cred
E6C2496A1EL	424	96"W Leg Bs Cred
E6C2496A1GI	424	96"W Leg Bs Cred
E6C2496A1GJ	424	96"W Leg Bs Cred
E6C2496A1GL	424	96"W Leg Bs Cred
E6C2496A1ID	424	96"W Leg Bs Cred

Style Number	Page	Description
E6C2496A1IE	424	96"W Leg Bs Cred
E6C2496A1IG	424	96"W Leg Bs Cred
E6C2496A1JD	424	96"W Leg Bs Cred
E6C2496A1JE	424	96"W Leg Bs Cred
E6C2496A1JG	424	96"W Leg Bs Cred
E6C2496A1LD	424	96"W Leg Bs Cred
E6C2496A1LE	424	96"W Leg Bs Cred
E6C2496A1LG	424	96"W Leg Bs Cred
E6C2496A2DD	427	96"W Leg Bs Cred
E6C2496A2DE	427	96"W Leg Bs Cred
E6C2496A2DG	427	96"W Leg Bs Cred
E6C2496A2ED	427	96"W Leg Bs Cred
E6C2496A2EE	427	96"W Leg Bs Cred
E6C2496A2EG	427	96"W Leg Bs Cred
E6C2496A2GD	427	96"W Leg Bs Cred
E6C2496A2GE	427	96"W Leg Bs Cred
E6C2496A2GG	427	96"W Leg Bs Cred
E6C2496A5BD	430	96"W Leg Bs Cred
E6C2496A5BE	430	96"W Leg Bs Cred
E6C2496A5BG	430	96"W Leg Bs Cred
E6C2496A5DB	430	96"W Leg Bs Cred
E6C2496A5EB	430	96"W Leg Bs Cred
E6C2496A5GB	430	96"W Leg Bs Cred
E6C2496A7BB	431	96"W Leg Bs Cred
E6C2496A7I	431	96"W Leg Bs Cred
E6C2496A7J	431	96"W Leg Bs Cred
E6C2496A7L	431	96"W Leg Bs Cred
E6C2496A8AA	432	96"W Leg Bs Cred
E6C2496A8D	432	96"W Leg Bs Cred
E6C2496A8E	432	96"W Leg Bs Cred
E6C2496A8G	432	96"W Leg Bs Cred
E6C2496AAA8	432	96"W Leg Bs Cred
E6C2496BA3I	429	96"W Leg Bs Cred
E6C2496BA3J	429	96"W Leg Bs Cred
E6C2496BA3L	429	96"W Leg Bs Cred
E6C2496BA5D	430	96"W Leg Bs Cred
E6C2496BA5E	430	96"W Leg Bs Cred
E6C2496BA5G	430	96"W Leg Bs Cred
E6C2496BBA7	431	96"W Leg Bs Cred
E6C2496BDA5	430	96"W Leg Bs Cred
E6C2496BEA5	430	96"W Leg Bs Cred
E6C2496BGA5	430	96"W Leg Bs Cred
E6C2496DA1I	426	96"W Leg Bs Cred
E6C2496DA1J	426	96"W Leg Bs Cred
E6C2496DA1L	426	96"W Leg Bs Cred
E6C2496DA2D	428	96"W Leg Bs Cred
E6C2496DA2E	428	96"W Leg Bs Cred
E6C2496DA2G	428	96"W Leg Bs Cred
E6C2496DA5B	430	96"W Leg Bs Cred
E6C2496DA8	432	96"W Leg Bs Cred
E6C2496DBA5	430	96"W Leg Bs Cred
E6C2496DDA2	427	96"W Leg Bs Cred
E6C2496DDI	421	96"W Leg Bs Cred
E6C2496DDJ	421	96"W Leg Bs Cred
E6C2496DDL	421	96"W Leg Bs Cred
E6C2496DEA2	427	96"W Leg Bs Cred

Style Number	Page	Description
E6C2496DEJ	421	96"W Leg Bs Cred
E6C2496DEL	421	96"W Leg Bs Cred
E6C2496DGA2	427	96"W Leg Bs Cred
E6C2496DGJ	421	96"W Leg Bs Cred
E6C2496DGL	421	96"W Leg Bs Cred
E6C2496DIA1	425	96"W Leg Bs Cred
E6C2496DIE	422	96"W Leg Bs Cred
E6C2496DIG	422	96"W Leg Bs Cred
E6C2496DJA1	425	96"W Leg Bs Cred
E6C2496DJE	422	96"W Leg Bs Cred
E6C2496DJG	422	96"W Leg Bs Cred
E6C2496DLA1	425	96"W Leg Bs Cred
E6C2496DLE	422	96"W Leg Bs Cred
E6C2496DLG	422	96"W Leg Bs Cred
E6C2496EA1I	426	96"W Leg Bs Cred
E6C2496EA1J	426	96"W Leg Bs Cred
E6C2496EA1L	426	96"W Leg Bs Cred
E6C2496EA2D	428	96"W Leg Bs Cred
E6C2496EA2E	428	96"W Leg Bs Cred
E6C2496EA2G	428	96"W Leg Bs Cred
E6C2496EA5B	430	96"W Leg Bs Cred
E6C2496EA8	432	96"W Leg Bs Cred
E6C2496EBA5	430	96"W Leg Bs Cred
E6C2496EDA2	427	96"W Leg Bs Cred
E6C2496EDI	421	96"W Leg Bs Cred
E6C2496EDL	421	96"W Leg Bs Cred
E6C2496EEA2	427	96"W Leg Bs Cred
E6C2496EEI	421	96"W Leg Bs Cred
E6C2496EEJ	421	96"W Leg Bs Cred
E6C2496EEL	421	96"W Leg Bs Cred
E6C2496EGA2	427	96"W Leg Bs Cred
E6C2496EGI	421	96"W Leg Bs Cred
E6C2496EGL	421	96"W Leg Bs Cred
E6C2496EIA1	425	96"W Leg Bs Cred
E6C2496EID	422	96"W Leg Bs Cred
E6C2496EIG	422	96"W Leg Bs Cred
E6C2496EJA1	425	96"W Leg Bs Cred
E6C2496EJD	422	96"W Leg Bs Cred
E6C2496EJE	422	96"W Leg Bs Cred
E6C2496EJG	422	96"W Leg Bs Cred
E6C2496ELA1	425	96"W Leg Bs Cred
E6C2496ELD	422	96"W Leg Bs Cred
E6C2496ELG	422	96"W Leg Bs Cred
E6C2496GA1I	426	96"W Leg Bs Cred
E6C2496GA1J	426	96"W Leg Bs Cred
E6C2496GA1L	426	96"W Leg Bs Cred
E6C2496GA2D	428	96"W Leg Bs Cred
E6C2496GA2E	428	96"W Leg Bs Cred
E6C2496GA2G	428	96"W Leg Bs Cred
E6C2496GA5B	430	96"W Leg Bs Cred
E6C2496GA8	432	96"W Leg Bs Cred
E6C2496GBA5	430	96"W Leg Bs Cred
E6C2496GDA2	427	96"W Leg Bs Cred
E6C2496GDI	421	96"W Leg Bs Cred
E6C2496GDJ	421	96"W Leg Bs Cred
E6C2496GEA2	427	96"W Leg Bs Cred

Style Number Index, continued

Style Number	Page	Description
E6C2496GEI	421	96"W Leg Bs Cred
E6C2496GEJ	421	96"W Leg Bs Cred
E6C2496GGA2	427	96"W Leg Bs Cred
E6C2496GGI	421	96"W Leg Bs Cred
E6C2496GGJ	421	96"W Leg Bs Cred
E6C2496GGL	421	96"W Leg Bs Cred
E6C2496GIA1	425	96"W Leg Bs Cred
E6C2496GID	422	96"W Leg Bs Cred
E6C2496GIE	422	96"W Leg Bs Cred
E6C2496GJA1	425	96"W Leg Bs Cred
E6C2496GJD	422	96"W Leg Bs Cred
E6C2496GJE	422	96"W Leg Bs Cred
E6C2496GLA1	425	96"W Leg Bs Cred
E6C2496GLD	422	96"W Leg Bs Cred
E6C2496GLE	422	96"W Leg Bs Cred
E6C2496GLG	422	96"W Leg Bs Cred
E6C2496IA1D	426	96"W Leg Bs Cred
E6C2496IA1E	426	96"W Leg Bs Cred
E6C2496IA1G	426	96"W Leg Bs Cred
E6C2496IA3B	429	96"W Leg Bs Cred
E6C2496IA7	431	96"W Leg Bs Cred
E6C2496IDA1	425	96"W Leg Bs Cred
E6C2496IDD	423	96"W Leg Bs Cred
E6C2496IDE	423	96"W Leg Bs Cred
E6C2496IDG	423	96"W Leg Bs Cred
E6C2496IEA1	425	96"W Leg Bs Cred
E6C2496IEE	423	96"W Leg Bs Cred
E6C2496IEG	423	96"W Leg Bs Cred
E6C2496IGA1	425	96"W Leg Bs Cred
E6C2496IGE	423	96"W Leg Bs Cred
E6C2496IGG	423	96"W Leg Bs Cred
E6C2496JA1D	426	96"W Leg Bs Cred
E6C2496JA1E	426	96"W Leg Bs Cred
E6C2496JA1G	426	96"W Leg Bs Cred
E6C2496JA3B	429	96"W Leg Bs Cred
E6C2496JA7	431	96"W Leg Bs Cred
E6C2496JDA1	425	96"W Leg Bs Cred
E6C2496JDD	423	96"W Leg Bs Cred
E6C2496JDG	423	96"W Leg Bs Cred
E6C2496JEA1	425	96"W Leg Bs Cred
E6C2496JED	423	96"W Leg Bs Cred
E6C2496JEE	423	96"W Leg Bs Cred
E6C2496JEG	423	96"W Leg Bs Cred
E6C2496JGA1	425	96"W Leg Bs Cred
E6C2496JGD	423	96"W Leg Bs Cred
E6C2496JGG	423	96"W Leg Bs Cred
E6C2496LA1D	426	96"W Leg Bs Cred
E6C2496LA1E	426	96"W Leg Bs Cred
E6C2496LA1G	426	96"W Leg Bs Cred
E6C2496LA3B	429	96"W Leg Bs Cred
E6C2496LA7	431	96"W Leg Bs Cred
E6C2496LDA1	425	96"W Leg Bs Cred
E6C2496LDD	423	96"W Leg Bs Cred
E6C2496LDE	423	96"W Leg Bs Cred
E6C2496LEA1	425	96"W Leg Bs Cred
E6C2496LED	423	96"W Leg Bs Cred

Style Number	Page	Description
E6C2496LEE	423	96"W Leg Bs Cred
E6C2496LGA1	425	96"W Leg Bs Cred
E6C2496LGD	423	96"W Leg Bs Cred
E6C2496LGE	423	96"W Leg Bs Cred
E6C2496LGG	423	96"W Leg Bs Cred
E6C2496NNR	373	96"W Leg Bs Cred
E6C2496NQN	373	96"W Leg Bs Cred
E6C2496NQO	373	96"W Leg Bs Cred
E6C2496NRO	373	96"W Leg Bs Cred
E6C2496OOQ	373	96"W Leg Bs Cred
E6C2496OQN	373	96"W Leg Bs Cred
E6C2496ORN	373	96"W Leg Bs Cred
E6C2496QOO	373	96"W Leg Bs Cred
E6C2496RNN	373	96"W Leg Bs Cred
E6FSH	500-501	Floating Shlf
E6GBP	533-534	Magnetic Bck Ptd Glss
E6GL24127	276	Gate Leg
E6GL30127	276	Gate Leg
E6HADLS	203	Hght-Adj Dsk, Fl Wdth
E6HADLSP	207-208	Hght-Adj Dsk, Prt Wid
E6HO153021T	519	Hutch Kit
E6HO153621T	519	Hutch Kit
E6HO154221T	519	Hutch Kit
E6HO154818TB	520	Hutch Kit
E6HO154821T	519	Hutch Kit
E6HO155421T	519	Hutch Kit
E6HO156018T	519	Hutch Kit
E6HO156018TB	520	Hutch Kit
E6HO156021T	519	Hutch Kit
E6HO156618T	519	Hutch Kit
E6HO156621T	519	Hutch Kit
E6HO157218T	519	Hutch Kit
E6HO157218TB	520	Hutch Kit
E6HO157221T	519	Hutch Kit
E6HO157818T	519	Hutch Kit
E6HO157821T	519	Hutch Kit
E6HO158418T	519	Hutch Kit
E6HO158418TB	520	Hutch Kit
E6HO158421T	519	Hutch Kit
E6HO159018T	519	Hutch Kit
E6HO159021T	519	Hutch Kit
E6HO159618T	519	Hutch Kit
E6HO159618TB	520	Hutch Kit
E6HO159621T	519	Hutch Kit
E6HT1514P	521	Hutch Kit
E6HT1517P	521	Hutch Kit
E6HT1521P	521	Hutch Kit
E6HT153021T	519	Hutch Kit
E6HT153621T	519	Hutch Kit
E6HT154221T	519	Hutch Kit
E6HT154818TB	520	Hutch Kit
E6HT154821T	519	Hutch Kit
E6HT155421T	519	Hutch Kit
E6HT156018T	519	Hutch Kit
E6HT156018TB	520	Hutch Kit
E6HT156021T	519	Hutch Kit

Style Number	Page	Description	Style Number	Page	Description
E6HT156618T	519	Hutch Kit	E6IS7218M	527, 529	Slatwall
E6HT156621T	519	Hutch Kit	E6IS7221M	527	Slatwall
E6HT157218T	519	Hutch Kit	E6IS7818M	527	Slatwall
E6HT157218TB	520	Hutch Kit	E6IS7821M	527	Slatwall
E6HT157221T	519	Hutch Kit	E6IS8415B	529	Slatwall
E6HT157818T	519	Hutch Kit	E6IS8418M	527	Slatwall
E6HT157821T	519	Hutch Kit	E6IS8421M	527	Slatwall
E6HT157P	521	Hutch Kit	E6IS9018M	527	Slatwall
E6HT158418T	519	Hutch Kit	E6IS9021M	527	Slatwall
E6HT158418TB	520	Hutch Kit	E6IS9615B	529	Slatwall
E6HT158421T	519	Hutch Kit	E6IS9618M	527, 529	Slatwall
E6HT159018T	519	Hutch Kit	E6IS9621M	527	Slatwall
E6HT159021T	519	Hutch Kit	E6IST5818S	551	Slatwall
E6HT159618T	519	Hutch Kit	E6IST5821S	551	Slatwall
E6HT159618TB	520	Hutch Kit	E6IST6418S	551	Slatwall
E6HT159621T	519	Hutch Kit	E6IST6421S	551	Slatwall
E6HT1714P	521	Hutch Kit	E6IST7018S	551	Slatwall
E6HT1717P	521	Hutch Kit	E6IST7021S	551	Slatwall
E6HT1721P	521	Hutch Kit	E6IST7618S	551	Slatwall
E6HT177P	521	Hutch Kit	E6IST7621S	551	Slatwall
E6IH2813C	513	Ins Bk Pnl for OH Stg	E6IST8218S	551	Slatwall
E6IH285S	513	Ins Bk Pnl for OH Stg	E6IST8221S	551	Slatwall
E6IH3413C	513	Ins Bk Pnl for OH Stg	E6IST8818S	551	Slatwall
E6IH345S	513	Ins Bk Pnl for OH Stg	E6IST8821S	551	Slatwall
E6IH4013C	513	Ins Bk Pnl for OH Stg	E6IST9418S	551	Slatwall
E6IH405S	513	Ins Bk Pnl for OH Stg	E6IST9421S	551	Slatwall
E6IH4613C	513	Ins Bk Pnl for OH Stg	E6IT2813C	512	Tackboard Insert
E6IH465S	513	Ins Bk Pnl for OH Stg	E6IT3021M	525	Tackboard
E6IH5213C	513	Ins Bk Pnl for OH Stg	E6IT3021W	526	Tackboard
E6IH525S	513	Ins Bk Pnl for OH Stg	E6IT3413C	512	Tackboard Insert
E6IH5813C	513	Ins Bk Pnl for OH Stg	E6IT3621M	525	Tackboard
E6IH585S	513	Ins Bk Pnl for OH Stg	E6IT3621W	526	Tackboard
E6IH6413C	513	Ins Bk Pnl for OH Stg	E6IT4013C	512	Tackboard Insert
E6IH645S	513	Ins Bk Pnl for OH Stg	E6IT4221M	525	Tackboard
E6IH7013C	513	Ins Bk Pnl for OH Stg	E6IT4221W	526	Tackboard
E6IH705S	513	Ins Bk Pnl for OH Stg	E6IT4613C	512	Tackboard Insert
E6IH7613C	513	Ins Bk Pnl for OH Stg	E6IT4818B	528	Tackboard
E6IH765S	513	Ins Bk Pnl for OH Stg	E6IT4818WB	528	Tackboard
E6IH8213C	513	Ins Bk Pnl for OH Stg	E6IT4821M	525	Tackboard
E6IH825S	513	Ins Bk Pnl for OH Stg	E6IT4821W	526	Tackboard
E6IH8813C	513	Ins Bk Pnl for OH Stg	E6IT5213C	512	Tackboard Insert
E6IH885S	513	Ins Bk Pnl for OH Stg	E6IT5421M	525	Tackboard
E6IH9413C	513	Ins Bk Pnl for OH Stg	E6IT5421W	526	Tackboard
E6IH945S	513	Ins Bk Pnl for OH Stg	E6IT5813C	512	Tackboard Insert
E6IS3021M	527	Slatwall	E6IT5814B	552	Tackboard
E6IS3621M	527	Slatwall	E6IT5815B	552	Tackboard
E6IS4221M	527	Slatwall	E6IT5817S	550	Tackboard
E6IS4818B	529	Slatwall	E6IT6015B	528	Tackboard
E6IS4821M	527	Slatwall	E6IT6018M	525, 528	Tackboard
E6IS5421M	527	Slatwall	E6IT6018W	526, 528	Tackboard
E6IS6015B	529	Slatwall	E6IT6021M	525	Tackboard
E6IS6018M	527, 529	Slatwall	E6IT6021W	526	Tackboard
E6IS6021M	527	Slatwall	E6IT6413C	512	Tackboard Insert
E6IS6618M	527	Slatwall	E6IT6417S	550	Tackboard
E6IS6621M	527	Slatwall	E6IT6618M	525, 528	Tackboard
E6IS7215B	529	Slatwall	E6IT6618W	526	Tackboard

Style Number Index, continued

Style Number	Page	Description
E6IT6621M	525	Tackboard
E6IT6621W	526	Tackboard
E6IT7013C	512	Tackboard Insert
E6IT7014B	552	Tackboard
E6IT7015B	552	Tackboard
E6IT7017S	550	Tackboard
E6IT7215B	528	Tackboard
E6IT7218M	525, 528	Tackboard
E6IT7218W	526, 528	Tackboard
E6IT7221M	525	Tackboard
E6IT7221W	526	Tackboard
E6IT7613C	512	Tackboard Insert
E6IT7617S	550	Tackboard
E6IT7818M	525, 528	Tackboard
E6IT7818W	526	Tackboard
E6IT7821M	525	Tackboard
E6IT7821W	526	Tackboard
E6IT8213C	512	Tackboard Insert
E6IT8214B	552	Tackboard
E6IT8215B	552	Tackboard
E6IT8217S	550	Tackboard
E6IT8415B	528	Tackboard
E6IT8418M	525, 528	Tackboard
E6IT8418W	526, 528	Tackboard
E6IT8421M	525	Tackboard
E6IT8421W	526	Tackboard
E6IT8813C	512	Tackboard Insert
E6IT8817S	550	Tackboard
E6IT9018M	525, 528	Tackboard
E6IT9018W	526	Tackboard
E6IT9021M	525	Tackboard
E6IT9021W	526	Tackboard
E6IT9413C	512	Tackboard Insert
E6IT9414B	552	Tackboard
E6IT9415B	552	Tackboard
E6IT9417S	550	Tackboard
E6IT9615B	528	Tackboard
E6IT9618M	525, 528	Tackboard
E6IT9618W	526, 528	Tackboard
E6IT9621M	525	Tackboard
E6IT9621W	526	Tackboard
E6ITT5818S	551	Tackboard
E6ITT5821S	551	Tackboard
E6ITT6418S	551	Tackboard
E6ITT6421S	551	Tackboard
E6ITT7018S	551	Tackboard
E6ITT7021S	551	Tackboard
E6ITT7618S	551	Tackboard
E6ITT7621S	551	Tackboard
E6ITT8218S	551	Tackboard
E6ITT8221S	551	Tackboard
E6ITT8818S	551	Tackboard
E6ITT8821S	551	Tackboard
E6ITT9418S	551	Tackboard
E6ITT9421S	551	Tackboard
E6KV243045A	339	Plinth Bs Vrt Cabinet

Style Number	Page	Description
E6KV243065B	339	Plinth Bs Vrt Cabinet
E6KV243065D	339	Plinth Bs Vrt Cabinet
E6KV243072B	340	Plinth Bs Vrt Cabinet
E6KV243077B	340	Plinth Bs Vrt Cabinet
E6KW181245L	343	Plinth Bs Wardrobe
E6KW181245R	343	Plinth Bs Wardrobe
E6KW181255L	344	Plinth Bs Wardrobe
E6KW181255R	344	Plinth Bs Wardrobe
E6KW181265L	344	Plinth Bs Wardrobe
E6KW181265R	344	Plinth Bs Wardrobe
E6KW181272L	345	Plinth Bs Wardrobe
E6KW181272R	345	Plinth Bs Wardrobe
E6KW181277L	346	Plinth Bs Wardrobe
E6KW181277R	346	Plinth Bs Wardrobe
E6KW241245L	343	Plinth Bs Wardrobe
E6KW241245R	343	Plinth Bs Wardrobe
E6KW241255L	344	Plinth Bs Wardrobe
E6KW241255R	344	Plinth Bs Wardrobe
E6KW241265L	344	Plinth Bs Wardrobe
E6KW241265R	344	Plinth Bs Wardrobe
E6KW241272L	345	Plinth Bs Wardrobe
E6KW241272R	345	Plinth Bs Wardrobe
E6KW241277L	346	Plinth Bs Wardrobe
E6KW241277R	346	Plinth Bs Wardrobe
E6KW241565L	344	Plinth Bs Wardrobe
E6KW241565R	344	Plinth Bs Wardrobe
E6KW241572L	345	Plinth Bs Wardrobe
E6KW241572R	345	Plinth Bs Wardrobe
E6KW241577L	346	Plinth Bs Wardrobe
E6KW241577R	346	Plinth Bs Wardrobe
E6KW243065	344	Plinth Bs Wardrobe
E6KW243072	345	Plinth Bs Wardrobe
E6KW243077	346	Plinth Bs Wardrobe
E6KWL241255L	481	Leg Bs Wardrobe
E6KWL241255R	481	Leg Bs Wardrobe
E6KWL241265L	481	Leg Bs Wardrobe
E6KWL241265R	481	Leg Bs Wardrobe
E6KWL241272L	482	Leg Bs Wardrobe
E6KWL241272R	482	Leg Bs Wardrobe
E6LBPSH	503	Floating Back Panel
E6LF243029T	305	Plinth Bs Lateral File
E6LF243041E	307	Plinth Bs Lateral File
E6LF243051F	307	Plinth Bs Lateral File
E6LF243629T	305	Plinth Bs Lateral File
E6LF243641E	307	Plinth Bs Lateral File
E6LF243651F	307	Plinth Bs Lateral File
E6LFL243045E	359	Leg Bs Lateral File
E6LFL243645E	359	Leg Bs Lateral File
E6LH19M	564	Metal Lgt. Housing
E6LH43M	564	Metal Lgt. Housing
E6LH68M	564	Metal Lgt. Housing
E6MDT156048C	548	Double-High Svrc Mod
E6MDT156048L	547	Double-High Svrc Mod
E6MDT156048P	549	Double-High Svrc Mod
E6MDT156048R	547	Double-High Svrc Mod
E6MDT156648C	548	Double-High Svrc Mod

Style Number	Page	Description	Style Number	Page	Description
E6MDT156648L	547	Double-High Svrc Mod	E6MST157843P	544	Single-High Svrc Mod
E6MDT156648P	549	Double-High Svrc Mod	E6MST158436C	541	Single-High Svrc Mod
E6MDT156648R	547	Double-High Svrc Mod	E6MST158436M	541	Single-High Svrc Mod
E6MDT157248C	548	Double-High Svrc Mod	E6MST158443C	543	Single-High Svrc Mod
E6MDT157248L	547	Double-High Svrc Mod	E6MST158443M	543	Single-High Svrc Mod
E6MDT157248P	549	Double-High Svrc Mod	E6MST158443P	544	Single-High Svrc Mod
E6MDT157248R	547	Double-High Svrc Mod	E6MST159036C	541	Single-High Svrc Mod
E6MDT157848C	548	Double-High Svrc Mod	E6MST159036M	541	Single-High Svrc Mod
E6MDT157848L	547	Double-High Svrc Mod	E6MST159043C	543	Single-High Svrc Mod
E6MDT157848P	549	Double-High Svrc Mod	E6MST159043M	543	Single-High Svrc Mod
E6MDT157848R	547	Double-High Svrc Mod	E6MST159043P	544	Single-High Svrc Mod
E6MDT158448C	548	Double-High Svrc Mod	E6MST159636C	541	Single-High Svrc Mod
E6MDT158448L	547	Double-High Svrc Mod	E6MST159636M	541	Single-High Svrc Mod
E6MDT158448P	549	Double-High Svrc Mod	E6MST159643C	543	Single-High Svrc Mod
E6MDT158448R	547	Double-High Svrc Mod	E6MST159643M	543	Single-High Svrc Mod
E6MDT159048C	548	Double-High Svrc Mod	E6MST159643P	544	Single-High Svrc Mod
E6MDT159048L	547	Double-High Svrc Mod	E6NB1521P	248	Back Panel
E6MDT159048P	549	Double-High Svrc Mod	E6NB1527P	248	Back Panel
E6MDT159048R	547	Double-High Svrc Mod	E6NB1536H	248	Back Panel
E6MDT159648C	548	Double-High Svrc Mod	E6NB1536V	324, 466	Back Panel
E6MDT159648L	547	Double-High Svrc Mod	E6NB1543V	324, 466	Back Panel
E6MDT159648P	549	Double-High Svrc Mod	E6NB1548V	324, 466	Back Panel
E6MDT159648R	547	Double-High Svrc Mod	E6NB1821P	248	Back Panel
E6MS156032P	538	Single-High Svrc Mod	E6NB1827P	248	Back Panel
E6MS156032S	537	Single-High Svrc Mod	E6NB1836V	324, 466	Back Panel
E6MS156632P	538	Single-High Svrc Mod	E6NB1843V	324, 466	Back Panel
E6MS156632S	537	Single-High Svrc Mod	E6NB1848V	324, 466	Back Panel
E6MS157232P	538	Single-High Svrc Mod	E6NB3014V	515	Back Panel
E6MS157232S	537	Single-High Svrc Mod	E6NB3015C	515	Back Panel
E6MS157832P	538	Single-High Svrc Mod	E6NB3015N	248	Back Panel
E6MS157832S	537	Single-High Svrc Mod	E6NB3021V	516	Back Panel
E6MS158432P	538	Single-High Svrc Mod	E6NB3022C	516	Back Panel
E6MS158432S	537	Single-High Svrc Mod	E6NB3036V	324, 466, 517	Back Panel
E6MS159032P	538	Single-High Svrc Mod	E6NB3043V	324, 466	Back Panel
E6MS159032S	537	Single-High Svrc Mod	E6NB3048V	324, 466	Back Panel
E6MS159632P	538	Single-High Svrc Mod	E6NB307S	514	Back Panel
E6MS159632S	537	Single-High Svrc Mod	E6NB3614V	515	Back Panel
E6MST156036C	541	Single-High Svrc Mod	E6NB3615C	515	Back Panel
E6MST156036M	541	Single-High Svrc Mod	E6NB3615N	248	Back Panel
E6MST156043C	543	Single-High Svrc Mod	E6NB3621V	516	Back Panel
E6MST156043M	543	Single-High Svrc Mod	E6NB3622C	516	Back Panel
E6MST156043P	544	Single-High Svrc Mod	E6NB3636V	324, 466, 517	Back Panel
E6MST156636C	541	Single-High Svrc Mod	E6NB3643V	324, 466	Back Panel
E6MST156636M	541	Single-High Svrc Mod	E6NB3648V	324, 466	Back Panel
E6MST156643C	543	Single-High Svrc Mod	E6NB367S	514	Back Panel
E6MST156643M	543	Single-High Svrc Mod	E6NB4214V	515	Back Panel
E6MST156643P	544	Single-High Svrc Mod	E6NB4215C	515	Back Panel
E6MST157236C	541	Single-High Svrc Mod	E6NB4221V	516	Back Panel
E6MST157236M	541	Single-High Svrc Mod	E6NB4222C	516	Back Panel
E6MST157243C	543	Single-High Svrc Mod	E6NB4236V	517	Back Panel
E6MST157243M	543	Single-High Svrc Mod	E6NB427S	514	Back Panel
E6MST157243P	544	Single-High Svrc Mod	E6NB4814V	515	Back Panel
E6MST157836C	541	Single-High Svrc Mod	E6NB4815C	515	Back Panel
E6MST157836M	541	Single-High Svrc Mod	E6NB4821V	516	Back Panel
E6MST157843C	543	Single-High Svrc Mod	E6NB4822C	516	Back Panel
E6MST157843M	543	Single-High Svrc Mod	E6NB4836V	517	Back Panel

Style Number Index, continued

Style Number	Page	Description
E6NB487S	514	Back Panel
E6NB5414V	515	Back Panel
E6NB5415C	515	Back Panel
E6NB5421V	516	Back Panel
E6NB5422C	516	Back Panel
E6NB5436V	517	Back Panel
E6NB547S	514	Back Panel
E6NB6014V	515	Back Panel
E6NB6015C	515	Back Panel
E6NB6021V	516	Back Panel
E6NB6022C	516	Back Panel
E6NB6036V	517	Back Panel
E6NB6043V	517	Back Panel
E6NB6048V	517	Back Panel
E6NB607S	514	Back Panel
E6NB6614V	515	Back Panel
E6NB6615C	515	Back Panel
E6NB6621V	516	Back Panel
E6NB6622C	516	Back Panel
E6NB6636V	517	Back Panel
E6NB6643V	517	Back Panel
E6NB6648V	517	Back Panel
E6NB667S	514	Back Panel
E6NB7214V	515	Back Panel
E6NB7215C	515	Back Panel
E6NB7221V	516	Back Panel
E6NB7222C	516	Back Panel
E6NB7236V	517	Back Panel
E6NB7243V	517	Back Panel
E6NB7248V	517	Back Panel
E6NB727S	514	Back Panel
E6NB7814V	515	Back Panel
E6NB7815C	515	Back Panel
E6NB7821V	516	Back Panel
E6NB7822C	516	Back Panel
E6NB7836V	517	Back Panel
E6NB7843V	517	Back Panel
E6NB7848V	517	Back Panel
E6NB787S	514	Back Panel
E6NB8414V	515	Back Panel
E6NB8415C	515	Back Panel
E6NB8421V	516	Back Panel
E6NB8422C	516	Back Panel
E6NB8436V	517	Back Panel
E6NB8443V	517	Back Panel
E6NB8448V	517	Back Panel
E6NB847S	514	Back Panel
E6NB9014V	515	Back Panel
E6NB9015C	515	Back Panel
E6NB9021V	516	Back Panel
E6NB9022C	516	Back Panel
E6NB9036V	517	Back Panel
E6NB9043V	517	Back Panel
E6NB9048V	517	Back Panel
E6NB907S	514	Back Panel
E6NB9614V	515	Back Panel

Style Number	Page	Description
E6NB9615C	515	Back Panel
E6NB9621V	516	Back Panel
E6NB9622C	516	Back Panel
E6NB9636V	517	Back Panel
E6NB9643V	517	Back Panel
E6NB9648V	517	Back Panel
E6NB967S	514	Back Panel
E6NBL1527H	262	Back Panel
E6NC1110	261	Panel Center Support
E6NC1115	261	Panel Center Support
E6NC1121	261	Panel Center Support
E6NC1127	261	Panel Center Support
E6NC810	261	Panel Center Support
E6NC815	261	Panel Center Support
E6NC821	261	Panel Center Support
E6NC827	261	Panel Center Support
E6NET1527L	252	Plinth Bs End Panel
E6NET1527R	252	Plinth Bs End Panel
E6NET1721L	253	Plinth Bs End Panel
E6NET1721R	253	Plinth Bs End Panel
E6NET1727L	252	Plinth Bs End Panel
E6NET1727R	252	Plinth Bs End Panel
E6NET2321L	253	Plinth Bs End Panel
E6NET2321R	253	Plinth Bs End Panel
E6NET2327L	252	Plinth Bs End Panel
E6NET2327R	252	Plinth Bs End Panel
E6NET2927L	252	Plinth Bs End Panel
E6NET2927R	252	Plinth Bs End Panel
E6NF610C	251	Plinth Bs End Panel
E6NF615A	251	Plinth Bs End Panel
E6NF615N	251	Plinth Bs End Panel
E6NF618V	263	Leg Bs Filler Panel
E6NF621D	251	Plinth Bs Filler Panel
E6NF621M	251	Plinth Bs Filler Panel
E6NF627B	250	Plinth Bs Filler Panel
E6NF627P	250	Plinth Bs Filler Panel
E6NF627V	250	Plinth Bs Filler Panel
E6NJT241527L	254	Plinth Bs End Panel
E6NJT241527R	254	Plinth Bs End Panel
E6NJT301527L	254	Plinth Bs End Panel
E6NJT301527R	254	Plinth Bs End Panel
E6NLL151527L	264	Leg Bs End Panel
E6NLL151527R	264	Leg Bs End Panel
E6NLL181527L	264	Leg Bs End Panel
E6NLL181527R	264	Leg Bs End Panel
E6NLL241527L	264	Leg Bs End Panel
E6NLL241527R	264	Leg Bs End Panel
E6NLT151527L	253	Plinth Bs End Panel
E6NLT151527R	253	Plinth Bs End Panel
E6NLT171510L	254	Plinth Bs End Panel
E6NLT171510R	254	Plinth Bs End Panel
E6NLT171515L	254	Plinth Bs End Panel
E6NLT171515R	254	Plinth Bs End Panel
E6NLT171521L	253	Plinth Bs End Panel
E6NLT171521R	253	Plinth Bs End Panel
E6NLT171527L	253	Plinth Bs End Panel

Style Number	Page	Description	Style Number	Page	Description
E6NLT171527R	253	Plinth Bs End Panel	E6NM6418R	269	Modesty Panel
E6NLT231510L	254	Plinth Bs End Panel	E6NM6612	267	Modesty Panel
E6NLT231510R	254	Plinth Bs End Panel	E6NM6618	267	Modesty Panel
E6NLT231515L	254	Plinth Bs End Panel	E6NM6618R	269	Modesty Panel
E6NLT231515R	254	Plinth Bs End Panel	E6NM6621	268	Modesty Panel
E6NLT231521L	253	Plinth Bs End Panel	E6NM6627	268	Modesty Panel
E6NLT231521R	253	Plinth Bs End Panel	E6NM6918R	269	Modesty Panel
E6NLT231527L	253	Plinth Bs End Panel	E6NM7212	267	Modesty Panel
E6NLT231527R	253	Plinth Bs End Panel	E6NM7218	267	Modesty Panel
E6NLT291510L	254	Plinth Bs End Panel	E6NM7218R	269	Modesty Panel
E6NLT291510R	254	Plinth Bs End Panel	E6NM7221	268	Modesty Panel
E6NLT291527L	253	Plinth Bs End Panel	E6NM7227	268	Modesty Panel
E6NLT291527R	253	Plinth Bs End Panel	E6NM7518R	269	Modesty Panel
E6NM10227	268	Modesty Panel	E6NM7812	267	Modesty Panel
E6NM10821	269	Modesty Panel	E6NM7818	267	Modesty Panel
E6NM10827	268	Modesty Panel	E6NM7818R	269	Modesty Panel
E6NM11421	269	Modesty Panel	E6NM7821	268	Modesty Panel
E6NM11427	268	Modesty Panel	E6NM7827	268	Modesty Panel
E6NM12021	269	Modesty Panel	E6NM8118R	269	Modesty Panel
E6NM12027	268	Modesty Panel	E6NM8412	267	Modesty Panel
E6NM2412	267	Modesty Panel	E6NM8418	267	Modesty Panel
E6NM2427	268	Modesty Panel	E6NM8418R	269	Modesty Panel
E6NM3012	267	Modesty Panel	E6NM8421	268	Modesty Panel
E6NM3021	268	Modesty Panel	E6NM8427	268	Modesty Panel
E6NM3027	268	Modesty Panel	E6NM9012	267	Modesty Panel
E6NM3612	267	Modesty Panel	E6NM9018	267	Modesty Panel
E6NM3621	268	Modesty Panel	E6NM9021	268	Modesty Panel
E6NM3627	268	Modesty Panel	E6NM9027	268	Modesty Panel
E6NM3918R	269	Modesty Panel	E6NM9621	268	Modesty Panel
E6NM4212	267	Modesty Panel	E6NM9627	268	Modesty Panel
E6NM4218	267	Modesty Panel	E6NMG4212E	270	Glass Modesty Panel
E6NM4218R	269	Modesty Panel	E6NMG4218E	270	Glass Modesty Panel
E6NM4221	268	Modesty Panel	E6NMG4218S	270	Glass Modesty Panel
E6NM4227	268	Modesty Panel	E6NMG4812E	270	Glass Modesty Panel
E6NM4518R	269	Modesty Panel	E6NMG4818E	270	Glass Modesty Panel
E6NM4812	267	Modesty Panel	E6NMG4818S	270	Glass Modesty Panel
E6NM4818	267	Modesty Panel	E6NMG5412E	270	Glass Modesty Panel
E6NM4818B	269	Modesty Panel	E6NMG5418E	270	Glass Modesty Panel
E6NM4818R	269	Modesty Panel	E6NMG5418S	270	Glass Modesty Panel
E6NM4821	268	Modesty Panel	E6NMG6012E	270	Glass Modesty Panel
E6NM4827	268	Modesty Panel	E6NMG6018E	270	Glass Modesty Panel
E6NM4827B	269	Modesty Panel	E6NMG6018S	270	Glass Modesty Panel
E6NM5118R	269	Modesty Panel	E6NMG6612E	270	Glass Modesty Panel
E6NM5412	267	Modesty Panel	E6NMG6618E	270	Glass Modesty Panel
E6NM5418	267	Modesty Panel	E6NMG6618S	270	Glass Modesty Panel
E6NM5418B	269	Modesty Panel	E6NMG7212E	270	Glass Modesty Panel
E6NM5418R	269	Modesty Panel	E6NMG7212S	270	Glass Modesty Panel
E6NM5421	268	Modesty Panel	E6NMG7218E	270	Glass Modesty Panel
E6NM5427	268	Modesty Panel	E6NMG7218S	270	Glass Modesty Panel
E6NM5427B	269	Modesty Panel	E6NOT1527L	255	Plinth Bs End Panel
E6NM5718R	269	Modesty Panel	E6NOT1527R	255	Plinth Bs End Panel
E6NM6012	267	Modesty Panel	E6NOT1827L	255	Plinth Bs End Panel
E6NM6018	267	Modesty Panel	E6NOT1827R	255	Plinth Bs End Panel
E6NM6018R	269	Modesty Panel	E6NOT2427L	255	Plinth Bs End Panel
E6NM6021	268	Modesty Panel	E6NOT2427R	255	Plinth Bs End Panel
E6NM6027	268	Modesty Panel	E6NOT3027L	255	Plinth Bs End Panel

Style Number Index, continued

Style Number	Page	Description
E6NOT3027R	255	Plinth Bs End Panel
E6NPT19134	271	Perp. Tether Support
E6NPT19194	271	Perp. Tether Support
E6NPT25134	271	Perp. Tether Support
E6NPT25194	271	Perp. Tether Support
E6NPT31134	271	Perp. Tether Support
E6NPT31194	271	Perp. Tether Support
E6NST19484L	273	Cable Shroud Support
E6NST19484R	273	Cable Shroud Support
E6NST19544L	273	Cable Shroud Support
E6NST19544R	273	Cable Shroud Support
E6NST19604L	273	Cable Shroud Support
E6NST19604R	273	Cable Shroud Support
E6NST19664L	273	Cable Shroud Support
E6NST19664R	273	Cable Shroud Support
E6NST25484L	273	Cable Shroud Support
E6NST25484R	273	Cable Shroud Support
E6NST25544L	273	Cable Shroud Support
E6NST25544R	273	Cable Shroud Support
E6NST25604L	273	Cable Shroud Support
E6NST25604R	273	Cable Shroud Support
E6NST25664L	273	Cable Shroud Support
E6NST25664R	273	Cable Shroud Support
E6NST31484L	273	Cable Shroud Support
E6NST31484R	273	Cable Shroud Support
E6NST31544L	273	Cable Shroud Support
E6NST31544R	273	Cable Shroud Support
E6NST31604L	273	Cable Shroud Support
E6NST31604R	273	Cable Shroud Support
E6NST31664L	273	Cable Shroud Support
E6NST31664R	273	Cable Shroud Support
E6NT30727	256	Free Supt End Panel
E6NT36727	256	Free Supt End Panel
E6NTL30727	265	Free Supt End Panel
E6NTL36727	265	Free Supt End Panel
E6NTT24124	257	T-Shape End Panel
E6NTT301210	257	T-Shape End Panel
E6NTT30124	257	T-Shape End Panel
E6NTT361210	257	T-Shape End Panel
E6NTT36124	257	T-Shape End Panel
E6NXT304227	258	Ext. T-Shp End Pnl
E6NXT304427L	259	Ext. T-Shp End Pnl
E6NXT304427R	259	Ext. T-Shp End Pnl
E6NXT304827	258	Ext. T-Shp End Pnl
E6NXT305027L	259	Ext. T-Shp End Pnl
E6NXT305027R	259	Ext. T-Shp End Pnl
E6NXT305427	258	Ext. T-Shp End Pnl
E6NXT306027	258	Ext. T-Shp End Pnl
E6NXT306627	258	Ext. T-Shp End Pnl
E6NXT307227	258	Ext. T-Shp End Pnl
E6NXT363927	258	Ext. T-Shp End Pnl
E6NXT364527	258	Ext. T-Shp End Pnl
E6NXT365127	258	Ext. T-Shp End Pnl
E6NXT365127L	259	Ext. T-Shp End Pnl
E6NXT365127R	259	Ext. T-Shp End Pnl
E6NXT365727	258	Ext. T-Shp End Pnl

Style Number	Page	Description
E6NXT366327	258	Ext. T-Shp End Pnl
E6NXT366927	258	Ext. T-Shp End Pnl
E6OD156030C	496	Double-High OH Cab.
E6OD156030L	495	Double-High OH Cab.
E6OD156030P	497	Double-High OH Cab.
E6OD156030R	496	Double-High OH Cab.
E6OD156630C	496	Double-High OH Cab.
E6OD156630L	495	Double-High OH Cab.
E6OD156630P	497	Double-High OH Cab.
E6OD156630R	496	Double-High OH Cab.
E6OD157230C	496	Double-High OH Cab.
E6OD157230L	495	Double-High OH Cab.
E6OD157230P	497	Double-High OH Cab.
E6OD157230R	496	Double-High OH Cab.
E6OD157830C	496	Double-High OH Cab.
E6OD157830L	495	Double-High OH Cab.
E6OD157830P	497	Double-High OH Cab.
E6OD157830R	496	Double-High OH Cab.
E6OD158430C	496	Double-High OH Cab.
E6OD158430L	495	Double-High OH Cab.
E6OD158430P	497	Double-High OH Cab.
E6OD158430R	496	Double-High OH Cab.
E6OD159030C	496	Double-High OH Cab.
E6OD159030L	495	Double-High OH Cab.
E6OD159030P	497	Double-High OH Cab.
E6OD159030R	496	Double-High OH Cab.
E6OD159630C	496	Double-High OH Cab.
E6OD159630L	495	Double-High OH Cab.
E6OD159630P	497	Double-High OH Cab.
E6OD159630R	496	Double-High OH Cab.
E60F15307	506	Open Shelf
E60F15367	506	Open Shelf
E60F15427	506	Open Shelf
E60F15487	506	Open Shelf
E60F15547	506	Open Shelf
E60F15607	506	Open Shelf
E60015307	505	Open Shelf
E60015367	505	Open Shelf
E60015427	505	Open Shelf
E60015487	505	Open Shelf
E60015547	505	Open Shelf
E60015607	505	Open Shelf
E60015667	505	Open Shelf
E60015727	505	Open Shelf
E60015787	505	Open Shelf
E60015847	505	Organizer Shelf
E60015907	505	Organizer Shelf
E60015967	505	Organizer Shelf
E60017307	505	Organizer Shelf
E60017367	505	Organizer Shelf
E60017427	505	Organizer Shelf
E60017487	505	Organizer Shelf
E60017547	505	Organizer Shelf
E60017607	505	Organizer Shelf
E60017667	505	Organizer Shelf
E60017727	505	Organizer Shelf

Style Number	Page	Description	Style Number	Page	Description
E60O17787	505	Organizer Shelf	E6OS159022H	491	Single-High OH Cab
E60O17847	505	Organizer Shelf	E6OS159022P	492	Single-High OH Cab
E60O17907	505	Organizer Shelf	E6OS159615H	486	Single-High OH Cab
E60O17967	505	Organizer Shelf	E6OS159615P	489	Single-High OH Cab
E6OS153015H	486	Single-High OH Cab	E6OS159615S	488	Single-High OH Cab
E6OS153015P	489	Single-High OH Cab	E6OS159622H	491	Single-High OH Cab
E6OS153022H	491	Sgl High OH	E6OS159622P	492	Single-High OH Cab
E6OS153022P	492	Sgl High OH	E6OS173015P	489	Single-High OH Cab
E6OS153615H	486	Single-High OH Cab	E6OS173615P	489	Single-High OH Cab
E6OS153615P	489	Single-High OH Cab	E6OS174215P	489	Single-High OH Cab
E6OS153615S	488	Single-High OH Cab	E6OS174815P	489	Single-High OH Cab
E6OS153622H	491	Single-High OH Cab	E6OS175415P	489	Single-High OH Cab
E6OS153622P	492	Single-High OH Cab	E6OS176015P	489	Single-High OH Cab
E6OS154215H	486	Single-High OH Cab	E6OS176615P	489	Single-High OH Cab
E6OS154215P	489	Single-High OH Cab	E6OS177215P	489	Single-High OH Cab
E6OS154215S	488	Single-High OH Cab	E6OS177815P	489	Single-High OH Cab
E6OS154222H	491	Single-High OH Cab	E6OS178415P	489	Single-High OH Cab
E6OS154222P	492	Single-High OH Cab	E6OS179015P	489	Single-High OH Cab
E6OS154815H	486	Single-High OH Cab	E6OS179615P	489	Single-High OH Cab
E6OS154815P	489	Single-High OH Cab	E6OS183015H	487	Single-High OH Cab
E6OS154815S	488	Single-High OH Cab	E6OS183615H	487	Single-High OH Cab
E6OS154822H	491	Single-High OH Cab	E6OS183615S	488	Single-High OH Cab
E6OS154822P	492	Single-High OH Cab	E6OS184215H	487	Single-High OH Cab
E6OS155415H	486	Single-High OH Cab	E6OS184215S	488	Single-High OH Cab
E6OS155415P	489	Single-High OH Cab	E6OS184815H	487	Single-High OH Cab
E6OS155415S	488	Single-High OH Cab	E6OS184815S	488	Single-High OH Cab
E6OS155422H	491	Single-High OH Cab	E6OS185415H	487	Single-High OH Cab
E6OS155422P	492	Single-High OH Cab	E6OS185415S	488	Single-High OH Cab
E6OS156015H	486	Single-High OH Cab	E6OS186015H	487	Single-High OH Cab
E6OS156015P	489	Single-High OH Cab	E6OS186015S	488	Single-High OH Cab
E6OS156015S	488	Single-High OH Cab	E6OS186615H	487	Single-High OH Cab
E6OS156022H	491	Single-High OH Cab	E6OS186615S	488	Single-High OH Cab
E6OS156022P	492	Single-High OH Cab	E6OS187215H	487	Single-High OH Cab
E6OS156615H	486	Single-High OH Cab	E6OS187215S	488	Single-High OH Cab
E6OS156615P	489	Single-High OH Cab	E6OS187815H	487	Single-High OH Cab
E6OS156615S	488	Single-High OH Cab	E6OS187815S	488	Single-High OH Cab
E6OS156622H	491	Single-High OH Cab	E6OS188415H	487	Single-High OH Cab
E6OS156622P	492	Single-High OH Cab	E6OS188415S	488	Single-High OH Cab
E6OS157215H	486	Single-High OH Cab	E6OS189015H	487	Single-High OH Cab
E6OS157215P	489	Single-High OH Cab	E6OS189015S	488	Single-High OH Cab
E6OS157215S	488	Single-High OH Cab	E6OS189615H	487	Single-High OH Cab
E6OS157222H	491	Single-High OH Cab	E6OS189615S	488	Single-High OH Cab
E6OS157222P	492	Single-High OH Cab	E6PA231527B	289	Adjustable-Height Ped
E6OS157815H	486	Single-High OH Cab	E6PA231527F	289	Adjustable-Height Ped
E6OS157815P	489	Single-High OH Cab	E6PA231827B	289	Adjustable-Height Ped
E6OS157815S	488	Single-High OH Cab	E6PA231827F	289	Adjustable-Height Ped
E6OS157822H	491	Single-High OH Cab	E6PA233027F	289	Adjustable-Height Ped
E6OS157822P	492	Single-High OH Cab	E6PA233627F	289	Adjustable-Height Ped
E6OS158415H	486	Single-High OH Cab	E6PA291527B	289	Adjustable-Height Ped
E6OS158415P	489	Single-High OH Cab	E6PA291527F	289	Adjustable-Height Ped
E6OS158415S	488	Single-High OH Cab	E6PD161527P	285	Plinth Bs Hgd Dr Ped
E6OS158422H	491	Single-High OH Cab	E6PD161827P	285	Plinth Bs Hgd Dr Ped
E6OS158422P	492	Single-High OH Cab	E6PD163015P	297	Plinth Bs Open Bkcs
E6OS159015H	486	Single-High OH Cab	E6PD163021P	294	Plinth Bs 1.5 High Stg
E6OS159015P	489	Single-High OH Cab	E6PD163027P	286	Plnth Bs Und WS Bkcs
E6OS159015S	488	Single-High OH Cab	E6PD163615P	297	Plinth Bs Open Bkcs

Style Number Index, continued

Style Number	Page	Description
E6PD163621P	294	Plinth Bs 1.5 High Stg
E6PD163627P	286	Plnth Bs Und WS Bkcs
E6PD164221P	294	Plinth Bs 1.5 High Stg
E6PD171527B	283	Plinth Bs 2-B/F Ped
E6PD171527F	283	Plinth Bs 2-B/F Ped
E6PD171527L	284	Plinth Bs Hgd Dr Ped
E6PD171527R	284	Plinth Bs Hgd Dr Ped
E6PD171827B	283	Plinth Bs 2-B/F Ped
E6PD171827F	283	Plinth Bs F/F Ped
E6PD171827L	284	Plinth Bs Hgd Dr Ped
E6PD171827R	284	Plinth Bs Hgd Dr Ped
E6PD173015N	297	Plinth Bs File Dwr Ped
E6PD173021G	293	Plinth Bs 1.5 High Stg
E6PD173027D	284	Plinth Bs 2-Hi Lat Ped
E6PD173027F	285	Plinth Bs 2-Hi Lat Ped
E6PD173615N	297	Plinth Bs File Dwr Ped
E6PD173621G	293	Plinth Bs 1.5 High Stor
E6PD173627D	284	Plinth Bs 2-Hi Lat Ped
E6PD173627F	285	Plinth Bs 2-Hi Lat Ped
E6PD221527P	285	Plinth Bs Hgd Dr Ped
E6PD221827P	285	Plinth Bs Hgd Dr Ped
E6PD223015P	297	Plinth Bs Opn Bks Ped
E6PD223021P	294	Plinth Bs 1.5 High Stg
E6PD223021T	294	Plinth Bs 1.5 High Stg
E6PD223027P	286	Plnth Bs Und WS Bkcs
E6PD223615P	297	Plinth Bs Open Bkcs
E6PD223621P	294	Plinth Bs 1.5 High Stor
E6PD223621T	294	Plinth Bs 1.5 High Stor
E6PD223627P	286	Plnth Bs Und WS Bkcs
E6PD224221P	294	Plinth Bs 1.5 High Stg
E6PD231521C	293	1.5 High Stg
E6PD231527B	283	Plinth Bs 2-B/F Ped
E6PD231527F	283	Plinth Bs 2-File Ped
E6PD231527L	284	Plinth Bs Hgd Dr Ped
E6PD231527R	284	Plinth Bs Hgd Dr Ped
E6PD231821C	293	1.5 High Stg
E6PD231827B	283	Plinth Bs 2-B/F Ped
E6PD231827F	283	Plinth Bs 2-File Ped
E6PD231827L	284	Plinth Bs Hgd Dr Ped
E6PD231827R	284	Plinth Bs Hgd Dr Ped
E6PD233015N	297	Plinth Bs File Dr Ped
E6PD233021C	293	Plinth Bs 1.5 High Stor
E6PD233021G	293	Plinth Bs 1.5 High Stor
E6PD233027D	284	Plinth Bs Hgd Dr Ped
E6PD233027F	285	Plinth Bs 2-Hi Lat Ped
E6PD233615N	297	Plinth Bs File Dr Ped
E6PD233621C	293	Plinth Bs 1.5 High Stor
E6PD233621G	293	Plinth Bs 1.5 High Stor
E6PD233627D	284	Plinth Bs 2-Hi Lat Ped
E6PD233627F	285	Plinth Bs 2-Hi Lat Ped
E6PD283027P	286	Plnth Bs Und WS Bkcs
E6PD283627P	286	Plnth Bs Und WS Bkcs
E6PD291527B	283	Plinth Bs 2-B/F Ped
E6PD291527F	283	Plinth Bs 2-Hi Lat Ped
E6PD291827B	283	Plinth Bs 2-B/F Ped
E6PD291827F	283	Plinth Bs 2-File Dr Ped

Style Number	Page	Description
E6PD293027D	284	Plinth Bs Hgd Dr Ped
E6PD293027F	285	Plinth Bs 2-Lateral File
E6PD293627F	285	Plinth Bs 2-Lateral File
E6PDHAD	308	Plinth Bs Ped Ology Ap
E6PH151535L	303	Plnth Bs High Pedestal
E6PH151535P	303	Plnth Bs High Pedestal
E6PH151535R	303	Plnth Bs High Pedestal
E6PHL151535L	357	Leg Bs High Pedestal
E6PHL151535R	357	Leg Bs High Pedestal
E6PM201523	301	Plinth Bs Mobile Ped
E6PS238	564	Leg Bs Power Shroud
E6QCT1212	260	Plinth Bs Cnr Supp Kits
E6QKT151215	260	Plinth Bs Cnr Supp Kits
E6QKT151223	260	Plinth Bs Cnr Supp Kits
E6QKT231215	260	Plinth Bs Cnr Supp Kits
E6QKT231223	260	Plinth Bs Cnr Supp Kits
E6QL24	277	Height-Adjustable Leg
E6QL27	277	Height-Adjustable Leg
E6QR6227T	276	Rectangular Col Leg
E6QR6227TB	276	Rectangular Col Leg
E6RN184227BL	361	Leg Bs Rtn Cred
E6RN184227BR	361	Leg Bs Rtn Cred
E6RN184227CL	362	Leg Bs Rtn Cred
E6RN184227CR	362	Leg Bs Rtn Cred
E6RN184827BL	361	Leg Bs Rtn Cred
E6RN184827BR	361	Leg Bs Rtn Cred
E6RN184827CL	362	Leg Bs Rtn Cred
E6RN184827CR	362	Leg Bs Rtn Cred
E6RN186027BL	361	Leg Bs Rtn Cred
E6RN186027BR	361	Leg Bs Rtn Cred
E6RN186027CL	362	Leg Bs Rtn Cred
E6RN186027CR	362	Leg Bs Rtn Cred
E6RN244227BL	362	Leg Bs Rtn Cred
E6RN244227BR	363	Leg Bs Rtn Cred
E6RN244227CL	363	Leg Bs Rtn Cred
E6RN244227CR	363	Leg Bs Rtn Cred
E6RN244827BL	362	Leg Bs Rtn Cred
E6RN244827BR	363	Leg Bs Rtn Cred
E6RN244827CL	363	Leg Bs Rtn Cred
E6RN244827CR	363	Leg Bs Rtn Cred
E6RN246027BL	362	Leg Bs Rtn Cred
E6RN246027BR	363	Leg Bs Rtn Cred
E6RN246027CL	363	Leg Bs Rtn Cred
E6RN246027CR	363	Leg Bs Rtn Cred
E6SF712	277	Parallel Slip-Fit Supprt
E6SL188R	277	Leg Bs Stg Leg
E6SL248R	277	Leg Bs Stg Leg
E6SL8SL	277	Leg Bs Stg Leg
E6SL8SR	277	Leg Bs Stg Leg
E6TW181545J	335	Plinth Bs Tower
E6TW181545L	327	Plinth Bs Tower
E6TW181545R	329	Plinth Bs Tower
E6TW181555J	335	Plinth Bs Tower
E6TW181555L	327	Plinth Bs Tower
E6TW181555R	329	Plinth Bs Tower
E6TW182445T	332	Plinth Bs Tower

Style Number	Page	Description	Style Number	Page	Description
E6TW182445W	333	Plinth Bs Tower	E6TW302472C	328	Plinth Bs Tower
E6TW182455T	332	Plinth Bs Tower	E6TW302472D	329	Plinth Bs Tower
E6TW182455W	333	Plinth Bs Tower	E6TW302477C	328	Plinth Bs Tower
E6TW241545E	332	Plinth Bs Tower	E6TW302477D	329	Plinth Bs Tower
E6TW241545F	333	Plinth Bs Tower	E6TWL181555L	469	Leg Bs Tower
E6TW241545J	335	Plinth Bs Tower	E6TWL181555R	470	Leg Bs Tower
E6TW241545L	327	Plinth Bs Tower	E6TWL182455T	473	Leg Bs Tower
E6TW241545R	329	Plinth Bs Tower	E6TWL182455W	474	Leg Bs Tower
E6TW241555J	335	Plinth Bs Tower	E6TWL241555L	469	Leg Bs Tower
E6TW241555L	327	Plinth Bs Tower	E6TWL241555R	470	Leg Bs Tower
E6TW241555R	329	Plinth Bs Tower	E6TWL241565A	469	Leg Bs Tower
E6TW241565A	327	Plinth Bs Tower	E6TWL241565B	470	Leg Bs Tower
E6TW241565B	329	Plinth Bs Tower	E6TWL241572A	469	Leg Bs Tower
E6TW241565E	332	Plinth Bs Tower	E6TWL241572B	470	Leg Bs Tower
E6TW241565F	333	Plinth Bs Tower	E6TWL242455T	473	Leg Bs Tower
E6TW241565J	335	Plinth Bs Tower	E6TWL242455W	474	Leg Bs Tower
E6TW241572A	327	Plinth Bs Tower	E6TWL242465C	470	Leg Bs Tower
E6TW241572B	329	Plinth Bs Tower	E6TWL242465D	471	Leg Bs Tower
E6TW241572E	332	Plinth Bs Tower	E6TWL242465G	473	Leg Bs Tower
E6TW241572F	333	Plinth Bs Tower	E6TWL242465H	474	Leg Bs Tower
E6TW241572J	335	Plinth Bs Tower	E6TWL242465K	477	Leg Bs Tower
E6TW241577A	327	Plinth Bs Tower	E6TWL242465L	477	Leg Bs Tower
E6TW241577B	329	Plinth Bs Tower	E6TWL242465M	478	Leg Bs Tower
E6TW241577E	332	Plinth Bs Tower	E6TWL242465N	478	Leg Bs Tower
E6TW241577F	333	Plinth Bs Tower	E6TWL242472C	470	Leg Bs Tower
E6TW241577J	335	Plinth Bs Tower	E6TWL242472D	471	Leg Bs Tower
E6TW242445G	332	Plinth Bs Tower	E6TWL242472G	473	Leg Bs Tower
E6TW242445H	333	Plinth Bs Tower	E6TWL242472H	474	Leg Bs Tower
E6TW242445K	336	Plinth Bs Tower	E6TWL242472K	477	Leg Bs Tower
E6TW242445L	336	Plinth Bs Tower	E6TWL242472L	477	Leg Bs Tower
E6TW242445T	332	Plinth Bs Tower	E6VP4C	557	Wire Power Unit
E6TW242445W	333	Plinth Bs Tower	E6VP4H	557	Wire Power Unit
E6TW242455T	332	Plinth Bs Tower	E6VPC	557	Wire Power Unit
E6TW242455W	333	Plinth Bs Tower	E6VPH	557	Wire Power Unit
E6TW242465C	328	Plinth Bs Tower	E6VZ24C	556	Technology Zone
E6TW242465D	329	Plinth Bs Tower	E6VZ24H	556	Technology Zone
E6TW242465G	332	Plinth Bs Tower	E6VZ24M	556	Technology Zone
E6TW242465H	333	Plinth Bs Tower	E6WB1842	225	Bridge WS
E6TW242465K	336	Plinth Bs Tower	E6WB1848	225	Bridge WS
E6TW242465L	336	Plinth Bs Tower	E6WB2442	225	Bridge WS
E6TW242465M	336	Plinth Bs Tower	E6WB2448	225	Bridge WS
E6TW242465N	336	Plinth Bs Tower	E6WC4242242	239	Frnt Cnr WS
E6TW242472C	328	Plinth Bs Tower	E6WC4242303	239	Frnt Cnr WS
E6TW242472D	329	Plinth Bs Tower	E6WD2460	217	Desk WS
E6TW242472G	332	Plinth Bs Tower	E6WD2460T	219	Tech Desk WS
E6TW242472H	333	Plinth Bs Tower	E6WD2466	217	Desk WS
E6TW242472K	336	Plinth Bs Tower	E6WD2466T	219	Tech Desk WS
E6TW242472L	336	Plinth Bs Tower	E6WD2472	217	Desk WS
E6TW242477C	328	Plinth Bs Tower	E6WD2472T	219	Tech Desk WS
E6TW242477D	329	Plinth Bs Tower	E6WD2478	217	Desk WS
E6TW242477G	332	Plinth Bs Tower	E6WD2478T	219	Tech Desk WS
E6TW242477H	333	Plinth Bs Tower	E6WD2484	217	Desk WS
E6TW242477K	336	Plinth Bs Tower	E6WD2484T	219	Tech Desk WS
E6TW242477L	336	Plinth Bs Tower	E6WD2490	217	Desk WS
E6TW302465C	328	Plinth Bs Tower	E6WD2490T	219	Tech Desk WS
E6TW302465D	329	Plinth Bs Tower	E6WD3060	217	Desk WS

Style Number Index, continued

Style Number	Page	Description
E6WD3060T	219	Tech Desk WS
E6WD3066	217	Desk WS
E6WD3066T	219	Tech Desk WS
E6WD3072	217	Desk WS
E6WD3072T	219	Tech Desk WS
E6WD3078	217	Desk WS
E6WD3078T	219	Tech Desk WS
E6WD3084	217	Desk WS
E6WD3084T	219	Tech Desk WS
E6WD3090	217	Desk WS
E6WD3090T	219	Tech Desk WS
E6WD3666	217	Desk WS
E6WD3666T	219	Tech Desk WS
E6WD3672	217	Desk WS
E6WD3672T	219	Tech Desk WS
E6WD3678	217	Desk WS
E6WD3678T	219	Tech Desk WS
E6WD3684	217	Desk WS
E6WD3684T	219	Tech Desk WS
E6WD3690	217	Desk WS
E6WD3690T	219	Tech Desk WS
E6WE3060	231	Frstnd WS Bullet
E6WE3066	231	Frstnd WS Bullet
E6WE3072	231	Frstnd WS Bullet
E6WE3078	231	Frstnd WS Bullet
E6WE3084	231	Frstnd WS Bullet
E6WE3090	231	Frstnd WS Bullet
E6WE3660	231	Frstnd WS Bullet
E6WE3666	231	Frstnd WS Bullet
E6WE3672	231	Frstnd WS Bullet
E6WE3678	231	Frstnd WS Bullet
E6WE3684	231	Frstnd WS Bullet
E6WE3690	231	Frstnd WS Bullet
E6WF302436N	229	Dbl Tapered WS
E6WF302436S	229	Dbl Tapered WS
E6WF363048N	229	Dbl Tapered WS
E6WF363048S	229	Dbl Tapered WS
E6WF363060N	229	Dbl Tapered WS
E6WF363060S	229	Dbl Tapered WS
E6WF423672N	229	Dbl Tapered WS
E6WF423672S	229	Dbl Tapered WS
E6WG306642L	233	P-Top WS
E6WG306642R	233	P-Top WS
E6WG307242L	233	P-Top WS
E6WG307242R	233	P-Top WS
E6WG367248L	233	P-Top WS
E6WG367248R	233	P-Top WS
E6WH243072R	227	Sngl-Tapered WS
E6WH243090R	227	Sngl-Tapered WS
E6WH302472L	227	Sngl-Tapered WS
E6WH302490L	227	Sngl-Tapered WS
E6WI243036R	229	Tapered Run-off WS
E6WI243060R	229	Tapered Run-off WS
E6WI302436L	229	Tapered Run-off WS
E6WI302460L	229	Tapered Run-off WS
E6WJ1530A	243	Transaction Top WS

Style Number	Page	Description
E6WJ1530M	243	Transaction Top WS
E6WJ1536A	243	Transaction Top WS
E6WJ1536M	243	Transaction Top WS
E6WJ1542A	243	Transaction Top WS
E6WJ1542M	243	Transaction Top WS
E6WJ1548A	243	Transaction Top WS
E6WJ1548M	243	Transaction Top WS
E6WJ1560A	243	Transaction Top WS
E6WJ1560M	243	Transaction Top WS
E6WM3042	231	Bullet Runoff WS
E6WM3048	231	Bullet Runoff WS
E6WM3054	231	Bullet Runoff WS
E6WM3060	231	Bullet Runoff WS
E6WM3066	231	Bullet Runoff WS
E6WM3072	231	Bullet Runoff WS
E6WM3642	231	Bullet Runoff WS
E6WM3648	231	Bullet Runoff WS
E6WM3654	231	Bullet Runoff WS
E6WM3660	231	Bullet Runoff WS
E6WM3666	231	Bullet Runoff WS
E6WM3672	231	Bullet Runoff WS
E6WN3060L	223	Desk Return WS
E6WN3060R	223	Desk Return WS
E6WN3072L	223	Desk Return WS
E6WN3072R	223	Desk Return WS
E6WN3660L	223	Desk Return WS
E6WN3660R	223	Desk Return WS
E6WN3672L	223	Desk Return WS
E6WN3672R	223	Desk Return WS
E6WO30	245	Round Table WS
E6WO36	245	Round Table WS
E6WP306642L	233	Freestanding P-Top
E6WP306642R	233	Freestanding P-Top
E6WP307242L	233	Freestanding P-Top
E6WP307242R	233	Freestanding P-Top
E6WP367248L	233	Freestanding P-Top
E6WP367248R	233	Freestanding P-Top
E6WQ3030	245	Square Table WS
E6WQ3636	245	Square Table WS
E6WR1830L	221	Return WS
E6WR1830R	221	Return WS
E6WR1836L	221	Return WS
E6WR1836R	221	Return WS
E6WR1842L	221	Return WS
E6WR1842R	221	Return WS
E6WR1848L	221	Return WS
E6WR1848R	221	Return WS
E6WR1860L	221	Return WS
E6WR1860R	221	Return WS
E6WR1872L	221	Return WS
E6WR1872R	221	Return WS
E6WR2430L	221	Return WS
E6WR2430R	221	Return WS
E6WR2436L	221	Return WS
E6WR2436R	221	Return WS
E6WR2442L	221	Return WS

Style Number	Page	Description	Style Number	Page	Description
E6WR2442R	221	Return WS	E6WS2496	212	Straight WS
E6WR2448L	221	Return WS	E6WS2496T	215	Tech Straight WS
E6WR2448R	221	Return WS	E6WS30102	212	Straight WS
E6WR2460L	221	Return WS	E6WS30108	212	Straight WS
E6WR2460R	221	Return WS	E6WS30114	212	Straight WS
E6WR2472L	221	Return WS	E6WS30120	212	Straight WS
E6WR2472R	221	Return WS	E6WS3024	212	Straight WS
E6WS1830	211	Straight WS	E6WS3030	212	Straight WS
E6WS1836	211	Straight WS	E6WS3036	212	Straight WS
E6WS1842	211	Straight WS	E6WS3042	212	Straight WS
E6WS1842T	215	Tech Straight WS	E6WS3048	212	Straight WS
E6WS1848	211	Straight WS	E6WS3054	212	Straight WS
E6WS1848T	215	Tech Straight WS	E6WS3060	212	Straight WS
E6WS1854	211	Straight WS	E6WS3066	212	Straight WS
E6WS1854T	215	Tech Straight WS	E6WS3072	212	Straight WS
E6WS1860	211	Straight WS	E6WS3078	212	Straight WS
E6WS1860T	215	Tech Straight WS	E6WS3084	212	Straight WS
E6WS1866	211	Straight WS	E6WS3090	212	Straight WS
E6WS1866T	215	Tech Straight WS	E6WS3096	212	Straight WS
E6WS1872	211	Straight WS	E6WSHAD	311	Ology Open Pedestal
E6WS1872T	215	Tech Straight WS	E6WU4242242	239	Front Corner WS
E6WS1878	211	Straight WS	E6WU4242303	239	Front Corner WS
E6WS1878T	215	Tech Straight WS	E6WW303666	217	Bow Front WS
E6WS1884	211	Straight WS	E6WW303672	217	Bow Front WS
E6WS1884T	215	Tech Straight WS	E6WW364272	217	Bow Front WS
E6WS1890	211	Straight WS	E6WW364278	217	Bow Front WS
E6WS1890T	215	Tech Straight WS	E6WW364284	217	Bow Front WS
E6WS24102	212	Straight WS	E6XC4260242	241	Ext. Corner WS
E6WS24102T	215	Tech Straight WS	E6XC4266242	241	Ext. Corner WS
E6WS24108	212	Straight WS	E6XC4272242	241	Ext. Corner WS
E6WS24108T	215	Tech Straight WS	E6XC6042242	241	Ext. Corner WS
E6WS24114	212	Straight WS	E6XC6642242	241	Ext. Corner WS
E6WS24114T	215	Tech Straight WS	E6XC7242242	241	Ext. Corner WS
E6WS24120	212	Straight WS	E6XD4260L	237	Ext. Bullet WS
E6WS24120T	215	Tech Straight WS	E6XD4260R	237	Ext. Bullet WS
E6WS2424	211	Straight WS	E6XD4272L	237	Ext. Bullet WS
E6WS2430	211	Straight WS	E6XD4272R	237	Ext. Bullet WS
E6WS2436	211	Straight WS	E6XG3660L	235	Meeting WS
E6WS2442	211	Straight WS	E6XG3660R	235	Meeting WS
E6WS2442T	215	Tech Straight WS	E6XG3678L	235	Meeting WS
E6WS2448	211	Straight WS	E6XG3678R	235	Meeting WS
E6WS2448T	215	Tech Straight WS	FFAA23	605	Workwall Wire Manager
E6WS2454	211	Straight WS	FFAA29	605	Workwall Wire Manager
E6WS2454T	215	Tech Straight WS	FFAA35	605	Workwall Wire Manager
E6WS2460	211	Straight WS	FFAC	602	Wire Management Cut-out Cover
E6WS2460T	215	Tech Straight WS	FFAT23	602	Top Cap
E6WS2466	211	Straight WS	FFAT29	602	Top Cap
E6WS2466T	215	Tech Straight WS	FFAT35	602	Top Cap
E6WS2472	211	Straight WS	FFKB2214	598	Skin For Bin
E6WS2472T	215	Tech Straight WS	FFKB2214M	598	Cable Management Skin For Bin
E6WS2478	212	Straight WS	FFKB2814	598	Skin For Bin
E6WS2478T	215	Tech Straight WS	FFKB2814M	598	Cable Management Skin For Bin
E6WS2484	212	Straight WS	FFKB3414	598	Skin For Bin
E6WS2484T	215	Tech Straight WS	FFKB3414M	598	Cable Management Skin For Bin
E6WS2490	212	Straight WS	FFKC2324	600	Cantilever Desk and Table Attachment Skin
E6WS2490T	215	Tech Straight WS	FFKC2924	600	Cantilever Desk and Table Attachment Skin

Style Number Index, continued

Style Number	Page	Description	Style Number	Page	Description
FFKC3524	600	Cantilever Desk and Table Attachment Skin	FFPF22132	587	Workwall Perimeter Frame
FFKD2214	597	Skin For 16½"H Double Shelf	FFPF22138	587	Workwall Perimeter Frame
FFKD2214M	597	Cbl Mgmt Skin For 16½"H Double Shelf	FFPF22144	587	Workwall Perimeter Frame
FFKD2214T	597	Tech Skin For 16½"H Double Shelf	FFPF2224	587	Workwall Perimeter Frame
FFKD225	596	Skin For 8¼"H Double Shelf	FFPF2230	587	Workwall Perimeter Frame
FFKD2814	597	Skin For 16½"H Double Shelf	FFPF2236	587	Workwall Perimeter Frame
FFKD2814M	597	Cbl Mgmt Skin For 16½"H Double Shelf	FFPF2248	587	Workwall Perimeter Frame
FFKD2814T	597	Tech Skin For 16½"H Double Shelf	FFPF2254	587	Workwall Perimeter Frame
FFKD285	596	Skin For 8¼"H Double Shelf	FFPF2260	587	Workwall Perimeter Frame
FFKD3414	597	Skin For 16½"H Double Shelf	FFPF2266	587	Workwall Perimeter Frame
FFKD3414M	597	Cbl Mgmt Skin For 16½"H Double Shelf	FFPF2272	587	Workwall Perimeter Frame
FFKD3414T	597	Tech Skin For 16½"H Double Shelf	FFPF2278	587	Workwall Perimeter Frame
FFKD345	596	Skin For 8¼"H Double Shelf	FFPF2284	587	Workwall Perimeter Frame
FFKK2316	595	16½" High Skin	FFPF2290	587	Workwall Perimeter Frame
FFKK2316M	595	Cable Management Skin	FFPF2296	587	Workwall Perimeter Frame
FFKK2316T	595	Technology Skin	FFPF47102	587	Workwall Perimeter Frame
FFKK2333	595	33" High Skin	FFPF47108	587	Workwall Perimeter Frame
FFKK2349	595	49½" High Skin	FFPF47114	587	Workwall Perimeter Frame
FFKK238	595	8¼" High Skin	FFPF47120	587	Workwall Perimeter Frame
FFKK2916	595	16½" High Skin	FFPF47126	587	Workwall Perimeter Frame
FFKK2916M	595	Cable Management Skin	FFPF47132	587	Workwall Perimeter Frame
FFKK2916T	595	Technology Skin	FFPF47138	587	Workwall Perimeter Frame
FFKK2933	595	33" High Skin	FFPF47144	587	Workwall Perimeter Frame
FFKK2949	595	49½" High Skin	FFPF4724	587	Workwall Perimeter Frame
FFKK298	595	8¼" High Skin	FFPF4730	587	Workwall Perimeter Frame
FFKK3516	595	16½" High Skin	FFPF4736	587	Workwall Perimeter Frame
FFKK3516M	595	Cable Management Skin	FFPF4748	587	Workwall Perimeter Frame
FFKK3516T	595	Technology Skin	FFPF4754	587	Workwall Perimeter Frame
FFKK3533	595	33" High Skin	FFPF4760	587	Workwall Perimeter Frame
FFKK3549	595	49½" High Skin	FFPF4766	587	Workwall Perimeter Frame
FFKK358	595	8¼" High Skin	FFPF4772	587	Workwall Perimeter Frame
FFKQ3524L	600	Cantilever Desk and Table Attachment Skin	FFPF4778	587	Workwall Perimeter Frame
FFKQ3524R	600	Cantilever Desk and Table Attachment Skin	FFPF4784	587	Workwall Perimeter Frame
FFKS2215	597	Skin For 16½"H Single Shelf	FFPF4790	587	Workwall Perimeter Frame
FFKS2215M	597	Cbl Mgmt Skin For 16½"H Single Shelf	FFPF4796	587	Workwall Perimeter Frame
FFKS2215T	597	Tech Skin For 16½"H Single Shelf	FFPF64102	587	Workwall Perimeter Frame
FFKS227	597	Skin For 8¼"H Single Shelf	FFPF64108	587	Workwall Perimeter Frame
FFKS2815	597	Skin For 16½"H Single Shelf	FFPF64114	587	Workwall Perimeter Frame
FFKS2815M	597	Cbl Mgmt Skin For 16½"H Single Shelf	FFPF64120	587	Workwall Perimeter Frame
FFKS2815T	597	Tech Skin For 16½"H Single Shelf	FFPF64126	587	Workwall Perimeter Frame
FFKS287	597	Skin For 8¼"H Single Shelf	FFPF64132	587	Workwall Perimeter Frame
FFKS3415	597	Skin For 16½"H Single Shelf	FFPF64138	587	Workwall Perimeter Frame
FFKS3415M	597	Cbl Mgmt Skin For 16½"H Single Shelf	FFPF64144	587	Workwall Perimeter Frame
FFKS3415T	597	Tech Skin For 16½"H Single Shelf	FFPF6424	587	Workwall Perimeter Frame
FFKS347	597	Skin For 8¼"H Single Shelf	FFPF6430	587	Workwall Perimeter Frame
FFKT2333C	599	TV Attachment Skin, Centered	FFPF6436	587	Workwall Perimeter Frame
FFKT2333S	599	TV Attachment Skin—Pair, Spanning	FFPF6448	587	Workwall Perimeter Frame
FFKT2933C	599	TV Attachment Skin, Centered	FFPF6454	587	Workwall Perimeter Frame
FFKT2933S	599	TV Attachment Skin—Pair, Spanning	FFPF6460	587	Workwall Perimeter Frame
FFKT3533C	599	TV Attachment Skin, Centered	FFPF6466	587	Workwall Perimeter Frame
FFKT3533S	599	TV Attachment Skin—Pair, Spanning	FFPF6472	587	Workwall Perimeter Frame
FFPF22102	587	Workwall Perimeter Frame	FFPF6478	587	Workwall Perimeter Frame
FFPF22108	587	Workwall Perimeter Frame	FFPF6484	587	Workwall Perimeter Frame
FFPF22114	587	Workwall Perimeter Frame	FFPF6490	587	Workwall Perimeter Frame
FFPF22120	587	Workwall Perimeter Frame	FFPF6496	587	Workwall Perimeter Frame
FFPF22126	587	Workwall Perimeter Frame	FFPF80102	587	Workwall Perimeter Frame

Style Number	Page	Description	Style Number	Page	Description
FFPF80108	587	Workwall Perimeter Frame	FFSH193516W	591	Single Shelf
FFPF80114	587	Workwall Perimeter Frame	FFSH19358C	589	Double Shelf
FFPF80120	587	Workwall Perimeter Frame	FFSH19358D	592	Drawer
FFPF80126	587	Workwall Perimeter Frame	FFSH19358U	590	Single Shelf
FFPF80132	587	Workwall Perimeter Frame	FFSH19358W	591	Single Shelf
FFPF80138	587	Workwall Perimeter Frame	FFVF21	588	Inner Vertical Frame Piece
FFPF80144	587	Workwall Perimeter Frame	FFVF46	588	Inner Vertical Frame Piece
FFPF8024	587	Workwall Perimeter Frame	FFVF63	588	Inner Vertical Frame Piece
FFPF8030	587	Workwall Perimeter Frame	FFVF79	588	Inner Vertical Frame Piece
FFPF8036	587	Workwall Perimeter Frame	FFVH102	603	Modular Harness
FFPF8048	587	Workwall Perimeter Frame	FFVH108	603	Modular Harness
FFPF8054	587	Workwall Perimeter Frame	FFVH114	603	Modular Harness
FFPF8060	587	Workwall Perimeter Frame	FFVH120	603	Modular Harness
FFPF8066	587	Workwall Perimeter Frame	FFVH24	603	Modular Harness
FFPF8072	587	Workwall Perimeter Frame	FFVH30	603	Modular Harness
FFPF8078	587	Workwall Perimeter Frame	FFVH36	603	Modular Harness
FFPF8084	587	Workwall Perimeter Frame	FFVH42	603	Modular Harness
FFPF8090	587	Workwall Perimeter Frame	FFVH48	603	Modular Harness
FFPF8096	587	Workwall Perimeter Frame	FFVH54	603	Modular Harness
FFSH122316C	589	Double Shelf	FFVH60	603	Modular Harness
FFSH122316U	590	Single Shelf	FFVH66	603	Modular Harness
FFSH122316W	591	Single Shelf	FFVH72	603	Modular Harness
FFSH12238C	589	Double Shelf	FFVH78	603	Modular Harness
FFSH12238U	590	Single Shelf	FFVH84	603	Modular Harness
FFSH12238W	591	Single Shelf	FFVH90	603	Modular Harness
FFSH122916C	589	Double Shelf	FFVH96	603	Modular Harness
FFSH122916U	590	Single Shelf	FFVIH	604	Hardwire Power Infeed
FFSH122916W	591	Single Shelf	FFVR1	603	1-Circuit Receptacle Kit
FFSH12298C	589	Double Shelf	FFVR2	604	2-Circuit Receptacle Kit
FFSH12298U	590	Single Shelf	FFVT23	604	Workwall Base Power Tray
FFSH12298W	591	Single Shelf	FFVT29	604	Workwall Base Power Tray
FFSH123516C	589	Double Shelf	FFVT35	604	Workwall Base Power Tray
FFSH123516U	590	Single Shelf	GFUCH	559	Convenience Comm Housing
FFSH123516W	591	Single Shelf	GFUTMB	560	Mounting Bracket
FFSH12358C	589	Double Shelf	GFUTMC	559	Clamp Kit
FFSH12358U	590	Single Shelf	GFUTP96	558	Cnvc Tri-Receptacle
FFSH12358W	591	Single Shelf	LOCK9201FR	623	Lock Cylinder
FFSH192316B	592	Bin	LOCK9201XF	623	Lock Cylinder
FFSH192316C	589	Double Shelf	LOCK9250FR	623	Lock Cylinder
FFSH192316U	590	Single Shelf	LOCK9250XF	623	Lock Cylinder
FFSH192316W	591	Single Shelf	SPC	117	Power & Comm Box
FFSH19238C	589	Double Shelf	SPCH	117	Power & Comm Box
FFSH19238D	592	Drawer	SPP	117	Power & Comm Box
FFSH19238U	590	Single Shelf	SPPH	117	Power & Comm Box
FFSH19238W	591	Single Shelf	TS5LEGCLP	561	Und WS Wire Clips
FFSH192916B	592	Bin	TS5SKEXT	563	Und WS Skel Wr Mgr
FFSH192916C	589	Double Shelf	TS5SKLBNE	563	Und WS Skel Wr Mgr
FFSH192916U	590	Single Shelf	VLYGDWL	141	Verlay Gumdrop Table
FFSH192916W	591	Single Shelf	VLYRECWL	146	Verlay Rectangle Table
FFSH19298C	589	Double Shelf	VLYRWL	139	Verlay Round Table
FFSH19298D	592	Drawer	VLYSQWL	143	Verlay Square Table
FFSH19298U	590	Single Shelf	VLYSTLWL	150	Verlay Sightline Table
FFSH19298W	591	Single Shelf	WLAL60S	63	Walden; Light Valance
FFSH193516B	592	Bin	WLAL66S	63	Walden; Light Valance
FFSH193516C	589	Double Shelf	WLAL72S	63	Walden; Light Valance
FFSH193516U	590	Single Shelf	WLAL90S	63	Walden; Light Valance

Style Number Index, continued

Style Number	Page	Description
WLB153028P	67	Walden; Freestanding Bookcase
WLB153045P	67	Walden; Freestanding Bookcase
WLB153072P	67	Walden; Freestanding Bookcase
WLB153628P	67	Walden; Freestanding Bookcase
WLB153645P	67	Walden; Freestanding Bookcase
WLB153672P	67	Walden; Freestanding Bookcase
WLS151543L	65	Walden; Stacking Bookcase
WLS151543P	65	Walden; Stacking Bookcase
WLS151543R	65	Walden; Stacking Bookcase
WLS153043D	65	Walden; Stacking Bookcase
WLS153043P	65	Walden; Stacking Bookcase
WLS153643D	65	Walden; Stacking Bookcase
WLS153643P	65	Walden; Stacking Bookcase
WLCZ24102F	55	Walden; Shell Credenza
WLCZ24102J	51	Walden; Kneespace Credenza
WLCZ24102K	51	Walden; Kneespace Credenza
WLCZ2460A	47	Walden; Full Storage Credenza
WLCZ2460B	47	Walden; Full Storage Credenza
WLCZ2460C	47	Walden; Full Storage Credenza
WLCZ2460D	48	Walden; Full Storage Credenza
WLCZ2460E	48	Walden; Full Storage Credenza
WLCZ2460L	51	Walden; Kneespace Credenza
WLCZ2460M	52	Walden; Kneespace Credenza
WLCZ2460N	52	Walden; Kneespace Credenza
WLCZ2460P	52	Walden; Kneespace Credenza
WLCZ2460R	53	Walden; Kneespace Credenza
WLCZ2466D	48	Walden; Full Storage Credenza
WLCZ2466E	48	Walden; Full Storage Credenza
WLCZ2466L	51	Walden; Kneespace Credenza
WLCZ2466M	52	Walden; Kneespace Credenza
WLCZ2466R	53	Walden; Kneespace Credenza
WLCZ2472A	47	Walden; Full Storage Credenza
WLCZ2472B	47	Walden; Full Storage Credenza
WLCZ2472C	47	Walden; Full Storage Credenza
WLCZ2472D	48	Walden; Full Storage Credenza
WLCZ2472F	55	Walden; Shell Credenza
WLCZ2472L	51	Walden; Kneespace Credenza
WLCZ2472M	52	Walden; Kneespace Credenza
WLCZ2472N	52	Walden; Kneespace Credenza
WLCZ2472P	52	Walden; Kneespace Credenza
WLCZ2472R	53	Walden; Kneespace Credenza
WLCZ2490D	48	Walden; Full Storage Credenza
WLCZ2490E	48	Walden; Full Storage Credenza
WLCZ2490J	51	Walden; Kneespace Credenza
WLCZ2490K	51	Walden; Kneespace Credenza
WLCZ2490N	52	Walden; Kneespace Credenza
WLCZ2490P	52	Walden; Kneespace Credenza
WLCZ2496F	55	Walden; Shell Credenza
WLCZ2496J	51	Walden; Kneespace Credenza
WLCZ2496K	51	Walden; Kneespace Credenza
WLD364272	27	Walden; Double-Pedestal Bow Desk
WLD3060	27	Walden; Double-Pedestal Desk
WLD3066	27	Walden; Double-Pedestal Desk
WLD3672	27	Walden; Double-Pedestal Desk
WLD3060L	31	Walden; Single-Pedestal Desk w/Legs
WLD3060R	31	Walden; Single-Pedestal Desk w/Legs

Style Number	Page	Description
WLD3066L	31	Walden; Single-Pedestal Desk w/Legs
WLD3066R	31	Walden; Single-Pedestal Desk w/Legs
WLD3072L	31	Walden; Single-Pedestal Desk w/Legs
WLD3072R	31	Walden; Single-Pedestal Desk w/Legs
WLD3060L	28	Walden; Single-Pedestal Desk
WLD3060R	28	Walden; Single-Pedestal Desk
WLD3066L	28	Walden; Single-Pedestal Desk
WLD3066R	28	Walden; Single-Pedestal Desk
WLD3072L	28	Walden; Single-Pedestal Desk
WLD3072R	28	Walden; Single-Pedestal Desk
WLD3672L	28	Walden; Single-Pedestal Desk
WLD3672R	28	Walden; Single-Pedestal Desk
WLDW364272L	28	Walden; Single-Pedestal Bow Desk
WLDW364272R	28	Walden; Single-Pedestal Bow Desk
WLG2442	42	Walden; Bridge
WLG2448	42	Walden; Bridge
WLIT6021S	62	Walden; Tackboard
WLIT6621S	62	Walden; Tackboard
WLIT7221S	62	Walden; Tackboard
WLIT9021S	62	Walden; Tackboard
WLKV243072B	69	Walden; Vertical Cabinet
WLKV243672B	69	Walden; Vertical Cabinet
WLKW243072	69	Walden; Wardrobe
WLKW243672	69	Walden; Wardrobe
WLLF243028T	59	Walden; Lateral File 2-High
WLLF243051F	60	Walden; Lateral File 4-High
WLLF243628T	59	Walden; Lateral File 2-High
WLLF243651F	60	Walden; Lateral File 4-High
WLMS156043C	61	Walden; Service Module
WLMS156043P	61	Walden; Service Module
WLMS156643C	61	Walden; Service Module
WLMS156643P	61	Walden; Service Module
WLMS157243C	61	Walden; Service Module
WLMS157243P	61	Walden; Service Module
WLMS159043C	61	Walden; Service Module
WLMS159043P	61	Walden; Service Module
WLN3018	43	Walden; Modesty Panel
WLN3618	43	Walden; Modesty Panel
WLN4218	43	Walden; Modesty Panel
WLN4818	43	Walden; Modesty Panel
WLN5418	43	Walden; Modesty Panel
WLN6018	43	Walden; Modesty Panel
WLN6618	43	Walden; Modesty Panel
WLN7818	43	Walden; Modesty Panel
WLN8418	43	Walden; Modesty Panel
WLN9018	43	Walden; Modesty Panel
WLP201523	56	Walden; Mobile Pedestal
WLRB3048	35	Walden; Bullet Run-Off
WLRB3060	35	Walden; Bullet Run-Off
WLRB3672	35	Walden; Bullet Run-Off
WLRD3060L	39	Walden; Desk Return
WLRD3060R	39	Walden; Desk Return
WLRD3072L	39	Walden; Desk Return
WLRD3072R	39	Walden; Desk Return
WLRS3048	34	Walden; Straight Run-off
WLRS3060	34	Walden; Straight Run-off

Style Number	Page	Description
WLRS3672	34	Walden; Straight Run-off
WLRT2442L	41	Walden; Return
WLRT2442R	41	Walden; Return
WLRT2448L	41	Walden; Return
WLRT2448R	41	Walden; Return
WLRT2472L	41	Walden; Return
WLRT2472R	41	Walden; Return
WLTB3060	36	Walden; Bullet-Shape Table
WLTB3672	36	Walden; Bullet-Shape Table
WLTD3060	33	Walden; Table Desk
WLTD3066	33	Walden; Table Desk
WLTD3072	33	Walden; Table Desk
WLTD3672	33	Walden; Table Desk
WLTW242472G	69	Walden; Tower
WLTW242472H	69	Walden; Tower
WLUC4242242	44	Walden; Corner Unit

Trademark List

- The following are registered trademarks for products of Steelcase Inc. or one of its related corporate entities: 4 o'clock, 900 Series, à la carte, Airtouch, Ally, Amia, Answer, Archipelago, Avenir, Ballet, Bix, Brayton International, Cachet, Canopy, Canto, Chancellor, Coalesse, Confidante, Context, Convene, CopyCam, Criterion, Crushed Can, Currency, dash, Designtex, Details, Detour, Drive, Elective Elements, Ellipse, Ember Chrome, Emerge, E-Table 2, FYI, Garland, Gentry, Ginkgo Biloba, Groupwork, Ideo, Jacket, Jenny, Jersey, Kart, Kick, LaCosta, Leap, Let's B, LiveBack, Max-Stacker, media:scape, Metro, Migrations, Mitra, Montage, Nurture, Oriana, Parade, Pathways, PCT, Permiso, Player, Portal, Power Pincher, Progeny, Protégé, R2, Rally, Relevant, Reply, Rizzi Arc, Sensor, Series 9000, Siento, Sieste, Sine, Softcare, Springboard, Steelcase, Steelcase Design Partnership, Stella, Stow Davis, Swathmore, Sylvi, TeamWork, Technique, Texpress, Think, Thunder, Topo, Train, turnstone, Underline, Unison, Vecta, Viridian, Walden, Wernld, and X-Stack.
- The following registered trademarks are under license from AWI Licensing Company, Dover, DE: SoundScapes, DuraBrite, BioBlock, and Armstrong.
- The following registered trademarks are under license from Byrne Electrical, Rockford, MI: Interport, Mini-Port, Axil Z, and Ellora.
- The following is a registered trademark of DuPont, Wilmington, DE: Corian.
- The following is a registered trademark of Genlyte Thomas Company, Louisville, KY: Lightolier.
- The following is a registered trademark of Hilti Corporation, FL-9494 Schaan, Principality of Liechtenstein: Hilti.
- The following is a registered trademark of Leviton Manufacturing Company, Little Neck, NY: Decora.
- The following is a registered trademark of Mechanical Plastics Corp, Elmsford, NY: Toggler.
- The following is a registered trademark of Microsoft Corporation, Redmond, WA: Microsoft.
- The following is a registered trademark of Panduit Corporation, Lockport, IL: Panduit.
- The following is a registered trademark of Trav (Press), Cuneo, Italy: Assisa.
- The following is a registered trademark of Virtual Ink, Boston, MA: mimioActive.
- The following registered trademarks are under license from Wilkhahn Furniture Products: Avera, Senzo, Versal, and Wilkhahn FS.

- The following is a registered trademark of Wilsonart International, Temple, TX: Chemsurf.
- The following is a registered trademark of Wiremold, West Hartford, CT: Wiremold.
- The following is a registered trademark of EMU Group S.P.A., Perugia, Italy: Emu.
- The following is a registered trademark of Security People, Inc.: Digilock.
- The following are trademarks for products of Steelcase Inc. or one of its related corporate entities: Access, Active/Passive Shelf, Ainsley, Akira, Alcove, Alerion, Alight, Amaris, American Elect, American Tradition, ap40, Arbor, Arriva, Asana, Ascot, Aspekt, Astor, Await, Bassline, B-Free, Bira, Bivi, Bixby, Bottomline, Brody, Brook, Buoy, Burton, c:scape, Calla, Calm, Camber, Campfire, Capa, Cappuccino, Cesar, Chester, Chord, Circa, Clarendon, Classic Rectangular, Clipper, cobì, Collaboration, Community, Company, Convey, Cortex, Coupe, Crea, Crew, Cura, Cypress, Davenport, Dearborn, Deck, Déjà, Denizen, Denska, Derby, Divisio, Donovan, Dune, Duo, Echo, Edge, Elsna, Empath, Empress, Enea, ēno, EnSync, Enviro, Escapade, Exchange, Exponents, Field, Flat Top, FlexFrame, Flip Top, Flute, Folio, FrameOne, FreeFlow, Frontier, Galliei, Gesture, Ginger, Ginkgo, Go Wall, Grip, Groove, Hatchback, Hawthorne, Hitch, Host Collection, Hosu, Huddleboard, i2i, Impact, Indy, InfoLink, IOS, I-Solve, Jack, Jarrah, Jetty, Juice, Kami, Kast, Kathryn, Lagunitas, Lark, L'Attitude, LearnLab, Leela, LessThanFive, Lincoln, Linden, LiveSeat, Loria, Lyric, Malibu, Malibu Too, Mansfield, Marathon, Martini, Mason, Masque, Migration, Millbrae, Mineral, Mingle, Mystic, Mystic Metal, Mystic Wood, Montara650, Montreal, Move, Nadia, Neighbor, nesso, Nickel, Nikko, Nod, Node, Norfolk, Ology, Ontrak, Oom, Opus, Orchid, Outlook Collection, Ovation, Paloma, Paperflo, Parliament, Pasio, Passerelle, Patriarch, Payback, Peek, Pile File, Pisa, Pool, Potrero415, PUCK, QiVi, Quba, Rave, Reed, Regard, Relay, Reunion, Ripple, Riser, Roam, Rocco, Rocky, RoomWizard, Runner, Satellite, Sawyer, ScapeSeries, Senti, Sentinel, Senza, Sequoia, Session, ShareLink, Shield, Shortcut, Sidewalk, SILQ, Skylar, Slumber, Smoke, Snug, Soft Leaf, Sonata, Sorrel, SOTO, Southside, Stationkits, Steelcase Series, Stiletto, Surprise!, Surround, Switch, Symphony, Sync, TagWizard, Tava, TeamStudio, TeamTheater, Tenaro, Terrazzo, Theorem, Thread, Topaz, Touchdown, Tour, Tower Too, Trees, Trillium, Trolley, tX2, U-Free, Umami, Underscore, Uno, V.I.A., Verb, Verge, Verlay, Victor2, Visalia, Waldorf, Woodruff, Workspring, and X-tenz.
- The following is a trademark of Microsoft Corporation, Redmond, WA: Windows.
- The following is a trademark of Rodman Industries, Inc., Oconomowoc, WI: ResinCore1.
- The following is a trademark of Ultrafabrics, LLC, Elmsford, NY: Ultraleather.

- The following trademarks are under license from Wilkhahn Furniture products: Cana, Linus, Logon, Picto, Range, Stitz, Thema, Timetable, and Tubis.
- The following trademark is used under license from Cradle to Cradle Products Innovation Institute, Oakland, CA: Cradle to Cradle Certified.
- The following trademarks are under license from Walter Knoll: Andoo, Bob, Lazlo, Lox, Ribbon, and Together.
- The following trademarks are under license from PP Möbler: Bar and Flag Halyard.
- The following trademarks are under license from Viccarbe: Davos, Holy Day, Last Minute, RS, Sistema, and Wrapp.
- The following trademarks are under license from Carl Hansen: Elbow, Paddle, Shell, Wing, and Wishbone.
- The following trademarks are under license from Cambridge Sound Management, LLC, Cambridge, MA: QtPro Soundmasking, Qt Quiet Technology, and Sonet Qt.
- The following is a trademark of Electri-Cable Assemblies, Shelton, CT: Interact.
- The following is a trademark of Clestra Hauserman: IRYS.
- The following is a trademark of Wiesner-Hager Möbel GmbH: Nooi.
- The following are trademarks of PolyVision: a³, e³, Flow, Motif, PolyVision, Sans, and Serif.
- The following is a trademark of Bostock Company, Inc: SnapCab.
- The following is a trademark of Williams-Sonoma, Inc: West Elm.
- The following is a trademark of Elena Marquina Testor: nanimarquina.
- The following is a trademark of Forbo International SA: Forbo.

Trademarks used here in are the property of Steelcase, Inc. or of their respective owners.