

---

# Stackable Chairs

**Max-Stacker III 477 Series**

**581**



---

# Understanding and Specifying Max-Stacker III 477 Series Stackable Chair

---

## Product Details

Max-Stacker III 477 Series	582
Dimensions	584

---

## Specifying

Stackable Chair	586
Accessories	587

---

### Stackable Chairs

**Stackable chairs** offer flexibility and ease of use in classrooms, auditoriums, or wherever extra seating is required.

- Max-Stacker III 477 Series
- Player 475 Series  
Leg-Base Chairs

# Max-Stacker III 477 Series

**Max-Stacker III** is a stacking chair perfect for high traffic areas. With a new texture and an updated finish offering, it fits into any environment.

**Tablet arms and bookracks** are available factory or field installed.

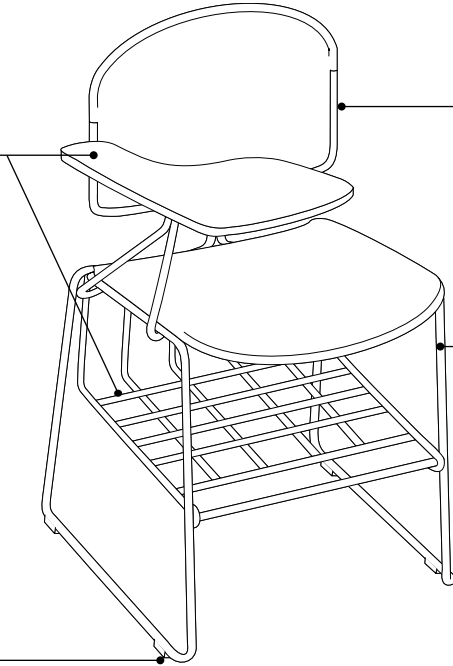

**Plastic glides** are standard. Soft felt glides, optional, are recommended for use on non-carpeted floors.

**Shell** is available in flexible, contoured plastic.

**Two-piece wire-rod frame** is  $\frac{7}{16}$ " diameter carbon steel for strength and durability.

## Product Details

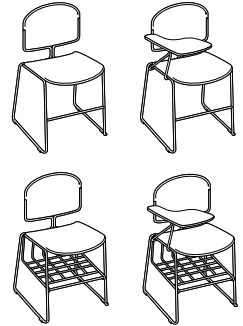

**Four configurations** are available—chairs without arms, chairs with bookracks, chairs with tablet arms, and chairs with a combination of bookrack and tablet arm.

**Max-Stacker III** can stack up to 12 chairs high when stacked on the floor.

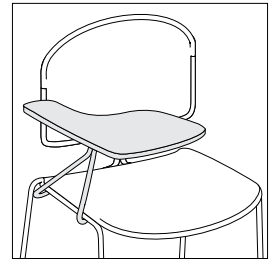

**Tablet arms** provide a writing surface that is  $12\frac{1}{2}$ "D x  $11\frac{3}{8}$ "W. They are available in left- or right-hand models.

**Clearance** between tablet arm and seat is  $7\frac{1}{4}$ "H. Tablet arm tilts for easy entrance and exit from chair.

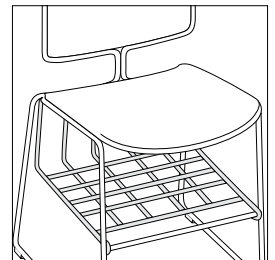

**Bookrack** is available factory or field installed for convenient storage of notebooks and purses.

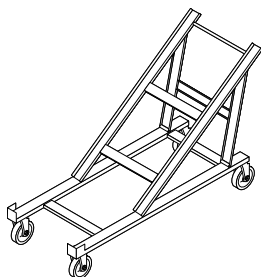

**Transport and storage dolly** is available to stack, move, and store up to 45 chairs. Chairs with book-racks and tablet arms cannot be stacked.

**Unloaded transport dolly** measures 55"D x 22"W x 37½"H.

**Fully loaded transport dolly** measures 57"D x 22"W x 68½"H.

**Without transport dolly** stack can be up to 12 chairs high.

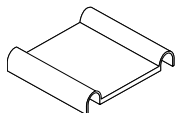

**Alignment device** is available to temporarily link chairs together in the field for evenly spaced rows. Chairs can be unlinked easily. Spacing between chairs linked with alignment device is 2¼".

## Surface Materials

▶ See surface materials on page 590 for specific availability or refer to the *Surface Materials Reference Manual* for further information.

### Hard components (frame)

- 4799 Platinum Metallic
- 7000 Black
- 7239 Midnight
- 9201 Polished Chrome

### Lux Coatings

- 4B20 Obsidian
- 4B22 Matte Brass
- 4B23 Burnished Bronze
- 4B24 Night Bronze
- 4B25 Matte Copper
- 4B26 Smoked Mica
- 4B27 Blue Steel
- 4B28 Silver Lilac
- 4B29 Cast Iron
- 4B30 Bright Gold

## Shell

### Price Group 1

#### Plastics

- 6009 Arctic White
- 6059 Sterling Dark Solid
- 6205 Black
- 6249 Platinum Solid
- 6259 Midnight
- 6332 Citron
- 6333 Picasso
- 6334 Flash
- 6335 Wasabi
- 6336 Jazz
- 6337 Element
- 6338 Chili Red
- 6BD8 Snow
- 6BD9 Carbon Flat
- 6BE1 Ore

### Price Group 2

#### Signature Plastics

- 6BC2 Purple
- 6BC5 Blue
- 6BC8 Gold
- 6BD1 Aubergine
- 6BD2 Peacock
- 6BD3 Jungle
- 6BD4 Merlot
- 6BD5 Honey
- 6BD6 Lagoon
- 6BD7 Saffron

### Bookrack

- Coated to match the frame color on seating coated models
- 9201 Polished Chrome on Polished Chrome models
- 4B20 Obsidian
- 4B22 Matte Brass
- 4B23 Burnished Bronze
- 4B24 Night Bronze
- 4B25 Matte Copper

### Tablet arms

- Laminate

### Glides

- Clear plastic
- Soft

## Programs & Services

▶ See the *Surface Materials Reference Manual* for further detail about programs and services offered for seating.

## Dimensions

▶ Page 584

## Resources

### Printed Materials

▶ Max-Stacker Brochure (11-0002245)

### Online Resources

▶ Environmental profiles available on [www.steelcase.com/sustainability](http://www.steelcase.com/sustainability).

# Dimensions

## Max-Stacker III 477 Series

• Features	• Overall Depth	Width	Height	• Seat Depth	• Functional Seat Depth	• Seat Width	• Seat Height from Floor	• Back Width	• Back Height from Seat	• Back Lumbar Height
<b>Max-Stacker III 477 Series</b>										
	21½"	20"	30¼"	17¾"	16¾"	18¼"	17½"	18¼"	14¾"	9½"

•Width •Between •Arms	•Arm •to •Floor	•Arm •Height •from •Seat	•Seat •Pan •Angle	•Angle •Between •Seat and •Back
-----------------------------	-----------------------	-----------------------------------	-------------------------	--

N.A.	N.A.	N.A.	8°	93°
------	------	------	----	-----

# Max-Stacker III 477 Series Stackable Chair

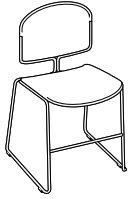

Standard Includes	Required to Specify
<p>► Need help? Product details, page 582</p> <ul style="list-style-type: none"> <li>• Frame: 7000 Black paint</li> <li>• Shell: plastic</li> <li>• Tablet arm, if selected: laminate</li> <li>• Bookrack, if selected: high-wear coating or 9201 Polished Chrome</li> <li>• Glides: plastic</li> </ul>	<ol style="list-style-type: none"> <li>1 Style number</li> <li>2 Seating coating color number for frame</li> <li>3 Plastic color number for shell</li> <li>4 Laminate color number for tablet arm, if selected (see below under Required Selections)</li> <li>5 High-wear coating or 9201 Polished Chrome for bookrack, if selected (see below under Required Selections)</li> <li>6 Options, if selected (see below)</li> </ol> <p>► See <i>Surface Materials</i>, page 590.</p>

Required Selections	U.S. Price	Required to Specify
<p><b>Tablet</b></p> <ul style="list-style-type: none"> <li>• No tablet</li> <li>• Tablet left</li> <li>• Tablet right</li> </ul>	<p>No cost +\$169 +\$169</p>	<p>Specify <i>with no tablet</i>. Specify <i>with tablet arm left</i> and select laminate color number. Specify <i>with tablet arm right</i> and select laminate color number.</p>
<p><b>Bookrack</b></p> <ul style="list-style-type: none"> <li>• No bookrack</li> <li>• Bookrack</li> </ul>	<p>No cost +\$102</p>	<p>Specify <i>with no bookrack</i>. Specify <i>with bookrack</i> and select color number.</p>

Options	U.S. Price	Required to Specify
<p><b>Surface Materials</b></p> <p><b>Frame</b></p> <ul style="list-style-type: none"> <li>• 7239 Midnight</li> <li>• 4799 Platinum Metallic</li> <li>• 9201 Polished Chrome</li> <li>• Lux Coatings</li> </ul>	<p>No cost +\$ 33 +\$ 33 +\$ 65</p>	<p>Specify <i>with 7239 Midnight</i>. Specify <i>with 4799 Platinum Metallic</i>. Specify <i>with 9201 Polished Chrome</i>. Specify Lux Coatings color number. ► See <i>Surface Materials</i>, page 590.</p>
<p><b>Shell</b></p> <ul style="list-style-type: none"> <li>• Plastic price group 1</li> <li>• Plastic price group 2</li> </ul>	<p>No cost +\$ 30</p>	<p>Specify color number. ► See <i>Surface Materials</i>, page 590. Specify color number. ► See <i>Surface Materials</i>, page 590.</p>
<p><b>Glides</b></p> <ul style="list-style-type: none"> <li>• Soft glides for use on non-carpeted floors</li> </ul>	<p>+\$ 6</p>	<p>Specify <i>with soft glides</i>.</p>

## Specification Information

Style Number	U.S. Base Price
477100	\$227
.	.

► Detailed dimensions, page 584



### For Canadian Pricing

Multiply U.S. Price by the Canadian price factor.

► See page 1 for details.



## Tablet Arm Assembly

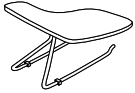

Standard Includes	Required to Specify
-------------------	---------------------

- Tablet arm frame: paint price group 1
- Tablet arm worksurface: laminate

- 1 Style number
- 2 Laminate color number
- 3 Paint color number for tablet arm frame
- 4 Options, if selected (see below)

Options	U.S. Price	Required to Specify
---------	------------	---------------------

**Surface Materials**

**Frame**

- Paint price group 1
- 4799 Platinum Metallic
- 9201 Polished Chrome
- Lux Coatings

- No cost
- +\$33
- +\$33
- +\$65

- Specify paint color number.  
Specify *with 4799 Platinum Metallic*.  
Specify *with 9201 Polished Chrome*.  
Specify Lux Coatings color number.  
▶ See *Surface Materials*, page 590.

Specification Information	
---------------------------	--

• **Style Number**

• **U.S. Base Price**

**Right-Hand**

**472TAR**      \$175

**Left-Hand**

**472TAL**      \$175

## Bookrack Assembly

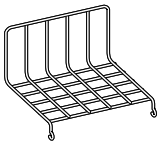

Standard Includes	Required to Specify
-------------------	---------------------

- Bookrack assembly: paint price group 1

- 1 Style number
- 2 Paint color number for bookrack
- 3 Options, if selected (see below)

Options	U.S. Price	Required to Specify
---------	------------	---------------------

**Surface Materials**

- Paint price group 1
- 4799 Platinum Metallic
- 9201 Polished Chrome
- Lux Coatings

- No cost
- +\$33
- +\$33
- +\$65

- Specify paint color number.  
Specify *with 4799 Platinum Metallic*.  
Specify *with 9201 Polished Chrome*.  
Specify Lux Coatings color number.  
▶ See *Surface Materials*, page 590.

Specification Information	
---------------------------	--

• **Style Number**

• **U.S. Base Price**

**472BR**      \$106



**For Canadian Pricing**

Multiply U.S. Price by the Canadian price factor.

▶ See page 1 for details.

**Alignment Device**

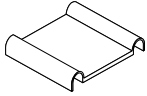

Standard Includes		Required to Specify
<ul style="list-style-type: none"> <li>• Carton of 12 alignment devices: black plastic only</li> </ul>		Style number
Specification Information		
• Style Number	• U.S. Price	
472G	\$40	

**Transport and Storage Dolly**

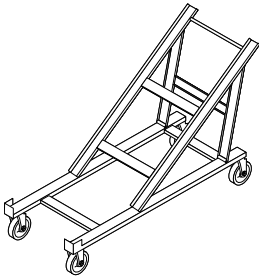

Standard Includes		Required to Specify
<ul style="list-style-type: none"> <li>• Transport and storage dolly: black paint only</li> </ul>		Style number
Specification Information		
• Style Number	• U.S. Price	
473D	\$581	



**For Canadian Pricing**  
 Multiply U.S. Price by the Canadian price factor.  
 ▶ See page 1 for details.