



Gargantua

TECHNICAL OVERVIEW

Gargantua

© design by Dirk Wynants

Backrest
Cushion
Floor fastening

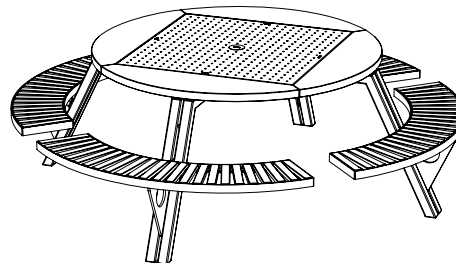

Gargantua

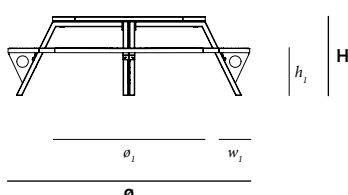
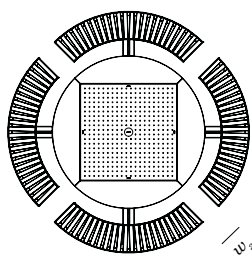

Dimensions (mm)	\varnothing	H	\varnothing_1	h_1	w_1	w_2
Position 1	2309	751	1460	450	270	209
Position 2	2235	751	1460	524	270	157
Position 3	2161	751	1460	599	270	105
Position 4	2014	751	1460	751	270	1

See last page for the different bench heights.

BOX 1: TABLETOP



BOX 3: BENCH SUPPORT + MOUNTING KIT

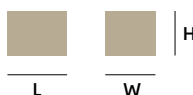

BOX 2: 2 BENCHES



BOX 4: LEGS



Box dimensions (mm)		L	W	H	Qty (#)	Volume (m ³)	Gross weight (kg)	Net weight (kg)	Packaging weight (kg)
Gargantua	Box 1	1540	1540	100	1	0,24	55,84	49,68	6,16
	Box 2	1437	515	100	2	0,14	67,92	64,41	3,51
	Box 3	315	265	235	1	0,05	16,41	16,21	0,20
	Box 4	1300	500	240	1	0,16	34,96	34,40	0,56
	total:				0,59		170,19	159,98	10,23

extremis®

Backrest

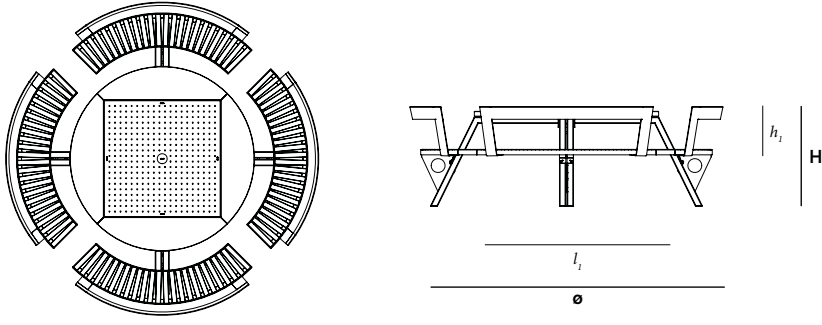

Dimensions (mm)	ø	H	hi	l1
Position 1	2480	787	388	1373
Position 2	2406	861	388	1373
Position 3	2332	942	388	1373

BOX 5: 2 BACKRESTS



Box dimensions (mm)	L	W	H	Qty (#)	Volume (m ³)	Gross weight (kg)	Net weight (kg)	Packaging weight (kg)	
Backrest	Box 5	1415	465	440	1	0,29	25,52	21,02	4,50

Cushions

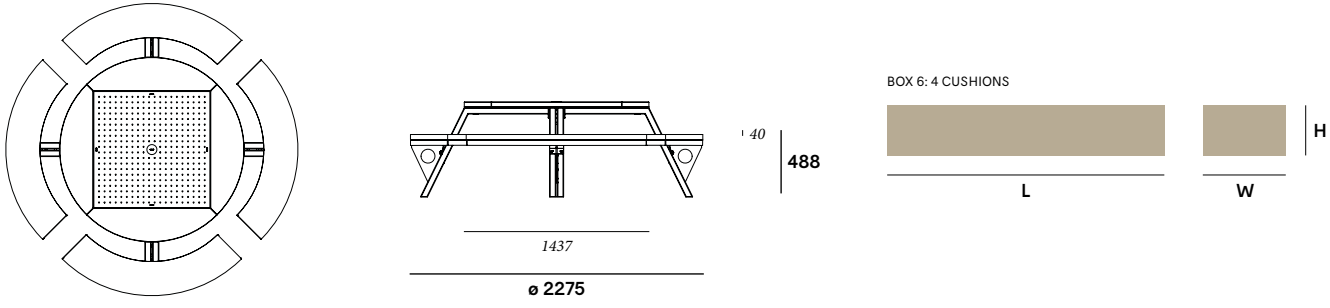

BOX 6: 4 CUSHIONS

Box dimensions (mm)	L	W	H	Qty (#)	Volume (m ³)	Gross weight (kg)	Net weight (kg)	Packaging weight (kg)	
Cushions	Box 6	1415	465	190	1	0,13	5,39	2,38	3,01

Floor fastening



BOX 7: FLOOR FASTENING

Box dimensions (mm)	L	W	H	Qty (#)	Volume (m ³)	Gross weight (kg)	Net weight (kg)	Packaging weight (kg)	
Floor fastening	Box 7	200	140	140	1	0,01	1,42	1,35	0,07

Materials & colours



Materials	Key facts	Thickness	Layer thickness	Density	In/ outdoor	Water	UV colour fastness	Flame retarding
		mm	micron					
Iroko tabletop & benches	<ul style="list-style-type: none"> • Durability CLASS 1 • Feels comfortable in all weather conditions • Advisable to oil the wood 	20 benches 40 tabletop	n.a.	600 à 700 kg/m ³	Outdoor & indoor	n.a.	Untreated wood turns grey after a while	/
Stainless steel tabletop centreplate AISI 316	<ul style="list-style-type: none"> • High rust resistance • Periodical maintenance required 	2	n.a.	8,00 10 ³ kg/m ³	Outdoor & indoor	n.a.	Very good	NEN- EN13501- 1 A1 *
Hot dip galvanised steel frame, legs and backrests	<ul style="list-style-type: none"> • Most durable method for pro- tecting metal from rusting • Protective layer • Very long life span • 100% recyclable • Cradle to Cradle Certified™ 	2 - 10	50 - 100	7,50 10 ³ kg/m ³	Outdoor & indoor	n.a.	Very good, gal- vanisation will however become less shiny when used outdoors	NEN- EN13501- 1 A1 *
Sunbrella cushions	<ul style="list-style-type: none"> • 100% Sunbrella Acrylic • Best outdoor fabric available for making cushions • Dirt repellent • Not waterproof, store inside! • Machine washable at max. 30°C. Ironing restores the protective layer 	0,50	n.a.	260 g/m ²	Outdoor & indoor	The fabric has a water column of 350 mm (EN 20811)	7/8 (ISO 105- B02)	/

* NEN-EN13501-1 A1

Class A1 products will not contribute to fire in any stage, including fully developed fire. For this reason, they are assumed to be capable of satisfying all requirements of all lower classes as well.

Applications

Residential: the perfect family picnic table for your terrace, patio or courtyard

Project: hotel and catering industry, company terraces, public spaces, squares, event venues, schools, ...

Instructions

Every leg of the table has four support brackets, one for every height of the bench. To change the height of a bench, grab the bench with both hands on the frame (see picture) and subsequently hook it in at the desired height between the two tubes of the legs.

Make sure the bench is securely fixed and is hanging in a horizontal position.



Position 1: for adults



Position 2: for tall children and small adults



Position 3: for small children



Position 4: for tabletop extension



Position 4, adjustment & fastening of the benches (see manual).

1. Loosen the bolts underneath each bench.
2. Align with the table and check if the gap is equally spaced over the entire length of the bench.
3. Tighten the bolts carefully.

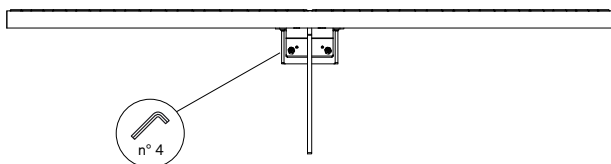

F.a.q.

Q: Do you need to oil the wood?

A: Just like other types of wood, Iroko will gradually become rougher and start to turn grey as a consequence of exposure to the sun and rain. Small cracks and crevices can also appear as part of this process. We strongly advise everyone to treat the furniture with our Wood Protector. This 100% natural oil controls the moisture level within the wood, which makes the planks stay stable for longer, and the layer of oil also helps to prevent spilled liquids from being absorbed, so that stains tend to stay superficial. It is best to repeat this treatment at regular intervals.

Q: All benches on the highest level = a table for 12 people?

A: Yes, but this position is not meant to be used all the time.

Floor fastening

Gargantua comes with an optional floor anchoring set: four jugged steel plates to be fixed with bolts. Use suitable bolts or screws from a DIY store depending on the material your terrace is made of, and combine them with this four-part floor-fastening set.



Good to know

- The slight movement you feel when sitting down is the result of the space we need to hook or unhook the benches. If this would be too narrow, moving the benches would no longer be possible.
- The hole in the tabletop to place a parasol in is Ø65 mm
- Gargantua combines perfectly with Inumbra ø35, ø40 & Inumbria ø38. For both combinations, a connection piece is required.



- With all the benches at top level 12 chairs can be put around the table. However, the benches do not form one closed surface with the round tabletop. This position is meant for exceptional situations, like family reunions and parties. Level deviations up to 1 cm may appear. Minimise with the adjusting bolts (see instructions position 4).



Maintenance

Find maintenance instructions at the downloads section of extremis.com for:

GALVANISED PARTS



- How to repair a damaged zinc layer

WOOD

- Cleaning regularly with mild detergent
- Thorough cleaning with Extremis Wood Cleaner
- Oiling the wood with Extremis Wood Protector. We recommend oiling the wood once or twice a year. 1x before the summer and 1x after the summer as protection for the winter.
- In order to smoothen the surface again after a thorough cleaning, lightly sand your wood with 80 grit sanding paper or a sanding pad.

USAGE ADVISE

- For Extremis Wood Protector:

 1L	7 to 10 wood care treatments
 0.5L	3 to 5 wood care treatments
	100 - 150 ml for one Gargantua
