

1 | 17-0080507

BASSLINE TABLES

New chapter. Different song.
Today's office has its own bassline.



2 | 17-0080506



4 | 17-0081209



5 | 17-0081210

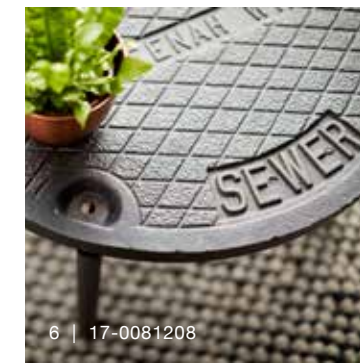

6 | 17-0081208

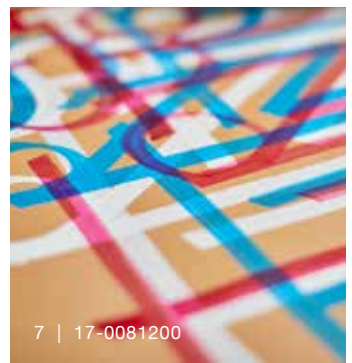

7 | 17-0081200

Bassline is made for more than magazines and coffee.
It kicks down old doors and celebrates all a table can be.
Because, like the bass of a song sets the mood,
its possibilities are limitless.

Bassline is personal and infinitely creative.
It raises the bar and sets the tone with hard lines and smooth edges.
It adds elegance with curves and thoughtful design.

So find another place for your coffee.
There's a new table in town.
And this one's built to inspire.



3 | 17-0080508



8 | 17-0080509

STATEMENT OF LINE AND FINISHES

Bassline brings a unique look to any setting. Choose from standard offerings or make a statement by adding your own custom top for a truly one-of-a-kind piece.

Standard tops

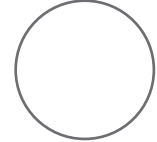
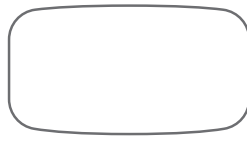
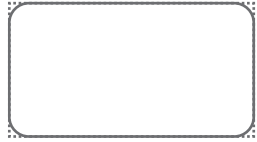
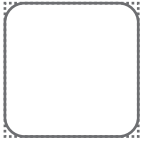

Square

TSBLNTRS*
TSBLNBRSM†

28.75"W x 28.75"L
18.875"W x 18.875"L

Rectangle

TSBLNTRS*
TSBLNBRSM†

28.75"W x 60"L
24"W x 54"L
20"W x 36"L

Oval

TSBLNTOV
TSBLNBOVM†

28.75"W x 60"L
24"W x 54"L
20"W x 36"L

Racetrack

TSBLNTRT
TSBLNBRTM†

28.75"W x 60"L
24"W x 54"L
20"W x 36"L

Round

TSBLNTRD
TSBLNBRDM†

39" diameter
25" diameter

* Standard square and rectangle tops are available with rounded or squared corners

Finishes: Bassline tables are available in all Steelcase High Pressure Laminates (HPL), Low Pressure Laminates (LPL), Open Line Laminates (OLL) and assorted Veneers.

Height: Bassline tables with standard tops are 13" tall. Legs are available in all Steelcase Standard Paints, Accent Paints, Lux Coatings and PerfectMatch.

ADD YOUR OWN CUSTOM TOP

Creating a one-of-a-kind table has never been easier. Bassline's innovative platform supports up to 800 pounds so you can add anything from a reclaimed barn door to grandpa's workbench top. Representing you and highlighting your personality is what Bassline is all about.

Simply find a top you love and use the provided hook and loop adhesive to affix your top to the Bassline platform.

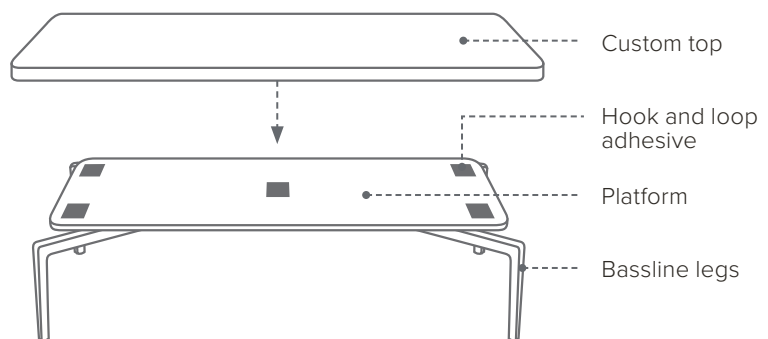

† Use these style numbers (above) to create your own custom Bassline table

Bassline finishes shown: **1** | Bassline Round table (TSBLNTRD) in Gold Teak veneer (3GAX), Legs in Black (835). **2** | Bassline Rectangular platform (TSBLNBRSM) with custom top, Legs in Lux Night Bronze (4B24). **3** | Bassline Round platform (TSBLNBRDM) with custom top, Legs in Lux Matte Brass (4B22). **4** | Bassline Oval platform (TSBLNBOVM) with custom top, Legs in Arctic White Gloss. **5** | Bassline Round platform (TSBLNBRDM) with custom top, Legs in Lux Burnished Bronze (4B23). **6** | Bassline Round platform (TSBLNBRDM) with custom top, Legs in Lux Obsidian (4B20). **7** | Bassline Square platform (TSBLNBRSM) with custom top. **8** | Bassline Square table (TSBLNTRS) with squared corners in Planked Walnut Veneer (3P71), Legs in Carbon Metallic (7245).

