



Pricebook / Specification Guide

January **2018**

5 Day Open Plan specializing in open plan applications and height adjustability

Table of Contents

General

- Orders 6
- Warranties 6
- Shipping 7
- Order Processing 8
- Payments & Deposits 8

- Worksurfaces 10
- Privacy Screens 12
- Modesty & Insert Panels 14

- Electrical — General 16
- Electrical — 3 Circuit/5 Wire 18
- Electrical — 4 Circuit/8 Wire 20
- Electrical — Unique Codes 22

KINEX
height adjustable benching

- Statement of Line 26
- Typical Configurations 28
- Electrical 30
- How to Specify 34

- PRICING:**
- Bases 34
- Crossbeams 34
- Beams 35
- Feet 35
- End Panels 36
- Worksurfaces 36
- Privacy Screens 37
- Accessories 37
- Electrical — Universal 38
- Electrical — Chicago 38
- Electrical — 3 Circuit/5 Wire 39
- Electrical — 4 Circuit/8 Wire 40

ICON benching

- Statement of Line 44
- Typical Configurations 46
- How to Specify 48
- Electrical 50

- PRICING:**
- ICON Frames 54
- Worksurfaces 56
- Privacy Screens 57
- Panel Inserts 57
- Electrical — Universal 58
- Electrical — Chicago 58
- Electrical — 3 Circuit/5 Wire 59
- Electrical — 4 Circuit/8 Wire 60

ILINE power/data beam	Statement of Line	64
	Typical Configurations.	66
	Electrical	68
	PRICING:	
	ILINE Kits	74
	Privacy Screens and Panels	75
	Electrical — Universal	76
	Electrical — Chicago.	76
	Electrical — 3 Circuit/5 Wire	77
	Electrical — 4 Circuit/8 Wire	78

ACTIV sit-to-stand bases	Statement of Line	82
	Specifications: ACTIV-Pro — 2 Stage	84
	Specifications: ACTIV-Pro — 3 Stage	86
	Specifications: ACTIV-Pro3	88
	PRICING:	
	ACTIV sit-to-stand bases.	90
	Worksurfaces — ACTIV-Pro	92
	Worksurfaces — ACTIV-Pro3	93
	Privacy Screens	94
	Accessories	95

Storage	Specifications	98
	Storage	99
	Storage Accessories	100

Ergonomic Accessories	Monitor Arms	103
-----------------------	------------------------	-----

Orders

Orders

Please send P.O.s to orders@amqsolutions.com.

Cancellations

Orders may be cancelled within 48 hours of order placement in writing via email. Orders are not officially cancelled until a confirmation is sent via email from AMQ. Please send cancellation requests to cc@amqsolutions.com.

Returns and Exchanges

We do not accept returns or exchanges on products; sales are final once acknowledgments are sent. If a product is ordered by mistake or other issue arises, contact our Customer Care team at cc@amqsolutions.com.

Change Orders

Orders may be changed within 48 hours of order placement. The request must be made via email to cc@amqsolutions.com. The change order is subject to approval and is not accepted until an AMQ acknowledgment is sent to the dealer. In the event that a change order is accepted, change fees may apply. Lead time starts on the day of approval of changes.

Pricing/Order Entry Errors

Claims for pricing or order entry errors must be made no later than 48 hours from receipt of an AMQ acknowledgment. After the 48 hour grace period, customers will be responsible for orders as they are acknowledged.

Please send emails to cc@amqsolutions.com along with your order acknowledgment number, line number with error and detail of the error.

Lead Times

All AMQ products ship within 5 business days.*
Lead time begins the day after receipt of a clean P.O.
When your order is shipped, a tracking notification will be emailed to the contact specified on your purchase order.

Order Fulfillment

We make every attempt to ship all of our orders complete. In the event of a partial or split shipment, you will be notified and an estimated date will be provided for the backordered items. We cannot guarantee which warehouse the product will ship from.

Customer has 10 calendar days after delivery at the specified location to file a claim with AMQ for missing items or AMQ errors not obvious at the time of delivery. If AMQ determines missing items or error was made by AMQ, AMQ's sole obligation is to replace the missing items or correct error and ship at AMQ's expense. AMQ does not cover labor or trip charges. Customer waives right to file a claim if filed after 10 calendar days of receipt of shipment.

*Two products (noted on following pages) require a 10 day lead time. Orders including these products will ship in 10 days.

Warranties

All AMQ products have a 10-year warranty, with 5 years on ACTIV and KINEX electrical parts. AMQ is not responsible for labor charges on any repairs needed.

AMQ's obligation under this warranty is limited to replacing any product or part that it determines to be defective after inspection by its authorized representative, following receipt of written notice of the defect from the purchaser within the warranty period. This warranty shall apply to the original purchaser only, is non-transferable, and is not applicable outside the United States, Canada, and Mexico.

This warranty is based on normal installation and use of the product in an 8-hour shift. This warranty does not apply to:

- Damage in shipment caused by a carrier
- Defects caused by improper installation
- Products subject to improper use and conditions
- Customer modifications to the product
- Any product that has been modified, altered, tampered with or repaired by any person other than an authorized representative of AMQ
- Normal wear and tear

Labor charges and/or damage incurred in the installation, repair, or replacement of any products are excluded; AMQ will replace the product if the claim is approved.

Product Design

The right is reserved by AMQ to make changes in design and material, as well as discontinuance of parts and units when such action is deemed to be an improvement in design, function and/or construction.

Warranty Claims

Please email claims to cc@amqsolutions.com.

Shipping

Will Call

AMQ provides Will Call pickup from our Santa Clara, CA and Atlanta, GA warehouses. Please specify this method upon placement of order.

Note we have mandatory Will Call zones in our warehouse regions. Zones are noted on our Discount sheet.

We will maintain availability of your order up to 48 hours beyond the scheduled pick up date. Failure to pick up your order after 48 hours will result in storage fees of \$100 per working day per pallet. Failure to pick up your order after 15 working days of scheduled will call, will result in your order being returned to inventory and subject to restocking fees in addition to accumulated storage fees.

Freight Terms

All pricing includes freight, except for orders less than \$1500 Net, which incur surcharges of \$100.

Orders that contain Seating and Accessories ONLY do not incur a shipping surcharge.

Products are shipped LTL (Less than Truck Load) with freight costs and handling fees prepaid. If a split shipment is requested by the customer, they are responsible for additional freight charges.

AMQ reserves the right to pass on charges for other than the normal dock to dock delivery, such as a residential delivery, lift gate service, inside delivery, etc., unless alternative arrangements have been agreed to in writing with AMQ prior to shipment. Any special freight requirements need to be requested prior to order placement and are subject to approval by AMQ. Please contact our Customer Care team for details and quotes.

Canada/Hawaii/Alaska

For shipments to Canada, AMQ pricing includes transportation (dock to dock) but not for customs clearance and import duty/taxes.

For shipments to Hawaii/Alaska, AMQ pricing does not include freight. Our pricing covers the continental United States only.

Delivery Date Guarantee Option

Delivery date and time are at the discretion of the carrier within reasonable transit time unless special arrangements have been agreed to in writing between the customer and AMQ prior to shipment. There is an additional charge to guarantee delivery on a specific day. These charges will be quoted at customer request.

Redelivery and Re-consignment of Freight

The customer will be charged for redelivery or re-consignment of all orders (regardless of shipping terms agreed to), if redelivery or re-consignment was caused by a customer change after the goods have left AMQ's dock.

Shipment Damage Claims

All shipments must be carefully inspected by customer before acceptance, and the customer must record any damage or shortages noted at time of delivery on the Bill of Lading, and provide this information to AMQ immediately along with photos of any damage. AMQ will arrange inspection by the carrier. If customer believes it has uncovered further damage after delivery they must take photos of the damage and immediately request inspection by the delivering carrier. Damaged freight must be kept at point of delivery in original packaging for inspection by carrier until further notice by AMQ. If carrier is designated by AMQ, AMQ will seek recourse on behalf of the Customer. Freight Claims must be filed within 10 days of delivery date.

AMQ warrants to the original purchaser that the products it manufactures are free from defects in design, material and workmanship. Subject to the limitations below, AMQ warrants each product in this catalog to be free from material defects in materials and workmanship.

Submission of Claims

Please submit all order fulfillment, shipping, and warranty claims to cc@amqsolutions.com.

Order Processing

Please send purchase orders to orders@amqsolutions.com.

- Lead time of 5 business days starts from the next day after receipt of clean P.O.
- P.O.'s with missing information/finishes or incorrect pricing will be placed on order processing hold and the lead time will not start until the revised P.O. is sent to Customer Care (orders@amqsolutions.com).
- Please provide .sif file and AMQ quote number along with P.O., if applicable.
- Orders will be acknowledged within 24-48 hours with an AMQ acknowledgment number.
- Claims for quote errors, pricing, order entry errors and/or incorrect finishes must be made within 48 hours of receipt of acknowledgment. After 48 hours, AMQ will not be responsible for errors.

Please be sure to check order acknowledgments to confirm accuracy of products, fabrics and finishes against your purchase order.

Payments & Deposits

Terms of payment will be established based on the credit rating and credit information provided by and for specific customers. Orders are invoiced at the time of shipment or will call date. Standard payment terms are net 30 days.

	Orders Under 40,000 Net	Orders Over 40,000 Net
Deposit	No Deposit Required*	50% Deposit Due Upon Order
Balance Due	Net 30	Net 30

*First order with new dealership requires 50% deposit.

Worksurfaces

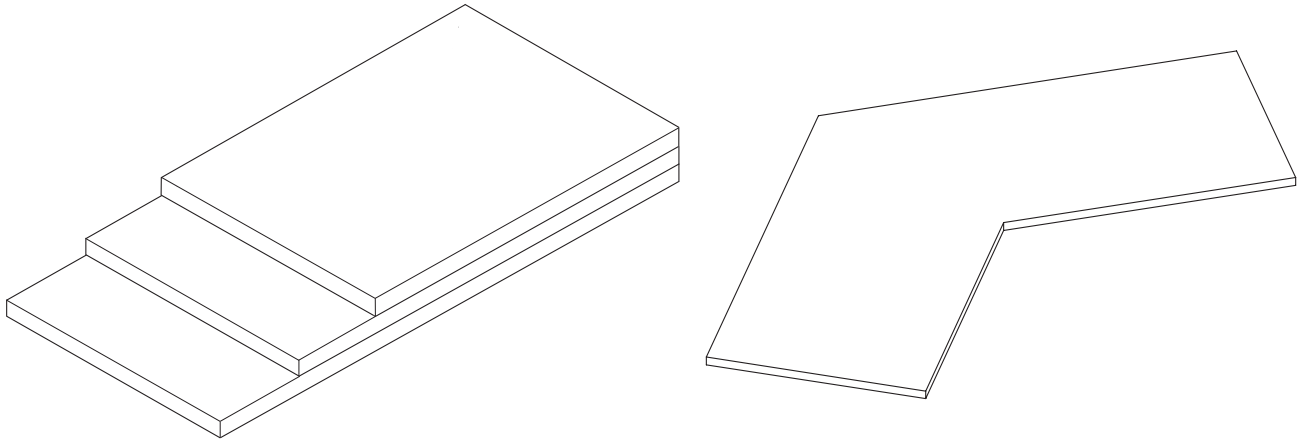

AMQ worksurfaces are low pressure laminate (LPL).
Available in linear, 90° and 120° degree shapes in four colors: White, Maple, Walnut and Teak.

SPECS

LPL (low pressure laminate)

1 inch/25mm thick

3mm PVC on four sides

Linear, 120, extended corner

*For customized worksurfaces, please call AMQ sales support at (888) 234-5098.

Our linear worksurfaces come in 48", 60" and 72" widths at 24" or 30" depth.



72" width

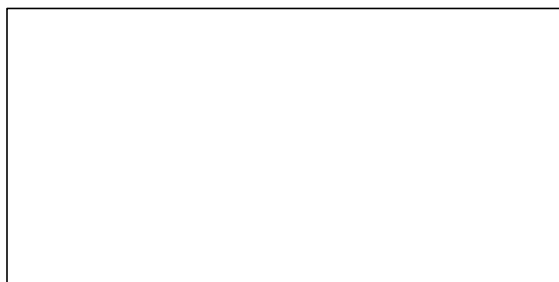

60" width

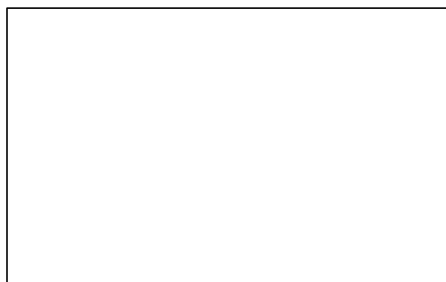

48" width

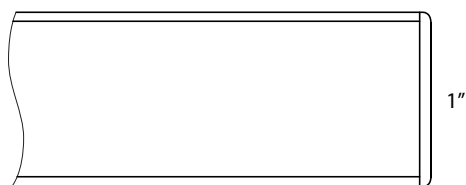

Worksurfaces are 1" thick with 3mm PVC on 4 sides.

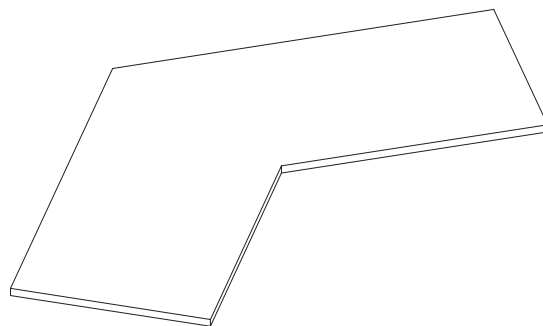

120° worksurfaces also available for ACTIV-Pro3 height adjustable base.

Privacy Screens

We offer 3 types of privacy screens for your open plan environments.

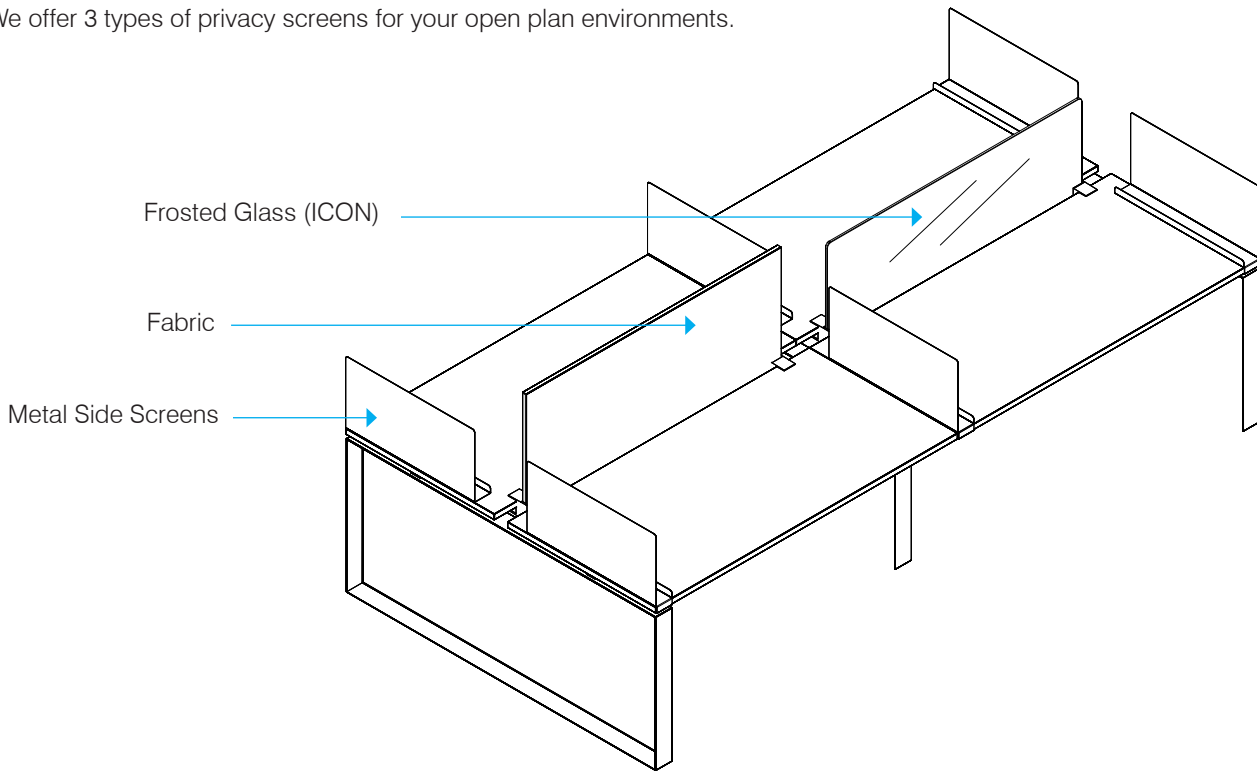

Fabric screens clip onto worksurfaces and are height adjustable when used with ICON and ACTIV bases

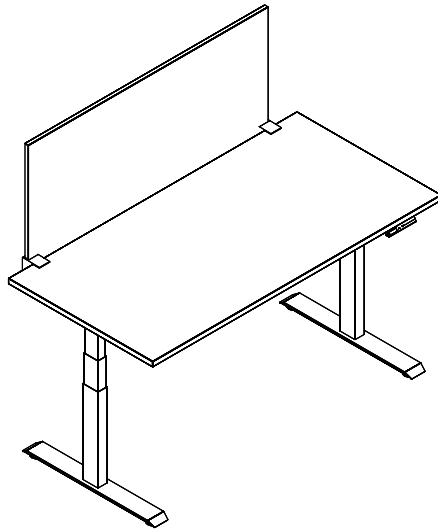

Metal side screens slide onto 24" and 30" deep worksurfaces

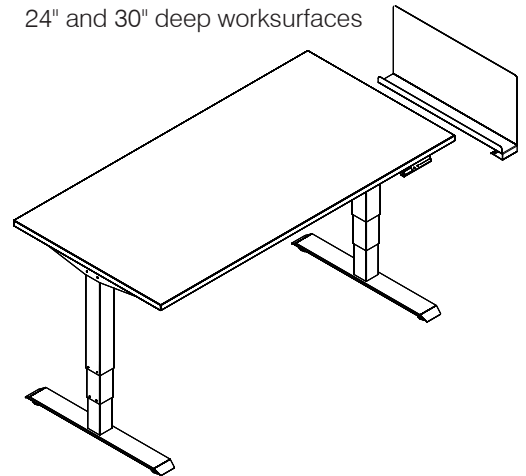

Frosted glass allows for more light and design possibilities (available for 60" and 72" ICON only)

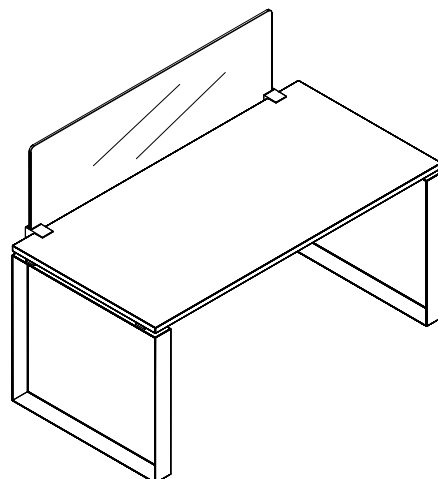

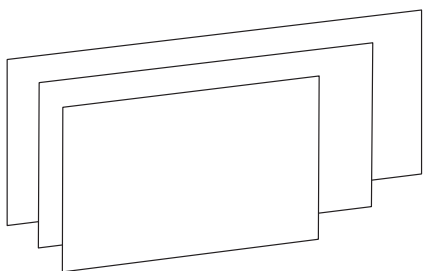

Fabric Screens

AMQ fabric screens are .75" thick with aluminum and plastic frame and high density felt interiors. Upholstered in polyester fabric (ASTM E-84, Class A or 1).

Height adjustable when used with ICON and ACTIV bases.

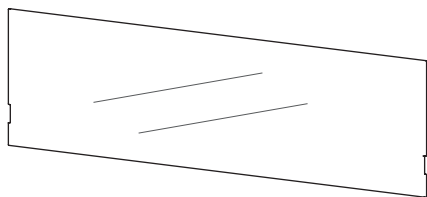

Frosted Glass Screens (60" and 72" ICON only)

AMQ frosted glass screens are .3"/8mm thick and sold in 2-packs for our ICON product line.

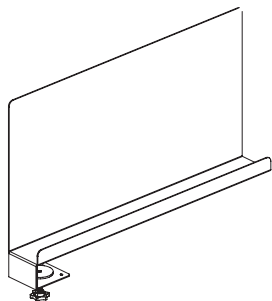

Side Screens

Our metal side screens are 22.9"D x 3.14"W x 12.2"H, 1/16" thick, with 3" overhang that slides onto worksurfaces up to 1.5" thick. Rubber mat inset with knob tightener. No clips required. Fits 24" and 30" deep worksurfaces. KINEX and ACTIV only.

Screen Clips

AMQ screen clips vary by product line and configuration. All sold in pairs (separately from screens). ICON/ACTIV base clips work with worksurfaces between .7"-1.5" (18mm and 40mm) thickness.

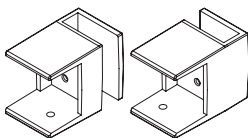

ICON and KINEX single runs, plus ACTIV bases

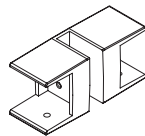

ICON double run



ILINE



KINEX double run

Modesty & Insert Panels

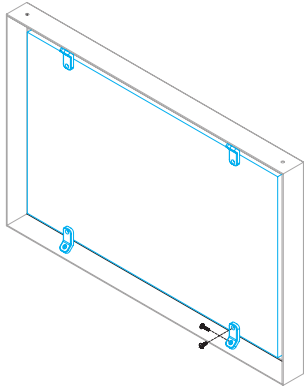

ICON Modesty Panel Leg Insert (ICON)

Laminate; .6" thick
 Available in White
 Available for SR/DR 24"/30" O-Legs

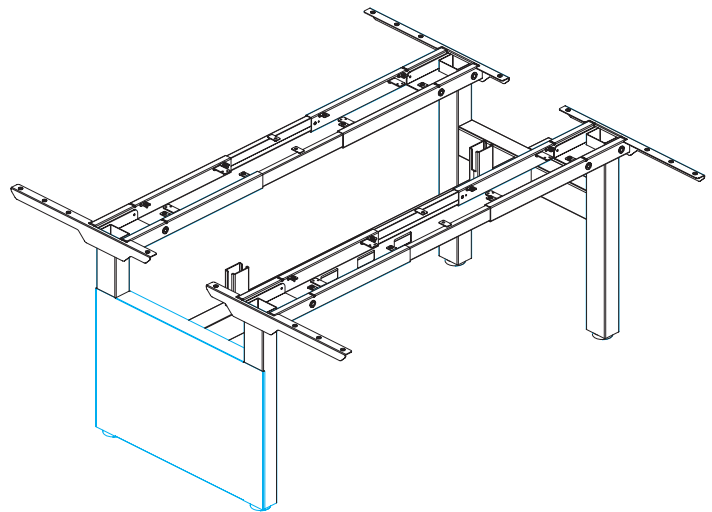

KINEX End Panel

End Panel for 24" and 30" DR applications.
 Available in Platinum and White.

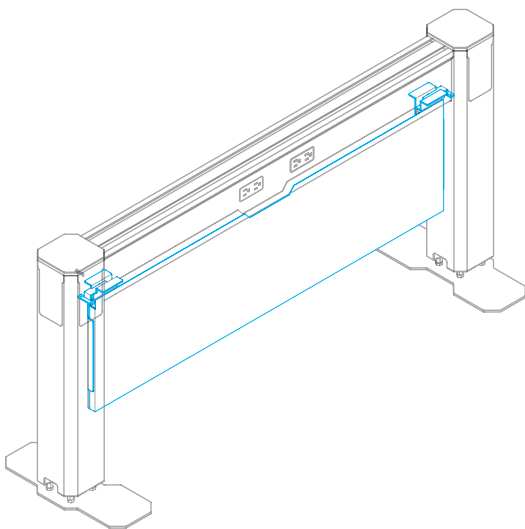

ILINE Modesty Panel

2-piece metal panel, with clips
 Available in Platinum and White
 48", 60" and 72" lengths

Electrical

We use the USA-based company Byrne Electrical for all our power and data.

The Byrne 8-Trac System and Phase 3 are UL recognized as an Office Furnishing Accessory (UL 1286), and are UL Listed as a Manufactured Wiring System (UL 183) in full compliance with electrical specifications found in the National Electrical Code (NEC). It also complies with municipal standards such as New York, Los Angeles and San Francisco.

To learn more about Byrne, visit their website at www.byrne-electrical.com



Electrical — 3 Circuit/5 Wire

The Byrne Phase 3 System is similar to 8-trac system except is a double sided 3-Circuit/5-Wire system. It Includes flexible mesh conduit jumpers (UL1286 only). Also offers multiple circuit configurations selected by the receptacles.

SPECS

UL183 Listed and UL 1286 Recognized in full compliance with National Electric Code (NEC)

3-Phase System

Modular Receptacles

Flexible mesh conduit jumpers (UL1286 only)

Multiple Circuit configurations selected by receptacles

Double-sided system

Wire Diagram for 3 Keying

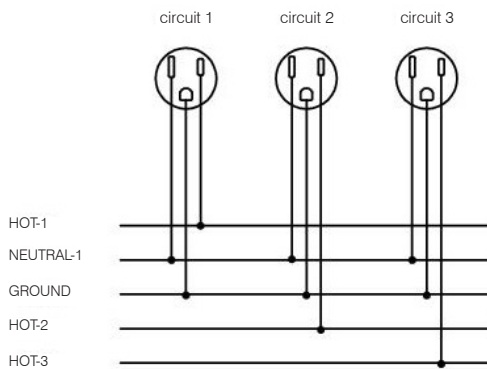

Electrical — 4 Circuit/8 Wire

BYRNE 8-TRAC SYSTEM

The Byrne 8-Trac System is rated for 15 amps allowing the use of 4 circuits with 4 line conductors, 2 neutrals and 2 grounds. Under NEC requirements, up to 13 duplex receptacles maybe used per circuit, with a total of 52 available receptacles if all circuits are used, per single power entry. The line conductors are 12 AWG, and share 12 AWG ground and a 10 AWG neutral. The fourth circuit is isolated and dedicated, and is serviced by its own line conductor, neutral and isolated ground. The Byrne System can be wired in both single and 3-phase configurations, 240/120V, 208/120V respectively. Additionally, a 3 hot, 3 general, 2 ground (3-3-2) wiring system is available. The System accommodates panel applications of 2" to 3½" thick harnesses available from 12" to 1800" in length. Assemblies are 100% electrically tested to ensure the highest quality and reliability.

3+1

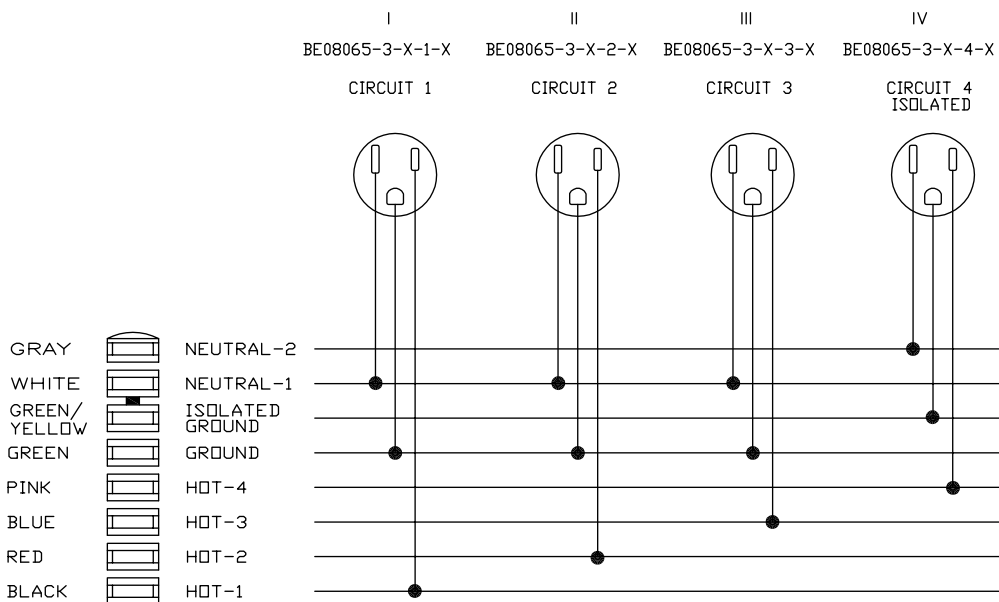

Four-circuit, 3 + 1 Receptacle Option

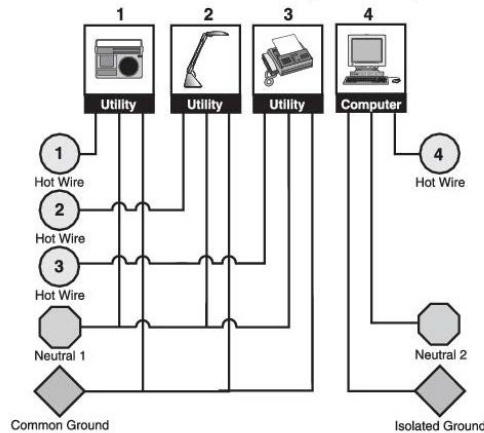

2+2 special order

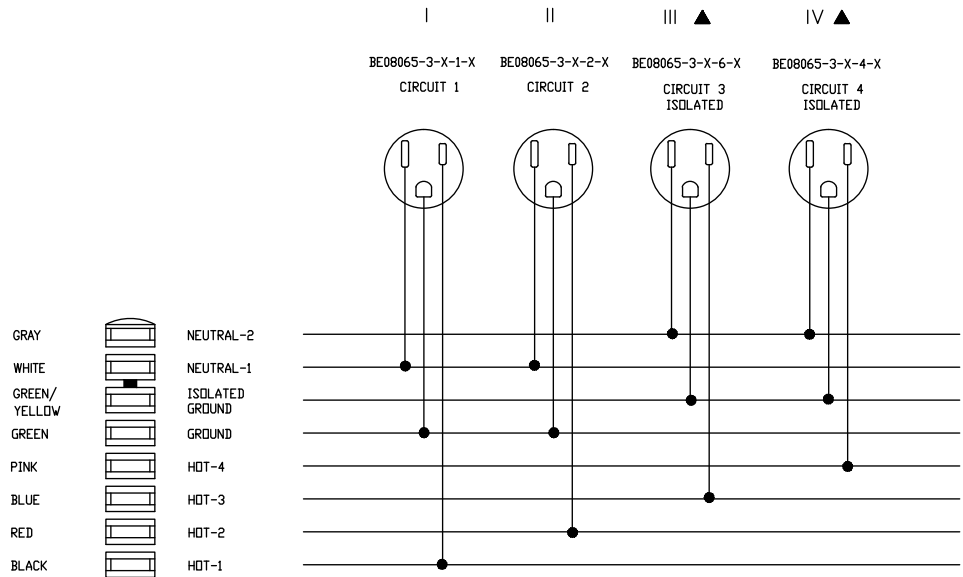

Four-circuit, 2 + 2 Receptacle Option

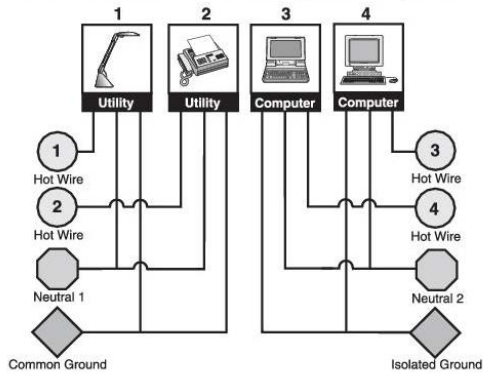

Unique Electrical Codes

The primary electrical code used in the United States is the National Electrical Code (NEC) (NFPA70). While most states and cities use the NEC as is, some have created their own electrical code using the NEC as the basis for the requirements. There are 3 cities that have unique requirements that directly affect office furnishings installations: New York, Chicago, and San Francisco. These unique requirements are detailed below.

Chicago

Chicago has their own electrical code based on the NEC.

Chicago does not allow the use of any modular systems. All electrical must be hardwired by a licensed electrician. The specific wording of the 2009 Chicago Electrical Code is as follows:

18-27-605.2. General. Wiring in and on office partitions shall conform to all applicable chapter provisions. Relocatable wired partitions are not considered portable and, as such, plug and jack connections are not acceptable. All wiring is to be contained in listed and labeled electrical raceways and outlet boxes.

(a) Use. Wired relocatable office partitions shall be installed and used only as provided for by this Article. The biggest ambiguity is what product types will require TR receptacle for code compliance applications. For example, the NEC TR code dwelling requirements specify "appliances" as exempt from the scope of TR receptacles. Relocatable Power Taps are often grouped into this category.

Hardwire accessories can be used in Chicago if they have a metallic enclosure. This includes Mho, Assemble, Axil, Glenbeigh, and Wonderbar product lines. These hardwire units can be provided as a Chicago version which includes 15" of conduit and a 4X4 junction box.

New York City

- Allows the use of Office Furnishings Systems (as permitted by Article 605 of the NEC) but requires that licensed electricians install the electrical components into the furniture.
- Does not allow the use of any non-metallic liquid tight conduit.
- Metallic liquid tight conduit can only be 18" long.
- Flexible metal conduit used on infeeds can only be 6' long.
- Does not allow Manufactured Wiring Systems in furniture.

As of 2009, New York City allows the use of Relocatable Power Taps in office environments.

The New York Electric Code exception of Article 604 for Manufactured Wiring Systems includes Article 604(3) Such wiring may only be used for general lighting circuits above the hung ceiling line.

Until now, this statement was interpreted as lighting circuits must be above the ceiling, while other Manufactured Wiring Systems can be used below the ceiling line.

The new official interpretation requested by BIFMA indicates Manufactured Wiring Systems can only be used for lighting and must be above the ceiling. This applies to Byrne 8-Trac, Byrne 4-Trac and Byrne Phase 3 product lines. This interpretation has not been published on the official NYC Codes site even though more recent interpretations have been. BIFMA continues to work on a resolution to this issue.

San Francisco

San Francisco uses the California Electrical Code which in turn uses the NEC. San Francisco has additional / revised requirements that are called out as an addendum to the code. San Francisco does not allow the use of non-metallic liquid tight conduit and only metallic liquid tight conduit is permitted.

ARTICLE 356 – LIQUIDTIGHT FLEXIBLE NONMETALLIC CONDUIT: TYPE LFNC

- 356.10 Revise the first sentence of this section as follows:
 356.10 Uses Permitted.

LFNC shall be permitted to be used in exposed or concealed locations for systems not exceeding 50 volts for the following purposes:

356.12 Uses Not Permitted

356.12 Revise item 4 of this section as follows:

(4) Where the operating voltage of the contained conductors is in excess of 50 volts, nominal, except as permitted in 600.32(A).

KINEX



height adjustable benching

- Statement of Line 26
- Typical Configurations..... 28
- Electrical 30
- How to Specify 34

- PRICING:
- Bases..... 34
- Crossbeams 34
- Beams 35
- Feet 35
- End Panels 36
- Worksurfaces..... 36
- Privacy Screens..... 37
- Accessories..... 37
- Electrical — Universal 38
- Electrical — Chicago..... 38
- Electrical — 3 Circuit/5 Wire 39
- Electrical — 4 Circuit/8 Wire 40

Statement of Line

BASES

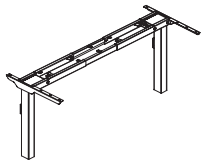

1 Stage/Fixed,
2 Stage/dual motor, and
3 Stage/dual motor

BEAMS

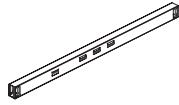

48", 60" and 72"
single and double

CROSSBEAMS

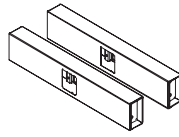

24" and 30"D

FEET

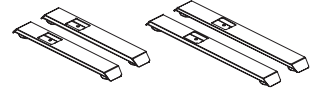

24" and 30" feet
single run applications only

WORKSURFACES

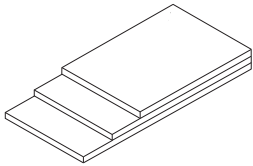

Rectangular
48", 60" and 72" widths

PRIVACY SCREENS & PANELS

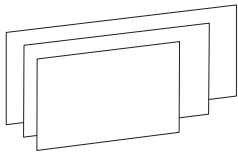

Fabric Screens

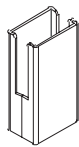

Screen Mounting Clip

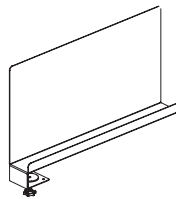

Side Screen

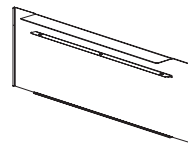

End Panel

ACCESSORIES

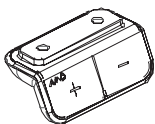

Standard Hand Set

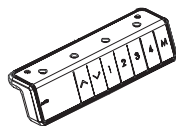

Pre-set Hand Set
upgrade

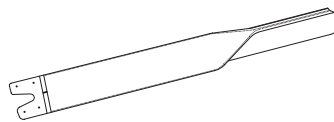

Soft Cable Management

Typical Configurations

A full gallery of typicals is available in our Typicals price book and on our web site under Dealer Tools (ask your AMQ Sales Representative for the password). Each typical includes CAD file, specifications, rendering and .dwg, .sp4 and .sif files.

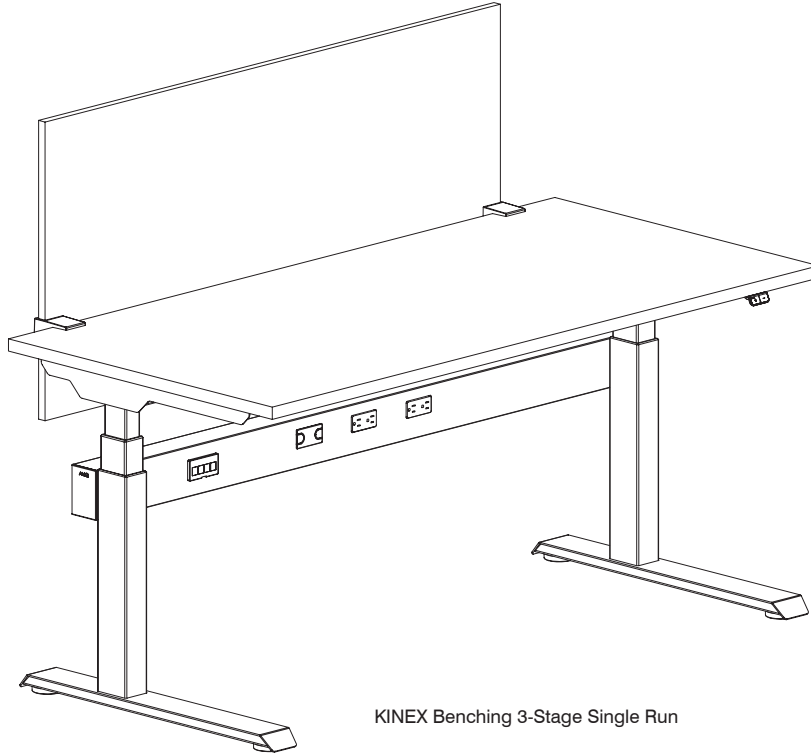

KINEX Benching 3-Stage Single Run

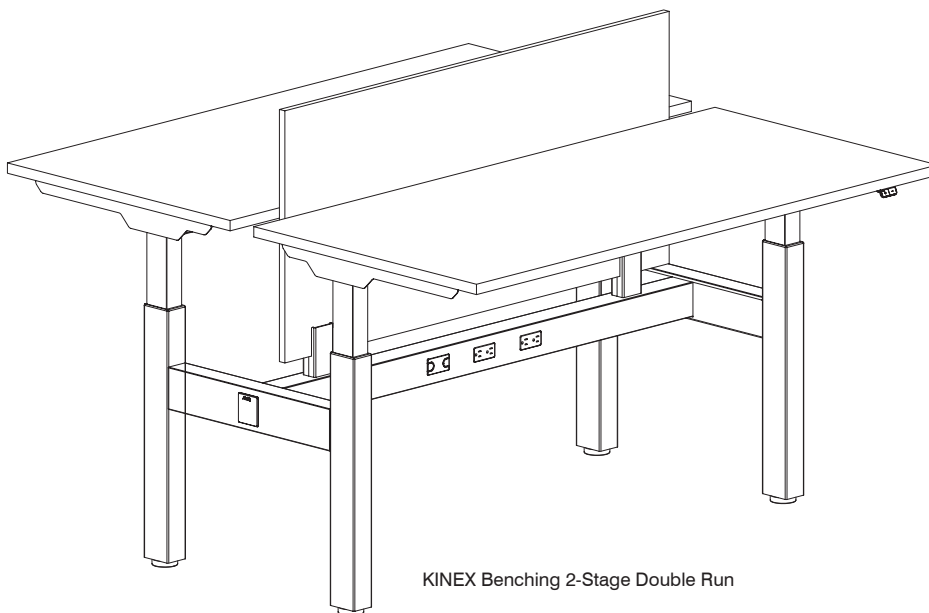

KINEX Benching 2-Stage Double Run

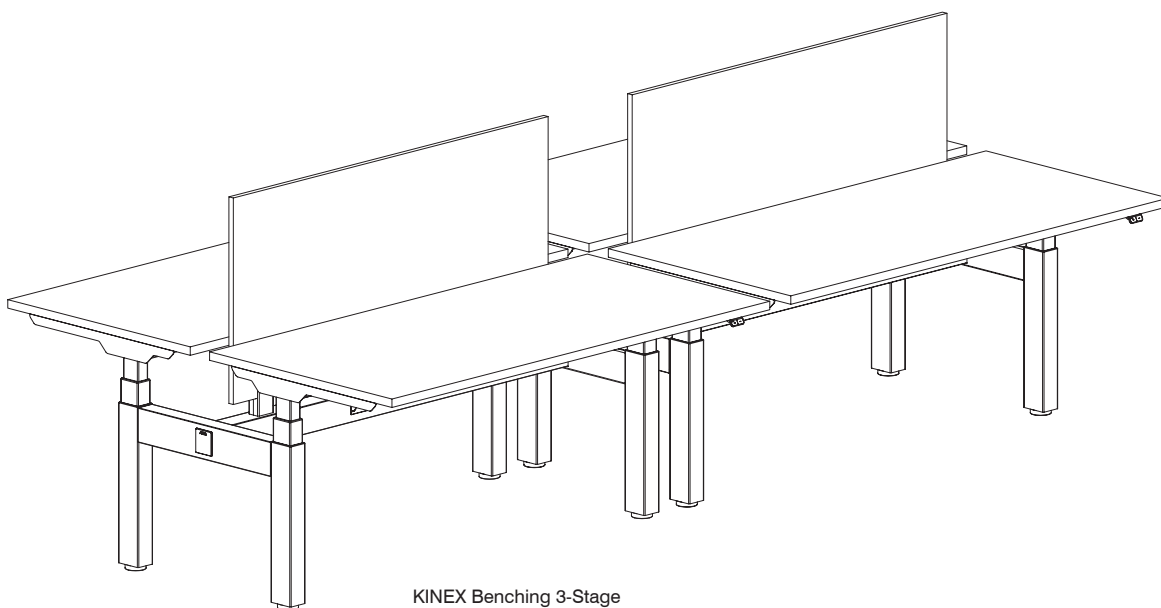

KINEX Benching 3-Stage
Double Run 4 pack

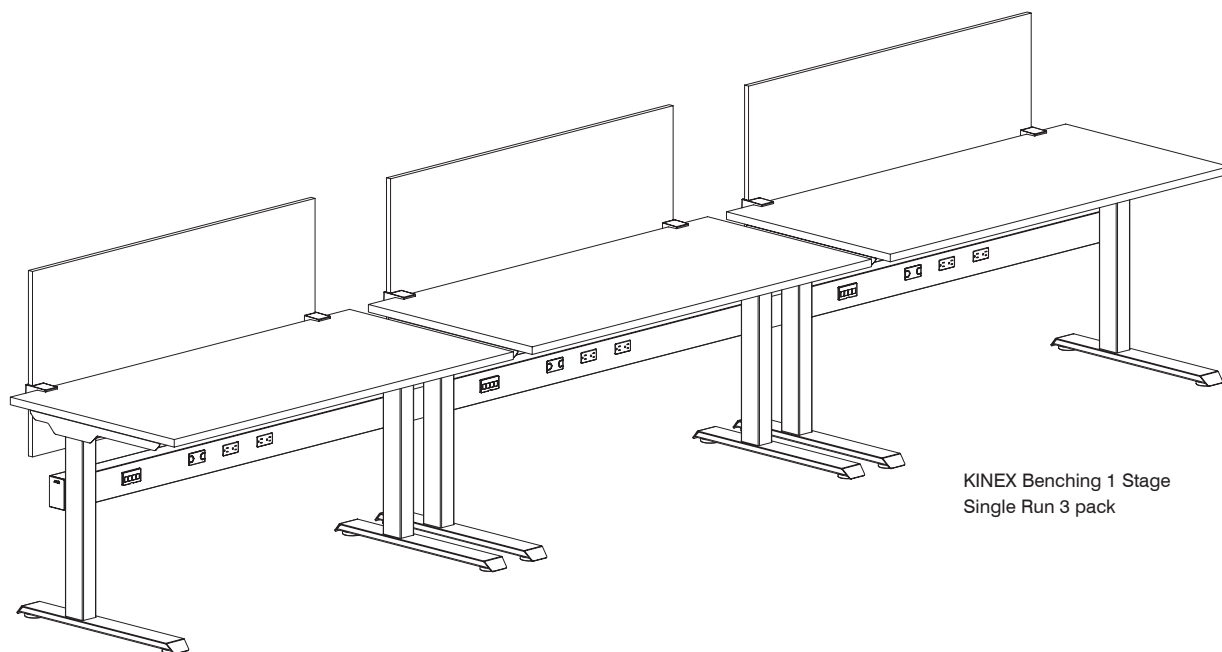

KINEX Benching 1 Stage
Single Run 3 pack

Electrical

KINEX Benching uses ILINE beam technology to distribute power, with either 3 circuit/5 wire or 4 circuit/8 wire electrical.

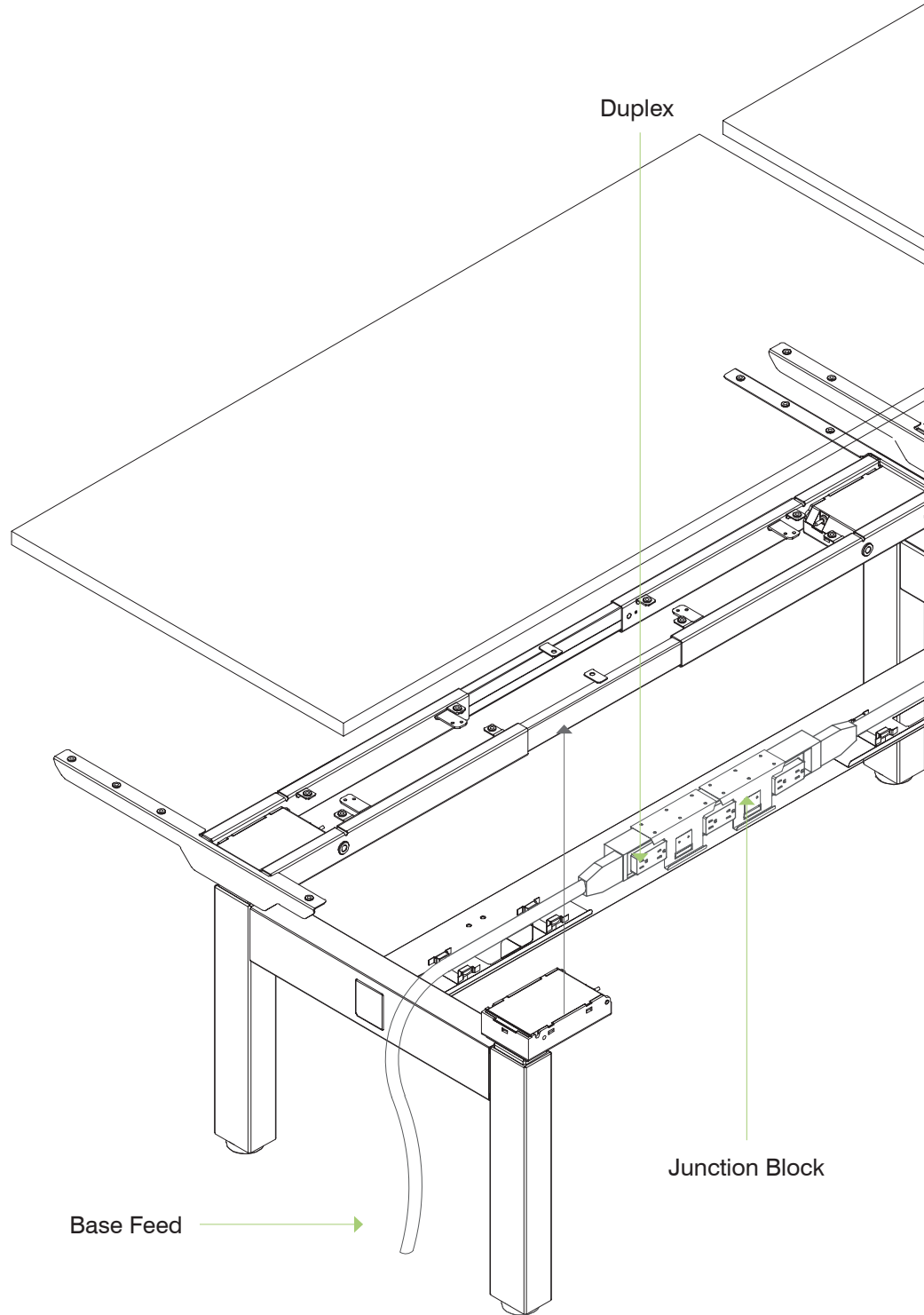

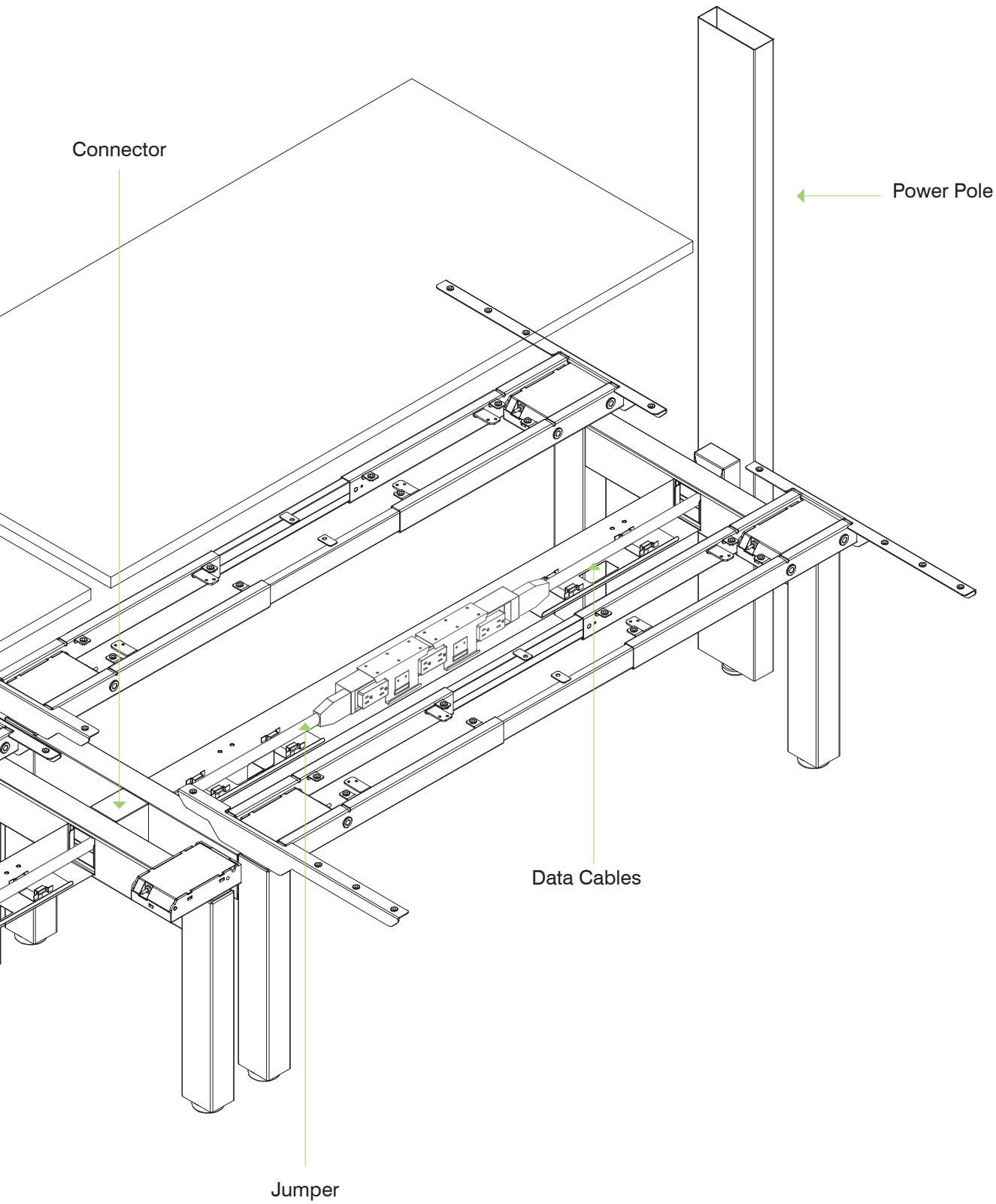

Electrical

4 Circuit/8 Wire Specification

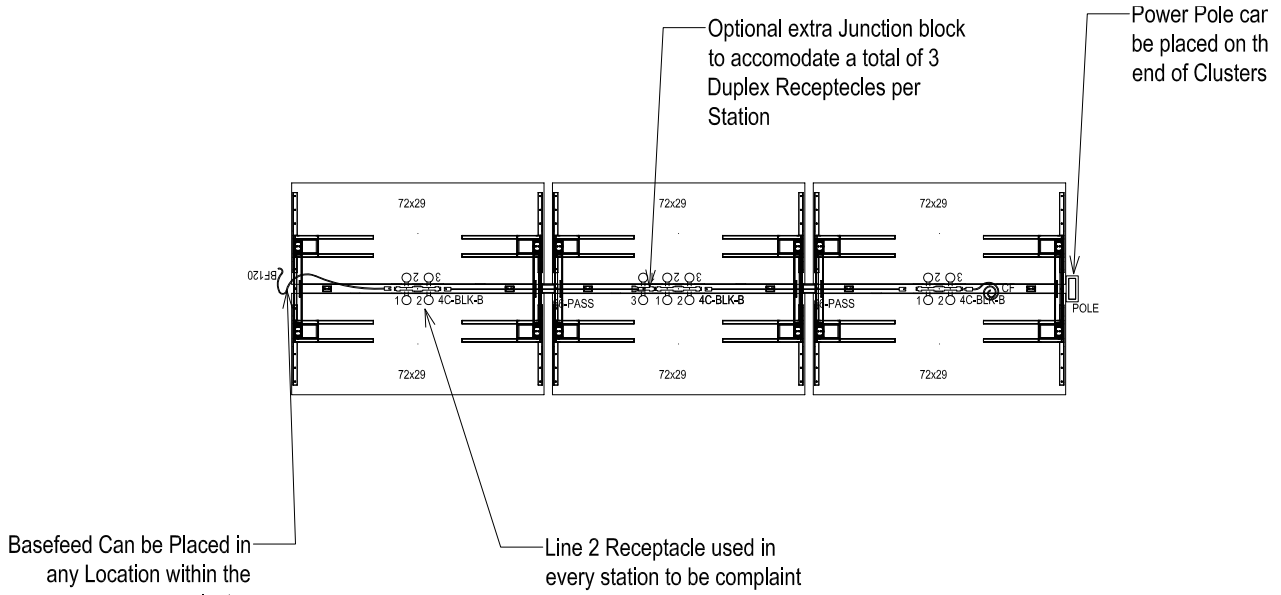

3 Circuit/5 Wire Specification

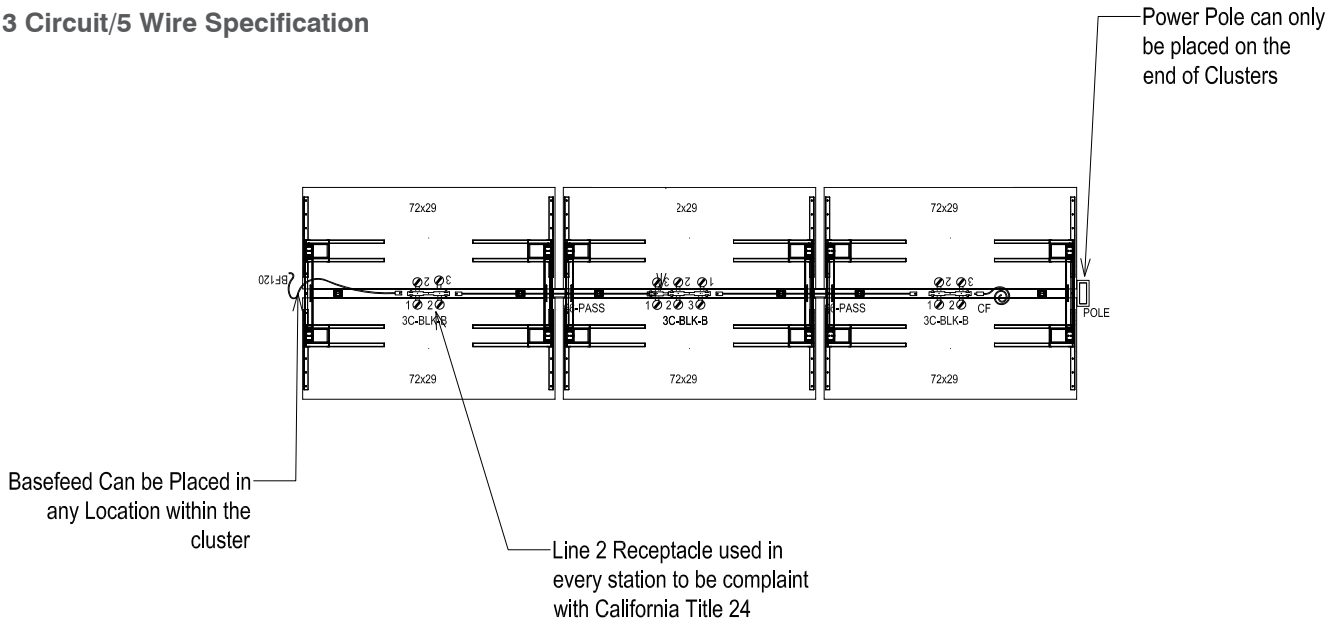

Jumpers — 4 Circuit/8 Wire and 3 Circuit/5 Wire

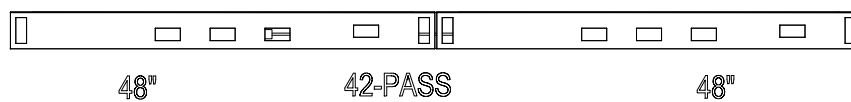
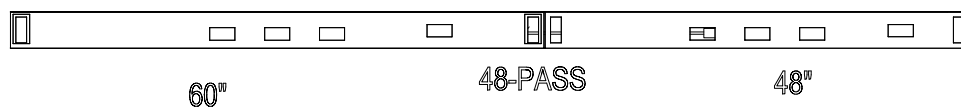
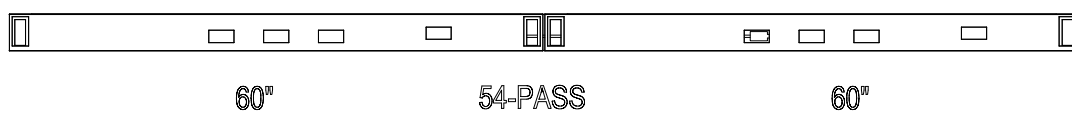
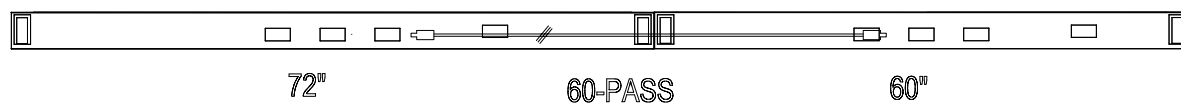
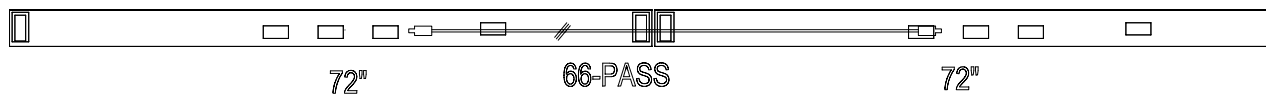

How to Specify

HOW TO ORDER KINEX Single Run (SR):

To order a 2 pack of KINEX 2-Stage Benching in Platinum, specify:

- **KNX-BASE-S2M1.F1** - KINEX 2-Stage Base in Platinum
- **KNX-BM48-SR.F1** - 48" Single Run Beam in Platinum
- **KNX-SR-FT22.F1** - 22" Feet for Single Run, 24" deep worksurfaces

Worksurfaces, electrical components and accessories are specified separately.

HOW TO ORDER KINEX Double Run (DR):

To order a 2 pack of KINEX 3-Stage Benching in White, specify:

- **KNX-BASE-S3M2.F2** - KINEX 3-Stage Base in White
- **KNX-BM48-DR.F2** - 48" Double Run Beam in White
- **KNX-CB24.F2** - 48" Double Run Cross Beam Kit in White

Worksurfaces, electrical components and accessories are specified separately.

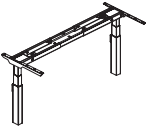

Bases

		SKU	DESCRIPTION	LIST
	KINEX Base – Fixed	KNX-BASE-S1.F1 (Platinum) KNX-BASE-S1.F2 (White)	KINEX Benching Fixed Column leg. Includes the width adjustable stretcher bars, Set of Cantilevers Finish: Platinum	\$875
	KINEX Base, 2 Stage, Double Motor	KNX-BASE-S2M2.F1 (Platinum) KNX-BASE-S2M2.F2 (White)	KINEX Benching 2-Stage Column, Two Motors. Includes width adjustable stretcher bars, Set of Cantilevers & 2 Button Handset. Height Range: 27"-46.7"	\$2,000
	KINEX Base, 3 Stage, Double Motor	KNX-BASE-S3M2.F1 (Platinum) KNX-BASE-S3M2.F2 (White)	KINEX Benching 3-Stage Column, Two Motors. Includes width adjustable stretcher bars, Set of Cantilevers & 2 Button Handset. Height Range: 22"-48".	\$2,165

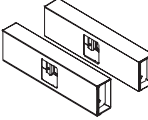
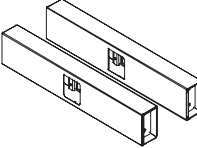
Crossbeams

		SKU	DESCRIPTION	LIST
	KINEX Benching 24" Crossbeam Kit for DR application	KNX-CB24.F1 (Platinum) KNX-CB24.F2 (White)	KINEX Benching 24" set of two Crossbeam for DR application. Includes 2 x DR Plastic Side Covers.	\$265
	KINEX Benching 30" Crossbeam Kit for DR application	KNX-CB30.F1 (Platinum) KNX-CB30.F2 (White)	KINEX Benching 30" set of two Crossbeam for DR application. Includes 2 x DR Plastic Side Covers.	\$285

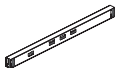
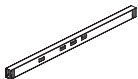
Beams

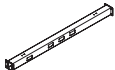
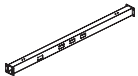
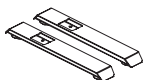
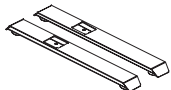
		SKU	DESCRIPTION	LIST
Single Runs				
	KINEX Benching 48" SR Beam	KNX-BM48-SR.F1 (Platinum) KNX-BM48-SR.F2 (White)	KINEX Benching 48" SR Beam, 2x Data Faceplates. Includes 2x Bottom Caps, 6 x Plastic Side Covers, 6x Plastic Front Covers and 1x Bridge connector, 2x Data Faceplates.	\$265
	KINEX Benching 60" SR Beam	KNX-BM60-SR.F1 (Platinum) KNX-BM60-SR.F2 (White)	KINEX Benching 60" SR Beam, 2x Data Faceplates. Includes 2x Bottom Caps, 6 x Plastic Side Covers, 6x Plastic Front Covers and 1x Bridge connector, 2x Data Faceplates.	\$280
	KINEX Benching 72" SR Beam	KNX-BM72-SR.F1 (Platinum) KNX-BM72-SR.F2 (White)	KINEX Benching 72" SR Beam, 2x Data Faceplates. Includes 2x Bottom Caps, 6 x Plastic Side Covers, 6x Plastic Front Covers and 1x Bridge connector, 2x Data Faceplates.	\$300
Double Runs				
	KINEX Benching 48" DR Beam	(Platinum) KNX-BM48-DR.F2 (White)	KINEX Benching 48" DR Beam, 2x Data Faceplates. Includes 2x Bottom Caps, 4x Plastic Side Covers and 1x bridge Connector, 2x Data Faceplates.	\$260
	KINEX Benching 60" DR Beam	KNX-BM60-DR.F1 (Platinum) KNX-BM60-DR.F2 (White)	KINEX Benching 60" DR Beam, 2x Data Faceplates. Includes 2x Bottom Caps, 4x Plastic Side Covers and 1x bridge Connector, 2x Data Faceplates.	\$270
	KINEX Benching 72" DR Beam	KNX-BM72-DR.F1 (Platinum) KNX-BM72-DR.F2 (White)	KINEX Benching 72" DR Beam, 2x Data Faceplates. Includes 2x Bottom Caps, 4x Plastic Side Covers and 1x bridge Connector, 2x Data Faceplates.	\$300
Feet <small>for Single Run applications only</small>				
	KINEX Benching Base Feet for SR application, 24" worksurfaces.	KNX-SR-FT24.F1 (Platinum) KNX-SR-FT24.F2 (White)	KINEX Benching set of two 24" Feet for 24" SR application.	\$130
	KINEX Benching Base Feet for SR application, 30" worksurfaces.	KNX-SR-FT30.F1 (Platinum) KNX-SR-FT30.F2 (White)	KINEX Benching set of two 30" Feet for 30" SR application.	\$140

End Panels

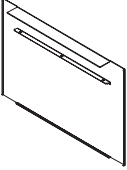
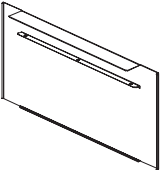
	SKU	DESCRIPTION	LIST
 <p>KINEX 24" DR End Panel</p>	KNX-EP24.F1 (Platinum) KNX-EP24.F2 (White)	KINEX Benching End Panel for 24" DR application.	\$275
 <p>KINEX 30" DR End Panel</p>	KNX-EP30.F1 (Platinum) KNX-EP30.F2 (White)	KINEX Benching End Panel for 30" DR application.	\$300

Worksurfaces

	SKU	DESCRIPTION	LIST
48" x 23" Worksurfaces	AB-S4823-W_._	Worksurface for KINEX Bench 48x23 (48"W x 23"D X 1"H)	\$365
48" x 29" Worksurfaces	AB-S4829-W_._	Worksurface for KINEX Bench 48x29 (48"W x 29"D X 1"H)	\$425
60" x 23" Worksurfaces	AB-S6023-W_._	Worksurface for KINEX Bench 60x23 (60"W x 23"D X 1"H)	\$455
60" x 29" Worksurfaces	AB-S6029-W_._	Worksurface for KINEX Bench 60x29 (60"W x 29"D X 1"H)	\$495
72" x 23" Worksurfaces	AB-S7223-W_._	Worksurface for KINEX Bench 72x23 (72"W x 23"D X 1"H)	\$548
72" x 29" Worksurfaces	AB-S7229-W_._	Worksurface for KINEX Bench 72x29 (72"W x 29"D X 1"H)	\$595

Worksurface Finishes

Specify at the end of product SKU



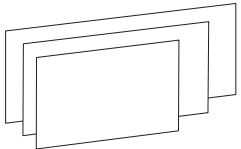

Privacy Screens

	SKU	DESCRIPTION	LIST	
Fabric Screens 	X-S2-F3824.C1 (Aloe Green) X-S2-F3824.C2 (Varsity Blue) X-S2-F3824.C4 (Nickel Grey)	Fabric Screen, 38"W x 24"H Requires set of Screen Mounting Clips (sold separately, below)	\$399	
	X-S2-F5024.C1 (Aloe Green) X-S2-F5024.C2 (Varsity Blue) X-S2-F5024.C4 (Nickel Grey)	Fabric Screen, 50"W x 24"H Requires set of Screen Mounting Clips (sold separately, below)	\$440	
	X-S2-F6224.C1 (Aloe Green) X-S2-F6224.C2 (Varsity Blue) X-S2-F6224.C4 (Nickel Grey)	Fabric Screen, 62"W x 24"H Requires set of Screen Mounting Clips (sold separately, below)	\$518	
	Screen Clips - Double Run	KNX-CLIPS.F1 (Platinum) KNX-CLIPS.F2 (White)	KINEX Benching Screen Clips for double run application.	\$200
	Screen Clips - Single Run	X-SMC-S.F1 (Platinum) X-SMC-S.F2 (White)	KINEX Benching Screen Clips for single run application.	\$210
	Side Screen, metal (Left and Right handed)	Left Handed: X-SS2Lx2.F1 (Platinum) X-SS2Lx2.F2 (White) Right Handed: X-SS2Rx2.F1 (Platinum) X-SS2Rx2.F2 (White)	Metal Side Screen for 24" and 30" worksurfaces, available in Platinum and White. Slide-on application, rubber mat inset. Knob adjusts to worksurface thicknesses up to 1.5". Box of 2. Specify Right or Left handed. Dimensions: 22.9"D x 3.14"W x 12.2"H	\$550

Accessories

	SKU	DESCRIPTION	LIST
KINEX Benching 4 preset handset 	KNX-4-HSET	KINEX Benching 4 preset handset. Upgrade option.	\$115

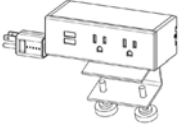

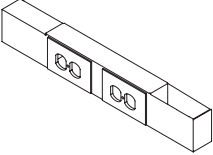

Electrical — Universal

	SKU	DESCRIPTION	LIST
Power Pole 	X-E-PP1-KNX-DR.F1 (Platinum) X-E-PP1-KNX-DR.F1 (White)	Powerpole for KINEX DR application.	\$631
	X-E-PP1-KNX-SR.F1 (Platinum) X-E-PP1-KNX-SR.F1 (White)	Powerpole for KINEX SR application.	\$631
Power Box 	X-E-PB3-EEU	Power Box v2 with 2 electrical, 2 USB outlets. Edge mount with 72" power cord. White.	\$606
Soft Cable Management 	X-FCMT	Soft cable management with zip closure. Light Grey felt fabric.	\$180

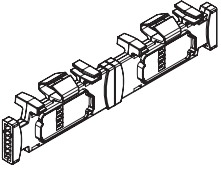

Electrical — Chicago

	SKU	DESCRIPTION	LIST
Chicago Power Box 	IBS-KNX-CHB.F1 (Platinum) IBS-KNX-CHB.F2 (White)	Chicago Box for KINEX application.	\$420

Electrical — 3 Circuit/5 Wire

	SKU	DESCRIPTION	LIST
Power Entry 	X-E3-BF120	Power Entry Base Feed, 120"	\$330
	X-E3-BF120.SF	San Francisco Base Entry Pack — Power Entry Base Feed, 120"	\$432
	X-E3-BF120.NYC	New York Base Entry Pack — Power Entry Base Feed	\$440
	X-E3-CF	3-Circuit — Power Entry Ceiling Feed, 180"	\$390
Junction Block 	X-E3-DJCTBLK.1C	3-Circuit — Double Sided Junction Block. Includes 2 Junction Block Brackets for KINEX.	\$180
Receptacles 	X-E3-D1.C.G (Grey) X-E3-D1.C.G (White)	3-Circuit — Duplex Receptacle (C), 15Amp, 3D, Line-1	\$46
	X-E3-D2.C.G (Grey) X-E3-D2.C.G (White)	3-Circuit — Duplex Receptacle (C), 15Amp, 3D, Line-2	\$46
	X-E3-D3.C.G (Grey) X-E3-D3.C.G (White)	3-Circuit — Duplex Receptacle (C), 15Amp, 3D, Line-3	\$46
Jumpers / Adapters 	X-E3-J36A	36" Adjustable Jumper	\$131
	X-E3-J42A	42" Adjustable Jumper	\$139
	X-E3-J48A	48" Adjustable Jumper	\$148
	X-E3-J54A	54" Adjustable Jumper	\$156
	X-E3-J60A	60" Adjustable Jumper	\$164
	X-E3-J66A	66" Adjustable Jumper	\$172
Y-Connector 	X-E3-YC	3 Circuit Y-Connector (Box of 1)	\$45

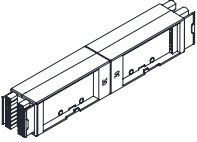
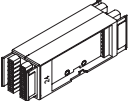
Electrical — 4 Circuit/8 Wire

	SKU	DESCRIPTION	LIST	
Power Entry 	X-E4-BF120	4-Circuit — Power Entry Base Feed, 120"	\$440	
	X-E4-BF120.SF	4-Circuit — San Francisco Base Entry Pack — Power Entry Base Feed, 120"	\$550	
	X-E4-BF120.NYC	4-Circuit — New York City Base Entry Pack — Power Entry Base Feed, 54"	\$525	
	X-E4-CF	4-Circuit — Power Entry Ceiling Feed, 180"	\$475	
Junction Block 	X-E4-DJCTBLK.2C	4-Circuit — Double Sided Double Junction Block. Includes Junction Block Bracket for KINEX.	\$234	
KINEX Single/Double Sided Junction Block 	X-E4-SDJCTBLK	4 Circuit — Double Sided Single Junction Block for KINEX. Includes junction block bracket.	\$215	
Receptacles 	X-E4-D1.D.G (Grey) X-E4-D1.D.W (White)	4-Circuit-Duplex Receptacle (D), 15Amp, 3D, Line-1	\$47	
	X-E4-D2.DT.G (Grey) X-E4-D2.DT.W (White)	4-Circuit-Duplex Receptacle (D), 15Amp, 3D, Line-2, Title 24 Compliant	\$47	
	X-E4-D3.D.G (Grey) X-E4-D3.D.W (White)	4-Circuit -Duplex Receptacle (D), 15Amp, 3D, Line-3	\$47	
	X-E4-D4.D.G (Grey) X-E4-D4.D.W (White)	4-Circuit -Duplex Receptacle (D), 15Amp, 3D, Line-4	\$47	
	Jumpers / Adapters 	X-E4-J36A	4-Circuit — 36" Adjustable Jumper	\$195
		X-E4-J42A	4-Circuit — 42" Adjustable Jumper	\$202
X-E4-J48A		4-Circuit — 48" Adjustable Jumper	\$225	
X-E4-J54A		4-Circuit — 54" Adjustable Jumper	\$235	
X-E4-J60A		4-Circuit — 60" Adjustable Jumper	\$250	
X-E4-J66A		4-Circuit — 66" Adjustable Jumper	\$262	

ICON benching system



Statement of Line

FRAMES

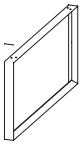

Outer O-Leg — DR



Outer O-Leg — SR



Inner O-Leg — SR

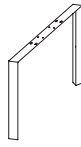

Inner U-Leg — DR



Returns

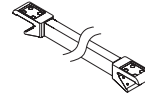

Inner-to-Inner Bars
Inner-to-Outer Bars
Outer-to-Outer Bars

WORKSURFACES

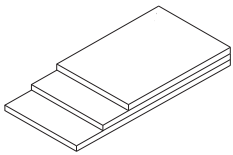

Linear — 48", 60", 72"



Returns

PRIVACY SCREENS & PANELS

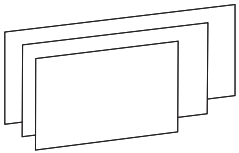

Fabric (Height Adjustable)

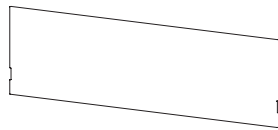

Frosted Glass

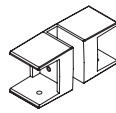

Screen Mounting Clips

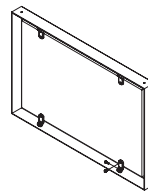

Modesty Panel Leg Insert

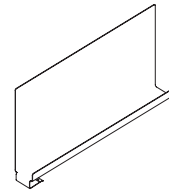

Side Screens

ACCESSORIES

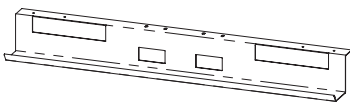

Wire Trough



Vertebrae Cable Management

Typical Configurations

A full gallery of typicals is available in our Typicals price book and on our web site under Dealer Tools (ask your AMQ Sales Representative for the password). Each typical includes CAD file, specifications, rendering and .dwg, .sp4 and .sif files.

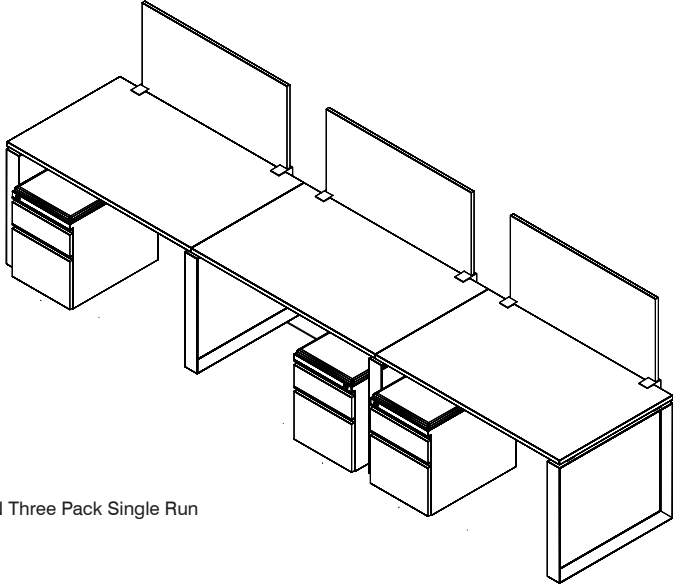

ICON Three Pack Single Run

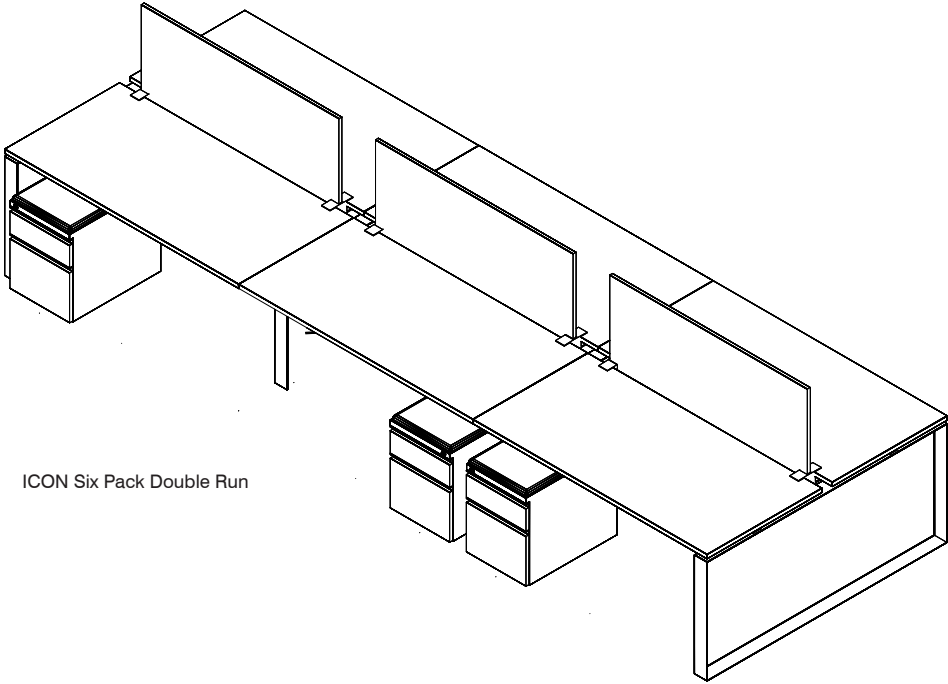

ICON Six Pack Double Run

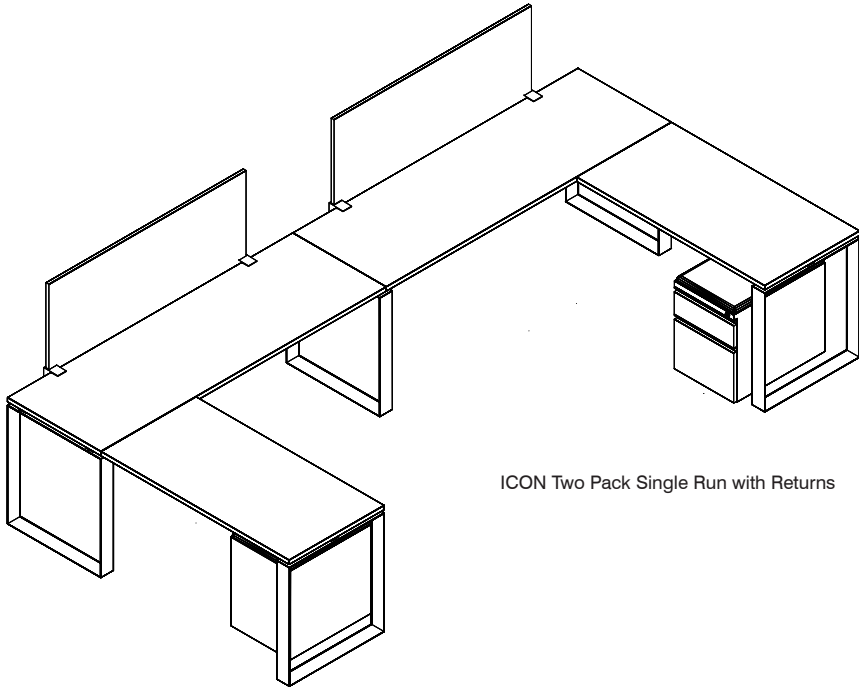

ICON Two Pack Single Run with Returns

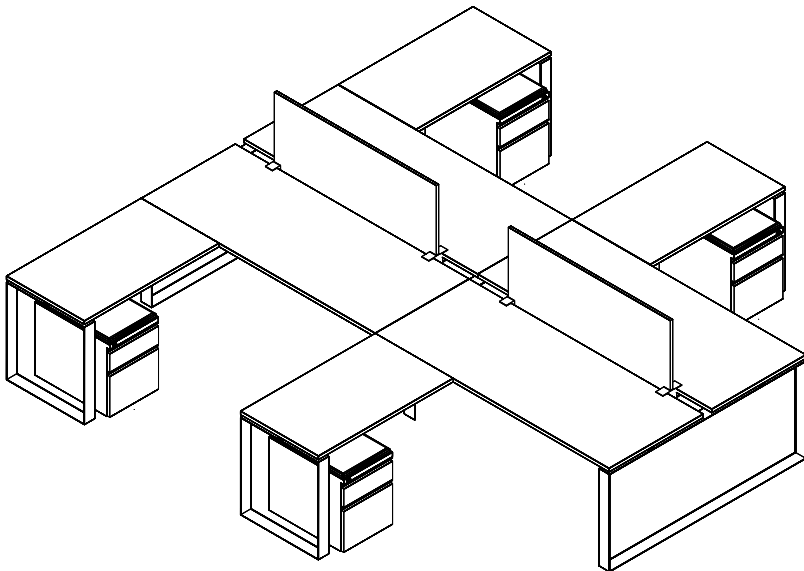

ICON Four Pack Double Run with Returns

How to Specify

EXAMPLE

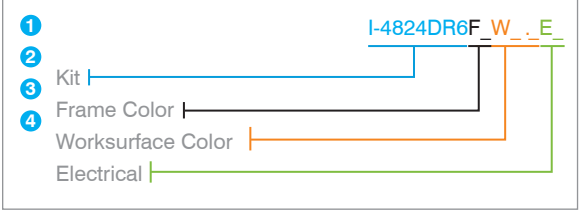

KIT # **I-4824DR6F2W2.4E3**
ICON Double Row of 6; White Frame with Worksurfaces in Walnut Finish and 3 Circuit/5 Wire Electrical (144"W x48.5"D)

Electrical

ICON is designed for one Power Block and two Receptacles per user.
Electrical jumpers are snapped into power blocks in a daisy chain fashion.
Wire troughs manage wires (specify 1 per user).

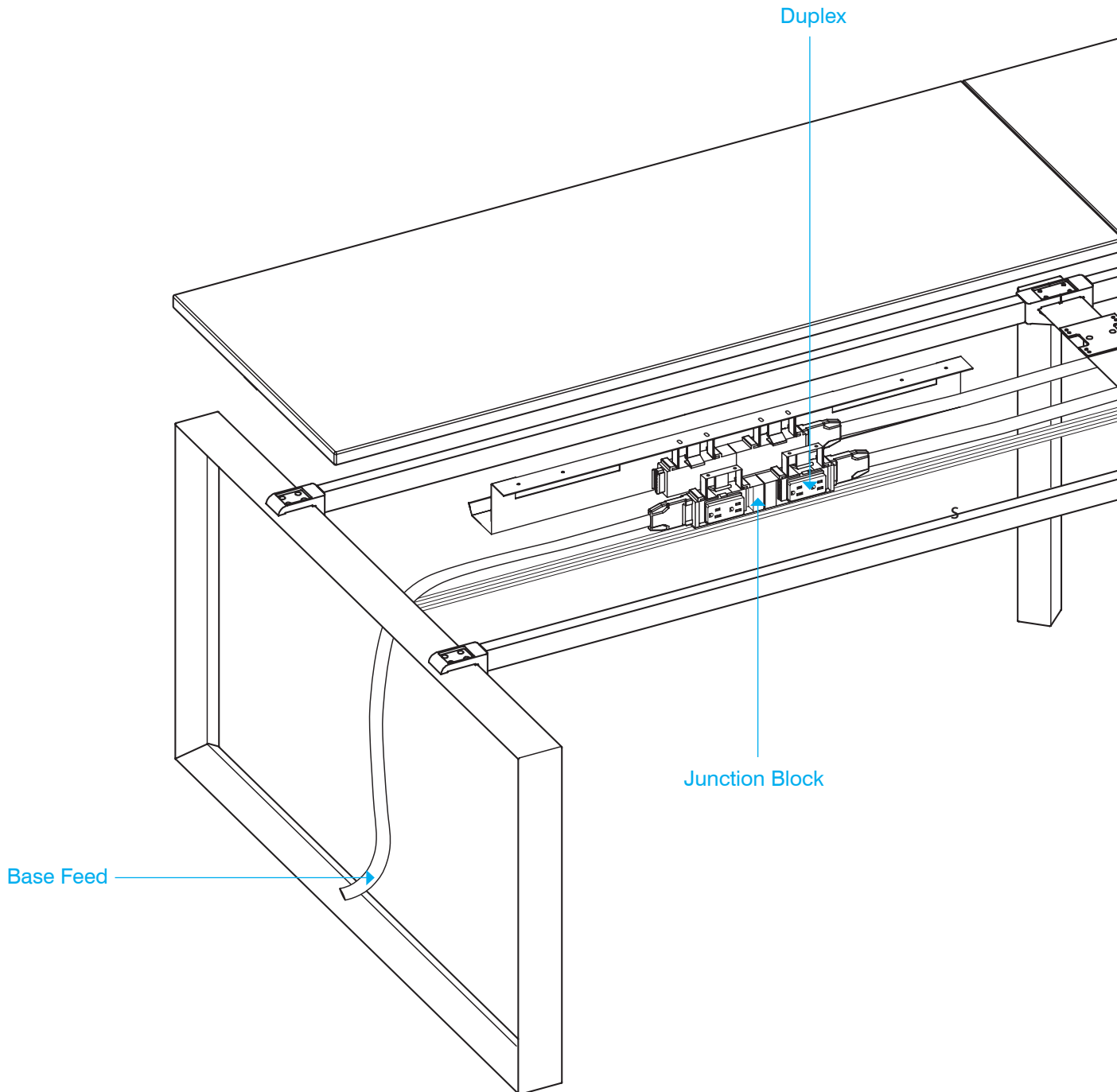

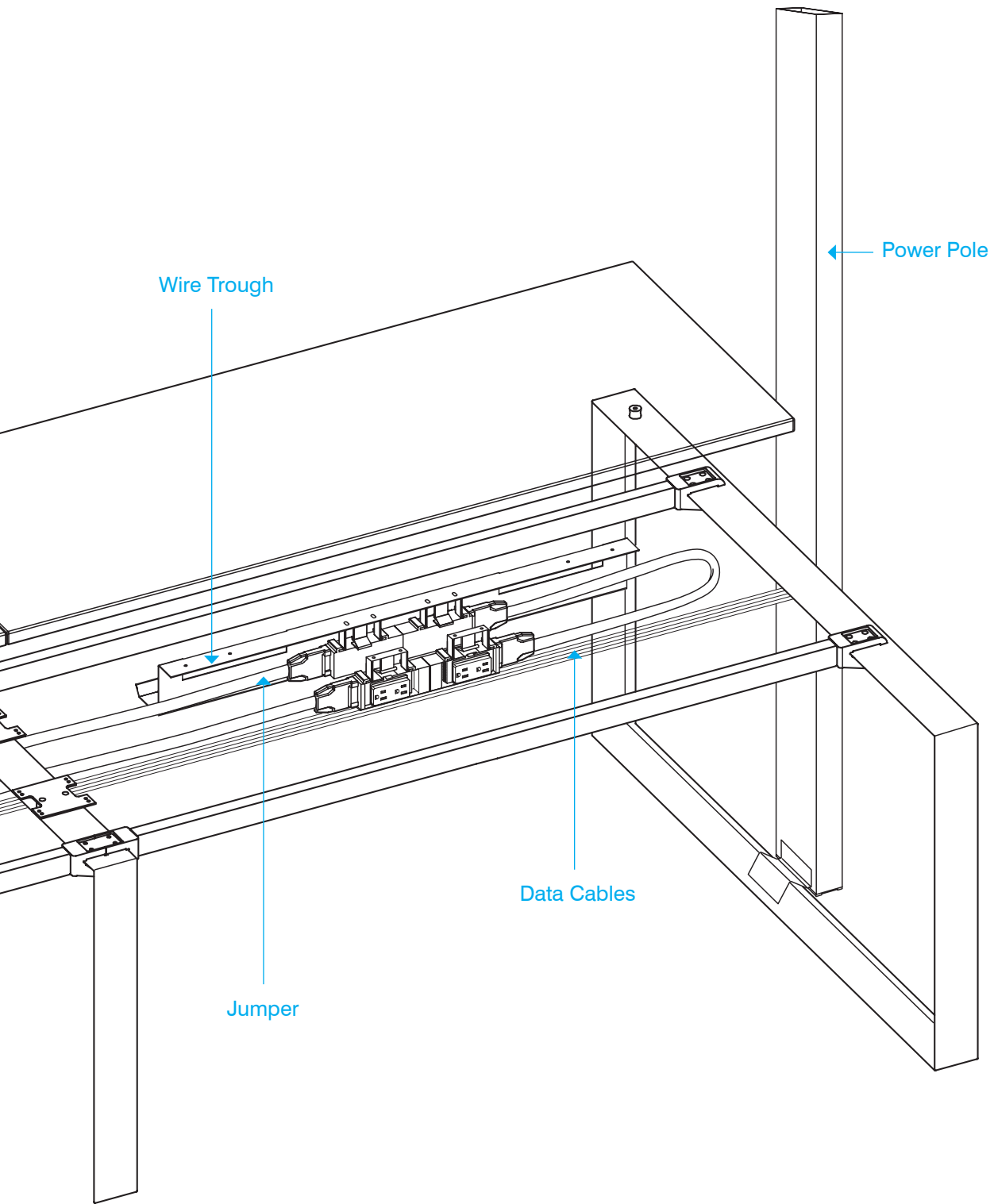

Electrical

Below are examples of how to specify electrical for ICON in both a single and double run.

4 Circuit/8 Wire Specification

Single Run (SR)

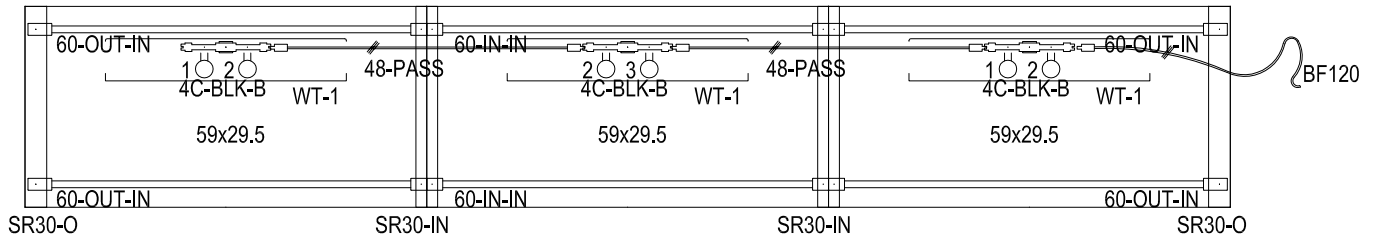

Double Run (DR)

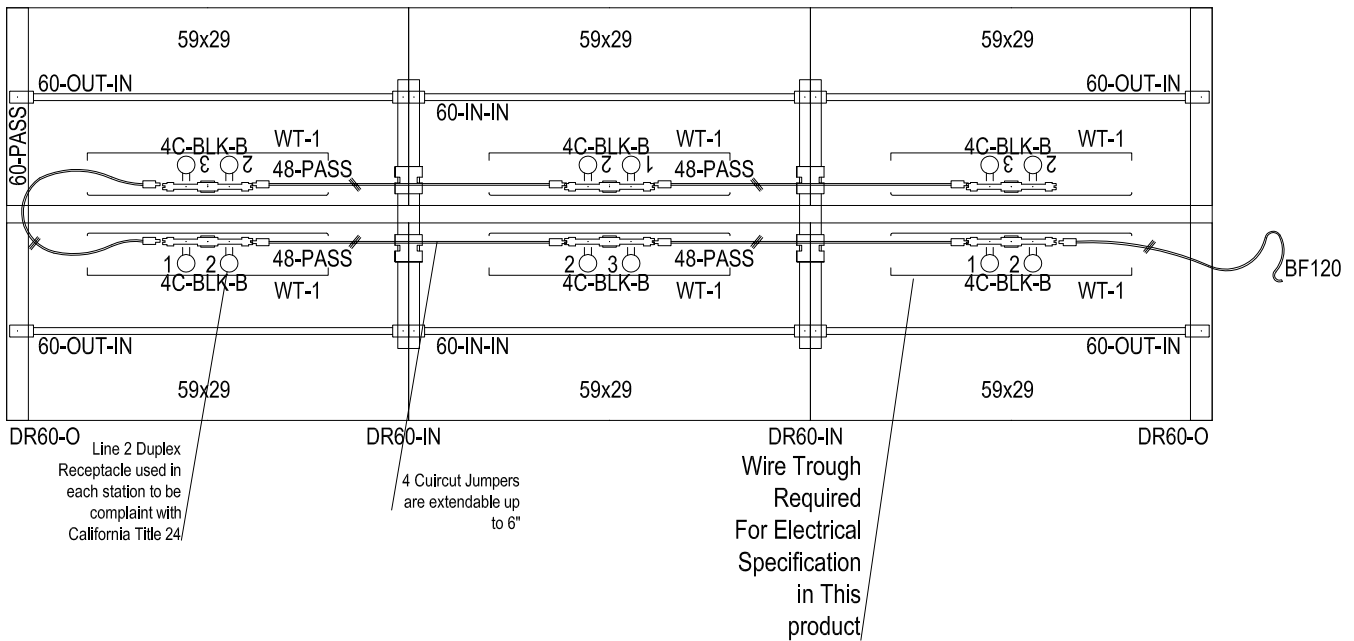

3 Circuit/5 Wire Specification

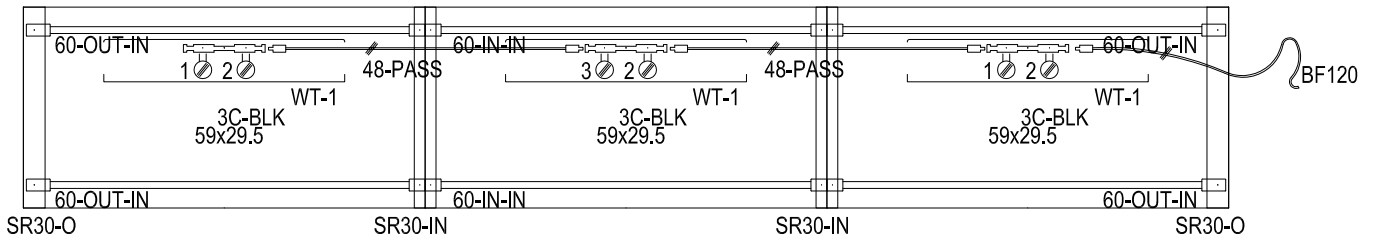

Single Run (SR)

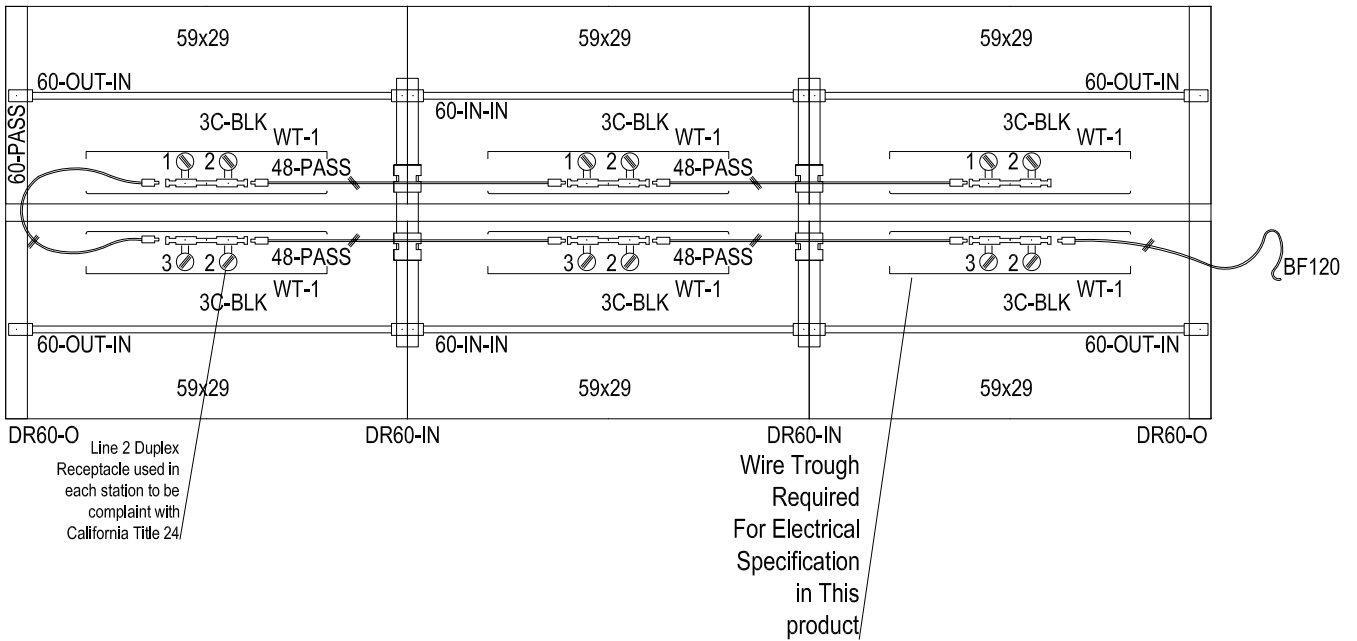

Double Run (DR)

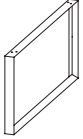
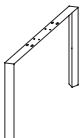

ICON Frames

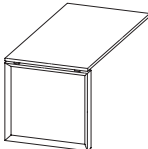
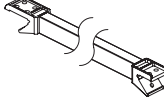
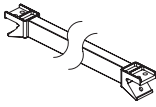
	SKU	DESCRIPTION	LIST
 	I-FL-DR48-2O.F1 (Platinum) I-FL-DR48-2O.F2 (White)	DR Frame Leg — Outside 48"D O-Legs (Box of 2)	\$1,437
	I-FL-DR60-2O.F1 (Platinum) I-FL-DR60-2O.F2 (White)	DR Frame Leg — Outside 60"D O-Legs (Box of 2)	\$1,503
	I-FL-DR48-1I.F1 (Platinum) I-FL-DR48-1I.F2 (White)	DR Frame Leg — Inner 27.6"D U-Leg	\$488
	I-FL-DR60-1I.F1 (Platinum) I-FL-DR60-1I.F2 (White)	DR Frame Leg — Inner 39.5"D U-Leg	\$511
	I-FL-SR24-2O.F1 (Platinum) I-FL-SR24-2O.F2 (White)	SR Frame Leg — Outside 24"D O-Legs (Box of 2)	\$887
	I-FL-SR30-2O.F1 (Platinum) I-FL-SR30-2O.F2 (White)	SR Frame Leg — Outside 30"D O-Leg (Box of 2)	\$929
	I-FL-SR24-1I.F1 (Platinum) I-FL-SR24-1I.F2 (White)	SR Frame Leg — Inner 24"D O-Leg	\$444
	I-FL-SR30-1I.F1 (Platinum) I-FL-SR30-1I.F2 (White)	SR Frame Leg — Inner 30"D O-Leg	\$465
	I-FL-RN24-1O.F1 (Platinum) I-FL-RN24-1O.F2 (White)	Return Frame Leg — One (1) Outside 24"D Return O-Leg	\$449
	I-FB48-4OI.F1 (Platinum) I-FB48-4OI.F2 (White)	48"W Frame H-Bars — Outer-to-Inner (Box of 4)	\$1,280
	I-FB60-4OI.F1 (Platinum) I-FB60-4OI.F2 (White)	60"W Frame H-Bars — Outer-to-Inner (Box of 4)	\$1,280
	I-FB72-4OI.F1 (Platinum) I-FB72-4OI.F2 (White)	72"W Frame H-Bars — Outer-to-Inner (Box of 4)	\$1,495
	I-FB48-2II.F1 (Platinum) I-FB48-2II.F2 (White)	48"W Frame H-Bars — Inner-to-Inner (Box of 2)	\$641
	I-FB60-2II.F1 (Platinum) I-FB60-2II.F2 (White)	60"W Frame H-Bars — Inner-to-Inner (Box of 2)	\$641
	I-FB72-2II.F1 (Platinum) I-FB72-2II.F2 (White)	72"W Frame H-Bars — Inner-to-Inner (Box of 2)	\$747

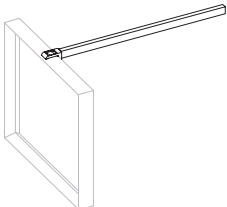
	SKU	DESCRIPTION	LIST
Outer-to-Outer H-Bar 	I-FB48-2OO.F1 (Platinum) I-FB48-2OO.F2 (White)	48"W Frame H-Bars — Outer-to-Outer (Box of 2)	\$641
	I-FB60-2OO.F1 (Platinum) I-FB60-2OO.F2 (White)	60"W Frame H-Bars — Outer-to-Outer (Box of 2)	\$641
	I-FB72-2OO.F1 (Platinum) I-FB72-2OO.F2 (White)	72"W Frame H-Bars — Outer-to-Outer (Box of 2)	\$747
Return H-Bar compatible with 60" and 72" ICON Return leg ordered separately. 	I-RB-D42.F1 (Platinum) I-RB-D42.F2 (White)	42"W Return H-Bar for Double Row Bench	\$309
	I-RB-S42.F1 (Platinum) I-RB-S42.F2 (White)	42"W Return H-Bar for Single Row Bench	\$309
	I-RB-D48.F1 (Platinum) I-RB-D48.F2 (White)	48"W Return H-Bar for Double Row Bench	\$309
	I-RB-S48.F1 (Platinum) I-RB-S48.F2 (White)	48"W Return H-Bar for Single Row Bench	\$309

Worksurfaces

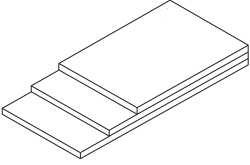
	SKU	DESCRIPTION	LIST
48" Worksurfaces 	I-SR4824-W_._	Worksurface for ICON Single Row 48x24 (48"W x 23.5"D X 1"H)	\$365
	I-SR4829-W_._	Worksurface for ICON Single Row 48x30 (48"W x 29.5"D X 1"H)	\$425
	I-DR4824-W_._	Worksurface for ICON Double Row 48x24 (48"W x 23"D X 1"H)	\$365
	I-DR4829-W_._	Worksurface for ICON Double Row 48x30 (48"W x 29"D X 1"H)	\$425
60" Worksurfaces 	I-SR5924-W_._	Worksurface for ICON Single Row 60x24 (59"W x 23.5"D X 1"H)	\$455
	I-SR5929-W_._	Worksurface for ICON Single Row 60x30 (59"W x 29.5"D X 1"H)	\$495
	I-DR5924-W_._	Worksurface for ICON Double Row 60x24 (59"W x 23"D X 1"H)	\$455
	I-DR5929-W_._	Worksurface for ICON Double Row 60x30 (59"W x 29"D X 1"H)	\$495
72" Worksurfaces 	I-SR7224-W_._	Worksurface for ICON Single Row 72x24 (72"W x 23.5"D X 1"H)	\$548
	I-SR7229-W_._	Worksurface for ICON Single Row 72x30 (72"W x 29.5"D X 1"H)	\$595
	I-DR7224-W_._	Worksurface for ICON Double Row 72x24 (72"W x 23"D X 1"H)	\$548
	I-DR7229-W_._	Worksurface for ICON Double Row 72x30 (72"W x 29"D X 1"H)	\$595
Return Worksurfaces 	X-R4224-W_._	Return Worksurface 42x24 (42"W x 24"D X 1"H)	\$285
	X-R4824-W_._	Return Worksurface 48x24 (48"W x 24"D X 1"H)	\$295

Worksurface Finishes

Specify at the end of product SKU



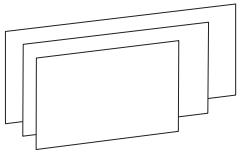
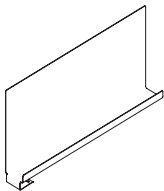
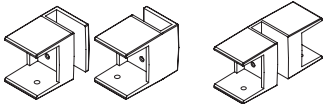

Privacy Screens

	SKU	DESCRIPTION	LIST	
Fabric Screen (height adjustable) 	X-S2-F3824.C1 (Aloe Green) X-S2-F3824.C2 (Varsity Blue) X-S2-F3824.C4 (Nickel Grey)	Screen — Fabric, 38"W x 24"H Requires screen mounting clips (sold separately, below).	\$399	
	X-S2-F5024.C1 (Aloe Green) X-S2-F5024.C2 (Varsity Blue) X-S2-F5024.C4 (Nickel Grey)	Screen — Fabric, 50"W x 24"H Requires screen mounting clips (sold separately, below).	\$440	
	X-S2-F6224.C1 (Aloe Green) X-S2-F6224.C2 (Varsity Blue) X-S2-F6224.C4 (Nickel Grey)	Screen — Fabric, 62"W x 24"H Requires screen mounting clips (sold separately, below).	\$518	
	Frosted Glass Screen	X-S-GF5020	Screen — Frosted Glass with Mounting Clamp Notches 50"W x 20"H (Box of 2). 8mm depth. <i>Note:</i> Each box of Frosted Glass screens (Qty 2) requires <u>two</u> sets of Screen Mounting Clips (sold separately, below).	\$1,250
	Side Screen, metal (Left and Right handed) 	Left Handed: X-SS1.1Lx2.F2 (White)	Metal Side Screen for 30" worksurfaces in White. Slide-on application, available Left or Right Handed. Works with worksurfaces up to 1" thick. Box of 2.	\$550
		Right Handed: X-SS1.1Rx2.F2 (White)	Dimensions: 25"D x 3.14"W x 12.2"H	
	Screen Mounting Clips (for fabric and frosted glass screens) 	X-SMC-D.F1 (Platinum) X-SMC-D.F2 (White)	Screen Mounting Clips for Double Run Worksurfaces (Set of 2). For fabric and frosted screen attachment.	\$295
		X-SMC-S.F1 (Platinum) X-SMC-S.F2 (White)	Screen Mounting Clips for Single Run Worksurfaces (Set of 2). For fabric and frosted screen attachment.	\$210

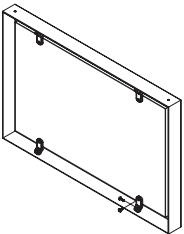
Panel Inserts

	SKU	DESCRIPTION	LIST
Privacy Panel Leg Insert (White finish) 10 day lead time 	I-DR48-PP-W2.1	ICON Double Run (DR) Privacy Panel Leg Insert, White. 22.6"H x 45.4"W x 0.6"D	\$460
	I-DR60-PP-W2.1	ICON Double Run (DR) Privacy Panel Leg Insert, White. 22.6"H x 57.2"W x 0.6"D	\$505
	I-SR24-PP-W2.1	ICON Single Run (SR) Privacy Panel Leg Insert, White. 22.6"H x 20.2"W x 0.6"D	\$385
	I-SR30-PP-W2.1	ICON Single Run (SR) Privacy Panel Leg Insert, White. 22.6"H x 26"W x 0.6"D	\$420

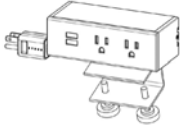
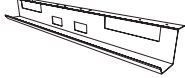

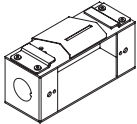

Electrical — Universal

	SKU	DESCRIPTION	LIST
Power Poles 	X-E-PP1.F1 (Platinum) X-E-PP1.F2 (White)	Power Pole (includes ICON attachment bracket) for ceiling feed and/or data management. 12' high.	\$631
Power Box 	X-E-PB3-EEU	Power Box v2 with 2 electrical, 2 USB outlets. Edge mount with 72" power cord. White.	\$606
Wire Trough 	X-E-WT1.F1 (Platinum) X-E-WT1.F2 (White)	Wire Trough, 36"W	\$150
Cable Management Vertebrae 	X-VB.F1 (Grey) X-VB.F2 (White)	Vertebrae Cable Management <i>Note:</i> To be used with Base Feed; ICON only	\$180

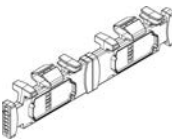

Electrical — Chicago

	SKU	DESCRIPTION	LIST
Chicago Box 	X-E-CHB	Chicago Box for hardwiring ICON electrical	\$155

Electrical — 3 Circuit/5 Wire

	SKU	DESCRIPTION	LIST	
Power Entry 	X-E3-BF120	Power Entry Base Feed, 120"	\$330	
	X-E3-BF120.SF	San Francisco Base Entry Pack — Power Entry Base Feed, 120"	\$432	
	X-E3-BF120.NYC	New York Base Entry Pack — Power Entry Base Feed	\$440	
	X-E3-CF	3-Circuit — Power Entry Ceiling Feed, 180"	\$390	
Junction Block 	X-E3-DJCTBLK.1	3-Circuit — Double Sided Junction Block for ICON Includes 2 Junction Block Brackets	\$180	
Receptacles 	X-E3-D1.C.G (Grey) X-E3-D1.C.W (White)	3-Circuit - Duplex Receptacle (C), 15Amp, 3D, Line-1	\$46	
	X-E3-D2.C.G (Grey) X-E3-D2.C.W (White)	3-Circuit - Duplex Receptacle (C), 15Amp, 3D, Line-2	\$46	
	X-E3-D3.C.G (Grey) X-E3-D3.C.W (White)	3-Circuit - Duplex Receptacle (C), 15Amp, 3D, Line-3	\$46	
	Jumpers / Adapters 	X-E3-J36A	36" Adjustable Jumper — 3-Circuit	\$131
		X-E3-J42A	42" Adjustable Jumper — 3-Circuit	\$139
		X-E3-J48A	48" Adjustable Jumper — 3-Circuit	\$148
X-E3-J54A		54" Adjustable Jumper — 3-Circuit	\$156	
X-E3-J60A		60" Adjustable Jumper — 3-Circuit	\$164	
X-E3-J66A		66" Adjustable Jumper — 3-Circuit	\$172	
Y-Connector 		X-E3-YC	3-Circuit — Y Connector (Box of 1)	\$45

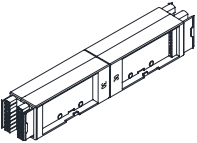
Electrical — 4 Circuit/8 Wire

	SKU	DESCRIPTION	LIST	
Power Entry 	X-E4-BF120	4-Circuit — Power Entry Base Feed, 120"	\$440	
	X-E4-BF120.SF	4-Circuit — San Francisco Base Entry Pack — Power Entry Base Feed, 120"	\$550	
	X-E4-BF120.NYC	4-Circuit — New York City Base Entry Pack — Power Entry Base Feed, 54"	\$525	
	X-E4-CF	4-Circuit-Power Entry Ceiling Feed, 180"	\$475	
Junction Block 	X-E4-HJCTBLK.2	4-Circuit Single Sided Junction Block for ICON (Includes 2 Junction Block Brackets)	\$225	
	X-E4-DJCTBLK.2	4-Circuit Double Sided Junction Block for ICON (Includes 2 Junction Block Brackets)	\$234	
Receptacles 	X-E4-D1.D.G (Grey) X-E4-D1.D.W (White)	4-Circuit-Duplex Receptacle (D), 15Amp, 3D, Line-1	\$47	
	X-E4-D2.DT.G (Grey) X-E4-D2.DT.W (White)	4-Circuit-Duplex Receptacle (D), 15Amp, 3D, Line-2 Title 24 Compliant	\$47	
	X-E4-D3.D.G (Grey) X-E4-D3.D.W (White)	4-Circuit -Duplex Receptacle (D), 15Amp, 3D, Line-3	\$47	
	X-E4-D4.D.G (Grey) X-E4-D4.D.W (White)	4-Circuit -Duplex Receptacle (D), 15Amp, 3D, Line-4	\$47	
	Jumpers / Adapters 	X-E4-J36A	36" Adjustable Jumper	\$195
		X-E4-J48A	48" Adjustable Jumper	\$225
		X-E4-J60A	60" Adjustable Jumper	\$250
		X-E4-J66A	66" Adjustable Jumper	\$262
H-Connector	X-E4-HC	4-Circuit H-Connector for single side Junction Block	\$100	

ILINE power/data beam

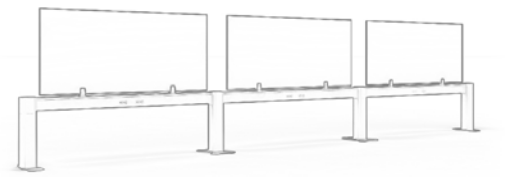

Statement of Line

FRAME

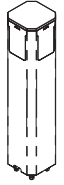

90°/180° Post
(2-way, 3-way, 4-way)



120° Post
(3-way)

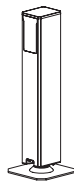

180° Post
(2-way)

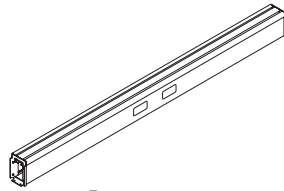

Beam



DR End Foot

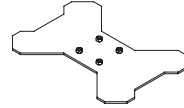

DR Center Foot

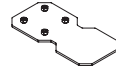

SR End Foot

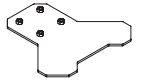

SR Center Foot

WORKSURFACES

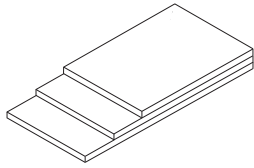

Linear
48", 60" and 72" widths

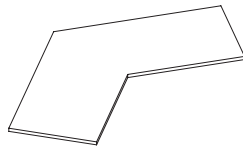

120°
with ACTIV-Pro3

PRIVACY SCREENS & PANELS

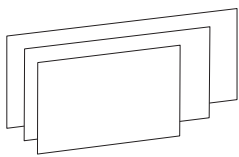

Fabric Screens



Screen Mounting Clips

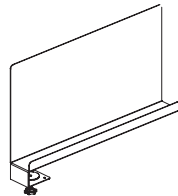

Side Screen

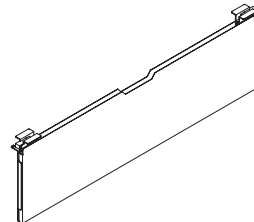

Modesty Panel

ACCESSORIES

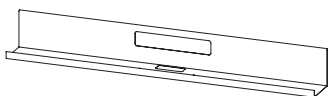

ILINE Wire Tray

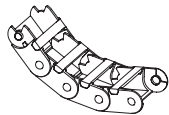

Cable Management Track

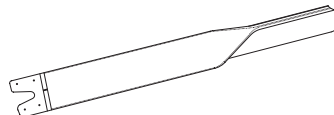

Soft Cable Management

Typical Configurations

A full gallery of typicals is available in our Typicals price book and on our web site under Dealer Tools (ask your AMQ Sales Representative for the password). Each typical includes CAD file, specifications, rendering and .dwg, .sp4 and .sif files.

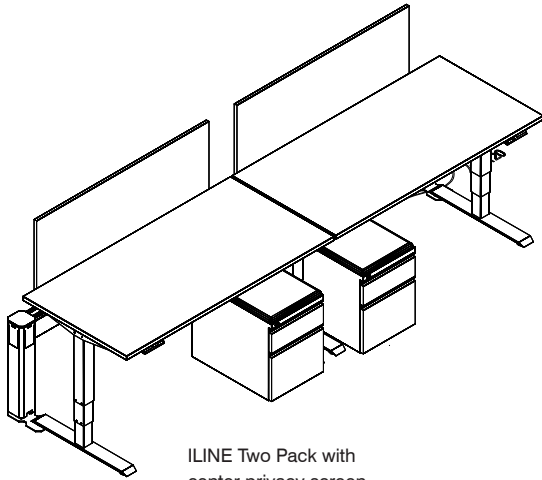

ILINE Two Pack with center privacy screen

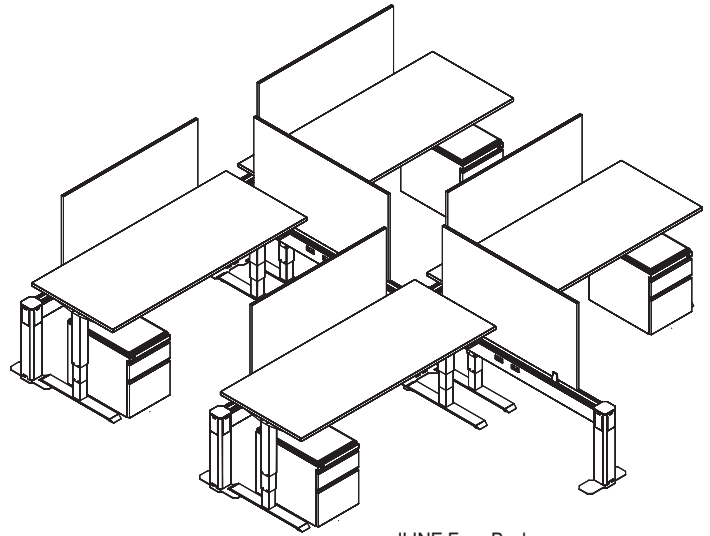

ILINE Four Pack

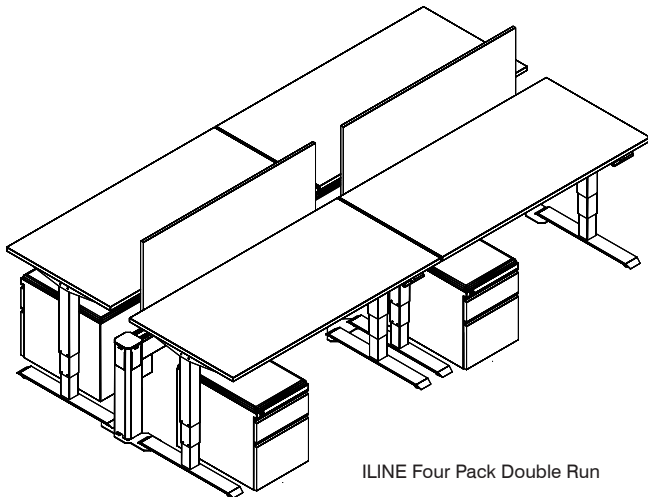

ILINE Four Pack Double Run

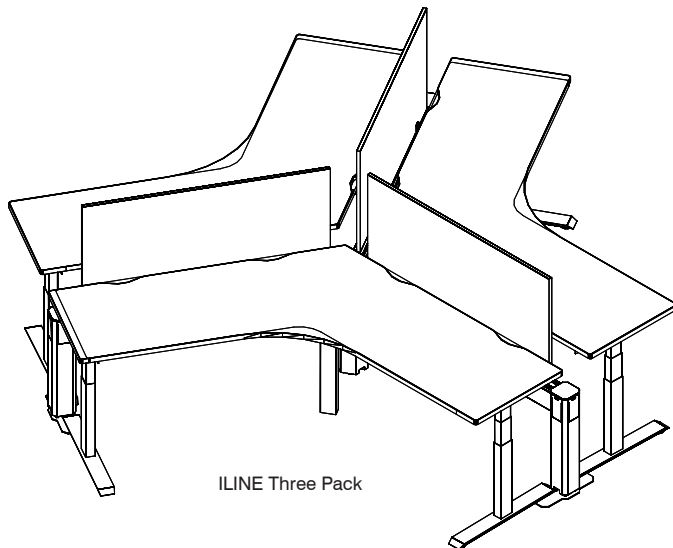

ILINE Three Pack

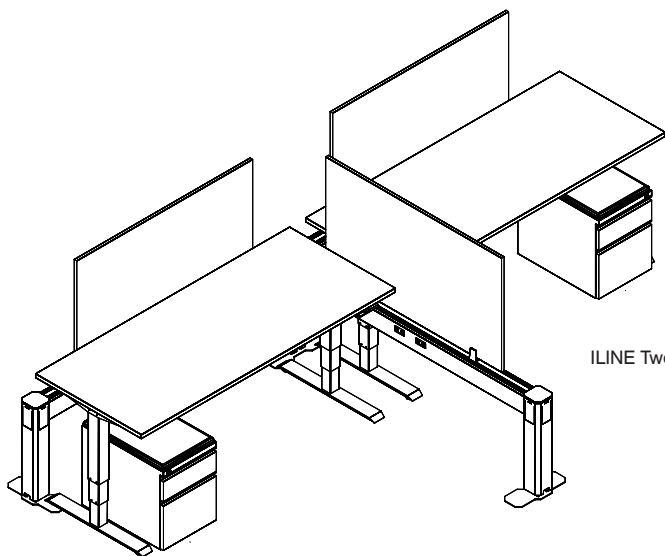

ILINE Two Pack Single Run

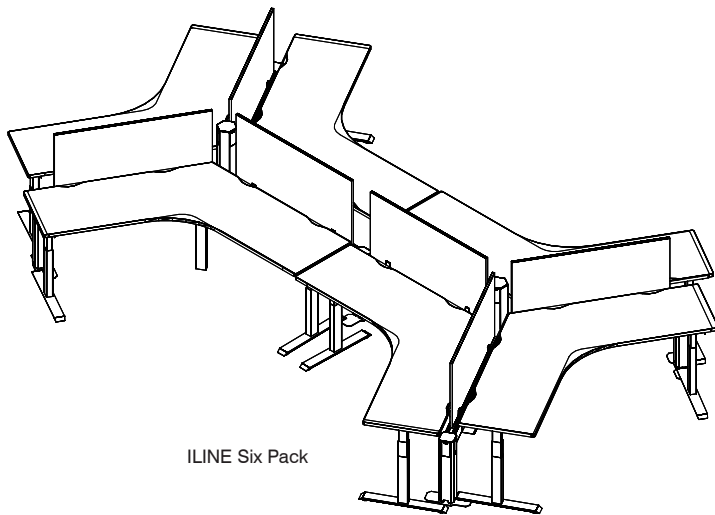

ILINE Six Pack

Electrical

ILINE beam technology distributes electrical with either 3 circuit/5 wire or 4 circuit/8 wire.

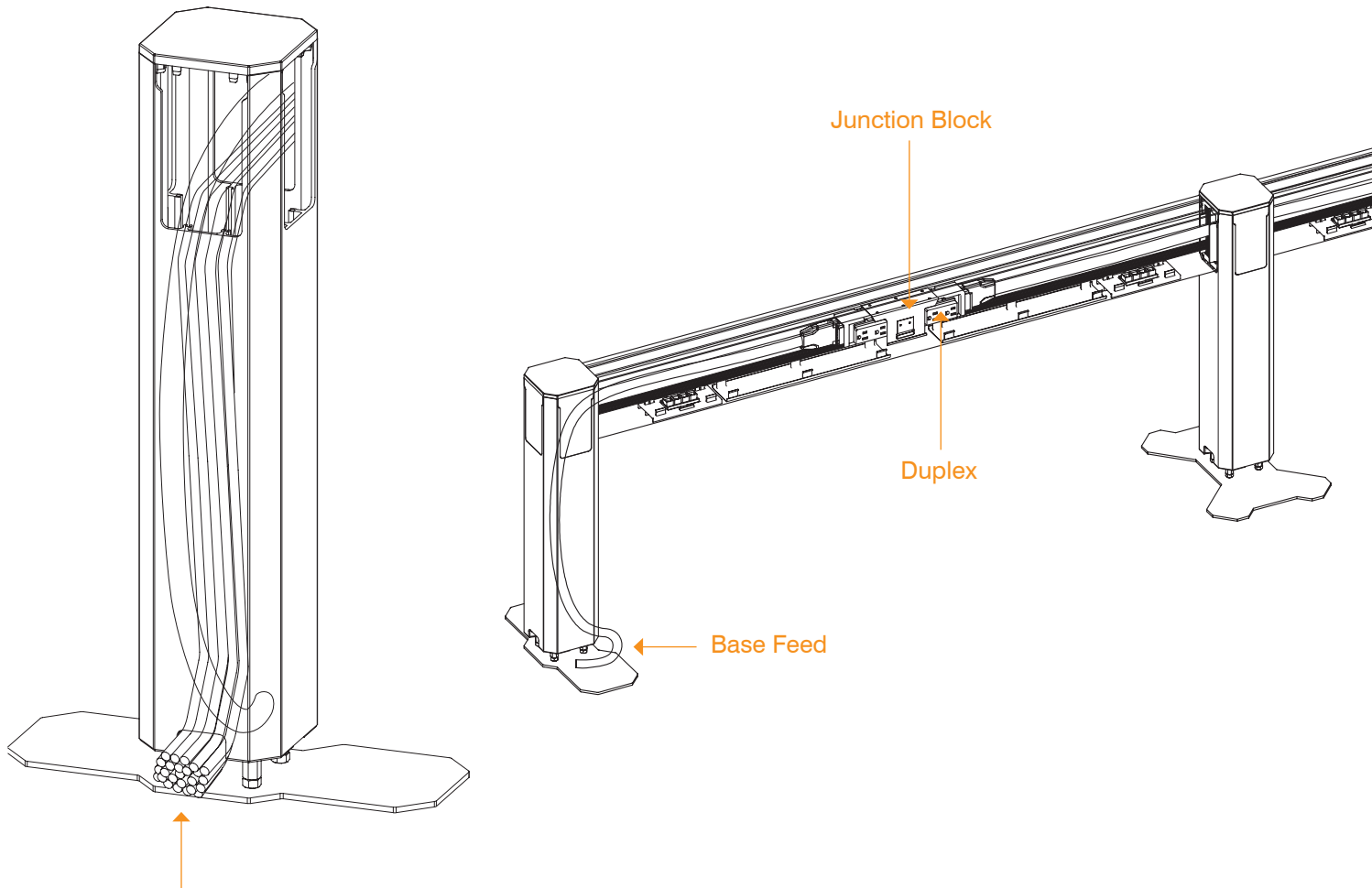

Each floor entry accepts up to 24 CAT6 cables or 1 infeed/conduit

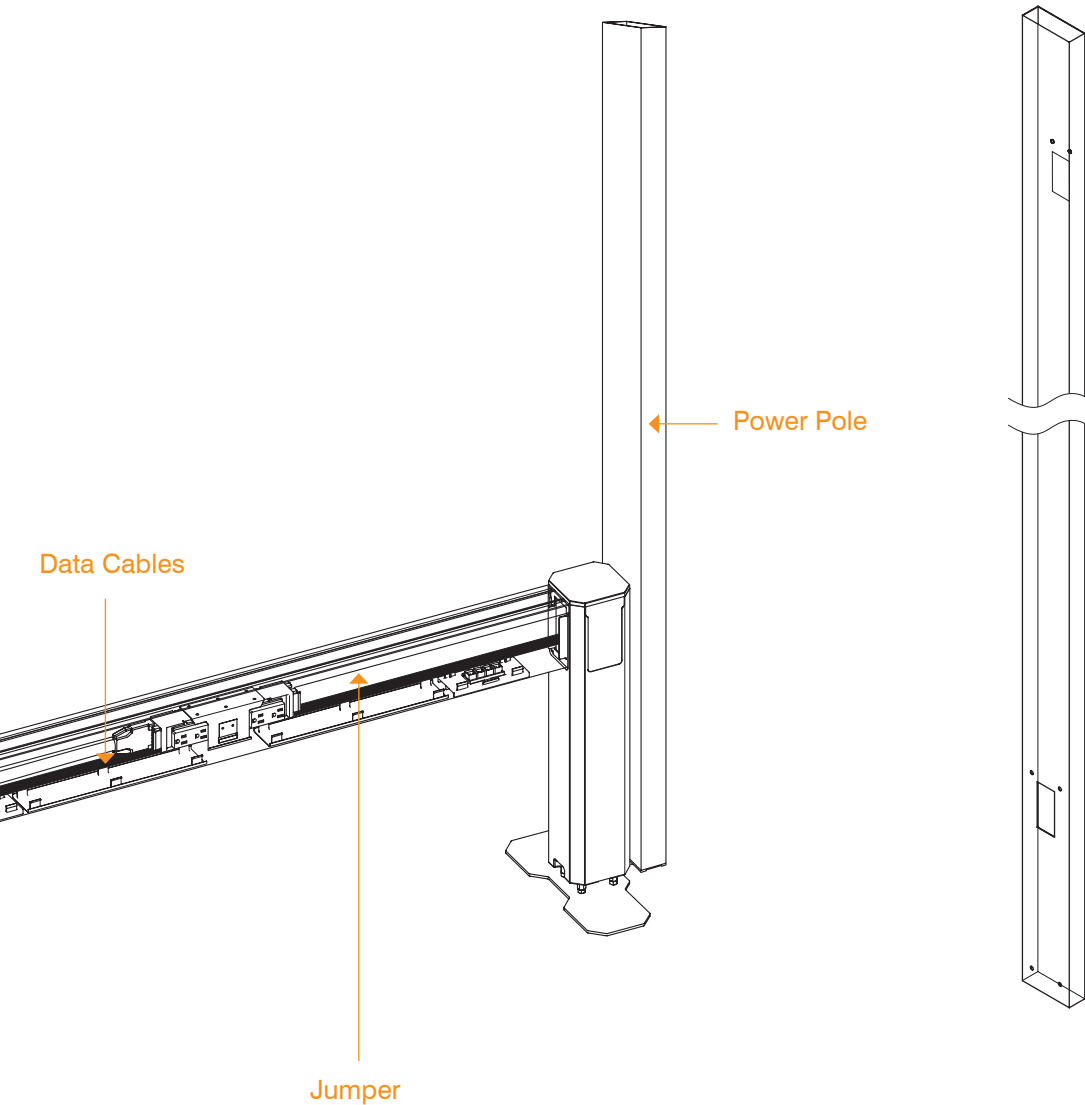

Power Pole

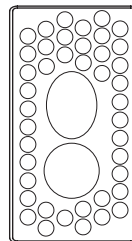

Can accept
42 CAT6 cables,
1 conduit and
1 infeed

3 Circuit

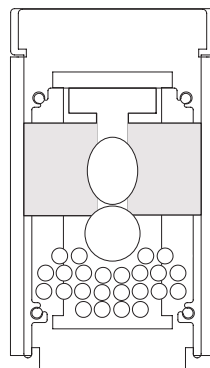

4 Circuit

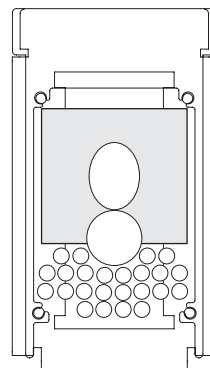

Accepts 24 CAT6 cables, 1 conduit and 1 infeed

3 Circuit/5 Wire

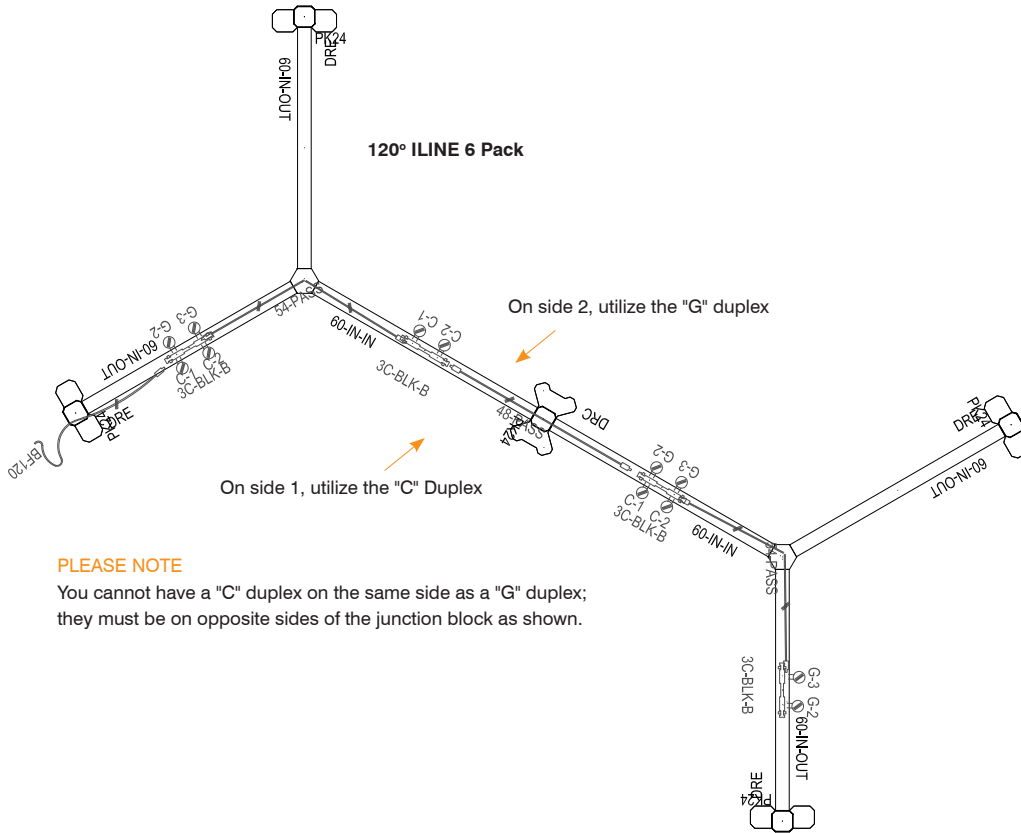

PLEASE NOTE

You cannot have a "C" duplex on the same side as a "G" duplex; they must be on opposite sides of the junction block as shown.

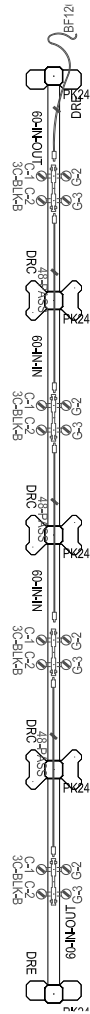
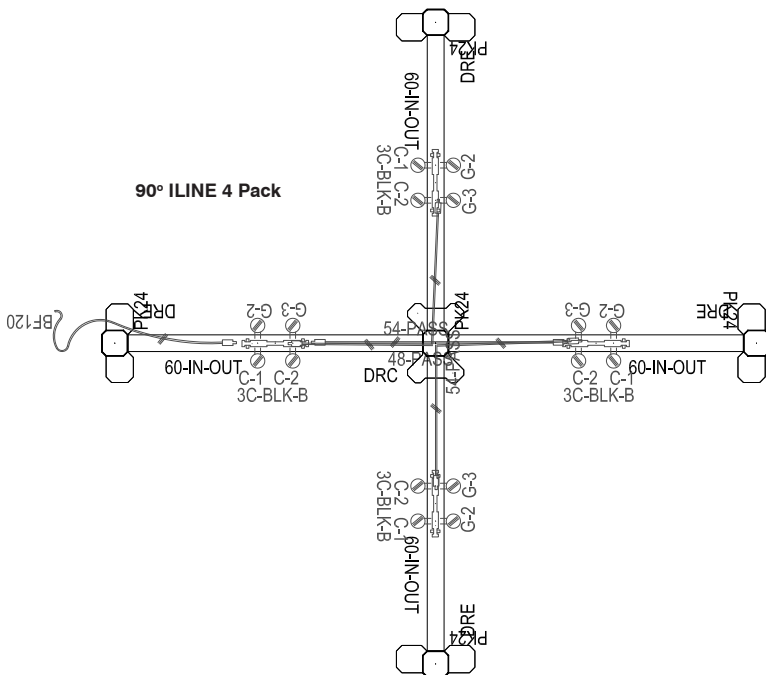

Electrical Specification



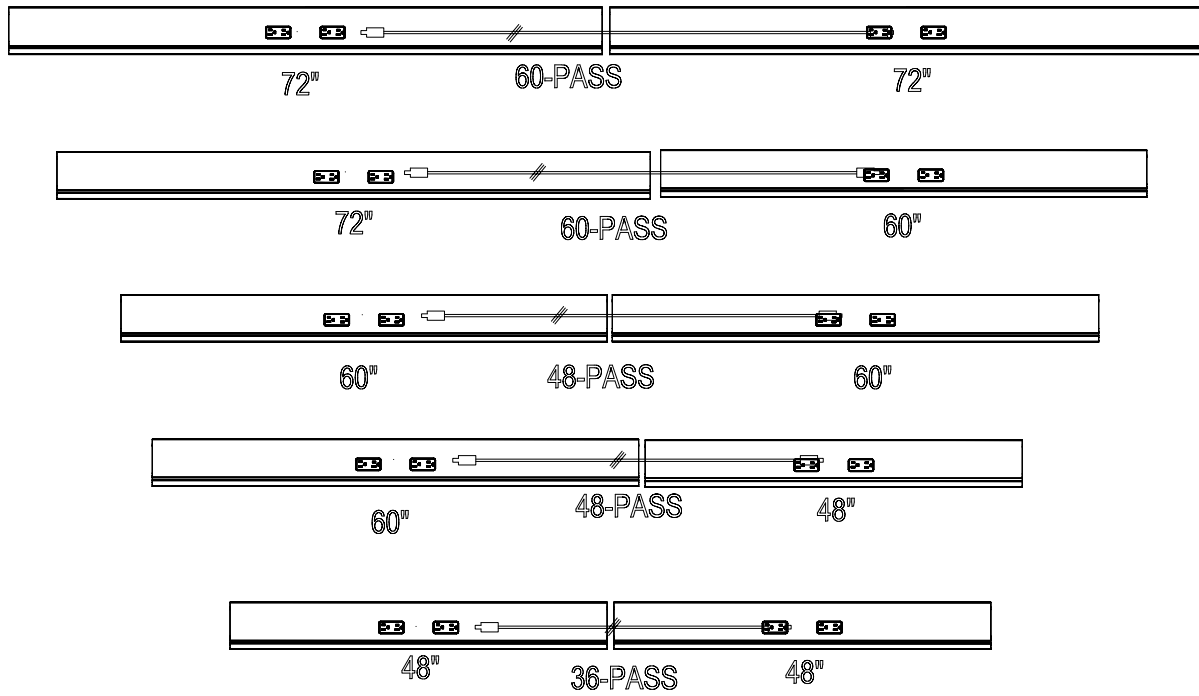

Jumpers (4 Circuit/8 Wire)

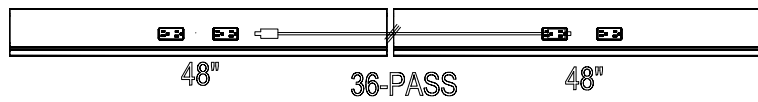
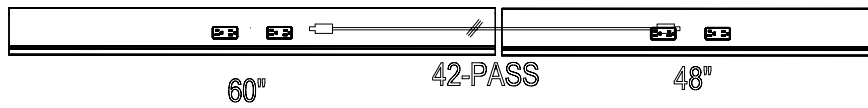
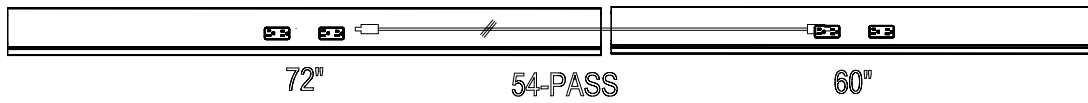
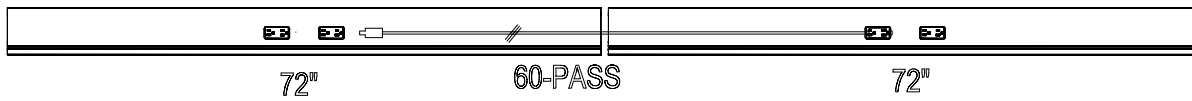



Jumpers (3 Circuit/5 Wire)

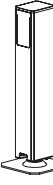
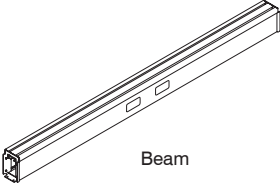
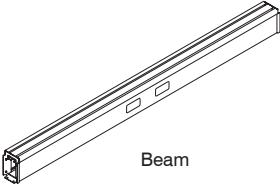
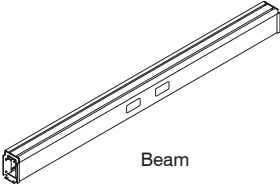

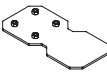
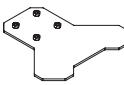
ILINE Kits



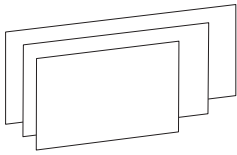

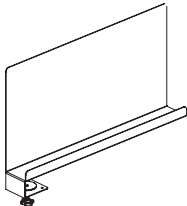
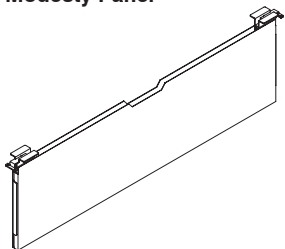
	SKU	DESCRIPTION	LIST
Post Kits			
 120° Post  90°/180° Post (2-way, 3-way, 4-way)  180° Post (2-way)	IBS-POST-24.F1 (Platinum) IBS-POST-24.F2 (White)	24"H ILINE Post for 90/180 degree (2-way, 3-way, 4-way) application. Includes Post Top Cap, Post, Hardware and 3x plastic Side Covers.	\$440
	IBS-120POST24.F1 (Platinum) IBS-120POST24.F2 (White)	24"H ILINE Post for 120 Degree application. Includes Post Top Cap, Post, 3x plastic Side Covers, Base Plate, Glides and Hardware.	\$455
	IBS-180POST24.F1 (Platinum) IBS-180POST24.F2 (White)	ILINE 24"H 180 Post (2-way) Includes; Post Top Cap, 24"H Post for 180 degree application. Includes: Base Plate, Glides, 2x plastic Side Covers and Hardware.	\$375
48" Beam Kits			
 Beam	IBS-BEAM48-OI.F1 (Platinum) IBS-BEAM48-OI.F2 (White)	48"W (41-5/8") Outer-to-Inner Extruded Aluminium Beam. Includes 2 x Beam Plates 2x Bridge Connector, 2x Receptacle Cover, 2x Data Adapter with Data Faceplates and Hardware	\$560
	IBS-BEAM48-II.F1 (Platinum) IBS-BEAM48-II.F2 (White)	48"W (44-1/4") Inner-to-Inner Extruded Aluminium Beam includes 2x Beam Plates 2x Bridge Connector, 2x Receptacle Cover, 2x Data Adapter with Data Faceplates and Hardware	\$580
60" Beam Kits			
 Beam	IBS-BEAM60-OI.F1 (Platinum) IBS-BEAM60-OI.F2 (White)	60"W (53-5/8") Outer-to-Inner Extruded Aluminium Beam includes 2x Beam Plates 2x Bridge Connector, 2x Receptacle Cover, 2x Data Adapter with Data Faceplates and Hardware	\$640
	IBS-BEAM60-II.F1 (Platinum) IBS-BEAM60-II.F2 (White)	60"W (56-1/4") Inner-to-Inner Extruded Aluminium Beam includes 2x Beam Plates 2x Bridge Connector, 2x Receptacle Cover, 2x Data Adapter with Data Faceplates and Hardware	\$660
72" Beam Kits			
 Beam	IBS-BEAM72-OI.F1 (Platinum) IBS-BEAM72-OI.F2 (White)	72"W (65-5/8") Outer-to-Inner Extruded Aluminium Beam includes 2x Beam Plates 2x Bridge Connector, 2x Receptacle Cover, 2x Data Adapter with Data Faceplates and Hardware	\$720
	IBS-BEAM72-II.F1 (Platinum) IBS-BEAM72-II.F2 (White)	72"W (68-1/4") Inner-to-Inner Extruded Aluminium Beam includes 2 x Beam Plates 2x Bridge Connector, 2x Receptacle Cover, 2x Data Adapter with Data Faceplates and Hardware	\$740
Base Kits			
 DR End Foot  DR Center Foot	IBS-BASE-SRE.F1 (Platinum) IBS-BASE-SRE.F2 (White)	Single Run End Base — Includes Base Plate and Hardware	\$115
	IBS-BASE-SRC.F1 (Platinum) IBS-BASE-SRC.F2 (White)	ILINE — Single Run Center base — Includes Base Plate and Hardware	\$130
 SR End Foot  SR Center Foot	IBS-BASE-DRE.F1 (Platinum) IBS-BASE-DRE.F2 (White)	ILINE — Double Run End base — Includes Base Plate and Hardware	\$135
	IBS-BASE-DRC.F1 (Platinum) IBS-BASE-DRC.F2 (White)	ILINE — Double Run Center base — Includes Base Plate and Hardware	\$160

Privacy Screens and Panels

	SKU	DESCRIPTION	LIST	
Fabric Screens 	X-S2-F3824.C1 (Aloe Green) X-S2-F3824.C2 (Varsity Blue) X-S2-F3824.C4 (Nickel Grey)	Screen — Fabric, 38"W x 24"H Requires set of Screen Mounting Clips (sold separately, below)	\$399	
	X-S2-F5024.C1 (Aloe Green) X-S2-F5024.C2 (Varsity Blue) X-S2-F5024.C4 (Nickel Grey)	Screen — Fabric, 50"W x 24"H Requires set of Screen Mounting Clips (sold separately, below)	\$440	
	X-S2-F6224.C1 (Aloe Green) X-S2-F6224.C2 (Varsity Blue) X-S2-F6224.C4 (Nickel Grey)	Screen — Fabric, 62"W x 24"H Requires set of Screen Mounting Clips (sold separately, below)	\$518	
	Screen Mounting Clips			
		IBS-CLIPS.F1 (Platinum) IBS-CLIPS.F2 (White)	ILINE — Screen Mounting Clips (Set of 2)	\$325
		Side Screen, metal (Left and Right handed)		
		Left Handed: X-SS2Lx2.F1 (Platinum) X-SS2Lx2.F2 (White)	Metal Side Screen for 24" and 30" worksurfaces, available in Platinum and White.	\$550
		Right Handed: X-SS2Rx2.F1 (Platinum) X-SS2Rx2.F2 (White)	Slide-on application, rubber mat inset. Knob adjusts to worksurface thicknesses up to 1.5". Box of 2. Specify Right or Left handed.	Dimensions: 22.9"D x 3.14"W x 12.2"H
	Modesty Panel 	IBS-MP48-OI.F1 (Platinum) IBS-MP48-OI.F2 (White)	Modesty Panel, Metal — 48" Outer-Inner; Includes set of brackets.	\$455
IBS-MP48-II.F1 (Platinum) IBS-MP48-II.F2 (White)		Modesty Panel, Metal — 48" Inner-Inner; Includes set of brackets.	\$455	
IBS-MP60-OI.F1 (Platinum) IBS-MP60-OI.F2 (White)		Modesty Panel, Metal — 60" Outer-Inner; Includes set of brackets.	\$465	
IBS-MP60-II.F1 (Platinum) IBS-MP60-II.F2 (White)		Modesty Panel, Metal — 60" Inner-Inner; Includes set of brackets.	\$465	
IBS-MP72-OI.F1 (Platinum) IBS-MP72-OI.F2 (White)		Modesty Panel, Metal — 72" Outer-Inner; Includes set of brackets.	\$475	
IBS-MP72-II.F1 (Platinum) IBS-MP72-II.F2 (White)		Modesty Panel, Metal — 72" Inner-Inner; Includes set of brackets.	\$475	

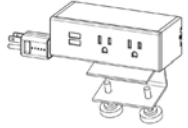
For Worksurfaces, see pages 92 and 93 in the ACTIV section.

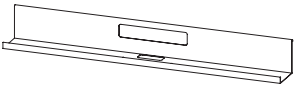



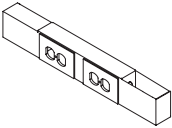

Electrical — Universal

	SKU	DESCRIPTION	LIST
Power Poles 	X-E-PP1-IBS.F1 (Platinum) X-E-PP1-IBS.F2 (White)	Power Pole — for ceiling feed and/or data management. 12' high. Includes ILINE attachment bracket.	\$631
Power Box 	X-E-PB3-EEU	Power Box v2 with 2 electrical, 2 USB outlets. Edge mount with 72" power cord. White.	\$606
Cable Management Track 	X-CMT	Cable Management Track Black Plastic <i>Note:</i> Must be ordered with ILINE Wire Tray, below.	\$170
ILINE Wire Tray 	X-IBS-WT-36.F1 (Platinum) X-IBS-WT-36.F2 (White)	ILINE Wire Tray	\$165
Soft Cable Management 	X-FCMT	Soft cable management with zip closure. Light Grey felt fabric.	\$180

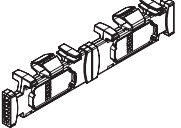

Electrical — Chicago

	SKU	DESCRIPTION	LIST
Chicago Power Box 	IBS-KNX-CHB.F1 (Platinum) IBS-KNX-CHB.F2 (White)	Chicago Box for ILINE application	\$420

Electrical — 3 Circuit/5 Wire

	SKU	DESCRIPTION	LIST	
Power Entry    	X-E3-BF120	Power Entry Base Feed, 120"	\$330	
	X-E3-BF120.SF	San Francisco Base Entry Pack — Power Entry Base Feed, 120"	\$432	
	X-E3-BF120.NYC	New York Base Entry Pack — Power Entry Base Feed, 54"	\$440	
	X-E3-CF	3-Circuit — Power Entry Ceiling Feed, 180"	\$390	
Junction Block 	X-E3-DJCTBLK.1B	3-Circuit — Double Sided Junction Block for ILINE Includes 2 Junction Block Brackets	\$180	
Receptacles 	X-E3-D1.C.G (Grey) X-E3-D1.C.W (White)	3-Circuit - Duplex Receptacle (C), 15Amp, 3D, Line-1	\$46	
	X-E3-D2.C.G (Grey) X-E3-D2.C.W (White)	3-Circuit - Duplex Receptacle (C), 15Amp, 3D, Line-2	\$46	
	X-E3-D2.G.G (Grey) X-E3-D2.G.W (White)	3-Circuit - Duplex Receptacle (G), 15Amp, 3D, Line-2	\$46	
	X-E3-D3.G.G (Grey) X-E3-D3.G.W (White)	3-Circuit - Duplex Receptacle (G), 15Amp, 3D, Line-3	\$46	
	Jumpers / Adapters      	X-E3-J36A	36" Adjustable Jumper	\$131
		X-E3-J42A	42" Adjustable Jumper	\$139
		X-E3-J48A	48" Adjustable Jumper	\$148
		X-E3-J54A	54" Adjustable Jumper	\$156
X-E3-J60A		60" Adjustable Jumper	\$164	
X-E3-J66A		66" Adjustable Jumper	\$172	
Y-Connector 		X-E3-YC	3 Circuit Y-Connector (Box of 1)	\$45

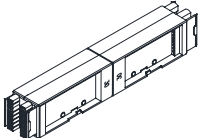
Electrical — 4 Circuit/8 Wire

	SKU	DESCRIPTION	LIST	
Power Entry 	X-E4-BF120	4-Circuit — Power Entry Base Feed, 120"	\$440	
	X-E4-BF120.SF	4-Circuit — San Francisco Base Entry Pack — Power Entry Base Feed, 120"	\$550	
	X-E4-BF120.NYC	4-Circuit — New York City Base Entry Pack — Power Entry Base Feed, 54"	\$525	
	X-E4-CF	4-Circuit — Power Entry Ceiling Feed, 180"	\$475	
Junction Block 	X-E4-DJCTBLK.2B	4-Circuit — Double Sided Junction Block for ILINE Includes Junction Block Bracket.	\$234	
Receptacles 	X-E4-D1.D.G (Grey) X-E4-D1.D.W (White)	4-Circuit-Duplex Receptacle (D), 15Amp, 3D, Line-1.	\$47	
	X-E4-D2.DT.G (Grey) X-E4-D2.DT.W (White)	4-Circuit-Duplex Receptacle (D), 15Amp, 3D, Line-2.	\$47	
	X-E4-D3.D.G (Grey) X-E4-D3.D.W (White)	4-Circuit -Duplex Receptacle (D), 15Amp, 3D, Line-3	\$47	
	X-E4-D4.D.G (Grey) X-E4-D4.D.W (White)	4-Circuit -Duplex Receptacle (D), 15Amp, 3D, Line-4	\$47	
	Jumpers / Adapters 	X-E4-J36A	36" Adjustable Jumper	\$195
		X-E4-J48A	48" Adjustable Jumper	\$225
		X-E4-J60A	60" Adjustable Jumper	\$250
		X-E4-J66A	66" Adjustable Jumper	\$262

ACTIV sit-to-stand bases

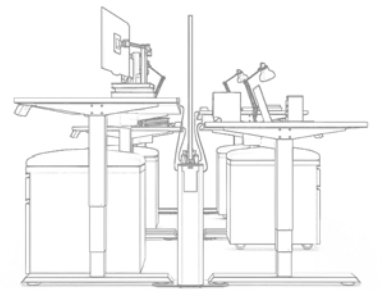

Statement of Line

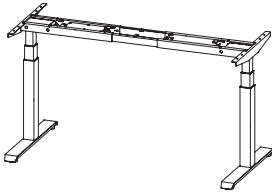

ACTIV-Pro
dual motor, available with 2- or 3-stage
legs in T or C foot style

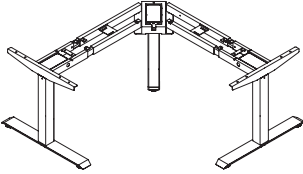

ACTIV-Pro3
3 legs/triple motor
90°/120° configurations

WORKSURFACES

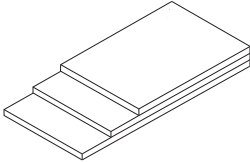

Linear (48", 60", 72")

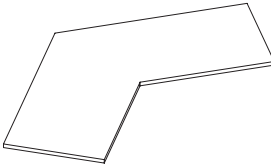

90°/120° (ACTIV-Pro3)

PRIVACY SCREENS

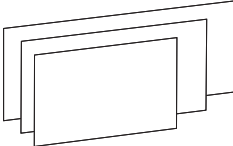

Fabric
height adjustable

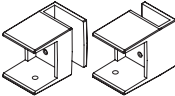

Screen Clips

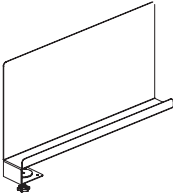

Side Screen

ACCESSORIES

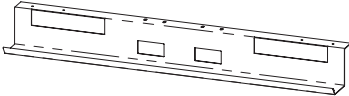

Wire Tray

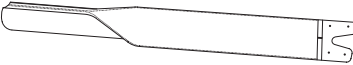

Soft Cable Management

ACTIV-Pro 2 Stage legs



Worksurface Sizes

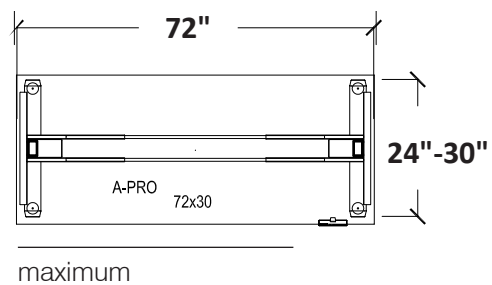
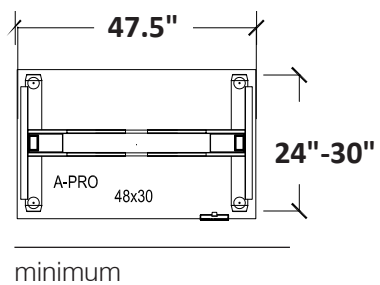

ACTIV-Pro/2-stage legs Specifications

Handset	Push button with 4 programmable settings
Safety	Anti-collision
Foot Length in inches	22" and 28" for 24" and 30" deep worksurfaces
Legs	2 stage, available as T or C Leg
Leg Diameter	2.75" x 2.75"
Height range (excluding top)	27"-46.7"
Frame width expansion	width extendable 48"-72" in 1mm increments
Worksurface widths	48", 60" and 72"
Worksurface depths	24" and 30"
Max lifting capacity	220 lbs
Base weight without top	76 lbs
Gauge of Steel	2mm
Speed	30m/s
Standby Consumption	.2W
Active Consumption	200/360 W
Total Stroke	500 mm
Finishes	Platinum and White
ANSI BIFMA	X5.5
Green Certification	MAS Green
UL	UL962
Warranty	10 years (5 years mechanical parts)

ACTIV-Pro 3 Stage legs



Worksurface Sizes

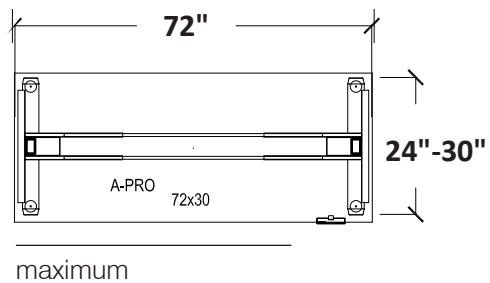
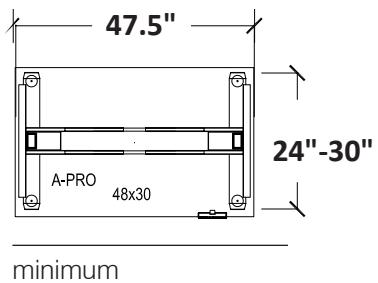

ACTIV-Pro/3-stage legs Specifications

Handset	Push button with 4 programmable settings
Safety	Anti-collision
Foot Length in inches	22" and 28" available for 24" and 30" deep worksurfaces
Legs	3 stage, available as T or C Leg
Leg Diameter	2.75" x 2.75"
Height range (excluding top)	23.5"-49"
Frame width expansion	width extendable 48"-72" in 1mm increments
Worksurface widths	48", 60" and 72"
Worksurface depths	24" and 30"
Max lifting capacity	250 lbs
Base weight without top	76 lbs
Gauge of Steel	2mm
Speed	30m/s
Standby Consumption	.2W
Active Consumption	200/360 W
Total Stroke	650 mm
Finishes	Platinum, White and Black
ANSI BIFMA	X5.5
Green Certification	MAS Green
UL	UL962
Warranty	10 years (5 years mechanical parts)

ACTIV-Pro3



Worksurface Sizes

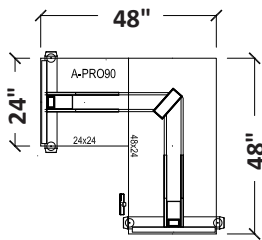

90° — minimum

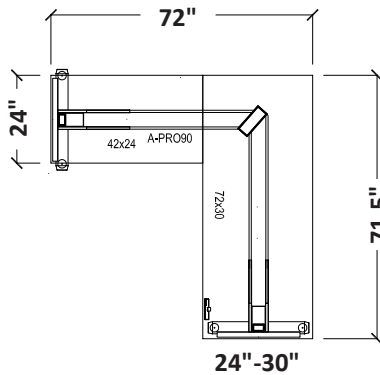

90° — maximum

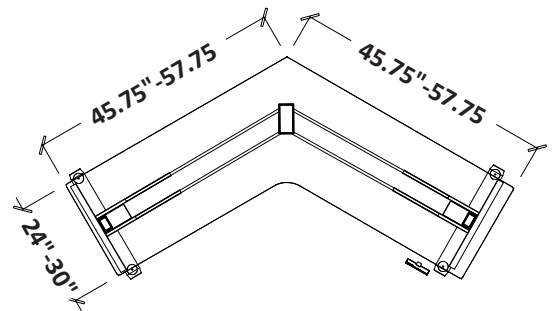

120°

ACTIV-Pro3 Specifications

Handset	Push button with 4 programmable settings
Safety	Anti-collision
Foot Length in inches	22" and 28" available for 24" and 30" deep worksurfaces
Leg Stage	3 stage
Leg Diameter	2.75" x 2.75"
Height range (excluding top)	23.5"-49"
Frame width expansion	120°: 470mm / 90°: 500mm
Worksurface widths	Linear: 48", 60", 72" (see page 90 for 90° and 120° sizes)
Worksurface depths	24" and 30"
Max lifting capacity	300 lbs
Gauge of Steel	Inner/Middle tubes: 2mm / Outer tube 2mm
Base weight without top	113 lbs
Speed	33m/s
Standby Consumption	0.1A
Active Consumption	200/360 W
Total Stroke	650 mm
Finishes	White and Platinum
ANSI BIFMA	X5.5
Green Certification	MAS Green
UL	UL962
Warranty	10 years (5 years mechanical parts)

ACTIV sit-to-stand bases

ACTIV-Pro — 2 Stage Legs

ACTIV-Pro 2 Stage T Legs

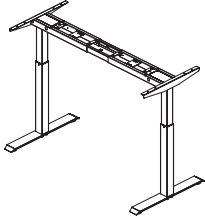

SKU	DESCRIPTION	LIST
	ACTIV-PRO Electric Height Adjustable Base with 2 stage legs. LED display, push button handset, 4 height presets, dual motor, width extendable, 27"H to 46.6"H range (without worksurface).	
AP2-S2-24T.F1 (Platinum) AP2-S2-24T.F2 (White) AP2-S2-24T.F3 (Black)	ACTIV-Pro with T Legs for 24" worksurfaces Feet length 22".	\$1,280
AP2-S2-30T.F1 (Platinum) AP2-S2-30T.F2 (White) AP2-S2-30T.F3 (Black)	ACTIV-Pro with T Legs for 30" worksurfaces Feet length 28".	\$1,280

ACTIV-Pro 2 Stage C Legs

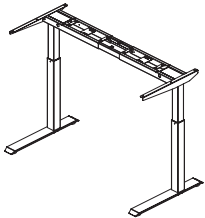

AP2-S2-24C.F1 (Platinum) AP2-S2-24C.F2 (White) AP2-S2-24C.F3 (Black)	ACTIV-Pro with C Legs for 24" worksurfaces Feet length 22".	\$1,280
AP2-S2-30C.F1 (Platinum) AP2-S2-30C.F2 (White) AP2-S2-30C.F3 (Black)	ACTIV-Pro with C Legs for 30" worksurfaces Feet length 28".	\$1,280

ACTIV-Pro — 3 Stage Legs

ACTIV-Pro 3 Stage / T Legs

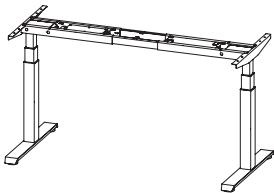

SKU	DESCRIPTION	LIST
	ACTIV-PRO Electric Height Adjustable Base with 3 stage legs. LED display, push button handset, 4 height presets, dual motor, width extendable, 23.5"H to 49"H range (without worksurface).	
AP2-24T.F1 (Platinum) AP2-24T.F2 (White) AP2-24T.F3 (Black)	ACTIV-Pro with T-Legs for 24" worksurfaces Feet length 22".	\$1,460
AP2-30T.F1 (Platinum) AP2-30T.F2 (White) AP2-30T.F3 (Black)	ACTIV-Pro with T-Legs for 30" worksurfaces Feet length 28".	\$1,460

ACTIV-Pro 3 Stage / C Legs

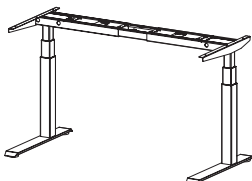

AP2-24C.F1 (Platinum) AP2-24C.F2 (White)	ACTIV-Pro with C-Legs for 24" worksurfaces Feet length 22".	\$1,460
AP2-30C.F1 (Platinum) AP2-30C.F2 (White)	ACTIV-Pro with C-Legs for 30" worksurfaces Feet length 28".	\$1,460

ACTIV-Pro3

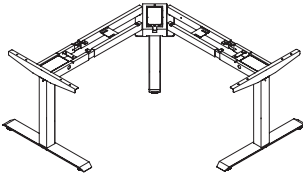
	SKU	DESCRIPTION	LIST
ACTIV-Pro3 		ACTIV-PRO3 — 3 legged, 3 motor Height Adjustable Base. Push button handset with 4 height memory presets, triple motor, width extendable, 23.5"H to 49"H range. Stretcher Bars required for 72"w, sold below.	
	AP3-24T.F1 (Platinum) AP3-24T.F2 (White)	ACTIV-PRO3 for 24" worksurfaces. Feet length 22"	\$2,440
	AP3-30T.F1 (Platinum) AP3-30T.F2 (White)	ACTIV-PRO3 for 30" worksurfaces. Feet length 28".	\$2,440
72" Stretcher Bar for ACTIV-Pro3	AP3-S72.F1 (Platinum) AP3-S72.F2 (White)	72" Stretcher Bar for ACTIV-Pro3 1 box (2 x 72" stretcher bars)	\$130
		Note: 1 box required per side 72"w or larger.	

Worksurfaces — ACTIV-Pro

	SKU	DESCRIPTION	LIST
48" Worksurfaces	X-S4824-W_ _	48x24 Worksurface (47.5"W x 24"D X 1"H)	\$365
	X-S4830-W_ _	48x30 Worksurface (47.5"W x 30"D X 1"H)	\$425
60" Worksurfaces	X-S6024-W_ _	60x24 Worksurface (59.75"W x 24"D X 1"H)	\$455
	X-S6030-W_ _	60x30 Worksurface (59.75"W x 30"D X 1"H)	\$495
72" Worksurfaces	X-S7224-W_ _	72x24 Worksurface (71.5"W x 24"D X 1"H)	\$548
	X-S7230-W_ _	72x30 Worksurface (71.5"W x 30"D X 1"H)	\$595

Worksurface Finishes

Specify at the end of product SKU



White — W2.1



Teak — W2.3



Maple — W2.2
*ships from CA only



Walnut — W2.4

Worksurfaces — ACTIV-Pro3

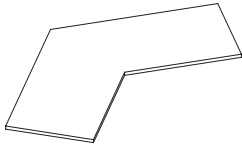
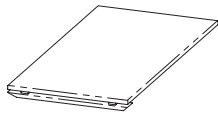

	SKU	DESCRIPTION	LIST
48" Worksurfaces	X-S4824-W_ _	48x24 Worksurface (47.5"W x 24"D X 1"H)	\$365
	X-S4830-W_ _	48x30 Worksurface (47.5"W x 30"D X 1"H)	\$425
60" Worksurfaces	X-S6024-W_ _	60x24 Worksurface (59.75"W x 24"D X 1"H)	\$455
	X-S6030-W_ _	60x30 Worksurface (59.75"W x 30"D X 1"H)	\$495
72" Worksurfaces	X-S7224-W_ _	72x24 Worksurface (71.5"W x 24"D X 1"H)	\$548
	X-S7230-W_ _	72x30 Worksurface (71.5"W x 30"D X 1"H)	\$595
90° Return Worksurfaces	X-R2424-W_ _	24x24 — 90° Worksurface for ACTIV-Pro3 (24"W x 24"D X 1"H)	\$255
	X-R3024-W_ _	30x24 — 90° Worksurface for ACTIV-Pro3 (30"W x 24"D X 1"H)	\$265
	X-R3624-W_ _	36x24 — 90° Worksurface for ACTIV-Pro3 (36"W x 24"D X 1"H)	\$275
	X-R4224-W_ _	42x24 — 90° Worksurface for ACTIV-Pro3 (42"W x 24"D X 1"H)	\$285
	X-R4824-W_ _	48x24 — 90° Worksurface for ACTIV-Pro3 (48"W x 24"D X 1"H)	\$295
120° Worksurfaces 10 day lead time	X-A3-4824-W_ _	(45.75" x 45.75" x 24")	\$1,140
	X-A3-4830-W_ _	(45.75" x 45.75" x 30")	\$1,660

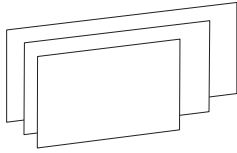
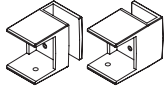
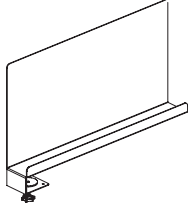

Privacy Screens

	SKU	DESCRIPTION	LIST	
Adjustable Height Fabric Screens 	X-S2-F3824.C1 (Aloe Green) X-S2-F3824.C2 (Varsity Blue) X-S2-F3824.C4 (Nickel Grey)	Screen — Fabric, 38"W x 24"H Requires set of Screen Mounting Clips (sold separately, below).	\$399	
	X-S2-F5024.C1 (Aloe Green) X-S2-F5024.C2 (Varsity Blue) X-S2-F5024.C4 (Nickel Grey)	Screen — Fabric, 50"W x 24"H Requires set of Screen Mounting Clips (sold separately, below).	\$440	
	X-S2-F6224.C1 (Aloe Green) X-S2-F6224.C2 (Varsity Blue) X-S2-F6224.C4 (Nickel Grey)	Screen — Fabric, 62"W x 24"H Requires set of Screen Mounting Clips (sold separately, below).	\$518	
	Screen Mounting Clips 	X-SMC-S.F1 (Platinum) X-SMC-S.F2 (White)	Single Sided Clips for Single Worksurfaces (Set of 2)	\$210
	Side Screen, metal (Left and Right handed) 	Left Handed: X-SS2Lx2.F1 (Platinum) X-SS2Lx2.F2 (White)	Metal Side Screen for 24" and 30" worksurfaces, available in Platinum and White. Slide-on application, rubber mat inset. Knob adjusts to worksurface thicknesses up to 1.5". Box of 2. Specify Right or Left handed. Dimensions: 22.9"D x 3.14"W x 12.2"H	\$550
		Right Handed: X-SS2Rx2.F1 (Platinum) X-SS2Rx2.F2 (White)		

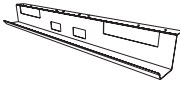
Accessories

	SKU	DESCRIPTION	LIST
Castors 	ACTIV-CASTORS	Castors for ACTIV Bases (Set of 4) Finish: Black	\$240
Wire Trough 	X-E-WT1.F1 (Platinum) X-E-WT1.F2 (White)	Wire Trough, 36"W	\$150
Soft Cable Management 	X-FCMT	Soft cable management with zip closure. Light Grey felt fabric.	\$180

STORAGE

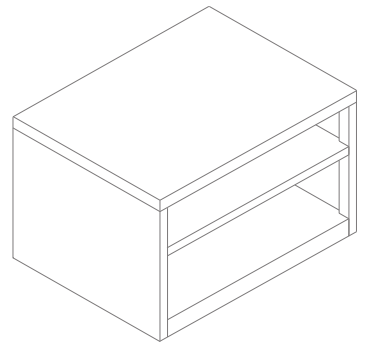

Specifications	98
Storage	99
Storage Accessories	100



SPECIFICATIONS

Powder coated

22 gauge steel

Pedestal has locking castors and 220 lb. seated capacity

Lateral and Book Shelf have 65 lb. storage weight capacity

Lateral and Book Shelf have glides, with 16mm Castors also available

Seat cushions for standard Pedestal in 3 colors and for Slim Pedestal in 1 color

Storage

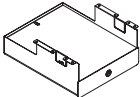
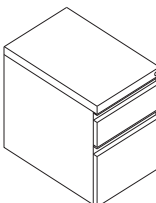
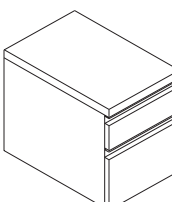
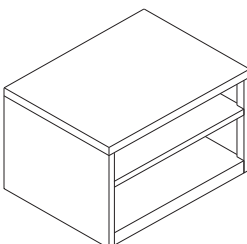
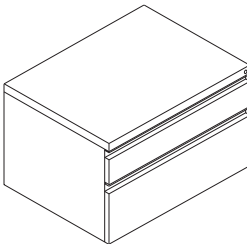
	SKU	DESCRIPTION	LIST
Personal Storage Drawer 	SS-PSD.F1 (Platinum) SS-PSD.F2 (White) SS-PSD.F3 (Black)	Personal storage shelf with locking drawer. 13.25"W x 15"D x 5.9"H	\$360
Slim Mobile Box/File Pedestal (12" wide) 	SS-MMP.F1 (Platinum) SS-MMP.F2 (White) SS-MMP.F3 (Black)	Metal Box/File Pedestal with Top and Castors, 23"D x 12"W. Includes pencil tray, box drawer divider, file hanger, anti-tip counter weight, locking castors, full extension ball bearing glides, and removable lock core. Seat cushion sold next page.	\$525
Mobile Box/File Pedestal (15" wide) 	SS-MBF.TC-P4.F1 (Platinum) SS-MBF.TC-P4.F2 (White)	Metal Box/File Pedestal with Top and Castors, 23"D x 15"W. Includes pencil tray, box drawer divider, file hanger, anti-tip counter weight, locking castors, full extension ball bearing glides, and removable lock core. Seat cushion sold next page.	\$616
1.5H Bookcase 	SS-SS_30-P4.F1 (Platinum) SS-SS_30-P4.F2 (White)	1.5 High Bookcase with glides. 30"W x 18"D x 20.9"H Includes adjustable shelf. Castors available, see next page.	\$725
1.5H Lateral File 	SS-DD_30-P4.F1 (Platinum) SS-DD_30-P4.F2 (White)	1.5 High Lateral File with glides. 30"W x 18"D x 20.9"H Includes 12" Bottom drawer and 4.8" Top drawer. Castors available, see next page.	\$965

Storage Accessories

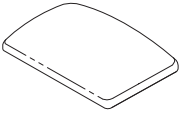
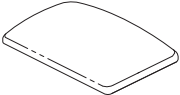
	SKU	DESCRIPTION	LIST
Castors 	SS-Castors	Castors — 60mm Set of four: 2 lock & 2 unlock Finish: Black	\$100
<p><u>Note:</u> Only available for Bookcase and Lateral File (pedestals come with castors).</p>			
Pedestal (15" w) Seat Cushions 	Seat Cushions (23" x 15") SS-C2315.C1 (Aloe Green) SS-C2315.C2 (Varsity Blue) SS-C2315.C3 (Carbon Grey)	23" x 15" seat cushion for Standard Pedestal.	\$232
Slim Pedestal (12" w) Seat Cushions 	Seat Cushions (23" x 12") SS-C2312.C3 (Carbon Grey)	23" x 12" seat cushion for Mini Pedestal. Carbon Grey only.	\$220
Lock Core & Keys	SS-LCK	Lock Core & Keys	\$67
	SS-MK	Master Keys	\$25
	SS-CRK	Core Removal Keys	\$25

ERGONOMOMIC ACCESSORIES

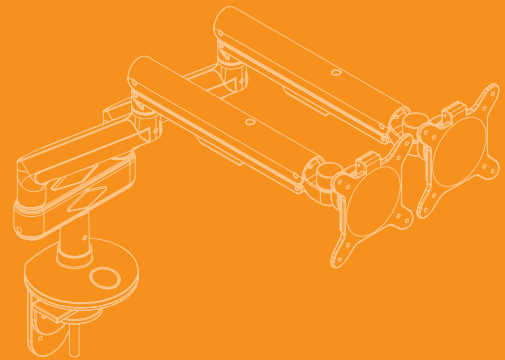

Monitor Arms

	SKU	DESCRIPTION	LIST
<p>Single Monitor Arm</p> 	<p>X-SMA1.F1 (Platinum) X-SMA1.F2 (White)</p>	<p>Articulating monitor arm for single monitor. Clamps onto worksurface with adjustment tension knob.</p>	<p>\$420</p>
<p>Dual Monitor Arm</p> 	<p>X-DMA1.F1 (Platinum) X-DMA1.F2 (White)</p>	<p>Articulating monitor arm for two monitors. Clamps onto worksurface with adjustment tension knob.</p>	<p>\$680</p>

amqsolutions.com



amqsolutions.com