Coalesse Seating/ Occasional Tables Specification Guide

Availability

Electronic price list updated with release 182.A (U.S.) and 147.A (Canada), dated April 20, 2015.

Transitional products in this specification guide are **maintained for existing customers only** and are likely to be phased out over time. These products are indicated with a **†**. Products that are scheduled to be culled are indicated with an **✖**, followed by the last order entry date.

General Information

Locations	2
Warranty	3
Ordering	4
Sustainability	6
SCS Certifications	7
Design Awards	8
Designers	9

Seating/Occasional Tables	13
Lounge Seating	51
Guest/Side/Stack Seating	267
Executive Seating	325
Occasional Tables	337
Indoor/Outdoor Seating	393

Resources	415
------------------	------------

► For a list of all trademarks, refer to the last page of this specification guide.
© 2015 Steelcase Inc.



For Canadian Pricing

Canadian factor can be found at steelcase.com/CADpricing.

Calculate in the following order to avoid rounding errors:

- Multiply the base price and each option by the Canadian factor.
- Round each to the nearest dollar.
- Add base and options for total list price.

Locations



MAIN TELEPHONE 866.645.6952
CUSTOMER SERVICE 1.800.627.6770

Showrooms

- 1 Chicago, IL**
 222 Merchandise Mart, Suite 1032
 Chicago, IL 60654
 TEL 312.467.1783
- 2 Grand Rapids, MI**
 901 44th Street SE
 Grand Rapids, MI 49508
 TEL 616.246.4000
- 3 New York, NY**
 4 Columbus Circle, 7th Floor
 New York, NY 10019
 TEL 212.445.8989
- 4 Los Angeles, CA**
 1217 2nd Street
 Santa Monica, CA 90401
 TEL 310.633.2200
- 5 High Point, NC**
 250 Swathmore Avenue
 High Point, NC 27263
 TEL 336.434.4151
- 6 Mexico**
 Steelcase, Mexico
 Blvd. Manuel Avila Camacho #24
 Piso11, Col. Lamas de Chapultepec
 11000 Mexico D.F., Mexico
 TEL 011.52.555.540.9916

Offices

- 7 San Francisco, CA**
 Coalesse Design Center
 660 Third Street, Suite 100
 San Francisco, CA 94107
 TEL 415.486.6340

This specification guide is published for domestic use only. For export pricing and information concerning the shipment of Coalesse products outside North America, please contact Customer Service. Prices and data subject to change without notice and are shown in U.S. dollars.

Warranty

Warranty

This warranty applies to Coalesse products delivered in the United States, Canada, Mexico, Latin America, and the Caribbean.

Coalesse, a division of Steelcase Inc. ("Coalesse"), warrants that Coalesse, Brayton, Metro and Vecta brand commercial products are free from defects in materials or workmanship, for a period of (10) years, subject to the exceptions listed below. Coalesse will repair or replace with comparable product, at its option and free of charge, any product, part or component manufactured after November 16, 2009 that fails under normal use as a result of such defect. This warranty applies from the date of manufacture, regardless of shift usage and is valid only for the original purchaser.

Exceptions

Lifetime

All interior wood frames

5 years

Stacking chairs, wood veneer, metal chair frames, functional mechanisms such as dollies, carts and trolleys, seating components including controls, adjustment mechanisms, pneumatic cylinders, and tablet arm assemblies. For Emu outdoor frames warranty applies against invasive and perforating rust not deriving from scratches or abrasions due to use and which cannot be removed by normal cleaning and care.

3 years

High wear parts such as casters and glides, stocked fabrics and other stocked covering materials. For all fabrics and leathers (DesignTex, Maharam, Luna, etc) originating manufacturer warranties apply.

2 years

Exposed wood frames.

1 year

Marker boards, electrical components (including task lights, power strips, harnesses, power blocks, outlets, data connectors, audio and video connectors and all tabletop devices), drawer and door mechanisms, keyboard supports, fiberglass panels, replacement parts, granite and glass top surfaces, and outdoor cushions.

Exclusions

This warranty does not apply to product failure resulting from:

- Normal wear and tear
- Failure to apply, install, or maintain products according to published Coalesse instructions and guidelines
- Abuse, misuse, or accident
- Alteration or modification of the product
- The substitution of any unauthorized non-Coalesse components for use in the place of Coalesse components in an integrated product solution; such substitute components include but are not limited to worksurfaces, leg supports, panels, brackets, shelves, overhead bins, and other integral components.

The following products and materials are not covered by this warranty:

- Products considered consumables (e.g. lamps),
- Customer's Own Material (COM) or non-standard textiles and materials
- Variations occurring in surface materials (e.g. color fastness or matching grains, textures, and colors across dissimilar substrates and lots)
- Other manufacturer's products, including Carl Hansen and Emu. Coalesse will pass through other manufacturer's warranties where applicable and to the extent possible.

THIS LIMITED WARRANTY IS THE SOLE REMEDY FOR PRODUCT DEFECT AND NO OTHER EXPRESS OR IMPLIED WARRANTY IS PROVIDED, INCLUDING BUT NOT LIMITED TO ANY IMPLIED WARRANTIES OF MERCHANTABILITY OR FITNESS FOR A PARTICULAR PURPOSE. COALESSE SHALL NOT BE LIABLE FOR CONSEQUENTIAL OR INCIDENTAL DAMAGES ARISING FROM ANY PRODUCT DEFECT.

Ordering

How to Order

Coalesse furniture is available through authorized dealers and retailers. Select products are available for order from our web site. The authorized dealer can help you with everything from surface material selection and order placement, to specialized services, such as space planning and design, delivery and installation. Best of all, they are part of your local community, providing expert advice with a thorough understanding of local needs. For more information and a listing of dealers and retailers, visit www.coalesse.com or call 1.800.627.6770.

Coalesse reserves the right to limit distribution of any or all models.

Credit, Prices, and Terms

Credit may be established upon acceptance of satisfactory references. For payment terms, contact Coalesse's Credit Department. Coalesse may cancel or change credit terms at its discretion and may request advance payment at any time.

The order confirmation will be deemed by the customer and by Coalesse, as the final expression of agreement and will be deemed the exclusive statement of terms. The order confirmation supersedes all prior writings and may not be modified or rescinded, except by a revised Coalesse order confirmation signed by the customer. No changes are binding on Coalesse until delivery of the order confirmation. Any storage charges and applicable sales taxes are in addition to the prices shown for merchandise. Inside delivery, uncartoning and installation are customer's responsibility unless separately quoted. All list pricing shown includes freight prepaid to one destination for delivery in the 48 contiguous United States. Hawaii and Alaska are not included. We reserve the right to increase prices without notice due to increases in labor and material costs. If timely payment is not made, customer is liable for reasonable collection costs, including attorney's fees.

Shipping and Storage

Coalesse reserves the right to select carrier and packaging method. Partial shipments may be delivered. Coalesse is not liable for delays or delivery failure due to strikes, lockouts, labor, or transportation difficulties, failure or delay of supply sources, accidents, fire, acts of God, or any other cause of like or unlike nature beyond Coalesse's control. Coalesse may transfer merchandise to storage if not accepted when shipment scheduled. Transfer and storage charges will be the customer's expense. Coalesse's invoice is payable upon transfer. If transfer is made prior to confirmed shipping date, storage expenses will be borne by customer.

Shipping charges MAY be calculated per order. Lead times vary by product. Coalesse reserves the right to select carrier. Partial shipments may be delivered. Coalesse will make every effort to provide current and accurate lead time information, however, Coalesse is not liable for delays or delivery failure due to strikes, lockouts, labor, or transportation difficulties, failure or delay of supply sources, accidents, fire, acts of God, or any other cause of like or unlike nature beyond Coalesse's control.

Freight is included on domestically manufactured products within the 48 contiguous states of the United States and standard freight service of Carl Hansen & Son and Emu.

Claims

Merchandise shipped from Coalesse is thoroughly inspected and properly packed before leaving the factory. Responsibility of its safe delivery is assumed by the carrier at the time of shipment. Customer must match the freight delivered with the bill of lading. Customer must examine packaging material upon delivery and note any damage on the carrier bill of lading. If there is damage to the packaging material, inspect the furniture immediately. If concealed damage is found, contact the carrier within 10 days of delivery date. Save all packaging materials until after inspection.

Freight damage and claims must be reported by the purchaser to the carrier. Coalesse is not responsible for freight claims. Claims for loss or damage must not be deducted from our invoice, nor payment withheld awaiting adjustment of such claims. Do not return any merchandise to Coalesse without a Return Authorization number. By following these procedures carefully, Coalesse guarantees our full support of your claims to protect you against loss or damages. All claims against Coalesse for defects, errors or shortages must be made by customer in writing within ten (10) days after delivery. Failure to make claims within ten (10) days constitutes acceptance of merchandise and waives claims. Cutting of textiles deems acceptance of yardage and waives all defects, errors, and shortages. Coalesse is not liable for subsequent damages.

Special/Custom Products

Coalesse prides itself on being responsive to our customer's needs. Contact our customer service team at 1.800.627.6770 to discuss a special opportunity. Due to product modifications and engineering time, special orders may not be cancelled. Charges will apply.

FOR MORE INFORMATION (on ordering our products) Please contact Coalesse Customer Service at: 1.800.627.6770 .

Ordering

Order Cancellations/ Changes

All order change/cancellation requests must be submitted using the Coalesse order change/cancellation request form. Late changes could jeopardize the committed delivery of an order.

Coalesse Rapid10 programs no change or cancellations allowed.

Coalesse Products:

- No charges will be assessed for change or cancellation 14 or more calendar days prior to the manufacturing completion date (excludes holidays and/or large quantity project size orders). For import products, charges may apply.

- No manufacturing changes are allowed 0-13 calendar days prior to the manufacturing completion date. Simple changes including shipping address changes are subject to approval but will be accommodated when possible.

- No cancellations or product changes will be accepted for quick ship or special/custom product orders including special laminates. A cancellation fee will be applicable for any custom product and/or change may jeopardize lead time.

- If COM/COL has been received at time of change or cancellation, it is the dealer's responsibility to advise disposition or return of materials. Coalesse will not store materials after 30 days.

Additional Charges

- Changes or cancellations that involve any of the following may be subject to a charge earlier and/or greater than shown above: Special engineering product, CSM, pre-ordered components, materials with extended lead times (e.g., veneers, special paint, etc.) or large quantities of standard materials.

- Use our Order Change/Cancellation Request Form for all order changes. It is Coalesse responsibility to accurately process change order requests. It is the dealer's responsibility to verify that we have accurately interpreted your change requests by checking the acknowledgement after the change has been made. If you do not use the web-based change order form process and an error occurs during our translation which cannot be corrected prior to ship, all costs will be shared on a 50/50 basis. Changing ship dates or adding product to your order is subject to the availability of manufacturing capacity.

- Cartoning changes and shipping address changes are subject to approval and to a change charge. Please consult your Customer Service for specific information pertaining to your order.

Reserved Fabric Policy

Prior to order receipt, reserving textiles (COM/COL, Maharam, Designtex, and select Luna Graded-In) is the responsibility of the dealer. Coalesse cannot reserve textiles based on projected orders. Coalesse cannot guarantee Maharam or Designtex fabric availability. If dealer reserves Maharam or Designtex textiles, Coalesse will require the reserve number and zip code for locating purposes when ordering.

Schedule Enhancements

Coalesse will entertain schedule enhancements on a case-by-case basis; however, please understand that we must receive complete information such as installation date, opening date etc...to make informed scheduling decisions.

No order move-ups or move-outs are allowed on any order that falls within the 15-working day period of its manufacturing completion date. If it is within the 15-working day period, Coalesse will invoice at shipment but may offer storage options at a charge for manufactured product.

Sustainability

As our understanding of sustainability evolves in the contract furniture business, Coalesse is being launched on three important fronts: responsibly harvested woods, better ways of plating metal, and manufacturing for the highest level of durability. To ensure all new products are socially responsible, we have engaged the "cradle-to-cradle" design consultancy, MBDC, to advise us and provide third-party analysis of the materials and processes we use to create our products. As Coalesse grows, social responsibility will be an essential part of our decision-making, from design to disposal. We believe that our success on the environmental front will be built on the accumulation of a multitude of small steps and the occasional big leap. We are starting with a green outlook and we have every intention of growing greener.

WOODS: FSC CERTIFICATION

Our policy with wood sourced from outside North America and our approved European partners is that they must be certified by The Forestry Stewardship Council (FSC) to ensure these woods have been responsibly harvested from sustainable forests, and that the rights and welfare of workers and local communities are being respected. Through an FSC label, wood can be traced back to its original source of supply.

Our Geneva, NY manufacturing location has chain of custody certification for working with FSC certified woods.

CHROME: A NEW ALTERNATIVE TO METAL

Chromed steel is a mainstay of the contract furniture industry because it is considered a premium finish with high durability. But depending on the type of chrome processing used, it can have a detrimental impact on human and environmental health. The most common method of chrome plating uses hexavalent chrome, a known carcinogen and considered by MBDC in their color-coded rating system (green, yellow, red), to be a "hard-red" chemical. There are no health hazards associated with chrome once it has been applied, but the hexavalent chrome electroplating process can be hazardous.

Is there an alternative? Coalesse is opting for a safer method of plating and has partnered with a domestic supplier who uses only "trivalent" chrome, a non-carcinogenic form of the metal. Few, if any, metal finishing processes are without environmental challenges, and chrome is no exception. Working with the best technology currently available, we will continue to seek new and better alternatives.

BUILDING TO LAST

Building longevity into products is an important sustainability strategy. A chair or table that lasts for 50 or 100 years or more will not have to be replaced, saving the materials and finishes and embodied energy from being duplicated in another form. Coalesse is quality furniture designed to outlast its buyers. We hold up Hans Wegner designs as the model of longevity—pieces manufactured a generation ago are still prized possessions today. Our hope is that every piece in our collection appreciates in value over the years, so it will be passed on.

ONGOING AUDITS

As the Coalesse collection grows, our intention is to live by the cradle-to-cradle (C2C) philosophy described by MBDC this way: "Instead of designing cradle-to-grave products, dumped in landfills at the end of their 'life,' the goal is create products for cradle-to-cradle cycles, whose materials are perpetually circulated in closed loops. Maintaining materials in closed loops maximizes material value without damaging ecosystems." Coalesse has contracted MBDC to audit the materials used in the majority of our existing products, and to advise us as we develop new products. We intend to achieve Cradle to Cradle certification on the highest percentage of products possible. As Coalesse grows, social responsibility will be an essential part of our decision-making, from design to disposal. We believe that our success on the environmental front will be built on the accumulation of a multitude of small steps and the occasional big leap. We are starting with a green outlook and we have every intention of growing greener.

SCS Certifications

Consolidated List, as of November, 2009

Seating

Guest

- Kart Café
- Kart Stack
- Enea (All models)
- Last Minute Stool
- Lottus
- Bindu

SCS Indoor Advantage Gold Indoor Air Quality Certified to SCS-EC10.2-2007
Conforms to ANSI/BIFMA Furniture Emissions Standard (M7.1/X7.1-2007) for the open plan and private office scenarios: California Specification 01350 for the open plan and school classroom scenarios and BIFMA e3-2008 (Credit 7.6.1 and 7.6.2) for the open plan and private office scenarios. Registration: SCS-IAQ-01822

Guest - Wood

- Capa
- Switch Guest
- Wrapp

SCS Indoor Advantage Gold Indoor Air Quality Certified to SCS-EC10.2-2007
Conforms to ANSI/BIFMA Furniture Emissions Standard (M7.1/X7.1-2007) for the open plan and private office scenarios: California Specification 01350 for the open plan scenario and BIFMA e3-2008 (Credit 7.6.1 and 7.6.2) for the open plan and private office scenarios. Registration: SCS-IAQ-02305

Stack Seating

- Kathryn

SCS Indoor Advantage Indoor Air Quality Certified to SCS-EC10.2-2007
Conforms to ANSI/BIFMA Furniture Emissions Standard (M7.1/X7.1-2007) and BIFMA e3-2008 (Credit 7.6.1 and 7.6.2) for the open plan and private office scenarios. Registration: SCS-IAQ-01823

Executive - Task

- Bob
- Chord
- Bindu
- La Costa
- Rocky (all models)

SCS Indoor Advantage Gold Indoor Air Quality Certified to SCS-EC10.2-2007
Conforms to ANSI/BIFMA Furniture Emissions Standard (M7.1/X7.1-2007) for the open plan and private office scenarios: California Specification 01350 for the open plan and school classroom scenarios and BIFMA e3-2008 (Credit 7.6.1 and 7.6.2) for the open plan and private office scenarios. Registration: SCS-IAQ-01824

Lounge (Gold)

- Astor
- Await
- Circa
- Coupe
- Davos
- Evaneau
- Holy Day
- Joel
- Ripple
- Sidewalk (includes mobile)
- Stilleto
- Swathmore (includes Grande and Grande Mobile)
- Switch chair
- Switch lounge
- Thoughtful
- Together

SCS Indoor Advantage Gold Indoor Air Quality Certified to SCS-EC10.2-2007
Conforms to ANSI/BIFMA Furniture Emissions Standard (M7.1/X7.1-2007) for the open plan and private office scenarios: California Specification 01350 for the open plan and school classroom scenarios and BIFMA e3-2008 (Credit 7.6.1 and 7.6.2) for the open plan and private office scenarios. Registration: SCS-IAQ-01820

Lounge

- Archipelago
- Bix
- Detour
- Passerelle
- Topo

SCS Indoor Advantage Indoor Air Quality Certified to SCS-EC10.2-2007
Conforms to ANSI/BIFMA Furniture Emissions Standard (M7.1/X7.1-2007) and BIFMA e3-2008 (Credit 7.6.1) for the open plan and private office scenarios. Registration: SCS-IAQ-01820

Tables

- Akira
- Au Lait
- Ballet
- Derby
- Disc
- E-table
- Ginkgo Biloba
- Juice
- Reunion
- Rizzi Arc
- Runner (including TR)
- Teamwork Auxiliary Table
- Train

SCS Indoor Advantage Indoor Air Quality Certified to SCS-EC10.2-2007
Conforms to ANSI/BIFMA Furniture Emissions Standard (M7.1/X7.1-2007) and BIFMA e3-2008 (Credit 7.6.1) for the private office scenario only. Registration: SCS-IAQ-02272

Tables (Excludes Wood or Wood Veneer, for laminates only):

- Akira
- Arriva
- Au Lait
- Ballet
- Derby
- E-table
- Ginkgo Biloba
- Juice
- Reunion
- Rizzi Arc
- Runner (including TR)
- Teamwork Auxiliary Table
- Train

SCS Indoor Advantage Gold Indoor Air Quality Certified to SCS-EC10.2-2007
Conforms to ANSI/BIFMA Furniture Emissions Standard (M7.1/X7.1-2007) for the open plan and private office scenario. Also conforms to BIFMA e3-2008 (Credit 7.6.2) for the private office scenario only. Registration: SCS-IAQ-01844

Systems Furniture

(Includes all wood options except wood fronts on storage for the open plan scenario)
Teamwork Tables, Storage Carts, Mobile Easel and Wall Mounted Markerboards, Detour Mobile Desk, Café Tables, Moped and Stations.

SCS Indoor Advantage Indoor Air Quality Certified to SCS-EC10.2-2007
Conforms to ANSI/BIFMA Furniture Emissions Standard (M7.1/X7.1-2007) for the open plan and private office scenarios. Also conforms to BIFMA e3-2008 (Credit 7.6.1) for the open plan and private office scenario. Registration: SCS-IAQ-01844

Casegoods

- Denizen

SCS Indoor Advantage Indoor Air Quality Certified to SCS-EC10.2-2007
Conforms to ANSI/BIFMA Furniture Emissions Standard (M7.1/X7.1-2007) for the private office scenario only and BIFMA e3-2008 (Credit 7.6.1) for the private office scenario only. Registration: SCS-IAQ-01842

Design Awards Since 1991

2013 Best of Neocon, Bench, Gold Award	Lagunitas
2013 IF Design Award	Hosu
2013 Red Dot Design Award – Product Design	Hosu
2012 Editor's Choice	Free Stand
2012 Innovation Award	Free Stand
2012 Silver Award	Free Stand
2011 Best of NeoCon Gold	Sebastopol
2011 Best of NeoCon Silver	CG_1
2010 Best of NeoCon Innovation	SW_1
2009 IDEA Bronze Award	Akira
2009 Best of NeoCon Gold	Denizen
2009 Best of NeoCon Silver	Emu Heaven
2008 Good Design Award	Holy Day
2007 Best of NeoCon Gold and Silver	Akira
2006 Good Design Award	Await
2006 Best of NeoCon Gold, Roscoe Merit Award	X-Stack
2005 Adex Platinum	Calm
2005 Adex Platinum	Ripple
2005 Best of NeoCon Silver	Rocky
2005 Adex Silver	Thoughtful
2005 Good Design Award, Adex Platinum, ID Magazine - Design Distinction	Topo
2004 Adex Gold	Bix Expansion
2004 Best of NeoCon Gold	Calm
2004 Good Design Award	Ripple
2004 Best of NeoCon, Best of Competition Gold	Topo
2003 Best of NeoCon Gold	Au Lait
2004 Best of NeoCon Gold, Bronze - Arido Award of Excellence	Bix Expansion
2002 Silver - Arido Award of Excellence	Bix
2002 Best of NeoCon Gold	Kart Café
2002 Best of NeoCon Silver	E-Table
2001 Best of NeoCon Gold, Silver, and most Innovative	Bix
2000 Best of NeoCon Gold	Diekman Tables
2000 Best of NeoCon Gold, Best of NeoCon Editor's Choice	Sidewalk
2000 Best of NeoCon Silver	TeamWork
2000 Best of NeoCon Gold	Train
2000 Adex Platinum	TX
1999 Best of NeoCon Silver, Adex Award	Detour

1999 Best of NeoCon Gold and Most Innovative, IDSA Design of the Decade, IDEA Gold Award, Apex Award, Acclaim Award, Office Insight	Kart
1998 Best of NeoCon Gold and Most Innovative, IDSA Design of the Decade, IDEA Gold Award, Apex Award, Acclaim Award, Office Insight-Most Excellent	Kart
1998 Best of NeoCon Silver	Switch Lounge
1997 IIDA Charles Gelber Award	Reunion
1996 Apex Award	Reunion
1995 Best of NeoCon Gold	Runner
1995 Apex Award	TeamWork
1994 Charles Gelber Award, Apex Award	Reunion
1994 Best of NeoCon Gold	Rizzi Arc
1994 Best of NeoCon - Best of Competition and Gold	Template
1993 IBD Bronze	TeamWork
1992 IBD Best of	Ballet Pedestal
1992 IBD Bronze and Acclaim Award	Evaneau
1991 Roscoe Award, Acclaim Award Best of Show	Ballet

Designers

EOOS - Austria

Together

The Austrian-based EOOS was founded in 1995 by Martin Bergmann, Harald Gründl, and Gernot Bohmann, three graduates of the Academy of Applied Arts in Vienna. The partners collaborate on all projects, specializing in the design of furniture, consumer products, and architectural spaces, particularly flagship retail stores. Customers include celebrated names such as Armani, Adidas, Moroso, A1/Vodafone, Matteograssi, Walter Knoll, Keilhauer, Duravit and Zumtobel Staff.

EOOS relies heavily on research and a design process they refer to as "poetic analysis." The partners seek words, sentences, or images that evoke concepts "deeply rooted in mankind."

Says Martin Bergmann: "Our work is not one-dimensional, nor is it based on a direct process that leads from a specific customer requirement to our design. We actually research the context of the customer's brand. What is it derived from? How did the brand myth come about? What does the brand stand for? Our approach frequently enables us to illuminate a previously undiscovered dimension of the customer."

Jeffrey Bennett - USA

Davos Chair & Benches

Jeffrey Bennett, who founded his renowned Studio B in 1995, presented his first collection of furniture and accessories, entitled "Ideas for Production," at the May 1996 International Contemporary Furniture Fair (ICFF) in New York City. The designs won the Editor's Award for "Best Decorative Accessories." At the ICFF in May of 2000, Bennett, along with five other designers, was named "Best New Designer" for work with the U.S. manufacturer, Dune.

Highly versatile, Bennett works in interior architecture, furniture, household products, lighting, fashion accessories, graphic design/corporate image and art direction. He is the first American designer to be hired by a number of major European companies. Recent clients include Authentics, Viccarbe, B&B Italia, Boffi, Cappellini, Dune, Estée Lauder, Hidde/sdb, Michael Kors (LVMH), Ligne Roset, and Troy.

His work has been featured in Abitare, Casa Abitare, Design Diffusion News, Domus, Elle Decor, House & Garden, Interni, Intramuros, Metropolitan Home, The New York Times, Ottagono, and the books "50 Products" and "50 Beds."

In 1995, Bennett founded Consultants for Design Strategy. In collaboration with Nicholas Dodziuk, he consults on custom furnishings and fixtures for clients such as Northwest Airlines, Michael Kors, and Samsonite.

Bennett's explanation of why he designs (Interior Design magazine, December, 2003): "I'm very mechanically inclined, which includes an affinity for and curiosity about machines, industrial process, and materials. I was born with the benefit of being a good three-dimensional thinker, as well as studying a fair bit of business at university. Design was the perfect profession—culture for commerce."

PearsonLloyd - UK

Bob and Lox

Tom Lloyd and Luke Pearson met while studying at England's Royal College of Art in the early 1990's. The London-based PearsonLloyd studio was founded in 1997 based on their shared desire to combine furniture and product design. They work a number of design disciplines, including furniture, consumer products, transport, and the public realm.

The designers have written that their "desire is to produce compelling solutions that are intelligent, appropriate and timeless, and contribute to what for us, is the still embryonic craft of industrial design."

PearsonLloyd's work includes: Virgin Atlantic Airway's Upper Class Suite (2003); a range of walk-in showers for Ideal Standard (2005); a street lighting system by Artemide for The City of Westminster (2004); bus shelters and way-finding system for Sheffield City (2007); and numerous furniture projects for Walter Knoll, Bernhardt Design, Kokuyo, Tacchini, and Allermuir. The studio was selected from over 150 companies to be one of four designated product design consultancies for Transport for London (TFL) until 2009.

Jean-Marie - Massaud-France

Holy Day Lounge & Tables, Emu Heaven, Massaud

In 2000, Jean-Marie Massaud formed Studio Massaud with Daniel Pouzet. Together, they have designed the Tanabé House (Fukuoka, Japan), Renault's displays at international motor shows, the Modern Object concept store (Columbus, Ohio), the HIP spa (Nice, France), and the brand and architectural image of Lancôme (cosmetics) and Poltrona Frau (furniture) worldwide. Studio Massaud is also working on a 50,000-seat football stadium and two condominium towers (Guadalajara, Mexico), luxury hotel (Paris, France), and a condominium building (Tribeca, New York).

A graduate of Les Ateliers, Ecole Nationale Supérieure de Création Industrielle, Massaud's work, while "humanistic," is rooted in the applied sciences and clearly influenced by his training as an engineer.

Victor Carrasco, General Manager of Viccarbe, says of Massaud: "His unmistakable "Human Nature Style" has allowed him to become, in few years, one of the top designers at international level.

"Who other than Massaud," says Carrasco, "would be able to reinterpret Mies Van Der Rohe in such an elegant and sophisticated way? Only someone with a special sensitivity can develop a landmark collection like Holy Day. It is already a great international bestseller and part of the contemporary history of design."

Massaud's furniture designs are displayed in design museums in Amsterdam, Chicago, London, Lisbonne, Paris, and Zurich.

Marc Krusin

Wrapp Chair

One of Europe's brightest young designers, Marc Krusin is veteran of the Milan-based group Codice 31, which he founded in 1998 with five other designers. He now directs the design team of the prestigious Milanese design firm, Piero Lissoni, overseeing projects for international clients such as Alessi, Kartell, Flos, Thonet, and Wella.

Much of Krusin's own work is done through Klay, a firm he opened in 2004, specializing in "objects of natural materials influenced by world cultures." Cross-cultural influences run throughout his practice.

He has designed for Fontana Arte, Liv'it, Pallucco, Saporiti, Bosa ceramiche, Merten, Omnidector, Glas Italia, and the Spanish furniture firm, Viccarbe. Viccarbe's General Manager, Victor Carrasco, describes Krusin as "a great talent at a very young age."

Krusin was recently honored in the 2008 "Europe 40 Under 40," an annual program co-sponsored by The European Centre for Architecture Art Design and Urban Studies and The Chicago Athenaeum: Museum of Architecture and Design. According to the program directors, Krusin is one of the "next generation of innovative architects and designers who will impact future living and working environments, cities, and rural areas."

Designers *continued*

Patricia Urquiola - Spain

Last Minute Stool, Emu Retrouvé, and Hosu

Patricia Urquiola began training as a student in architecture at Facultad de Arquitectura de Madri before graduating in design from Politecnico di Milano in 1989, where she studied under Achille Castiglione.

In 1991, as head of the product development team at De Padova, Urquiola designed her first commercial furniture pieces (in collaboration with Vico Magistretti). They were highly imaginative yet functionally pragmatic, an appealing combination that has defined her work since.

From 1993 to 1996, Urquiola owned a studio with two friends, accepting commissions in architecture, interiors, showrooms, and restaurants. From 1996 to 2000 she managed the design group Lissoni Associati, then opened her own studio in Milan, focusing on product design, displays, and architecture.

Best known for her many designs for Moroso, Urquiola has also worked for De Padova, Agape, B&B, Alessi, Driade, Foscarini, Kartell, Flos, Molteni, and Artelano among other well-known furniture houses. She has won numerous design awards and is sought after as a speaker at conferences and universities.

Hans J. Wegner - Denmark

Carl Hansen & Son

Hans J. Wegner is one of the 20th century's most important furniture designers. A leader of the Danish Modern style, Wegner is revered for his iconic chairs with their organic beauty and ample comfort. His understanding of wood joinery was unsurpassed, his views on quality uncompromising. Wegner balanced form and function brilliantly.

Carl Hansen & Son, the Danish furniture maker, began working with Wegner in 1949. Among his first designs for the company were the legendary Wishbone Chair (CH24) and several other designs that are still produced today.

During his long career, Wegner designed more than 500 chairs. He almost singularly brought the chair out of its hiding place as "part of a furniture set" and into its own as modern sculpture. He broke new ground by combining natural materials in imaginative ways, always testing the limits of craftsmanship and serial production.

Wegner was demanding and difficult to satisfy, often taking weeks to get the results he wanted from his craftspeople. But he was also limitlessly curious, often playful, and always elegant. "We must take care," he said, "that everything doesn't get so dreadfully serious. We must play - but we must play seriously."

While Wegner was awarded practically every honor possible for a furniture designer, and his chairs are featured in museums around the world, his design is accessible. He believed that chairs were made for sitting. Ergonomics and usability had a central role in his thinking before those words ever entered the mainstream.

Hans J. Wegner died in Denmark in January, 2007.

Brian Kane - USA

Bindu

Brian Kane graduated from the University of Bridgeport, Connecticut, in 1970 with a Bachelor of Science degree in Industrial Design. He worked for several New York City design studios and spent a year in Milan, Italy, working for Architect Silvio Coppola. His projects included the design of seating and case-goods for such companies as Mobil Italia Spa. and Bernini Spa.

After returning to the U.S., he worked in New York for Atelier International (A.I.). Work involved special contract furniture design projects, showroom design, and the startup of U.S. production of Italian designs by Cassina, B&B, and Tecno.

Kane joined the design staff at Metropolitan Furniture Corporation (Coalesse) in January, 1977. Less than three years later, he became one of four partners assuming ownership of the firm, and took on the responsibilities of Vice President of Design and Product Development.

In 1987, Metropolitan was acquired by Steelcase. For the next two years, Kane maintained his position as Vice President and was responsible for all aspects of Coalesse's design, including products, showrooms, and graphics.

In March of 1989, Kane established Kane Design Studio in San Francisco.

Kane's designs have won over 80 design awards and have been exhibited at the Whitney and Brooklyn Museums in New York and the Museum of Modern Art in San Francisco.

WilliamsSorel - USA

Denizen

WilliamsSorel is a California-based design studio established by Otto Williams and Jess Sorel in 2007. Prior to launching their own firm, Otto and Jess were the creative force behind Coalesse, by Steelcase. Their designs for Coalesse won more than 20 awards, most notably for Bix, which defied conventional office furniture categories. During their tenure at Coalesse, Otto and Jess developed a passion and reputation for exploring the boundaries between work and life in an effort to humanize the modern workplace.

The designers have said "we are thinking less about categorizing office furniture and residential furniture, and thinking more about the experiences of working and living in spaces, and the artifacts you need to support both narratives simultaneously. There's really a move to allow furniture to be furniture again, as opposed to equipment. In a sense, the office is being dismantled."

Together they hold numerous design and utility patents and their work has been published in Abitare, Azure, Contract, Fast Company, I.D. Magazine, Interior Design, and Metropolis. Otto holds a BFA in Industrial Design from Rhode Island School of Design. Jess holds a BFA in Industrial Design from The California College of the Arts.

Scott Wilson & MINIMAL - USA

SW_1 Collection, Power Pod

In 2007, Scott Wilson founded Chicago-based MINIMAL, a studio whose diverse work spans industries ranging from technology, interaction, and consumer products to fashion, furniture and environments. A former Global Creative Director at Nike, Wilson has led design organizations such as IDEO, Thomson Consumer Electronics, Fortune Brands, and Motorola and created some of the most recognized consumer design icons.

Currently partnering with top Fortune 500 companies such as Google, Dell, Microsoft, Nike, and Xbox as well as exciting start-ups, MINIMAL is working on the some of the most anticipated new devices and experiences in the industry. Balancing consulting for design-centric brands with his intense passion for self-manufacturing and entrepreneurial ventures, Wilson is constantly looking for the next consumer connection. In January of 2010 he successfully incubated, developed, raised funding, and launched a revolutionary new customization platform brand, Uncommon, which took the existing industry giants by surprise.

One of the most respected hands-on designers in the industry, Wilson has the elusive ability to consistently deliver products to market that speak rationally and emotionally to the consumer, ultimately ensuring a higher probability of market success and endurance.

His work has been exhibited in museums and competitions including the Cooper-Hewitt National Design Triennial, MoMA, MCA, and Chicago Athenaeum and has been recognized with over 50 international design awards in the last decade including ID Magazine's Top 40, FastCompany's Master of Design, and TIME Magazine's Style+Design 100.

Designers

Lievore Altherr Molina

Enea Lottus

Lievore Altherr Molina was created in 1991 by the merging of its three partners: Alberto Lievore, Jeannette Altherr, and Manel Molina. Since its founding, the studio has been devoted to product design, consulting, and the art direction of various companies, always offering individualized solutions.

Throughout the years the studio has been recognized for its furniture design, its interior design projects, its products, and packaging. Simultaneously, the studio has developed an intense teaching practice, giving seminars, and training courses to new professionals at various Spanish universities and other organizations.

The studio has been awarded many national and international awards, including Spain's National Design Award in 1999. Lievore Altherr Molina has exhibited their work in Barcelona, Cologne, Chicago, Stockholm, Helsinki, Lisbon, London, Louisiana, Madrid, Malmö, Milan, New York, Paris, and Tokyo. Their ideas and projects are regularly published in the most prestigious design magazines around the world.

Coalesse is excited to introduce the Enea Lottus collection, designed by Lievore Altherr Molina. The Lottus collection of stacking chairs, stools, and tables offers a simple, clean aesthetic to most live/work settings. Easy to store, easy to clean, and user-friendly, the Enea Lottus collection is a logical solution for any environment.

Steven Copeland

Free Stand

Steven Copeland is an industrial designer known for crafting mobility. "I'm looking for new products that free up people's physical aspirations and enable intuitive expression... constructions that gel with the amazing human body and celebrate agility."

Born in 1960 in Montreal, Copeland's kinetic approach to design began as a child making toys and bicycles. Today his professional work is defined by an interactive quality, the way toys are defined by the play they inspire.

With a client list of elite manufacturers in the U.S. and Europe, Copeland has won several of the industry's top awards and has been widely published and exhibited for design innovation. Best known for a groundbreaking collection of lighting with Flos, Steelcase, Knoll, and Luxo, Copeland has built a reputation for creative problem-solving that led to collaborations with NASA and M.I.T., and to work with Rhode Island School of Design and the University of the Arts in Philadelphia, P.A. He has also pioneered new levels of performance in computer ergonomics and disabled cycling.

Toan Nguyen

Lagunitas

Toan Nguyen was born in Paris in 1969 and graduated in Industrial Design at ENSCI-Les Ateliers in Paris, in 1995.

After experiences in several design studios in Paris, Barcelona, and Milan and notably ten years of collaboration with Antonio Citterio as design director and design partner, signing products for many brands such as Axor-Hansgrohe, B&B Italia, Flos, Fusital, Guzzini, Iittala, Kartell, Metalco, Skantherm, Technogym, or Vitra, Toan Nguyen founded his own design studio based in Milan in 2008.

Toan Nguyen Studio is a multidisciplinary Atelier focused on design development in many different design fields, from furniture to technological products, in partnership with leading international companies based in Germany, Italy, Spain, Switzerland, and USA such as Accademia, Dedon, Fendi Casa, Laufen, Lema, Moroso, Urmet Group, Varaschin, Viccarbe, and Walter Knoll.

The Bellows Collection designed for Walter Knoll has won a Red Dot Design Award in 2010 and Antero, designed for Laufen, has obtained the Red Dot Design Award 2012.

Seating/Occasional Tables

Statement of Line 14

Lounge Seating	51
Guest/Side/Stack Seating	267
Executive Seating	325
Occasional Tables	337
Indoor/Outdoor	393

Statement of Line

Lounge Seating

Archipelago Lounge

Understanding
▶ Page 52
Specifying
▶ Page 56

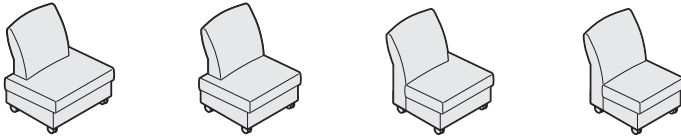

Archipelago Arms and Tablet Arms

Understanding
▶ Page 52
Specifying
▶ Page 57

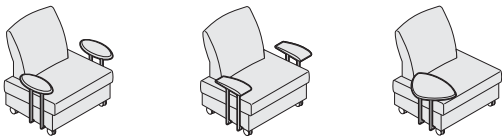

Archipelago Ottoman

Understanding
▶ Page 52
Specifying
▶ Page 58



Astor

Specifying
▶ Page 62

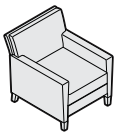

Chair

Await Modular Seating

Specifying
▶ Page 64

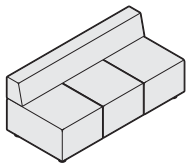

Three-seat Sofa

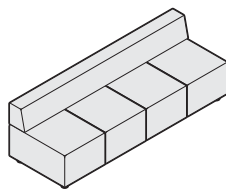

Four-seat Sofa

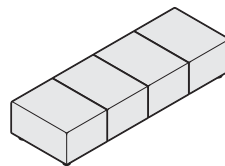

Four-seat Bench



Mobile Ottoman

Lounge Seating, continued

Await Connector Benches

Specifying
▶ Page 66

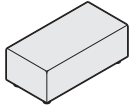

One-section Connector

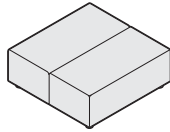

Two-section Connector

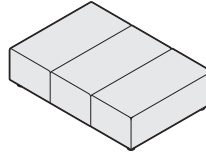

Three-section Connector

Bix Lounge

Understanding
▶ Page 70
Specifying
▶ Page 80

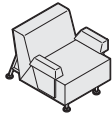

Bix Sled Lounge

Understanding
▶ Page 70
Specifying
▶ Page 81

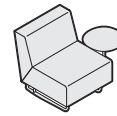
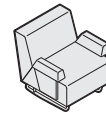
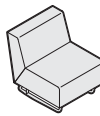

Bix Sectional Seating

Understanding
▶ Page 70
Specifying
▶ Page 82

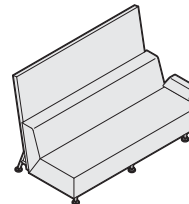
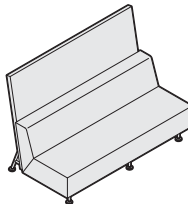
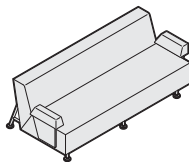
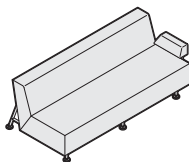
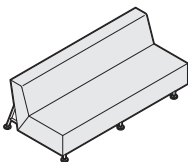
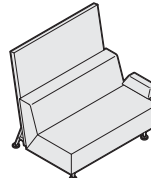
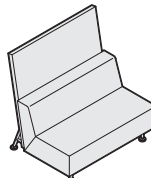
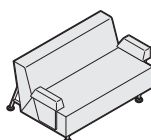
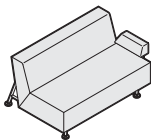
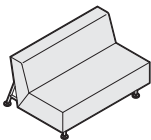
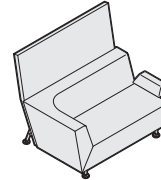
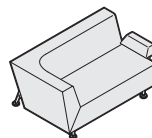
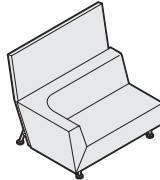
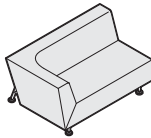
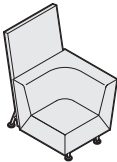

Lounge Seating, continued

Bix Benches

Understanding
▶ Page 70
Specifying
▶ Page 88

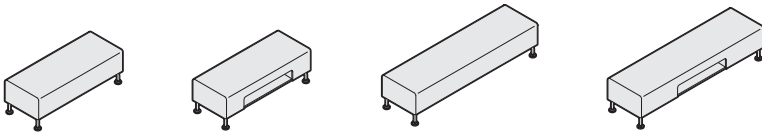

Bix Podium

Understanding
▶ Page 70
Specifying
▶ Page 90

Bix Service Tray

Understanding
▶ Page 70
Specifying
▶ Page 95

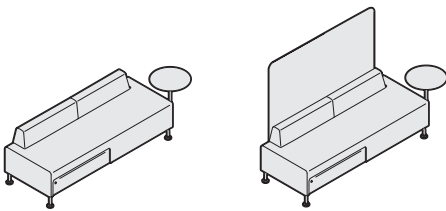

Bix Bridge Tables

Understanding
▶ Page 71
Specifying
▶ Page 96

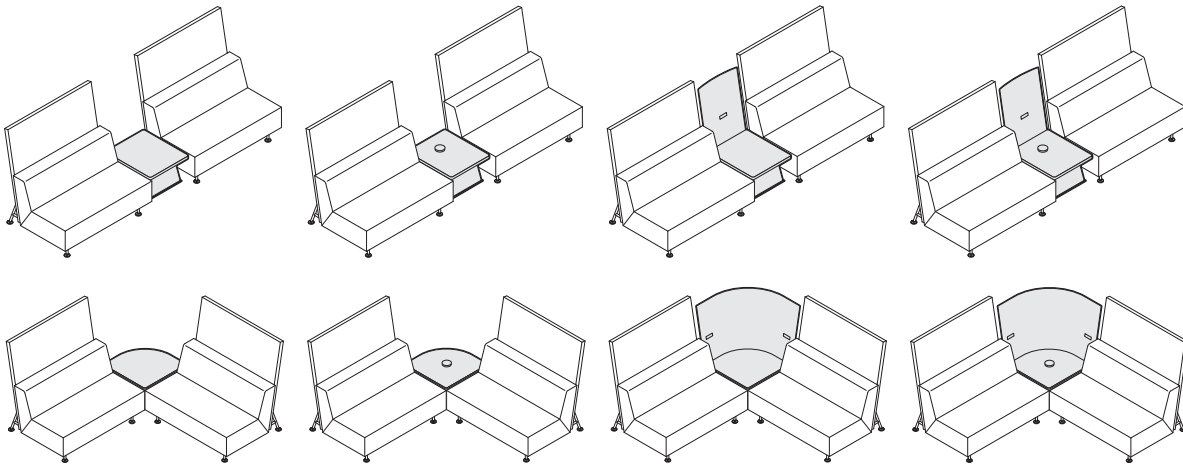

Bix 27"H Work-Booth Tables

Understanding
▶ Page 71
Specifying
▶ Page 99

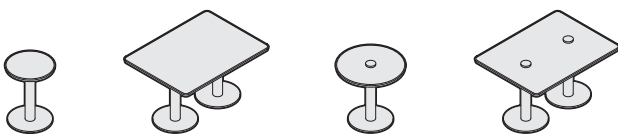

Lounge Seating, continued

Bob Chairs

Specifying
▶ Page 101



Lounge Swivel



Lounge with
Headrest



Ottoman

CH07 Shell Chair

Specifying
▶ Page 102



CH25 Paddle Chair

Specifying
▶ Page 103



CH44 Ladderback Chair

Specifying
▶ Page 104



CH100 Series

Specifying
▶ Page 105

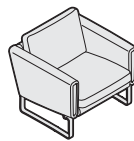

Club Chair

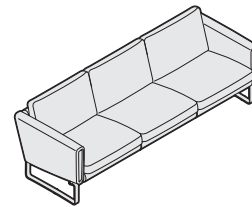

Sofa

CH401 Airport Chair

Specifying
▶ Page 106



Lounge Seating, continued

CH445 Wing Chair and Ottoman

Specifying
▶ Page 107

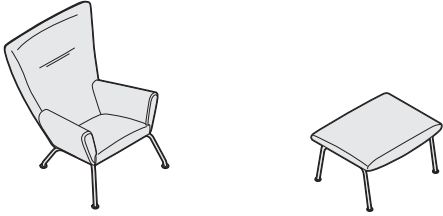

CH468 Oculus Chair

Specifying
▶ Page 108



Lounge Seating, continued

Circa Modular Seating

Specifying
► Page 110

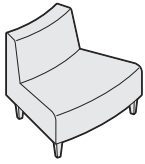

30° Outside/Inside
Facing Wedge Seat

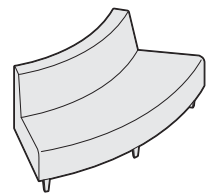
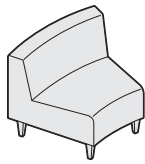

60° Wedge Loveseat

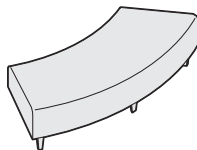
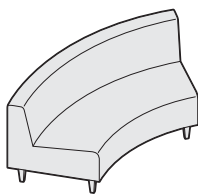

Wedge Bench

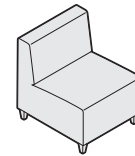
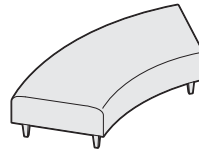

Straight Seat Chair

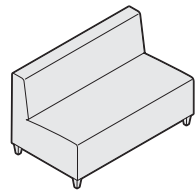

Straight Loveseat

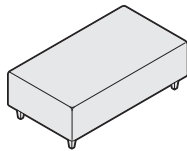

Straight Bench

Circa Modular Armrests

Specifying
► Page 114



Straight Armrest
Intermediate without
Legs

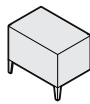

Straight Armrest
End-of-Run with Two Legs



15° Inside Armrest
Intermediate without Legs

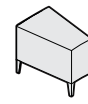

15° Inside Armrest
End-of-Run with Two Legs



15° Outside Armrest
Intermediate without Legs



15° Outside Armrest
End-of-Run with Two Legs

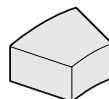

30° Inside Armrest
Intermediate without Legs

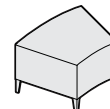

30° Inside Armrest
End-of-Run with Two Legs

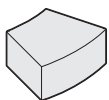

30° Outside Armrest
Intermediate without Legs

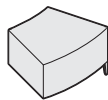

30° Outside Armrest
End-of-Run with Two Legs

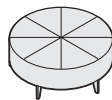

Round Ottoman

Lounge Seating, continued

Circa Ganging Tables

Specifying
▶ Page 120

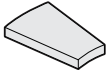

Low Wedge Table

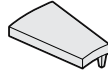

End-of-Run Low Wedge Table

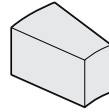

High Wedge Table

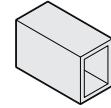

High Straight Table

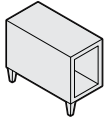

End-of-Run High Straight Table

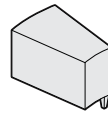

End-of-Run High Wedge Table

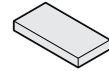

Low Straight Table

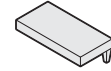

End-of-Run Low Straight Table

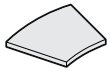

30° Ganging without Legs

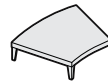

30° End-of-Run with Two Legs



30° End-of-Run with One Legs

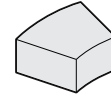

30° Ganged High Table without Legs

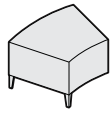

30° End-of-Run High Table with Two Legs

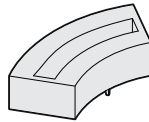

60° Ganged Table-Planter with Two Legs Front and Back

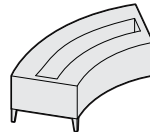

60° End-of-Run Table-Planter with Three Legs

Coupe

Specifying
▶ Page 124

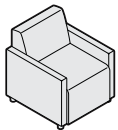

Chair

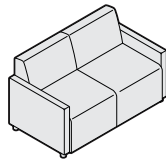

Loveseat

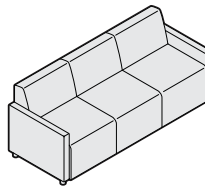

Three-seat Sofa



Ottoman

Coupe Grande/Mobile

Specifying
▶ Page 126

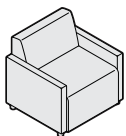

Grande Chair

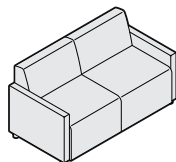

Grande Loveseat

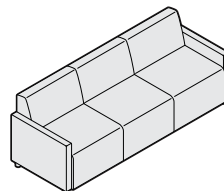

Grande Sofa

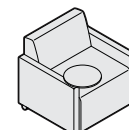

Grande Mobile Chair

Statement of Line

Lounge Seating, continued

Coupe with Wood

Specifying
▶ Page 128

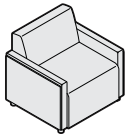

Chair with Wood

Davos

Specifying
▶ Page 129

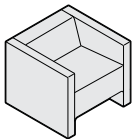

Chair

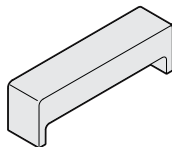

Large Bench

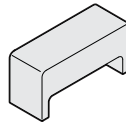

Medium Bench



Small Bench

Detour Lounge

Understanding
▶ Page 132
Specifying
▶ Page 136



Small Lounge/
Narrow Back
with No Arms

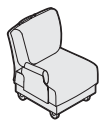

Small Lounge/
Narrow Back
with One Arm

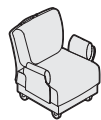

Small Lounge/
Narrow Back
with Two Arms



Small Lounge/
Wide Back
with No Arms

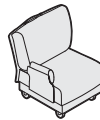

Small Lounge/
Wide Back with
One Arm



Small Lounge/
Wide Back with
Two Arms



Large Lounge
with No Arms

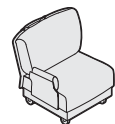

Large Lounge
with One Arm

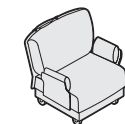

Large Lounge
with Two Arms



Tablet
Arm

Detour Ottoman

Understanding
▶ Page 132
Specifying
▶ Page 140



Statement of Line *continued*

Lounge Seating, continued

Evaneau

Specifying
▶ Page 144

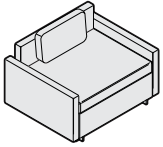

Chair

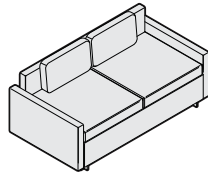

Two-seat Sofa

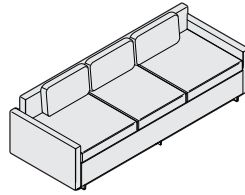

Three-seat Sofa



Low Round Ottoman



High Round Ottoman



Cushions



Arm Pillow



Arm Bolster

Holy Day Lounge Chair

Specifying
▶ Page 147

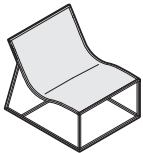

Hosu

Specifying
▶ Page 148

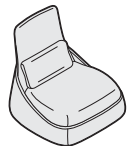

Lounge Chair

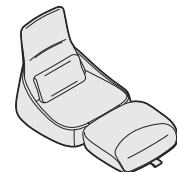

Lounge Chair
with Ottoman

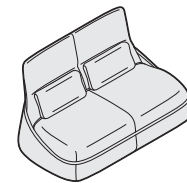

Two-seat Sofa

Joel Lounge

Specifying
▶ Page 151

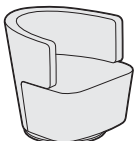

Statement of Line

Lounge Seating, continued

Lagunitas

- Understanding
▶ Page 154
- Specifying
▶ Page 174

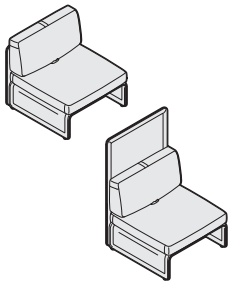

One-Seat Lounges

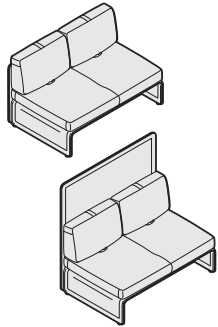

Two-Seat Lounges

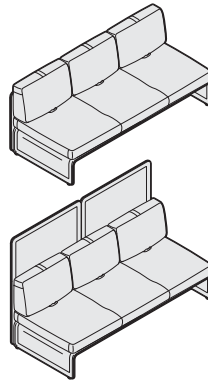

Three-Seat Lounges

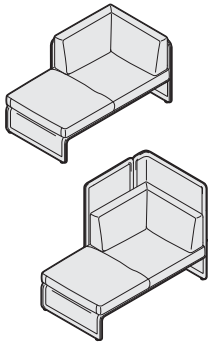

Two-Seat Chaises

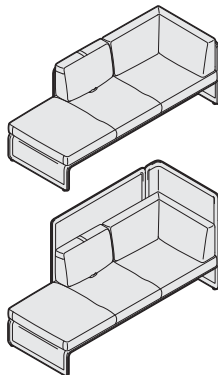

Three-Seat Chaises

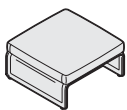

One-Seat Bench

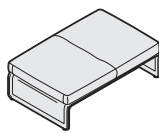

Two-Seat Bench

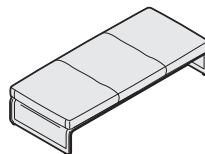

Three-Seat Bench

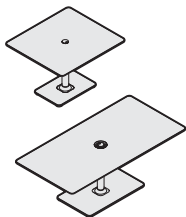

Work Tables

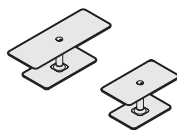

Occasional Tables



Personal Table

Lounge Seating, continued

Massaud

Specifying
▶ Page 200



Lounge



Work Lounge



Ottoman

Millbrae Lifestyle Chairs

Specifying
▶ Page 204

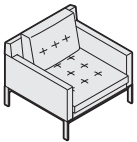

Lounge

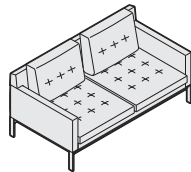

Two-seat Sofa

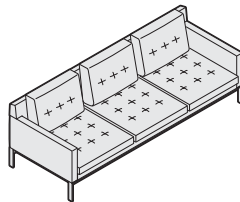

Three-seat Sofa



Round Arm Bolster



Square Arm Bolster

Lounge Seating, continued

Millbrae Contract Chairs

Specifying
► Page 204



Lounge
without Arms

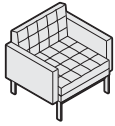

Lounge
with Arms



Lounge
with Left Arm Facing

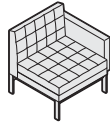

Lounge
with Right Arm Facing

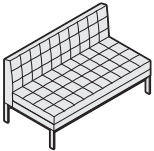

Two-seat Sofa
without Arms

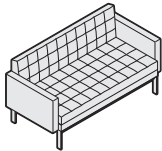

Two-seat Sofa
with Arms

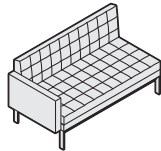

Two-seat Sofa
with Left Arm Facing

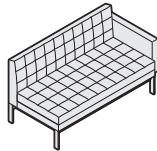

Two-seat Sofa
with Right Arm Facing

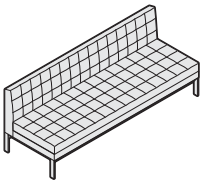

Three-seat Sofa
without Arms

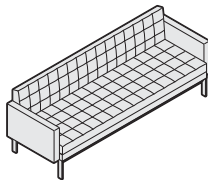

Three-seat Sofa
with Arms

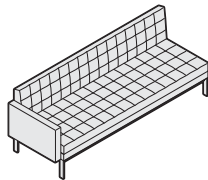

Three-seat Sofa
with Left Arm Facing

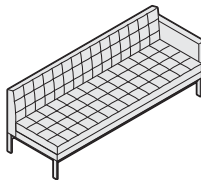

Three-seat sofa
with Right Arm Facing

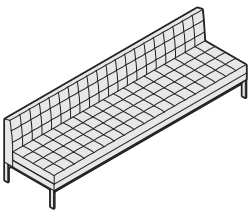

Four-seat Sofa
without Arms

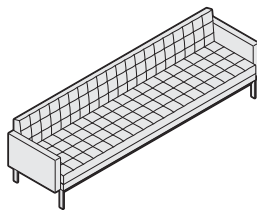

Four-seat Sofa
with Arms

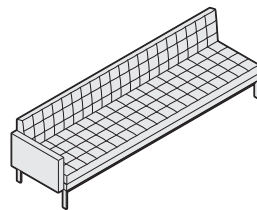

Four-seat Sofa
with Left Arm Facing

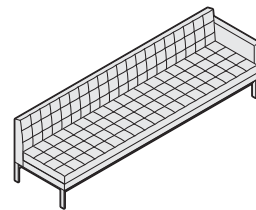

Four-seat Sofa
with Right Arm Facing

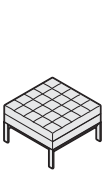

One-Seat
Bench

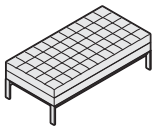

Two-Seat Bench

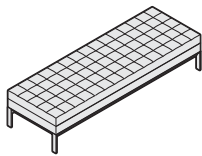

Three-Seat Bench

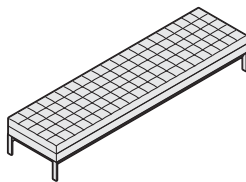

Four-Seat Bench

Statement of Line *continued*

Lounge Seating, continued

Millbrae Tables

Specifying
► Page 375

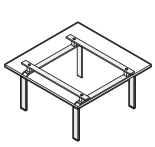

Square Tables

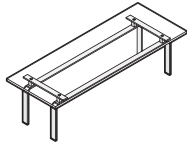

Rectangular Tables

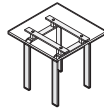

Side Table

Passerelle

Specifying
► Page 214

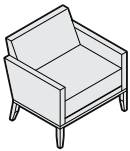

Chair

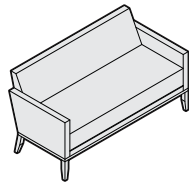

Loveseat

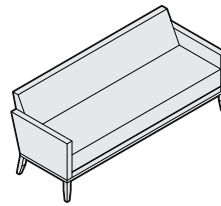

Sofa



Arm Bolster



Ottomans

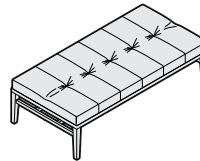
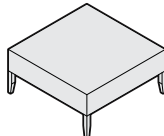
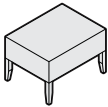

Benches

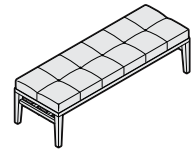
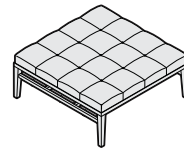

Ripple

Specifying
► Page 218

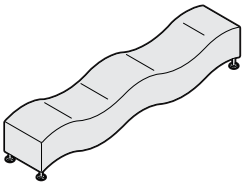

Upholstered
Wave Seat

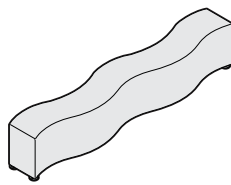

Upholstered
Flat Seat

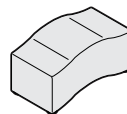

Little Ripple
Wave Seat

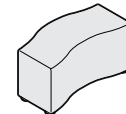

Little Ripple
Flat Seat

Lounge Seating, continued

Sidewalk Lounge/Mobile

Specifying
► Page 220

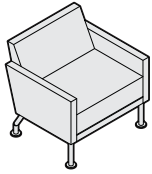

Lowback Chair

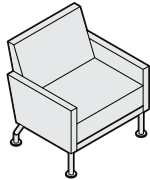

Highback Chair

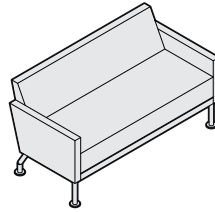

Two Seat

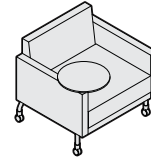

Lowback Chair
with Tablet

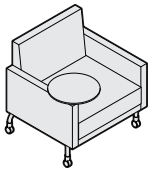

Highback Chair
with Tablet



Arm Bolster

Sidewalk Collaborative

Specifying
► Page 224

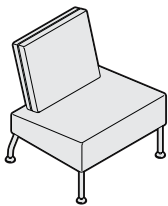

Chair

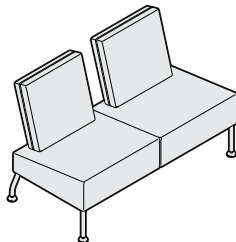

Two-seat

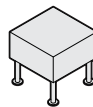

Ottoman

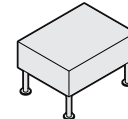
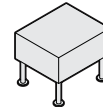

Sidewalk Ottoman/Benches

Specifying
► Page 226

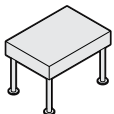

Bench

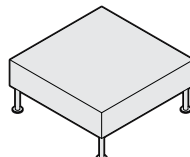
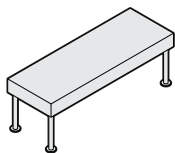
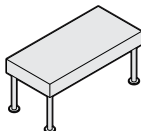

Ottoman

Lounge Seating, continued

SW_1 Collaborative Lounge Chairs

Specifying
▶ Page 228



Lowback Lounge

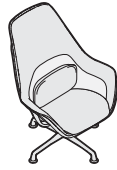

Highback Lounge



Ottoman



Tablet

*Left-hand tablet shown. Right-hand tablet available.

SW_1 Low Collaborative Conference Tables

Specifying
▶ Page 230



Large Round
One-Piece Top

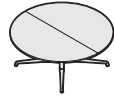

Large Round
Two-Piece Top



Square



Large Square
One-Piece Top

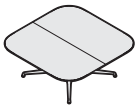

Large Square
Two-Piece Top

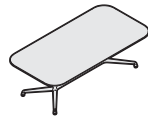

Rectangular



Super Elliptical
One-Piece Top

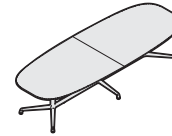

Super Elliptical
Two-Piece Top

Swathmore

Specifying
▶ Page 234

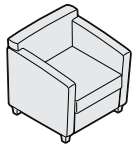

Chair with Wood Legs

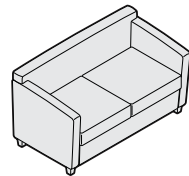

Two-seat Sofa with Wood Legs

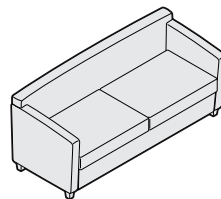

Three-seat Sofa with Wood Legs

Swathmore Louver

Specifying
▶ Page 235

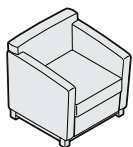

Chair with Wood
Louver Base

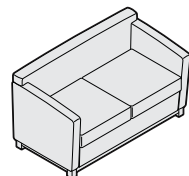

Two-seat Sofa with
Wood Louver Base

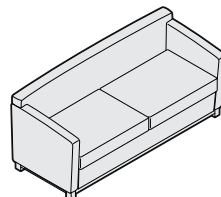

Three-seat Sofa with Wood
Louver Base

Statement of Line

Lounge Seating, continued

Swathmore Grande with Wood Leg

Specifying
► Page 236

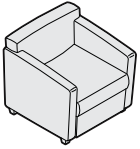

Chair with Wood Legs

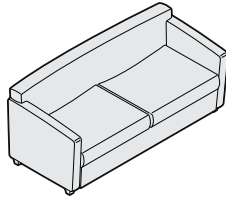

Three-seat Sofa with
Wood Legs

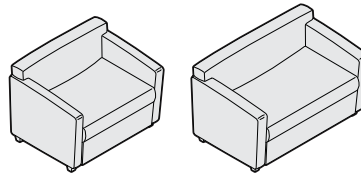

Bariatric Chair with Wood Legs

Swathmore Grande Louver

Specifying
► Page 238

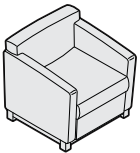

Chair with Wood
Louver Base

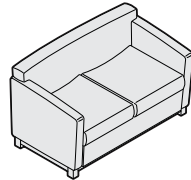

Two-seat Sofa with
Wood Louver Base

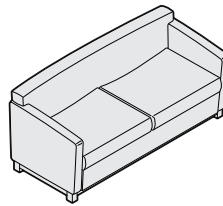

Three-seat Sofa with
Wood Louver Base

Swathmore Grande Mobile

Specifying
► Page 239

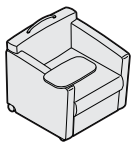

Chair/Tablet Left Facing

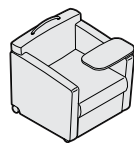

Chair/Tablet Right Facing

Lounge Seating, continued

Switch

Specifying
► Page 240

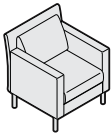

Chair

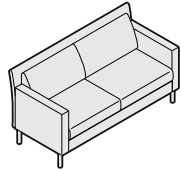

Two-seat

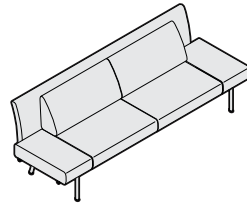

Two-seat with Extensions

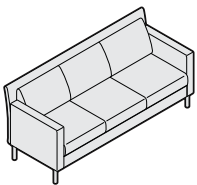

Three-seat



Arm Bolster

Thoughtful

Specifying
► Page 244

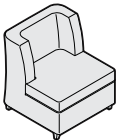

Lounge Chair

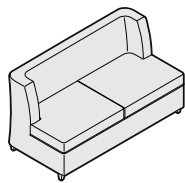

Small Sofa

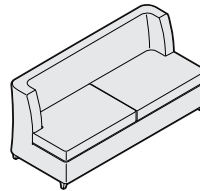

Medium Sofa

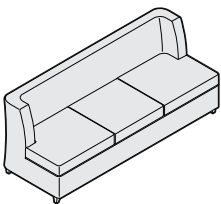

Long Sofa

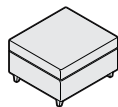

Ottoman

Statement of Line

Lounge Seating, continued

Specifying
► Page 248

Together Bench

69¾"D 96½"W 31"H

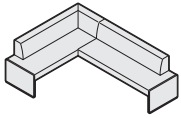

Left Corner with Back 8" Offset

96½"D 96½"W 31"H

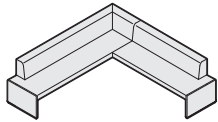

123¼"D 69¼"W 31"H

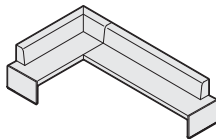

96½"D 123¼"W 31"H

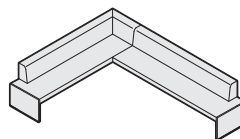

69¾"D 96½"W 31"H

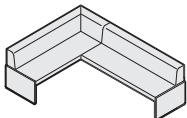

Left Corner with Back 1.5" Offset

96½"D 96½"W 31"H

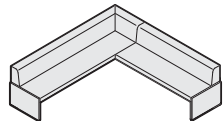

69¾"D 123¼"W 31"H

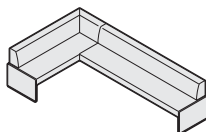

96½"D 123¼"W 31"H

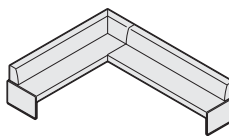

69¾"D 96½"W 31"H

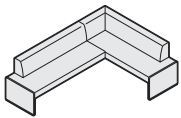

Right Corner with Back 8" Offset

96½"D 96½"W 31"H

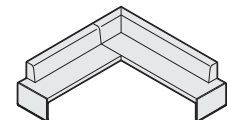

123¼"D 69¼"W 31"H

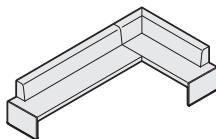

96½"D 123¼"W 31"H

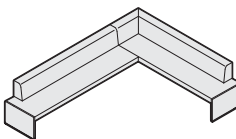

69¾"D 96½"W 31"H

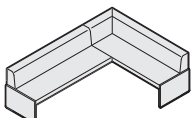

Right Corner with Back 1.5" Offset

96½"D 96½"W 31"H

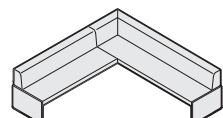

69¾"D 123¼"W 31"H

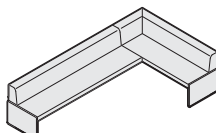

96½"D 123¼"W 31"H

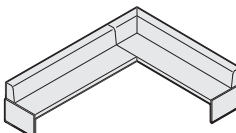

26¾"D 69¾"W 31"H

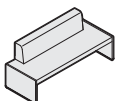

Straight with 8" Offset Back

26¾"D 96½"W 31"H

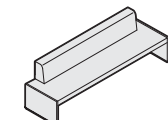

26¾"D 69¾"W 31"H

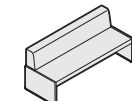

Straight with 1.5" Offset Back

26¾"D 96½"W 31"H

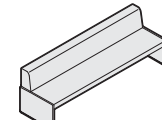

26¾"D 69¾"W 18½"H

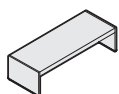

Straight without Back

26¾"D 96½"W 18½"H

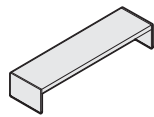

Lounge Seating, continued

Topo Lounge

Understanding
▶ Page 256
Specifying
▶ Page 258



Lounge

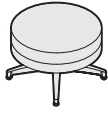

Lounge Jr.

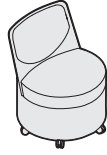

Mobile Lounge

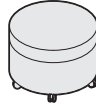

Mobile Lounge Jr.

Visalia

Specifying
▶ Page 262

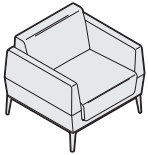

Lounge

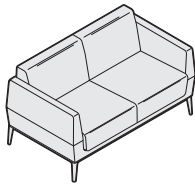

Two-Seat Chair

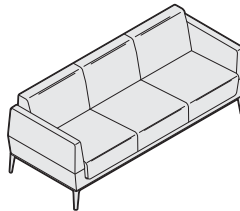

Three-Seat
Chair

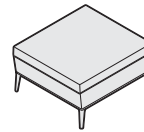

Ottoman

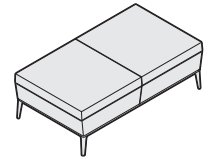

Bench

Statement of Line

Guest/Side/Stack Seating

Bindu



Low Back Guest/
Side Chair



Mid Back Guest/
Side Chair

Specifying
▶ Page 268

Bob



Guest



Ottoman

Specifying
▶ Page 269

Capa Chair



Specifying
▶ Page 270

CH20 Elbow Chair



Specifying
▶ Page 271

CH24 Wishbone Chair



Specifying
▶ Page 272

CH53 Stool



Specifying
▶ Page 273

CH88 Chairs



Specifying
▶ Page 274

Guest/Side/Stack Seating, continued

Enea Stacker

Specifying
▶ Page 276



Wood Seat and Back with Arms



Metal Stacker with Upholstered Seat and Back with Arms



Metal Stacker with Upholstered Seat and Wood Back with Arms

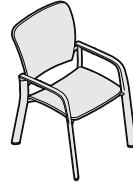

Metal Stacker with Polypropylene Seat and Back with Arms



Wood Seat and Back Without Arms



Upholstered Seat and Back Without Arms



Upholstered Seat and Wood Back Without Arms

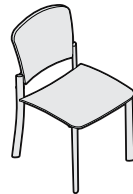

Polypropylene Seat and Back Without Arms

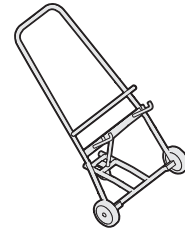

Dolly

Enea Bar-Height Stools

Specifying
▶ Page 280

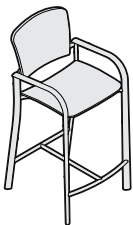

Bar-Height Stool with Wood Seat and Back with Arms

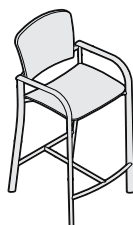

Bar-Height Stool with Upholstered Seat and Back with Arms

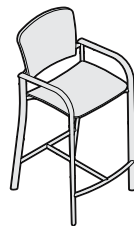

Bar-Height Stool with Upholstered Seat and Wood Back with Arms



Bar-Height Stool with Polypropylene Seat and Back with Arms

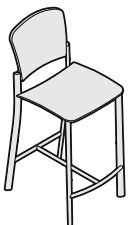

Bar-Height Stool with Wood Seat and Back Without Arms

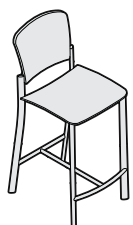

Bar-Height Stool with Upholstered Seat and Back Without Arms

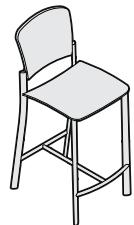

Bar-Height Stool with Upholstered Seat and Wood Back Without Arms

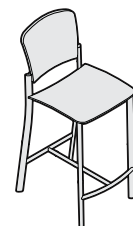

Bar-Height Stool with Polypropylene Seat and Back Without Arms

Statement of Line

Guest/Side/Stack Seating, continued

Enea Café Stool

Specifying
▶ Page 284



Café Counter-Height Stool

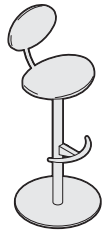

Café Bar-Height Stool



Low Stool Upholstered Seat



Café Counter-Height Stool Upholstered Seat

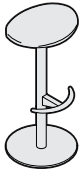

Café Bar-Height Stool Upholstered Seat

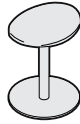

Low Stool



Café Counter-Height Stool



Café Bar-Height Stool

Enea Lottus Seating

Specifying
▶ Page 288



Armless Chair



Cantilever Arm Chair



Aluminum Loop Arm Chair



Counter Height Sled Base Stool



Bar Height Sled Base Stool

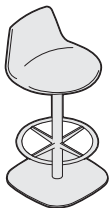

Counter Height Post Base Stool

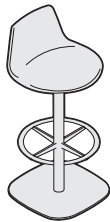

Base Height Post Base Stool

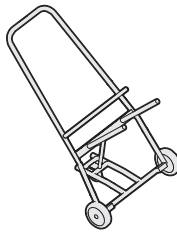

Dolly

Guest/Side/Stack Seating, continued

Kart Nesting Chairs

Specifying
▶ Page 298



With Arms*

*Jury base available



Armless*

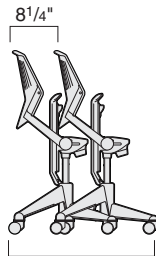

Nested

Kart Stools on Casters

Specifying
▶ Page 300



With Arms*

*Jury base available



Armless

Kart Four-Leg Stools

Specifying
▶ Page 302



With arms

Kart Stacking Chairs

Specifying
▶ Page 303



Kathryn

Specifying
▶ Page 308

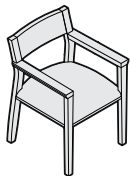

Open Wood Back

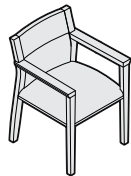

Upholstered Wood
Back Panel

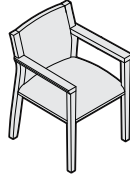

Fully Upholstered
Back

Statement of Line

Guest/Side/Stack Seating, continued

Last Minute Stools

Specifying
► Page 310



High



Medium

Lox Chairs

Specifying
► Page 311



Chair with
Upholstered Seat



Chair with
Upholstered
Seat and Back

Lox Stools

Specifying
► Page 312



Counter-Height
Stool



Bar-Height Stool

Rocky Four-Star Base Nesting Chairs

Specifying
► Page 313



Rocky Five-Star Base Chairs*

Specifying
► Page 314



*Jury base available

Rocky Five-Star Base Stools

Specifying
► Page 315



SW_1

Specifying
► Page 317



Guest Swivel Return Chair



Conference Swivel Return Chair

Statement of Line *continued*

Guest/Side/Stack Seating, continued

Switch Guest

Specifying
▶ Page 318

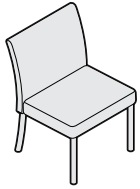

Armless Chair

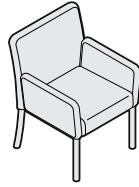

Arm Chair

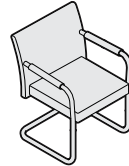

Lowback Sledbase

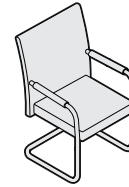

Highback Sledbase

Switch Stools without Arms

Specifying
▶ Page 320

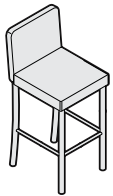

Armless Counter-Height
Stools

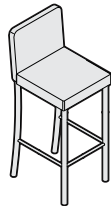

Armless Bar-Height
Stool

Wrapp Side

Specifying
▶ Page 321



Four Leg



Sled Base

X-Stack Four-Leg Stacking Chairs

Specifying
▶ Page 322



Without Arms
on Casters



With Arms
on Casters



Without Arms on
Casters with Tablet



With Arm on Casters
with Tablet

Statement of Line

Executive Seating

Bindu

Specifying
▶ Page 326



Mid Back Executive/
Conference Chair



High Back Executive/
Conference Chair



Low Back Guest/
Side Chair



Mid Back Guest/
Side Chair

Chord

Specifying
▶ Page 328



Conference Narrow



Midback



Highback Narrow



Highback/Large Scale

La Costa Couture

Specifying
▶ Page 330



Conference with Open
Urethane Arms



Midback with Open
Urethane Arms



Highback with
Open Urethane
Arms

La Costa/Sport

Specifying
▶ Page 332



Sled Base with
Open Urethane
Arm



Conference with
Open Urethane
Arm



Midback with
Open Urethane
Arm



High Back with
Open Urethane
Arm

Statement of Line *continued*

Occasional Tables

Avon

Specifying
▶ Page 338

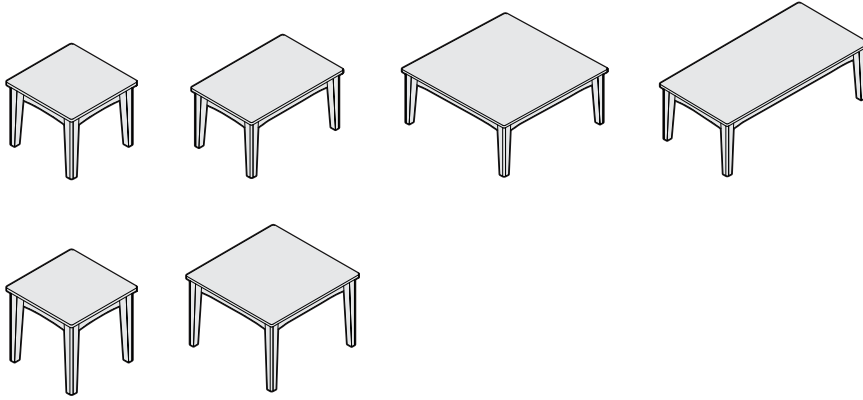

Await Tables

Specifying
▶ Pages 67 and 340

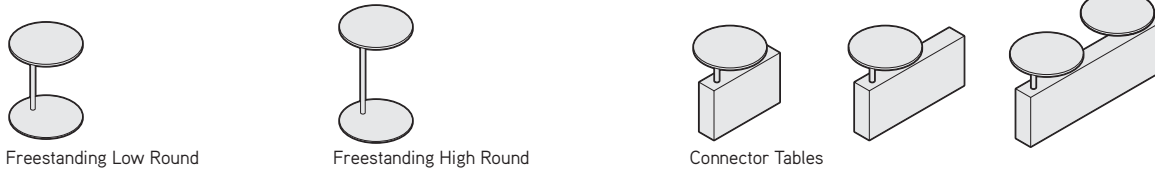

Bix 18"H Occasional Tables

Understanding
▶ Page 70
Specifying
▶ Pages 98 and 343



Statement of Line

Occasional Tables, continued

Bix Side Table

- Understanding
▶ Page 70
- Specifying
▶ Pages 100 and 342



Bob Tables

- Specifying
▶ Page 344

24" 30" 36" 42"

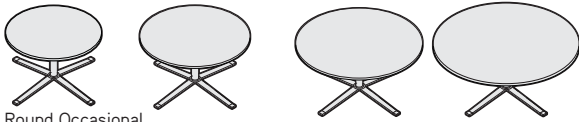

Round Occasional

24" 30" 36" 42"



Round Conference

Calm Square

- Specifying
▶ Page 346

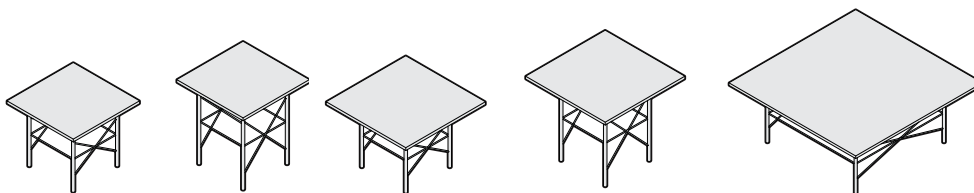

Occasional Tables, continued

Calm Rectangle

Specifying
▶ Page 347



CG_1

Specifying
▶ Page 350

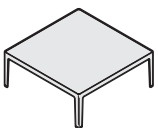

Low Square Tables

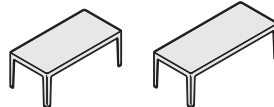
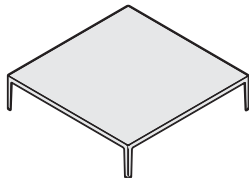
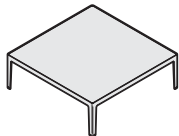

Low Rectangular Tables

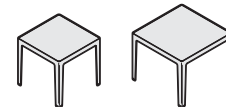

High Square Tables

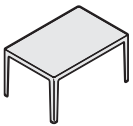

High Rectangular Table

CH008 Sofa Tables

Specifying
▶ Page 352



30" Round Sofa Table



34 1/2" Round Sofa Table

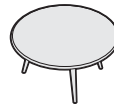

39 1/4" Round Sofa Table

CH100 Occasional Table

Specifying
▶ Page 353

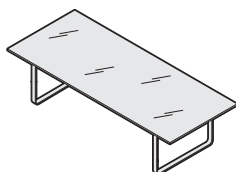

Glass Coffee Table

CH327 Dining Tables

Specifying
▶ Page 354

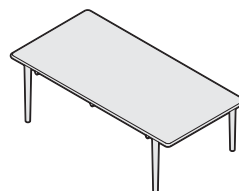

Statement of Line

Occasional Tables, continued

Circa Freestanding Tables

Specifying
► Pages 118 and 355

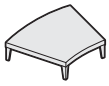

30° Freestanding Low Table with Four Legs

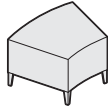

30° Freestanding High Table with Four Legs

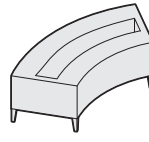

60° Freestanding Planter with Five Legs

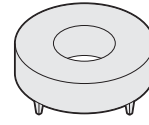

Round

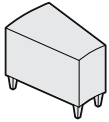

High Wedge

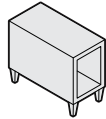

High Straight

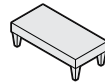

Low Straight

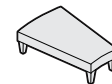

Low Wedge

Denizen Tablet Table

Specifying
► Page 357



Diekman

Specifying
► Page 358

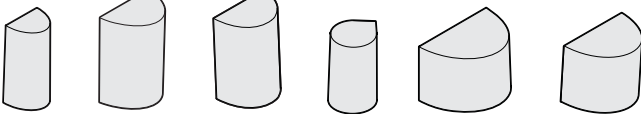

Wood

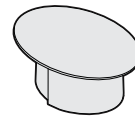

Wood Base with Elliptical Top

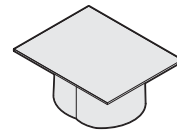

Wood Base with Rectangle Top

Occasional Tables, continued

Enea Single Base

Specifying
▶ Page 360

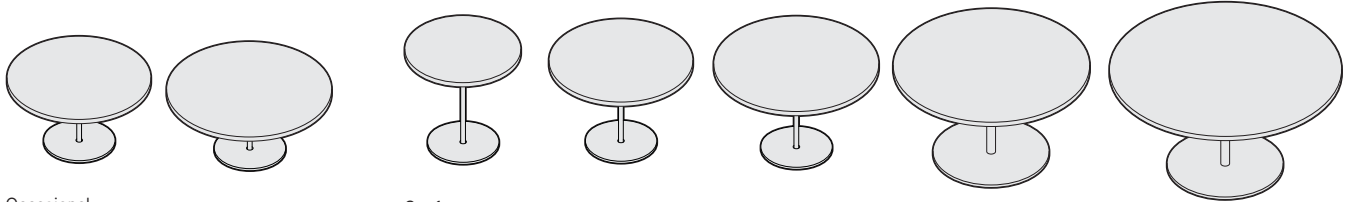

Occasional

Conference

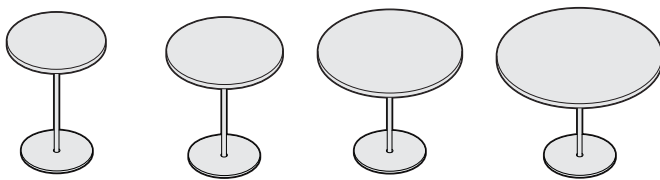

Café/Counter Height

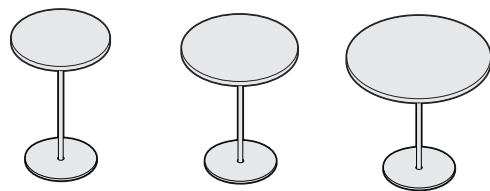

Café/Bar Height

Enea Twin Bases

Specifying
▶ Page 362

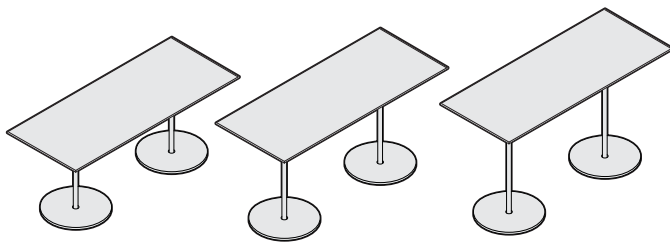

Rectangular

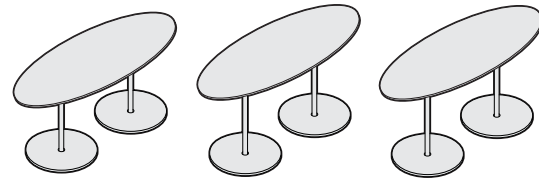

Oval

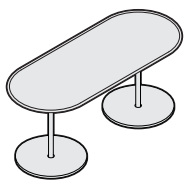

Conference
Racetrack

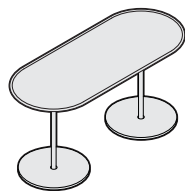

Counter Racetrack

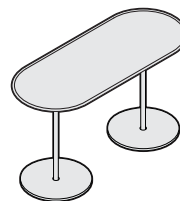

Café Racetrack

Occasional Tables, continued

Enea Lottus Tables

Specifying
► Page 365

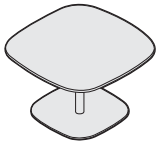

Occasional



Conference

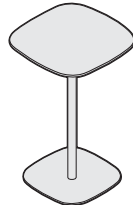

Café Counter Height

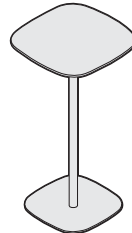

Café Bar Height

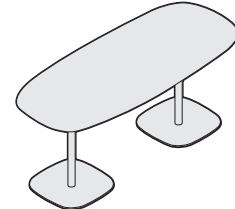

Rectangular

Free Stand

Specifying
► Page 370



Ginger

Specifying
► Page 372

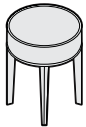

Round

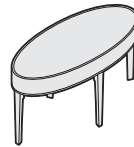
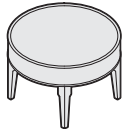
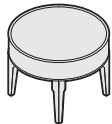

Elliptical

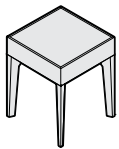

Square

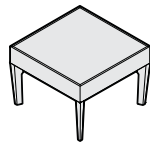
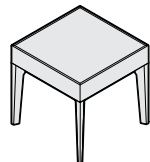

Holy Day Tables

Specifying
► Page 374



Round Table

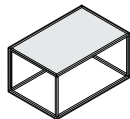

Rectangular Table

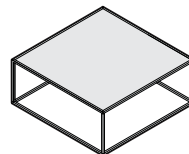

Square Table

Statement of Line *continued*

Occasional Tables, continued

Millbrae Tables

Specifying
▶ Page 375

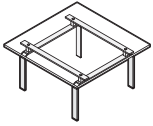

Square Tables

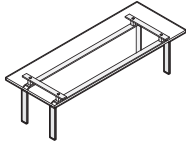

Rectangular Tables

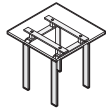

Side Table

Passerelle

Specifying
▶ Page 376

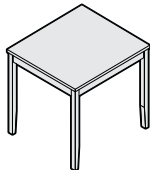
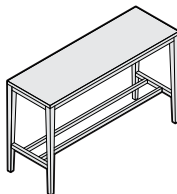
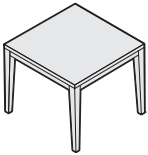

Sebastopol

Specifying
▶ Page 378

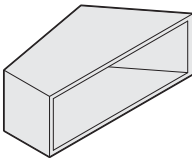
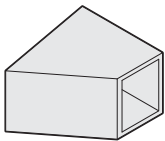

16" High Tables

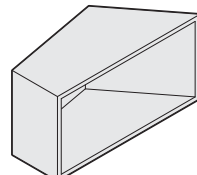
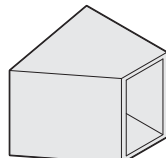

22" High Tables

Sidewalk Occasional Tables

Specifying
▶ Page 380

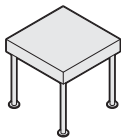
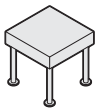

Sidewalk Storage

Specifying
▶ Page 381

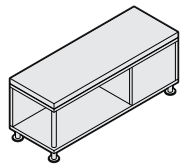

Credenza

Statement of Line

Occasional Tables, continued

Soft Leaf

Specifying
► Page 382

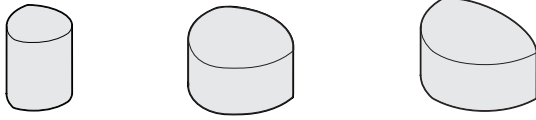

SW_1 Occasional Tables

Specifying
► Page 384

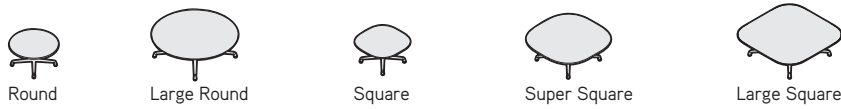

Switch

Specifying
► Page 386

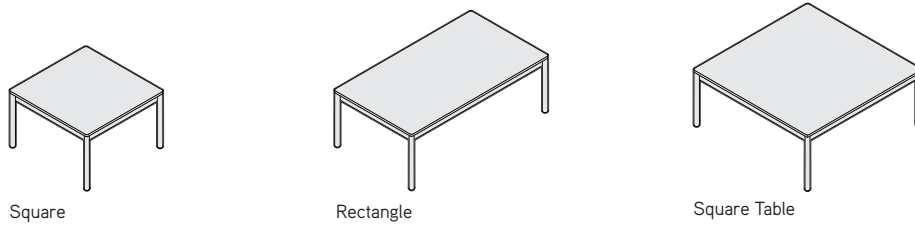

TeamWork Satellite Table

Specifying
► Page 388



Occasional Tables, continued

Trees

Specifying
▶ Page 390

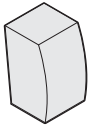

Curve High-
Stainless Steel

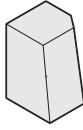

Bevel High-
Embossed Wood

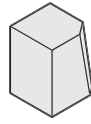

Bevel Medium-
Embossed Wood

Indoor/Outdoor Seating

Emu Heaven

Specifying
▶ Page 396



Chair



Arm Chair

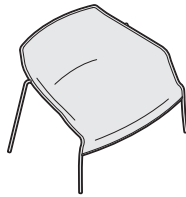

Lounge Chair



Pouf/Side Table



Low Vase

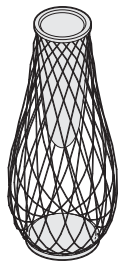

High Vase



Cushions



Round Table Bases

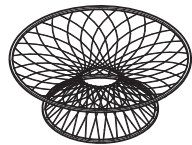
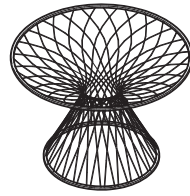

Low Table Base



Glass Tops

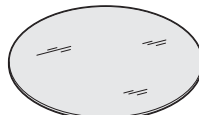

Tip: Cushions are available for indoor and outdoor use.

Statement of Line

Indoor/Outdoor Seating, continued

Emu Ivy

Specifying
► Page 402



Side Chair



Side Arm Chair

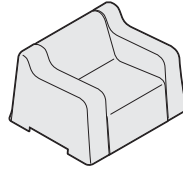

Arm Chair

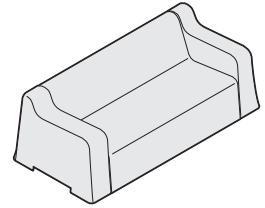

Sofa



Pouf

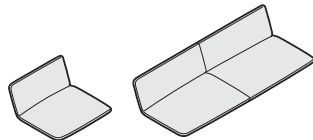

Cushions

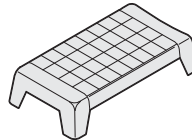

Rectangular Side Table

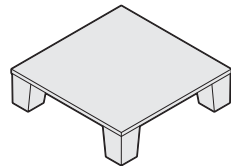

Square Side Table

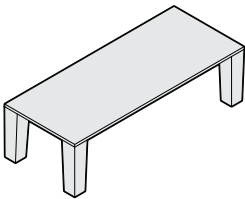

Rectangular Metal Top Table

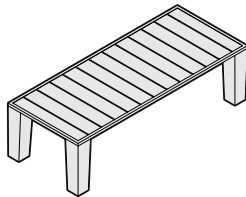

Rectangular Teak Top Table

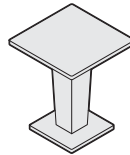

Square Table

Tip: Cushions are available for indoor and outdoor use.

Emu Pattern

Specifying
► Page 405



Arm Chair



Armless Chair

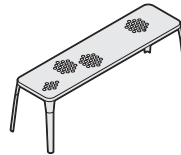

Rectangular Bench



Small Round Table

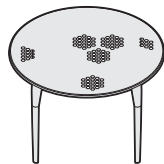

Large Round Table

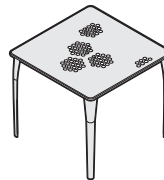

Square Table

Indoor/Outdoor Seating, continued

Emu Re-Trouvé

Specifying
▶ Page 408



Midback Chair



Highback Chair



Pouf



Low Vase Frame



High Vase Frame

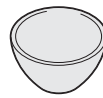

Vase Insert



Cushions



Tip: Cushions are available for indoor and outdoor use.

Emu Round

Specifying
▶ Page 410



Stool



Chair



Arm Chair



Lounge

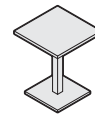

Square Tables

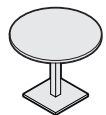
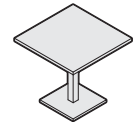
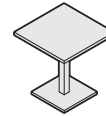

Round Table

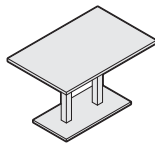

Rectangle Table

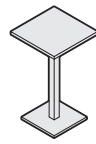

Counter Table

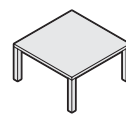

Side Tables

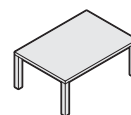

Lounge Seating

Archipelago	52
Astor	62
Await	64
Bix	70
Bob Chairs	101
CH07 Shell Chair	102
CH25 Paddle Chair	103
CH44 Ladderback Chair	104
CH100 Series	105
CH401 Airport Chair	106
CH445 Wing Chair	107
CH468 Oculus Chair	108
Circa	110
Coupe	124
Davos	129
Detour	132
Evaneau	144
Holy Day Lounge Chair	147
Hosu	148
Joel Lounge	151
Lagunitas	154
Massaud	200
Millbrae	204
Passerelle	214
Ripple	218
Sidewalk	220
SW_1	228
Swathmore	234
Swathmore Grande	236
Switch	240
Thoughtful	244
Together	248
Topo Lounge	256
Visalia	262

Archipelago

DESIGN METRO DESIGN GROUP WITH EIGHT INC.

Archipelago lounge seating features a simple, versatile design that works well in an informal work setting. Lounge chairs may be specified individually or connected with elliptical, fully upholstered arms or pivoting tablet arms. An ottoman is also available.

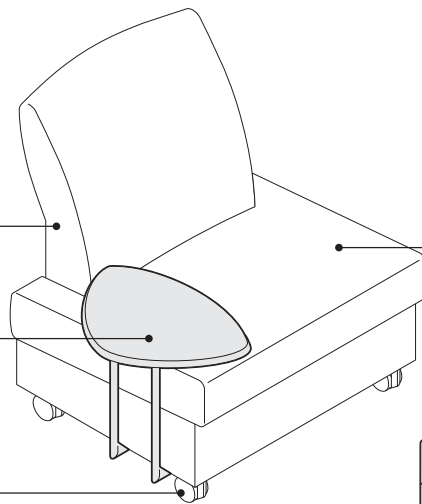

Back is fully upholstered. The position of the back cushion varies depending on the chair model.

Tablet arm pivots on a 60° angle. It has a wood core with a laminate or wood veneer surface.

Soft casters are non-locking. *Tip: casters are not recommended for connected lounge sections.*

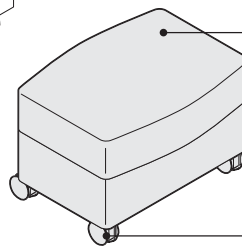

Seat is fully upholstered.

Ottoman can be used as a mobile footrest, bench, or soft worksurface.

Casters are standard on ottoman.

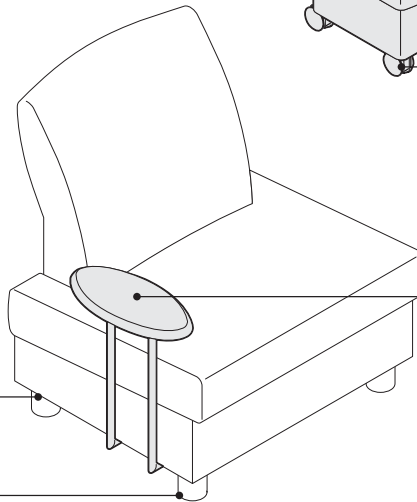

Legs are constructed with steel and finished with any paint color.

Adjustable glides are standard on models with legs. Bottom of glide is black plastic, with no adjustment.

Elliptical arms are available in wood. They can be positioned to the left or right side or intermediate between two seats. Fully upholstered arm is also available.

Actual Dimensions

	Overall			Seat		Seat height from floor: at front, at back	Back height from seat at back	Back width	Arm/tablet height
	Depth	Width	Height	Depth	Width				
Lounge	29"	32"	35"	20"	32"	17" - front 15" - back	20"	24"	23½"
Lounge, left or right section	29"	28"	35"	20"	28"	17" - front 15" - back	20"	24"	23½"
Lounge, straight section	29"	24"	35"	20"	24"	17" - front 15" - back	20"	24"	23½"
Elliptical arm	16"	8"	23½" when attached	N.A.	N.A.	N.A.	N.A.	N.A.	N.A.
Upholstered arm	14"	6"	23½" when attached	N.A.	N.A.	N.A.	N.A.	N.A.	N.A.
Tablet arm	19¾"	13¾"	23½" when attached	N.A.	N.A.	N.A.	N.A.	N.A.	N.A.
Ottoman	17½"	23¾"	16½"	N.A.	N.A.	N.A.	N.A.	N.A.	N.A.

Archipelago

DESIGN METRO DESIGN GROUP WITH EIGHT INC.

Product Details

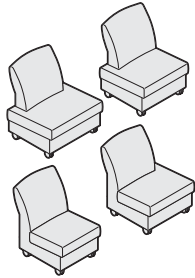

Lounge chair is available in four models – 32"W straight, left section, right section, and 24"W straight.



24"W straight-section lounge chair has a back cushion that is flush on both sides of the chair. It can stand-alone or adjoin to another chair with a straight side.

Tip: An arm or tablet arm cannot be attached to the straight-section lounge chair.



Ottoman is equipped with casters. It is intended as a footrest. However, it also provides a backless seating option.

32"W straight lounge chair has a back cushion that is centered on the back of the chair. It has a 4" extension on each side of the back cushion. It can stand-alone or be adjoined to another lounge chair. An arm or tablet arm may be attached to either side.



Left-section lounge chair has a back cushion that is flush on the right side and has a 4" extension on the left side when facing the front of the chair.

Tip: The right side will adjoin with a straight or right-section lounge chair. An arm or tablet arm may be attached to the extended left side.



Right-section lounge chair has a back cushion that is flush on the left side and has a 4" extension on the right side when facing the front of the chair.

Tip: The left side will adjoin with a straight or left-section lounge chair. An arm or tablet arm may be attached to the extended right side.

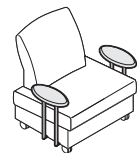
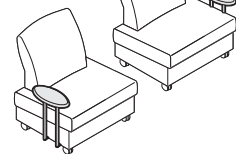
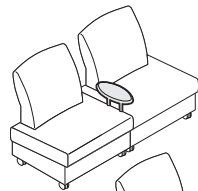

Elliptical arm is available in two styles – intermediate or end. The intermediate arm attaches between adjoining chairs. The end arm is handed for use on the left- or right-hand side. It is available with a laminate or wood veneer surface.

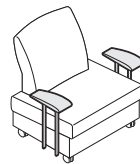
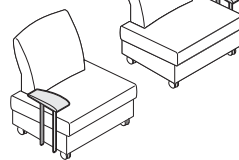
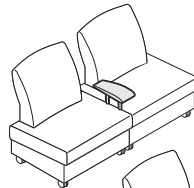

Fully upholstered arm is available in two styles – intermediate or end. An intermediate arm attaches between adjoining chairs. The end arm is handed for use on the left- or right-hand side.

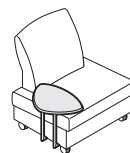

Tablet arm pivots on a 60° angle. It is handed for use on the left- or right-hand side. It is field installed.

Multiple fabrics can be specified on an individual unit for an additional fee per specified fabric. A lounge chair can have up to two additional fabrics. An ottoman can have one additional fabric.

Lounge chair

- Seat cushion and sides of seat cushion - no additional fee
- Back cushion (including the front, back, and sides of back cushion) - additional fee
- Base frame - additional fee
- Fully upholstered arms (if selected and ordered separately) - no additional fee

Ottoman

- Seat cushion and sides of seat cushion - no additional fee
 - Base frame - additional fee
- See *Archipelago Multi-Fabric Diagram and Yardage Request Form*, page 59.

Tip: Fully upholstered arms, if selected, can have a contrasting fabric. However, since they are ordered separate from the chair, simply order the arms with whatever kind of fabric is desired.

Connections

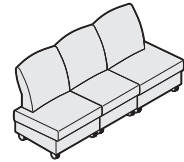

Straight side of a chair adjoins to another straight side. Ganging brackets are provided.

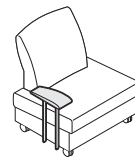

End arm connects to the extended side of a chair. An end arm cannot attach to the straight side of a chair.

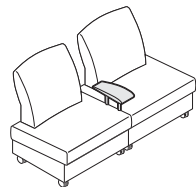

Intermediate arms connect between two adjoining chairs that have extended sides.

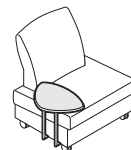

Tablet arm connects to the extended side of a chair. A tablet arm cannot attach to the straight side of a chair.

Casters are not recommended for connected lounge sections.

Archipelago *continued*

DESIGN METRO DESIGN GROUP WITH EIGHT INC.

Surface Materials

Seat, back, and base frame

- Fabric

Elliptical arm

- Laminate
- Wood

Fully upholstered arm

- Fabric

Tablet surface

- Laminate Grade 1
- Wood veneer

Support for arm or tablet

- Paint

Leg and glides

- Paint

Casters

- Black plastic only

Note: Refer to the Coalesse Surface Materials Reference Guide for additional surface materials information.

Programs & Services

Customer's Own

Material/Leather (COM/COL)

Program is available.

▶ See *Coalesse Surface Materials Reference Guide* for additional information.

Designers

Metro Design Group with Eight Inc.

Coalesse

Archipelago

DESIGN METRO DESIGN GROUP WITH EIGHT INC.

Archipelago Lounge Chairs and Ottoman **X10/15**

DESIGN METRO DESIGN GROUP WITH EIGHT INC.

Tip: For Customer's Own Material or Leather, see necessary requirements, important processing instructions, and ordering information on page
 ▶ See *Coalesse Surface Materials Reference Guide*.

Tip: Arms and tablet arms, if selected, should be entered on consecutive lines of the purchase order immediately following the lounge chair to which they will be applied. Components for identical chair configurations may be grouped together on consecutive lines.

Tip: Begin a new series of line items for each chair configuration.

Tip: For veneer tops, edge and top will be the same finish color. For laminate tops, edge will always be black.

Tip: When specifying fabric in different price grades, the highest price grade prevails.

Tip: Arms are ordered separately. They can be specified with matching or contrasting upholstery.

Tip: The COM yards and COL square footage listed on these pages reflect the requirements for a single fabric that are based on non-directional 54"W material applied railroaded. For multi-fabric COM requirements, please refer to Multi-Fabric Diagram and Yardage Request Form.
 ▶ Page 59

Tip: Fully upholstered arms do not require additional COM yardage or COL square footage.

Tip: Handedness is determined while facing the chair.

Tip: Fabrics and leathers will appear loose with comfort wrinkles when upholstered.



Standard Includes		Required to Specify
▶ Need help? Product details, page 52	<ul style="list-style-type: none"> Lounge chair: <ul style="list-style-type: none"> - Seat, back, and base frame: fabric or leather - Legs and glides, if selected: paint - Casters, if selected: black plastic only Arm, if selected: <ul style="list-style-type: none"> - Elliptical arm: laminate (Grade 1) or wood veneer - Fully upholstered arm: fabric or leather - Support: paint Tablet arm, if selected: <ul style="list-style-type: none"> - Surface: laminate (Grade 1) or wood veneer - Support: paint Ottoman: <ul style="list-style-type: none"> - Seat: fabric or leather - Casters: black plastic only 	1 Style number 2 Number of fabrics if contrasting fabric style number is selected 3 Fabric or leather color number for seat, back, and fully upholstered arm or ottoman, if selected 4 Paint color number for legs and glides, base frame and support, if selected 5 Laminate or wood color number for elliptical arm or tablet arm, if selected 6 Options, if selected (see below) ▶ See <i>Coalesse Surface Materials Reference Guide</i> .

Options	U.S. Price	Required to Specify
Surface Materials	<ul style="list-style-type: none"> Contrasting fabric +\$118 per fabric 	Add suffix K to the style number and select fabric color number.
Acrylic backer		Specify with acrylic backer.
• 24"W chair	+\$ 37	Specify with acrylic backer.
• 28"W and 32"W chairs	+\$ 41	Specify with acrylic backer.
• Ottoman	+\$ 22	Specify with acrylic backer.
• Upholstered arms	+\$ 4	Specify with acrylic backer.

▶ See *Coalesse Surface Materials Reference Guide*.

Specification Information															
Style Number	U.S. Base Prices												Leather Grades:		
	Fabric Grades:												COL	C	E
	COM	6	7	8	9	10	11	12	13	14					

32"W Straight Lounge Chair

With Casters

910C X10/15	\$2286	\$2335	\$2400	\$2453	\$2581	\$2651	\$2709	\$2839	\$2898	\$3177	\$2468	\$3809	\$4066
--------------------	--------	--------	--------	--------	--------	--------	--------	--------	--------	--------	--------	--------	--------

With Glides

910G X10/15	\$2286	\$2335	\$2400	\$2453	\$2581	\$2651	\$2709	\$2839	\$2898	\$3177	\$2468	\$3809	\$4066
--------------------	--------	--------	--------	--------	--------	--------	--------	--------	--------	--------	--------	--------	--------

COM/yds = 4¼, COL/sq ft = 77

▶ Specification Information, continued on next page

X10/15 = Last order entry
 October 18, 2015

Archipelago Lounge Chairs and Ottoman

DESIGN METRO DESIGN GROUP WITH EIGHT INC.

Tip: Handedness is determined while facing the chair.

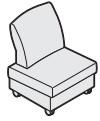

► Specification Information, continued from previous page

Specification Information

Style Number	U.S. Base Prices										Leather Grades:		
	Fabric Grades:										COL	C	E
	COM	6	7	8	9	10	11	12	13	14			

28"W Left-Section Lounge Chair

With Casters

910LC	✕10/15	\$2240	\$2289	\$2354	\$2407	\$2535	\$2605	\$2663	\$2793	\$2852	\$3131	\$2419	\$3915	\$4197
-------	--------	--------	--------	--------	--------	--------	--------	--------	--------	--------	--------	--------	--------	--------

With Glides

910LG	✕10/15	\$2240	\$2289	\$2354	\$2407	\$2535	\$2605	\$2663	\$2793	\$2852	\$3131	\$2419	\$3915	\$4197
-------	--------	--------	--------	--------	--------	--------	--------	--------	--------	--------	--------	--------	--------	--------

COM/yds = 4¼, COL/sq ft = 85

28"W Right-Section Lounge Chair

With Casters

910RC	✕10/15	\$2240	\$2289	\$2354	\$2407	\$2535	\$2605	\$2663	\$2793	\$2852	\$3131	\$2419	\$3915	\$4197
-------	--------	--------	--------	--------	--------	--------	--------	--------	--------	--------	--------	--------	--------	--------

With Glides

910RG	✕10/15	\$2240	\$2289	\$2354	\$2407	\$2535	\$2605	\$2663	\$2793	\$2852	\$3131	\$2419	\$3915	\$4197
-------	--------	--------	--------	--------	--------	--------	--------	--------	--------	--------	--------	--------	--------	--------

COM/yds = 4¼, COL/sq ft = 85

24"W Straight-Section Lounge Chair

With Casters

910XC	✕10/15	\$2105	\$2119	\$2172	\$2215	\$2322	\$2380	\$2427	\$2533	\$2581	\$2812	\$2233	\$3498	\$3729
-------	--------	--------	--------	--------	--------	--------	--------	--------	--------	--------	--------	--------	--------	--------

With Glides

910XG	✕10/15	\$2105	\$2119	\$2172	\$2215	\$2322	\$2380	\$2427	\$2533	\$2581	\$2812	\$2233	\$3498	\$3729
-------	--------	--------	--------	--------	--------	--------	--------	--------	--------	--------	--------	--------	--------	--------

COM/yds = 3½, COL/sq ft = 70

Specification Information

Dimensions			Style Number	U.S. Base Prices			
D	W	H		Lam 1	Lam 2	Wood 1	Upholstered

Elliptical Intermediate Arm

16"	8"	23½"	910IA	✕10/15	\$398	\$415	\$437	N.A.
-----	----	------	-------	--------	-------	-------	-------	------

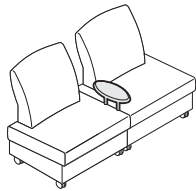

Left-Handed Elliptical End Arm

16"	8"	23½"	910EAL	✕10/15	\$398	\$415	\$437	N.A.
-----	----	------	--------	--------	-------	-------	-------	------

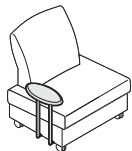

Right-Handed Elliptical End Arm

16"	8"	23½"	910EAR	✕10/15	\$398	\$415	\$437	N.A.
-----	----	------	--------	--------	-------	-------	-------	------

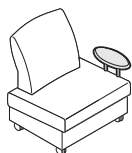

► Specification Information, continued on next page

✕10/15 = Last order entry
October 18, 2015

Archipelago Lounge Chairs and Ottoman *continued*

DESIGN METRO DESIGN GROUP WITH EIGHT INC.

Tip: Handedness is determined while facing the chair.

Tip: Fabrics and leathers will appear loose with comfort wrinkles when upholstered.

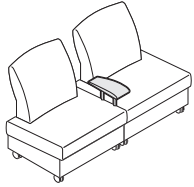

Tip: Fully upholstered arms do not require additional COM yardage or COL square footage.

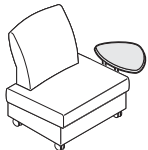
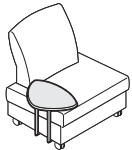
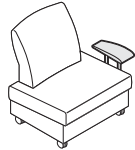
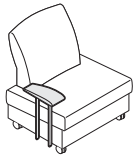

17½"D 23¾"W 16½"H

► Specification Information, continued from previous page

Specification Information

Dimensions			Style Number	U.S. Base Prices			
D	W	H		Lam 1	Lam 2	Wood 1	Upholstered

Fully Upholstered Intermediate Arm

14"	6"	23½"	910UIA ☒10/15	N.A.	N.A.	N.A.	\$650
-----	----	------	----------------------	------	------	------	-------

Left-Handed Fully Upholstered End Arm

14"	6"	23½"	910UEAL ☒10/15	N.A.	N.A.	N.A.	\$650
-----	----	------	-----------------------	------	------	------	-------

Right-Hand Fully Upholstered End Arm

14"	6"	23½"	910UEAR ☒10/15	N.A.	N.A.	N.A.	\$650
-----	----	------	-----------------------	------	------	------	-------

Left-Hand Tablet Arm

19¾"	13¾"	23½"	910TAL ☒10/15	\$740	\$776	\$850	N.A.
------	------	------	----------------------	-------	-------	-------	------

Right-Hand Tablet Arm

19¾"	13¾"	23½"	910TAR ☒10/15	\$740	\$776	\$850	N.A.
------	------	------	----------------------	-------	-------	-------	------

Specification Information

Style Number	U.S. Base Prices													
	Fabric Grades:													
	COM	6	7	8	9	10	11	12	13	14	Leather Grades:			
											COL	C	E	

Ottoman

911 ☒10/15	\$901	\$907	\$938	\$964	\$1024	\$1055	\$1085	\$1144	\$1173	\$1305	\$990	\$1866	\$2011
-------------------	-------	-------	-------	-------	--------	--------	--------	--------	--------	--------	-------	--------	--------

COM/yds = 2.5, COL/sq ft = 55



For Canadian Pricing
 Multiply U.S. Price by the Canadian price factor.
 ► See page 1 for details.

☒10/15 = Last order entry
 October 18, 2015

Archipelago Multi-Fabric Diagram and Yardage Request Form

DESIGN METRO DESIGN GROUP WITH EIGHT INC.

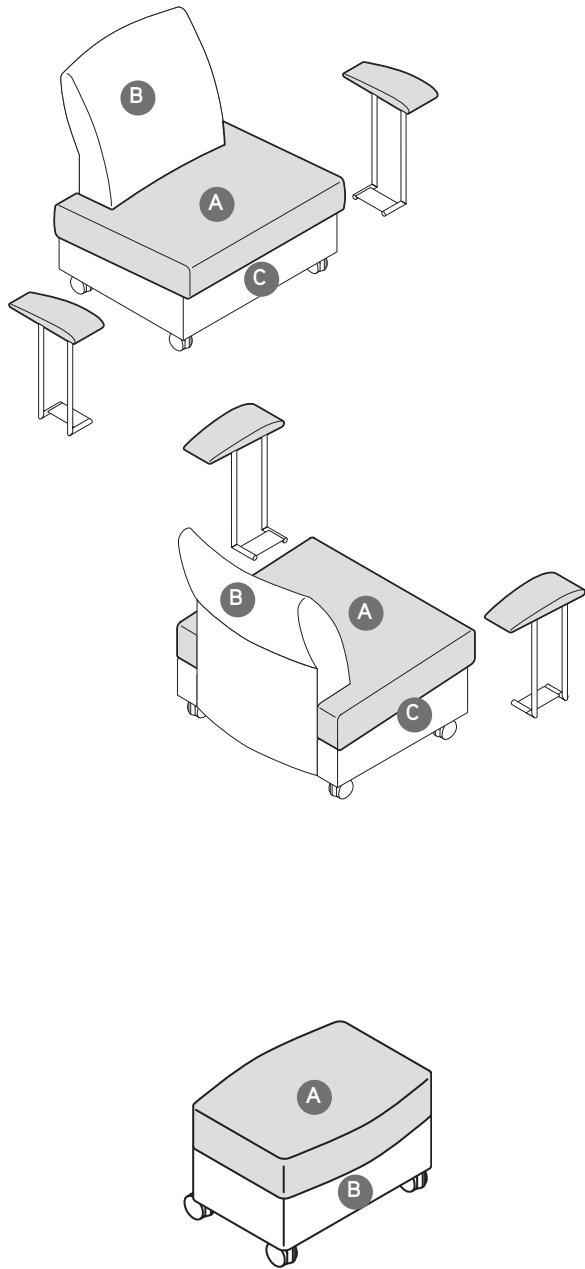

Lounge

TO: _____

FROM: _____

DATE: _____

FAX....888.413.5161

A Seat (upholstery selections default for entire unit if B is not selected): _____

B Back: _____

C Baseframe: _____

**Arms ordered as separate option.*

**\$118 U.S. list per contrasting fabric specified. List price based on highest fabric grade usage.*

Lounge Seating

Ottoman

TO: _____

FROM: _____

DATE: _____

FAX....888.413.5161

A Seat (upholstery selections default for entire unit if B is not selected): _____

B Baseframe: _____

For Canadian Pricing
 Multiply U.S. Price by the
 Canadian price factor.
 ▶ See page 1 for details.

Archipelago Multi-Fabric Yardage

DESIGN METRO DESIGN GROUP WITH EIGHT INC.

Multi-Fabric Yardage

CHAIR MODEL	STYLE NUMBER	COM YDS*		
		SEAT CUSHION	BACK CUSHION	BASE FRAME
Lounge with casters	910C	3	2	2 1/2
Lounge with glides	910G	3	2	2 1/2
Lounge with casters, left section	910LC	3	2	2 1/2
Lounge with glides, left section	910LG	3	2	2 1/2
Lounge with casters, right section	910RC	3	2	2 1/2
Lounge with glides, right section	910RG	3	2	2 1/2
Lounge with casters, straight section	910XC	3	2	2 1/2
Lounge with glides, straight section	910XG	3	2	2 1/2
Ottoman	911	1 1/4	N.A.	1 1/4

*Fabric yardage is based on non-directional/solid fabrics. Use conversion chart below for repeat/printed fabric yardage.

Non-standard fabric requirements

Yardage requirements shown are based on non-directional 54" w material applied railroaded. Coalesse will apply fabric railroaded unless instructed otherwise on the dealer's purchase order. The following conversion chart should be used to determine yardage requirements when COM has a repeat of 2" or more. Please contact Coalesse customer service for a yardage quotation if the fabric is less than 54" wide, has a repeat of more than 24", or if the fabric must be cut-right.

CONVERSION CHART

PRODUCT	REPEAT		
	2" - 8"	9" - 14"	15" - 24"
All other products	15%	25%	35%

Yardage quotations will also be provided for order of 10 or more pieces.

Cutting direction guidelines

Cutting direction is based on the fabric width and the way the fabric is cut from the roll and applied to Coalesse products. There are two cutting directions: railroaded or cut-right.

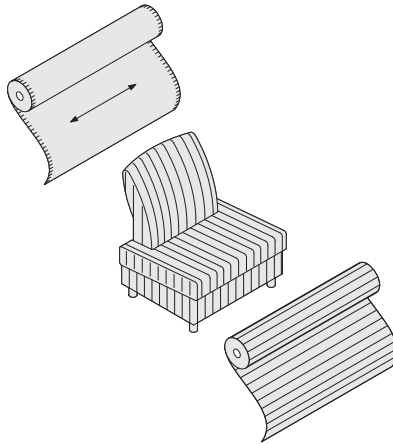

Horizontal or railroaded (across roll, warp horizontal) means fabric is cut across the roll; selvages are on the top and bottom.

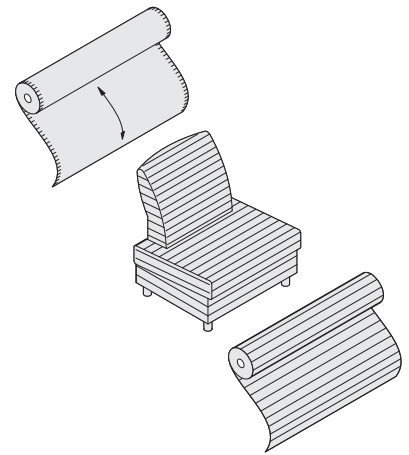

Vertical or cut-right (down roll, warp vertical) means fabric is cut in the same direction it is woven; selvages are on the left and right sides.

Coalesse reserves the right to railroad or apply fabric according to weave unless instructions specify otherwise. Fabrics are railroaded when possible to avoid seams in large upholstered areas and/or single cushion units. If a fabric is questionable, a cutting of adequate size showing full repeat (if any) should be sent to Coalesse for a fabric requirement quotation.

Coalesse

Archipelago Multi-Fabric Yardage

DESIGN METRO DESIGN GROUP WITH EIGHT INC.

Astor

DESIGN EDGAR REUTER DESIGN ORIGIN: GERMANY

 = Available in Rapid10.

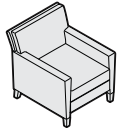

Overall: 34"D 30½"W 32"H
 Inside: 20"D 22"W 17"H
 Seat: 17"H
 Arm: 22"H

Tip: All cushions are loose.

Tip: Fabrics and leathers will appear loose with comfort wrinkles when upholstered.

Tip: Recommended leathers are Elmosoft Grade C and Elmorustical Grade E.

Tip: Special color match, consult customer service.

Tip: For Customer's Own Material or Leather, see necessary requirements, important processing instructions, and ordering information
 ▶ See *Coalesse Surface Materials Reference Guide*.

Standard Includes	Required to Specify
<ul style="list-style-type: none"> Chair <ul style="list-style-type: none"> - Seat, back, and fully upholstered arms: fabric or leather - Legs: wood - Glides: non-adjustable 	<ol style="list-style-type: none"> Style number Number of fabrics if contrasting fabric style number is selected Fabric or leather color number Wood color number for legs Options, if selected (see below) ▶ See <i>Coalesse Surface Materials Reference Guide</i> .

Options	U.S. Price	Required to Specify
Surface Materials <ul style="list-style-type: none"> Contrasting fabric 	+\$118 per fabric	Add suffix K to the style number and select fabric color number.
Acrylic backer <ul style="list-style-type: none"> Chair 	+\$ 48	Specify with acrylic backer. ▶ See <i>Coalesse Surface Materials Reference Guide</i> .
Attachment Straps <ul style="list-style-type: none"> Cushion attachment straps (318) 	+\$123	Specify with cushion attachment straps.

Specification Information

Style Number	U.S. Base Prices														Leather Grades:		
	Fabric Grades:														COL	C	E
	COM	6	7	8	9	10	11	12	13	14							

Chair

 318	\$2161	\$2293	\$2350	\$2408	\$2636	\$2891	\$3108	\$3312	\$3412	\$3523	\$2334	\$4466	\$5072
COM/yds = 5¼, COL/sq ft = 116													



For Canadian Pricing
 Multiply U.S. Price by the Canadian price factor.
 ▶ See page 1 for details.

Coalesse

Astor

DESIGN EDGAR REUTER DESIGN ORIGIN: GERMANY

Await Modular

DESIGN EOOS DESIGN ORIGIN: GERMANY

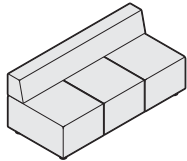

Tip: Recommended leathers are Elmosoft Grade C and Elmorustical Grade E.

Tip: Special color match, consult customer service.

Tip: For Customer's Own Material or Leather, see necessary requirements, important processing instructions, and ordering information
 ► See *Coalesse Surface Materials Reference Guide*.

Tip: Contrasting option available only on sofas.

Tip: Please include sketch for ganging.

Tip: Fabrics and leathers will appear loose with comfort wrinkles when upholstered.

Standard Includes	Required to Specify
-------------------	---------------------

- Frame: unibody construction with finger-jointed plywood
- Multiple densities of polyurethane foam and polyester foam and polyester fiber
- Sofa:
 - Seat and back: fabric or leather
 - Legs: black high-density polyurethane resin
 - Glides: non-adjustable
- Ottoman:
 - Seat: fabric or leather
 - Casters: non-locking

- 1 Style number
 - 2 Number of fabrics if contrasting fabric style number is selected
 - 3 Fabric or leather color number for upholstery on seat and back
 - 4 Options, if selected (see below)
- See *Coalesse Surface Materials Reference Guide*.

Options	U.S. Price	Required to Specify
---------	------------	---------------------

Surface Materials	<ul style="list-style-type: none"> • Contrasting fabric +\$118 per fabric 	Add suffix K to the style number and select fabric color number.
	<p>Fire code seating</p> <ul style="list-style-type: none"> • Three-seat sofa, four-seat sofa, and bench +\$600 • Ottoman +\$231 	Specify with <i>fire code seating</i> . Specify with <i>fire code seating</i> . ► See <i>Coalesse Surface Materials Reference Guide</i> .
	<p>Acrylic backer</p> <ul style="list-style-type: none"> • Three-seat sofa +\$ 54 • Four-seat sofa +\$ 67 • Four-seat bench +\$ 46 • Ottoman +\$ 15 	Specify with <i>acrylic backer</i> . Specify with <i>acrylic backer</i> . Specify with <i>acrylic backer</i> . Specify with <i>acrylic backer</i> . ► See <i>Coalesse Surface Materials Reference Guide</i> .
Floor Mount Legs	<ul style="list-style-type: none"> • Floor mount legs +\$123 per unit 	Specify with <i>floor mount legs</i> .



For Canadian Pricing
 Multiply U.S. Price by the Canadian price factor.
 ► See page 1 for details.

Await Modular

DESIGN EOOS DESIGN ORIGIN: GERMANY

Specification Information

Style Number	U.S. Base Prices													
	Fabric Grades:											Leather Grades:		
	COM	6	7	8	9	10	11	12	13	14	COL	C	E	

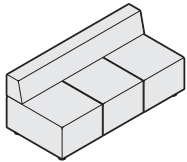

Overall: 30"D 66"W 27"H
 Inside: 22"D 66"W 27"H
 Seat: 16½"H
 Arm: 10½"H

Three-Seat Sofa

460-3	\$3345	\$3392	\$3430	\$3494	\$3689	\$3815	\$3962	\$4063	\$4244	\$4495	\$3489	\$6041	\$6502
--------------	--------	--------	--------	--------	--------	--------	--------	--------	--------	--------	--------	--------	--------

COM/yds = 5¾, COL/sq ft = 147

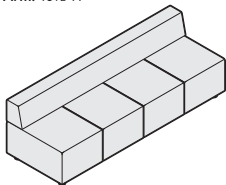

Overall: 30"D 88"W 27"H
 Inside: 22"D 88"W 27"H
 Seat: 16½"H
 Arm: 10½"H

Four-Seat Sofa

460-4	\$4079	\$4178	\$4225	\$4306	\$4552	\$4711	\$4896	\$5024	\$5252	\$5569	\$4223	\$7459	\$8035
--------------	--------	--------	--------	--------	--------	--------	--------	--------	--------	--------	--------	--------	--------

COM/yds = 7¼, COL/sq ft = 185



Overall: 30"D 88"W 16½"H
 Seat: 16½"H

Four-Seat Bench

460-4B	\$3026	\$3065	\$3101	\$3162	\$3349	\$3469	\$3609	\$3707	\$3880	\$4120	\$3170	\$5613	\$6049
---------------	--------	--------	--------	--------	--------	--------	--------	--------	--------	--------	--------	--------	--------

COM/yds = 5½, COL/sq ft = 100



Overall: 22"D 22"W 16½"H

Ottoman/Mobile

460-H	\$ 749	\$ 749	\$ 759	\$ 776	\$ 827	\$ 860	\$ 898	\$ 925	\$ 972	\$1037	\$ 992	\$1625	\$1740
--------------	--------	--------	--------	--------	--------	--------	--------	--------	--------	--------	--------	--------	--------

COM/yds = 1½, COL/sq ft = 33

Lounge Seating



For Canadian Pricing
 Multiply U.S. Price by the
 Canadian price factor.
 ▶ See page 1 for details.

Await Connector Benches

DESIGN EOOS DESIGN ORIGIN: GERMANY

 = Available in Rapid10.

Tip: Recommended leathers are Elmosoft Grade C and Elmorustical Grade E.

Tip: Special color match, consult customer service.

Tip: For Customer's Own Material or Leather, see necessary requirements, important processing instructions, and ordering information
 ▶ See *Coalesse Surface Materials Reference Guide*.

Tip: Please include sketch for ganging.

Tip: Fabrics and leathers will appear loose with comfort wrinkles when upholstered.

Standard Includes		Required to Specify	
	<ul style="list-style-type: none"> Bench: fabric or leather Frame: unibody construction with finger-jointed plywood Multiple densities of polyurethane foam Fixed seat Top and double needle stitching on seams Legs: black high-density polyurethane resin Glides 		1 Style number 2 Fabric or leather color number for upholstery on bench 3 Options, if selected (see below) ▶ See <i>Coalesse Surface Materials Reference Guide</i> .
Options		U.S. Price	Required to Specify
Surface Materials	<ul style="list-style-type: none"> Fire code seating One-section connector bench Two-section connector bench Three-section connector bench 	+\$231 +\$461 +\$600	Specify with <i>fire code seating</i> . Specify with <i>fire code seating</i> . Specify with <i>fire code seating</i> . ▶ See <i>Coalesse Surface Materials Reference Guide</i> .
	<ul style="list-style-type: none"> Acrylic backer One-section connector bench Two-section connector bench Three-section connector bench 	+\$ 22 +\$ 33 +\$ 48	Specify with <i>acrylic backer</i> . Specify with <i>acrylic backer</i> . Specify with <i>acrylic backer</i> . ▶ See <i>Coalesse Surface Materials Reference Guide</i> .
Floor Mount Legs	<ul style="list-style-type: none"> Field-installed floor mount legs 	+\$123 per unit	Specify with <i>floor mount legs</i> .

Specification Information

Style Number	U.S. Base Prices														Leather Grades:		
	Fabric Grades:														COL	C	E
COM	6	7	8	9	10	11	12	13	14								

One-Section Connector Bench

461-1B	\$1381	\$1381	\$1396	\$1421	\$1497	\$1547	\$1604	\$1644	\$1715	\$1813	\$1598	\$2571	\$2746
--------	--------	--------	--------	--------	--------	--------	--------	--------	--------	--------	--------	--------	--------

COM/yds = 2¹/₄, COL/sq ft = 53

Two-Section Connector Bench

461-2B	\$2123	\$2123	\$2147	\$2189	\$2316	\$2399	\$2494	\$2560	\$2678	\$2842	\$2288	\$3937	\$4236
--------	--------	--------	--------	--------	--------	--------	--------	--------	--------	--------	--------	--------	--------

COM/yds = 3³/₄, COL/sq ft = 83

Three-Section Connector Bench

461-3B	\$2924	\$2963	\$2999	\$3060	\$3247	\$3367	\$3507	\$3605	\$3778	\$4018	\$3068	\$5397	\$5814
--------	--------	--------	--------	--------	--------	--------	--------	--------	--------	--------	--------	--------	--------

COM/yds = 5, COL/sq ft = 110

Ganging Kit

460-GANGPKG	\$ 46
-------------	-------

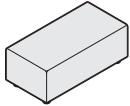

Overall: 44"D 22"W 16¹/₂"H

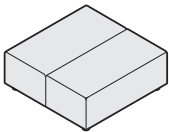

Overall: 44"D 44"W 16¹/₂"H

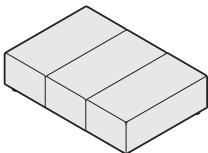

Overall: 44"D 66"W 16¹/₂"H



For Canadian Pricing
 Multiply U.S. Price by the Canadian price factor.
 ▶ See page 1 for details.

Await Tables

DESIGN EOOS DESIGN ORIGIN: GERMANY

 = Available in Rapid10.

Tip: Await connector tables are not recommended to be used in end-of-run applications.

Tip: Await connector tables are not made for ganging to Await mobile ottoman.

Standard Includes	Required to Specify
-------------------	---------------------

- Freestanding table frame: silver
- Connector table frame: panels are black, white, or gray
- Top: High-Pressure Laminate top with matching 3 mm edge band
- Glass top (tablet):
 - 1/2" thick
 - Radiused edges
- Ganging plate: 1/4" thick ganging plates attach to the bottom of units to the seating unit plates

- 1 Style number
- 2 Laminate top and tablets, if selected:
 - 2595 Black
 - 2730 Arctic White
 - 2906 North Sea
- 3 Glass color number for top, if selected
 - ▶ See *Coalesse Surface Materials Reference Guide*.

Specification Information

Style Number	U.S. Prices			
	Top Surface:			
	Laminate	Clear Green/ Clear Green Frosted Glass Top	Absolute Clear/ Clear Frosted Glass Top	Colored Glass Top

Freestanding Low Round Table

 46-T1	\$1048	\$1253	\$1276	\$1444
---	--------	--------	--------	--------

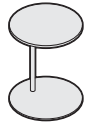

Overall: 15 3/4" Dia. 19"H

Freestanding High Round Table

 46-T2	\$1369	\$1574	\$1597	\$1765
--	--------	--------	--------	--------



Overall: 15 3/4" Dia. 25"H

Specification Information

Style Number	U.S. Prices								
	Laminate Top:			Glass Tablet:					
	No Tablet	Tablet	Power/Data	Clear Green/ Clear Green Frosted Glass Tablet	Clear Green/ Clear Green Frosted Tablet and Power/Data	Absolute Clear/ Clear Frosted Glass Tablet	Absolute Clear/ Clear Frosted Tablet and Power/Data	Colored Glass Tablet	Colored Tablet and Power/Data

Connector Tables

460-SE22	\$ 646	\$1483	N.A.	\$1542	N.A.	\$1564	N.A.	\$1725	N.A.
460-SE22PD	\$1763	N.A.	\$1763	N.A.	\$1867	N.A.	\$1888	N.A.	\$2048

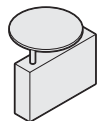

Overall: 20"D 4 1/2"W 15 3/4"H
With Tablet: 15 3/4" Dia. and 25 3/8"H

460-SE30	\$ 739	\$1576	N.A.	\$1635	N.A.	\$1662	N.A.	\$1818	N.A.
460-SE30PD	\$1861	N.A.	\$1861	N.A.	\$1965	N.A.	\$1986	N.A.	\$2146

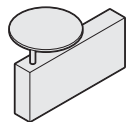

Overall: 28"D 4 1/2"W 15 3/4"H
With Tablet: 15 3/4" Dia. and 25 3/8"H

460-SE44	\$ 908	\$2582	N.A.	\$2626	N.A.	\$2671	N.A.	\$2987	N.A.
460-SE44PD	\$2858	N.A.	\$2858	N.A.	\$2996	N.A.	\$3039	N.A.	\$3361

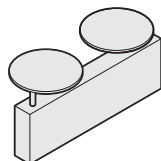

Overall: 42"D 4 1/2"W 25 3/8"H
With Tablets: 15 3/4" Dia. and 25 3/8"H

Await Ganging Diagrams by Model (Underside View)

DESIGN EOOS DESIGN ORIGIN: GERMANY

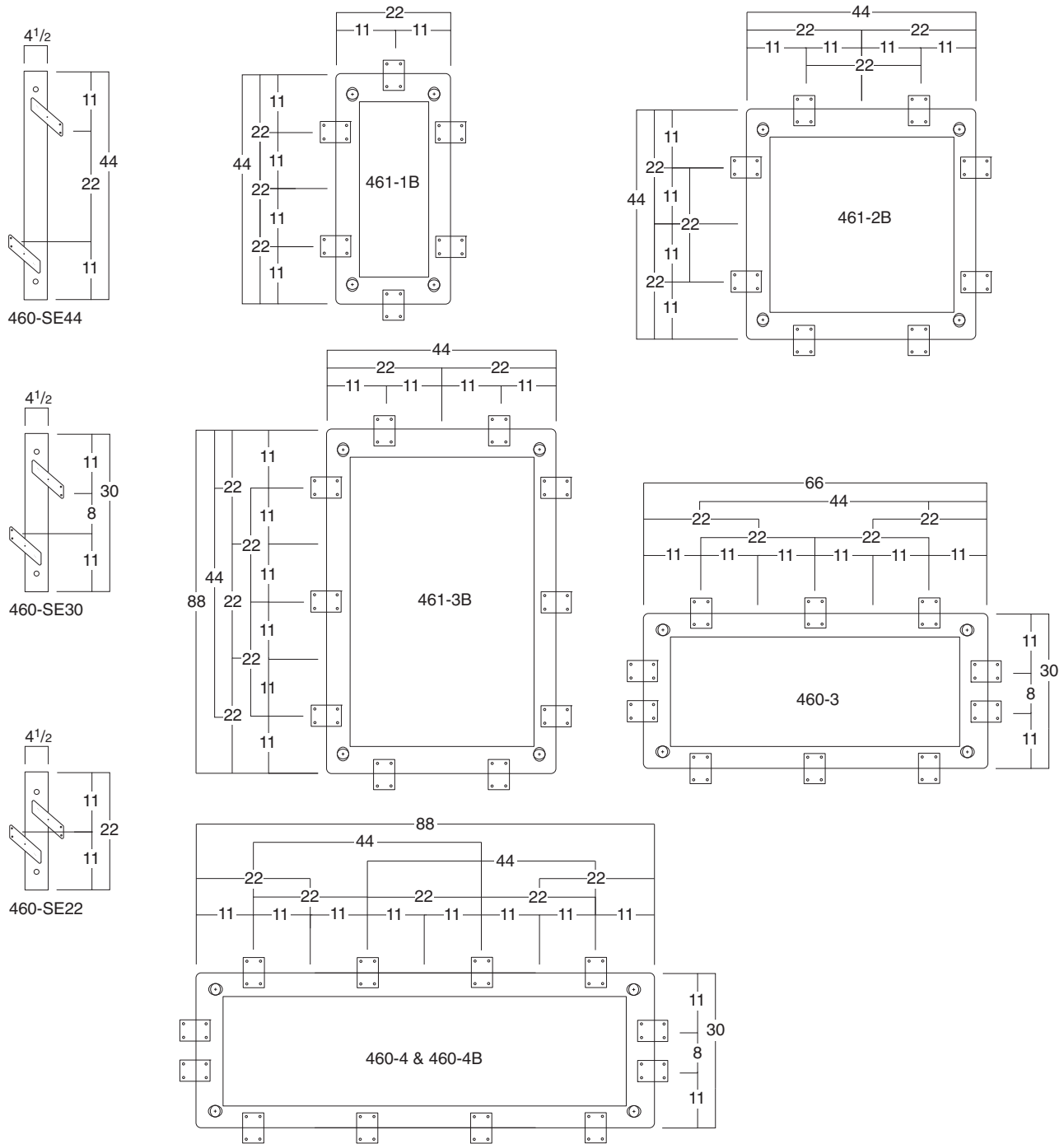

Await Multi-Fabric Diagram

TO: _____

FROM: _____

DATE: _____

FAX....888.413.5161

A Seat (upholstery selections default for entire unit if B is not selected):

B Back: _____

\$118 U.S. list per contrasting fabric specified. List price based on highest fabric grade usage.

Specify Model below:

460-3K

460-4K

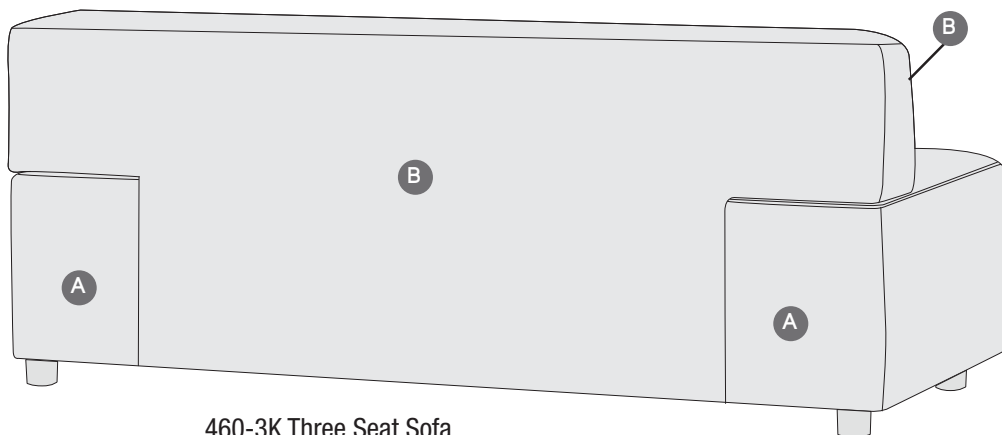
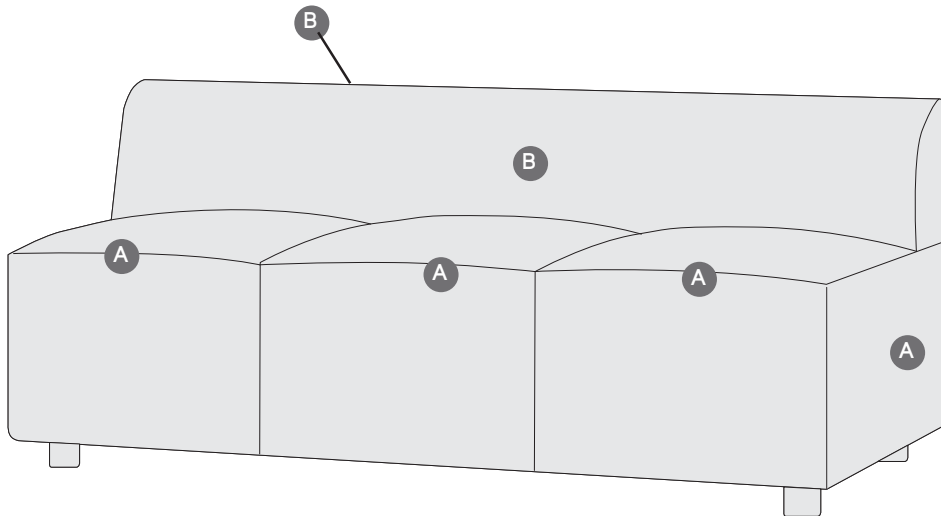

460-3K Three Seat Sofa

 **For Canadian Pricing**
 Multiply U.S. Price by the
 Canadian price factor.
 ▶ See page 1 for details.

Bix

DESIGN METRO DESIGN GROUP

Bix offers a system of seating and tables that can create a variety of lounge-based applications that address group or individual work needs. Each application provides convenient connections to power, voice, and data.

Group meeting area created with Bix furniture offers a sense of enclosure without walls for collaborating and provides social and physical comfort.

Back screen is available on select units to provide privacy and divide space. It is upholstered.

Seat is upholstered.

Arms are available on select seating units. They are upholstered.

Back is upholstered.

Sled base on a lounge chair is finished with paint. The back of the sled base does not extend past the chair back.

Side table offers a freestanding mobile tablet surface. It is available in vinyl.

Projection screen is available on podium seating for presentations and to divide space. It also accommodates Steelcase huddleboards.

Bolster is upholstered.

Storage drawer is available on select models to store equipment or presentation tools.

Face lock, keyed randomly, is standard on storage drawers to secure the items stored in it.

Legs and base are constructed with steel tubing and steel plates for structural integrity. They are finished with paint. They are either inset under the seating unit (sled base) or slant off the back of a unit (legs).

Tablet provides a surface for presenter's notes, laptop computer, or wireless mouse.

Leveling glides adjust for installations on uneven floors. Adjustability range is 3/4".

Service tray is optional.

Actual Dimensions
▶ See page 74

Product Details

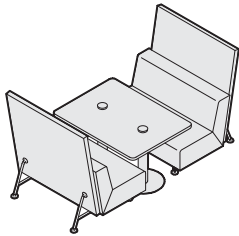

Individual work-booth area provides an alternative to a confined workstation. It offers a semi-private setting for temporary tasks that require projects to be spread out. It is created by grouping two straight sectionals or lounge chairs with a 27"H work-booth table.

Tip: Extended corner sectionals or straight sections with arms should not be used in a work-booth application because access to the seating area is obstructed.

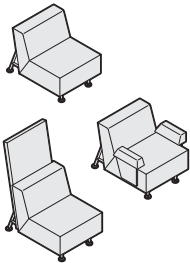

Lounge chairs are available with or without upholstered back screens. Models with upholstered arms are also available.

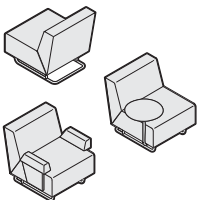

Sled lounge chairs feature a compact base that is designed for small spaces or to be used flush against the wall. They are available with or without upholstered arms or a tablet arm.

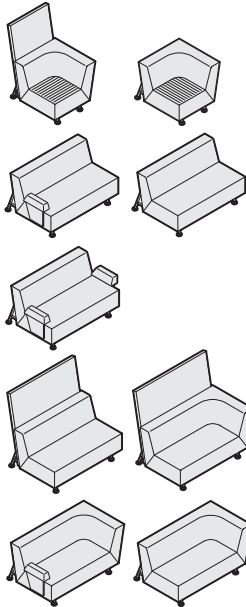

Sectional seating is offered in corner, extended corner, and straight units to provide a variety of configurations. They are offered with or without back screens and with or without arms. All sections include an integrated ganging device. Corner sectional units are handed. Handedness is determined by the location of the back screen or back support legs.

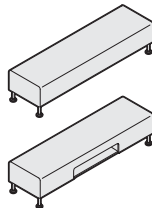

Bench provides a backless seating option. It can also be used as an alternative soft occasional table. An open storage space that is accessible from either side is available for storing magazine and media equipment. Bench can accommodate a service tray.

18" seat height is an available option on all lounge, sectional seating, bench, and podiums. This option should not be used in conjunction with work booth tables. It allows a higher sit for healthcare applications.

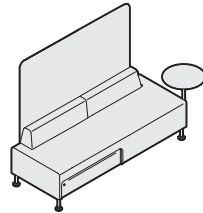

Podium serves as a focal point for lounge-based meeting spaces and provides comfortable seating for the presenter. A lockable storage drawer secures projection equipment or presentation tools. A fixed tablet arm provides a surface for presenter's notes, laptop computer, or wireless mouse. Podium can accommodate a service tray.

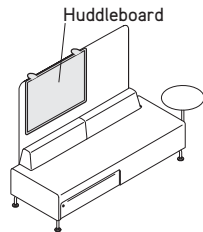

Integrated projection screen is available on select podium units for slides or projected digital media. It can also be used to divide an open space. The screen is a fine white mesh that allows light to filter through when the screen is used as a space divider. It also accommodates a Steelcase huddleboard.

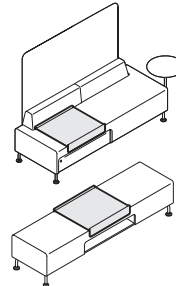

Service tray rests on benches and podium units for food service or to support projection equipment in a lounge-base meeting space.

Multiple fabrics can be specified on lounge, sectional, and podium seating units for an additional fee per specified fabric.

- Seat cushion and sides of seat cushion - no additional fee
- Back cushion and sides of back cushion - additional fee
- Back screen (if selected) - no additional fee
- Armrest (if selected) - no additional fee

► See *Bix Multi-Fabric Diagram and Yardage Request Form*, pages 87 and 92.

Tip: Fabric for the seat and back is specified separate from the back screen, if selected. For a monochromatic look, specify the same fabric for both the seat and back and back screen.

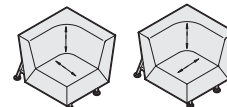

30"W corner sectional units are available with the two fabric direction options for the seat - railroaded or cut-right. Seat fabric direction is determined by its relationship to the back screen or back support legs.

Tip: Seat fabric on extended corner and straight sections is always railroaded.

► Page 94

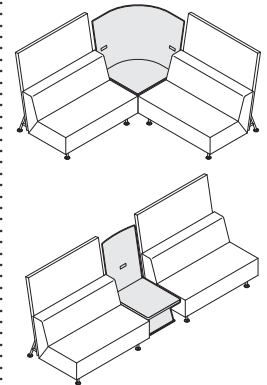

Bridge tables integrate with Bix sectional seating to create a range of lounge-based applications and are available with two top shapes - rectangular and corner. Translucent screens are available to create a sense of visual privacy for open space environments. The worksurface is available with or without a grommet and an optional power, voice, and data module.

The rectangular table features an integrated 18"W x 12 1/2"H tilted display surface for magazines or project folders.

Tip: Bridge tables are used with sectional seating. They do not attach to benches or podiums.

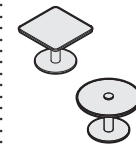

Occasional tables are freestanding 18"H tables that can be used a variety of lounge applications. They are available with a round, square, or rectangular top. The tops are available with or without a grommet and an optional power, voice, and data module.

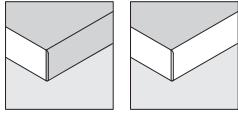

Plastic edge Wood edge

Edge detail is available in either plastic or wood edge.

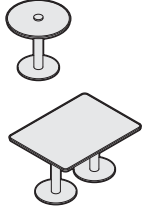

Work-booth tables are free-standing 27"H tables that are used with sectional seating to create a work-booth configuration. They are available with either a round or rectangular top. The tops are available with or without a grommet and an optional power, voice, and data module. Base features a low profile for foot clearance.



Side table offers a freestanding, mobile tablet surface. The tripod base allows it to be positioned close to a seating unit. The top is available in vinyl.



Back screen is available on lounge and sectional seating. It is fully upholstered with a zipper detail. However, it is not removable. Back screens must be ordered with the chair. It cannot be retrofitted to an existing backless lounge chair or seating sections.

Connections

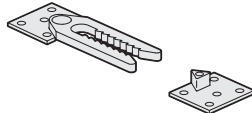

Integrated ganging device, included, connects sectional seating units together in the field. It is not intended for user reconfiguration.

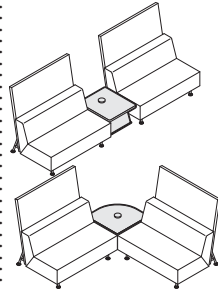

Bridge tables connect on both sides between sectional seating units. A rectangular top is used in an in-line configuration. A corner top is used in an L-shape configuration.

Exception: Bridge tables cannot attach to a seating unit with arms.

Lounge chairs are independent and are not intended to connect to sectional units or bridge tables.

▶ See How To Plan, page 76

Wiring & Cabling

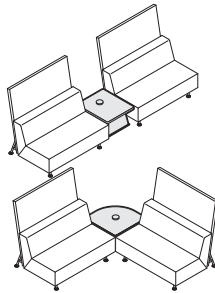

Bridge tables are available with a grommet, factory installed, to allow cords and cables to pass through the top. Wire management clips, attached to the underside of the top, are used to route cords and cables. A power, voice, and data module can be inserted in the grommet.

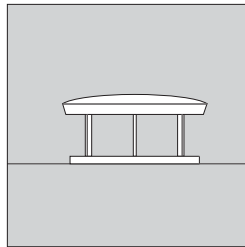
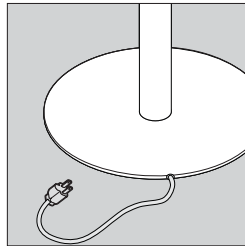

Occasional and work-booth tables are available with a factory-installed grommet located over each column and base to allow cords and cables to pass through the top. A power, voice, and data module can be inserted in each grommet location.

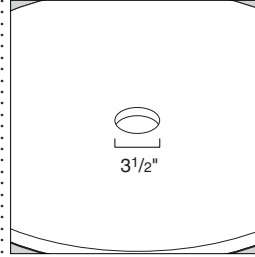

The work surface cutout for the grommet and PVD is 3 1/2" in diameter.

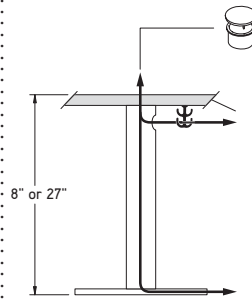

Column and base of occasional and work-booth tables are used to route and conceal cords. The cords pass through the work surface down through the column and out through a mouse hole in the base plate. Bases may be installed with the mouse hole facing in any of four directions, depending upon where cords need to exit for access to power/data/voice in the wall or floor. Cords should be routed through the concealed channels and out the mouse hole during the installation of the table base.

Hole at the top of each column allows cords to be routed between tables directly below the work surfaces. Wire management clips are included for routing purposes.

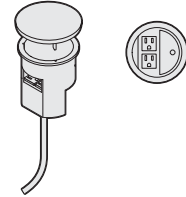

Power, voice, and data module can be installed in the grommet locations to bring power and communication to the work surface. Each module is equipped with two 110volt electrical outlets and one snap-in voice/data module insert consisting of dual CAT 5 RJ45 universal T568A/B jacks. It is UL listed and CSA certified. It has a 6' power cord. For additional data/voice outlet options, please contact Metro customer service at 1.800.627.6770.

Hardwired applications require on-site modifications by a licensed electrician following all local electrical code requirements.

Tip: The base will accommodate a 3/8" diameter flex-conduit.

Bix

DESIGN METRO DESIGN GROUP

Surface Materials

Seat and back

- Fabric

Arms

- Fabric

Bolster

- Fabric

Legs

- Paint

Sled base

- Paint

Glides

- Paint and nylon bottom

Back screen

- Fabric

Projection screen

- White mesh only

Projection screen frame

- Paint

Tablet surface

- Bronco onyx vinyl

Tablet support

- Paint

Open storage interior

- Paint

Storage drawer front

- Laminate (standard)
- Wood (option), high sheen only
- Custom wood finish (option), high sheen only

Integrated storage drawer pull

- Paint

Service tray frame

- Paint

Bridge, occasional, and work-booth table surface

- Laminate with matching 3 mm plastic edge
- Wood with matching wood edge
- Custom wood finish (option)

Bridge table frame and tilted display surface

- Paint

Bridge table screen

- Translucent material

Occasional and work-booth table base

- Paint (textured only)

Grommet

- Black plastic only

Side table surface and base cover

- Bronco onyx vinyl

Side table base

- Paint (vinyl)

Note: Refer to the Coalesse Surface Materials Reference Guide for additional surface materials information.

Programs & Services

Fire code seating (FCS) modifications are available to meet CAL TB133 requirements.

► See *Coalesse Surface Materials Reference Guide*.

Customer's Own

Material/Leather (COM/COL)

Program is available.

► See *Coalesse Surface Materials Reference Guide* for additional information,

Note: Due to unusual upholstery conditions inherent in the design of Bix, not all seating fabrics may be specified. Refer to www.metrofurniture.com for a list of pre-approved DesignTex fabrics on Bix. Pre-approval is required for all COM fabric.

Also, due to the geometric shapes and flat planes of the Bix design, seat fabric tautness will vary depending upon the amount of stretch in the fabric. Leather naturally stretches with use.

Designers

Metro Design Group | San Francisco

Actual Dimensions

	Overall Depth	Width	Height	Seat Depth	Width	Seat Height From Floor	Back Height From Seat	Arm Height
Lounge	38½"	26" or 30"	29" or 31"	19½"	26"	16" or 18"	13½"	22"
Sled lounge	30½"	26", 30", or 36½"	29"	19½"	26"	16"	13½"	22"
Sled lounge tablet arm	17" Dia.	N.A.	N.A.	N.A.	N.A.	N.A.	N.A.	N.A.
Corner sectional	38½"	30"	29" or 31" 49½" or 51½"	19½"	19½"	16" or 18"	13½"	N.A.
Extended corner sectional	38½"	54" or 56"	29" or 31" 49½" or 51½"	19½"	48" or 72"	16" or 18"	13½"	22½"
Straight sectional, no arms	38½"	48" or 72"	29" or 31" 49½" or 51½"	19½"	48" or 72"	16" or 18"	13½"	N.A.
Straight sectional, one arm	38½"	50" or 74"	29" or 31" 49½" or 51½"	19½"	48" or 72"	16" or 18"	13½"	22½"
Straight sectional, two arms	38½"	52" or 76"	29" or 31"	19½"	48" or 72"	16" or 18"	13½"	22½"
Back screen	1¾"	23½", 45½", 51½", or 69"	49" or 51"	N.A.	N.A.	N.A.	N.A.	N.A.
Bench	19½"	48" or 72"	16" or 18"	N.A.	N.A.	16" or 18"	N.A.	N.A.
Podium	26½"	81⅞" Includes tablet	25" or 27" 52" or 54"	19½"	N.A.	16" or 18"	7" or 34"	N.A.
Podium tablet arm	17" Dia.	N.A.	26"	N.A.	N.A.	N.A.	N.A.	N.A.
Projection screen	N.A.	59"	27"	N.A.	N.A.	N.A.	N.A.	N.A.
Service tray	20"	22"	4"	N.A.	N.A.	N.A.	N.A.	N.A.
Service tray mat area	18¼"	21½"	N.A.	N.A.	N.A.	N.A.	N.A.	N.A.
Rectangular bridge table	26"	22"	18" or 46"	N.A.	N.A.	N.A.	N.A.	N.A.
Corner bridge tables	26"	26"	18" or 20" 46" or 48"	N.A.	N.A.	N.A.	N.A.	N.A.
Bridge table screen	N.A.	22"	46"	N.A.	N.A.	N.A.	N.A.	N.A.
Round occasional tables	20" or 28" Dia.	N.A.	18"	N.A.	N.A.	N.A.	N.A.	N.A.
Square occasional tables	24"	24"	18"	N.A.	N.A.	N.A.	N.A.	N.A.
Rectangular occasional tables	24"	48" or 72"	18"	N.A.	N.A.	N.A.	N.A.	N.A.
Occasional table base	18" Dia.	N.A.	N.A.	N.A.	N.A.	N.A.	N.A.	N.A.
Occasional table column	4" Dia.	N.A.	N.A.	N.A.	N.A.	N.A.	N.A.	N.A.
Round work-booth tables	20" or 28" Dia.	N.A.	27"	N.A.	N.A.	N.A.	N.A.	N.A.
Rectangular work-booth tables	36"	48" or 72"	27"	N.A.	N.A.	N.A.	N.A.	N.A.
Side table	16" Dia.	N.A.	23"	N.A.	N.A.	N.A.	N.A.	N.A.

Coalesse

Bix

DESIGN METRO DESIGN GROUP

Bix How To Plan

DESIGN METRO DESIGN GROUP

Configuration guidelines — work settings with podium, benches & bridge tables

A variety of configurations may be created to support lounge-based meeting spaces using the Bix podium as a focal point. Benches and bridge tables support media projection equipment. As projection equipment varies, you will need to verify the distance required between the equipment and projection screen when planning your space. The examples below are suggested layouts.

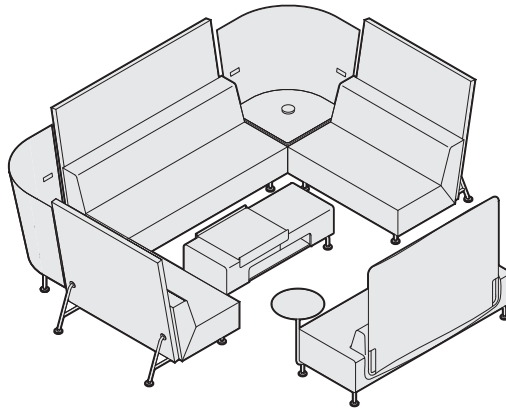

Configuration Examples

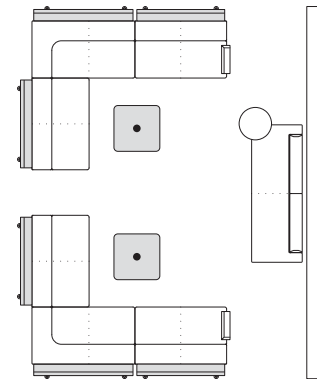
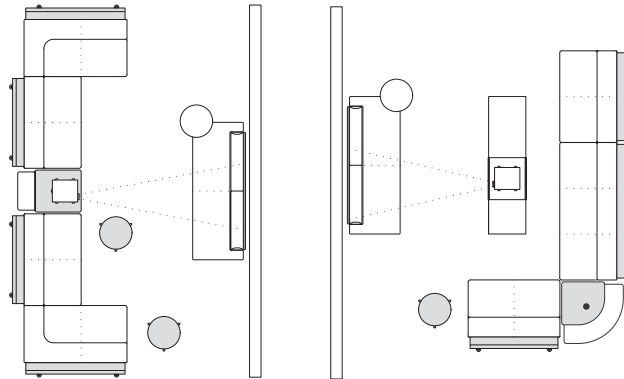
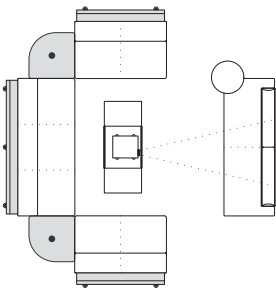
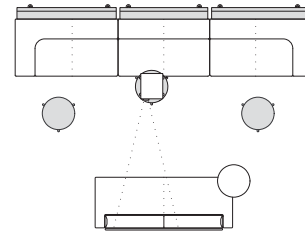
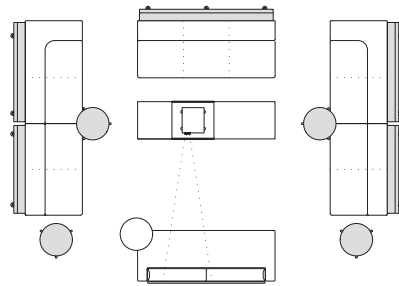
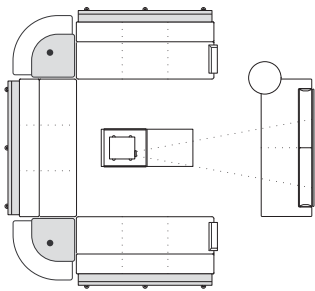

Bix How To Plan

DESIGN METRO DESIGN GROUP

Configuration guidelines –
 work-booths with 27" high tables
 Two straight sections are grouped with 27" high tables to create work-booth applications.
 Lounge chairs may also be specified with 27" high tables to create a two-person work-booth.
 Facing seats edges should be spaced 24"-27" apart from one another to accommodate leg clearance and maintain the correct user relationship to the worksurface. The table base is centered within the 24"-27" space.

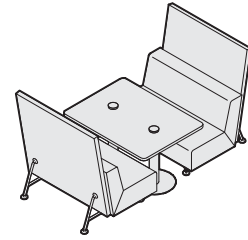

Configuration Examples

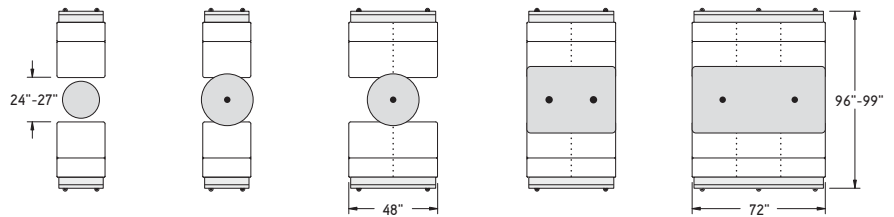

Configuration guidelines –
 work settings with 18" high tables
 A variety of configurations may be created by combining sectional seating and 18" high tables. The Bix system is built upon a 12"/24" dimension module for planning.
 Seats are 24" wide. Rectangular tables are 24" deep. Tables are spaced 12" from seat edges. A 24" opening should be maintained for large 360° group enclaves.

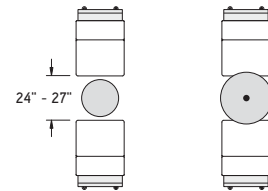

Configuration Examples

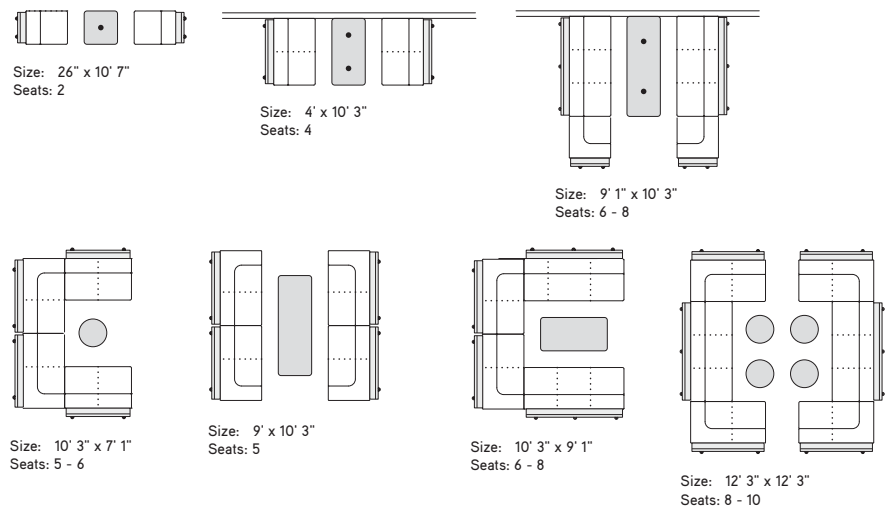

Bix How To Plan *continued*

DESIGN METRO DESIGN GROUP

Configuration guidelines – DON'TS

- 30" wide corner sections are not intended to be freestanding. 30" wide corner sections must always be connected to an adjoining 54" wide extended corner or straight section, using the ganging hardware provided.

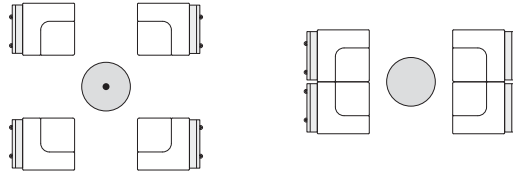

- Individual lounge chairs are independent elements not designed as a module within the seating system. The lounge chair seat is wider than the 24" system module and lounge chairs do not include ganging hardware. Bridge tables also do not connect to lounge chairs.

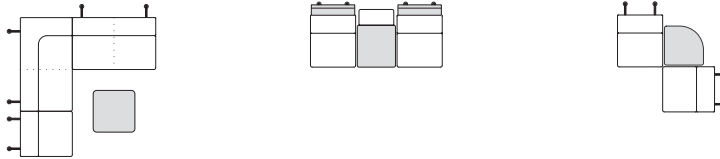

- Do not create a U-shaped configuration with a 27" high rectangular table. Access to the closed end is difficult and the table edge is too far from reach for the user.

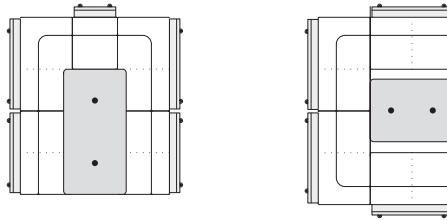

- Do not use 54" wide extended corner sections or straight sections with arms to create a work-booth configuration with 27" high tables. Access is obstructed.

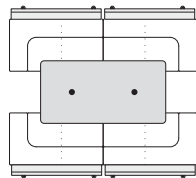

- Bridge tables must be connected on both sides to a seating section.



- Bridge tables do not connect to seating sections with arms. Seating sections do not gang with arms at the seam.

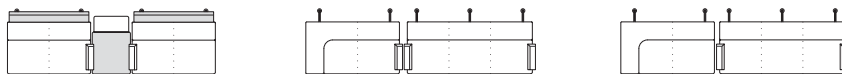

- Do not attach 30" wide corner sections to a corner bridge table. This application does not allow enough leg room for two users.

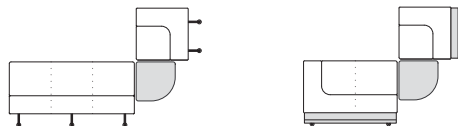

- Bridge tables do not attach to benches or podiums.



Bix How To Plan

DESIGN METRO DESIGN GROUP

Orientation & fabric direction

Corner units are handed from a facing position. Handedness for 30"W corner units is determined by the location of the back-screen or back support legs. Location of back-screens should be considered for each configuration. In order to create a consistent pattern across seats in the configuration,

30"W corner units are available with two seat fabric direction options. Seat fabric direction is determined by its relationship to the back-screen or back support legs. Seat and back fabric on 54"W extended corner and straight sections is always railroaded.

Examples below assume a striped patterned fabric:

30"W Corner Sections

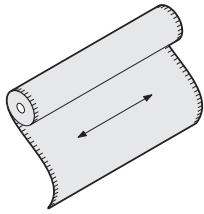

Arrow indicates direction of the pattern on the roll

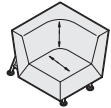

Left-hand, fabric railroaded BSC30LA

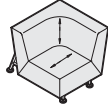

Left-hand, fabric cut-right BSC30LB

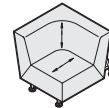

Right-hand, fabric railroaded BSC30RA

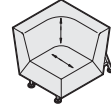

Right-hand, fabric cut-right BSC30RB

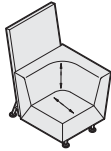

Left-hand, fabric railroaded BSCB30LA

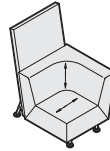

Left-hand, fabric cut-right BSCB30LB

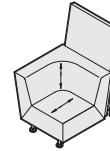

Right-hand, fabric railroaded BSCB30RA

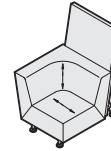

Right-hand, fabric cut-right BSCB30RB

54"W Extended Corner and Straight Sections

Note: Seat and back fabric is always railroaded

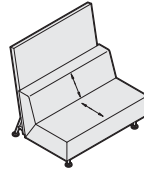
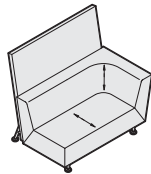

Configuration Examples

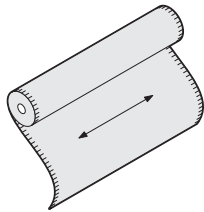

Arrow indicates direction of the pattern on the roll

Right-hand, fabric railroaded BSCB30RA

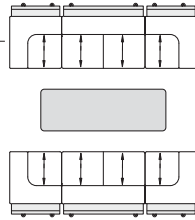

Left-hand, fabric railroaded BSCB30LA

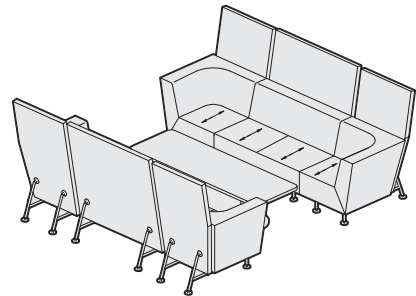

Left-hand, fabric cut-right BSCB30LB

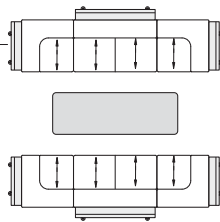

Right-hand, fabric cut-right BSCB30RB

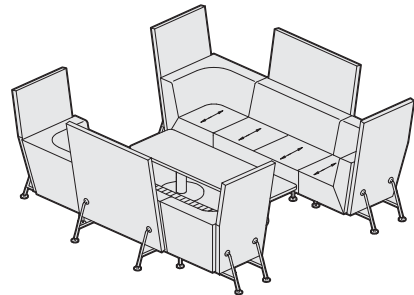

Bix Lounge Chairs

DESIGN METRO DESIGN GROUP

Tip: Fabric for the seat and back is specified separate from the back screen, if selected. For a monochromatic look, specify the same fabric for both the seat and back and back screen.

Tip: Fabrics and leathers will appear loose with comfort wrinkles when upholstered.

Tip: When specifying fabric in different price grades, the highest price grade prevails.

Tip: The COM yards and COL square footage listed on this page reflect the requirements for a single fabric that are based on non-directional 54"W material applied rail-roaded. For multi-fabric COM requirements, please refer to Multi-Fabric Yardage. ▶Page 93

Standard Includes		Required to Specify
▶ Need help? Product details, page 70	<ul style="list-style-type: none"> • Seat, back, and arms, if selected: fabric or leather • Legs: paint • Adjustable glides: paint to match legs • Back screen, if selected: fabric • Leveling wrench 	<ol style="list-style-type: none"> 1 Style number 2 Number of fabrics if contrasting fabric style number is selected 3 Fabric or leather color number for seat, back, and arms, if selected 4 Paint color number for legs and glides 5 Fabric color number for back screen, if selected 6 Options, if selected (see below) <p>▶ See <i>Coalesse Surface Materials Reference Guide</i>.</p>

Options	U.S. Price	Required to Specify
Surface Materials	<ul style="list-style-type: none"> • Contrasting fabric +\$118 per fabric 	Add suffix K to the style number and select fabric color number.
Fire code seating	<ul style="list-style-type: none"> • Lounge chair +\$231 • Lounge chair with arms +\$301 • Lounge chair with back screen +\$461 	<p>Specify with fire code seating.</p> <p>Specify with fire code seating.</p> <p>Specify with fire code seating.</p> <p>▶ See <i>Coalesse Surface Materials Reference Guide</i>.</p>
Acrylic backer	<ul style="list-style-type: none"> • Lounge chair +\$ 34 • Lounge chair with arms +\$ 46 • Lounge chair with back screen +\$ 56 	<p>Specify with acrylic backer.</p> <p>Specify with acrylic backer.</p> <p>Specify with acrylic backer.</p> <p>▶ See <i>Coalesse Surface Materials Reference Guide</i>.</p>
Seat Height	<ul style="list-style-type: none"> • 18" seat height +\$227 	Specify with 18" seat height.
Related Products	<ul style="list-style-type: none"> • Sectional seating • Bench • Podium • Occasional tables • Work booth tables • Side tables 	<p>▶ Page 82</p> <p>▶ Page 88</p> <p>▶ Page 90</p> <p>▶ Page 98</p> <p>▶ Page 99</p> <p>▶ Page 100</p>

Specification Information													
Style Number	U.S. Base Prices											Leather Grades:	
	Fabric Grades:											COL	C
	COM	6	7	8	9	10	11	12	13	14			

Lounge Chair													
BL26XX	\$1702	\$1702	\$1720	\$1751	\$1844	\$1905	\$1975	\$2023	\$2110	\$2230	\$1859	\$2772	\$2938
COM/yds = 2¾, COL/sq ft = 55													

Lounge Chair with Arms													
BL26AA	\$2381	\$2381	\$2405	\$2447	\$2574	\$2657	\$2752	\$2818	\$2936	\$3100	\$2603	\$3605	\$3805
COM/yds = 3¾, COL/sq ft = 73													

Lounge Chair with Back Screen													
BLB26XX	\$2454	\$2458	\$2488	\$2538	\$2691	\$2790	\$2904	\$2984	\$3125	\$3322	\$2664	\$4033	\$4300
Chair: COM/yds = 2¾, COL/sq ft = 55													
Screen: COM/yds = 1¾													

Back cushion

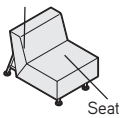

Seat

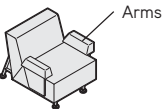

Arms

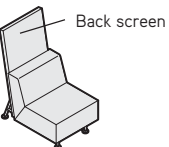

Back screen

Bix Sled Lounge Chairs

DESIGN METRO DESIGN GROUP

Tip: The COM yards and COL square footage listed on this page reflect the requirements for a single fabric that are based on non-directional 54"W material applied rail-roaded. For multi-fabric COM requirements, please refer to Multi-Fabric Yardage.
▶ Page 93

Tip: When specifying fabric in different price grades, the highest price grade prevails.

Standard Includes		Required to Specify	
▶ Need help? Product details, page 70	<ul style="list-style-type: none"> • Seat, back, and arms, if selected: fabric or leather • Base and tablet support, if selected: paint • Glides • Tablet surface: bronco onyx vinyl 	<ol style="list-style-type: none"> 1 Style number 2 Number of fabrics if contrasting fabric style number is selected 3 Fabric or leather color number for seat, back, and arms, if selected 4 Paint color number for base and tablet, if selected 5 Options, if selected (see below) 	▶ See <i>Coalesse Surface Materials Reference Guide</i> .

Options	U.S. Price	Required to Specify	
Surface Materials	<ul style="list-style-type: none"> • Contrasting fabric 	+\$118 per fabric	Add suffix K to the style number and select fabric color number.
	Fire code seating		
	<ul style="list-style-type: none"> • Lounge chair and lounge chair with tablet arm • Lounge chair with arms 	+\$231 +\$301	Specify with <i>fire code seating</i> . Specify with <i>fire code seating</i> . ▶ See <i>Coalesse Surface Materials Reference Guide</i> .
	Acrylic backer		
	<ul style="list-style-type: none"> • Lounge chair and lounge chair with tablet arm • Lounge chair with arms 	+\$ 34 +\$ 46	Specify with <i>acrylic backer</i> . ▶ See <i>Coalesse Surface Materials Reference Guide</i> .
Related Products	<ul style="list-style-type: none"> • Bench • Podium • Occasional tables • Side tables 		▶ Page 88 ▶ Page 90 ▶ Page 98 ▶ Page 100

Specification Information

Style Number	U.S. Base Prices												Leather Grades:			
	Fabric Grades:												COL	C	E	
	COM	6	7	8	9	10	11	12	13	14						

Sled Lounge Chair

BLD26XX	\$1520	\$1520	\$1538	\$1569	\$1662	\$1723	\$1793	\$1841	\$1928	\$2048	\$1606	\$2590	\$2756
---------	--------	--------	--------	--------	--------	--------	--------	--------	--------	--------	--------	--------	--------

COM/yds = 2¾, COL/sq ft = 55

Sled Lounge Chair with Arms

BLD26AA	\$2199	\$2199	\$2223	\$2265	\$2392	\$2475	\$2570	\$2636	\$2754	\$2918	\$2312	\$3423	\$3623
---------	--------	--------	--------	--------	--------	--------	--------	--------	--------	--------	--------	--------	--------

COM/yds = 3¾, COL/sq ft = 73

Sled Lounge Chair with Left-Hand Facing Tablet Arm

BLD26TX	\$1836	\$1836	\$1854	\$1885	\$1978	\$2039	\$2109	\$2157	\$2244	\$2364	\$1954	\$2906	\$3072
---------	--------	--------	--------	--------	--------	--------	--------	--------	--------	--------	--------	--------	--------

COM/yds = 2¾, COL/sq ft = 55

Sled Lounge Chair with Right-Hand Facing Tablet Arm

BLD26XT	\$1836	\$1836	\$1854	\$1885	\$1978	\$2039	\$2109	\$2157	\$2244	\$2364	\$1954	\$2906	\$3072
---------	--------	--------	--------	--------	--------	--------	--------	--------	--------	--------	--------	--------	--------

COM/yds = 2¾, COL/sq ft = 55

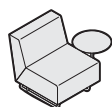
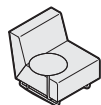
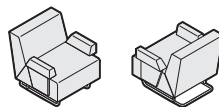
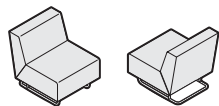

For Canadian Pricing
Multiply U.S. Price by the Canadian price factor.
▶ See page 1 for details.

Bix Sectional Seating

DESIGN METRO DESIGN GROUP

 = Available in Rapid10.

Tip: Fabric for the seat and back is specified separate from the back screen, if selected. For a monochromatic look, specify the same fabric for both the seat and back, and back screen.

Tip: The COM yards and COL square footage listed on these pages reflect the requirements for a single fabric that are based on non-directional 54"W material applied rail-roaded. For multi-fabric COM requirements, please refer to Multi-Fabric Yardage.
▶ Page 93

Tip: When specifying fabric in different price groups, the highest price group prevails.

Tip: Fabrics and leathers will appear loose with comfort wrinkles when upholstered.

Tip: 30"W corner sections are available with two seat fabric direction options – rail-roaded or cut-right. Illustrations assume a striped patterned fabric.
▶ Page 94

Standard Includes	Required to Specify
<ul style="list-style-type: none"> • Seat, back, and arms, if selected: fabric or leather • Legs: paint • Adjustable glides: paint to match legs • Back screen, if selected: fabric • Leveling wrench 	<ol style="list-style-type: none"> 1 Style number 2 Number of fabrics if contrasting fabric style number is selected 3 Fabric or leather color number for seat, back, and arms, if selected 4 Paint color number for legs and glides 5 Fabric color number for back screen, if selected 6 Options, if selected (see below) <p>▶ See <i>Coalesse Surface Materials Reference Guide</i>.</p>

Options	U.S. Price	Required to Specify
Surface Materials <ul style="list-style-type: none"> • Contrasting fabric 	+\$118 per fabric	Add suffix K to the style number and select fabric color number.
Fire code seating <ul style="list-style-type: none"> • 30"W sections • 48"W, 54"W, and 72"W sections • 72"W sections with back screen 	+\$461 +\$600 +\$719	Specify with <i>fire code seating</i> . Specify with <i>fire code seating</i> . Specify with <i>fire code seating</i> . ▶ See <i>Coalesse Surface Materials Reference Guide</i> .
Acrylic backer <ul style="list-style-type: none"> • 30"W sections • 30"W sections with back screen • 48"W sections • 48"W sections with back screen • 54"W sections • 72"W sections • 54"W and 72"W sections with back screen 	+\$ 46 +\$ 67 +\$ 54 +\$ 83 +\$ 83 +\$ 72 +\$ 125	Specify with <i>acrylic backer</i> . Specify with <i>acrylic backer</i> . Specify with <i>acrylic backer</i> . Specify with <i>acrylic backer</i> . Specify with <i>acrylic backer</i> . Specify with <i>acrylic backer</i> . ▶ See <i>Coalesse Surface Materials Reference Guide</i> .
Seat Height <ul style="list-style-type: none"> • 18" seat height 	+\$227	Specify with <i>18" seat height</i> .
Related Products <ul style="list-style-type: none"> • Bench • Podium • Bridge tables • Occasional tables • Work booth tables • Side tables 		▶ Page 88 ▶ Page 90 ▶ Page 96 ▶ Page 98 ▶ Page 99 ▶ Page 100

Specification Information

Style Number	U.S. Base Prices													Leather Grades:			
	Fabric Grades:													COL	C	E	
	COM	6	7	8	9	10	11	12	13	14							

30"W Corner Section–Left Section with Seat Fabric Rail-roaded

BSC30LA	\$2439	\$2443	\$2473	\$2523	\$2676	\$2775	\$2889	\$2969	\$3110	\$3307	\$2645	\$3642	\$3842
---------	--------	--------	--------	--------	--------	--------	--------	--------	--------	--------	--------	--------	--------

COM/yds = 4½, COL/sq ft = 90

30"W Corner Section–Left Section with Seat Fabric Cut-Right

BSC30LB	\$2439	\$2443	\$2473	\$2523	\$2676	\$2775	\$2889	\$2969	\$3110	\$3307	\$2645	\$3642	\$3842
---------	--------	--------	--------	--------	--------	--------	--------	--------	--------	--------	--------	--------	--------

COM/yds = 4½, COL/sq ft = 90

▶ Specification Information, continued on next page

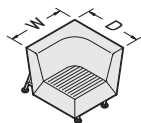
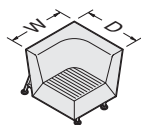

 **For Canadian Pricing**
Multiply U.S. Price by the Canadian price factor.
▶ See page 1 for details.

Bix Sectional Seating

DESIGN METRO DESIGN GROUP

 = Available in Rapid10.

► Specification Information, continued from previous page

Specification Information

Style Number	U.S. Base Prices										Leather Grades:		
	Fabric Grades:										COL	C	E
	COM	6	7	8	9	10	11	12	13	14			

30"W Corner Section–Right Section with Seat Fabric Railroaded

BSC30RA	\$2439	\$2443	\$2473	\$2523	\$2676	\$2775	\$2889	\$2969	\$3110	\$3307	\$2645	\$3642	\$3842
----------------	--------	--------	--------	--------	--------	--------	--------	--------	--------	--------	--------	--------	--------

COM/yds = 4½, COL/sq ft = 90

30"W Corner Section–Right Section with Seat Fabric Cut-Right

BSC30RB	\$2439	\$2443	\$2473	\$2523	\$2676	\$2775	\$2889	\$2969	\$3110	\$3307	\$2645	\$3642	\$3842
----------------	--------	--------	--------	--------	--------	--------	--------	--------	--------	--------	--------	--------	--------

COM/yds = 4½, COL/sq ft = 90

30"W Corner Section with Back Screen–Left Section with Seat Fabric Railroaded

BSCB30LA	\$3199	\$3272	\$3314	\$3387	\$3608	\$3750	\$3916	\$4031	\$4235	\$4519	\$3510	\$5156	\$5490
-----------------	--------	--------	--------	--------	--------	--------	--------	--------	--------	--------	--------	--------	--------

Chair: COM/yds = 4½, COL/sq ft = 90
Screen: COM/yds = 2

30"W Corner Section with Back Screen–Left Section with Seat Fabric Cut-Right

BSCB30LB	\$3199	\$3272	\$3314	\$3387	\$3608	\$3750	\$3916	\$4031	\$4235	\$4519	\$3510	\$5156	\$5490
-----------------	--------	--------	--------	--------	--------	--------	--------	--------	--------	--------	--------	--------	--------

Chair: COM/yds = 4½, COL/sq ft = 90
Screen: COM/yds = 2

30"W Corner Section with Back Screen–Right Section with Seat Fabric Railroaded

BSCB30RA	\$3199	\$3272	\$3314	\$3387	\$3608	\$3750	\$3916	\$4031	\$4235	\$4519	\$3510	\$5156	\$5490
-----------------	--------	--------	--------	--------	--------	--------	--------	--------	--------	--------	--------	--------	--------

Chair: COM/yds = 4½, COL/sq ft = 90
Screen: COM/yds = 2

30"W Corner Section with Back Screen–Right Section with Seat Fabric Cut-Right

BSCB30RB	\$3199	\$3272	\$3314	\$3387	\$3608	\$3750	\$3916	\$4031	\$4235	\$4519	\$3510	\$5156	\$5490
-----------------	--------	--------	--------	--------	--------	--------	--------	--------	--------	--------	--------	--------	--------

Chair: COM/yds = 4½, COL/sq ft = 90
Screen: COM/yds = 2

► Specification Information, continued on next page

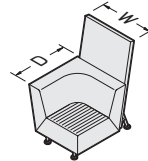
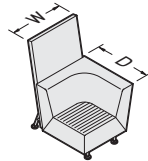
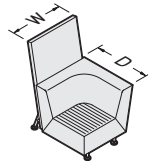
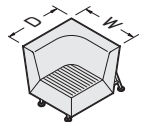
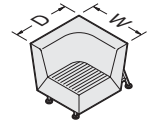

For Canadian Pricing
Multiply U.S. Price by the Canadian price factor.
► See page 1 for details.

Bix Sectional Seating *continued*

DESIGN METRO DESIGN GROUP

 = Available in Rapid10.

Tip: Extended corner sections are standard with a railroaded seat and back fabric direction.
▶ Page 94

Tip: Fabrics and leathers will appear loose with comfort wrinkles when upholstered.

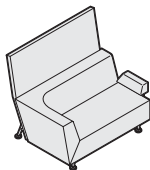
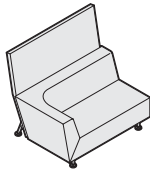
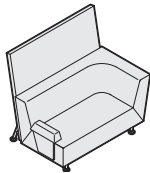
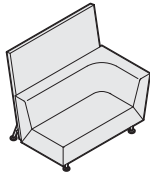
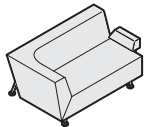
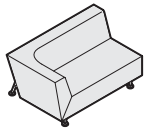
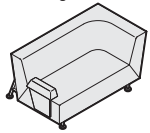
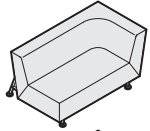

► Specification Information, continued from previous page

Specification Information

Style Number	U.S. Base Prices											Leather Grades:		
	Fabric Grades:											COL	C	E
	COM	6	7	8	9	10	11	12	13	14				

54"W Extended Corner Section–Left Section

BSE54LX	\$3344	\$3434	\$3480	\$3558	\$3796	\$3949	\$4127	\$4251	\$4471	\$4777	\$3677	\$5113	\$5412
COM/yds = 7, COL/sq ft = 140													

54"W Extended Corner Section–Left Section with Arm

BSE54LA	\$3667	\$3774	\$3823	\$3907	\$4162	\$4326	\$4517	\$4650	\$4885	\$5213	\$4043	\$5624	\$5958
COM/yds = 7½, COL/sq ft = 149													

54"W Extended Corner Section–Right Section

BSE54RX	\$3344	\$3434	\$3480	\$3558	\$3796	\$3949	\$4127	\$4251	\$4471	\$4777	\$3677	\$5113	\$5412
COM/yds = 7, COL/sq ft = 140													

54"W Extended Corner Section–Right Section with Arm

BSE54RA	\$3667	\$3774	\$3823	\$3907	\$4162	\$4326	\$4517	\$4650	\$4885	\$5213	\$4043	\$5624	\$5958
COM/yds = 7½, COL/sq ft = 149													

54"W Extended Corner Section–Left Section with Back Screen

BSEB54LX	\$4292	\$4519	\$4591	\$4714	\$5088	\$5329	\$5609	\$5803	\$6149	\$6630	\$4754	\$7286	\$7802
Chair: COM/yds = 7, COL/sq ft = 140 Screen: COM/yds = 4													

54"W Extended Corner Section–Left Section with Back Screen and Arm

BSEB54LA	\$4613	\$4857	\$4933	\$5061	\$5452	\$5704	\$5996	\$6200	\$6561	\$7064	\$5117	\$7984	\$8567
Chair: COM/yds = 7½, COL/sq ft = 149 Screen: COM/yds = 4													

54"W Extended Corner Section–Right Section with Back Screen

BSEB54RX	\$4292	\$4519	\$4591	\$4714	\$5088	\$5329	\$5609	\$5803	\$6149	\$6630	\$4754	\$7286	\$7802
Chair: COM/yds = 7, COL/sq ft = 140 Screen: COM/yds = 4													

54"W Extended Corner Section–Right Section with Back Screen and Arm

BSEB54RA	\$4613	\$4857	\$4933	\$5061	\$5452	\$5704	\$5996	\$6200	\$6561	\$7064	\$5117	\$7984	\$8567
Chair: COM/yds = 7½, COL/sq ft = 149 Screen: COM/yds = 4													

► Specification Information, continued on next page

Bix Sectional Seating

DESIGN METRO DESIGN GROUP

 = Available in Rapid10.

Tip: Straight sections are standard with a railroaded seat and back fabric direction.

► Page 94

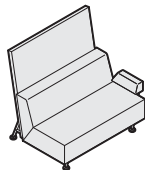
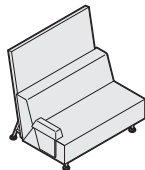
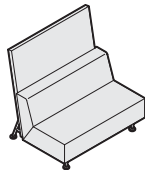
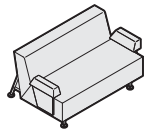
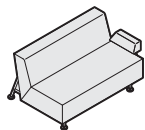
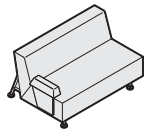

► Specification Information, continued from previous page

Specification Information

Style Number	U.S. Base Prices													
	Fabric Grades:													
	COM	6	7	8	9	10	11	12	13	14	Leather Grades:			
											COL	C	E	

48"W Straight Section

BSS48XX	\$2519	\$2523	\$2553	\$2603	\$2756	\$2855	\$2969	\$3049	\$3190	\$3387	\$2737	\$4005	\$4254
----------------	--------	--------	--------	--------	--------	--------	--------	--------	--------	--------	--------	--------	--------

COM/yds = 4½, COL/sq ft = 90

48"W Straight Section with Left Arm

BSS48AX	\$2842	\$2863	\$2896	\$2952	\$3122	\$3231	\$3359	\$3447	\$3604	\$3823	\$3104	\$4421	\$4688
----------------	--------	--------	--------	--------	--------	--------	--------	--------	--------	--------	--------	--------	--------

COM/yds = 5, COL/sq ft = 99

48"W Straight Section with Right Arm

BSS48XA	\$2842	\$2863	\$2896	\$2952	\$3122	\$3231	\$3359	\$3447	\$3604	\$3823	\$3104	\$4421	\$4688
----------------	--------	--------	--------	--------	--------	--------	--------	--------	--------	--------	--------	--------	--------

COM/yds = 5, COL/sq ft = 99

48"W Straight Section with Two Arms

BSS48AA	\$3164	\$3203	\$3239	\$3300	\$3487	\$3607	\$3747	\$3845	\$4018	\$4258	\$3469	\$4933	\$5232
----------------	--------	--------	--------	--------	--------	--------	--------	--------	--------	--------	--------	--------	--------

COM/yds = 5½, COL/sq ft = 108

48"W Straight Section with Back Screen

 BSSB48XX	\$3397	\$3504	\$3553	\$3637	\$3892	\$4056	\$4247	\$4380	\$4615	\$4943	\$3738	\$6015	\$6463
---	--------	--------	--------	--------	--------	--------	--------	--------	--------	--------	--------	--------	--------

Chair: COM/yds = 4½, COL/sq ft = 90
Screen: COM/yds = 3

48"W Straight Section with Back Screen and Left Arm

BSSB48AX	\$3719	\$3843	\$3896	\$3985	\$4257	\$4432	\$4636	\$4777	\$5029	\$5378	\$4103	\$6431	\$6896
-----------------	--------	--------	--------	--------	--------	--------	--------	--------	--------	--------	--------	--------	--------

Chair: COM/yds = 5, COL/sq ft = 99
Screen: COM/yds = 3

48"W Straight Section with Back Screen and Right Arm

BSSB48XA	\$3719	\$3843	\$3896	\$3985	\$4257	\$4432	\$4636	\$4777	\$5029	\$5378	\$4103	\$6431	\$6896
-----------------	--------	--------	--------	--------	--------	--------	--------	--------	--------	--------	--------	--------	--------

Chair: COM/yds = 5, COL/sq ft = 99
Screen: COM/yds = 3

► Specification Information, continued on next page



For Canadian Pricing
Multiply U.S. Price by the Canadian price factor.
► See page 1 for details.

Bix Sectional Seating *continued*

DESIGN METRO DESIGN GROUP

 = Available in Rapid10.

Tip: Straight sections are standard with a railroaded seat and back fabric direction.

▶ Page 94

Tip: Fabrics and leathers will appear loose with comfort wrinkles when upholstered.

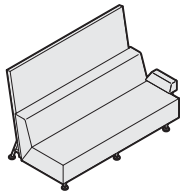
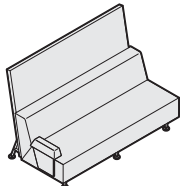
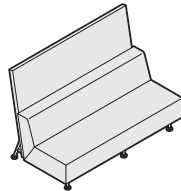
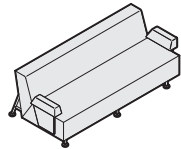
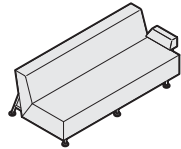
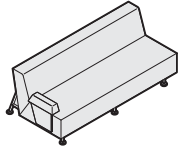
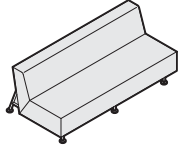

► Specification Information, continued from previous page

Specification Information

Style Number	U.S. Base Prices														Leather Grades:		
	Fabric Grades:														COL	C	E
	COM	6	7	8	9	10	11	12	13	14							

72"W Straight Section

BSS72XX	\$3515	\$3588	\$3630	\$3703	\$3924	\$4066	\$4232	\$4347	\$4551	\$4835	\$3869	\$5472	\$5806
----------------	--------	--------	--------	--------	--------	--------	--------	--------	--------	--------	--------	--------	--------

COM/yds = 6½, COL/sq ft = 130

72"W Straight Section with Left Arm

BSS72AX	\$3835	\$3925	\$3971	\$4049	\$4287	\$4440	\$4618	\$4742	\$4962	\$5268	\$4237	\$5981	\$6347
----------------	--------	--------	--------	--------	--------	--------	--------	--------	--------	--------	--------	--------	--------

COM/yds = 7, COL/sq ft = 139

72"W Straight Section with Right Arm

BSS72XA	\$3835	\$3925	\$3971	\$4049	\$4287	\$4440	\$4618	\$4742	\$4962	\$5268	\$4237	\$5981	\$6347
----------------	--------	--------	--------	--------	--------	--------	--------	--------	--------	--------	--------	--------	--------

COM/yds = 7, COL/sq ft = 139

72"W Straight Section with Two Arms

BSS72AA	\$4159	\$4266	\$4315	\$4399	\$4654	\$4818	\$5009	\$5142	\$5377	\$5705	\$4602	\$6495	\$6892
----------------	--------	--------	--------	--------	--------	--------	--------	--------	--------	--------	--------	--------	--------

COM/yds = 7½, COL/sq ft = 148

72"W Straight Section with Back Screen

 BSSB72XX	\$4686	\$4913	\$4985	\$5108	\$5482	\$5723	\$6003	\$6197	\$6543	\$7024	\$5202	\$8340	\$8972
---	--------	--------	--------	--------	--------	--------	--------	--------	--------	--------	--------	--------	--------

Chair: COM/yds = 6½, COL/sq ft = 130
Screen: COM/yds = 4½

72"W Straight Section with Back Screen and Left Arm

BSSB72AX	\$5005	\$5249	\$5325	\$5453	\$5844	\$6096	\$6388	\$6592	\$6953	\$7456	\$5565	\$8847	\$9513
-----------------	--------	--------	--------	--------	--------	--------	--------	--------	--------	--------	--------	--------	--------

Chair: COM/yds = 7, COL/sq ft = 139
Screen: COM/yds = 4½

72"W Straight Section with Back Screen and Right Arm

BSSB72XA	\$5005	\$5249	\$5325	\$5453	\$5844	\$6096	\$6388	\$6592	\$6953	\$7456	\$5565	\$8847	\$9513
-----------------	--------	--------	--------	--------	--------	--------	--------	--------	--------	--------	--------	--------	--------

Chair: COM/yds = 7, COL/sq ft = 139
Screen: COM/yds = 4½

Bix Multi-Fabric Diagram and Yardage Request Form

DESIGN METRO DESIGN GROUP

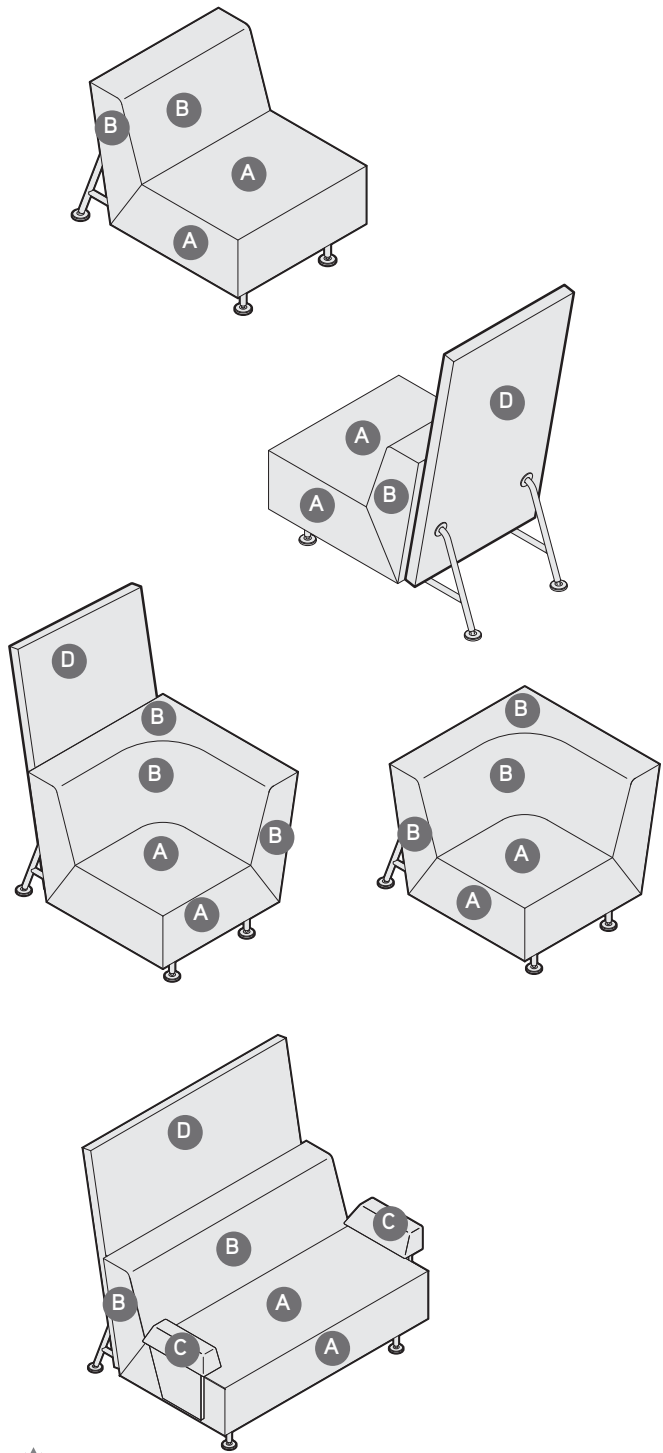

TO: _____

FROM: _____

DATE: _____

FAX...888.413.5161

Lounge Seating

A Seat (upholstery selections default for entire unit if B is not selected): _____

B Back: _____

C Arms (if applicable): _____

D Backscreen (if applicable): _____

**Back screen defined separately when ordered.*

** \$118 U.S. list per contrasting fabric specified. List price based on highest fabric grade usage.*

 **For Canadian Pricing**
 Multiply U.S. Price by the
 Canadian price factor.
 ▶ See page 1 for details.

Bix Benches

DESIGN METRO DESIGN GROUP

Tip: Fabrics and leathers will appear loose with comfort wrinkles when upholstered.

Tip: The COM yards and COL square footage listed on this page reflect the requirements for a single fabric that are based on non-directional 54"W material applied railroaded.

Standard Includes		Required to Specify	
<ul style="list-style-type: none"> Need help? Product details, page 70 	<ul style="list-style-type: none"> Seat: fabric or leather Legs and open storage interior, if selected: paint Adjustable glides: paint to match legs Leveling wrench 	<ol style="list-style-type: none"> Style number Fabric or leather color number for seat Paint color number for legs, glides, and open storage interior, if selected Options, if selected (see below) 	<ul style="list-style-type: none"> ▶ See <i>Coalesse Surface Materials Reference Guide</i>.

Options	U.S. Price	Required to Specify
Surface Materials <ul style="list-style-type: none"> Fire code seating 48"W benches 72"W benches 	<ul style="list-style-type: none"> +\$461 +\$600 	<ul style="list-style-type: none"> Specify with fire code seating. Specify with fire code seating. ▶ See <i>Coalesse Surface Materials Reference Guide</i>.
<ul style="list-style-type: none"> Acrylic backer 48"W benches 72"W benches 	<ul style="list-style-type: none"> +\$ 22 +\$ 29 	<ul style="list-style-type: none"> Specify with acrylic backer. Specify with acrylic backer. ▶ See <i>Coalesse Surface Materials Reference Guide</i>.
Seat Height <ul style="list-style-type: none"> 18" seat height 	<ul style="list-style-type: none"> +\$227 	<ul style="list-style-type: none"> Specify with 18" seat height.
Related Products <ul style="list-style-type: none"> Lounge chairs Sectional seating Podium Side tables 		<ul style="list-style-type: none"> ▶ Page 80 ▶ Page 82 ▶ Page 90 ▶ Page 100

Specification Information

Style Number	U.S. Base Prices												Leather Grades:			
	Fabric Grades:												COL	C	E	
	COM	6	7	8	9	10	11	12	13	14						

48"W Bench

BB48	\$1526	\$1526	\$1541	\$1566	\$1642	\$1692	\$1749	\$1789	\$1860	\$1958	\$1688	\$2519	\$2669
------	--------	--------	--------	--------	--------	--------	--------	--------	--------	--------	--------	--------	--------

COM/yds = 2¼, COL/sq ft = 41

72"W Bench

BB72	\$1845	\$1845	\$1865	\$1898	\$2000	\$2066	\$2142	\$2195	\$2289	\$2420	\$2024	\$3095	\$3295
------	--------	--------	--------	--------	--------	--------	--------	--------	--------	--------	--------	--------	--------

COM/yds = 3, COL/sq ft = 54

48"W Bench with Open Storage

BBS48	\$1760	\$1760	\$1775	\$1800	\$1876	\$1926	\$1983	\$2023	\$2094	\$2192	\$1955	\$2753	\$2903
-------	--------	--------	--------	--------	--------	--------	--------	--------	--------	--------	--------	--------	--------

COM/yds = 2¼, COL/sq ft = 41

72"W Bench with Open Storage

BBS72	\$2080	\$2080	\$2100	\$2133	\$2235	\$2301	\$2377	\$2430	\$2524	\$2655	\$2291	\$3330	\$3530
-------	--------	--------	--------	--------	--------	--------	--------	--------	--------	--------	--------	--------	--------

COM/yds = 3, COL/sq ft = 54

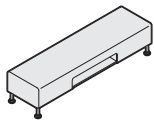
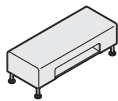
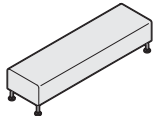
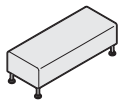

 **For Canadian Pricing**
 Multiply U.S. Price by the Canadian price factor.
 ▶ See page 1 for details.

Coalesse

Bix Benches

DESIGN METRO DESIGN GROUP

Bix Podium

DESIGN METRO DESIGN GROUP

Tip: The COM yards and COL square footage listed on this page reflect the requirements for a single fabric that are based on non-directional 54"W material applied rail-rudded. For multi-fabric COM requirements, please refer to Multi-Fabric Yardage and Square Footage Requirements.
▶ Page 93

Tip: When specifying fabric in different price groups, the highest price group prevails.

Tip: Wood veneer storage drawers are available in high sheen finishes only.

Standard Includes		Required to Specify
▶ Need help? Product details, page 70	<ul style="list-style-type: none"> • Seat and bolster: fabric or leather • Legs, tablet support, drawer pull, and projection screen frame, if selected: paint • Tablet surface: bronco onyx vinyl • Drawer front: laminate • Face-mounted lock, keyed random: black only • Projection screen, if selected: sand color mesh • Adjustable glides: paint to match legs • Leveling wrench 	<ol style="list-style-type: none"> 1 Style number 2 Number of fabrics if contrasting fabric style number is selected 3 Fabric or leather color number for seat and bolster 4 Paint color number for legs, glides, tablet support, drawer pull, and projection screen frame, if selected 5 Laminate color number for drawer front 6 Options, if selected (see below) <p>▶ See <i>Coalesse Surface Materials Reference Guide</i>.</p>

Options	U.S. Price	Required to Specify
Surface Materials		
• Contrasting fabric	+\$118 per fabric	Add suffix K to the style number and select fabric color number.
Fire code seating		
• Fire code seating	+\$600	Specify with <i>fire code seating</i> . ▶ See <i>Coalesse Surface Materials Reference Guide</i> .
Acrylic backer		
• Backer	+\$ 63	Specify with <i>acrylic backer</i> . ▶ See <i>Coalesse Surface Materials Reference Guide</i> .
Storage drawer		
• Wood veneer Grade 1	+\$ 33	Specify with <i>wood drawer front</i> and select wood veneer grade 1 color number.
• Wood veneer Grade 2	+\$ 52	Specify with <i>wood drawer front</i> and select wood veneer grade 2 color number.
Grade 2 laminate drawer front	No cost	Specify laminate color number.
Wood		
• Custom wood finish		▶ See <i>Coalesse Surface Materials Reference Guide</i> .
Seat Height		
• 18" seat height	+\$227	Specify with <i>18" seat height</i> .
Related Products		
• Lounge chairs		▶ Page 80
• Sectional seating		▶ Page 82
• Bench		▶ Page 88
• Side tables		▶ Page 100

Specification Information													
Style Number	U.S. Base Prices											Leather Grades:	
	Fabric Grades:											COL	C
COM	6	7	8	9	10	11	12	13	14				

Podium with Left Tablet

BP72TX	\$4071	\$4127	\$4166	\$4233	\$4437	\$4568	\$4721	\$4827	\$5016	\$5278	\$4506	\$6407	\$6804
--------	--------	--------	--------	--------	--------	--------	--------	--------	--------	--------	--------	--------	--------

COM/yds = 6, COL/sq ft = 108

▶ Specification Information, continued on next page

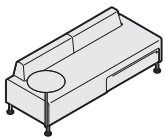

For Canadian Pricing
Multiply U.S. Price by the Canadian price factor.
▶ See page 1 for details.

► Specification Information, continued from previous page

Specification Information

Style Number	U.S. Base Prices											Leather Grades:		
	Fabric Grades:											COL	C	E
	COM	6	7	8	9	10	11	12	13	14				

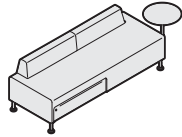

Podium with Right Tablet

BP72XT	\$4071	\$4127	\$4166	\$4233	\$4437	\$4568	\$4721	\$4827	\$5016	\$5278	\$4506	\$6407	\$6804
---------------	--------	--------	--------	--------	--------	--------	--------	--------	--------	--------	--------	--------	--------

COM/yds = 6, COL/sq ft = 108

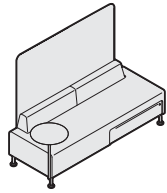

Podium with Projection Screen and Left Tablet

BPP72TX	\$4947	\$5003	\$5042	\$5109	\$5313	\$5444	\$5597	\$5703	\$5892	\$6154	\$5504	\$7283	\$7680
----------------	--------	--------	--------	--------	--------	--------	--------	--------	--------	--------	--------	--------	--------

COM/yds = 6, COL/sq ft = 108

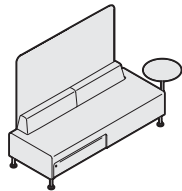

Podium with Projection Screen and Right Tablet

BPP72XT	\$4947	\$5003	\$5042	\$5109	\$5313	\$5444	\$5597	\$5703	\$5892	\$6154	\$5504	\$7283	\$7680
----------------	--------	--------	--------	--------	--------	--------	--------	--------	--------	--------	--------	--------	--------

COM/yds = 6, COL/sq ft = 108



For Canadian Pricing
 Multiply U.S. Price by the
 Canadian price factor.
 ► See page 1 for details.

Bix Multi-Fabric Diagram and Yardage Request Form

DESIGN METRO DESIGN GROUP

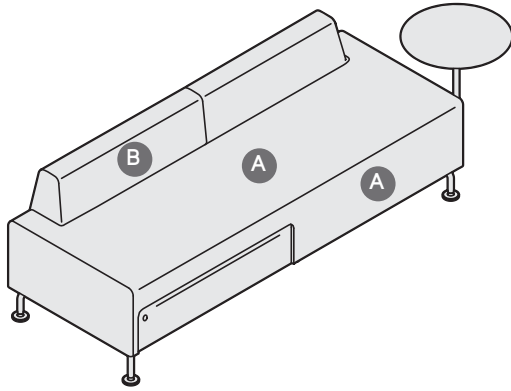

TO: _____

FROM: _____

DATE: _____

FAX...888.413.5161

A Seat (upholstery selections default for entire unit if B is not selected): _____

B Back: _____

\$118 U.S. list per contrasting fabric specified. List price based on highest fabric grade usage.



For Canadian Pricing
Multiply U.S. Price by the
Canadian price factor.
▶ See page 1 for details.

Multi-Fabric Yardage

Description	Style Number	COM Yds*			
		Seat	Back	Arm(s)	Back Screen
Lounge chair	BL26XX	1¾	1¾	N.A.	N.A.
Lounge chair with arms	BL26AA	1¾	1¾	1	N.A.
Lounge chair with back screen	BLB26XX	1¾	1¾	N.A.	1¾
Sled lounge chair	BLD26XX	1¾	1¾	N.A.	N.A.
Sled lounge chair with arms	BLD26AA	1¾	1¾	1	N.A.
Sled lounge chair with left-hand tablet arm	BLD26TX	1¾	1¾	N.A.	N.A.
Sled lounge chair with right-hand tablet arm	BLD26XT	1¾	1¾	N.A.	N.A.
30"W corner section-left section with seat fabric railroaded	BSC30LA	2	2½	N.A.	N.A.
30"W corner section-left section with seat fabric cut-right	BSC30LB	2	2½	N.A.	N.A.
30"W corner section-right section with seat fabric railroaded	BSC30RA	2	2½	N.A.	N.A.
30"W corner section-right section with seat fabric cut-right	BSC30RB	2	2½	N.A.	N.A.
30"W corner section with back screen-left section with seat fabric railroaded	BSCB30LA	2	2½	N.A.	2
30"W corner section with back screen-left section with seat fabric cut-right	BSCB30LB	2	2½	N.A.	2
30"W corner section with back screen-right section with seat fabric railroaded	BSCB30RA	2	2½	N.A.	2
30"W corner section with back screen-right section with seat fabric cut-right	BSCB30RB	2	2½	N.A.	2
54"W extended corner section-left section	BSE54LX	2½	3	N.A.	N.A.
54"W extended corner section-left section with arm	BSE54LA	2½	3	½	N.A.
54"W extended corner section-right section	BSE54RX	2½	3	N.A.	N.A.
54"W extended corner section-right section with arm	BSE54RA	2½	3	½	N.A.
54"W extended corner section-left section with back screen	BSEB54LX	2½	3	N.A.	4
54"W extended corner section-left section with back screen and arm	BSEB54LA	2½	3	½	4
54"W extended corner section-right section with back screen	BSEB54RX	2½	3	N.A.	4
54"W extended corner section-right section with back screen and arm	BSEB54RA	2½	3	½	4
48"W straight section	BSS48XX	2½	2½	N.A.	N.A.
48"W straight section with left arm	BSS48AX	2½	2½	½	N.A.
48"W straight section with right arm	BSS48XA	2½	2½	½	N.A.
48"W straight section with two arms	BSS48AA	2½	2½	1	N.A.
48"W straight section with back screen	BSSB48XX	2½	2½	N.A.	3
48"W straight section with back screen and left arm	BSSB48AX	2½	2½	½	3
48"W straight section with back screen and right arm	BSSB48XA	2½	2½	½	3
72"W straight section	BSS72XX	4½	4½	N.A.	N.A.
72"W straight section with left arm	BSS72AX	4½	4½	½	N.A.
72"W straight section with right arm	BSS72XA	4½	4½	½	N.A.
72"W straight section with two arms	BSS72AA	4½	4½	1	N.A.
72"W straight section with back screen	BSSB72XX	4½	4½	N.A.	4½
72"W straight section with back screen and left arm	BSSB72AX	4½	4½	½	4½
72"W straight section with back screen and right arm	BSSB72XA	4½	4½	½	4½

*Fabric yardage is based on non-directional/solid fabrics. use conversion chart on the following page for repeat/printed fabric yardage.

Bix Multi-Fabric Yardage *continued*

DESIGN METRO DESIGN GROUP

Multi-Fabric Yardage

DESCRIPTION	STYLE NUMBER	COM YDS*			
		SEAT CUSHION	BACK CUSHION	ARM(S)	BACK SCREEN
Podium with left tablet	BP72TX	3½	2½	N.A.	N.A.
Podium with right tablet	BP72XT	3½	2½	N.A.	N.A.
Podium with projection screen and left tablet	BPP72TX	3½	2½	N.A.	N.A.
Podium with projection screen and right tablet	BPP72XT	3½	2½	N.A.	N.A.

*Fabric yardage is based on non-directional/solid fabrics. Use conversion chart below for repeat/printed fabric yardage.

Non-standard fabric requirements

Yardage requirements shown are based on non-directional 54"W material applied railroaded. Coalesse will apply fabric railroaded unless instructed otherwise on the dealer's purchase order. The following conversion chart should be used to determine yardage requirements when COM has a repeat of 2" or more. Please contact Coalesse customer service for a yardage quotation if the fabric is less than 54" wide, has a repeat of more than 24", or if the fabric must be cut-right.

CONVERSION CHART

PRODUCT	REPEAT		
	2" - 8"	9" - 14"	15" - 24"
Bix	15%	30%	75%

Yardage quotations will also be provided for order of 10 or more pieces.

Pattern matching on Bix

Due to Coalesse's high standards for pattern matching, we reserve the right to apply the following upcharges for extra labor incurred by a pattern or material that poses such challenges.

Customers will be informed if an upcharge will be applied to their order during the approval process. Should Coalesse receive an order without prior approval, it will be held as pending until the customer accepts such charges. The upcharge will be applied per item where applicable.

Cutting direction guidelines

Cutting direction is based on the fabric width and the way the fabric is cut from the roll and applied to Coalesse products. There are two cutting directions: railroaded or cut-right.

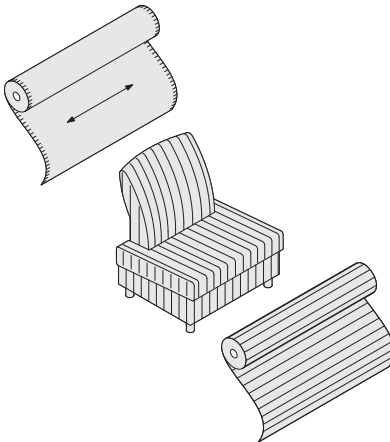

Horizontal or railroaded (across roll, warp horizontal) means fabric is cut across the roll; selvages are on the top and bottom.

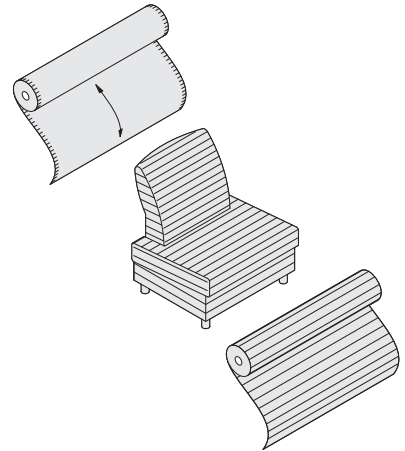

Vertical or cut-right (down roll, warp vertical) means fabric is cut in the same direction it is woven; selvages are on the left and right sides.

Coalesse reserves the right to railroad or apply fabric according to weave unless instructions specify otherwise. Fabrics are railroaded when possible to avoid seams in large upholstered areas and/or single cushion units. If a fabric is questionable, a cutting of adequate size showing full repeat (if any) should be sent to Coalesse for a fabric requirement quotation.

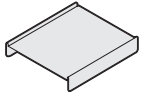

Standard Includes **Required to Specify**

- | | |
|--|--|
| <p>▶ Need help?
Product details,
page 70</p> | <ul style="list-style-type: none"> • Tray: paint <p>1 Style number
2 Paint color number for tray
▶ See <i>Coalesse Surface Materials Reference Guide</i>.</p> |
|--|--|

Related Products

- | | |
|--------|-----------|
| Bench | ▶ Page 88 |
| Podium | ▶ Page 90 |

Specification Information

Dimensions			Style Number	U.S. Price
D	W	H		
20"	22"	4"	BATRAY	\$271

For Canadian Pricing
Multiply U.S. Price by the
Canadian price factor.
▶ See page 1 for details.

Standard Includes		Required to Specify
<p>► Need help? Product details, page 71</p>	<ul style="list-style-type: none"> • Top: <ul style="list-style-type: none"> - Laminate top (Grade 1 laminates) with matching plastic edge - Laminate top (Grade 1 Steelcase) with contrasting plastic edge - Wood top with matching flat wood edge • Frame, tilted display surface for rectangular tables, and support leg for corner tables, if selected: paint • Grommet, if selected: black plastic only • Screens, if selected: translucent material only • Wire management clips: black plastic only • Attachment hardware 	<ol style="list-style-type: none"> 1 Style number 2 Laminate or wood color number for top 3 Plastic edge color number for top with Grade 1 Steelcase or Grade 2 laminate, if selected 4 Paint color number for frame, tilted display surface for rectangular tables, and support leg for corner tables, if selected 5 Options, if selected (see below) <p>► See <i>Coalesse Surface Materials Reference Guide</i>.</p>

	Options	U.S. Price	Required to Specify
Surface Materials	<p>Wood</p> <ul style="list-style-type: none"> • Custom wood finish 		► See <i>Coalesse Surface Materials Reference Guide</i> .
Cable Management	<ul style="list-style-type: none"> • PDV module: black plastic 	+\$373	Specify with <i>PDV module</i> .
Corner Bridge Table Height	<ul style="list-style-type: none"> • 20" table height 	+\$227	Specify with <i>20" table height</i> .
Related Products	<ul style="list-style-type: none"> • Sectional seating 		► Page 82

Tip: 20" table height must be used in conjunction with 18" seat height in the sectional seating.

Specification Information							
Dimensions			Style Number	U.S. Base Prices			
D	W	H		Lam 1	Lam 2	Wood 1	Wood 2

Rectangular Bridge Table

26"	22"	18"	BTB2226	\$888	\$934	\$1100	\$1214
-----	-----	-----	---------	-------	-------	--------	--------

Rectangular Bridge Table with Grommet

26"	22"	18"	BTB2226U	\$943	\$992	\$1155	\$1269
-----	-----	-----	----------	-------	-------	--------	--------

► Specification Information, continued on next page

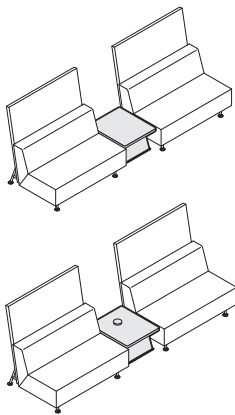

Edge Profiles

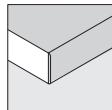

Plastic edge

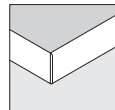

Wood edge

 **For Canadian Pricing**
Multiply U.S. Price by the Canadian price factor.
► See page 1 for details.

► Specification Information, continued from previous page

Specification Information

Dimensions			Style Number	U.S. Base Prices			
D	W	H		Lam 1	Lam 2	Wood 1	Wood 2

Rectangular Bridge Table with Screen

26"	22"	46"	BTBS2226	\$1341	\$1409	\$1553	\$1667
-----	-----	-----	----------	--------	--------	--------	--------

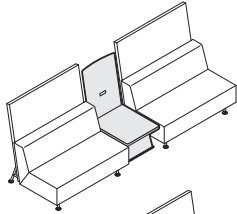

Rectangular Bridge Table with Grommet and Screen

26"	22"	46"	BTBS2226U	\$1398	\$1469	\$1610	\$1724
-----	-----	-----	-----------	--------	--------	--------	--------

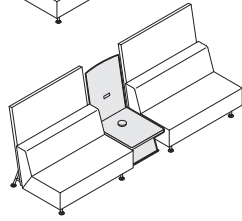

Corner Bridge Table

26"	26"	18"	BTB2626	\$1006	\$1057	\$1245	\$1359
-----	-----	-----	---------	--------	--------	--------	--------

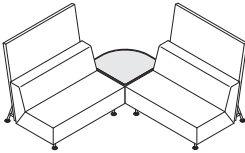

Corner Bridge Table with Grommet

26"	26"	18"	BTB2626U	\$1062	\$1117	\$1301	\$1415
-----	-----	-----	----------	--------	--------	--------	--------

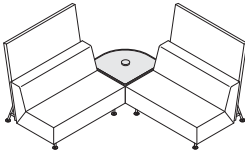

Corner Bridge Table with Screen

26"	26"	46"	BTBS2626	\$1599	\$1680	\$1838	\$1952
-----	-----	-----	----------	--------	--------	--------	--------

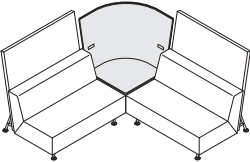

Corner Bridge Table with Grommet and Screen

26"	26"	46"	BTBS2626U	\$1654	\$1740	\$1893	\$2007
-----	-----	-----	-----------	--------	--------	--------	--------

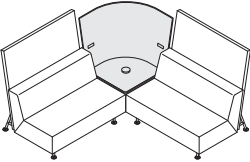

For Canadian Pricing
 Multiply U.S. Price by the
 Canadian price factor.
 ► See page 1 for details.

Bix 18"H Occasional Tables

DESIGN METRO DESIGN GROUP

Standard Includes		Required to Specify
<ul style="list-style-type: none"> ▶ Need help? Product details, page 70 	<ul style="list-style-type: none"> • Top: <ul style="list-style-type: none"> - Laminate top (Grade 1 laminates) with matching plastic edge - Laminate top (Grade 1 Steelcase) with contrasting plastic edge - Wood top with matching flat wood edge • Base: textured paints only • Grommet, if selected: black plastic only 	<ol style="list-style-type: none"> 1 Style number 2 Laminate or wood color number for top 3 Plastic edge color number for top with Grade 1 Steelcase or Grade 2 laminate, if selected 4 Textured paint color number for base 5 Options, if selected (see below) <p>▶ See <i>Coalesse Surface Materials Reference Guide</i>.</p>

Options	U.S. Price	Required to Specify
Surface Materials <ul style="list-style-type: none"> • Wood <ul style="list-style-type: none"> - Custom wood finish 		▶ See <i>Coalesse Surface Materials Reference Guide</i> .
Cable Management <ul style="list-style-type: none"> • PDV module: black plastic 	+\$373 each	Specify with PDV module.
Related Products <ul style="list-style-type: none"> • Lounge chair • Sectional seating 		▶ Page 80 ▶ Page 82

Tip: One or two power, data, and voice modules are available on rectangular occasional tables.

Specification Information

Dimensions			Diameter	Style Number	U.S. Base Prices			
D	W	H			Lam 1	Lam 2	Wood 1	Wood 2

Round Occasional Tables

N.A.	N.A.	18"	20"	BTC20001	\$1028	\$1080	\$1138	\$1191
N.A.	N.A.	18"	28"	BTC28001	\$1071	\$1126	\$1190	\$1304

Round Occasional Table with Grommet

N.A.	N.A.	18"	28"	BTC28001U	\$1141	\$1199	\$1260	\$1374
------	------	-----	-----	-----------	--------	--------	--------	--------

Square Occasional Table

24"	24"	18"	N.A.	BTC24241	\$1056	\$1110	\$1172	\$1244
-----	-----	-----	------	----------	--------	--------	--------	--------

Square Occasional Table with Grommet

24"	24"	18"	N.A.	BTC24241U	\$1127	\$1185	\$1243	\$1315
-----	-----	-----	------	-----------	--------	--------	--------	--------

Rectangular Table

24"	48"	18"	N.A.	BTC24481	\$1709	\$1797	\$1889	\$2036
24"	72"	18"	N.A.	BTC24721	\$1751	\$1841	\$1952	\$2168

Rectangular Occasional Tables with Grommets

24"	48"	18"	N.A.	BTC24481U	\$1849	\$1943	\$2029	\$2176
24"	72"	18"	N.A.	BTC24721U	\$1892	\$1989	\$2093	\$2309

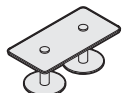
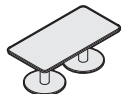

Edge Profiles

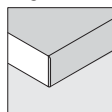

Plastic edge

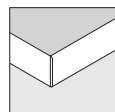

Wood edge

 **For Canadian Pricing**
 Multiply U.S. Price by the Canadian price factor.
 ▶ See page 1 for details.

Bix 27"H Work-Booth Tables

DESIGN METRO DESIGN GROUP

 = Available in Rapid10.

Tip: One or two power, data, and voice modules are available on rectangular occasional tables.

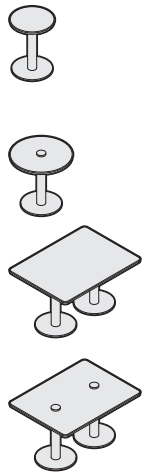

Standard Includes		Required to Specify
<ul style="list-style-type: none"> ▶ Need help? Product details, page 71 	<ul style="list-style-type: none"> • Top: <ul style="list-style-type: none"> - Laminate top (Grade 1 laminates) with matching plastic edge - Laminate top (Grade 1 Steelcase) with contrasting plastic edge - Wood top with matching flat wood edge • Base: textured paints only • Grommet, if selected: black plastic only 	<ol style="list-style-type: none"> 1 Style number 2 Laminate or wood color number for top 3 Plastic edge color number for top with Grade 1 Steelcase or Grade 2 laminate, if selected 4 Textured paint color number for base 5 Options, if selected (see below) <p>▶ See <i>Coalesse Surface Materials Reference Guide</i>.</p>

Options	U.S. Price	Required to Specify
Surface Materials <ul style="list-style-type: none"> • Wood <ul style="list-style-type: none"> • Custom wood finish 		▶ See <i>Coalesse Surface Materials Reference Guide</i> .
Cable Management <ul style="list-style-type: none"> • PDV module: black plastic 	+\$373 each	Specify with PDV module.
Related Products <ul style="list-style-type: none"> • Lounge chair • Sectional seating 		▶ Page 80 ▶ Page 82

Specification Information

Dimensions				Style Number	U.S. Base Prices			
	D	W	H		Diameter	Lam 1	Lam 2	Wood 1



Round Work-Booth Tables

N.A.	N.A.	27"	20"	BTW20003	\$1056	\$1110	\$1166	\$1219
N.A.	N.A.	27"	28"	BTW28003	\$1099	\$1155	\$1218	\$1332

Round Work-Booth Table with Grommet

N.A.	N.A.	27"	28"	BTW28003U	\$1168	\$1227	\$1287	\$1401
------	------	-----	-----	-----------	--------	--------	--------	--------

Rectangular Work-Booth Tables

	36"	48"	27"	N.A.	BTW36483	\$2009	\$2113	\$2239	\$2456
	36"	72"	27"	N.A.	BTW36723	\$2223	\$2337	\$2453	\$2780

Rectangular Work-Booth Tables with Grommets

36"	48"	27"	N.A.	BTW36483U	\$2148	\$2258	\$2378	\$2595
36"	72"	27"	N.A.	BTW36723U	\$2362	\$2483	\$2592	\$2919

Edge Profiles

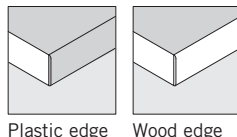

 **For Canadian Pricing**
 Multiply U.S. Price by the Canadian price factor.
 ▶ See page 1 for details.



Standard Includes		Required to Specify
▶ Need help? Product details, page 70	<ul style="list-style-type: none"> • Base: paint • Table surface and base cover: bronco onyx vinyl 	1 Style number 2 Paint color number for base ▶ See <i>Coalesse Surface Materials Reference Guide</i> .

Related Products	
Lounge chairs	▶ Page 80
Sectional seating	▶ Page 82
Podium	▶ Page 90

Specification Information			
Dimensions		Style	U.S.
Diameter	H	Number	Price
16"	23"	BTS1700	\$512



For Canadian Pricing
 Multiply U.S. Price by the
 Canadian price factor.
 ▶ See page 1 for details.

Bob Chairs by Walter Knoll

DESIGN PEARSON LLOYD DESIGN ORIGIN: 2007 GERMANY

Tip: For Customer's Own Material or Leather, see necessary requirements, important processing instructions, and ordering information
 ▶ See *Coalesse Surface Materials Reference Guide*.

Tip: Fabrics and leathers will appear loose with comfort wrinkles when upholstered.

Standard Includes		Required to Specify	
	<ul style="list-style-type: none"> • Base: 8040 Aluminum Matte Polished • Upholstery for chair: fabric or leather • Glides 		1 Style number 2 Number of fabrics if contrasting fabric style number is selected 3 Fabric or leather color number for upholstery 4 Options, if selected (see below) ▶ See <i>Coalesse Surface Materials Reference Guide</i> .
Options	U.S. Price	Required to Specify	
Surface Materials	<ul style="list-style-type: none"> • Contrasting fabric 	+\$118 per fabric	Add suffix K to the style number and select fabric color number.
	Fire code seating		
	<ul style="list-style-type: none"> • Fire code seating 	+\$231	Specify with <i>fire code seating</i> . ▶ See <i>Coalesse Surface Materials Reference Guide</i> .
	Acrylic backer		
	<ul style="list-style-type: none"> • Lounge chair • Lounge chair with headrest • Ottoman 	+\$ 29 +\$ 33 +\$ 10	Specify with <i>acrylic backer</i> . Specify with <i>acrylic backer</i> . Specify with <i>acrylic backer</i> . ▶ See <i>Coalesse Surface Materials Reference Guide</i> .
Glides	<ul style="list-style-type: none"> • Felted glides 	+\$ 16	Specify with <i>felted glides</i> .

Specification Information															
Style Number	U.S. Base Prices												Leather Grades:		
	Fabric Grades:												COL	C	E
	COM	6	7	8	9	10	11	12	13	14					

Lounge Swivel Chair

216	\$2896	\$2896	\$2916	\$2949	\$3051	\$3117	\$3193	\$3246	\$3340	\$3471	\$3076	\$4321	\$4547
-----	--------	--------	--------	--------	--------	--------	--------	--------	--------	--------	--------	--------	--------

COM/yds = 3, COL/sq ft = 72



Overall: 34¼"D 35"W 31¾"H
 Inside: 21¾"D 20"W 17¼"H
 Seat: 17"H
 Arm: 21¾"H

Lounge Chair with Headrest

221	\$3432	\$3432	\$3455	\$3494	\$3613	\$3690	\$3779	\$3841	\$3951	\$4103	\$3595	\$5053	\$5318
-----	--------	--------	--------	--------	--------	--------	--------	--------	--------	--------	--------	--------	--------

COM/yds = 3½, COL/sq ft = 77



Overall: 34¼"D 35"W 41¼"H
 Inside: 21¾"D 20"W 27½"H
 Seat: 17"H
 Arm: 21¾"H

Ottoman

221-H	\$1064	\$1058	\$1065	\$1076	\$1110	\$1132	\$1157	\$1175	\$1206	\$1250	\$1307	\$1687	\$1762
-------	--------	--------	--------	--------	--------	--------	--------	--------	--------	--------	--------	--------	--------

COM/yds = 1, COL/sq ft = 22



Overall: 18½"D 19¾"W 15¼"H



For Canadian Pricing
 Multiply U.S. Price by the Canadian price factor.
 ▶ See page 1 for details.

CH07 Shell Chair by Carl Hansen & Son

DESIGN HANS WEGNER DESIGN ORIGIN: DENMARK, 1963

Smoked Oak style number will be available Summer 2015.
Only select finishes are available at this time.



Overall: 32½"D 36¼"W 26"H
Seat: 13¾"H

Tip: Not all finishes offered on every wood species, see matrix below.

Tip: For Customer's Own Material or Leather, see necessary requirements, important processing instructions, and ordering information
▶ See *Coalesse Surface Materials Reference Guide*.

Tip: Contact Coalesse Customer Service for a collection of curated upholstered shell chairs.

Standard Includes Required to Specify

- Upholstered seat and back cushion: fabric or leather
- Bent ply frame

- 1 Style number
- 2 Fabric or leather color number for upholstery, if selected
▶ See *Coalesse Surface Materials Reference Guide*.
- 3 Wood species/finish number (See matrix below)

Specification Information

Style Number	U.S. Prices						Leather:			
	Fabric: COM	Group 1	Group 2	Group 3	Group 4	Group 5	COL	Loke Leather	Thor Leather	SIF Leather
CH07OAK	\$5485	\$5505	\$5543	\$5570	\$5617	\$6206	\$5731	\$5752	\$5969	\$6464
CH07WALNUT	\$5931	\$5960	\$5998	\$6027	\$6074	\$6663	\$6188	\$6206	\$6414	\$6909
CH07BEECH	\$5057	\$5077	\$5115	\$5144	\$5191	\$5781	\$5306	\$5324	\$5543	\$6036
CH07SMKOAK	\$5485	\$5505	\$5543	\$5570	\$5617	\$6206	\$5731	\$5752	\$5969	\$6464

COM/yds = 1¼

Wood Species/Finish Number Matrix

Finish	Wood Species Number:				
	Oak	Ash	Walnut	Beech	Smoked Oak
Lacquer	3255	3615	3325	N.A.	N.A.
White Oil	3265	3645	N.A.	N.A.	N.A.
Oil	3227	N.A.	3335	N.A.	3233
CHS Color	3235	N.A.	N.A.	3246	N.A.



For Canadian Pricing
Multiply U.S. Price by the Canadian price factor.
▶ See page 1 for details.

Coalesse

CH25 Paddle Chair by Carl Hansen & Son

DESIGN HANS WEGNER DESIGN ORIGIN: DENMARK, 1950

Smoked Oak style number will be available Summer 2015.
Only select finishes are available at this time.



Overall: 28¾"D 28"W 28¾"H
Seat: 15¼"H

Tip: Not all finishes offered on every wood species, see matrix below.

Tip: For Customer's Own Material or Leather, see necessary requirements, important processing instructions, and ordering information
▶ See Coalesse Surface Materials Reference Guide.

Standard Includes Required to Specify

- Frame: wood
- Hand-woven papercord seat

- 1 Style number
- 2 Papercord: (See prices below)
 - Black: P500
 - Natural: P501
- 3 Wood species/finish number, (See matrix below)

Specification Information

Style Number	U.S. Prices	
	Papercord:	
	Natural	Black
CH25OAK	\$6708	\$7573
CH25SMKOAK	\$7297	\$8161

Wood Species/Finish Number Matrix

Finish	Wood Species Number:	
	Oak	Smoked Oak
Lacquer	3255	N.A.
White Oil	3265	N.A.
Oil	3227	3233
Soap	3225	N.A.
CHS Color	3235	N.A.

Lounge Seating



For Canadian Pricing
Multiply U.S. Price by the Canadian price factor.
▶ See page 1 for details.

CH44 Ladderback Chair by Carl Hansen & Son

DESIGN HANS WEGNER DESIGN ORIGIN: DENMARK, 1965

Only select finishes are available at this time.



Overall: 26"D 25"W 31½"H
Seat: 15¼"H

Tip: Not all finishes offered on every wood species, see matrix below.

Tip: For Customer's Own Material or Leather, see necessary requirements, important processing instructions, and ordering information
▶ See Coalesse Surface Materials Reference Guide.

Standard Includes **Required to Specify**

- Frame: wood
- Hand-woven papercord seat

- 1 Style number
- 2 Papercord: (See prices below)
 - Black: P500
 - Natural: P501
- 3 Wood finish number, (See matrix below)
- 4 Options, if selected (see below)

Options **U.S. Price** **Required to Specify**

	Options	U.S. Price	Required to Specify
Cushion	• Customer's own material (COM)	+\$ 968	Specify <i>with COM</i> and select fabric color number.
	• Fabric group 1	+\$1026	Specify <i>with cushion</i> and select color number.
	• Fabric group 2	+\$1187	Specify <i>with cushion</i> and select color number.
	• Fabric group 3	+\$1272	Specify <i>with cushion</i> and select color number.
	• Fabric group 4	+\$1413	Specify <i>with cushion</i> and select color number.
	• Fabric group 5	+\$2249	Specify <i>with cushion</i> and select color number.
	• COL	+\$1823	Specify <i>with leather cushion</i> and select color number.
	• Loke leather	+\$1832	▶ See <i>Coalesse Surface Materials Reference Guide</i> . Specify <i>with leather cushion</i> and select color number.
	• Thor Leather	+\$2096	▶ See <i>Coalesse Surface Materials Reference Guide</i> . Specify <i>with leather cushion</i> and select color number.
	• SIF Leather	+\$2885	▶ See <i>Coalesse Surface Materials Reference Guide</i> . Specify <i>with leather cushion</i> and select color number. ▶ See <i>Coalesse Surface Materials Reference Guide</i> .

Specification Information

Style Number	U.S. Base Prices	
	Papercord:	
	Natural	Black
CH44OAK	\$3796	\$4063

COM/yds = 1½

Wood Species/Finish Number Matrix

Finish	Wood Species Number:
	Oak
Lacquer	3255
White Oil	3265
Oil	3227
Soap	3225
CHS Color	3235

For Canadian Pricing
Multiply U.S. Price by the Canadian price factor.
▶ See page 1 for details.

CH100 Series by Carl Hansen & Son

DESIGN HANS WEGNER DESIGN ORIGIN: DENMARK, 1970

Tip: Thor leather used on CH100 products is not an exact color match to the Loke leather used on other Carl Hansen products.

Tip: For Customer's Own Material or Leather, see necessary requirements, important processing instructions, and ordering information
 ► See Coalesse Surface Materials Reference Guide.

Tip: Cowhide and Loke Leather are not available for CH100 Series.

Standard Includes	Required to Specify
-------------------	---------------------

- Internal frame: wood
- Stainless steel external frame and hardware
- Feather filled cushions

- 1 Style number
- 2 Leather color number, if selected
- See Coalesse Surface Materials Reference Guide.

Specification Information

Style Number	U.S. Prices		
	Leather:		
COL	Thor leather	SIF leather	

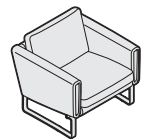

Overall: 30"D 30¾"W 28"H

100 Series Club Chair

CH101L	\$ 9870	\$10,325	\$18,172
COM/yds = 6½			

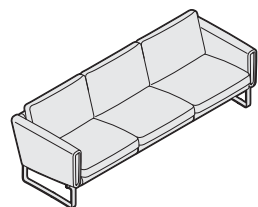

Overall: 30"D 85½"W 28"H
 Seat: 16½"H

100 Series Sofa

CH103L	\$21,295	\$21,751	\$42,562
COM/yds = 13			



For Canadian Pricing
 Multiply U.S. Price by the Canadian price factor.
 ► See page 1 for details.

Coalesse

CH401 Airport Chair by Carl Hansen & Son

DESIGN HANS WEGNER DESIGN ORIGIN: DENMARK, 1958

Only select finishes are available at this time.

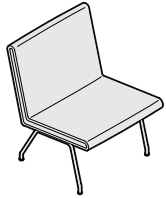

Overall: 27¼"D 23½"W 29½"H
 Seat: 17¼"H

Tip: For Customer's Own Material or Leather, see necessary requirements, important processing instructions, and ordering information
 ▶ See *Coalesse Surface Materials Reference Guide*.

Tip: CH401 is not available in cowhide.

Standard Includes **Required to Specify**

- Chair: fabric or leather
- Frame: stainless steel

- 1 Style number
- 2 Fabric or leather color number for upholstery, if selected
- ▶ See *Coalesse Surface Materials Reference Guide*.

Specification Information

Style Number	U.S. Prices						Leather:			
	Fabric: COM	Group 1	Group 2	Group 3	Group 4	Group 5	COL	Loke Leather	Thor Leather	SIF Leather
CH401	\$4423	\$4802	\$5106	\$5182	\$5191	\$6177	\$5742	\$5884	\$7012	\$10,022
COM/yds = 2¼										



For Canadian Pricing
 Multiply U.S. Price by the Canadian price factor.
 ▶ See page 1 for details.

CH445 Wing Chair by Carl Hansen & Son

DESIGN HANS WEGNER DESIGN ORIGIN: DENMARK, 1960

Only select finishes are available at this time.

Tip: For Customer's Own Material or Leather, see necessary requirements, important processing instructions, and ordering information
 ▶ See *Coalesse Surface Materials Reference Guide*.

Tip: CH445 is not available in cowhide.



Overall: 38¼"D 35½"W 40½"H
 Seat: 15¾"H



Overall: 19¼"D 24½"W 14¾"H

Standard Includes **Required to Specify**

- Chair or ottoman: fabric or Loke Leather
- Internal Beech wood frame
- Legs: stainless steel

- 1 Style number
 - 2 Fabric or leather color number for upholstery, if selected
- ▶ See *Coalesse Surface Materials Reference Guide*.

Specification Information

Style Number	U.S. Prices						Leather:			
	Fabric: COM	Group 1	Group 2	Group 3	Group 4	Group 5	COL	Loke Leather	Thor Leather	SIF Leather

Wing Chair

CH445	\$9785	\$9850	\$10,401	\$11,312	\$12,385	\$14,282	\$13,077	\$13,086	\$13,931	\$20,300
COM/yds = 9½										

Ottoman

CH446	\$3312	\$3321	\$ 3559	\$ 3767	\$ 3872	\$ 5001	\$ 3711	\$ 3720	\$ 4497	\$ 5655
COM/yds = 1¾										

Lounge Seating

For Canadian Pricing
 Multiply U.S. Price by the Canadian price factor.
 ▶ See page 1 for details.

Coalesse

CH468 Oculus Chair by Carl Hansen & Son

DESIGN HANS WEGNER DESIGN ORIGIN: DENMARK, 1958

Only select finishes are available at this time.



Overall: 37"D 37"W 41½"H

Tip: For Customer's Own Material or Leather, see necessary requirements, important processing instructions, and ordering information

▶ See *Coalesse Surface Materials Reference Guide*.

Tip: CH468 is not available in cowhide.

Standard Includes **Required to Specify**

- Chair: wood seat backrest
- Frame: black powder coat metal legs and solid beech

- 1 Style number
- 2 Fabric or leather color number for upholstery, if selected
- ▶ See *Coalesse Surface Materials Reference Guide*.

Specification Information

Style Number	U.S. Prices					Leather:			
	Fabric: COM	Group 1	Group 2	Group 3	Group 4	COL	Loke Leather	Thor Leather	SIF Leather
CH468	\$10,096	\$10,155	\$10,723	\$11,673	\$12,773	\$13,494	\$13,505	\$14,358	\$20,945



For Canadian Pricing
 Multiply U.S. Price by the Canadian price factor.
 ▶ See page 1 for details.

Coalesse

CH468 Oculus Chair by Carl Hansen & Son

DESIGN HANS WEGNER DESIGN ORIGIN: DENMARK, 1958

Circa Modular Seating

DESIGN ALISON SPEAR, AIA DESIGN ORIGIN: UNITED STATES

 = Available in Rapid10.

Tip: These colors are different than other Coalesse powder coats.

Tip: Recommended leathers are Elmosoft Grade C and Elmorustical Grade E.

Tip: Special color match, consult customer service.

Tip: Fabrics and leathers will appear loose with comfort wrinkles when upholstered.

Tip: Pricing based on highest grade textile specified.

Tip: Contrasting option not available on benches.

Tip: Optional steel leg has 90° corner taper shape.

Tip: For Customer's Own Material or Leather, see necessary requirements, important processing instructions, and ordering information
 ▶ See *Coalesse Surface Materials Reference Guide*.

Tip: Benches are flat and seats and loveseats are angled. These will not be aligned when placed next to each other. A table is recommended between the units to minimize the difference.

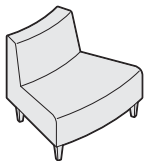

Overall: 28"D 36¾"W 29½"H
 Inside: 20"D 36¾"W 12¼"H
 Seat: 17¼"H
 Angle Degree: 30°

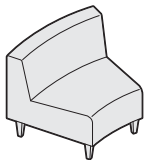

Overall: 28"D 36¾"W 29½"H
 Inside: 20"D 36¾"W 12¼"H
 Seat: 17¼"H
 Angle Degree: 30°

For Canadian Pricing
 Multiply U.S. Price by the Canadian price factor.
 ▶ See page 1 for details.

Standard Includes		Required to Specify	
	<ul style="list-style-type: none"> • Frame: unibody construction of hardwood plywood utilizing box joinery • Upholstery: multiple densities of polyurethane foam fixed seat and back with top stitch on seams • Legs: hardwood maple or walnut 		<ol style="list-style-type: none"> 1 Style number 2 Number of fabrics if contrasting fabric style number is selected 3 Fabric or leather color number for upholstery on seat and back 4 Wood color number for legs 5 Options, if selected (see below) ▶ See <i>Coalesse Surface Materials Reference Guide</i> .
Surface Materials	Options	U.S. Price	Required to Specify
	<ul style="list-style-type: none"> • Contrasting Fabric 	+\$118 per fabric	Add suffix K to the style number and select fabric color number.
	Acrylic backer <ul style="list-style-type: none"> • 30° outside facing wedge seat • 30° inside facing wedge seat • 60° outside and inside wedge loveseats • 60° benches • Straight seat • Straight loveseat • Straight bench 	+\$ 31 +\$ 33 +\$ 58 +\$ 39 +\$ 22 +\$ 46 +\$ 29	Specify with <i>acrylic backer</i> . Specify with <i>acrylic backer</i> . Specify with <i>acrylic backer</i> . Specify with <i>acrylic backer</i> . Specify with <i>acrylic backer</i> . Specify with <i>acrylic backer</i> . Specify with <i>acrylic backer</i> . ▶ See <i>Coalesse Surface Materials Reference Guide</i> .
	<ul style="list-style-type: none"> • Powder coat steel legs 	+\$134 per leg	Specify with <i>powder coat steel legs</i> and specify color number: 4138 Graphite Gloss 4140 Arctic White Gloss 4142 Platinum Gloss 4144 Black Gloss 4148 Midnight Brown Gloss

Specification Information															
Style Number	U.S. Base Prices												Leather Grades:		
	Fabric Grades:												COL	C	E
	COM	6	7	8	9	10	11	12	13	14					

30° Outside Facing Wedge Seat													
451-3730FO	\$1384	\$1384	\$1406	\$1442	\$1552	\$1624	\$1706	\$1764	\$1866	\$2008	\$1600	\$3151	\$3436
COM/yds = 3¼, COL/sq ft = 72													

30° Inside Facing Wedge Seat													
 451-3730FI	\$1384	\$1384	\$1406	\$1442	\$1552	\$1624	\$1706	\$1764	\$1866	\$2008	\$1600	\$3151	\$3436
COM/yds = 3¼, COL/sq ft = 72													

▶ Specification Information, continued on next page

Circa Modular Seating

DESIGN ALISON SPEAR, AIA DESIGN ORIGIN: UNITED STATES

 = Available in Rapid10.

► Specification Information, continued from previous page

Specification Information

Style Number	U.S. Base Prices										Leather Grades:		
	Fabric Grades:										COL	C	E
	COM	6	7	8	9	10	11	12	13	14			

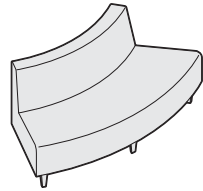

Overall: 28"D 71"W 29½"H
 Inside: 20"D 71"W 12¼"H
 Seat: 17¼"H
 Angle Degree: 60°

60° Outside Wedge Loveseat

451-7460FO	\$2200	\$2273	\$2315	\$2388	\$2609	\$2751	\$2917	\$3032	\$3236	\$3520	\$2366	\$5527	\$6095
COM/yds = 4½, COL/sq ft = 99													

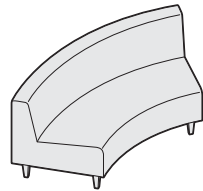

Overall: 28"D 71"W 29½"H
 Inside: 20"D 71"W 12¼"H
 Seat: 17¼"H
 Angle Degree: 60°



60° Inside Wedge Loveseat

451-7460FI	\$2200	\$2273	\$2315	\$2388	\$2609	\$2751	\$2917	\$3032	\$3236	\$3520	\$2366	\$5527	\$6095
COM/yds = 4¾, COL/sq ft = 105													

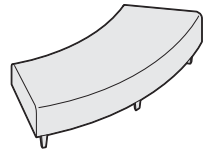

Overall: 28"D 71"W 17¼"H
 Seat: 17¼"H
 Angle Degree: 60°

60° Outside Wedge Bench

451-B7460FO	\$1743	\$1743	\$1763	\$1796	\$1898	\$1964	\$2040	\$2093	\$2187	\$2318	\$1961	\$3392	\$3658
COM/yds = 3, COL/sq ft = 66													

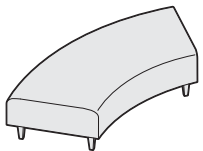

Overall: 28"D 71"W 17¼"H
 Seat: 17¼"H
 Angle Degree: 60°

60° Inside Wedge Bench

451-B7460FI	\$1743	\$1743	\$1763	\$1796	\$1898	\$1964	\$2040	\$2093	\$2187	\$2318	\$1961	\$3392	\$3658
COM/yds = 3, COL/sq ft = 66													

► Specification Information, continued on next page



For Canadian Pricing
 Multiply U.S. Price by the
 Canadian price factor.
 ► See page 1 for details.

Circa Modular Seating *continued*

DESIGN ALISON SPEAR, AIA DESIGN ORIGIN: UNITED STATES

► Specification Information, continued from previous page

Specification Information

Style Number	U.S. Base Prices											Leather Grades:		
	Fabric Grades:											COL	C	E
	COM	6	7	8	9	10	11	12	13	14				

Straight Seat Chair

451-2500	\$1243	\$1243	\$1259	\$1287	\$1372	\$1427	\$1490	\$1535	\$1613	\$1722	\$1478	\$2659	\$2877
COM/yds = 2½, COL/sq ft = 55													

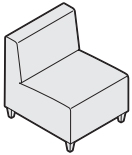

Overall: 28"D 25"W 29½"H
 Inside: 20"D 25"W 12¼"H
 Seat: 17¼"H
 Angle Degree: 0°

Straight Loveseat

451-5000	\$1784	\$1805	\$1838	\$1894	\$2064	\$2173	\$2301	\$2389	\$2546	\$2765	\$1955	\$4371	\$4807
COM/yds = 4, COL/sq ft = 83													

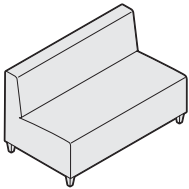

Overall: 28"D 50"W 29½"H
 Inside: 20"D 50"W 12¼"H
 Seat: 17¼"H
 Angle Degree: 0°

Straight Bench

451-B5000	\$1587	\$1587	\$1607	\$1640	\$1742	\$1808	\$1884	\$1937	\$2031	\$2162	\$1800	\$3241	\$3495
COM/yds = 3, COL/sq ft = 66													

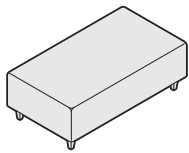

Overall: 28"D 50"W 17¼"H
 Seat: 17¼"H
 Angle Degree: 0°

Tip: Please submit sketch for modular application. One kit is required per two chairs.

Ganging Kit

451-GANGPKG	\$ 38	N.A.	N.A.	N.A.	N.A.	N.A.	N.A.	N.A.	N.A.	N.A.	N.A.	N.A.	N.A.
-------------	-------	------	------	------	------	------	------	------	------	------	------	------	------



For Canadian Pricing
 Multiply U.S. Price by the Canadian price factor.
 ► See page 1 for details.

Coalesse

Circa Modular Seating

DESIGN ALISON SPEAR, AIA DESIGN ORIGIN: UNITED STATES

Circa Upholstered Modular Arm Rests—Straight and 15°

DESIGN ALISON SPEAR, AIA DESIGN ORIGIN: UNITED STATES

Tip: Fabrics and leathers will appear loose with comfort wrinkles when upholstered.

Tip: Recommended leathers are Elmosoft Grade C and Elmorustical Grade E.

Tip: Special color match, consult customer service.

Tip: Pricing based on highest grade textile specified.

Tip: Optional steel leg has 90° corner taper shape.

Tip: These colors are different than other Coalesse powder coats.

Tip: For Customer's Own Material or Leather, see necessary requirements, important processing instructions, and ordering information
 ▶ See *Coalesse Surface Materials Reference Guide*.

Standard Includes	Required to Specify
<ul style="list-style-type: none"> • Frame: unibody construction of hardwood plywood utilizing box joinery • Upholstery: multiple densities of polyurethane foam • Top stitch on seams • Legs: hardwood maple or walnut • Ganging brackets and hardware included 	1 Style number 2 Fabric or leather color number for arm rests 3 Wood color number for legs 4 Options, if selected (see below) ▶ See <i>Coalesse Surface Materials Reference Guide</i> .

Options	U.S. Price	Required to Specify
Surface Materials <ul style="list-style-type: none"> • Contrasting fabric 	+\$118 per fabric	Add suffix K to the style number and select fabric color number.
Acrylic backer <ul style="list-style-type: none"> • Straight armrests and 15° armrests 	+\$ 19	Specify with acrylic backer. ▶ See <i>Coalesse Surface Materials Reference Guide</i> .
Metal Legs <ul style="list-style-type: none"> • Powder coat steel legs 	+\$134 per leg	Specify with powder coat steel legs and specify color number: 4138 Graphite Gloss 4140 Arctic White Gloss 4142 Platinum Gloss 4144 Black Gloss 4148 Midnight Brown Gloss

Specification Information														
Style Number	U.S. Base Prices											Leather Grades:		
	Fabric Grades:											COL	C	E
	COM	6	7	8	9	10	11	12	13	14				

Straight Armrest—Intermediate without Legs

451-A1800G	\$766	\$766	\$781	\$806	\$ 882	\$ 932	\$ 989	\$1029	\$1100	\$1198	\$ 972	\$1894	\$2063
COM/yds = 2¼, COL/sq ft = 50													

Straight Armrest—End of Run with Two Legs

451-A1800ER	\$889	\$889	\$904	\$929	\$1005	\$1055	\$1112	\$1152	\$1223	\$1321	\$1095	\$2017	\$2186
COM/yds = 2¼, COL/sq ft = 50													

15° Inside Armrest—Intermediate without Legs

451-A1815FIG	\$758	\$758	\$771	\$793	\$ 861	\$ 905	\$ 956	\$ 991	\$1054	\$1141	\$ 972	\$1786	\$1934
COM/yds = 2, COL/sq ft = 44													

15° Inside Armrest—End of Run with Two Legs

451-A1815FIER	\$930	\$930	\$943	\$965	\$1033	\$1077	\$1128	\$1163	\$1226	\$1313	\$1144	\$1958	\$2106
COM/yds = 2, COL/sq ft = 44													

▶ Specification Information, continued on next page



Overall: 28"D 18½"W 17"H

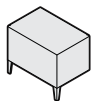

Overall: 28"D 18½"W 23½"H
 Tip: Specify left or right facing.



Overall: 28¾"D 18½"W 17"H



Overall: 28¾"D 18½"W 23½"H
 Tip: Specify left or right facing.



For Canadian Pricing
 Multiply U.S. Price by the Canadian price factor.
 ▶ See page 1 for details.

Circa Upholstered Modular Arm Rests—Straight and 15°

DESIGN ALISON SPEAR, AIA DESIGN ORIGIN: UNITED STATES

► Specification Information, continued from previous page

Specification Information

Style Number	U.S. Base Prices											Leather Grades:		
	Fabric Grades:											COL	C	E
	COM	6	7	8	9	10	11	12	13	14				

15° Outside Armrest—Intermediate without Legs

451-A1815FOG	\$758	\$758	\$771	\$793	\$ 861	\$ 905	\$ 956	\$ 991	\$1054	\$1141	\$ 972	\$1786	\$1934
COM/yds = 2, COL/sq ft = 44													

15° Outside Armrest—End of Run with Two Legs

451-A1815FOER	\$930	\$930	\$943	\$965	\$1033	\$1077	\$1128	\$1163	\$1226	\$1313	\$1144	\$1958	\$2106
COM/yds = 2, COL/sq ft = 44													

Ganging Kit

451-GANGPKG	\$ 38	N.A.	N.A.	N.A.	N.A.	N.A.	N.A.	N.A.	N.A.	N.A.	N.A.	N.A.	N.A.
-------------	-------	------	------	------	------	------	------	------	------	------	------	------	------



Overall: 28¾"D 18½"W 17"H

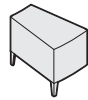

Overall: 28¾"D 18½"W 23½"H

Tip: Specify left or right facing.

Tip: Please submit sketch for modular application. One kit is required per two chairs.



For Canadian Pricing
 Multiply U.S. Price by the Canadian price factor.
 ► See page 1 for details.

Circa Upholstered Modular Arm rests–30° and Ottoman

DESIGN ALISON SPEAR, AIA DESIGN ORIGIN: UNITED STATES

Tip: For Customer's Own Material or Leather, see necessary requirements, important processing instructions, and ordering information
 ▶ See *Coalesse Surface Materials Reference Guide*.

Tip: Fabrics and leathers will appear loose with comfort wrinkles when upholstered.

Tip: Please submit sketch for modular applications. For ganging, contact customer service. 451-GANGPKG is available for \$34 list (one per two chairs).

Tip: These colors are different than other Coalesse powder coats.

Tip: Recommended leathers are Elmosoft Grade C and Elmorustical Grade E.

Tip: Contrasting option available only on ottoman.

Tip: 90° corner tapered shape leg is standard on arm rests. The ottoman legs are single width taper with no corner.

Tip: Special color match, consult customer service.

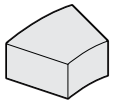

Overall: 29½"D 36¾"W 17"H

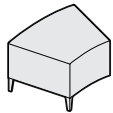

Overall: 29½"D 36¾"W 23½"H
Tip: Specify left or right facing.

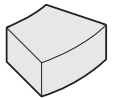

Overall: 29½"D 36¾"W 17"H



For Canadian Pricing
 Multiply U.S. Price by the Canadian price factor.
 ▶ See page 1 for details.

Standard Includes		Required to Specify	
	<ul style="list-style-type: none"> • Frame: unibody construction of hardwood plywood utilizing box joinery • Upholstery: multiple densities of polyurethane foam • Top stitch on seams • Legs: hardwood maple or walnut • Ganging brackets and hardware included 		<ol style="list-style-type: none"> 1 Style number 2 Number of fabrics if contrasting fabric style number is selected 3 Fabric or leather color number for arm rests 4 Wood color number for legs 5 Options, if selected (see below) ▶ See <i>Coalesse Surface Materials Reference Guide</i> .
Options		U.S. Price	Required to Specify
Surface Materials	• Contrasting fabric	+\$118 per fabric	Add suffix K to the style number and select fabric color number.
	Acrylic backer • 30° armrests and ottoman	+\$ 31	Specify with acrylic backer. ▶ See <i>Coalesse Surface Materials Reference Guide</i> .
Metal Legs	• Powder coat steel legs	+\$134 per leg	Specify with powder coat steel legs and specify color number: 4138 Graphite Gloss 4140 Arctic White Gloss 4142 Platinum Gloss 4144 Black Gloss 4148 Midnight Brown Gloss

Specification Information

Style Number	U.S. Base Prices													
	Fabric Grades:													Leather Grades:
	COM	6	7	8	9	10	11	12	13	14	COL	C	E	

30° Inside Arm Rest–Intermediate without Legs

451-A3730FIG	\$1083	\$1083	\$1103	\$1136	\$1238	\$1304	\$1380	\$1433	\$1527	\$1658	\$1263	\$2508	\$2734
COM/yds = 3, COL/sq ft = 66													

30° Inside Arm Rest–End of Run with Two Legs

451-A3730FIER	\$1215	\$1215	\$1235	\$1268	\$1370	\$1436	\$1512	\$1565	\$1659	\$1790	\$1395	\$2640	\$2866
COM/yds = 3, COL/sq ft = 66													

30° Outside Arm Rest–Intermediate without Legs

451-A3730FOG	\$1083	\$1083	\$1103	\$1136	\$1238	\$1304	\$1380	\$1433	\$1527	\$1658	\$1263	\$2508	\$2734
COM/yds = 3, COL/sq ft = 66													

▶ Specification Information, continued on next page

Circa Upholstered Modular Arm rests–30° and Ottoman

DESIGN ALISON SPEAR, AIA DESIGN ORIGIN: UNITED STATES

► Specification Information, continued from previous page

Specification Information

Style Number	U.S. Base Prices											Leather Grades:		
	Fabric Grades:											COL	C	E
	COM	6	7	8	9	10	11	12	13	14				

30° Outside Arm Rest–End of Run with Two Legs

451-A3730FOER	\$1215	\$1215	\$1235	\$1268	\$1370	\$1436	\$1512	\$1565	\$1659	\$1790	\$1395	\$2640	\$2866
---------------	--------	--------	--------	--------	--------	--------	--------	--------	--------	--------	--------	--------	--------

COM/yds = 3, COL/sq ft = 66

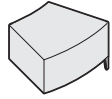

Overall: 29½"D 36¾"W 23½"H
Tip: Specify left or right facing.

Round Ottoman with Five Legs

451-B42RD	\$1721	\$1721	\$1743	\$1779	\$1889	\$1961	\$2043	\$2101	\$2203	\$2345	\$1893	\$3248	\$3490
-----------	--------	--------	--------	--------	--------	--------	--------	--------	--------	--------	--------	--------	--------

COM/yds = 3¼, COL/sq ft = 72

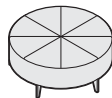

Overall: 42"Dia. 17"H



For Canadian Pricing
Multiply U.S. Price by the Canadian price factor.
► See page 1 for details.

Circa Freestanding Tables

DESIGN ALISON SPEAR, AIA DESIGN ORIGIN: UNITED STATES

Tip: Galvanized aluminum liner is not water tight, plastic liner recommended.

Tip: Please submit sketch for modular applications.

Tip: These colors are different than other Coalesse powder coats.

Tip: Optional steel leg has a 90° corner tapered shape.

Standard Includes	Required to Specify
-------------------	---------------------

- Frame: hardwood veneered panels
- Top and legs: hardwood maple or walnut
- Planter: galvanized aluminum

- 1 Style number
 - 2 Wood color number for legs and top
 - 3 Options, if selected (see below)
- ▶ See *Coalesse Surface Materials Reference Guide*.

Options	U.S. Price	Required to Specify
---------	------------	---------------------

Metal Legs	<ul style="list-style-type: none"> • Powder coat steel legs 	+\$134 per leg Specify with <i>powder coat steel legs</i> and specify color number: 4138 Graphite Gloss 4140 Arctic White Gloss 4142 Platinum Gloss 4144 Black Gloss 4148 Midnight Brown Gloss
-------------------	--	--

Specification Information

Style Number	U.S. Base Prices Walnut or Maple
--------------	-------------------------------------

30° Freestanding Low Table with Four Legs

45-T3730L	\$1914
-----------	--------

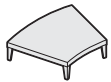

Overall: 29½"D 36⅝"W 8½"H

30° Freestanding High Table with Four Legs

45-T3730H	\$2566
-----------	--------

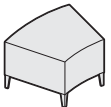

Overall: 29"D 36⅞"W 22½"H

60° Freestanding Table-Planter with Five Legs

45-T7460HP	\$5107
------------	--------

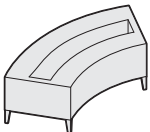

Overall: 33¼"D 70¾"W 22½"H



For Canadian Pricing
 Multiply U.S. Price by the Canadian price factor.
 ▶ See page 1 for details.

Circa Freestanding Tables

DESIGN ALISON SPEAR, AIA DESIGN ORIGIN: UNITED STATES

Tip: Please submit sketch for modular applications.

Tip: These colors are different than other Coalesse powder coats.

Tip: Optional steel leg has 90° corner taper shape on all tables except 42" round. 42" round has single width taper leg with no corner.

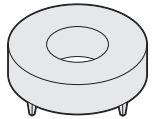

Overall: 42" dia. 15¾"H

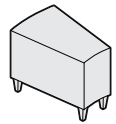

Overall: 28"D 18½"W 22½"H
Angle Degree: 15°

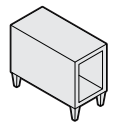

Overall: 27½"D 13½"W 22½"H
Angle Degree: 0°

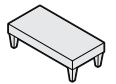

Overall: 27½"D 13½"W 8½"H
Angle Degree: 0°

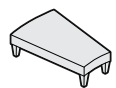

Overall: 28"D 18½"W 8½"H
Angle Degree: 15°

Standard Includes	Required to Specify
-------------------	---------------------

- Frame: hardwood veneered panels
- Top and legs: hardwood maple or walnut

- 1 Style number
 - 2 Wood color number for legs and top
 - 3 Options, if selected (see below)
- ▶ See *Coalesse Surface Materials Reference Guide*.

Options	U.S. Price	Required to Specify
---------	------------	---------------------

Glass Insert	<ul style="list-style-type: none"> • Glass insert for round table ¾" thick with translucent coating on bottom surface square edge detail 	+\$248	Specify <i>with glass insert</i> .
Metal Legs	<ul style="list-style-type: none"> • Powder coat steel legs 	+\$134 per leg	Specify <i>with powder coat steel legs</i> and specify color number: 4138 Graphite Gloss 4140 Arctic White Gloss 4142 Platinum Gloss 4144 Black Gloss 4148 Midnight Brown Gloss
Power/Data Module (45-T42RD only)	<ul style="list-style-type: none"> • Two power/two data ports for round table only matte black or silver mica 	+\$368	Specify finish color number.

Specification Information

Style Number	U.S. Base Prices	
	Walnut or Maple	Sunburst Top

Freestanding Round Table

45-T42RD	\$3464	\$3732
----------	--------	--------

Freestanding High Wedge Table

45-T1815H	\$2073	N.A.
-----------	--------	------

Freestanding High Straight Table

45-T1300H	\$2445	N.A.
-----------	--------	------

Freestanding Low Straight Table

45-T1300L	\$1602	N.A.
-----------	--------	------

Freestanding Low Wedge Table

45-T1815L	\$1602	N.A.
-----------	--------	------

Circa Ganging Tables

DESIGN ALISON SPEAR, AIA DESIGN ORIGIN: UNITED STATES

Standard Includes	Required to Specify
<ul style="list-style-type: none"> • Frame: hardwood veneered panels • Top and legs: hardwood maple or walnut • Ganging brackets and hardware included 	1 Style number 2 Wood color number for legs and top 3 Options, if selected (see below) ▶ See <i>Coalesse Surface Materials Reference Guide</i> .

Tip: Optional steel leg is a 90° corner taper leg.

Tip: These colors are different than other Coalesse powder coats.

Tip: Please submit sketch for modular applications. For ganging, contact customer service.

Options	U.S. Price	Required to Specify
Metal Legs <ul style="list-style-type: none"> • Powder coat steel legs on end-of-run tables only 	+\$134 per leg	Specify with <i>powder coat steel legs</i> and specify color number: 4138 Graphite Gloss 4140 Arctic White Gloss 4142 Platinum Gloss 4144 Black Gloss 4148 Midnight Brown Gloss
Leg Position <ul style="list-style-type: none"> • Left-side facing • Right-side facing 	No cost No cost	Specify with <i>left-side legs</i> . Specify with <i>right-side legs</i> .

Specification Information	
Style Number	U.S. Base Price Walnut or Maple

Ganging Low Wedge Table

45-T1815LG \$1260

End-of-Run Low Wedge Table

45-T1815LER \$1428

Ganging High Wedge Table

45-T1815HG \$1738

Ganging High Straight Table

45-T1300HG \$2106

End-of-Run High Straight Table

45-T1300HER \$2308

▶ Specification Information, continued on next page

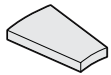

Overall: 28"D 18½"W 8½"H
Angle Degree: 15°

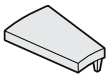

Overall: 28"D 18½"W 8½"H
Angle Degree: 15°

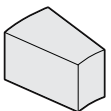

Overall: 28"D 18½"W 22½"H
Angle Degree: 15°

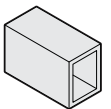

Overall: 27½"D 13½"W 22½"H
Angle Degree: 0°

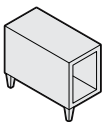

Overall: 27½"D 13½"W 22½"H
Angle Degree: 0°



For Canadian Pricing
 Multiply U.S. Price by the Canadian price factor.
 ▶ See page 1 for details.

Circa Ganging Tables

DESIGN ALISON SPEAR, AIA DESIGN ORIGIN: UNITED STATES

► Specification Information, continued from previous page

Specification Information

Style Number	U.S. Base Price
	Walnut or Maple

End-of-Run High Wedge Table

45-T1815HER	\$1900
-------------	--------

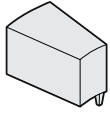

Overall: 28"D 18½"W 22½"H
Angle Degree: 15°

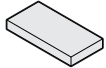

Overall: 27½"D 13½"W 8½"H
Angle Degree: 0°

Ganging Low Straight Table

45-T1300LG	\$1230
------------	--------

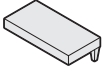

Overall: 27½"D 13½"W 8½"H
Angle Degree: 0°

End-of-Run Low Straight Table

45-T1300LER	\$1428
-------------	--------

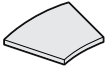

Overall: 29"D 36⅝"W 2"H
(8½" from floor once assembled)

30° Ganging without Legs

45-T3730LG	\$1543
------------	--------

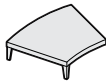

Overall: 29"D 36⅝"W 8½"H

30° End-of-Run with Two Legs

45-T3730LER	\$1726
-------------	--------



Overall: 13¾"D 27½"W 22¼"H
(8½" from floor once assembled)
Tip: Model 45-T28HER has only a single width tapered leg, no corner.

30° End-of-Run with One Leg

45-T28HER	\$1862
-----------	--------

► Specification Information, continued on next page

Options for Creating 90° Applications:

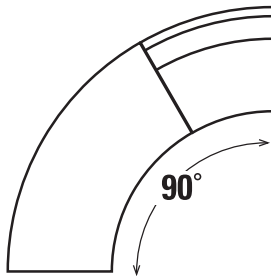

- (1) 30° Outside or Inside Facing Wedge Seat
- (1) 60° Wedge Bench

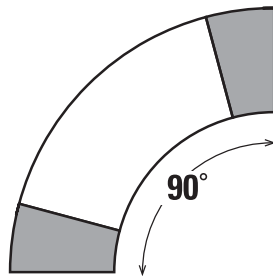

- (2) 15° Wedge Tables
- (1) 60° Wedge Bench

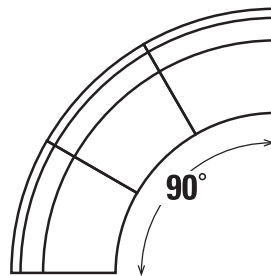

- (3) 30° Outside or Inside Facing Wedge Seats

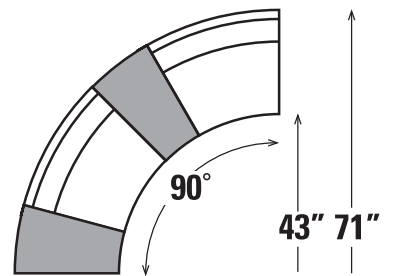

- (2) 30° Outside or Inside Facing Wedge Seats
- (2) 15° Wedge Tables

Circa Ganging Tables *continued*

DESIGN ALISON SPEAR, AIA DESIGN ORIGIN: UNITED STATES

► Specification Information, continued from previous page

Specification Information

Style Number	U.S. Base Price
	Walnut or Maple

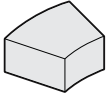

Overall: 29"D 36⁵/₈"W 16"H

30° Ganged High Table without Legs

45-T3730HG \$2198

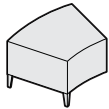

Overall: 29"D 36⁵/₈"W 22¹/₂"H

30° End-of-Run High Table with Two Legs

45-T3730HER \$2377

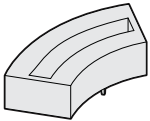

Overall: 33¹/₄"D 70³/₄"W 22¹/₂"H

60° Ganged Table-Planter with Two Legs Front and Back

45-T7460HPG \$4883

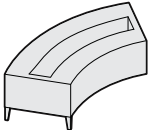

Overall: 33¹/₄"D 70³/₄"W 22¹/₂"H

60° End-of-Run Table-Planter with Three Legs

45-T7460HPER \$4929



For Canadian Pricing
 Multiply U.S. Price by the
 Canadian price factor.
 ► See page 1 for details.

Circa Multi-Fabric Diagram

Applies to all Circa models including: Straight Seat, Wedge, and Straight Loveseat

TO: _____

FROM: _____

DATE: _____

FAX...888.413.5161

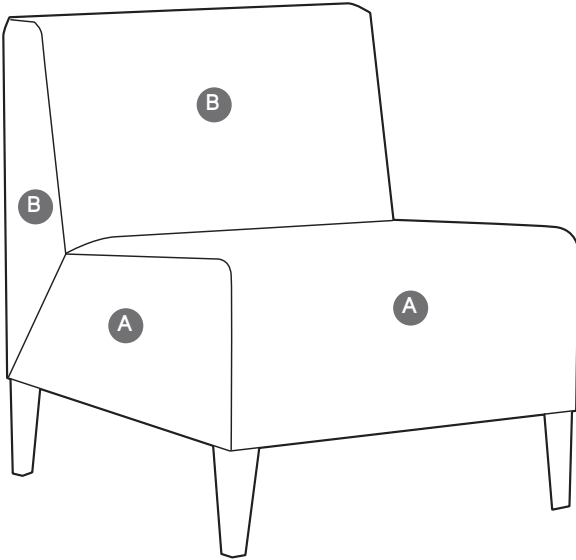

A Upholstery Selection (default for entire unit if B is not selected):

B Back: _____

\$118 U.S. list per contrasting fabric specified. List price based on highest fabric grade usage.

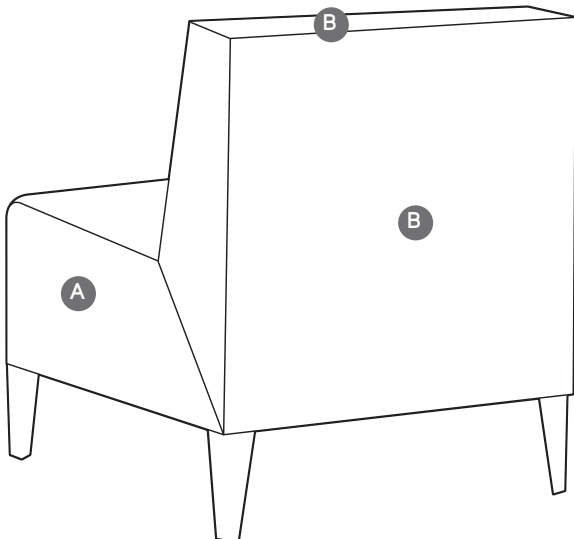

Specify model below:

451-7460FOK Outside Facing

451-7460FIK Inside Facing

451-5000K

451-2500K

451-3730FOK Outside Facing

451-3730FIK Inside Facing



For Canadian Pricing
 Multiply U.S. Price by the
 Canadian price factor.
 ▶ See page 1 for details.

Coupe

DESIGN DENNIE PIMENTAL / JOHN DUFFY DESIGN ORIGIN: UNITED STATES

 = Available in Rapid10.

Tip: Fabrics and leathers will appear loose with comfort wrinkles when upholstered.

Tip: Recommended leathers are Elmosoft Grade C and Elmorustical Grade E.

Tip: Special color match, consult customer service.

Tip: Pricing based on highest grade textile specified.

Tip: For Customer's Own Material or Leather, see necessary requirements, important processing instructions, and ordering information
 ► See *Coalesse Surface Materials Reference Guide*.

Standard Includes	Required to Specify
<ul style="list-style-type: none"> • Frame: unibody construction of hardwood plywood utilizing box joinery • Legs: solid beech • Glides: non-adjustable • Upholstery: multiple densities of laminated polyurethane foam and polyester fiber on seat and back with top stitch sewing detail 	<ol style="list-style-type: none"> 1 Style number 2 Number of fabrics if contrasting fabric style number is selected 3 Wood color number for legs 4 Fabric or leather color number for upholstery on seat and back 5 Options, if selected (see below) ► See <i>Coalesse Surface Materials Reference Guide</i> .

Options	U.S. Price	Required to Specify
Surface Materials <ul style="list-style-type: none"> • Contrasting fabric <hr/> <ul style="list-style-type: none"> • Acrylic backer • Chair +\$ 39 • Loveseat +\$ 52 • Sofa +\$ 63 • Ottoman +\$ 17 	+\$118 per fabric	Add suffix K to the style number and select fabric color number. Specify with <i>acrylic backer</i> . Specify with <i>acrylic backer</i> . Specify with <i>acrylic backer</i> . Specify with <i>acrylic backer</i> . ► See <i>Coalesse Surface Materials Reference Guide</i> .
Legs <ul style="list-style-type: none"> • Brushed aluminum • Powder coat <hr/> <ul style="list-style-type: none"> • Acrylic: clear 	+\$162 +\$128 +\$226	Specify with <i>brushed aluminum legs</i> . Specify with <i>powder coat legs</i> and select color: 4138 Graphite Gloss 4140 Arctic White Gloss 4142 Platinum Gloss 4144 Black Gloss Specify with <i>acrylic legs</i> .
Casters <ul style="list-style-type: none"> • Ottoman casters 	+\$142	Specify with <i>casters</i> .

Specification Information

Style Number	U.S. Base Prices														Leather Grades:		
	Fabric Grades:														COL	C	E
	COM	6	7	8	9	10	11	12	13	14							

Chair

 470	\$1492	\$1492	\$1520	\$1567	\$1711	\$1805	\$1913	\$1988	\$2121	\$2307	\$1656	\$3583	\$3932
COM/yds = 4 ¹ / ₄ , COL/sq ft = 94													

Loveseat

470-2	\$2220	\$2267	\$2305	\$2369	\$2564	\$2690	\$2837	\$2938	\$3119	\$3370	\$2380	\$5193	\$5377
COM/yds = 5 ³ / ₄ , COL/sq ft = 127													

► Specification Information, continued on next page

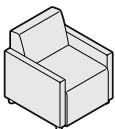

Overall: 28"D 26¹/₂"W 30"H
 Inside: 20"D 22"W 13"H
 Seat: 17"H
 Arm: 22"H

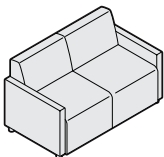

Overall: 28"D 52¹/₂"W 30"H
 Inside: 20"D 48"W 13"H
 Seat: 17"H
 Arm: 22"H



For Canadian Pricing
 Multiply U.S. Price by the Canadian price factor.
 ► See page 1 for details.

Coupe

DESIGN DENNIE PIMENTAL / JOHN DUFFY DESIGN ORIGIN: UNITED STATES

► Specification Information, continued from previous page

Specification Information

Style Number	U.S. Base Prices											Leather Grades:		
	Fabric Grades:											COL	C	E
	COM	6	7	8	9	10	11	12	13	14				

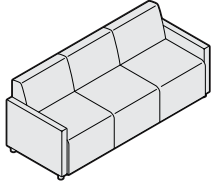

Overall: 28"D 72"W 30"H
 Inside: 20"D 67½"W 13"H
 Seat: 17"H
 Arm: 22"H

Sofa

470-3	\$2561	\$2651	\$2697	\$2775	\$3013	\$3166	\$3344	\$3468	\$3688	\$3994	\$2713	\$5930	\$6505
-------	--------	--------	--------	--------	--------	--------	--------	--------	--------	--------	--------	--------	--------

COM/yds = 7, COL/sq ft = 154



Overall: 20"D 25"W 18"H

Ottoman

470-H	\$ 706	\$ 706	\$ 719	\$ 741	\$ 809	\$ 853	\$ 904	\$ 939	\$1002	\$1089	\$ 937	\$1821	\$1988
-------	--------	--------	--------	--------	--------	--------	--------	--------	--------	--------	--------	--------	--------

COM/yds = 2, COL/sq ft = 44



For Canadian Pricing
 Multiply U.S. Price by the
 Canadian price factor.
 ► See page 1 for details.

Coupe Grande/Mobile

DESIGN DENNIE PIMENTAL / JOHN DUFFY DESIGN ORIGIN: UNITED STATES

 = Available in Rapid10.

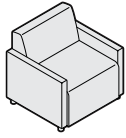

Tip: Fabrics and leathers will appear loose with comfort wrinkles when upholstered.

Tip: Recommended leathers are Elmosoft Grade C and Elmorustical Grade E.

Tip: Special color match, consult customer service.

Tip: For Customer's Own Material or Leather, see necessary requirements, important processing instructions, and ordering information
 ► See *Coalesse Surface Materials Reference Guide*.

Tip: Pricing based on highest grade textile specified.

Standard Includes	Required to Specify
<ul style="list-style-type: none"> • Frame: unibody construction of hardwood plywood utilizing box joinery • Legs: solid beech • Glides: non-adjustable • Upholstery: multiple densities of laminated polyurethane foam and polyester fiber on seat and back with top stitch sewing detail • On 476M model: <ul style="list-style-type: none"> - Casters: swivel hard - Locking and non-locking wheels Tablet: <ul style="list-style-type: none"> - Laminate - 13½" diameter 	<ol style="list-style-type: none"> 1 Style number 2 Number of fabrics if contrasting fabric style number is selected 3 Wood color number for legs 4 Fabric or leather color number for seat and back 5 Laminate color number for 476M tablet, if selected 6 Options, if selected (see below) ► See <i>Coalesse Surface Materials Reference Guide</i> .

	Options	U.S. Price	Required to Specify
Surface Materials	• Contrasting fabric	+\$118 per fabric	Add suffix K to the style number and select fabric color number.
	Acrylic backer		
	<ul style="list-style-type: none"> • Chair • Loveseat • Sofa 	<ul style="list-style-type: none"> +\$ 46 +\$ 60 +\$ 72 	Specify with <i>acrylic backer</i> . Specify with <i>acrylic backer</i> . Specify with <i>acrylic backer</i> . ► See <i>Coalesse Surface Materials Reference Guide</i> .
Casters on 476M only	• Soft casters	No cost	Specify with <i>soft casters</i> .
Legs	<ul style="list-style-type: none"> • Brushed aluminum • Powder coat 	<ul style="list-style-type: none"> +\$162 +\$128 	Specify with <i>brushed aluminum legs</i> . Specify with <i>powder coat legs</i> and select color: 4138 Graphite Gloss 4140 Arctic White Gloss 4142 Platinum Gloss 4144 Black Gloss Specify with <i>acrylic legs</i> .
		• Acrylic: clear	+\$226
Tablet 476M only	• Anodized aluminum	+\$220	Specify with <i>anodized aluminum tablet</i> .
	• Wood	+\$122	Specify with <i>wood tablet</i> and select wood color number.
	• Omit tablet	-\$161	Specify with <i>remove tablet</i> .



For Canadian Pricing
 Multiply U.S. Price by the Canadian price factor.
 ► See page 1 for details.

Coupe Grande/Mobile

DESIGN DENNIE PIMENTAL / JOHN DUFFY DESIGN ORIGIN: UNITED STATES

 = Available in Rapid10.

Specification Information

Style Number	U.S. Base Prices													
	Fabric Grades:											Leather Grades:		
	COM	6	7	8	9	10	11	12	13	14	COL	C	E	

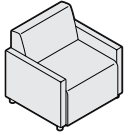

Overall: 28"D 31"W 30"H
 Inside: 20"D 25"W 13"H
 Seat: 17"H
 Arm: 22"H

Chair

476	\$1703	\$1724	\$1757	\$1813	\$1983	\$2092	\$2220	\$2308	\$2465	\$2684	\$1855	\$4139	\$4550
-----	--------	--------	--------	--------	--------	--------	--------	--------	--------	--------	--------	--------	--------

COM/yds = 5, COL/sq ft = 110

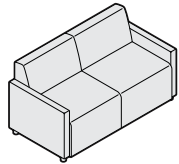

Overall: 28"D 61½"W 30"H
 Inside: 20"D 55½"W 13"H
 Seat: 17"H
 Arm: 22"H

Loveseat

476-2	\$3089	\$3145	\$3184	\$3251	\$3455	\$3586	\$3739	\$3845	\$4034	\$4296	\$3239	\$5990	\$6481
-------	--------	--------	--------	--------	--------	--------	--------	--------	--------	--------	--------	--------	--------

COM/yds = 6, COL/sq ft = 132

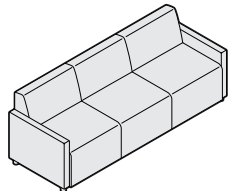

Overall: 28"D 80"W 30"H
 Inside: 20"D 74"W 13"H
 Seat: 17"H
 Arm: 22"H

Sofa

476-3	\$3504	\$3594	\$3640	\$3718	\$3956	\$4109	\$4287	\$4411	\$4631	\$4937	\$3654	\$6872	\$7448
-------	--------	--------	--------	--------	--------	--------	--------	--------	--------	--------	--------	--------	--------

COM/yds = 7, COL/sq ft = 154

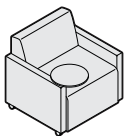

Overall: 28"D 31"W 30"H
 Inside: 20"D 25"W 13"H
 Seat: 17"H
 Arm: 22"H

Mobile Chair

476M	\$2291	\$2312	\$2345	\$2401	\$2571	\$2680	\$2808	\$2896	\$3053	\$3272	\$2443	\$4720	\$5133
------	--------	--------	--------	--------	--------	--------	--------	--------	--------	--------	--------	--------	--------

COM/yds = 5, COL/sq ft = 110



For Canadian Pricing
 Multiply U.S. Price by the
 Canadian price factor.
 ▶ See page 1 for details.

Coupe Wood

DESIGN DENNIE PIMENTAL / JOHN DUFFY DESIGN ORIGIN: UNITED STATES

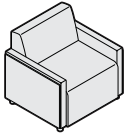

Overall: 29"D 28"W 30"H
 Inside: 20"D 22"W 13"H
 Seat: 17"H
 Arm: 22"H

Tip: Fabrics and leathers will appear loose with comfort wrinkles when upholstered.

Tip: Recommended leathers are Elmosoft Grade C and Elmorustical Grade E.

Tip: Special color match, consult customer service.

Tip: For Customer's Own Material or Leather, see necessary requirements, important processing instructions, and ordering information
 ▶ See Coalesse Surface Materials Reference Guide.

Standard Includes	Required to Specify
<ul style="list-style-type: none"> • Frame: unibody construction of hardwood plywood utilizing box joinery • Legs: solid wood • Glides: non-adjustable • Upholstery: multiple densities of laminated polyurethane foam and polyester fiber on seat and back with top stitch sewing detail 	<ol style="list-style-type: none"> 1 Style number 2 Number of fabrics if contrasting fabric style number is selected 3 Wood color number for legs 4 Fabric or leather color number for upholstery on seat and back 5 Options, if selected (see below) ▶ See Coalesse Surface Materials Reference Guide.

Options	U.S. Price	Required to Specify
Surface Materials <ul style="list-style-type: none"> • Contrasting fabric 	+\$118 per fabric	Add suffix K to the style number and select fabric color number.
Acrylic backer <ul style="list-style-type: none"> • Chair 	+\$ 39	Specify with acrylic backer. ▶ See Coalesse Surface Materials Reference Guide.
Legs <ul style="list-style-type: none"> • Brushed aluminum • Powder coat 	+\$162 +\$128	Specify with brushed aluminum legs. Specify with powder coat legs and select color: 4138 Graphite Gloss 4140 Arctic White Gloss 4142 Platinum Gloss 4144 Black Gloss
<ul style="list-style-type: none"> • Acrylic: clear 	+\$226	Specify with acrylic legs.

Specification Information													
Style Number	U.S. Base Prices											Leather Grades:	
	Fabric Grades:											COL	C
	COM	6	7	8	9	10	11	12	13	14			

Chair

473MAPLE	\$3654	\$3654	\$3682	\$3729	\$3873	\$3967	\$4075	\$4150	\$4283	\$4469	\$3810	\$5736	\$6087
473WALNUT	\$3741	\$3741	\$3769	\$3816	\$3960	\$4054	\$4162	\$4237	\$4370	\$4556	\$3895	\$5830	\$6181

COM/yds = 4 1/4, COL/sq ft = 94



For Canadian Pricing
 Multiply U.S. Price by the Canadian price factor.
 ▶ See page 1 for details.

Davos by Viccarbe

DESIGN JEFFREY BERNETT DESIGN ORIGIN: 2006 SPAIN

Tip: For Customer's Own Material or Leather, see necessary requirements, important processing instructions, and ordering information
 ▶ See *Coalesse Surface Materials Reference Guide*.

Tip: Fabrics and leathers will appear loose with comfort wrinkles when upholstered.

▶ See page 130 for Multi-Fabric Diagram.

Tip: K suffix must be specified for leather underside.

Tip: Models with fabric underside include black denim section to allow for proper air flow. If this aesthetic is not desired, select contrasting option with leather underside.

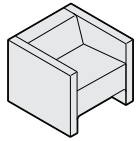

Overall: 30"D 30"W 25½"H
 Seat: 19"D 24"W 16½"H

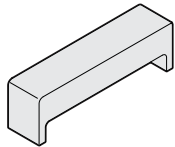

Overall: 13¼"D 59½"W 17½"H

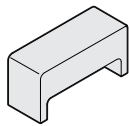

Overall: 13¼"D 38"W 17½"H



Overall: 13¼"D 18½"W 17½"H



For Canadian Pricing
 Multiply U.S. Price by the Canadian price factor.
 ▶ See page 1 for details.

Standard Includes	Required to Specify
-------------------	---------------------

- | | |
|--|---|
| <ul style="list-style-type: none"> Upholstery for chair or bench: fabric or leather | <ol style="list-style-type: none"> Style number Number of fabrics if contrasting fabric style number is selected Fabric or leather color number for upholstery Options, if selected (see below) ▶ See <i>Coalesse Surface Materials Reference Guide</i> . |
|--|---|

Options	U.S. Price	Required to Specify
---------	------------	---------------------

Surface Materials	<ul style="list-style-type: none"> Contrasting Fabric 	+\$118 per fabric	Add suffix K to the style number and select fabric color number.
	Acrylic backer <ul style="list-style-type: none"> Chair Large bench Medium bench Small bench 	+\$ 54 +\$ 33 +\$ 24 +\$ 15	Specify with <i>acrylic backer</i> . Specify with <i>acrylic backer</i> . Specify with <i>acrylic backer</i> . Specify with <i>acrylic backer</i> . ▶ See <i>Coalesse Surface Materials Reference Guide</i> .

Specification Information

Style Number	U.S. Base Prices											Leather Grades:		
	Fabric Grades:											COL	C	E
	COM	6	7	8	9	10	11	12	13	14				

Chair

CODAV	\$2222	\$2243	\$2276	\$2332	\$2502	\$2611	\$2739	\$2827	\$2984	\$3203	\$2346	\$4064	\$4357
-------	--------	--------	--------	--------	--------	--------	--------	--------	--------	--------	--------	--------	--------

COM/yds = 5, COL/sq ft = 110

Large Bench

CODAV60	\$1828	\$1828	\$1850	\$1886	\$1996	\$2068	\$2150	\$2208	\$2310	\$2452	\$1991	\$2984	\$3148
---------	--------	--------	--------	--------	--------	--------	--------	--------	--------	--------	--------	--------	--------

COM/yds = 3¼, COL/sq ft = 71½

Medium Bench

CODAV38	\$1312	\$1312	\$1328	\$1356	\$1441	\$1496	\$1559	\$1604	\$1682	\$1791	\$1500	\$2388	\$2535
---------	--------	--------	--------	--------	--------	--------	--------	--------	--------	--------	--------	--------	--------

COM/yds = 2½, COL/sq ft = 55

Small Bench

CODAV16	\$ 795	\$ 795	\$ 806	\$ 826	\$ 885	\$ 924	\$ 968	\$ 999	\$1054	\$1131	\$1009	\$1692	\$1822
---------	--------	--------	--------	--------	--------	--------	--------	--------	--------	--------	--------	--------	--------

COM/yds = 1¾, COL/sq ft = 39

Davos Multi-Fabric Diagram

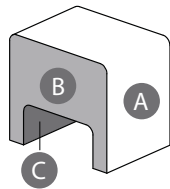
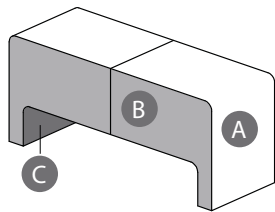
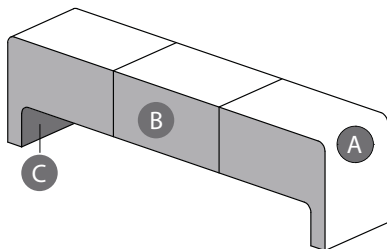
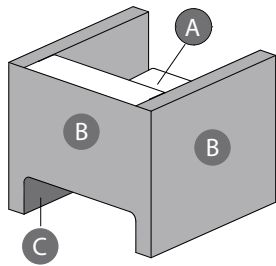
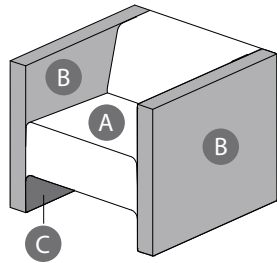

TO: _____

FROM: _____

DATE: _____

FAX...888.413.5161

Davos Chair

- A** Seat (upholstery selections default for entire unit if B is not selected): _____
- B** Arms and Back: _____
- C** Underside: _____

Davos Large Bench

- A** Seat (upholstery selections default for entire unit if B is not selected): _____
- B** Side: _____
- C** Underside: _____

Davos Medium Bench

- A** Seat (upholstery selections default for entire unit if B is not selected): _____
- B** Side: _____
- C** Underside: _____

Davos Small Bench

- A** Seat (upholstery selections default for entire unit if B is not selected): _____
- B** Side: _____
- C** Underside: _____

\$118 list per contrasting fabric specified. List price based on highest grade textile specified.

***Highest grade pricing will not apply to C and E leathers when applied to the underside.*



For Canadian Pricing
 Multiply U.S. Price by the
 Canadian price factor.
 ▶ See page 1 for details.

Coalesse

Davos Multi-Fabric Diagram

Detour

DESIGN METRO DESIGN GROUP | STEELCASE AND IDGO

Detour lounge seating offers a range of soft seating with embedded features that provide user control and personal comfort for informal work activities. Three lounge chair sizes are available – small lounge with a narrow back, small lounge with a wide back, and large lounge. An ottoman is also available.

Cast handle is integrated into the top of the back cushion. It is used to move or position the chair.

Back is fully upholstered. It flexes for user comfort.

Tablet arm is available. It pivots into position or can be moved out of the user's way.

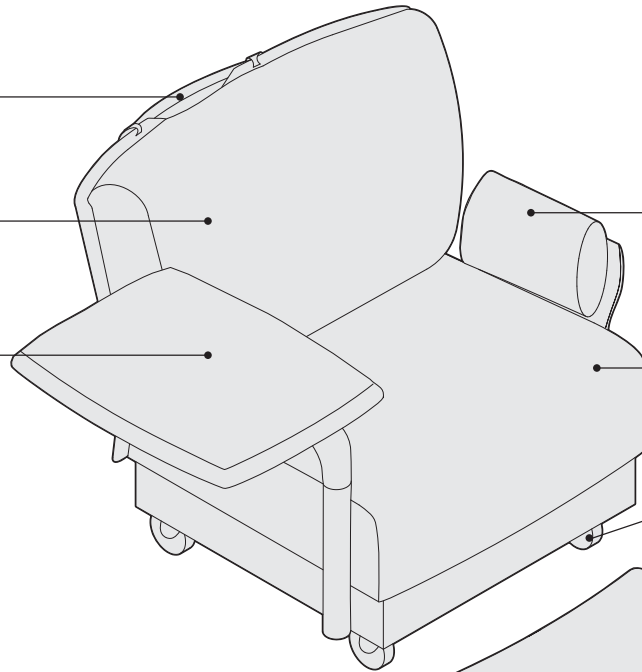

Arms are fully upholstered. They are available on the left, right, or both sides. An armless model is also available.

Seat is fully upholstered.

Soft casters provide ease of mobility. They are non-locking.

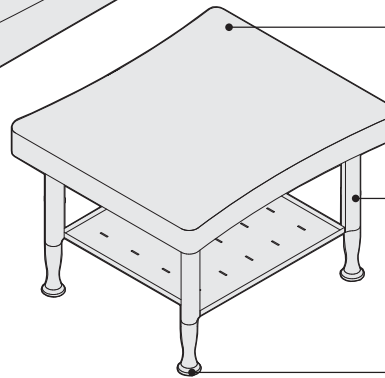

Ottoman can be used as a footrest, bench, or soft work-surface. An open shelf below the seat provides storage.

Legs are finished with paint.

Adjustable glides painted to match the legs with a black plastic bottom. Glides adjust 3/4".

Actual dimensions
▶ See page 134

Detour

DESIGN METRO DESIGN GROUP | STEELCASE AND IDEO

Product Details

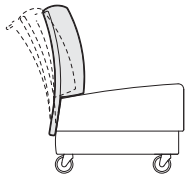

Flex-back allows the user to lean back with the concealed flex-back mechanism. The amount of recline resistance is directly proportional to the user's weight.

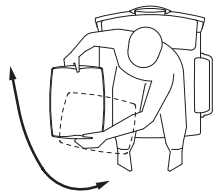

Tablet arm pivots into position or out of the way. The tablet arm is handed for use on the left- or right-hand side of the chair.

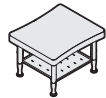

Ottoman is available with glides or casters. It is intended as a footrest. However, it also provides a backless seating option. It is equipped with a lower storage shelf.

Multiple fabrics can be specified on an individual unit for an additional fee per specified fabric. A lounge chair can have up to five additional fabrics.

Lounge chair

- Seat cushion (including sides of seat cushion) - no additional fee
- Back cushion (including sides of back cushion) - additional fee
- Base frame - additional fee
- Back frame (outside back panel) - additional fee
- Inside arms - no additional fee
- Outside arms - no additional fee

► See *Detour multi-fabric diagram and yardage request form*, page 141.

Connections

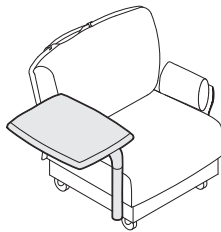

Tablet arm is handed. A right-hand tablet connects to the right side and a left-hand tablet connects to the left side while facing the chair. It may be attached on the same side as an arm. It is positioned in front and over the arm, so the movement isn't restricted.

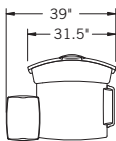
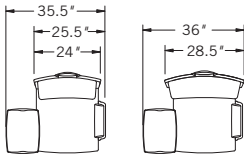

Overall width increases when a tablet arm is attached.

Surface Materials

Seat, inner back, outer back frame, base frame, inside arm, and outside arm, if selected

- Fabric

Tablet arm surface

- Laminate Grade 1
- Wood veneer

Support for tablet arm

- Paint

Cast handle

- Paint

Legs

- Paint

Glides

- Paint

Casters

- Paint

Ottoman lower storage shelf

- Paint

Note: Refer to the *Coalesse Surface Materials Reference Guide* for additional surface materials information.

Programs & Services

Customer's Own Material/Leather (COM/COL) program is available.

► See *Coalesse Surface Materials Reference Guide* for additional information.

Designers

Metro Design Group | Steelcase & IDEO

Detour continued

DESIGN METRO DESIGN GROUP | STEELCASE AND IDEO

Actual Dimensions

	Overall Depth	Width	Height	Seat Depth	Width	Seat height from floor: at back, at front	Back height from seat at back	Back width	Arm height	Tablet height
Small lounge, narrow back without arms	29"	24"	31"	18½"	22"	16½"-front 14½"-back	16½"	21½"	n.a.	24½"
Small lounge, narrow back with one arm	29"	25½"	31"	18½"	22"	16½"-front 14½"-back	16½"	21½"	22½"	24½"
Small lounge, narrow back with two arms	29"	28½"	31"	18½"	22"	16½"-front 14½"-back	16½"	21½"	22½"	24½"
Small lounge, wide back <i>Tip: overall dimensions are the same for all models, regardless of the arm selection.</i>	29"	28½"	31"	18½"	22"	16½"-front 14½"-back	16½"	25¾"	22½"	24½"
Large lounge <i>Tip: overall dimensions are the same for all models, regardless of the arm selection.</i>	29"	28½"	31"	19½"	25"	16½"-front 14½"-back	16½"	28¾"	22½"	24½"
Small arm	14"	4"	22½"	N.A.	N.A.	N.A.	N.A.	N.A.	N.A.	N.A.
Large arm	15"	4"	22½"	N.A.	N.A.	N.A.	N.A.	N.A.	N.A.	N.A.
Tablet arm	16"	12"	24½" when attached	N.A.	N.A.	N.A.	N.A.	N.A.	N.A.	N.A.
Ottoman	20"	23"	16½"	N.A.	N.A.	N.A.	N.A.	N.A.	N.A.	N.A.

Coalesse

Detour

DESIGN METRO DESIGN GROUP | STEELCASE AND IDEO

Detour Lounge Chairs **X10/15**

DESIGN METRO DESIGN GROUP | STEELCASE AND IDEO

Tip: Begin a new series of line items for each chair configuration.

Tip: For veneer tops, edge and top will be the same finish color. For laminate tops, edge will always be black.

Tip: Fabrics and leathers will appear loose with comfort wrinkles when upholstered.

Tip: When specifying fabric in different price grades, the highest price grade prevails.

Tip: The COM yards and COL square footage listed on these pages reflect the requirements for a single fabric that are based on non-directional 54"W material applied railroaded. For multi-fabric COM requirements, please refer to multi-fabric yardage.
▶ Page 141

Tip: For Customer's Own Material or Leather, see necessary requirements, important processing instructions, and ordering information
▶ See Coalesse Surface Materials Reference Guide.

Tip: Tablet arm, if selected, should be entered on consecutive lines of the purchase order immediately following the lounge chair to which it will be applied. Components for identical chair configurations may be grouped together on consecutive lines.

Tip: Handedness is determined while facing the chair.

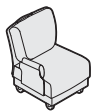

For Canadian Pricing
Multiply U.S. Price by the Canadian price factor.
▶ See page 1 for details.

Standard Includes		Required to Specify
▶ Need help? product details, page 132	<ul style="list-style-type: none"> • Seat, inner back, outer back frame, base frame, inside and outside arms, if selected: fabric or leather • Cast handle: paint • Legs and adjustable glides, if selected: paint • Casters, if selected: paint • Tablet arm surface, if selected: laminate (Grade 1) or wood veneer • Tablet arm support: paint 	<ol style="list-style-type: none"> 1 Style number 2 Number of fabrics if contrasting fabric style number is selected 3 Fabric or leather color number for seat, inner back, outer back frame, base frame, inside and outside arms, if selected 4 Paint color number for cast handle, legs, glides or casters, and tablet arm support, if selected 5 Laminate or wood color number for tablet arm, if selected 6 Options, if selected (see below) ▶ See Coalesse Surface Materials Reference Guide.

Options	U.S. Price	Required to Specify
Surface Materials	• Contrasting fabric +\$118 per fabric	Add suffix K to the style number and select fabric color number.
Acrylic backer		
• Backer for small lounge with narrow back and no arms	+\$ 33	Specify with acrylic backer.
• Backer for small lounge with wide back and no arms	+\$ 37	Specify with acrylic backer.
• Backer for large chair with no arms	+\$ 46	Specify with acrylic backer.
• Backer for small lounge with narrow back and one arm	+\$ 39	Specify with acrylic backer.
• Backer for small lounge with wide back and one arm	+\$ 44	Specify with acrylic backer.
• Backer for large chair and one arm	+\$ 52	Specify with acrylic backer.
• Backer for small lounge with narrow back and two arms	+\$ 46	Specify with acrylic backer.
• Backer for small lounge with wide back and two arms	+\$ 50	Specify with acrylic backer.
• Backer for large chair and two arms	+\$ 58	Specify with acrylic backer.
Related Products	• Ottoman	▶ page 140

Specification Information													
Style Number	U.S. Base Prices											Leather Grades:	
	Fabric Grades:											COL	C
	COM	6	7	8	9	10	11	12	13	14			

Small Lounge Chair with Narrow Back and No Arms

With Casters

1101C X10/15	\$2424	\$2435	\$2485	\$2523	\$2623	\$2677	\$2721	\$2820	\$2864	\$3077	\$2542	\$3618	\$3813
---------------------	--------	--------	--------	--------	--------	--------	--------	--------	--------	--------	--------	--------	--------

With Glides

1101G X10/15	\$2424	\$2435	\$2485	\$2523	\$2623	\$2677	\$2721	\$2820	\$2864	\$3077	\$2542	\$3618	\$3813
---------------------	--------	--------	--------	--------	--------	--------	--------	--------	--------	--------	--------	--------	--------

COM/yds = 3¼, COL/sq ft = 59

Small Lounge Chair with Narrow Back and Left Arm

With Casters

1101CAX X10/15	\$2954	\$2990	\$3054	\$3100	\$3221	\$3290	\$3344	\$3465	\$3520	\$3785	\$3117	\$4723	\$5022
-----------------------	--------	--------	--------	--------	--------	--------	--------	--------	--------	--------	--------	--------	--------

With Glides

1101GAX X10/15	\$2954	\$2990	\$3054	\$3100	\$3221	\$3290	\$3344	\$3465	\$3520	\$3785	\$3117	\$4723	\$5022
-----------------------	--------	--------	--------	--------	--------	--------	--------	--------	--------	--------	--------	--------	--------

COM/yds = 4, COL/sq ft = 80

▶ Specification Information, continued on next page
X10/15 = Last order entry
October 18, 2015

Detour Lounge Chairs

DESIGN METRO DESIGN GROUP | STEELCASE AND IDEO

► Specification Information, continued from previous page

Specification Information

Style Number	U.S. Base Prices												Leather Grades:		
	Fabric Grades:												COL	C	E
	COM	6	7	8	9	10	11	12	13	14					



Small Lounge Chair with Narrow Back and Right Arm

With Casters

1101CXA	✕10/15	\$2954	\$2990	\$3054	\$3100	\$3221	\$3290	\$3344	\$3465	\$3520	\$3785	\$3117	\$4723	\$5022
---------	--------	--------	--------	--------	--------	--------	--------	--------	--------	--------	--------	--------	--------	--------

With Glides

1101GXA	✕10/15	\$2954	\$2990	\$3054	\$3100	\$3221	\$3290	\$3344	\$3465	\$3520	\$3785	\$3117	\$4723	\$5022
---------	--------	--------	--------	--------	--------	--------	--------	--------	--------	--------	--------	--------	--------	--------

COM/yds = 4, COL/sq ft = 80

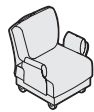

Small Lounge with Narrow Back and Two Arms

With Casters

1101CAA	✕10/15	\$3471	\$3531	\$3602	\$3655	\$3791	\$3866	\$3928	\$4065	\$4127	\$4423	\$3683	\$5240	\$5539
---------	--------	--------	--------	--------	--------	--------	--------	--------	--------	--------	--------	--------	--------	--------

With Glides

1101GAA	✕10/15	\$3471	\$3531	\$3602	\$3655	\$3791	\$3866	\$3928	\$4065	\$4127	\$4423	\$3683	\$5240	\$5539
---------	--------	--------	--------	--------	--------	--------	--------	--------	--------	--------	--------	--------	--------	--------

COM/yds = 4½, COL/sq ft = 90



Small Lounge Chair with Wide Back and No Arms

With Casters

1102C	✕10/15	\$2510	\$2534	\$2593	\$2639	\$2752	\$2814	\$2864	\$2979	\$3030	\$3278	\$2653	\$3996	\$4245
-------	--------	--------	--------	--------	--------	--------	--------	--------	--------	--------	--------	--------	--------	--------

With Glides

1102G	✕10/15	\$2510	\$2534	\$2593	\$2639	\$2752	\$2814	\$2864	\$2979	\$3030	\$3278	\$2653	\$3996	\$4245
-------	--------	--------	--------	--------	--------	--------	--------	--------	--------	--------	--------	--------	--------	--------

COM/yds = 3¾, COL/sq ft = 75



Small Lounge Chair with Wide Back and Left Arm

With Casters

1102CAX	✕10/15	\$3030	\$3079	\$3144	\$3197	\$3325	\$3395	\$3453	\$3583	\$3642	\$3921	\$3223	\$4705	\$4987
---------	--------	--------	--------	--------	--------	--------	--------	--------	--------	--------	--------	--------	--------	--------

With Glides

1102GAX	✕10/15	\$3030	\$3079	\$3144	\$3197	\$3325	\$3395	\$3453	\$3583	\$3642	\$3921	\$3223	\$4705	\$4987
---------	--------	--------	--------	--------	--------	--------	--------	--------	--------	--------	--------	--------	--------	--------

COM/yds = 4¼, COL/sq ft = 85



Small Lounge Chair with Wide Back and Right Arm

With Casters

1102CXA	✕10/15	\$3030	\$3079	\$3144	\$3197	\$3325	\$3395	\$3453	\$3583	\$3642	\$3921	\$3223	\$4705	\$4987
---------	--------	--------	--------	--------	--------	--------	--------	--------	--------	--------	--------	--------	--------	--------

With Glides

1102GXA	✕10/15	\$3030	\$3079	\$3144	\$3197	\$3325	\$3395	\$3453	\$3583	\$3642	\$3921	\$3223	\$4705	\$4987
---------	--------	--------	--------	--------	--------	--------	--------	--------	--------	--------	--------	--------	--------	--------

COM/yds = 4¼, COL/sq ft = 85



Small Lounge Chair with Wide Back and Two Arms

With Casters

1102CAA	✕10/15	\$3552	\$3635	\$3715	\$3774	\$3925	\$4009	\$4075	\$4227	\$4297	\$4626	\$3796	\$5509	\$5843
---------	--------	--------	--------	--------	--------	--------	--------	--------	--------	--------	--------	--------	--------	--------

With Glides

1102GAA	✕10/15	\$3552	\$3635	\$3715	\$3774	\$3925	\$4009	\$4075	\$4227	\$4297	\$4626	\$3796	\$5509	\$5843
---------	--------	--------	--------	--------	--------	--------	--------	--------	--------	--------	--------	--------	--------	--------

COM/yds = 5, COL/sq ft = 100



For Canadian Pricing
Multiply U.S. Price by the Canadian price factor.

► See page 1 for details.

► Specification Information, continued on next page

✕10/15 = Last order entry
October 18, 2015

Detour Lounge Chairs *continued*

DESIGN METRO DESIGN GROUP | STEELCASE AND IDEO

Tip: Handedness is determined while facing the chair.

Tip: Fabrics and leathers will appear loose with comfort wrinkles when upholstered.



► Specification Information, continued from previous page

Specification Information

Style Number	U.S. Base Prices											Leather Grades:		
	Fabric Grades:											COL	C	E
	COM	6	7	8	9	10	11	12	13	14				

Large Lounge Chair with No Arms

With Casters

1103C 10/15	\$2740	\$2800	\$2871	\$2924	\$3060	\$3135	\$3197	\$3334	\$3396	\$3692	\$2932	\$4509	\$4808
--------------------	--------	--------	--------	--------	--------	--------	--------	--------	--------	--------	--------	--------	--------

With Glides

1103G 10/15	\$2740	\$2800	\$2871	\$2924	\$3060	\$3135	\$3197	\$3334	\$3396	\$3692	\$2932	\$4509	\$4808
--------------------	--------	--------	--------	--------	--------	--------	--------	--------	--------	--------	--------	--------	--------

COM/yds = 4½, COL/sq ft = 90

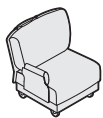

Large Lounge Chair with Left Arm

With Casters

1103CAX 10/15	\$3278	\$3338	\$3409	\$3462	\$3598	\$3673	\$3735	\$3872	\$3934	\$4230	\$3524	\$5047	\$5346
----------------------	--------	--------	--------	--------	--------	--------	--------	--------	--------	--------	--------	--------	--------

With Glides

1103GAX 10/15	\$3278	\$3338	\$3409	\$3462	\$3598	\$3673	\$3735	\$3872	\$3934	\$4230	\$3524	\$5047	\$5346
----------------------	--------	--------	--------	--------	--------	--------	--------	--------	--------	--------	--------	--------	--------

COM/yds = 4½, COL/sq ft = 90



Large Lounge Chair with Right Arm

With Casters

1103CXA 10/15	\$3278	\$3338	\$3409	\$3462	\$3598	\$3673	\$3735	\$3872	\$3934	\$4230	\$3524	\$5047	\$5346
----------------------	--------	--------	--------	--------	--------	--------	--------	--------	--------	--------	--------	--------	--------

With Glides

1103GXA 10/15	\$3278	\$3338	\$3409	\$3462	\$3598	\$3673	\$3735	\$3872	\$3934	\$4230	\$3524	\$5047	\$5346
----------------------	--------	--------	--------	--------	--------	--------	--------	--------	--------	--------	--------	--------	--------

COM/yds = 4½, COL/sq ft = 90

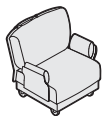

Large Lounge Chair with Two Arms

With Casters

1103CAA 10/15	\$3815	\$3909	\$3992	\$4055	\$4215	\$4303	\$4373	\$4533	\$4605	\$4950	\$4110	\$5866	\$6216
----------------------	--------	--------	--------	--------	--------	--------	--------	--------	--------	--------	--------	--------	--------

With Glides

1103GAA 10/15	\$3815	\$3909	\$3992	\$4055	\$4215	\$4303	\$4373	\$4533	\$4605	\$4950	\$4110	\$5866	\$6216
----------------------	--------	--------	--------	--------	--------	--------	--------	--------	--------	--------	--------	--------	--------

COM/yds = 5¼, COL/sq ft = 105

► Specification Information, continued on next page



For Canadian Pricing
 Multiply U.S. Price by the
 Canadian price factor.
 ► See page 1 for details.

10/15 = Last order entry
 October 18, 2015

Detour Lounge Chairs

DESIGN METRO DESIGN GROUP | STEELCASE AND IDEO

► Specification Information, continued from previous page

Specification Information

Dimensions			Style Number	U.S. Base Prices			
D	W	H		Lam 1	Lam 2	Wood 1	Wood 2

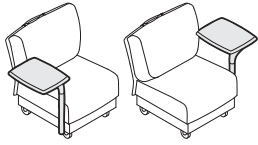

Tablet Arm

Left

16"	12"	24½"	1100TAL 10/15	\$621	\$652	\$691	N.A.
-----	-----	------	--------------------------	-------	-------	-------	------

Right

16"	12"	24½"	1100TAR 10/15	\$621	\$652	\$691	N.A.
-----	-----	------	--------------------------	-------	-------	-------	------



For Canadian Pricing
 Multiply U.S. Price by the
 Canadian price factor.
 ► See page 1 for details.

~~10/15~~ = Last order entry
 October 18, 2015



Tip: Ottoman with CAL TB133 option requires testing at the customer's expense.

Tip: The COM yards and COL square footage listed on this page reflect the requirements for a single fabric that are based on non-directional 54"W material applied railroaded.

Tip: For Customer's Own Material or Leather, see necessary requirements, important processing instructions, and ordering information
 ▶ See Coalesse Surface Materials Reference Guide.

Standard Includes		Required to Specify
▶ Need help? product details, page 132	<ul style="list-style-type: none"> • Seat: fabric or leather • Legs: paint • Lower storage shelf: paint • Adjustable glides, if selected: paint to match legs • Casters: paint to match legs 	1 Style number 2 Fabric or leather color number for seat 3 Paint color number for legs, lower storage shelf, glides or casters, if selected 4 Options, if selected (see below) ▶ See Coalesse Surface Materials Reference Guide.

Options	U.S. Price	Required to Specify
Surface Materials • Acrylic backer • Backer	+\$10	Specify with acrylic backer. ▶ See Coalesse Surface Materials Reference Guide.
Related Products • Lounge chairs		▶ Page 136

Specification Information												
Style Number	U.S. Base Prices											Leather Grades:
	COM	6	7	8	9	10	11	12	13	14	COL	C

Ottoman

With Casters

1104C X10/15	\$910	\$914	\$934	\$949	\$985	\$1008	\$1025	\$1063	\$1079	\$1162	\$981	\$1512	\$1588
---------------------	-------	-------	-------	-------	-------	--------	--------	--------	--------	--------	-------	--------	--------

With Glides

1104G X10/15	\$910	\$914	\$934	\$949	\$985	\$1008	\$1025	\$1063	\$1079	\$1162	\$981	\$1512	\$1588
---------------------	-------	-------	-------	-------	-------	--------	--------	--------	--------	--------	-------	--------	--------

COM/yds = 1¼, COL/sq ft = 23



For Canadian Pricing
 Multiply U.S. Price by the Canadian price factor.
 ▶ See page 1 for details.

X10/15 = Last order entry
 October 18, 2015

Detour Multi-Fabric Diagram and Yardage Request Form

DESIGN METRO DESIGN GROUP | STEELCASE AND IDEO

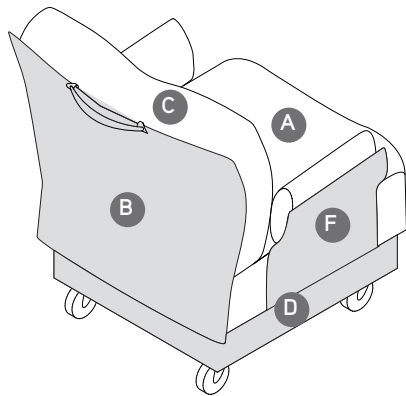
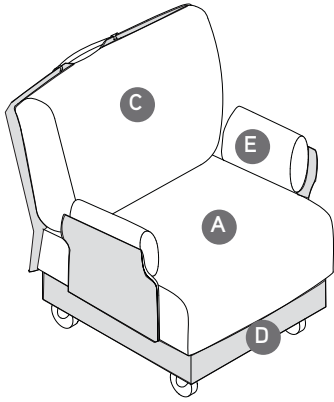

TO: _____

FROM: _____

DATE: _____

FAX...888.413.5161

Lounge Seating

A Seat (upholstery selections default for entire unit if B is not selected): _____

B Back: _____

C Back Cushion: _____

D Base Frame: _____

E Inner Arm: _____

F Outside Arm: _____

\$118 U.S. list per contrasting fabric specified. List price based on highest fabric grade usage.



For Canadian Pricing
Multiply U.S. Price by the
Canadian price factor.
▶ See page 1 for details.

Detour Multi-Fabric Yardage

DESIGN METRO DESIGN GROUP | STEELCASE AND IDEO

Multi-Fabric Yardage

Chair Model	Style Number	COM Yds*					
		Seat Cushion	Back Cushion	Outside Back Panel	Base Frame	Inside Arm(s)	Outside Arm(s)
Small lounge with casters, narrow back, no arms	1101C	1½	1	2	2½	N.A.	N.A.
Small lounge with glides, narrow back, no arms	1101G	1½	1	2	2½	N.A.	N.A.
Small lounge with casters, narrow back, arm left	1101CAX	1½	1	2	2½	½	½
Small lounge with glides, narrow back, arm left	1101GAX	1½	1	2	2½	½	½
Small lounge with casters, narrow back, arm right	1101CXAX	1½	1	2	2½	½	½
Small lounge with glides, narrow back, arm right	1101GXAX	1½	1	2	2½	½	½
Small lounge with casters, narrow back, two arms	1101CAA	1½	1	2	2½	1	1
Small lounge with glides, narrow back, two arms	1101GAA	1½	1	2	2½	1	1
Small lounge with casters, wide back, no arms	1102C	1½	1	2	2½	N.A.	N.A.
Small lounge with glides, wide back, no arms	1102G	1½	1	2	2½	N.A.	N.A.
Small lounge with casters, wide back, arm left	1102CAX	1½	1	2	2½	½	½
Small lounge with glides, wide back, arm left	1102GAX	1½	1	2	2½	½	½
Small lounge with casters, wide back, arm right	1102CXAX	1½	1	2	2½	½	½
Small lounge with glides, wide back, arm right	1102GXAX	1½	1	2	2½	½	½
Small lounge with casters, wide back, two arms	1102CAA	1½	1	2	2½	1	1
Small lounge with glides, wide back, two arms	1102GAA	1½	1	2	2½	1	1
Large lounge with casters	1103C	2	1¼	2	3	N.A.	N.A.
Large lounge with glides	1103G	2	1¼	2	3	N.A.	N.A.
Large lounge with casters, arm left	1103CAX	2	1¼	2	3	½	½
Large lounge with glides, arm left	1103GAX	2	1¼	2	3	½	½
Large lounge with casters, arm right	1103CXAX	2	1¼	2	3	½	½
Large lounge with glides, arm right	1103GXAX	2	1¼	2	3	½	½
Large lounge with casters, two arms	1103CAA	2	1¼	2	3	1	1
Large lounge with glides, two arms	1103GAA	2	1¼	2	3	1	1

*Fabric yardage is based on non-directional/solid fabrics. Use conversion chart on following page for repeat/printed fabric yardage.

Detour Multi-Fabric Yardage

DESIGN METRO DESIGN GROUP | STEELCASE AND IDEO

Non-standard fabric requirements

Yardage requirements shown are based on non-directional 54" w material applied railroaded. Coalesse will apply fabric railroaded unless instructed otherwise on the dealer's purchase order. The following conversion chart should be used to determine yardage requirements when COM has a repeat of 2" or more. Please contact Coalesse customer service for a yardage quotation if the fabric is less than 54" wide, has a repeat of more than 24", or if the fabric must be cut-right.

CONVERSION CHART

PRODUCT	REPEAT		
	2" - 8"	9" - 14"	15" - 24"
All other products	15%	25%	35%

Yardage quotations will also be provided for order of 10 or more pieces.

Cutting direction guidelines

Cutting direction is based on the fabric width and the way the fabric is cut from the roll and applied to Coalesse products. There are two cutting directions: railroaded or cut-right.

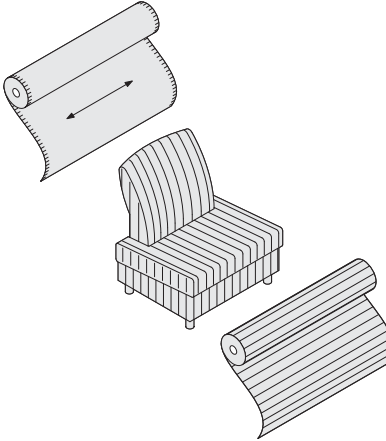

Horizontal or railroaded (across roll, warp horizontal) means fabric is cut across the roll; selvages are on the top and bottom.

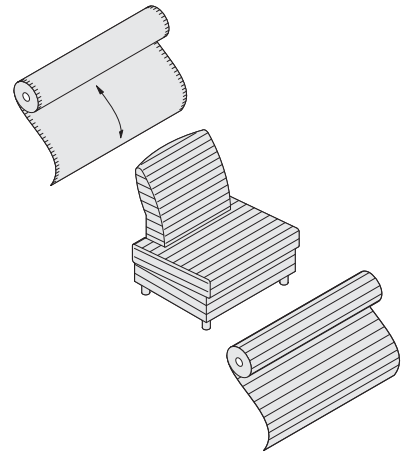

Vertical or cut-right (down roll, warp vertical) means fabric is cut in the same direction it is woven; selvages are on the left and right sides.

Coalesse reserves the right to railroad or apply fabric according to weave unless instructions specify otherwise. Fabrics are railroaded when possible to avoid seams in large upholstered areas and/or single cushion units. If a fabric is questionable, a cutting of adequate size showing full repeat (if any) should be sent to Coalesse for a fabric requirement quotation.

Evaneau

DESIGN LAUREN ROTTET DESIGN ORIGIN: UNITED STATES

Tip: Fabrics and leathers will appear loose with comfort wrinkles when upholstered.

Tip: Recommended leathers are Elmosoft Grade C and Elmorustical Grade E.

Tip: Special color match, consult customer service.

Tip: List price based on highest fabric grade.

Tip: All pillows and arm bolsters must be specified separately.

Tip: Seat and back cushions are standard as unattached. Attachment straps available as an option.

Tip: For Customer's Own Material or Leather, see necessary requirements, important processing instructions, and ordering information
 ▶ See *Coalesse Surface Materials Reference Guide*.

Standard Includes	Required to Specify
<ul style="list-style-type: none"> • Frame: selected hardwood • Legs: black powder coat • Upholstery: <ul style="list-style-type: none"> - Multiple densities of polyurethane foam and polyester fiber • Pillows, if selected: fabric or leather 	1 Style number 2 Number of fabrics if contrasting fabric style number is selected 3 Fabric or leather color number for upholstery on seat and back or pillows, if selected 4 Options, if selected (see below) ▶ See <i>Coalesse Surface Materials Reference Guide</i> .

Options	U.S. Price	Required to Specify
Surface Materials <ul style="list-style-type: none"> • Contrasting fabric 	+\$118 per fabric	Add suffix K to the style number and select fabric color number.
Acrylic backer <ul style="list-style-type: none"> • Chair • Two-seat sofa • Three-seat sofa • Low round ottomans • High ottomans • Back and arm pillows 	+\$ 52 +\$ 76 +\$109 +\$ 22 +\$ 33 +\$ 8	Specify with <i>acrylic backer</i> . Specify with <i>acrylic backer</i> . Specify with <i>acrylic backer</i> . Specify with <i>acrylic backer</i> . Specify with <i>acrylic backer</i> . Specify with <i>acrylic backer</i> . ▶ See <i>Coalesse Surface Materials Reference Guide</i> .
Legs <ul style="list-style-type: none"> • Plated: brushed carbon steel • Plated: brushed carbon steel (on 14-10R, 14-10L, or 14-30) 	+\$458 +\$685	Specify with <i>plated legs</i> . Specify with <i>plated legs</i> .
Attachment Straps <ul style="list-style-type: none"> • Attachment straps • Pillow attachment straps 	+\$123 per cushion +\$ 63	Specify with <i>attachment straps</i> . Specify with <i>pillow attachment straps</i> .
Casters <ul style="list-style-type: none"> • Dual wheel casters for ottoman 	+\$119	Specify with <i>dual wheel casters</i> .

Specification Information													
Style Number	U.S. Base Prices											Leather Grades:	
	Fabric Grades:											COL	C
COM	6	7	8	9	10	11	12	13	14				

Chair													
14-C	\$3393	\$3432	\$3468	\$3529	\$3716	\$3836	\$3976	\$4074	\$4247	\$4487	\$3571	\$5689	\$6306
COM/yds = 5½, COL/sq ft = 121													

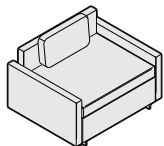

Overall: 34"D 42"W 29¾"H
 Inside: 22½"D 37"W 12½"H
 Seat: 17½"H
 Arm: 21"H

Two-Seat Sofa													
14-20	\$4778	\$4919	\$4975	\$5070	\$5359	\$5545	\$5761	\$5912	\$6179	\$6550	\$4950	\$8262	\$9094
COM/yds = 8½, COL/sq ft = 187													

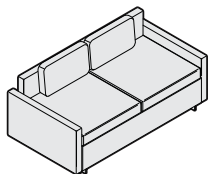

Overall: 34"D 66"W 29¾"H
 Inside: 22½"D 61"W 12½"H
 Seat: 17½"H
 Arm: 21"H

▶ Specification Information, continued on next page

 **For Canadian Pricing**
 Multiply U.S. Price by the Canadian price factor.
 ▶ See page 1 for details.

Evaneau

DESIGN LAUREN ROTTET DESIGN ORIGIN: UNITED STATES

► Specification Information, continued from previous page

Specification Information

Style Number	U.S. Base Prices										Leather Grades:		
	Fabric Grades:										COL	C	E
	COM	6	7	8	9	10	11	12	13	14			

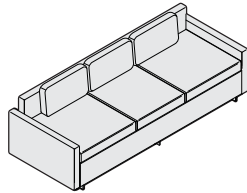

Overall: 34"D 90"W 29¾"H
 Inside: 22½"D 85"W 12½"H
 Seat: 17½"H
 Arm: 21"H

Three-Seat Sofa

14-30	\$5909	\$6136	\$6208	\$6331	\$6705	\$6946	\$7226	\$7420	\$7766	\$8247	\$6077	\$10,394	\$11,395
-------	--------	--------	--------	--------	--------	--------	--------	--------	--------	--------	--------	----------	----------

COM/yds = 11, COL/sq ft = 242



Overall: 30"D 13½"H

Ottoman, Low Round

14-HLR	\$1492	\$1492	\$1508	\$1536	\$1621	\$1676	\$1739	\$1784	\$1862	\$1971	\$1728	\$ 2675	\$ 3054
--------	--------	--------	--------	--------	--------	--------	--------	--------	--------	--------	--------	---------	---------

COM/yds = 2½, COL/sq ft = 55



Overall: 30"D 17½"H

Ottoman, High Round

14-HHR	\$1798	\$1798	\$1818	\$1851	\$1953	\$2019	\$2095	\$2148	\$2242	\$2373	\$2018	\$ 3157	\$ 3576
--------	--------	--------	--------	--------	--------	--------	--------	--------	--------	--------	--------	---------	---------

COM/yds = 3, COL/sq ft = 66



Overall: 12"D 3½" thick

12" Round Back Pillow

14-6	\$ 455	\$ 449	\$ 456	\$ 467	\$ 501	\$ 523	\$ 548	\$ 566	\$ 597	\$ 641	\$ 706	\$ 811	\$ 1085
------	--------	--------	--------	--------	--------	--------	--------	--------	--------	--------	--------	--------	---------

COM/yds = 1, COL/sq ft = 20



Overall: 16"D 3½" thick

16" Round Back Pillow

14-7	\$ 481	\$ 475	\$ 482	\$ 493	\$ 527	\$ 549	\$ 574	\$ 592	\$ 623	\$ 667	\$ 738	\$ 1047	\$ 1315
------	--------	--------	--------	--------	--------	--------	--------	--------	--------	--------	--------	---------	---------

COM/yds = 1, COL/sq ft = 20



Overall: 22"D 11"W 2"H

Arm Pillow

14-A	\$ 291	\$ 277	\$ 282	\$ 290	\$ 315	\$ 332	\$ 351	\$ 364	\$ 388	\$ 421	\$ 574	\$ 771	\$ 1020
------	--------	--------	--------	--------	--------	--------	--------	--------	--------	--------	--------	--------	---------

COM/yds = ¾, COL/sq ft = 15



Overall: 23"D 6"W 6"H

Arm Bolster

14-B	\$ 291	\$ 277	\$ 282	\$ 290	\$ 315	\$ 332	\$ 351	\$ 364	\$ 388	\$ 421	\$ 574	\$ 771	\$ 1020
------	--------	--------	--------	--------	--------	--------	--------	--------	--------	--------	--------	--------	---------

COM/yds = ¾, COL/sq ft = 15



For Canadian Pricing
 Multiply U.S. Price by the
 Canadian price factor.
 ► See page 1 for details.

Evaneau Multi-Fabric Diagram

TO: _____

FROM: _____

DATE: _____

MODEL: _____

FAX....888.413.5161

A Upholstery selections (default for entire unit if B is not selected): _____

B Back _____

C Back Cushion _____

D Base Frame _____

E Arms _____

Total List Price
 Upcharge For Contrasting Fabrics = \$118 U.S. list per
 contrasting fabric specified. List price based on highest
 grade textile specified.

Tip: All pillows and arm bolsters must be specified separately.

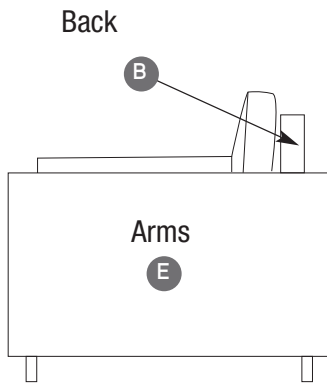

14-CK Chair

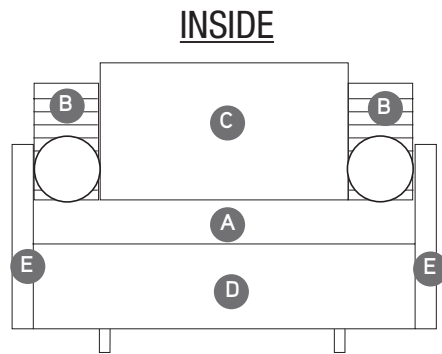

14-20K Two Seat Sofa

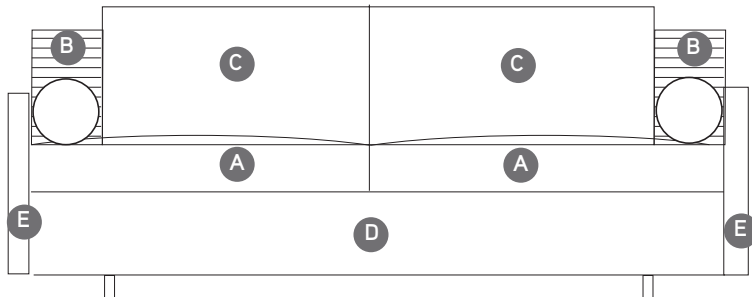

14-30 Three Seat Sofa

Holy Day Lounge Chair by Viccarbe

DESIGN JEAN-MARIE MASSAUD DESIGN ORIGIN: 2003 SPAIN

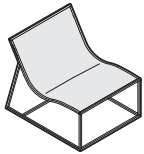

Overall: 30"D 27"W 26½"H
 Inside: 30½"D 27½"W 26½"H
 Seat: 15"H

Tip: Double needle stitch in matching color is standard for fabrics.

Tip: Saddle stitch in nine colors for leather.

Tip: For Customer's Own Material or Leather, see necessary requirements, important processing instructions, and ordering information
 ▶ See *Coalesse Surface Materials Reference Guide*.

Standard Includes	Required to Specify
-------------------	---------------------

<ul style="list-style-type: none"> Upholstery for chair: fabric or leather Glides Frame: polished trivalent chrome 	1 Style number 2 Fabric or leather color number for upholstery 3 Options, if selected (see below) ▶ See <i>Coalesse Surface Materials Reference Guide</i> .
---	--

Options	U.S. Price	Required to Specify
---------	------------	---------------------

Surface Materials <ul style="list-style-type: none"> Leather 	Prices below	Add suffix L to style number and specify leather color number.
Acrylic backer <ul style="list-style-type: none"> Backer for upholstered chair only 	+\$17	Specify with acrylic backer. ▶ See <i>Coalesse Surface Materials Reference Guide</i> .
Contrasting Saddle Stitching <ul style="list-style-type: none"> Available on leather only 	No cost	Specify with contrasting saddle stitching and select thread color.

Specification Information

Style Number	U.S. Base Prices											Leather Grades:		
	Fabric Grades: COM 6 7 8 9 10 11 12 13 14											COL	C	E
COHD	\$2996	\$2996	\$3009	\$3031	\$3099	\$3143	\$3194	\$3229	\$3292	\$3379	N.A.	N.A.	N.A.	
COHDL	N.A.	N.A.	N.A.	N.A.	N.A.	N.A.	N.A.	N.A.	N.A.	N.A.	\$3197	\$3986	\$4132	

COM/yds = 2, COL/sq ft = 44

Lounge Seating



For Canadian Pricing
 Multiply U.S. Price by the Canadian price factor.
 ▶ See page 1 for details.

Hosu

DESIGN PATRICIA URQUIOLA DESIGN ORIGIN: SPAIN

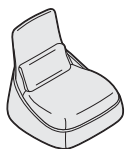

Tip: Fabrics and leathers will appear loose with comfort wrinkles when upholstered.

Tip: Recommended leathers are Elmosoft Grade C and Elmorustical Grade E.

Tip: If fabric is selected on models with ottoman, foot rest is available with Fusion fabric or leather.

Tip: Frame design allows back to flex to support occupants back shape.

Tip: Due to the design and construction techniques of the Hosu lounge and sofa only certain textiles can be successfully applied, therefore all COM fabrics must be submitted to Coalesse for approval prior to order acceptance.

Tip: Hexa fabrics (fabric group 10) were specifically designed by Patricia Urquiola for Hosu lounge and sofa seating.
 ▶ See *Coalesse Surface Materials Reference Guide* for complete listing of Hexa fabrics.

Standard Includes	Required to Specify
<ul style="list-style-type: none"> • Frame: plywood tab construction • Multiple densities of polyurethane foam and polyester fiber • Seat and back: fabric or leather • Wrap: made from ABS plastic • Footrest on fabric chair, if selected: Fusion fabric only • Footrest on leather chair, if selected: leather to match seat and back • Glides: non-adjustable • Pull tab on ottoman, if selected: Nylon strap • Grommet for wire pass-through on models COURQLO and COURQLOK, if selected • Pillow: fabric or leather 	<ol style="list-style-type: none"> 1 Style number 2 Number of fabrics if contrasting fabric style number is selected 3 Fabric or leather color number for upholstery on seat, back, and pillow 4 Fusion color number for footrest, if selected: CL60 Caviar CL61 Portobello CL62 Graphite CL63 Java 5 Fusion color number for pull tab, if selected: CL40 Red CL41 Blue CL42 Black 6 Options, if selected (see below) ▶ See <i>Coalesse Surface Materials Reference Guide</i> .

Options	U.S. Price	Required to Specify
Surface Materials Pillow for lounge chair and lounge chair with ottoman <ul style="list-style-type: none"> • Fabric groups 6-10 No cost • Fabric group 11 +\$145 • Fabric group 12 +\$164 • Fabric group 13 +\$198 • Fabric group 14 +\$246 • Fabric group C +\$346 • Fabric group E +\$417 • Customer's Own Material (COM) +\$ 40 • Customer's Own Leather (COL) +\$274 		Specify fabric color number. Specify fabric color number. Specify fabric color number. Specify fabric color number. Specify fabric color number. Specify fabric color number. Specify fabric color number. ▶ See <i>Coalesse Surface Materials Reference Guide</i> . ▶ See <i>Coalesse Surface Materials Reference Guide</i> .
Pillows for two-seat sofa <ul style="list-style-type: none"> • Fabric groups 6-10 No cost • Fabric group 11 +\$254 • Fabric group 12 +\$287 • Fabric group 13 +\$347 • Fabric group 14 +\$430 • Fabric group C +\$613 • Fabric group E +\$740 • Customer's Own Material (COM) +\$ 40 • Customer's Own Leather (COL) +\$274 		Specify fabric color number. Specify fabric color number. Specify fabric color number. Specify fabric color number. Specify fabric color number. Specify fabric color number. Specify fabric color number. ▶ See <i>Coalesse Surface Materials Reference Guide</i> . ▶ See <i>Coalesse Surface Materials Reference Guide</i> .
<ul style="list-style-type: none"> • Contrasting fabric +\$118 per fabric 		Add suffix K to the style number and select fabric color number.
Acrylic backer <ul style="list-style-type: none"> • Lounge chair +\$ 41 • Lounge chair with ottoman +\$ 54 • Two-seat sofa +\$ 72 		Specify with acrylic backer. Specify with acrylic backer. Specify with acrylic backer. ▶ See <i>Coalesse Surface Materials Reference Guide</i> .

 **For Canadian Pricing**
 Multiply U.S. Price by the Canadian price factor.
 ▶ See page 1 for details.

Hosu

DESIGN PATRICIA URQUIOLA DESIGN ORIGIN: SPAIN

Specification Information

Style Number	U.S. Base Prices												
	Fabric Grades:												
	COM	6	7	8	9	10	11	12	13	14	COL	C	E

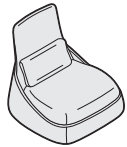

Overall: 35³/₈"D 34³/₈"W 35"H
 Inside: 24"D 31"W 14"H
 Pillow: 3"D 20⁹/₁₆"W 10¹/₈"H

Lounge with Lumbar Pillow

COURQL	\$2282	\$2312	\$2346	\$2405	\$2583	\$2698	\$2832	\$2925	\$3090	\$3319	\$2406	\$3722	\$3890
--------	--------	--------	--------	--------	--------	--------	--------	--------	--------	--------	--------	--------	--------

Lounge: COM/yds = 4¹/₄, COL/sq ft = 94
 Pillow: COM/yds = 1, COL/sq ft = 22



Overall: 35³/₈"D 34³/₈"W 35"H
 Overall extended: 57"L
 Inside: 24"D 31"W 14"H
 Inside extended: 48"L
 Pillow: 3"D 20⁹/₁₆"W 10¹/₈"H
 Ottoman: 24"D 31"W 8¹/₂"H

Lounge With Ottoman and Lumbar Pillow

COURQLO	\$2709	\$2790	\$2835	\$2910	\$3139	\$3287	\$3459	\$3578	\$3791	\$4085	\$2833	\$4690	\$4915
---------	--------	--------	--------	--------	--------	--------	--------	--------	--------	--------	--------	--------	--------

Lounge: COM/yds = 5³/₄, COL/sq ft = 126
 Pillow: COM/yds = 1, COL/sq ft = 22

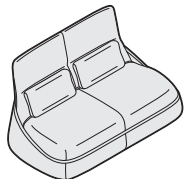

Overall: 35³/₈"D 64¹/₈"W 35"H
 Inside: 24"D 57¹/₈"W 14"H
 Pillows: 3"D 24"W 10¹/₈"H

Two-Seat Sofa with Two Lumbar Pillows

COURQS	\$3561	\$3702	\$3758	\$3853	\$4142	\$4328	\$4544	\$4695	\$4962	\$5333	\$3685	\$5830	\$6085
--------	--------	--------	--------	--------	--------	--------	--------	--------	--------	--------	--------	--------	--------

Sofa: COM/yds = 6³/₄, COL/sq ft = 143
 Pillows: COM/yds = 1³/₄, COL/sq ft = 39

Lounge Seating



For Canadian Pricing
 Multiply U.S. Price by the
 Canadian price factor.
 ▶ See page 1 for details.

Hosu Lounge Chair with Ottoman

DESIGN PATRICIA URQUIOLA DESIGN ORIGIN: SPAIN

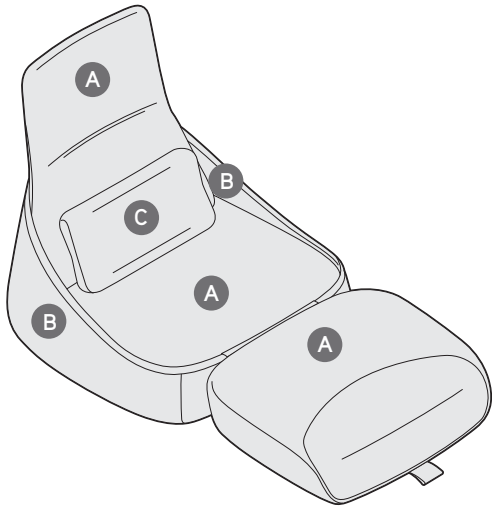

TO: _____

FROM: _____

DATE: _____

FAX....888.413.5161

A Seat & back: _____

B Wrap: _____

C Pillow: _____

\$118 U.S. list upcharge for each contrasting textile pricing based on highest grade textile specified.

Specify Model below:

COURQLK Lounge Chair

COURQLOK Lounge Chair with Ottoman

COURQSK Two-Seat Sofa

Footrest is standard in Fusion caviar if fabric is specified on the chair. If leather is specified on the chair, leather on footrest will match.

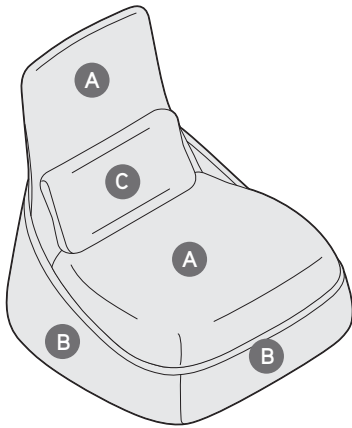

Coalesse

Joel Lounge by Walter Knoll

DESIGN EOOS DESIGN ORIGIN: 2004 GERMANY

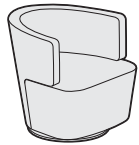

Overall: 29"D 30 1/4"W 27 1/2"H
 Seat: 16 1/4"H
 Arm: 26 1/4"H
 Inside: 21 1/2"D x 16 1/2" - 23"W x 11"H

Tip: Fabrics and leathers will appear loose with comfort wrinkles when upholstered.

Tip: For Customer's Own Material or Leather, see necessary requirements, important processing instructions, and ordering information
 ▶ See *Coalesse Surface Materials Reference Guide*.

Standard Includes	Required to Specify
<ul style="list-style-type: none"> • Base frame: steel with molded rigid foam • Seat frame: plywood with molded foam • Base: chrome plated steel • Auto swivel return mechanism 	1 Style number 2 Number of fabrics if contrasting fabric style number is selected 3 Fabric or leather color number for upholstery 4 Options, if selected (see below) ▶ See <i>Coalesse Surface Materials Reference Guide</i> .

Options	U.S. Price	Required to Specify
Surface Materials <ul style="list-style-type: none"> • Contrasting Fabric 	+\$118 per fabric	Add suffix K to the style number and select fabric color number.
<ul style="list-style-type: none"> • Fire code seating 	+\$231	Specify with fire code seating. ▶ See <i>Coalesse Surface Materials Reference Guide</i> .
<ul style="list-style-type: none"> • Acrylic backer • Backer 	+\$ 33	Specify with acrylic backer. ▶ See <i>Coalesse Surface Materials Reference Guide</i> .

Specification Information

Style Number	U.S. Base Prices													
	Fabric Grades:											Leather Grades:		
	COM	6	7	8	9	10	11	12	13	14	COL	C	E	
COWK100	\$1989	\$1989	\$2012	\$2051	\$2170	\$2247	\$2336	\$2398	\$2508	\$2660	\$2143	\$3626	\$3799	

COM/yds = 3 1/2, COL/sq ft = 77

Lounge Seating



For Canadian Pricing
 Multiply U.S. Price by the Canadian price factor.
 ▶ See page 1 for details.

Coalesse

Joel Lounge Multi-Fabric Diagram

DESIGN EOOS DESIGN ORIGIN: 2004 GERMANY

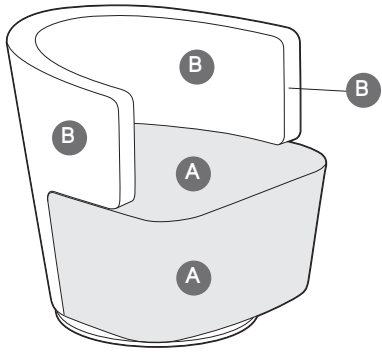

TO: _____

FROM: _____

DATE: _____

FAX...888.413.5161

A Seat (upholstery selections default for entire unit if B is not selected): _____

B Back: _____

\$118 U.S. list upcharge for each contrasting textile pricing based on highest grade textile specified.



For Canadian Pricing
Multiply U.S. Price by the
Canadian price factor.
▶ See page 1 for details.

Coalesse

Joel Lounge Multi-Fabric Diagram

DESIGN EOOS DESIGN ORIGIN: 2004 GERMANY

Lagunitas

DESIGN TOAN NGUYEN

Lagunitas offers a wide range of highly customizable settings, bringing a new level of versatility to all the ways we work. Lagunitas adapts to changing work styles and shifting postures. Lagunitas utilizes a full range of design expressions with benches, lounge pieces, and tables. Fabric and knit, combined with high and low panels, allow for a full range of aesthetic and functional possibilities. Benches complement the range of lounge pieces. Work, occasional, and personal tables are curated to work specifically with Lagunitas lounges and benches. Integrated power options for the lounges, benches, and tables are available. Lagunitas supports existing and emerging work activities in an endless number of social, collaborative, and personal settings.

All corners are standard with a stationary corner cushion for all two- and three-seat lounges and chaises. Arm cushions are optional on units with left- and right-hand screens to allow for articulating backs on all back cushions.

Welt cord is standard on fabric screens and will match the outside screen fabric selection if contrasting is selected.

Seat deck is available in knit or fabric and must be same material as the screen.

Lounges and chaises are standard with two glides per screen section or seat deck. Each glide can adjust 1/2" for uneven floors.

Lounges and benches are offered in one-, two-, and three-seat models. The chaise is offered in two- and three-seat models. The corresponding table offering works with the seating dimensions for complete systematic compatibility.

Screens are available in two heights for lounges and chaises. Low-back screens are 26 3/4"H and high-back screens are 50"H. Overall height of low-back units is 32 3/8".

Screens are available in knit or fabric.

Articulating back is standard on lounges and chaises which allow user to change from a lounge position to a task position within the same unit. An integrated handle at the top and bottom intuitively identifies the back and aids in the function of the back.

Lounge units can be connected together to create permanent connections for L- and U-configurations. The alignment connector bracket package includes two brackets to connect the seat decks and one screen alignment clip to keep the screens aligned.

Tables are offered in three types; work, occasional, and personal tables. Tables dimensions are curated to work with the lounge pieces for optimal compatibility.

Table bases and columns are standard in powder coat paint.

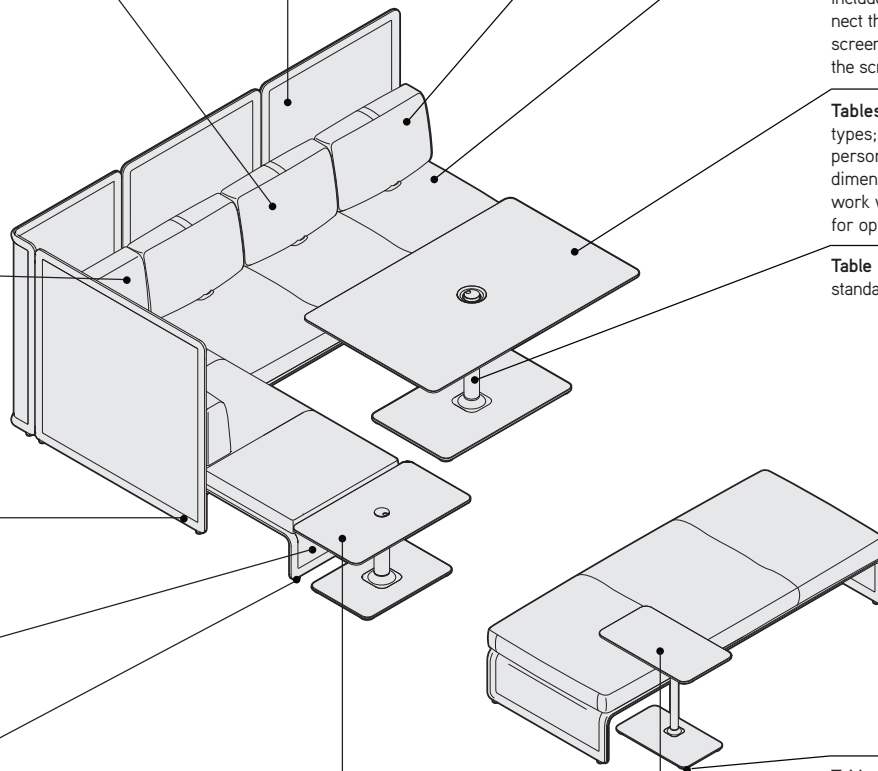

Work and occasional table tops are standard in High-Pressure Laminate with a 3 mm plastic edge or wood veneer with a 3 mm matching edge profile.

Table glides are non-adjustable and are clear plastic.

Personal table tops are standard in High-Pressure Laminate with 3 mm plastic edge or Fusion fabric.

Lagunitas

DESIGN TOAN NGUYEN

Product Details

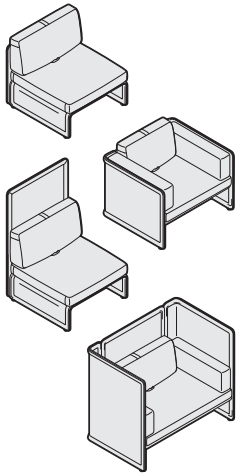

One-seat lounges are available in low- and high-back screens. Screens can be back only or back and left- and right-hand screens. One-seat lounges are standard with upholstered fabric or knit screen(s), fabric or knit seat deck, fabric or leather seat cushion, and articulating back cushions. Fabric or leather end arm cushions are available.

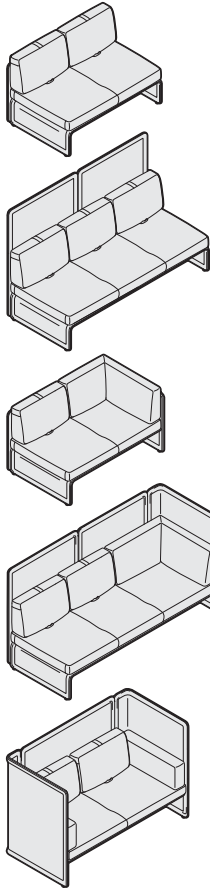

Two- and three-seat lounges are available in low- and high-back screens. Screens can be back only or back with left- or right-hand screens, or back and left- and right-hand screens. Two- and three-seat lounges are standard with upholstered fabric or knit screen(s), fabric or knit seat deck, fabric or leather seat cushions, fabric or leather articulating back(s) and or corner cushion(s). Fabric or leather end arm cushions are available.

Tip: Handedness is noted by seated position.

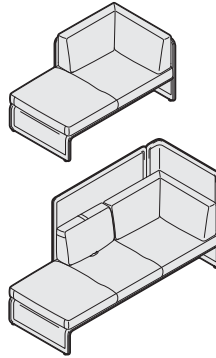

Two- and three-seat chaises are available in low- and high-back screens. Screens are back and left- or right-handed. Two- and three-seat chaises are standard with upholstered fabric or knit screens, fabric or knit seat deck, fabric or leather seat and corner cushion.

Tip: Handedness is determined while in the seated position.

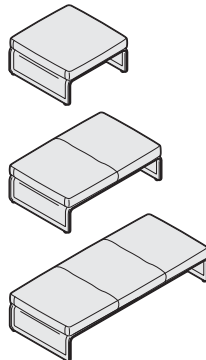

Benches are available in one-, two-, or three-seat models. Benches are standard with an upholstered knit or fabric seat deck and a fabric or leather seat cushion.

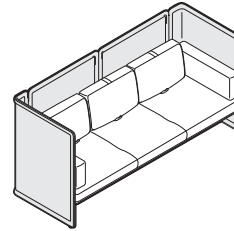

Screens are offered in two types of materials, knit and fabric. The knit panels allow for some transparency and light to pass through the panels. The fabric panels can be either monolithic (non-contrasting) or can be specified in differing finishes (contrasting) for the inside and outside of the screen.

Tip: If a contrasting screen is specified, the fabric must be chosen from the same fabric family.

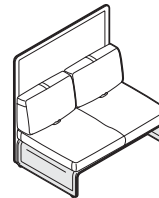

Seat deck is offered in two types of materials, knit and fabric. The seat deck material must match the screen material. If knit is specified on the screen, the seat deck will be applied automatically to the screen choice. If fabric is specified, seat deck must match either the inside or outside screen finish if contrasting is selected. When non-contrasting fabric screen is selected, seat deck will match screen fabric.

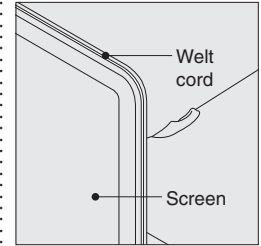

A welt cord is standard on all fabric specified screens and seat decks. The welt cord finish is non-specifiable and is the same fabric finish as the outside screen specification when contrasting screens are specified. For non-contrasting screens the welt cord matches the screen specification. The knit screen and seat deck does not require a welt cord.

Lagunitas *continued*

DESIGN TOAN NGUYEN

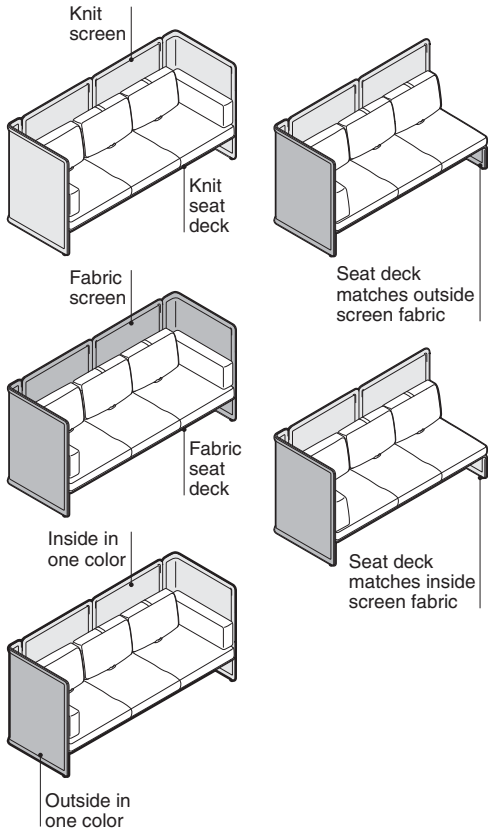

Screens and seat deck can be specified in:

- Knit
- Fabric (one fabric choice)
- Contrasting fabric (must be from fabric family)
 - Inside screen
 - Outside screen
 - Seat deck must match either the inside or outside fabric choice

Tip: Leather and vinyl are not approved for the screen(s) and seat deck. Consult the fabric database for fabric approvals.

Tip: It is important to understand the seat deck implication for contrasting fabric selection when two or more pieces are attached or adjacent to each other. The seat deck for contrasting fabric specification is either the outside screen (top example) or inside screen (bottom example).

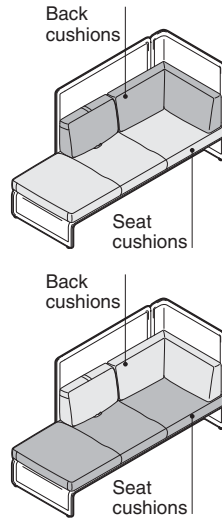

Seat back and seat cushions can be specified in:

- Fabric or leather (one fabric choice)
- Contrasting fabric or leather
 - Seat backs
 - Seat cushion

The seat back and seat cushion can be specified in fabric or leather. It can be specified as non-contrasting, one finish, or contrasting, finish for back cushions(s) and finish for seat cushion. Specification of back cushion is for all back cushions for that style number. Specification of seat cushion is for all seat cushions for the style number.

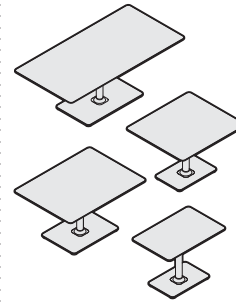

Work tables are available in six differing sizes, ranging from 30"W to 72"W that coordinate with the lounge dimensions to create a variety of social, collaborative, and personal applications. The work tables are comprised of a single column rectangular base in powder coat paint and a rectangular table top in laminate with matching or complementing 3 mm flat edge band profile or wood veneer with matching 3 mm flat wood edge band.

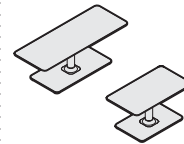

Occasional tables are available in two sizes, 32"W and 48"W, that coordinate with the lounge, chaise, and bench dimensions. The occasional tables are comprised of a single column with rectangular base available in powder coat paint and a rectangular table top in laminate with matching or complementing 3 mm flat edge band profile or wood veneer with matching 3 mm flat wood edge band.



Personal table is available in one size. It can easily be moved to your desired location for short term laptop work or simply used to set your coffee. The personal table is comprised of a single column with rectangular base available in powder coat paint and a rectangular table top in laminate with matching or complementing 3 mm flat edge band profile or a Fusion fabric-wrapped surface.

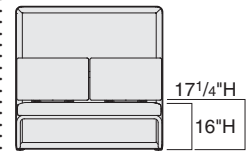

16" seat height is standard on all seating and benches. The 16"H seat height integrates specifically with the heights of all Lagunitas tables. There is an additional 1/4" crown of the seat cushion, which makes it 17 1/4" to work with the 26" work table height.

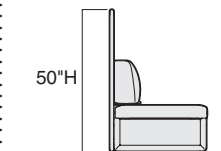
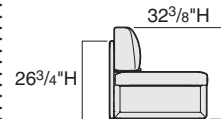

Two screen heights are available, 26 3/4"H for the low-back screen and 50"H for the high-back screen. Seat back cushions extend above the low-back screen, therefore, the overall height of low-back units is 32 3/8"H. Low-back screens are designed to provide an open environment. High-back screens are designed to provide privacy.

Lagunitas

DESIGN TOAN NGUYEN

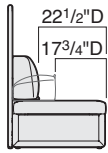

Seat depth accommodates two depths due to the articulated back design. In the lounge position, the seat depth is 22½\"/>

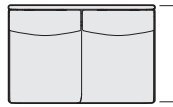

Lounge



Bench

The overall seat depth on benches is 32⅝\"/>

One-seat lounge, left- and right-hand screens

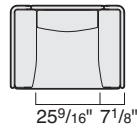

Two-seat lounge, left-hand screen

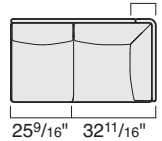

Three-seat lounge

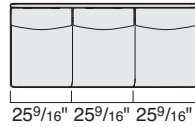

Three-seat lounge, right-hand screen

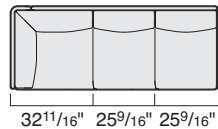

Three-seat lounge, left- and right-hand screens

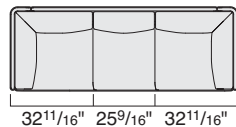

Three-seat chaise, right-hand configuration

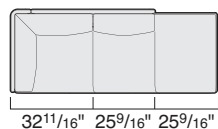

Three-seat bench

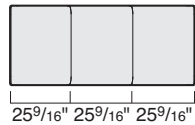

Two seat widths are available, 25⅙\"/>

Exception: One-seat lounge with three screens has an overall width of 46⅞\"/>

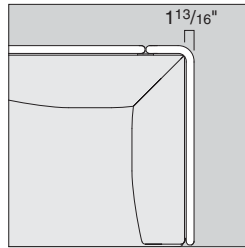

An additional 1⅜\"/>

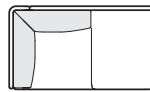

Corner cushions are standard when specifying two or three screens with closed end(s). Corner cushion are fixed and do not articulate.

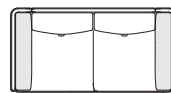

Two end cushions with two articulating backs

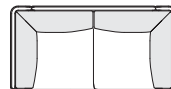

Two corner cushions

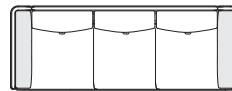

Two end cushions with three articulating backs

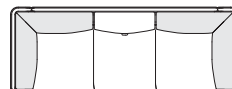

Two corner cushions with middle articulating back

Two corner cushions or two end cushions are available on all two- and three-seat lounges when back, left- and right-hand screens are specified. If articulating backs are specified, end cushions are required.



Lounge position



Task position

The articulating back is standard on all lounges and three-seat chaises (two-seat chaises are only available with a corner cushion). The articulating back allows the user to easily change postures from a lounge position, when the back cushion is fully upright, to a task position, when the seat back is articulated down. Simply use the integrated handles, one at the top and one at the bottom, to position the seat back to the desired position. The articulating mechanism is completely hidden behind the back cushion, and attaches the cushion to the seat frame.

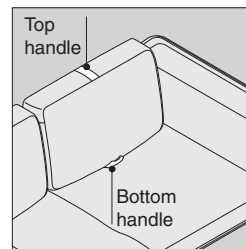

Handles at top and bottom of all articulating backs aid the user to change from a lounge position to a task position and back to the lounge position.

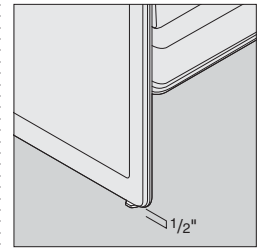

Glides adjust ½\"/>

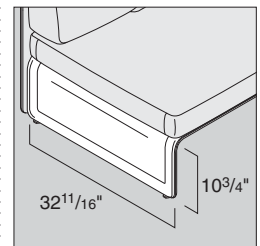

Space is available under the seat deck of all Lagunitas seating to provide a place to temporarily store personal items. The clearance height, without power module(s), is 10¾\"/>

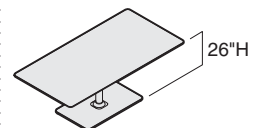

Work tables are available in one optimized height, 26\"/>

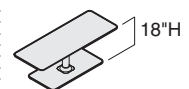

Occasional tables are available in one optimized height, 18\"/>

Lagunitas *continued*

DESIGN TOAN NGUYEN

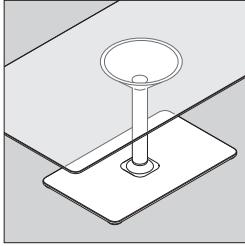

All work and occasional tables have a rectangular metal base with a centered column. The 3" column includes a cone at the top that attaches to the work surface. There are five rectangular base dimensions:

- 16"D x 23⁵/₈"W x ³/₈"H for 18"D x 32"W
- 24"D x 30"W and 24"D x 36"W work tables
- 16"D x 31⁵/₈"W x ³/₈"H for 18"D x 48"W occasional table
- 21"D x 28¹/₂"W x ³/₈"H for 36"D x 40"W and 36"D x 48"W work tables
- 21"D x 35"W x ³/₈"H for 36"D x 57"W x work table
- 21"D x 35"W x ¹/₂"H for 36"D x 72"W x work table

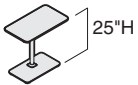

The personal table is available in one height, 25"H, to work with the lounge seat height.

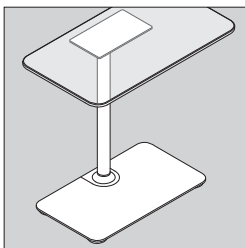

The personal table has a rectangular metal base with the column centered at the back of the base. The 1¹/₄" column includes a flat plate at the top that attaches to the underside of the top. The base plate dimension is 10³/₄"D x 15³/₄"W x ³/₈"H.

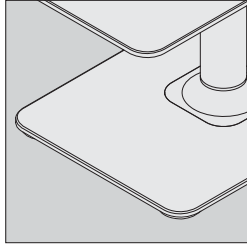

Non-adjustable 3" diameter plastic glides are standard on all tables. Glides are ³/₈" thick for the 36"D x 72"W table, ¹/₂" thick for all other work and occasional tables and ¹/₄" thick for the personal table. For all work and occasional tables the glide height is needed to route cords.

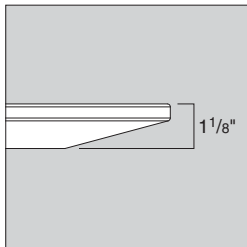

Tables are standard with a knife edge profile, that has the appearance of a ¹/₂" thick top that tapers to an overall top thickness of 1¹/₈".

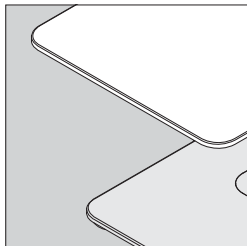

High-Pressure Laminate tables are standard with a matching or complementing 3 mm flat edge band. Wood veneer tables are standard with a matching wood 3 mm flat edge band. The underside of the table top is finished in black.

Specials are possible with Lagunitas, to confirm practicality and obtain a quotation, contact Customer Service at 1.800.627.6770.

Connections

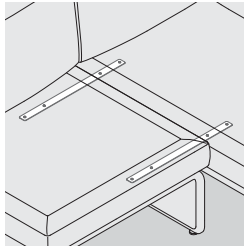

Alignment connector bracket package includes two seat attachment brackets and one screen alignment clip. The alignment connector bracket package is used when permanent connection is needed for L-, U-, and straight configurations of two or more pieces. The screen alignment clip is not needed for any bench connections, only the two seat attachment brackets would be utilized. The alignment connector bracket package should not be used if reconfigurations of the furniture pieces are required.

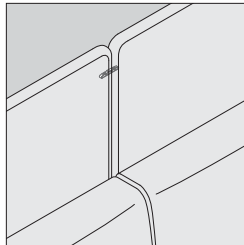

Attachment brackets for screen connection to seat deck must be specified in either platinum matte or low gloss black. Along with the brackets, the entire frame underneath will be painted to match the bracket finish specified.

Brackets can be specified in:

- 4710 Low Gloss Black Paint (for dark color fabrics)
- 4141 Platinum Matte Paint (for light color fabrics)

Power, Data, Wiring & Cabling

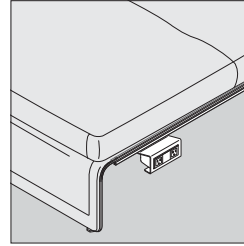

Optional power can be specified on all seating components (lounge, chaise, and bench). The power module consists of two simplex power outlets that can be positioned anywhere along the attachment rail underneath the front of the lounge seat. The power module is available in black. One optional power unit is available on one-seat lounges. One or two optional power units are available on two- and three-seat lounges.

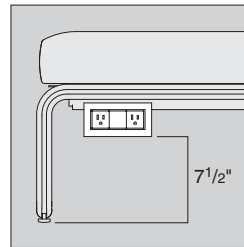

The power module is located 7¹/₂" from the floor.

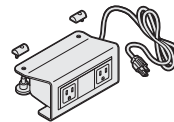

The power module has a 10'L cord and contains wire manager clips to route the cord underneath the seat deck when desired.

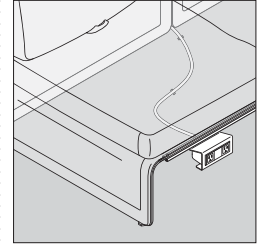

The power module cord is routed to the back utilizing clips attached to the underside of the lounge. The cord is then routed between the gap where the two screens meet when wall plug in access is needed.

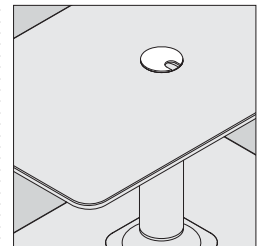

A metal grommet is an option on all work and occasional tables. The 3" grommet is flush-mounted and located in the center of the table top over the cone and column. The metal grommet is available in anodized silver only.

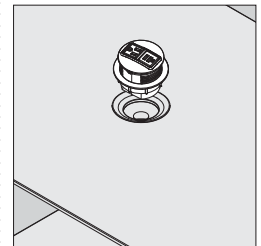

A power module is an option on work tables 40"W and smaller. The 3" power module has two simplex receptacles and is located in the center of the table top over the conelcolumn. The power module comes in one finish, silver and is standard with a 6' L power cord.

Lagunitas

DESIGN TOAN NGUYEN

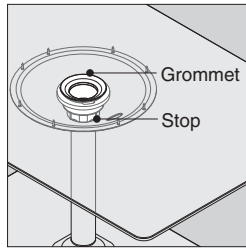

Power pod grommet and stop is an option on all work tables 48"W and larger. The grommet is located in the center of the table top over the cone/column. The stop attaches to the column to help hold and route cords and cables through the column. The grommet and stop cap are available in black or milk.

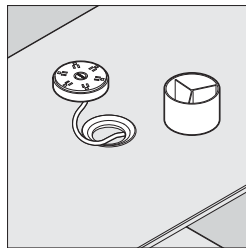

The grommet allows for pass through of cords and cables at the desktop. The grommet is open to allow for the power pod to be housed over or stored on the table. The grommet inside dimension is 3½" and outside dimension is 5¼".

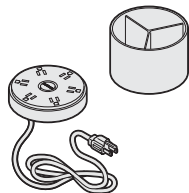

Power pod includes six 15 amp outlets with an energy saving illuminated on/off switch. It comes with a 6' cord with three prong plug. The top tray is milk and the power source is silver with a milk face. It is UL and CSA listed. *Tip: Power pod is sold separately.*

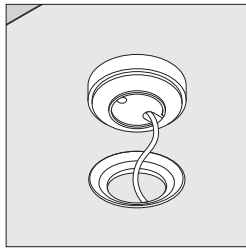

The contour of the power pod bottom cradle is designed to work in conjunction with the grommet for a snug fit or can be used independently without a grommet.

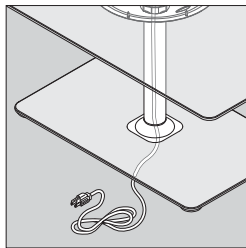

Work and occasional tables route cables and cords from the desktop through the column out through the base. Cords can be concealed in the cone.

Tip: A powerstrip cannot fit inside the cone. Tip: If a desktop device is desired, other than the standard power pod or power module, consult Specials engineering for capability.

Surface Materials

Screen(s) and seat deck:

- Knit
- Fabric (contrasting and non-contrasting - contrasting must be same fabric family)

Seat and back cushion(s), contrasting and non-contrasting:

- Fabric
- Leather

Lounge attachment brackets and frame:

- Paint

Lounge glides:

- Non-specifiable plated metal

Lounge power module (option):

- Black powder paint with black receptacles

Work and occasional table top surface:

- Laminated with matching or complementing 3 mm plastic edge band
- Wood veneer with matching 3 mm wood edge
- Custom wood finish (option)

Table base (cone or plate, column, and bottom plate):

- Paint

Table glides:

- Non-specifiable clear plastic

Metal grommet (option):

- Non-specifiable (anodized silver)

Power pod grommet and stop cover (option):

- 6000 Black plastic
- 6052 Milk plastic

Table power module (option):

- Non-specifiable silver paint with white receptacles

Personal table top surface:

- Laminate with matching or complementing 3 mm plastic edge band
- Fusion fabric

Note: Refer to the Coalesse Surface Materials Reference Guide for additional surface materials information.

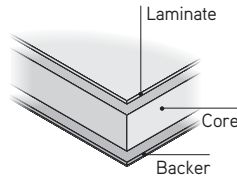

Laminates are available in two standard grades. Additional laminates from any manufacturer may also be practical—see *Other laminates* below.

Grade 1 laminates include:

- Coalesse standard laminates
- ▶ See *Coalesse Surface Materials Reference Guide*.
- Steelcase standard laminates (code 290A)
- ▶ See *Steelcase Surface Materials Reference Manual*.
- Any standard-grade Wilsonart laminate in solid color, woodgrain, or pattern finish (code 290A)

Grade 2 laminates (code 290B) include any standard-grade, solid color, woodgrain, or patterned laminate from Nevamar (includes Matrix), Formica, or Pionite. Grade 2 laminates may have extended lead times. For details, contact Customer Service at 1.800.627.6770.

Other laminates that are not included in the Grade 1 or Grade 2 offerings may also be available, such as Abet Laminati and Laminart. To determine availability and pricing, contact Customer Service at 1.800.627.6770, with the laminate manufacturer's name and the name and number of the laminate you want.

Laminate swatches are reproduced in the Surface Materials Color Palettes.

▶ See *Coalesse Surface Materials Reference Guide* for a list.

Swatch cards and actual samples of Coalesse standard laminates are available from your Coalesse customer service representative. For samples of laminates from other manufacturers, contact them directly:

- Wilsonart
1.800.433.3222
- Nevamar
1.800.638.4380
- Formica
1.800.FORMICA
- Pionite
1.800.285.5161

Tip: Laminate manufacturers change their offerings frequently. Always check availability before ordering.

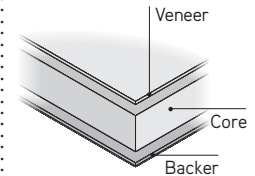

Wood veneer table tops are fabricated with Architectural Grade AA hand-selected hardwood veneer, plain sliced, book matched, and bonded to the core with a backing sheet for balance. Coalesse's primary wood finish, Clarity, is a water-borne UV topcoat, which protects the environment while providing exceptional durability and resistance to water and chemical stains. Due to natural variations in wood, finished products may vary from samples in color, texture, and grain.

Wood is a natural material; slight variations occur in veneer texture, color, grain configuration, and stain acceptance. Coalesse stains are all applied with an exacting regard for consistency and are well within traditional tolerances for wood products.

Tip: You should know that finished tops may vary slightly in tone or character from each other or from the samples Coalesse produces. No guarantee can be made of an absolutely exact match.

Wood veneer swatches are reproduced in the Surface Materials Color Palettes.

▶ See *Coalesse Surface Materials Reference Guide* for a list.

Lagunitas *continued*

DESIGN TOAN NGUYEN

Swatch cards and actual samples of Coalesse standard wood veneers are available from your Coalesse customer service representative.

Additional wood veneer species are available. To confirm availability and to determine pricing, contact Customer Service at 1.800.627.6770.

Stains applied to Coalesse wood veneer table tops are standard with the same stain color applied to both the top and the solid hardwood edge profile. Coalesse strives to produce a consistently high quality product and some natural variation in color is to be expected. This is especially apparent on natural woods which have no stain applied, for example 3525 Natural Maple. This color variation is normal and reflects the unique and natural properties of wood. This should not be considered a defect.

Stain swatches are reproduced in the Surface Materials Color Palettes. ▶ See *Coalesse Surface Materials Reference Guide* for a list.

Swatch cards and actual samples of standard wood veneers are available from your Customer Service representative.

Additional wood veneer stains are possible. Coalesse offers two programs to accommodate customers who need special stains—Stain-to-Match and Stain and Finish to Match.

Stain-to-Match option is a special Coalesse program that will match a wood stain sample that you provide. There is no additional charge for this service. You must supply a sample of reasonable size (3" x 3" or larger is usually adequate). Coalesse will formulate a stain, produce a matching sample, and send it to you for approval. When we receive your written approval, we'll schedule production of your order.

Tip: Stain-to-Match will achieve a color match to the sample only. Graining of the wood veneer and final surface finish may differ from your original sample. See Stain and Finish to Match.

Programs & Services

Customer's Own Material/Leather (COM/COL) Program is available. ▶ See *Coalesse Surface Materials Reference Guide* for additional information.

Designers

Toan Nguyen

Coalesse

Lagunitas

DESIGN TOAN NGUYEN

Lagunitas Thought Starters and Applications

DESIGN TOAN NGUYEN

Lagunitas offers a wide range of highly customizable settings with varying degrees of privacy and multimodal support that become a desired third place to collaborate, socialize, or focus on personal work as individuals spend less time at traditional workstations and require different postures for working.

Individual Carrels

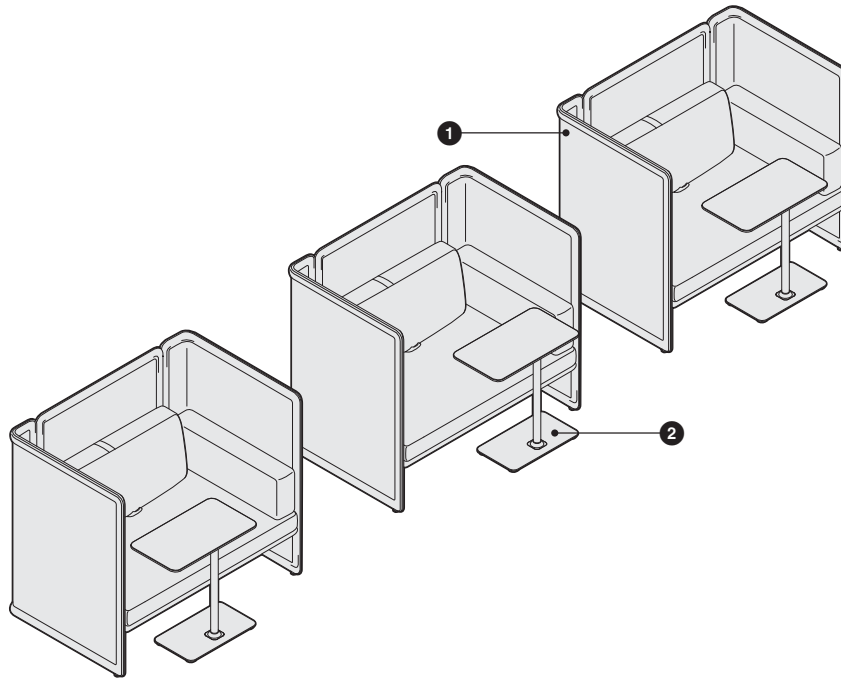

Non-contrasting knit Grade 1 screens and seat deck with non-contrasting fabric Grade 10 seat and back

Quantity	Style Number	Description	Components	U.S. Base Price	Total
1	COLAGLH1	One-Seat Lounge with Articulating Back and End Arm Cushions, High-Back, Left and Right Screens	Screen and Seat Deck	\$3417	\$3417
			Seat	\$ 517	\$ 517
			Back	\$1120	\$1120
2	COLAGTP	Personal Table Laminate Grade 1	Table	\$ 611	\$ 611
					\$5665

Non-contrasting fabric Grade 10 screens and seat deck with contrasting fabric Grade 12 seat and back

Quantity	Style Number	Description	Components	U.S. Base Price	Total
1	COLAGLH1	One-Seat Lounge with Articulating Back and End Arm Cushions, High-Back, Left and Right Screens	Screen and Seat Deck	\$5316	\$5316
			Seat	\$ 642	\$ 642
			Back	\$1385	\$1385
			Contrasting Cushions (option)	\$ 118	\$ 118
2	COLAGTP	Personal Table Laminate Grade 1	Table	\$ 611	\$ 611
					\$ 8072

Private Meeting

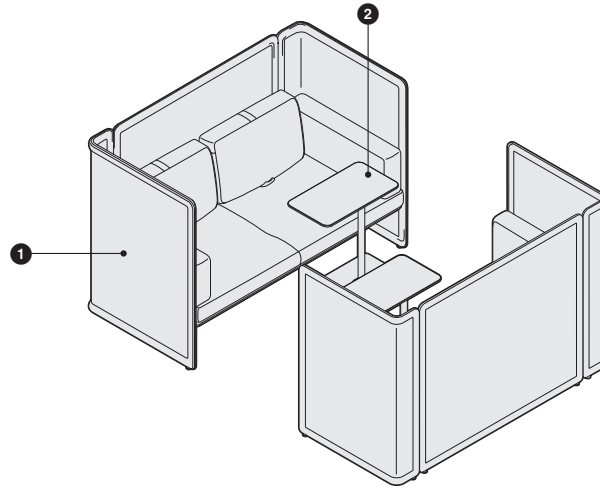

Non-contrasting knit Grade 1 screens and seat deck and non-contrasting fabric COM on seat and back

Quantity	Style Number	Description	Components	U.S. Base Price	Total
1	COLAGLH2	Two-Seat Lounge with Articulating Back and End Arm Cushions, High-Back, Left and Right Screens	Screen and Seat Deck	\$4131	\$ 4131
			Seat	\$ 306	\$ 306
			Back	\$ 918	\$ 918
			COM (option)	\$ 150	\$ 150
2	COLAGTP	Personal Table Laminate Grade 1	Table	\$ 611	\$ 1222
					\$ 6727

Contrasting fabric Grade 9 screens and seat deck and contrasting fabric Grade 14 seat and back

Quantity	Style Number	Description	Components	U.S. Base Price	Total
1	COLAGLH2	Two-Seat Lounge with Articulating Back and End Arm Cushions, High-Back, Left and Right Screens	Screen and Seat Deck	\$5865	\$ 5865
			Contrasting Screens (option)	\$ 118	\$ 118
			Seat	\$1037	\$ 1037
			Back	\$2656	\$ 2656
			Contrasting Cushions (option)	\$ 118	\$ 118
2	COLAGTP	Personal Table Laminate Grade 1	Table	\$ 611	\$ 1222
					\$11,016

Island

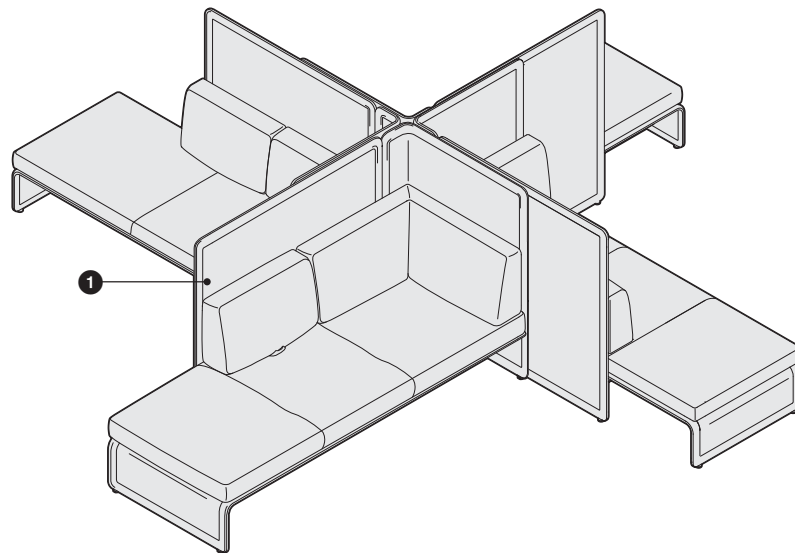

Non-contrasting knit Grade 2 screens and seat deck and non-contrasting fabric Grade 6 seat and back

Quantity	Style Number	Description	Components	U.S. Base Price	Total
1	COLAGCH3	Three-Seat Chaise with Corner Cushion and One Articulating Back, High-Back, Left Screen (Left-hand configuration)	Screen and Seat Deck	\$3649	\$3649
			Seat	\$ 565	\$ 565
			Back	\$1097	\$1097
					\$5311

Non-contrasting fabric Grade 11 screen and seat deck and non-contrasting fabric Grade 11 seat and back

Quantity	Style Number	Description	Components	U.S. Base Price	Total
1	COLAGCH3	Three-Seat Chaise with Corner Cushion and One Articulating Back, High-Back, Left Screen (Left-hand configuration)	Screen and Seat Deck	\$5276	\$5276
			Seat	\$1017	\$1017
			Back	\$1616	\$1616
					\$7909

Small Social

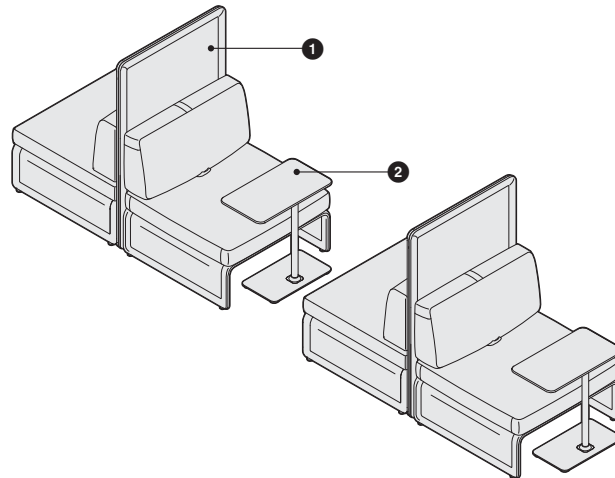

Non-contrasting knit Grade 1 screen and seat deck and non-contrasting fabric Grade 6 seat and back

	Quantity	Style Number	Description	Components	U.S. Base Price	Total
1	1	COLAGLH1	One-Seat Lounge with Articulating Back, High-Back Screen	Screen and Seat Deck	\$1581	\$1581
				Seat	\$ 288	\$ 288
				Back	\$ 543	\$ 543
2	1	COLAGTP	Personal Table Fusion Fabric	Table	\$ 867	\$ 867
						\$3279

Contrasting fabric Grade 9 screen and seat deck and non-contrasting fabric Grade11 seat and back

	Quantity	Style Number	Description	Components	U.S. Base Price	Total
1	1	COLAGLH1	One-Seat Lounge with Articulating Back, High-Back Screen	Screen and Seat Deck	\$2417	\$2417
				Contrasting Screens (option)	\$ 118	\$ 118
				Seat and Back	\$1317	\$1317
2	1	COLAGTP	Personal Table Fusion Fabric	Table	\$ 867	\$ 867
						\$4719

Booth Setting

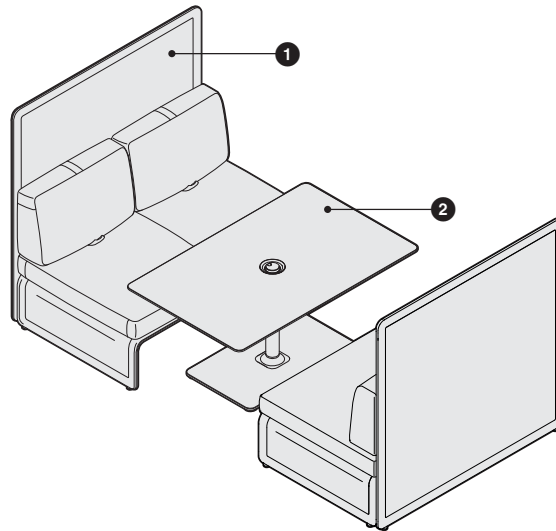

Non-contrasting knit Grade 1 screen and seat deck and non-contrasting fabric Grade 10 seat and back

	Quantity	Style Number	Description	Components	U.S. Base Price	Total
1	2	COLAGLH2	Two-Seat Lounge with Two Articulating Backs, High-Back Screen	Screen and Seat Deck	\$2295	\$ 4590
				Seat	\$ 619	\$ 1238
				Back	\$1363	\$ 2726
2	1	COLAGTRECT	Work Table Laminate Grade 1- 57"W	Table	\$2239	\$ 2239
						\$10,793

Contrasting fabric Grade 10 screen and seat deck and contrasting fabric Grade 10 seat and back

	Quantity	Style Number	Description	Components	U.S. Base Price	Total
1	2	COLAGLH2	Two-Seat Lounge with Two Articulating Backs, High-Back Screen	Screen and Seat Deck	\$3569	\$ 7138
				Contrasting Screen (option)	\$ 118	\$ 236
				Seat	\$ 619	\$ 1238
				Back	\$1363	\$ 2726
				Contrasting Cushions (option)	\$ 118	\$ 236
2	1	COLAGTRECT	Work Table Laminate Grade 1- 57"W	Table	\$2239	\$ 2239
						\$13,813

Crossover

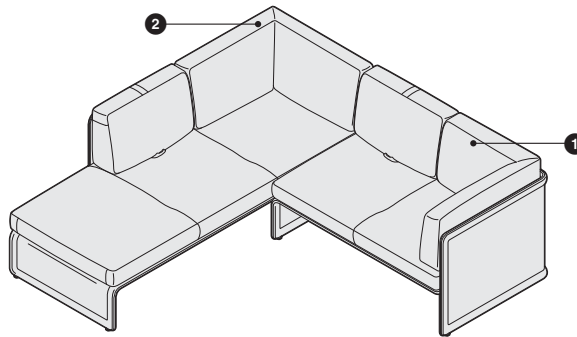

Non-contrasting fabric Grade 13 screen and seat deck and non-contrasting leather Grade E seat and back

	Quantity	Style Number	Description	Components	U.S. Base Price	Total
1	1	COLAGLL2	Two-Seat Lounge with One Corner Cushion and One Articulating Back, Low-Back, Left Screen	Screen and Seat Deck	\$4771	\$ 4771
				Seat	\$1418	\$ 1418
				Back	\$2929	\$ 2929
2	1	COLAGCL3	Three-Seat Chaise with Corner Cushion and One Articulating Back (Left-hand configuration)	Screen and Seat Deck	\$5245	\$ 5245
				Seat	\$ 2162	\$ 2162
				Back	\$2929	\$ 2929
						\$19,454

L-Configuration

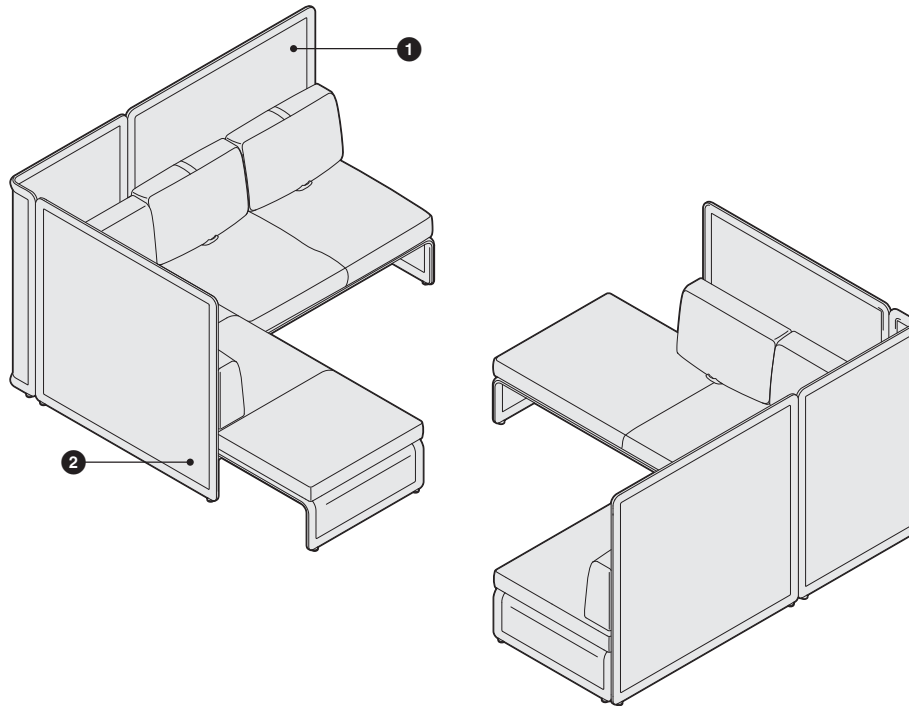

Non-contrasting knit Grade 1 screen and seat deck and non-contrasting leather Grade C seat and back

	Quantity	Style Number	Description	Components	U.S. Base Price	Total
1	1	COLAGLH2	Two-Seat Lounge with Two Articulating Backs, High-Back	Screen and Seat Deck	\$2295	\$ 2295
				Seat	\$1252	\$ 1252
				Back	\$2265	\$ 2265
2	1	COLAGCH3	Three-Seat Chaise with Corner Cushion and One Articulating Back (Left-hand configuration)	Screen and Seat Deck	\$3162	\$ 3162
				Seat	\$1900	\$ 1900
				Back	\$2629	\$ 2629
						\$13,503

L-Configuration, continued

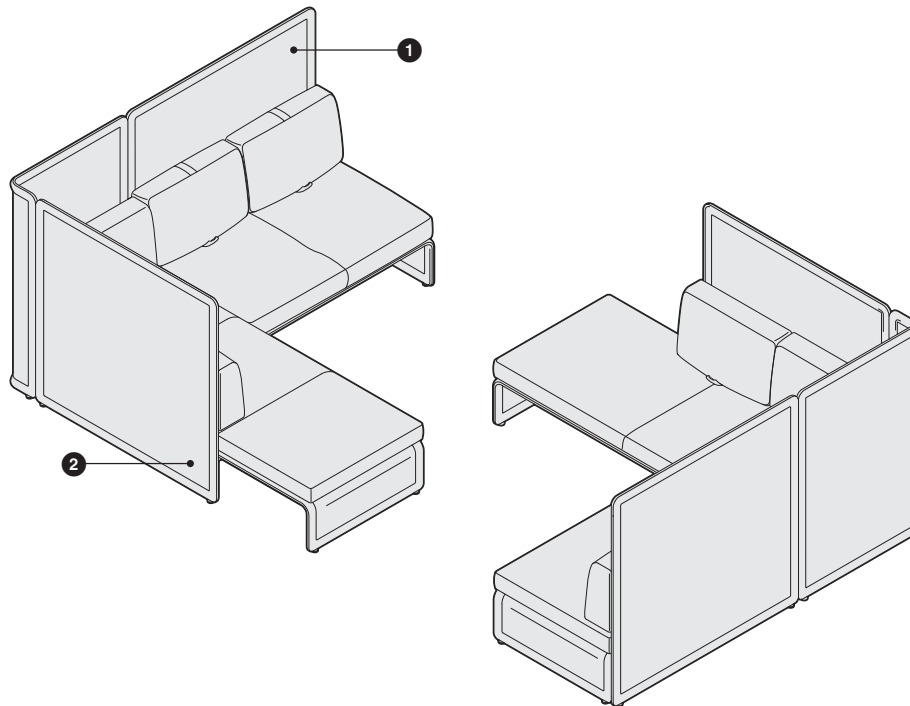

Lounge Seating

Contrasting fabric COM screen and seat deck and non-contrasting fabric COM seat and back

	Quantity	Style Number	Description	Components	U.S. Base Price	Total
1	1	COLAGLH2	Two-Seat Lounge with Two Articulating Backs, High-Back Screen	Screen and Seat Deck	\$2474	\$2474
				Contrasting Screens (option)	\$ 118	\$ 118
				Seat and Back	\$1224	\$1224
2	1	COLAGCH3	Three-Seat Chaise with Corner Cushion and One Articulating Back (Left-hand configuration)	Screen and Seat Deck	\$3494	\$3494
				Contrasting Screens (option)	\$ 118	\$ 118
				Seat and Back	\$1326	\$1326
						\$8754

Benching

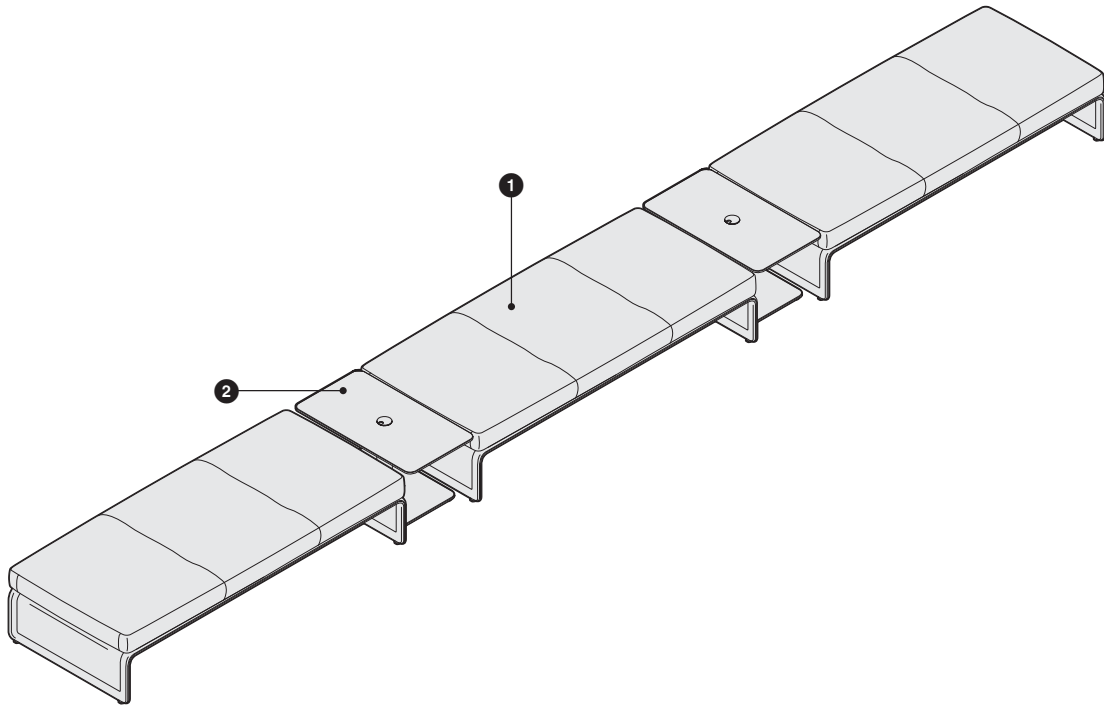

Knit Grade 1 seat deck and leather Grade C seat

	Quantity	Style Number	Description	Components	U.S. Base Price	Total
❶	3	COLAGB3	Three-Seat Bench	Seat Deck	\$1428	\$ 4284
				Seat	\$1865	\$ 5595
❷	2	COLAGTO	Occasional Table Laminate Grade 1-32"W	Table	\$1474	\$ 2948
						\$12,827

Benching, continued

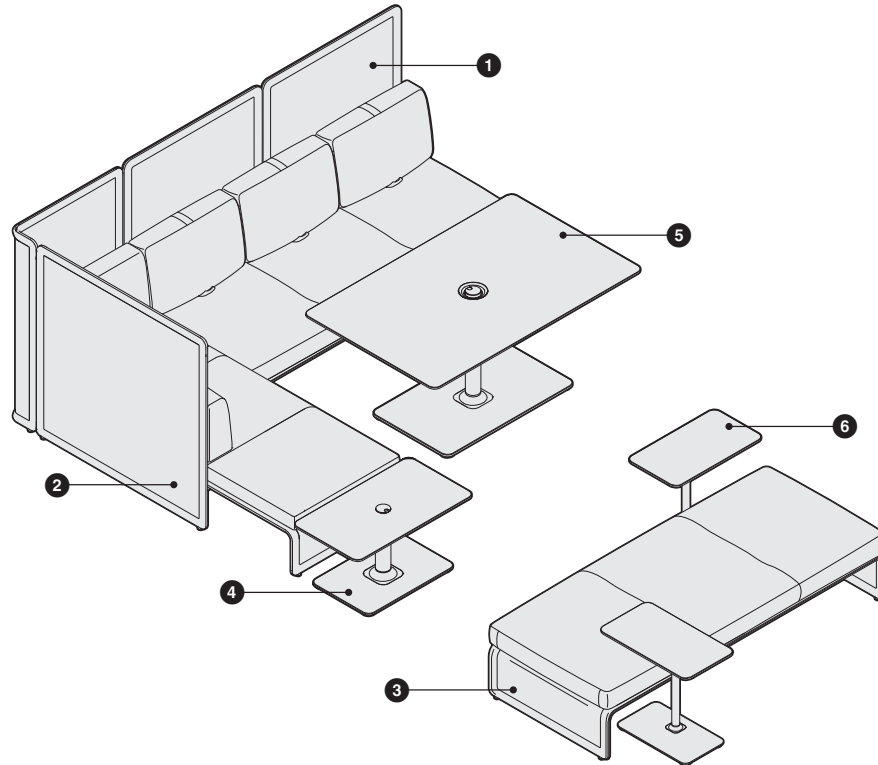

Non-contrasting knit Grade 1 screen and seat deck and contrasting fabric Grade 10 seat and back

	Quantity	Style Number	Description	Components	U.S. Base Price	Total
1	1	COLAGLH3	Three-Seat Lounge with Three Articulating Backs, High-Back	Screen and Seat Deck	\$3009	\$ 3009
				Seat	\$ 841	\$ 841
				Back	\$2038	\$ 2038
				Contrasting Cushions (option)	\$ 118	\$ 118
2	1	COLAGCH3	Three-Seat Chaise with Corner Cushion and One Articulating Back (Left-hand configuration)	Screen and Seat Deck	\$3162	\$ 3162
				Seat	\$ 901	\$ 901
				Back	\$1483	\$ 1483
				Contrasting Cushions (option)	\$ 118	\$ 118
3	1	COLAGB3	Three-Seat Bench	Seat Deck	\$1428	\$ 1428
				Seat	\$ 889	\$ 889
4	1	COLAGTO	Occasional Table Laminate Grade 1-32"W	Occasional Table	\$1474	\$ 1474
5	1	COLAGTRECT	Work Table Laminate Grade 1-57"W	Work Table	\$2239	\$ 2239
6	2	COLAGTP		Personal Table	\$ 611	\$ 1222
						\$18,922

Lagunitas Multi-Fabric Diagram

DESIGN TOAN NGUYEN

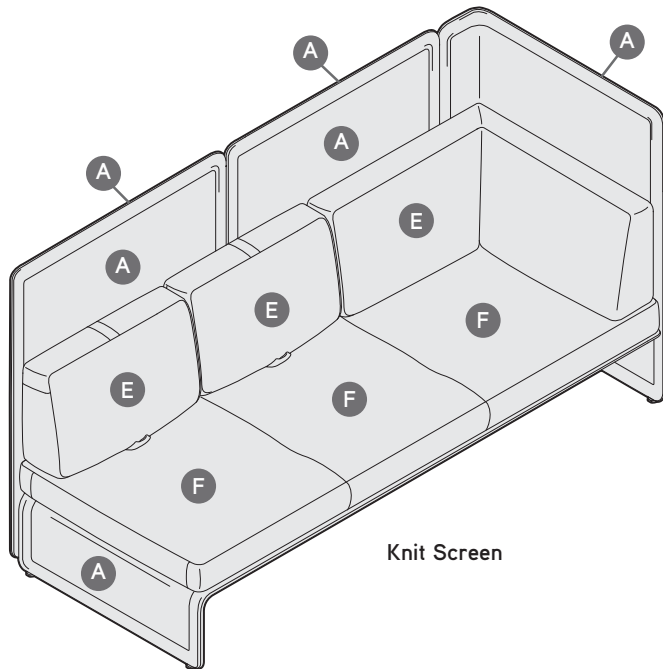

Knit Screen

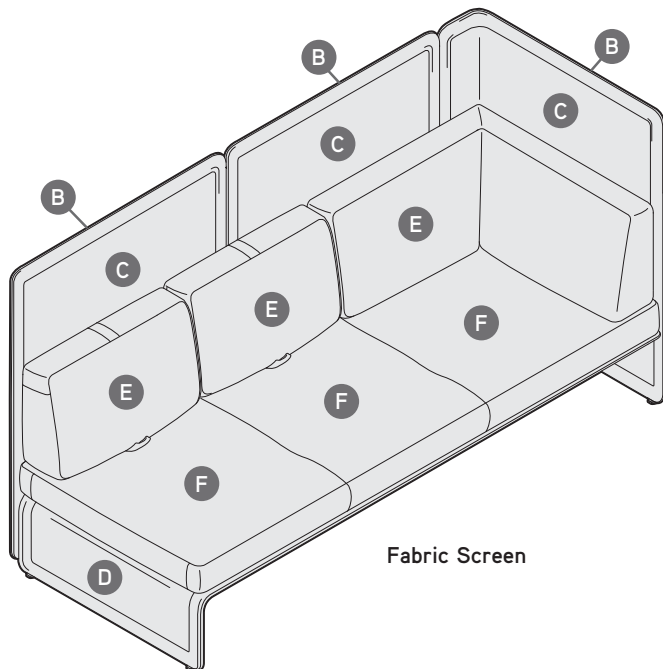

Fabric Screen

TO: _____

FROM: _____

DATE: _____

FAX...888.413.5161

A Knit screen, if selected (seat deck will match knit screen):

B Outside fabric screen, if contrasting fabric screen is selected:

C Inside fabric screen, if contrasting fabric screen is selected:

D Seat deck (must select to match outside or inside screen):

E Back/Corner cushion:

F Seat cushion:

\$118 list per contrasting fabric specified.

Tip: When selecting contrasting fabric screens, fabrics must be from same fabric family.



For Canadian Pricing
Multiply U.S. Price by the
Canadian price factor.
▶ See page 1 for details.

Coalesse

Lagunitas

Multi-Fabric Diagram

DESIGN TOAN NGUYEN

Lagunitas One-Seat Lounges

DESIGN TOAN NGUYEN

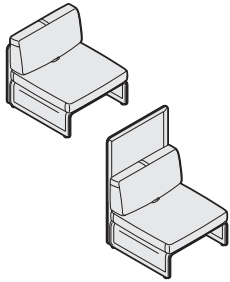

► Need help?
Product details,
page 154

Standard Includes

- Seat deck and screen: grade 1 knit or fabric
- Seat, articulating back cushion, and end arm cushions: fabric or leather
- Bracket: 4710 Low Gloss Black or 4141 Platinum Matte paint
- Six adjustable glides
- Ships assembled

Required to Specify

- 1 Style number
 - 2 Knit color number for screen and seat deck, if selected
 - 3 Fabric color number for non-contrasting screen (includes inside and outside) and seat deck, if selected
 - 4 Fabric color number for contrasting outside screen (same family as inside screen), if selected
 - 5 Fabric color number for contrasting inside screen (same family as outside screen), if selected
 - 6 Seat deck to match inside or outside screen, if contrasting screen is selected
 - 7 Fabric or leather color number for non-contrasting seat and back cushion, if selected
 - 8 Fabric or leather color number for contrasting seat cushion, if selected
 - 9 Fabric or leather color number for contrasting back cushion, if selected
 - 10 Paint color number for bracket
 - 11 Options, if selected (see below)
- See *Coalesse Surface Materials Reference Guide*.

Tip: For Customer's Own Material or Leather, see necessary requirements, important processing instructions and ordering information.

► See *Coalesse Surface Materials Reference Guide*.

Tip: Fire code seating is not available on one-seat lounge chairs with side screens.

Tip: Fire code seating is not available on chairs with contrasting fabric.

Tip: For any portion of the product that requires a COM, the additional \$150 upcharge is a one time charge per product.

Tip: For any portion of the product that requires a COL, the additional \$274 upcharge is a one time charge per product.

Tip: Must combine seat deck and list screen pricing choice (knit grade 1, knit grade 2, or fabric) from either non-contrasting or contrasting pricing list with seat and back cushion list pricing (fabric and leather) from either non-contrasting or contrasting pricing list to obtain completed list price.

	Options	U.S. Price	Required to Specify
Surface Materials	• Contrasting fabric for screen	+\$118	Specify with <i>contrasting fabric</i> and select fabric or leather color number.
	• Contrasting fabric for cushion	+\$118	Specify with <i>contrasting fabric</i> and select fabric or leather color number. ► See <i>Coalesse Surface Materials Reference Guide</i> .
	Fire code seating		
	• One-seat lounge with one low-back screen	+\$301	Specify with <i>fire code seating</i> .
	• One-seat lounge with one high-back screen	+\$461	Specify with <i>fire code seating</i> . ► See <i>Coalesse Surface Materials Reference Guide</i> .
	Acrylic backer		
	• One-seat lounge with one low-back screen	+\$ 33	Specify with <i>acrylic backer</i> .
	• One-seat lounge with one low-back screen, one right- and one left-hand screen	+\$ 68	Specify with <i>acrylic backer</i> .
	• One-seat lounge with one high-back screen	+\$ 55	Specify with <i>acrylic backer</i> .
	• One-seat lounge with one high-back screen, one right- and one left-hand screen	+\$ 90	Specify with <i>acrylic backer</i> . ► See <i>Coalesse Surface Materials Reference Guide</i> .
	• COM	+\$150	Specify with <i>COM</i> and select fabric color number. ► See <i>Coalesse Surface Materials Reference Guide</i> .
	• COL	+\$274	Specify with <i>COL</i> and select leather color number. ► See <i>Coalesse Surface Materials Reference Guide</i> .
Power	• One power module in 4710 Black paint	+\$306	Specify with <i>one power module</i> .
Related Products	<ul style="list-style-type: none"> • Bench • Chaise • Work Tables • Occasional Tables • Personal Table • Alignment Connector 		<ul style="list-style-type: none"> ► Page 194 ► Page 190 ► Page 197 ► Page 198 ► Page 199 ► Page 196

Lagunitas One-Seat Lounges

DESIGN TOAN NGUYEN

Specification Information

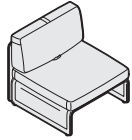

Overall: 32¾"W x 34"D x 32⅜"H,
Inside (Lounge): 32¾"W x 22½"D
Inside (Task): 32¾"W x 17¾"D
Seat: 16"H

Style Number	U.S. Base Prices												Leather Grades:		
	Knit Grade 1	Knit Grade 2	Fabric Grades: COM	6	7	8	9	10	11	12	13	14	COL	C	E

One-Seat Lounge with Articulating Back, Low-Back Screen

COLAGLL1	Screen and Seat Deck	\$1275	\$1455	\$1454	\$1706	\$1753	\$1837	\$2086	\$ 2248	\$ 2435	\$ 2565	\$ 2797	\$ 3117	N.A.	N.A.	N.A.
	Seat	N.A.	N.A.	+\$204	+\$288	+\$304	+\$331	+\$415	+\$ 468	+\$ 531	+\$ 574	+\$ 651	+\$ 759	+\$204	+\$1005	+\$1145
	Back	N.A.	N.A.	+\$459	+\$543	+\$559	+\$586	+\$670	+\$ 723	+\$ 786	+\$ 829	+\$ 906	+\$ 1014	+\$459	+\$1260	+\$1400

Seat Deck: 2.6 yards, Inside Screen: 1.4 yards, Outside Screen: 1.6 yards, Seat Cushion: 2.2 yards, 48.4 sq ft, Back Cushion: 2.2 yards, 48.4 sq ft

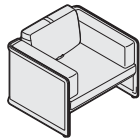

Overall: 49¼"W x 34"D x 32⅜"H
Seat: 16"H

Style Number	U.S. Base Prices												Leather Grades:		
	Knit Grade 1	Knit Grade 2	Fabric Grades: COM	6	7	8	9	10	11	12	13	14	COL	C	E

One-Seat Lounge with Articulating Back and End Arm Cushions, Low-Back, Left and Right Screens

COLAGLL1	Screen and Seat Deck	\$2397	\$2782	\$2729	\$3203	\$3293	\$3448	\$3917	\$ 4220	\$ 4571	\$ 4815	\$ 5250	\$ 5854	N.A.	N.A.	N.A.
	Seat	N.A.	N.A.	+\$204	+\$303	+\$322	+\$355	+\$453	+\$ 517	+\$ 590	+\$ 642	+\$ 733	+\$ 859	+\$204	+\$1150	+\$1316
	Back	N.A.	N.A.	+\$459	+\$669	+\$709	+\$778	+\$986	+\$1120	+\$1276	+\$1385	+\$1577	+\$1845	+\$459	+\$2461	+\$2812

Arm:0, Seat Deck: 1.8 yards, Inside Screen: 4.4 yards, Outside Screen: 5.1 yards, Seat Cushion: 2.6 yards, 57.2 sq ft, Back Cushion: 5.5 yards, 121 sq ft

► Specification Information, continued on next page



For Canadian Pricing
 Multiply U.S. Price by the
 Canadian price factor.
 ► See page 1 for details.

Lagunitas One-Seat Lounges *continued*

DESIGN TOAN NGUYEN

► Specification Information, continued from previous page

Specification Information

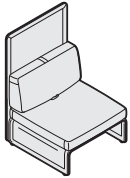

Overall: 32¾"W x 34"D x 50"H
Inside (Lounge): 32¾"W x 22½"D
Inside (Task): 32¾"W x 17¾"D
Seat: 16"H

Style Number	U.S. Base Prices												Leather Grades:		
	Knit Grade 1	Knit Grade 2	Fabric Grades:										COL	C	E
			COM	6	7	8	9	10	11	12	13	14			

One-Seat Lounge with Articulating Back, High-Back Screen

COLAGLH1	Screen and Seat Deck	\$1581	\$1786	\$1785	\$2037	\$2084	\$2168	\$2417	\$ 2579	\$2766	\$ 2896	\$ 3128	\$ 3448	N.A.	N.A.	N.A.
	Seat	N.A.	N.A.	+\$204	+\$288	+\$304	+\$331	+\$415	+\$ 468	+\$531	+\$ 574	+\$ 651	+\$ 759	+\$204	+\$1005	+\$1145
	Back	N.A.	N.A.	+\$459	+\$543	+\$559	+\$586	+\$670	+\$ 723	+\$786	+\$ 829	+\$ 906	+\$1014	+\$459	+\$1260	+\$1400

Seat Deck: 2.6 yards, Inside Screen: 1.4 yards, Outside Screen: 1.6 yards, Seat Cushion: 2.2 yards, 48.4 sq ft, Back Cushion: 2.2 yards, 48.4 sq ft

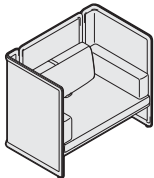

Overall: 49¼"W x 34"D x 50"H
Seat: 16"H

Style Number	U.S. Base Prices												Leather Grades:		
	Knit Grade 1	Knit Grade 2	Fabric Grades:										COL	C	E
			COM	6	7	8	9	10	11	12	13	14			

One-Seat Lounge with Articulating Back and End Arm Cushions, High-Back, Left and Right Screens

COLAGLH1	Screen and Seat Deck	\$3417	\$3878	\$3825	\$4299	\$4389	\$4544	\$5013	\$ 5316	\$5667	\$ 5911	\$ 6346	\$ 6950	N.A.	N.A.	N.A.
	Seat	N.A.	N.A.	+\$204	+\$303	+\$322	+\$355	+\$453	+\$ 517	+\$590	+\$ 642	+\$ 733	+\$ 859	+\$204	+\$1150	+\$1316
	Back	N.A.	N.A.	+\$459	+\$669	+\$709	+\$778	+\$986	+\$1120	+\$1276	+\$1385	+\$1577	+\$1845	+\$459	+\$2461	+\$2812

Arm:0, Seat Deck: 1.8 yards, Inside Screen: 4.4 yards, Outside Screen: 5.1 yards, Seat Cushion: 2.6 yards, 57.2 sq ft, Back Cushion: 5.5 yards, 121 sq ft



For Canadian Pricing
 Multiply U.S. Price by the
 Canadian price factor.
 ► See page 1 for details.

Coalesse

Lagunitas One-Seat Lounges

DESIGN TOAN NGUYEN

Lagunitas Two-Seat Lounges

DESIGN TOAN NGUYEN

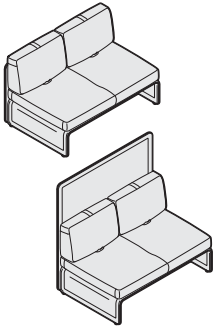

	Standard Includes	Required to Specify
<p>► Need help? Product details, page 154</p>	<ul style="list-style-type: none"> • Seat deck and screen: grade 1 knit or fabric • Seat, articulating back cushion, back corner cushion, and end arm cushions, if selected: fabric or leather • Bracket: 4710 Low Gloss Black or 4141 Platinum Matte paint • Six adjustable glides • Ships assembled 	<ol style="list-style-type: none"> 1 Style number 2 Left- or right-hand configuration, if selected (see below under Required Selections) 3 Knit color number for screen and seat deck, if selected 4 Fabric color number for non-contrasting screen (includes inside and outside) and seat deck, if selected 5 Fabric color number for contrasting outside screen (same family as inside screen), if selected 6 Fabric color number for contrasting inside screen (same family as outside screen), if selected 7 Seat deck to match inside or outside screen, if contrasting screen is selected 8 Fabric or leather color number for non-contrasting seat and back cushion, if selected 9 Fabric or leather color number for contrasting seat cushion, if selected 10 Fabric or leather color number for contrasting back cushion, if selected 11 Paint color number for bracket 12 Options, if selected (see below) <p>► See <i>Coalesse Surface Materials Reference Guide</i>.</p>

	Required Selections	U.S. Price	Required to Specify
Handedness	• Left-hand, two-screen lounges only (seated position)	No cost	Specify <i>left-hand configuration</i> .
	• Right-hand, two-screen lounges only (seated position)	No cost	Specify <i>right-hand configuration</i> .

	Options	U.S. Price	Required to Specify
Surface Materials	• Contrasting fabric for screen	+\$118	Specify <i>with contrasting fabric</i> and select fabric or leather color number.
	• Contrasting fabric for cushion	+\$118	Specify <i>with contrasting fabric</i> and select fabric or leather color number. ► See <i>Coalesse Surface Materials Reference Guide</i> .

	Fire code seating		
	• Two-seat lounge with low or high-back screen	+\$461	Specify <i>with fire code seating</i> . ► See <i>Coalesse Surface Materials Reference Guide</i> .

	Acrylic backer		
	• Two-seat lounge with one low-back screen	+\$ 53	Specify <i>with acrylic backer</i> .
	• Two-seat lounge with one low-back screen, one right- or left-hand screen	+\$ 81	Specify <i>with acrylic backer</i> .
	• Two-seat lounge with one low-back screen, one right- and one left-hand screen	+\$109	Specify <i>with acrylic backer</i> .
	• Two-seat lounge with one high-back screen	+\$ 81	Specify <i>with acrylic backer</i> .
	• Two-seat lounge with one high-back screen, one right- or left-hand screen	+\$123	Specify <i>with acrylic backer</i> .
	• Two-seat lounge with one high-back screen, one right- and one left-hand screen	+\$165	Specify <i>with acrylic backer</i> . ► See <i>Coalesse Surface Materials Reference Guide</i> .

► Options, continued on next page

Tip: For Customer's Own Material or Leather, see necessary requirements, important processing instructions and ordering information.
► See *Coalesse Surface Materials Reference Guide*.

Tip: Fire code seating is not available on chairs with contrasting fabric.



For Canadian Pricing
Multiply U.S. Price by the Canadian price factor.
► See page 1 for details.

Lagunitas Two-Seat Lounges

DESIGN TOAN NGUYEN

► Options, continued from previous page

Tip: For any portion of the product that requires a COM, the additional \$150 upcharge is a one time charge per product.

Tip: For any portion of the product that requires a COL, the additional \$274 upcharge is a one time charge per product.

Tip: Must combine seat deck and list screen pricing choice (knit grade 1, knit grade 2, or fabric) from either non-contrasting or contrasting pricing list with seat and back cushion list pricing (fabric and leather) from either non-contrasting or contrasting pricing list to obtain completed list price.

	Options	U.S. Price	Required to Specify
Surface Materials, continued	• COM	+\$150	Specify with COM and select fabric color number. ► See Coalesse Surface Materials Reference Guide.
	• COL	+\$274	Specify with COL and select leather color number. ► See Coalesse Surface Materials Reference Guide.
Power	• One power module in 4710 Black paint	+\$306	Specify with one power module.
	• Two power modules in 4710 Black paint	+\$612	Specify with two power modules.
Related Products	<ul style="list-style-type: none"> • Bench • Chaise • Work Tables • Occasional Tables • Personal Table • Alignment Connector 		<ul style="list-style-type: none"> ► Page 194 ► Page 190 ► Page 197 ► Page 198 ► Page 199 ► Page 196

Lounge Seating

Specification Information

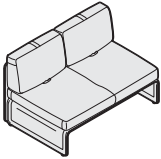

Overall: 51¼"W x 34"D x 32¾"H
Inside (Lounge): 51¼"W x 22½"D
Inside (Task): 51¼"W x 17¾"D
Seat: 16"H

Style Number	U.S. Base Prices														Leather Grades:		
	Knit		Fabric Grades:														
	Grade 1	Grade 2	COM	6	7	8	9	10	11	12	13	14	COL	C	E		

Two-Seat Lounge with Two Articulating Backs, Low-Back Screen

COLAGLL2	Screen and Seat Deck	\$1683	\$1914	\$1836	\$2185	\$2251	\$2363	\$2708	\$2931	\$3188	\$3367	\$3686	\$4129	N.A.	N.A.	N.A.
	Seat	N.A.	N.A.	+\$306	+\$405	+\$424	+\$457	+\$555	+\$619	+\$692	+\$744	+\$835	+\$961	+\$306	+\$1252	+\$1418
	Back	N.A.	N.A.	+\$918	+\$1059	+\$1086	+\$1132	+\$1273	+\$1363	+\$1467	+\$1540	+\$1670	+\$1850	+\$918	+\$2265	+\$2501

Seat Deck: 3.4 yards, Inside Screen: 2 yards, Outside Screen: 2.2 yards, Seat Cushion: 2.6 yards, 57.2 sq ft, Back Cushion: 3.7 yards, 81.4 sq ft

► Specification Information, continued on next page



For Canadian Pricing
 Multiply U.S. Price by the Canadian price factor.
 ► See page 1 for details.

Lagunitas Two-Seat Lounges *continued*

DESIGN TOAN NGUYEN

► Specification Information, continued from previous page

Specification Information

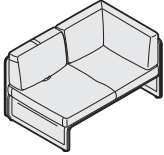

Overall: 59³/₈"W x 34"D x 32³/₈"H
Seat: 16"H

Tip: Handedness is determined while in the seated position. Illustration above shows left-hand lounge.

Style Number	U.S. Base Prices												Leather Grades:		
	Knit Grade 1	Knit Grade 2	Fabric Grades: COM	6	7	8	9	10	11	12	13	14	COL	C	E

Two-Seat Lounge with One Corner Cushion and One Articulating Back, Low-Back, Left or Right Screen

COLAGLL2	Screen and Seat Deck	\$2244	\$2603	\$2474	\$2906	\$2988	\$3129	\$3557	\$3833	\$4152	\$4375	\$4771	\$5321	N.A.	N.A.	N.A.
	Seat	N.A.	N.A.	+\$306	+\$405	+\$424	+\$457	+\$555	+\$619	+\$692	+\$744	+\$835	+\$961	+\$306	+\$1252	+\$1418
	Back	N.A.	N.A.	+\$918	+\$1097	+\$1132	+\$1190	+\$1368	+\$1483	+\$1616	+\$1709	+\$1873	+\$2102	+\$918	+\$2629	+\$2929

Arm: 0, Seat Deck: 2.7 yards, Inside Screen: 3.5 yards, Outside Screen: 3.9 yards, Seat Cushion: 2.6 yards, 57.2 sq ft, Back Cushion: 4.7 yards, 103.4 sq ft

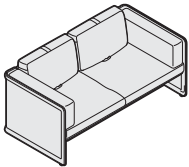

Overall: 67³/₄"W x 34"D x 32³/₈"H
Seat: 16"H

Tip: Must specify articulating backs to obtain configuration above.

Style Number	U.S. Base Prices												Leather Grades:		
	Knit Grade 1	Knit Grade 2	Fabric Grades: COM	6	7	8	9	10	11	12	13	14	COL	C	E

Two-Seat Lounge with Two Articulating Backs and End Arm Cushions, Low-Back, Left and Right Screens

COLAGLL2	Screen and Seat Deck	\$2805	\$3292	\$3111	\$3650	\$3753	\$3927	\$4462	\$4806	\$5205	\$5483	\$5978	\$6663	N.A.	N.A.	N.A.
	Seat	N.A.	N.A.	+\$306	+\$417	+\$438	+\$474	+\$584	+\$655	+\$737	+\$794	+\$895	+\$1037	+\$306	+\$1362	+\$1546
	Back	N.A.	N.A.	+\$918	+\$1181	+\$1232	+\$1318	+\$1579	+\$1747	+\$1943	+\$2079	+\$2320	+\$2656	+\$918	+\$3430	+\$3870

Arm: 0, Seat Deck: 1.6 yards, Inside Screen: 4.9 yards, Outside Screen: 5.6 yards, Seat Cushion: 2.9 yards, 63.8 sq ft, Back Cushion: 6.9 yards, 151.8 sq ft

► Specification Information, continued on next page



For Canadian Pricing
 Multiply U.S. Price by the Canadian price factor.
 ► See page 1 for details.

Lagunitas Two-Seat Lounges

DESIGN TOAN NGUYEN

► Specification Information, continued from previous page

Specification Information

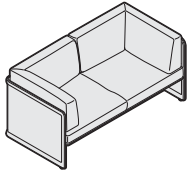

Overall: 67³/₄"W x 34"D x 32³/₈"H
Seat: 16"H

Style Number	U.S. Base Prices												Leather Grades:		
	Knit Grade 1	Knit Grade 2	Fabric Grades: COM	6	7	8	9	10	11	12	13	14	COL	C	E

Two-Seat Lounge with Two Corner Cushions, Low-Back, Left and Right Screens

COLAGLL2	Screen and Seat Deck	\$2805	\$3292	\$ 3111	\$ 3650	\$ 3753	\$ 3927	\$ 4462	\$ 4806	\$ 5205	\$ 5483	\$ 5978	\$ 6663	N.A.	N.A.	N.A.
	Seat	N.A.	N.A.	+\$306	+\$ 417	+\$ 438	+\$ 474	+\$ 584	+\$ 655	+\$ 737	+\$ 794	+\$ 895	+\$1037	+\$306	+\$1362	+\$1546
	Back	N.A.	N.A.	+\$ 918	+\$ 1181	+\$ 1232	+\$1318	+\$1579	+\$1747	+\$1943	+\$2079	+\$2320	+\$2656	+\$918	+\$3430	+\$3870

Arm: 0, Seat Deck: 1.6 yards, Inside Screen: 4.9 yards, Outside Screen: 5.6 yards, Seat Cushion: 2.9 yards, 63.8 sq ft, Back Cushion: 6.9 yards, 151.8 sq ft

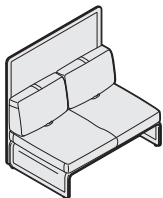

Overall: 51¹/₄"W x 34"D x 50"H
Inside (Lounge): 51¹/₄"W x 22¹/₂"D
Inside (Task): 51¹/₄"W x 17³/₄"D
Seat: 16"H

Style Number	U.S. Base Prices												Leather Grades:		
	Knit Grade 1	Knit Grade 2	Fabric Grades: COM	6	7	8	9	10	11	12	13	14	COL	C	E

Two-Seat Lounge with Two Articulating Backs, High-Back Screen

COLAGLH2	Screen and Seat Deck	\$2295	\$2552	\$ 2474	\$ 2823	\$ 2889	\$ 3001	\$ 3346	\$ 3569	\$ 3826	\$ 4005	\$ 4324	\$ 4767	N.A.	N.A.	N.A.
	Seat	N.A.	N.A.	+\$306	+\$ 405	+\$ 424	+\$ 457	+\$ 555	+\$ 619	+\$ 692	+\$ 744	+\$ 835	+\$ 961	+\$306	+\$1252	+\$1418
	Back	N.A.	N.A.	+\$ 918	+\$1059	+\$1086	+\$1132	+\$1273	+\$1363	+\$1467	+\$1540	+\$1670	+\$1850	+\$918	+\$2265	+\$2501

Seat Deck: 3.4 yards, Inside Screen: 2 yards, Outside Screen: 2.2 yards, Seat Cushion: 2.6 yards, 57.2 sq ft, Back Cushion: 3.7 yards, 81.4 sq ft

► Specification Information, continued on next page

 **For Canadian Pricing**
 Multiply U.S. Price by the Canadian price factor.
 ► See page 1 for details.

Lagunitas Two-Seat Lounges *continued*

DESIGN TOAN NGUYEN

► Specification Information, continued from previous page

Specification Information

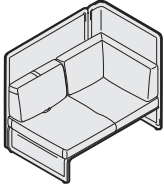

Overall: 59¾"W x 34"D x 50"H
Seat: 16"H

Tip: Handedness is determined while in the seated position. Illustration above shows left-hand lounge.

Style Number	U.S. Base Prices												Leather Grades:		
	Knit Grade 1	Knit Grade 2	Fabric Grades: COM	6	7	8	9	10	11	12	13	14	COL	C	E

Two-Seat Lounge with One Corner Cushion and One Articulating Back, High-Back, Left or Right Screen

COLAGLH2	Screen and Seat Deck	\$3213	\$3624	\$3494	\$ 3926	\$ 4008	\$ 4149	\$ 4577	\$ 4853	\$ 5172	\$ 5395	\$ 5791	\$ 6341	N.A.	N.A.	N.A.
	Seat	N.A.	N.A.	+\$306	+\$ 405	+\$ 424	+\$ 457	+\$ 555	+\$ 619	+\$ 692	+\$ 744	+\$ 835	+\$ 961	+\$306	+\$1252	+\$1418
	Back	N.A.	N.A.	+\$ 918	+\$1097	+\$ 1132	+\$1190	+\$1368	+\$1483	+\$ 1616	+\$1709	+\$1873	+\$ 2102	+\$918	+\$2629	+\$2929

Arm., Seat Deck: 2.7 yards, Inside Screen: 3.5 yards, Outside Screen: 3.9 yards, Seat Cushion: 2.6 yards, 57.2 sq ft, Back Cushion: 4.7 yards, 103.4 sq ft

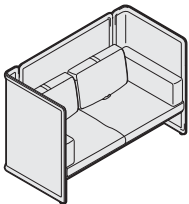

Overall: 67¾"W x 34"D x 50"H
Seat: 16"H

Tip: Must specify articulating backs to obtain configuration above.

Style Number	U.S. Base Prices												Leather Grades:		
	Knit Grade 1	Knit Grade 2	Fabric Grades: COM	6	7	8	9	10	11	12	13	14	COL	C	E

Two-Seat Lounge with Two Articulating Backs and End Arm Cushions, High-Back, Left and Right Screens

COLAGLH2	Screen and Seat Deck	\$4131	\$4695	\$4514	\$ 5053	\$ 5156	\$ 5330	\$ 5865	\$ 6209	\$ 6608	\$ 6886	\$ 7381	\$ 8066	N.A.	N.A.	N.A.
	Seat	N.A.	N.A.	+\$306	+\$ 417	+\$ 438	+\$ 474	+\$ 584	+\$ 655	+\$ 737	+\$ 794	+\$ 895	+\$ 1037	+\$306	+\$1362	+\$1546
	Back	N.A.	N.A.	+\$918	+\$ 1181	+\$1232	+\$1318	+\$1579	+\$ 1747	+\$ 1943	+\$2079	+\$2320	+\$2656	+\$918	+\$3430	+\$3870

Arm: 0, Seat Deck: 1.6 yards, Inside Screen: 4.9 yards, Outside Screen: 5.6 yards, Seat Cushion: 2.9 yards, 63.8 sq ft, Back Cushion: 6.9 yards, 151.8 sq ft

► Specification Information, continued on next page

Lagunitas Two-Seat Lounges

DESIGN TOAN NGUYEN

► Specification Information, continued from previous page

Specification Information

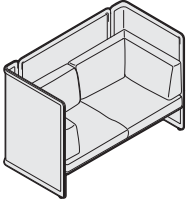

Overall: 67³/₄"W x 34"D x 50"H
Seat: 16"H

Style Number

U.S. Base Prices

Knit Grade 1	Knit Grade 2	Fabric Grades:										Leather Grades:		
		COM	6	7	8	9	10	11	12	13	14	COL	C	E

Two-Seat Lounge with Two Corner Cushions, High-Back, Left and Right Screens

Style Number	Description	Grade 1	Grade 2	COM	6	7	8	9	10	11	12	13	14	COL	C	E
COLAGLH2	Screen and Seat Deck	\$4131	\$4695	\$4514	\$5053	\$ 5156	\$5330	\$ 5865	\$ 6209	\$ 6608	\$ 6886	\$ 7381	\$ 8066	N.A.	N.A.	N.A.
	Seat	N.A.	N.A.	+\$306	+\$ 417	+\$ 438	+\$ 474	+\$ 584	+\$ 655	+\$ 737	+\$ 794	+\$ 895	+\$ 1037	+\$306	+\$1362	+\$1546
	Back	N.A.	N.A.	+\$918	+\$1181	+\$1232	+\$1318	+\$1579	+\$ 1747	+\$1943	+\$2079	+\$2320	+\$2656	+\$918	+\$3430	+\$3870

Arm: 0, Seat Deck: 1.6 yards, Inside Screen: 4.9 yards, Outside Screen: 5.6 yards, Seat Cushion: 2.9 yards, 63.8 sq ft, Back Cushion: 6.9 yards, 151.8 sq ft

Lounge Seating



For Canadian Pricing
 Multiply U.S. Price by the
 Canadian price factor.
 ► See page 1 for details.

Lagunitas Three-Seat Lounges

DESIGN TOAN NGUYEN

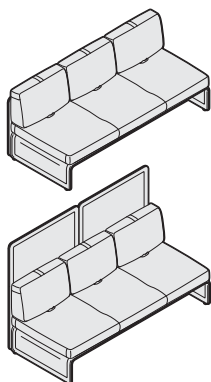

Standard Includes		Required to Specify
<ul style="list-style-type: none"> ▶ Need help? Product details, page 154 • Seat deck and screen: grade 1 knit or fabric • Seat, articulating back cushion, back corner cushion, and end arm cushions, if selected: fabric or leather • Bracket: 4710 Low Gloss Black or 4141 Platinum Matte paint • Eight adjustable glides • Ships assembled 	<ol style="list-style-type: none"> 1 Style number 2 Left- or right-hand configuration, if selected (see below under Required Selections) 3 Knit color number for screen and seat deck, if selected 4 Fabric color number for non-contrasting screen (includes inside and outside) and seat deck, if selected 5 Fabric color number for contrasting outside screen (same family as outside screen), if selected 6 Fabric color number for contrasting inside screen (same family as outside screen), if selected 7 Seat deck to match inside or outside screen, if contrasting screen is selected 8 Fabric or leather color number for non-contrasting seat and back cushion, if selected 9 Fabric or leather color number for contrasting seat cushion, if selected 10 Fabric or leather color number for contrasting back cushion, if selected 11 Paint color number for bracket 12 Options, if selected (see below) 	<ul style="list-style-type: none"> ▶ See <i>Coalesse Surface Materials Reference Guide</i>.

	Required Selections	U.S. Price	Required to Specify
Handedness	• Left-hand, three-screen lounges only (seated position)	No cost	Specify <i>left-hand configuration</i> .
	• Right-hand, three-screen lounges only (seated position)	No cost	Specify <i>right-hand configuration</i> .

	Options	U.S. Price	Required to Specify
Surface Materials	• Contrasting fabric for screen	+\$118	Specify <i>with contrasting fabric</i> and select fabric or leather color number.
	• Contrasting fabric for cushion	+\$118	Specify <i>with contrasting fabric</i> and select fabric or leather color number. ▶ See <i>Coalesse Surface Materials Reference Guide</i> .

Fire code seating

• Three-seat lounge with low- or high-back screen	+\$600	Specify <i>with fire code seating</i> . ▶ See <i>Coalesse Surface Materials Reference Guide</i> .
---	--------	--

Acrylic backer

• Three-seat lounge with one low-back screen	+\$ 71	Specify <i>with acrylic backer</i> .
• Three-seat lounge with one low-back screen, one right- or left-hand screen	+\$107	Specify <i>with acrylic backer</i> .
• Three-seat lounge with one low-back screen, one right- and one left-hand screen	+\$144	Specify <i>with acrylic backer</i> .
• Three-seat lounge with one high-back screen	+\$123	Specify <i>with acrylic backer</i> .
• Three-seat lounge with one high-back screen, one right- or left-hand screen	+\$159	Specify <i>with acrylic backer</i> .
• Three-seat lounge with one high-back screen, one right- and one left-hand screen	+\$196	Specify <i>with acrylic backer</i> . ▶ See <i>Coalesse Surface Materials Reference Guide</i> .

▶ Options, continued on next page

Tip: For Customer's Own Material or Leather, see necessary requirements, important processing instructions and ordering information.

▶ See *Coalesse Surface Materials Reference Guide*.

Tip: Fire code seating is not available on chairs with contrasting fabric.



For Canadian Pricing
Multiply U.S. Price by the Canadian price factor.

▶ See page 1 for details.

Lagunitas Three-Seat Lounges

DESIGN TOAN NGUYEN

Tip: For any portion of the product that requires a COM, the additional \$150 upcharge is a one time charge per product.

Tip: For any portion of the product that requires a COL, the additional \$274 upcharge is a one time charge per product.

Tip: Must combine seat deck and list screen pricing choice (knit grade 1, knit grade 2, or fabric) from either non-contrasting or contrasting pricing list with seat and back cushion list pricing (fabric and leather) from either non-contrasting or contrasting pricing list to obtain completed list price.

► Options, continued from previous page

	Options	U.S. Price	Required to Specify
Surface Materials, continued	• COM	+\$150	Specify with COM and select fabric color number. ► See Coalesse Surface Materials Reference Guide.
	• COL	+\$274	Specify with COL and select leather color number. ► See Coalesse Surface Materials Reference Guide.
Power	• One power module in 4710 Black paint	+\$306	Specify with one power module.
	• Two power modules in 4710 Black paint	+\$612	Specify with two power modules.
Related Products	<ul style="list-style-type: none"> • Bench • Chaise • Work Tables • Occasional Tables • Personal Table • Alignment Connector 		<ul style="list-style-type: none"> ► Page 194 ► Page 190 ► Page 197 ► Page 198 ► Page 199 ► Page 196

Lounge Seating

Specification Information

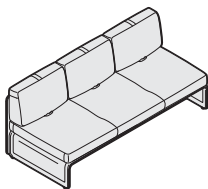

Overall: 76¾"W x 34"D x 32¾"H
Inside (Lounge): 76¾"W x 22½"D
Inside (Task): 76¾"W x 17¾"D
Seat: 16"H

Style Number	U.S. Base Prices														Leather Grades:		
	Knit		Fabric Grades:			6	7	8	9	10	11	12	13	14	COL	C	E
	Grade 1	Grade 2	COM														

Three-Seat Lounge with Three Articulating Backs, Low-Back Screen

COLAGLL3	Screen and Seat Deck	\$2193	\$2475	\$ 2423	\$ 2877	\$ 2965	\$ 3113	\$ 3563	\$ 3853	\$ 4191	\$4425	\$ 4842	\$ 5422	N.A.	N.A.	N.A.
	Seat	N.A.	N.A.	+\$ 408	+\$ 545	+\$ 572	+\$ 616	+\$ 752	+\$ 841	+\$ 943	+\$1014	+\$ 1140	+\$ 1315	+\$ 408	+\$1719	+\$1949
	Back	N.A.	N.A.	+\$1377	+\$1587	+\$1627	+\$1696	+\$1904	+\$2038	+\$2194	+\$2303	+\$2495	+\$2763	+\$1377	+\$3379	+\$3730

Seat Deck: 3.6 yards, Inside Screen: 3.2 yards, Outside Screen: 3.7 yards, Seat Cushion: 3.6 yards, 79.2 sq ft, Back Cushion: 5.5 yards, 121 sq ft

► Specification Information, continued on next page

 **For Canadian Pricing**
 Multiply U.S. Price by the Canadian price factor.
 ► See page 1 for details.

Lagunitas Three-Seat Lounges *continued*

DESIGN TOAN NGUYEN

► Specification Information, continued from previous page

Specification Information

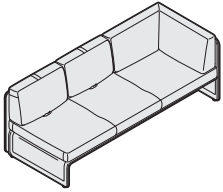

Overall: 85"W x 34"D x 32³/₈"H
Seat: 16"H

Tip: Handedness is determined while in the seated position. Illustration above shows left-hand lounge.

Style Number	U.S. Base Prices														Leather Grades:		
	Knit Grade 1	Knit Grade 2	Fabric Grades: COM	6	7	8	9	10	11	12	13	14	COL	C	E		

Three-Seat Lounge with One Corner Cushion and Two Articulating Backs, Low-Back, Left or Right Screen

COLAGLL3	Screen and Seat Deck	\$2754	\$3190	\$ 3060	\$ 3616	\$ 3724	\$ 3905	\$ 4458	\$ 4815	\$ 5230	\$ 5517	\$ 6028	\$ 6739	N.A.	N.A.	N.A.
	Seat	N.A.	N.A.	+\$ 408	+\$ 538	+\$ 563	+\$ 605	+\$ 734	+\$ 817	+\$ 913	+\$ 980	+\$1099	+\$ 1265	+\$ 408	+\$1646	+\$1862
	Back	N.A.	N.A.	+\$1377	+\$1625	+\$1673	+\$1753	+\$1999	+\$2158	+\$2343	+\$2471	+\$2698	+\$3015	+\$1377	+\$3743	+\$4158

Arm: 0, Seat Deck: 2.3 yards, Inside Screen: 4.6 yards, Outside Screen: 5.4 yards, Seat Cushion: 3.4 yards, 74.8 sq ft, Back Cushion: 6.5 yards, 143 sq ft

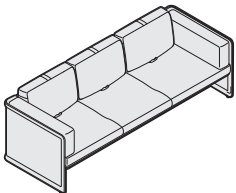

Overall: 93¹/₄"W x 34"D x 32³/₈"H | Hj196
Seat: 16"H

Tip: Must specify articulating backs to obtain configuration above.

Style Number	U.S. Base Prices														Leather Grades:		
	Knit Grade 1	Knit Grade 2	Fabric Grades: COM	6	7	8	9	10	11	12	13	14	COL	C	E		

Three-Seat Lounge with Three Articulating Backs and End Arm Cushions, Low-Back, Left and Right Screens

COLAGLL3	Screen and Seat Deck	\$3315	\$3904	\$ 3698	\$ 4348	\$ 4472	\$ 4683	\$ 5325	\$ 5742	\$ 6223	\$ 6558	\$ 7153	\$ 7982	N.A.	N.A.	N.A.
	Seat	N.A.	N.A.	+\$ 408	+\$ 545	+\$ 572	+\$ 616	+\$ 752	+\$ 841	+\$ 943	+\$1014	+\$1140	+\$ 1315	+\$ 408	+\$1719	+\$1949
	Back	N.A.	N.A.	+\$1377	+\$1709	+\$1773	+\$1880	+\$2210	+\$2423	+\$2670	+\$2841	+\$3145	+\$3569	+\$1377	+\$4544	+\$5099

Arm: 0, Seat Deck: 2 yards, Inside Screen: 6.1 yards, Outside Screen: 7.1 yards, Seat Cushion: 3.6 yards, 79.2 sq ft, Back Cushion: 8.7 yards, 191.4 sq ft

► Specification Information, continued on next page

Lagunitas Three-Seat Lounges

DESIGN TOAN NGUYEN

► Specification Information, continued from previous page

Specification Information

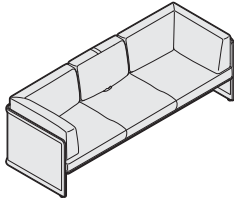

Overall: 93¼"W x 34"D x 32¾"H
Seat: 16"H

Style Number	U.S. Base Prices												Leather Grades:		
	Knit Grade 1	Knit Grade 2	Fabric Grades:										COL	C	E
			COM	6	7	8	9	10	11	12	13	14			

Three-Seat Lounge with Two Corner Cushions and One Middle Articulating Back, Low-Back, Left and Right Screens

COLAGLL3	Screen and Seat Deck	\$3315	\$3904	\$ 3698	\$ 4348	\$ 4472	\$ 4683	\$ 5325	\$ 5742	\$ 6223	\$ 6558	\$ 7153	\$ 7982	N.A.	N.A.	N.A.
	Seat	N.A.	N.A.	+\$ 408	+\$ 545	+\$ 572	+\$ 616	+\$ 752	+\$ 841	+\$ 943	+\$ 1014	+\$ 1140	+\$ 1315	+\$ 408	+\$1719	+\$1949
	Back	N.A.	N.A.	+\$1377	+\$1709	+\$1773	+\$1880	+\$2210	+\$ 2423	+\$2670	+\$ 2841	+\$3145	+\$3569	+\$1377	+\$4544	+\$5099

Arm., Seat Deck: 2 yards, Inside Screen: 6.1 yards, Outside Screen: 7.1 yards, Seat Cushion: 3.6 yards, 79.2 sq ft, Back Cushion: 8.7 yards, 191.4 sq ft

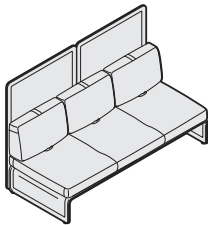

Overall: 76⅞"W x 34"D x 50"H
Inside (Lounge): 76⅞"W x 22½"D
Inside (Task): 76⅞"W x 17¾"D
Seat: 16"H

Style Number	U.S. Base Prices												Leather Grades:		
	Knit Grade 1	Knit Grade 2	Fabric Grades:										COL	C	E
			COM	6	7	8	9	10	11	12	13	14			

Three-Seat Lounge with Three Articulating Backs, High-Back Screen

COLAGLH3	Screen and Seat Deck	\$3009	\$3316	\$ 3239	\$ 3693	\$ 3781	\$ 3929	\$ 4379	\$ 4669	\$ 5007	\$ 5241	\$ 5658	\$ 6238	N.A.	N.A.	N.A.
	Seat	N.A.	N.A.	+\$ 408	+\$ 545	+\$ 572	+\$ 616	+\$ 752	+\$ 841	+\$ 943	+\$ 1014	+\$ 1140	+\$ 1315	+\$ 408	+\$1719	+\$1949
	Back	N.A.	N.A.	+\$1377	+\$1587	+\$1627	+\$1696	+\$1904	+\$2038	+\$ 2194	+\$2303	+\$2495	+\$2763	+\$1377	+\$3379	+\$3730

Seat Deck: 3.6 yards, Inside Screen: 3.2 yards, Outside Screen: 3.7 yards, Seat Cushion: 3.6 yards, 79.2 sq ft, Back Cushion: 5.5 yards, 121 sq ft

► Specification Information, continued on next page



For Canadian Pricing
Multiply U.S. Price by the Canadian price factor.
► See page 1 for details.

Lagunitas Three-Seat Lounges *continued*

DESIGN TOAN NGUYEN

► Specification Information, continued from previous page

Specification Information

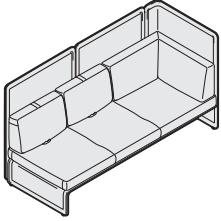

Overall: 85"W x 34½"D x 50"H
Seat: 16"H

Tip: Handedness is determined while in the seated position. Illustration above shows left-hand lounge.

Style Number	U.S. Base Prices														Leather Grades:		
	Knit Grade 1	Knit Grade 2	Fabric Grades: COM	6	7	8	9	10	11	12	13	14	COL	C	E		

Three-Seat Lounge with One Corner Cushion and Two Articulating Backs, High-Back, Left or Right Screen

COLAGLH3	Screen and Seat Deck	\$3927	\$4414	\$ 4259	\$ 4815	\$ 4923	\$ 5104	\$ 5657	\$ 6014	\$ 6429	\$ 6716	\$ 7227	\$ 7938	N.A.	N.A.	N.A.
	Seat	N.A.	N.A.	+\$ 408	+\$ 538	+\$ 563	+\$ 605	+\$ 734	+\$ 817	+\$ 913	+\$ 980	+\$1099	+\$ 1265	+\$ 408	+\$1646	+\$1862
	Back	N.A.	N.A.	+\$1377	+\$1625	+\$1673	+\$ 1753	+\$ 1999	+\$ 2158	+\$2343	+\$ 2471	+\$2698	+\$ 3015	+\$1377	+\$3743	+\$4158

Arm., Seat Deck: 2.3 yards, Inside Screen: 4.6 yards, Outside Screen: 5.4 yards, Seat Cushion: 3.4 yards, 74.8 sq ft, Back Cushion: 6.5 yards, 143 sq ft

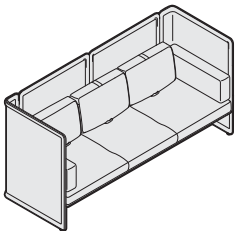

Overall: 93¾"W x 34"D x 50"H
Seat: 16"H

Tip: Must specify articulating backs to obtain configuration above.

Style Number	U.S. Base Prices														Leather Grades:		
	Knit Grade 1	Knit Grade 2	Fabric Grades: COM	6	7	8	9	10	11	12	13	14	COL	C	E		

Three-Seat Lounge with Three Articulating Backs and End Arm Cushions, High-Back, Left and Right Screens

COLAGLH3	Screen and Seat Deck	\$4845	\$5511	\$ 5279	\$ 5929	\$ 6053	\$ 6264	\$ 6906	\$ 7323	\$ 7804	\$ 8139	\$ 8734	\$ 9563	N.A.	N.A.	N.A.
	Seat	N.A.	N.A.	+\$ 408	+\$ 545	+\$ 572	+\$ 616	+\$ 752	+\$ 841	+\$ 943	+\$ 1014	+\$ 1140	+\$ 1315	+\$ 408	+\$1719	+\$1949
	Back	N.A.	N.A.	+\$1377	+\$1709	+\$1773	+\$1880	+\$2210	+\$2423	+\$2670	+\$2841	+\$3145	+\$3569	+\$1377	+\$4544	+\$5099

Arm., Seat Deck: 2 yards, Inside Screen: 6.1 yards, Outside Screen: 7.1 yards, Seat Cushion: 3.6 yards, 79.2 sq ft, Back Cushion: 8.7 yards, 191.4 sq ft

► Specification Information, continued on next page

Lagunitas Three-Seat Lounges

DESIGN TOAN NGUYEN

► Specification Information, continued from previous page

Specification Information

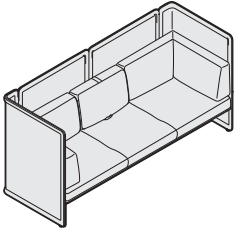

Overall: 93³/₈"W x 34"D x 32³/₈"H

Seat: 16"H

Style
Number

U.S. Base Prices

Knit	Knit	Fabric Grades:											Leather Grades:		
Grade 1	Grade 2	COM	6	7	8	9	10	11	12	13	14	COL	C	E	

Three-Seat Lounge with Two Corner Cushions and One Middle Articulating Back, High-Back, Left and Right Screens

COLAGLH3	Screen and Seat Deck	\$4845	\$5511	\$ 5279	\$ 5929	\$ 6053	\$ 6264	\$ 6906	\$ 7323	\$ 7804	\$ 8139	\$ 8734	\$ 9563	N.A.	N.A.	N.A.
	Seat	N.A.	N.A.	+\$ 408	+\$ 545	+\$ 572	+\$ 616	+\$ 752	+\$ 841	+\$ 943	+\$1014	+\$ 1140	+\$ 1315	+\$ 408	+\$1719	+\$1949
	Back	N.A.	N.A.	+\$1377	+\$1709	+\$1773	+\$1880	+\$2210	+\$2423	+\$2670	+\$2841	+\$3145	+\$3569	+\$1377	+\$4544	+\$5099

Arm., Seat Deck: 2 yards, Inside Screen: 6.1 yards Outside Screen: 7.1 yards, Seat Cushion: 3.6 yards, 79.2 sq ft, Back Cushion: 8.7 yards, 191.4 sq ft

Lounge Seating



For Canadian Pricing
Multiply U.S. Price by the
Canadian price factor.
► See page 1 for details.

Lagunitas Two-Seat Chaises

DESIGN TOAN NGUYEN

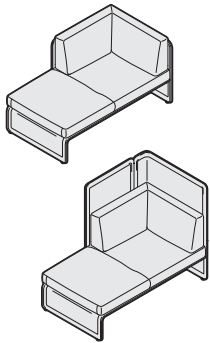

► Need help?
Product details,
page 154

Standard Includes

- Seat deck and screen: grade 1 knit or fabric
- Seat and back corner cushion: fabric or leather
- Bracket: 4710 Low Gloss Black or 4141 Platinum Matte Paint
- Six adjustable glides
- Ships assembled

Required to Specify

- 1 Style number
 - 2 Left- or right-hand configuration (see below under Required Selections)
 - 3 Knit color number for screen and seat deck, if selected
 - 4 Fabric color number for non-contrasting screen (includes inside and outside) and seat deck, if selected
 - 5 Fabric color number for contrasting outside screen (same family as outside screen), if selected
 - 6 Fabric color number for contrasting inside screen (same family as outside screen), if selected
 - 7 Seat deck to match inside or outside screen, if contrasting screen is selected
 - 8 Fabric or leather color number for non-contrasting seat and back cushion, if selected
 - 9 Fabric or leather color number for contrasting seat cushion, if selected
 - 10 Fabric or leather color number for contrasting back cushion, if selected
 - 11 Paint color number for bracket
 - 12 Options, if selected (see below)
- See *Coalesse Surface Materials Reference Guide*.

Tip: Handedness is determined while in the seated position. Illustration above shows left-hand chaise.

	Required Selections	U.S. Price	Required to Specify
Handedness	• Left-hand, two-screen chaises only (seated position)	No cost	Specify <i>left-hand configuration</i> .
	• Right-hand, two-screen chaises only (seated position)	No cost	Specify <i>right-hand configuration</i> .

Tip: For Customer's Own Material or Leather, see necessary requirements, important processing instructions and ordering information.

► See *Coalesse Surface Materials Reference Guide*.

Tip: Fire code seating is not available on chairs with contrasting fabric.

Tip: For any portion of the product that requires a COM, the additional \$150 upcharge is a one time charge per product.

Tip: For any portion of the product that requires a COL, the additional \$274 upcharge is a one time charge per product.

Tip: Must combine seat deck and list screen pricing choice (knit grade 1, knit grade 2, or fabric) from either non-contrasting or contrasting pricing list with seat and back cushion list pricing (fabric and leather) from either non-contrasting or contrasting pricing list to obtain completed list price.

	Options	U.S. Price	Required to Specify
Surface Materials	• Contrasting fabric for screen	+\$118	Specify <i>with contrasting fabric</i> and select fabric or leather color number.
	• Contrasting fabric for cushion	+\$118	Specify <i>with contrasting fabric</i> and select fabric or leather color number. ► See <i>Coalesse Surface Materials Reference Guide</i> .
Fire code seating			
	• Two-seat chaise with low- or high-back screen	+\$461	Specify <i>with fire code seating</i> . ► See <i>Coalesse Surface Materials Reference Guide</i> .
Acrylic backer			
	• Two-seat chaise with one low-back screen and one right- or one left-hand screen	+\$ 68	Specify <i>with acrylic backer</i> .
	• Two-seat chaise with one high-back screen and one right- or one left-hand screen	+\$101	Specify <i>with acrylic backer</i> . ► See <i>Coalesse Surface Materials Reference Guide</i> .
	• COM	+\$150	Specify <i>with COM</i> and select fabric color number. ► See <i>Coalesse Surface Materials Reference Guide</i> .
	• COL	+\$274	Specify <i>with COL</i> and select leather color number. ► See <i>Coalesse Surface Materials Reference Guide</i> .

► Options, continued on next page

Lagunitas Two-Seat Chaises

DESIGN TOAN NGUYEN

► Options, continued from previous page

Options	U.S. Price	Required to Specify
Power	<ul style="list-style-type: none"> • One power module in 4710 black paint +\$306 • Two power modules in 4710 Black paint +\$612 	<p>Specify with one power module.</p> <p>Specify with two power modules.</p>
Related Products	<ul style="list-style-type: none"> • Lounge • Bench • Work Tables • Occasional Tables • Personal Table • Alignment Connector 	<ul style="list-style-type: none"> ► Page 174 ► Page 194 ► Page 197 ► Page 198 ► Page 199 ► Page 196

Specification Information

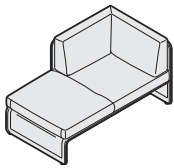

Tip: Handedness is determined while in the seated position. Illustration above shows left-hand chaise.

Overall: 59³/₈"W x 34"D x 32³/₈"H
Seat: 16"H

Style Number	U.S. Base Prices														Leather Grades:		
	Knit Grade 1	Knit Grade 2	Fabric Grades: COM	6	7	8	9	10	11	12	13	14	COL	C	E		

Two-Seat Chaise with Corner Cushion, Low-Back, Left or Right Screen

COLAGCL2	Screen and Seat Deck	\$2142	\$2501	\$2372	\$2743	\$2814	\$2935	\$3301	\$3539	\$3813	\$4004	\$ 4343	\$ 4817	N.A.	N.A.	N.A.
	Seat	N.A.	N.A.	+\$306	+\$420	+\$442	+\$478	+\$592	+\$665	+\$750	+\$808	+\$ 913	+\$1058	+\$306	+\$1392	+\$1583
	Back	N.A.	N.A.	+\$459	+\$570	+\$591	+\$627	+\$737	+\$808	+\$890	+\$947	+\$1048	+\$1190	+\$459	+\$1515	+\$1699

Arm: 0, Seat Deck: 2.7 yards, Inside Screen: 2.7 yards, Outside Screen: 3.2 yards, Seat Cushion: 3 yards, 66 sq ft, Back Cushion: 2.9 yards, 63.8 sq ft

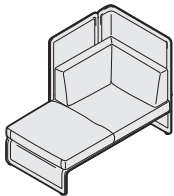

Tip: Handedness is determined while in the seated position. Illustration above shows left-hand chaise.

Overall: 59³/₈"W x 34"D x 50"H
Seat: 16"H

Style Number	U.S. Base Prices														Leather Grades:		
	Knit Grade 1	Knit Grade 2	Fabric Grades: COM	6	7	8	9	10	11	12	13	14	COL	C	E		

Two-Seat Chaise with Corner Cushion, High-Back, Left or Right Screen

COLAGCH2	Screen and Seat Deck	\$2805	\$3216	\$3086	\$3457	\$3528	\$3649	\$4015	\$4253	\$4527	\$4718	\$ 5057	\$ 5531	N.A.	N.A.	N.A.
	Seat	N.A.	N.A.	+\$306	+\$420	+\$442	+\$478	+\$592	+\$665	+\$750	+\$808	+\$ 913	+\$1058	+\$306	+\$1392	+\$1583
	Back	N.A.	N.A.	+\$459	+\$570	+\$591	+\$627	+\$737	+\$808	+\$890	+\$947	+\$1048	+\$1190	+\$459	+\$1515	+\$1699

Arm: 0, Seat Deck: 2.7 yards, Inside Screen: 2.7 yards, Outside Screen: 3.2 yards, Seat Cushion: 3 yards, 66 sq ft, Back Cushion: 2.9 yards, 63.8 sq ft

Lagunitas Three-Seat Chaises

DESIGN TOAN NGUYEN

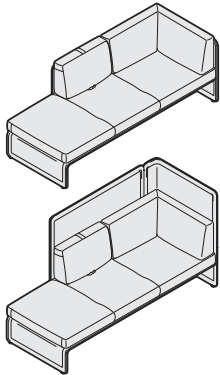

► Need help?
Product details,
page 154

Standard Includes

- Seat deck and screen: grade 1 knit or fabric
- Seat and back corner cushion: fabric or leather
- Bracket: 4710 Low Gloss Black or 4141 Platinum Matte Paint
- Six adjustable glides
- Ships assembled

Required to Specify

- 1 Style number
 - 2 Left- or right-hand configuration (see below under Required Selections)
 - 3 Knit color number for screen and seat deck, if selected
 - 4 Fabric color number for non-contrasting screen (includes inside and outside) and seat deck, if selected
 - 5 Fabric color number for contrasting outside screen (same family as outside screen), if selected
 - 6 Fabric color number for contrasting inside screen (same family as outside screen), if selected
 - 7 Seat deck to match inside or outside screen, if contrasting screen is selected
 - 8 Fabric or leather color number for non-contrasting seat and back cushion, if selected
 - 9 Fabric or leather color number for contrasting seat cushion, if selected
 - 10 Fabric or leather color number for contrasting back cushion, if selected
 - 11 Paint color number for bracket
 - 12 Options, if selected (see below)
- See *Coalesse Surface Materials Reference Guide*.

Tip: Handedness is determined while in the seated position. Illustration above shows left-hand chaise.

Tip: For Customer's Own Material or Leather, see necessary requirements, important processing instructions and ordering information.
► See *Coalesse Surface Materials Reference Guide*.

Tip: Fire code seating is not available on chairs with contrasting fabric.

Tip: For any portion of the product that requires a COM, the additional \$150 upcharge is a one time charge per product.

Tip: For any portion of the product that requires a COL, the additional \$274 upcharge is a one time charge per product.

Tip: Must combine seat deck and list screen pricing choice (knit grade 1, knit grade 2, or fabric) from either non-contrasting or contrasting pricing list with seat and back cushion list pricing (fabric and leather) from either non-contrasting or contrasting pricing list to obtain completed list price.

	Required Selections	U.S. Price	Required to Specify
Handedness	• Left-hand, three-screen chaises only (seated position)	No cost	Specify <i>left-hand configuration</i> .
	• Right-hand, three-screen chaises only (seated position)	No cost	Specify <i>right-hand configuration</i> .

	Options	U.S. Price	Required to Specify
Surface Materials	• Contrasting fabric for screen	+\$118	Specify <i>with contrasting fabric</i> and select fabric or leather color number.
	• Contrasting fabric for cushion	+\$118	Specify <i>with contrasting fabric</i> and select fabric or leather color number. ► See <i>Coalesse Surface Materials Reference Guide</i> .
Fire code seating			
	• Three-seat chaise with low- or high-back screen	+\$600	Specify <i>with fire code seating</i> . ► See <i>Coalesse Surface Materials Reference Guide</i> .
Acrylic backer			
	• Three-seat chaise with one low-back screen and one right- or one left-hand screen	+\$ 89	Specify <i>with acrylic backer</i> .
	• Three-seat chaise with one high-back screen and one right- or one left-hand screen	+\$141	Specify <i>with acrylic backer</i> . ► See <i>Coalesse Surface Materials Reference Guide</i> .
	• COM	+\$150	Specify <i>with COM</i> and select fabric color number. ► See <i>Coalesse Surface Materials Reference Guide</i> .
	• COL	+\$274	Specify <i>with COL</i> and select leather color number. ► See <i>Coalesse Surface Materials Reference Guide</i> .

► Options, continued on next page

Lagunitas Three-Seat Chaises

DESIGN TOAN NGUYEN

►Options, continued from previous page

Options	U.S. Price	Required to Specify
Power		
• One power modules in 4710 Black paint	+\$306	Specify with one power module.
• Two power modules in 4710 black paint	+\$612	Specify with two power modules.
Related Products		
• Lounge		► Page 174
• Bench		► Page 194
• Work Tables		► Page 197
• Occasional Tables		► Page 198
• Personal Table		► Page 199
• Alignment Connector		► Page 196

Specification Information

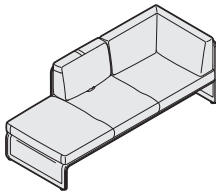

Tip: Handedness is determined while in the seated position. Illustration above shows left-hand chaise.

Overall: 85"W x 34"D x 32³/₈"H
Seat: 16"H

Style Number	U.S. Base Prices														Leather Grades:		
	Knit Grade 1	Knit Grade 2	Fabric Grades: COM	6	7	8	9	10	11	12	13	14	COL	C	E		

Three-Seat Chaise with Corner Cushion and One Articulating Back, Low-Back, Left or Right Screen

COLAGCL3 Screen and Seat Deck	\$2499	\$2935	\$2805	\$3263	\$3351	\$3500	\$3954	\$4248	\$4587	\$4824	\$5245	\$5828	N.A.	N.A.	N.A.
Seat	N.A.	N.A.	+\$408	+\$564	+\$594	+\$645	+\$799	+\$899	+\$1014	+\$1094	+\$1237	+\$1436	+\$408	+\$1893	+\$2153
Back	N.A.	N.A.	+\$918	+\$1097	+\$1132	+\$1190	+\$1368	+\$1483	+\$1616	+\$1709	+\$1873	+\$2102	+\$918	+\$2629	+\$2929

Arm., Seat Deck: 3.7 yards, Inside Screen: 3.5 yards, Outside Screen: 3.9 yards, Seat Cushion: 4.1 yards, 90.2 sq ft, Back Cushion: 4.7 yards, 103.4 sq ft

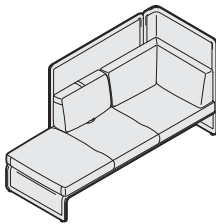

Tip: Handedness is determined while in the seated position. Illustration above shows left-hand chaise.

Overall: 85"W x 34"D x 50"H
Seat: 16"H

Style Number	U.S. Base Prices														Leather Grades:		
	Knit Grade 1	Knit Grade 2	Fabric Grades: COM	6	7	8	9	10	11	12	13	14	COL	C	E		

Three-Seat Chaise with Corner Cushion and One Articulating Back, High-Back, Left or Right Screen

COLAGCH3 Screen and Seat Deck	\$3162	\$3649	\$3494	\$3952	\$4040	\$4189	\$4643	\$4937	\$5276	\$5513	\$5934	\$6517	N.A.	N.A.	N.A.
Seat	N.A.	N.A.	+\$408	+\$564	+\$594	+\$645	+\$799	+\$899	+\$1014	+\$1094	+\$1237	+\$1436	+\$408	+\$1893	+\$2153
Back	N.A.	N.A.	+\$918	+\$1097	+\$1132	+\$1190	+\$1368	+\$1483	+\$1616	+\$1709	+\$1873	+\$2102	+\$918	+\$2629	+\$2929

Arm., Seat Deck: 3.7 yards, Inside Screen: 3.5 yards, Outside Screen: 3.9 yards, Seat Cushion: 4.1 yards, 90.2 sq ft, Back Cushion: 4.7 yards, 103.4 sq ft

Lagunitas Benches

DESIGN TOAN NGUYEN

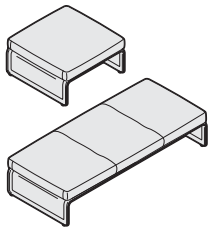

Tip: Fire code seating is not available on chairs with contrasting fabric.

Tip: For Customer's Own Material or Leather, see necessary requirements, important processing instructions and ordering information.
 ▶ See Coalesse Surface Materials Reference Guide.

Tip: For any portion of the product that requires a COM, the additional \$150 upcharge is a one time charge per product.

Tip: For any portion of the product that requires a COL, the additional \$274 upcharge is a one time charge per product.

Tip: Must combine seat deck and list screen pricing choice (knit grade 1, knit grade 2, or fabric) from either non-contrasting or contrasting pricing list with seat and back cushion list pricing (fabric and leather) from either non-contrasting or contrasting pricing list to obtain completed list price.

Standard Includes		Required to Specify	
▶ Need help? Product details, page 154	<ul style="list-style-type: none"> • Seat deck: grade 1 knit or fabric • Seat cushion: fabric or leather • Four adjustable glides • Ships assembled 		1 Style number 2 Knit or fabric color number for seat deck 3 Fabric or leather color number for seat cushion 4 Options, if selected (see below) ▶ See <i>Coalesse Surface Materials Reference Guide</i> .
Options		U.S. Price	Required to Specify
Surface Materials	Fire code seating		Specify with <i>fire code seating</i> .
	• One-seat bench cushion	+\$301	Specify with <i>fire code seating</i> .
	• Two-seat bench cushion	+\$461	Specify with <i>fire code seating</i> .
	• Three-seat bench cushion	+\$600	Specify with <i>fire code seating</i> . ▶ See <i>Coalesse Surface Materials Reference Guide</i> .
	Acrylic backer		Specify with <i>acrylic backer</i> .
	• One-seat bench cushion	+\$ 16	Specify with <i>acrylic backer</i> .
	• Two-seat bench cushion	+\$ 21	Specify with <i>acrylic backer</i> .
	• Three-seat bench cushion	+\$ 27	Specify with <i>acrylic backer</i> . ▶ See <i>Coalesse Surface Materials Reference Guide</i> .
	• COM	+\$150	Specify with <i>COM</i> and select fabric color number. ▶ See <i>Coalesse Surface Materials Reference Guide</i> .
	• COL	+\$274	Specify with <i>COL</i> and select leather color number. ▶ See <i>Coalesse Surface Materials Reference Guide</i> .
Power	One-seat benches		Specify with <i>one power module</i> .
	• One power module in 4710 Black paint	+\$306	
	Two- and Three-seat bench		Specify with <i>one power module</i> .
	• One power module in 4710 Black paint	+\$306	
	• Two power modules in 4710 Black paint	+\$612	Specify with <i>two power modules</i> .
Related Products	• Lounge		▶ Page 174
	• Chaise		▶ Page 190
	• Work Tables		▶ Page 197
	• Occasional Tables		▶ Page 198
	• Personal Table		▶ Page 199

 **For Canadian Pricing**
 Multiply U.S. Price by the Canadian price factor.
 ▶ See page 1 for details.

Lagunitas Benches

DESIGN TOAN NGUYEN

Specification Information

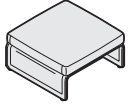

Overall: 32³/₄"W x 32³/₄"D x 16"H
Seat Deck: 2.8 yards
Seat Cushion: 2.6 yards, 57.2 sq ft

Style Number	U.S. Base Prices												Leather Grades:			
	Knit Grade 1	Knit Grade 2	Fabric Grades:			6	7	8	9	10	11	12	13	14	COL	C

One-Seat Bench

COLAGB1	Seat Deck	\$ 816	\$ 893	\$ 918	\$1067	\$1095	\$1144	\$1291	\$1386	\$1497	\$ 1574	\$ 1710	\$ 1901	N.A.	N.A.	N.A.
	Seat Cushion	N.A.	N.A.	+\$204	+\$303	+\$322	+\$355	+\$453	+\$517	+\$590	+\$ 642	+\$ 733	+\$ 859	+\$204	+\$1150	+\$1316

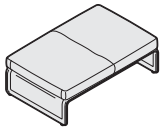

Overall: 51¹/₄"W x 32³/₄"D x 16"H
Seat Deck: 3.1 yards
Seat Cushion: 3.2 yards, 70.4 sq ft

Two-Seat Bench

COLAGB2	Seat Deck	\$1123	\$1226	\$1224	\$1384	\$1415	\$1467	\$1626	\$1729	\$1848	\$ 1930	\$ 2078	\$ 2282	N.A.	N.A.	N.A.
	Seat Cushion	N.A.	N.A.	+\$306	+\$428	+\$452	+\$492	+\$612	+\$690	+\$782	+\$ 844	+\$ 957	+\$ 1113	+\$306	+\$1470	+\$1675

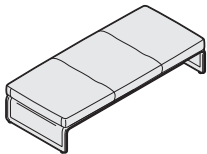

Overall: 76⁷/₈"W x 32³/₄"D x 16"
Seat Deck: 3.5 yards
Seat Cushion: 4 yards, 88 sq ft

Three-Seat Bench

COLAGB3	Seat Deck	\$1428	\$1556	\$1530	\$1705	\$1739	\$1797	\$1971	\$2082	\$ 2214	\$ 2304	\$ 2465	\$ 2689	N.A.	N.A.	N.A.
	Seat Cushion	N.A.	N.A.	+\$408	+\$561	+\$590	+\$640	+\$791	+\$889	+\$1003	+\$1081	+\$1221	+\$1416	+\$408	+\$1865	+\$2120



For Canadian Pricing
 Multiply U.S. Price by the
 Canadian price factor.
 ▶ See page 1 for details.

Alignment Connector



Standard Includes		Required to Specify
▶ Need help? Product details, page 154	<ul style="list-style-type: none">• Screen and seat deck connector package: pin, bracket, and hardware• Ships ready to assemble	Style number

Related Products	
<ul style="list-style-type: none">• Lounge• Chaise	<ul style="list-style-type: none">▶ Page 174▶ Page 190

Specification Information	
Style Number	U.S. Price
COLAGCI	\$41



For Canadian Pricing
Multiply U.S. Price by the
Canadian price factor.
▶ See page 1 for details.

Lagunitas Work Tables

DESIGN TOAN NGUYEN

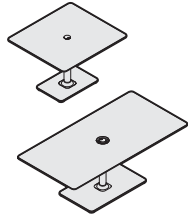

Standard Includes	Required to Specify
<ul style="list-style-type: none"> ▶ Need help? Product details, page 154 • Table top: <ul style="list-style-type: none"> – Grade 1 laminate with 3 mm flat plastic edge – Wood with matching flat wood edge • Base with column: paint • Six non-adjustable glides • Ships ready to assemble 	<ol style="list-style-type: none"> 1 Style number 2 Table top width 3 Laminate or wood color number for table top 4 Plastic edge color number for laminate table top, if selected 5 Paint color number for base with column 6 Options, if selected (see below) <p>▶ See <i>Coalesse Surface Materials Reference Guide</i>.</p>

Options	U.S. Price	Required to Specify
Surface Materials <ul style="list-style-type: none"> • Work table top • Grade 2 laminate • Grade 1 wood veneer • Grade 2 wood veneer • Stain-to-Match 	<ul style="list-style-type: none"> Prices below Prices below Prices below No cost 	<ul style="list-style-type: none"> Specify with <i>Grade 2 laminate</i> and select color number. Specify with <i>Grade 1 wood veneer</i> and select color number. Specify with <i>Grade 2 wood veneer</i> and select color number. Specify with <i>stain-to-match</i>. <p>▶ See <i>Coalesse Surface Materials Reference Guide</i>.</p>

Devices and Grommets	<ul style="list-style-type: none"> • Power module (two receptacles) for 30"W, 36"W, and 40"W work tables • One power module in silver finish (center only) +\$255 	<ul style="list-style-type: none"> Specify with <i>power module</i>.
	<ul style="list-style-type: none"> • 3" metal grommet for all work tables • One metal grommet in anodized silver finish (center only) +\$ 77 	<ul style="list-style-type: none"> Specify with <i>3" metal grommet</i>.
	<ul style="list-style-type: none"> • Power pod grommet for 48"W, 57"W, and 72"W work tables • One Power pod grommet in 6052 Milk or 6000 Black plastic finish (center only) +\$ 51 	<ul style="list-style-type: none"> Specify with <i>power pod grommet</i> and select color number.

Related Products	<ul style="list-style-type: none"> • Lounge • Chaise • Bench 	<ul style="list-style-type: none"> ▶ Page 174 ▶ Page 190 ▶ Page 194
-------------------------	---	--

Tip: Column routes cables and wires when optional power or grommet are selected and exits through the base.

Tip: Devices and grommets are center location only to allow for routing of cords through the column and exits through the base.

Specification Information

Style Number	Dimensions			U.S. Base Prices			
	D	W	H	Flat Vinyl Edge on Laminate Top		Flat Wood Edge on Wood Top	
				Grade 1	Grade 2	Grade 1	Grade 2
COLAGTRECT	24"	30"	26"	\$1525	\$1595	\$2793	\$3016
	24"	36"	26"	\$1627	\$1702	\$2960	\$3154
	36"	40"	26"	\$1729	\$1812	\$3472	\$3700
	36"	48"	26"	\$2137	\$2233	\$3777	\$4047
	36"	57"	26"	\$2239	\$2346	\$3930	\$4215
	36"	72"	26"	\$2596	\$2720	\$4390	\$4697

For Canadian Pricing
 Multiply U.S. Price by the Canadian price factor.
 ▶ See page 1 for details.

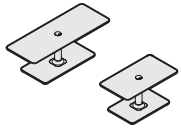

	Standard Includes	Required to Specify
<p>► Need help? Product details, page 154</p>	<ul style="list-style-type: none"> Table top: <ul style="list-style-type: none"> Grade 1 laminate with 3 mm flat plastic edge Wood with matching flat wood edge Base with column: paint Six non-adjustable glides Ships ready to assemble 	<ol style="list-style-type: none"> Style number Table top width Laminate or wood color number for table top Plastic edge color number for laminate table top, if selected Paint color number for base with column Options, if selected (see below) <p>► See <i>Coalesse Surface Materials Reference Guide</i>.</p>

	Options	U.S. Price	Required to Specify
Surface Materials	<p>Table top</p> <ul style="list-style-type: none"> Grade 2 laminate Grade 1 wood veneer Grade 2 wood veneer Stain-to-Match 	<p>Prices below</p> <p>Prices below</p> <p>Prices below</p> <p>No cost</p>	<p>Specify with <i>Grade 2 laminate</i> and select color number.</p> <p>Specify with <i>Grade 1 wood veneer</i> and select color number.</p> <p>Specify with <i>Grade 2 wood veneer</i> and select color number.</p> <p>Specify with <i>stain-to-match</i>.</p> <p>► See <i>Coalesse Surface Materials Reference Guide</i>.</p>
Devices and Grommets	<p>Power module (two receptacles)</p> <ul style="list-style-type: none"> One power module in silver finish (center only) <p>3" metal grommet</p> <ul style="list-style-type: none"> One metal grommet in anodized silver finish (center only) 	<p>+\$255</p> <p>+\$ 77</p>	<p>Specify with <i>power module</i>.</p> <p>Specify with <i>3" metal grommet</i>.</p>
Related Products	<ul style="list-style-type: none"> Lounge Chaise Bench 		<p>► Page 174</p> <p>► Page 190</p> <p>► Page 194</p>

Tip: Column routes cables and wires when optional power or grommet are selected and exits through the base.

Tip: Devices and grommets are center location only to allow for routing of cords through the column and exits through the base.

Style Number	Dimensions			U.S. Base Prices			
	D	W	H	Flat Vinyl Edge on Laminate Top		Flat Wood Edge on Wood Top	
				Grade 1	Grade 2	Grade 1	Grade 2
COLAGTO	18"	32"	16"	\$1474	\$1536	\$2786	\$2955
	18"	48"	16"	\$1734	\$1826	\$3477	\$3707



For Canadian Pricing
Multiply U.S. Price by the Canadian price factor.
► See page 1 for details.



Standard Includes		Required to Specify
<ul style="list-style-type: none"> ▶ Need help? Product details, page 154 	<ul style="list-style-type: none"> • Table top: Grade 1 laminate with 3 mm flat plastic edge • Table base with column: paint • Four non-adjustable glides • Ships ready to assemble 	<ol style="list-style-type: none"> 1 Style number 2 Laminate color number for table top 3 Plastic edge color number for laminate table top, if selected 4 Paint color number base with column 5 Options, if selected (see below) <ul style="list-style-type: none"> ▶ See <i>Coalesse Surface Materials Reference Guide</i>.

Options	U.S. Price	Required to Specify
Surface Materials <ul style="list-style-type: none"> • Personal table top • Grade 2 laminate • Fusion fabric wrapped 	<p>Prices below</p> <p>Prices below</p>	<p>Specify <i>with Grade 2 laminate</i> and select color number.</p> <p>Specify <i>with Fusion fabric</i> and select color number.</p>
Related Products <ul style="list-style-type: none"> • Lounge • Chaise • Bench 		<ul style="list-style-type: none"> ▶ Page 174 ▶ Page 190 ▶ Page 194

Specification Information						
Style Number	Dimensions			U.S. Prices		
	D	W	H	Laminate: Grade 1	Grade 2	Fusion: Fabric
COLAGTP	13"	24"	25"	\$611	\$642	\$867

 **For Canadian Pricing**
 Multiply U.S. Price by the Canadian price factor.
 ▶ See page 1 for details.

Massaud

Tip: Upholstery intent is loose to provide visual and inviting comfort.

Tip: Headrest is articulated to adjust forward and back 2¾" to accommodate support needs. Headrest contains removeable pillow to allow reorientation and differing heights.

Tip: Base swivels with automatic return to center position.

Tip: Fire code seating is not available on chairs with contrasting fabric.

Standard Includes	Required to Specify
-------------------	---------------------

- Base: paint
- Inner and outer seat: fabric or leather
- Arm caps: fabric or leather
- Work lounge tablet, if selected: Fusion fabric only
- Work lounge tablet lever, if selected: painted to match base
- Removable pillow: fabric or leather to match outer seat
- Ottoman, if selected: fabric or leather
- Pull tab on ottoman, if selected: paint

- 1 Style number
 - 2 Number of fabrics if contrasting fabric style number is selected
 - 3 Paint color number for base
 - 4 Fabric or leather color number for inner and outer seat, and arm caps
 - 5 Fusion color number for work lounge tablet, if selected:
CL60 Caviar
CL61 Portobello
CL62 Graphite
CL63 Java
CL64 Steam
 - 6 Fabric or leather color number for ottoman, if selected
 - 7 Paint color number for pull tab on ottoman, if selected
 - 8 Options, if selected (see below)
- See *Coalesse Surface Materials Reference Guide*.

	Options	U.S. Price	Required to Specify
--	---------	------------	---------------------

Surface Materials	• Contrasting fabric	+\$118 per fabric	Add suffix K to the style number and select fabric color number. ► See <i>Coalesse Surface Materials Reference Guide</i> .
	Fire code seating		
	• Fire code seating	+\$231	Specify with <i>fire code seating</i> . ► See <i>Coalesse Surface Materials Reference Guide</i> .
	Acrylic backer		
	• Lounge and work lounge	+\$ 42	Specify with <i>acrylic backer</i> .
	• Ottoman	+\$ 21	Specify with <i>acrylic backer</i> .

Specification Information

Style Number	U.S. Base Prices											Leather Grades:		
	Fabric Grades:											COL	C	E
COM	6	7	8	9	10	11	12	13	14					

Lounge Chair

COMCLG	\$3401	\$3401	\$3430	\$3478	\$3628	\$3724	\$3836	\$3914	\$4052	\$4244	\$3504	\$4686	\$4938
--------	--------	--------	--------	--------	--------	--------	--------	--------	--------	--------	--------	--------	--------

COM/yds = 5¾, COL/sq ft = 110



Overall: 33"D 36½"W 41½"H

Work Lounge Chair

COMCWL	\$4060	\$4060	\$4091	\$4143	\$4301	\$4404	\$4523	\$4605	\$4752	\$4956	\$4154	\$5418	\$5684
--------	--------	--------	--------	--------	--------	--------	--------	--------	--------	--------	--------	--------	--------

COM/yds = 5¾, COL/sq ft = 110

► Specification Information, continued on next page



Overall: 33"D 41½"W 41½"H

Tip: Pivoting tablet is fixed at a height of 17/8".

Massaud

► Specification Information, continued from previous page

Specification Information

Style Number	U.S. Base Prices											Leather Grades:		
	Fabric Grades:											COL	C	E
	COM	6	7	8	9	10	11	12	13	14				

Ottoman

COMCOT	\$1213	\$1269	\$1288	\$1320	\$1415	\$1476	\$1548	\$1598	\$1687	\$1810	\$1447	\$2093	\$2254
--------	--------	--------	--------	--------	--------	--------	--------	--------	--------	--------	--------	--------	--------

COM/yds = 3, COL/sq ft = 55

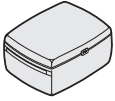

Overall: 20½"D 26"W 14"H

Tip: Ottoman is standard with one space divider and bottom insert. Divider and bottom insert are available in 3224 Charcoal only.

Tip: Ottoman is standard with Coalesse imprinted on pull and a left- and right-hand storage pocket.

Tip: Ottoman is not available in contrasting fabrics.



For Canadian Pricing
 Multiply U.S. Price by the
 Canadian price factor.
 ► See page 1 for details.

Massaud

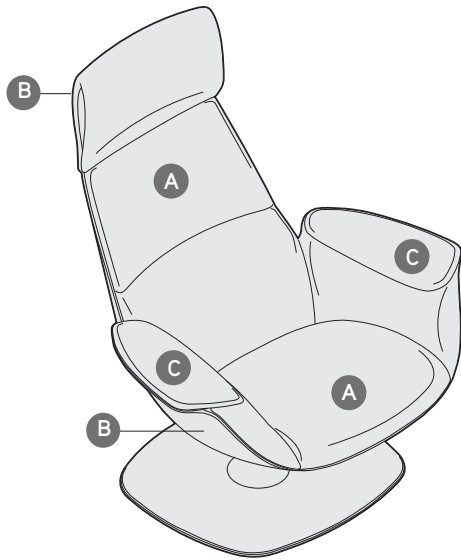

TO: _____

FROM: _____

DATE: _____

FAX....888.413.5161

A Inner seat: _____

B Outer Seat: _____

C Arm cap: _____

\$118 U.S. list upcharge for each contrasting textile pricing based on highest grade textile specified.

Specify Model below:

COMCLGK Lounge Chair

COMCWLK Work Lounge Chair

Tip: Ottoman is not available in contrasting fabrics.

Coalesse

Massaud

Millbrae Lounge

DESIGN COALESSE DESIGN STUDIO DESIGN ORIGIN: USA

Specification Information

Style Number	U.S. Base Prices													
	Fabric Grades:											Leather Grades:		
	COM	6	7	8	9	10	11	12	13	14	COL	C	E	

Lifestyle Chairs

Lounge

COMSL1	\$2441	\$2471	\$2505	\$2564	\$2742	\$2857	\$2991	\$3084	\$3249	\$3478	\$2565	\$4270	\$4480
--------	--------	--------	--------	--------	--------	--------	--------	--------	--------	--------	--------	--------	--------

COM/yds = 5¼, COL/sq ft = 115

Two-Seat

COMSL2	\$3617	\$3750	\$3804	\$3896	\$4176	\$4357	\$4567	\$4713	\$4972	\$5333	\$3741	\$6583	\$6913
--------	--------	--------	--------	--------	--------	--------	--------	--------	--------	--------	--------	--------	--------

COM/yds = 8¼, COL/sq ft = 181

Three-Seat

COMSL3	\$4484	\$4694	\$4763	\$4880	\$5237	\$5467	\$5734	\$5920	\$6250	\$6708	\$4608	\$8311	\$8730
--------	--------	--------	--------	--------	--------	--------	--------	--------	--------	--------	--------	--------	--------

COM/yds = 10½, COL/sq ft = 231

Contract Lounge Chairs

Without Arms

COMFL1	\$2076	\$2076	\$2094	\$2125	\$2218	\$2279	\$2349	\$2397	\$2484	\$2604	\$2256	\$2929	\$3030
--------	--------	--------	--------	--------	--------	--------	--------	--------	--------	--------	--------	--------	--------

COM/yds = 2¾, COL/sq ft = 60

With Arms

COMFLA1	\$2366	\$2366	\$2392	\$2437	\$2573	\$2661	\$2762	\$2833	\$2959	\$3134	\$2503	\$3744	\$3904
---------	--------	--------	--------	--------	--------	--------	--------	--------	--------	--------	--------	--------	--------

COM/yds = 4, COL/sq ft = 88

With Left Arm Facing

COMFLLA1	\$2216	\$2216	\$2238	\$2274	\$2384	\$2456	\$2538	\$2596	\$2698	\$2840	\$2379	\$3344	\$3475
----------	--------	--------	--------	--------	--------	--------	--------	--------	--------	--------	--------	--------	--------

COM/yds = 3¼, COL/sq ft = 72

With Right Arm Facing

COMFLRA1	\$2216	\$2216	\$2238	\$2274	\$2384	\$2456	\$2538	\$2596	\$2698	\$2840	\$2379	\$3344	\$3475
----------	--------	--------	--------	--------	--------	--------	--------	--------	--------	--------	--------	--------	--------

COM/yds = 3¼, COL/sq ft = 72

► Specification Information, continued on next page

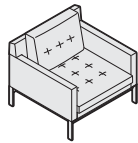

Overall: 35"D 35"W 28¾"H
Overall inside: 29"D 29"W 17"H
Inside to pillow: 22"D 29"W 17"H

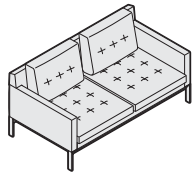

Overall: 35"D 64"W 28¾"H
Overall inside: 29"D 58"W 17"H
Inside to pillow: 22"D 58"W 17"H

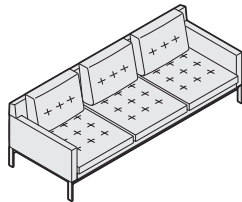

Overall: 35"D 92½"W 28¾"H
Overall inside: 29"D 87"W 17"H
Inside to pillow: 22"D 87"W 17"H



Overall: 30"D 26"W 31"H
Inside seat height: 22"D 17"H

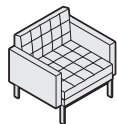

Overall: 30"D 32"W 31"H
Inside: 22"D 26½"W 17"H



Overall: 30"D 29"W 31"H
Inside: 22"D 26½"W 17"H



Overall: 30"D 29"W 31"H
Inside: 22"D 26½"W 17"H

Millbrae Lounge *continued*

DESIGN COALESSE DESIGN STUDIO DESIGN ORIGIN: USA

► Specification Information, continued from previous page

Specification Information

Style Number	U.S. Base Prices											Leather Grades:		
	Fabric Grades:											COL	C	E
	COM	6	7	8	9	10	11	12	13	14				

Contract Two-Seat Sofas

Without Arms

COMFL2	\$3308	\$3312	\$3342	\$3392	\$3545	\$3644	\$3758	\$3838	\$3979	\$4176	\$3679	\$5488	\$5708
COM/yds = 4½, COL/sq ft = 99													

With Arms

COMFLA2	\$3555	\$3602	\$3640	\$3704	\$3899	\$4025	\$4172	\$4273	\$4454	\$4705	\$3679	\$5488	\$5708
COM/yds = 5¾, COL/sq ft = 126													

With Left Arm Facing

COMFLLA2	\$3432	\$3453	\$3486	\$3542	\$3712	\$3821	\$3949	\$4037	\$4194	\$4413	\$3556	\$5073	\$5261
COM/yds = 5, COL/sq ft = 110													

With Right Arm Facing

COMFLRA2	\$3432	\$3453	\$3486	\$3542	\$3712	\$3821	\$3949	\$4037	\$4194	\$4413	\$3556	\$5073	\$5261
COM/yds = 5, COL/sq ft = 110													

► Specification Information, continued on next page

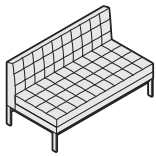

Overall: 30"D 52"W 31"H
Inside seat height: 22"D 17"H

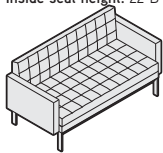

Overall: 30"D 58"W 31"H
Inside: 22"D 52½"W 17"H

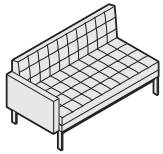

Overall: 30"D 55"W 31"H
Inside: 22"D 52¾"W 17"H

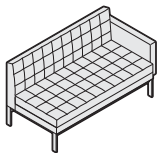

Overall: 30"D 55"W 31"H
Inside: 22"D 52¾"W 17"H



For Canadian Pricing
Multiply U.S. Price by the
Canadian price factor.
► See page 1 for details.

Millbrae Lounge

DESIGN COALESSE DESIGN STUDIO DESIGN ORIGIN: USA

► Specification Information, continued from previous page

Specification Information

Style Number	U.S. Base Prices													
	Fabric Grades:											Leather Grades:		
	COM	6	7	8	9	10	11	12	13	14	COL	C	E	

Contract Three-Seat Sofas

Without Arms

COMFL3	\$4112	\$4168	\$4207	\$4274	\$4478	\$4609	\$4762	\$4868	\$5057	\$5319	\$4236	\$6045	\$6265
--------	--------	--------	--------	--------	--------	--------	--------	--------	--------	--------	--------	--------	--------

COM/yds = 6, COL/sq ft = 132

With Arms

COMFLA3	\$4360	\$4467	\$4516	\$4600	\$4855	\$5019	\$5210	\$5343	\$5578	\$5906	\$4484	\$6862	\$7142
---------	--------	--------	--------	--------	--------	--------	--------	--------	--------	--------	--------	--------	--------

COM/yds = 7½, COL/sq ft = 159

With Left Arm Facing

COMFLLA3	\$4236	\$4317	\$4362	\$4437	\$4666	\$4814	\$4986	\$5105	\$5318	\$5612	\$4360	\$6462	\$6712
----------	--------	--------	--------	--------	--------	--------	--------	--------	--------	--------	--------	--------	--------

COM/yds = 6¾, COL/sq ft = 148

With Right Arm Facing

COMFLRA3	\$4236	\$4317	\$4362	\$4437	\$4666	\$4814	\$4986	\$5105	\$5318	\$5612	\$4360	\$6462	\$6712
----------	--------	--------	--------	--------	--------	--------	--------	--------	--------	--------	--------	--------	--------

COM/yds = 6¾, COL/sq ft = 148

► Specification Information, continued on next page

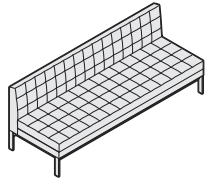

Overall: 30"D 78"W 31"H
Inside seat height: 22"D 17"H

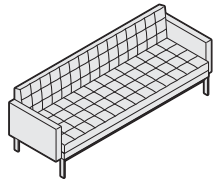

Overall: 30"D 84"W 31"H
Inside: 22"D 78½"W 17"H

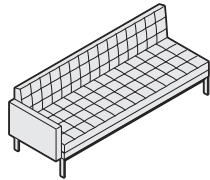

Overall: 30"D 81"W 31"H
Inside: 22"D 78¾"W 17"H

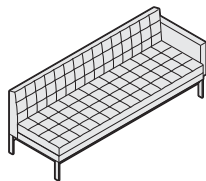

Overall: 30"D 81"W 31"H
Inside: 22"D 78¾"W 17"H



For Canadian Pricing
Multiply U.S. Price by the
Canadian price factor.
► See page 1 for details.

Millbrae Lounge *continued*

DESIGN COALESSE DESIGN STUDIO DESIGN ORIGIN: USA

► Specification Information, continued from previous page

Specification Information

Style Number	U.S. Base Prices											Leather Grades:		
	Fabric Grades:											COL	C	E
	COM	6	7	8	9	10	11	12	13	14				

Contract Four-Seat Sofas

Without Arms

COMFL4	\$4360	\$4476	\$4527	\$4613	\$4876	\$5046	\$5243	\$5380	\$5624	\$5963	\$4484	\$6862	\$7142
--------	--------	--------	--------	--------	--------	--------	--------	--------	--------	--------	--------	--------	--------

COM/yds = 7³/₄, COL/sq ft = 170

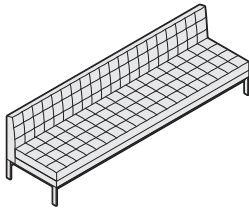

Overall: 30"D 104"W 31"H
Inside seat height: 22"D 17"H

With Arms

COMFLA4	\$4608	\$4758	\$4815	\$4913	\$5210	\$5402	\$5625	\$5779	\$6054	\$6437	\$4732	\$7678	\$8018
---------	--------	--------	--------	--------	--------	--------	--------	--------	--------	--------	--------	--------	--------

COM/yds = 8³/₄, COL/sq ft = 192

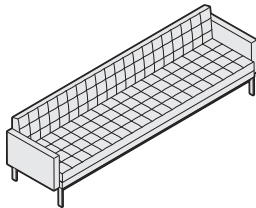

Overall: 30"D 110"W 31"H
Inside: 22"D 104¹/₂"W 17"H

With Left Arm Facing

COMFLLA4	\$4484	\$4617	\$4671	\$4763	\$5043	\$5224	\$5434	\$5580	\$5839	\$6200	\$4608	\$7260	\$7570
----------	--------	--------	--------	--------	--------	--------	--------	--------	--------	--------	--------	--------	--------

COM/yds = 8³/₄, COL/sq ft = 181

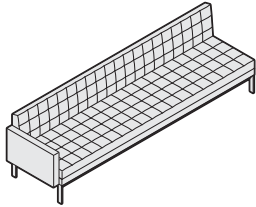

Overall: 30"D 107"W 31"H
Inside: 22"D 104³/₄"W 17"H

With Right Arm Facing

COMFLRA4	\$4484	\$4617	\$4671	\$4763	\$5043	\$5224	\$5434	\$5580	\$5839	\$6200	\$4608	\$7260	\$7570
----------	--------	--------	--------	--------	--------	--------	--------	--------	--------	--------	--------	--------	--------

COM/yds = 8³/₄, COL/sq ft = 181

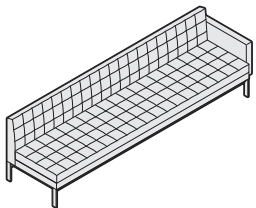

Overall: 30"D 107"W 31"H
Inside: 22"D 104³/₄"W 17"H

► Specification Information, continued on next page



For Canadian Pricing
Multiply U.S. Price by the
Canadian price factor.
► See page 1 for details.

Millbrae Lounge

DESIGN COALESSE DESIGN STUDIO DESIGN ORIGIN: USA

► Specification Information, continued from previous page

Specification Information

Style Number	U.S. Base Prices											Leather Grades:		
	Fabric Grades:											COL	C	E
	COM	6	7	8	9	10	11	12	13	14				

Benches

One-Seat Bench

COMFLB1	\$1670	\$1670	\$1681	\$1701	\$1760	\$1799	\$1843	\$1874	\$1929	\$2006	\$1884	\$2282	\$2352
COM/yds = 1¾, COL/sq ft = 39													

Two-Seat Bench

COMFLB2	\$2323	\$2323	\$2341	\$2372	\$2465	\$2526	\$2596	\$2644	\$2731	\$2851	\$2503	\$3176	\$3277
COM/yds = 2¾, COL/sq ft = 60													

Three-Seat Bench

COMFLB3	\$2712	\$2712	\$2734	\$2770	\$2880	\$2952	\$3034	\$3092	\$3194	\$3336	\$2875	\$3840	\$3971
COM/yds = 3¼, COL/sq ft = 72													

Four-Seat Bench

COMFLB4	\$2998	\$3002	\$3032	\$3082	\$3235	\$3334	\$3448	\$3528	\$3669	\$3866	\$3122	\$4363	\$4523
COM/yds = 4½, COL/sq ft = 93													

Round Arm Bolster

COMLPRND	\$ 300	\$ 286	\$ 291	\$ 299	\$ 324	\$ 341	\$ 360	\$ 373	\$ 397	\$ 430	\$ 534	\$ 552	\$ 583
COM/yds = ¾, COL/sq ft = 17													

Square Arm Bolster

COMLPSQR	\$ 300	\$ 294	\$ 301	\$ 312	\$ 346	\$ 368	\$ 393	\$ 411	\$ 442	\$ 486	\$ 534	\$ 638	\$ 679
COM/yds = 1, COL/sq ft = 22													

Ganging Kit

COMF1	\$ 68	N.A.	N.A.	N.A.	N.A.	N.A.	N.A.	N.A.	N.A.	N.A.	N.A.	N.A.	N.A.
-------	-------	------	------	------	------	------	------	------	------	------	------	------	------

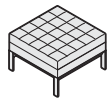

Overall: 26"D 26"W 16½"H

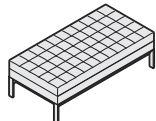

Overall: 26"D 52"W 16½"H

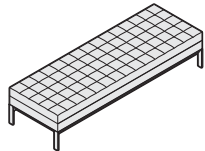

Overall: 26"D 78"W 16½"H

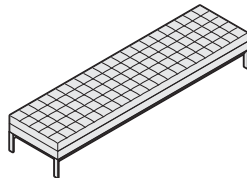

Overall: 26"D 104"W 16½"H



Overall: 18½"D 7"W 7"H



Overall: 18½"D 7"W 7"H

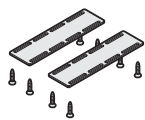

For Canadian Pricing
 Multiply U.S. Price by the
 Canadian price factor.
 ► See page 1 for details.

Millbrae

DESIGN COALESSE DESIGN STUDIO DESIGN ORIGIN: USA

Tip: Interport power/data module is not available on Millbrae.

Standard Includes	Required to Specify
<ul style="list-style-type: none"> • Base: steel, painted black gloss • Glass top: 3/4" thick glass • Legs: 1/2" x 13/4": paint • Glides 	1 Style number 2 Glass color number for top 3 Paint color number for legs 4 Options, if selected (see below) ▶ See <i>Coalesse Surface Materials Reference Guide</i> .

	Options	U.S. Price	Required to Specify
Surface Materials	Brushed nickel base <ul style="list-style-type: none"> • Side table, 30" x 30" and 36" x 36" square tables and 20" x 54" and 30" x 60" rectangular tables 	+\$573	Specify with plated metal.
	<ul style="list-style-type: none"> • 48" x 48" square table and rectangular tables 	+\$660	Specify with plated metal.

Specification Information									
Dimensions			Style Number	U.S. Base Prices					
D	W	H		Top Surface:					
				Clear	Clear Green	Absolute Clear/	Absolute	Colored	
				Green	Laminated/	Clear Frosted	Clear	Glass	
					Clear Green				
					Frosted				
					Appearance				

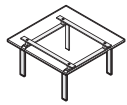

Square Tables

Dimensions	Style Number	U.S. Base Prices
30" x 30" x 15"	COMOTL3030	\$1982 \$2022 \$2099 \$2145 \$2240
36" x 36" x 15"	COMOTL3636	\$2354 \$2404 \$2517 \$2584 \$2724
48" x 48" x 15"	COMOTL4848	\$3220 \$3305 \$3490 \$3628 \$3870

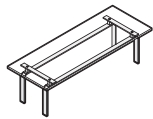

Rectangular Tables

Dimensions	Style Number	U.S. Base Prices
20" x 54" x 15"	COMOTL2054	\$2601 \$2668 \$2742 \$2798 \$2910
30" x 60" x 15"	COMOTL3060	\$2848 \$2915 \$3066 \$3173 \$3357



Side Table

Dimensions	Style Number	U.S. Base Prices
20" x 20" x 20"	COMOTL2020	\$1610 \$1639 \$1672 \$1682 \$1727



For Canadian Pricing
 Multiply U.S. Price by the Canadian price factor.
 ▶ See page 1 for details.

Coalesse

Millbrae Multi-Fabric Diagram

DESIGN COALESSE DESIGN

TO: _____

FROM: _____

DATE: _____

FAX...888.413.5161

Lifestyle

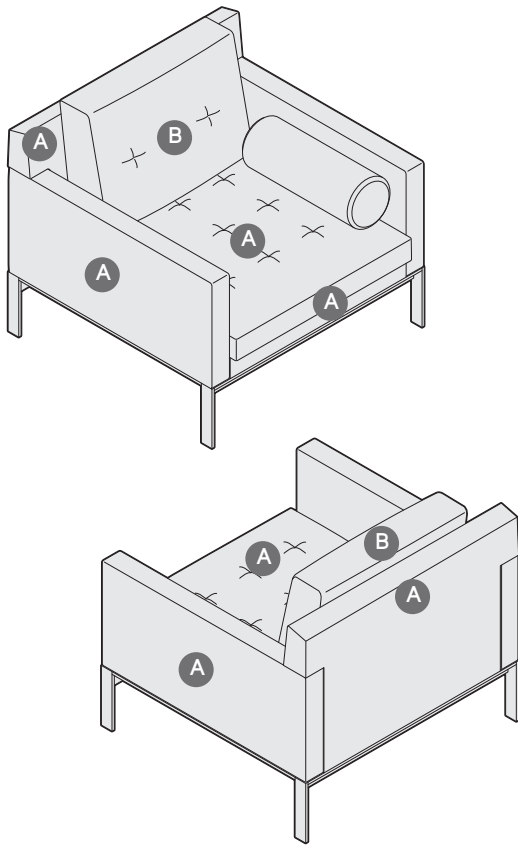

A Seat, Back, and Arms: _____

B Back Pillow: _____

Tip: Arm bolsters must be specified separately.

Tip: Attachment straps are standard on back pillow of lifestyle chairs.

Lounge Seating

Coalesse

Millbrae Multi-Fabric Diagram *continued*

DESIGN COALESSE DESIGN

TO: _____

FROM: _____

DATE: _____

FAX...888.413.5161

Contract

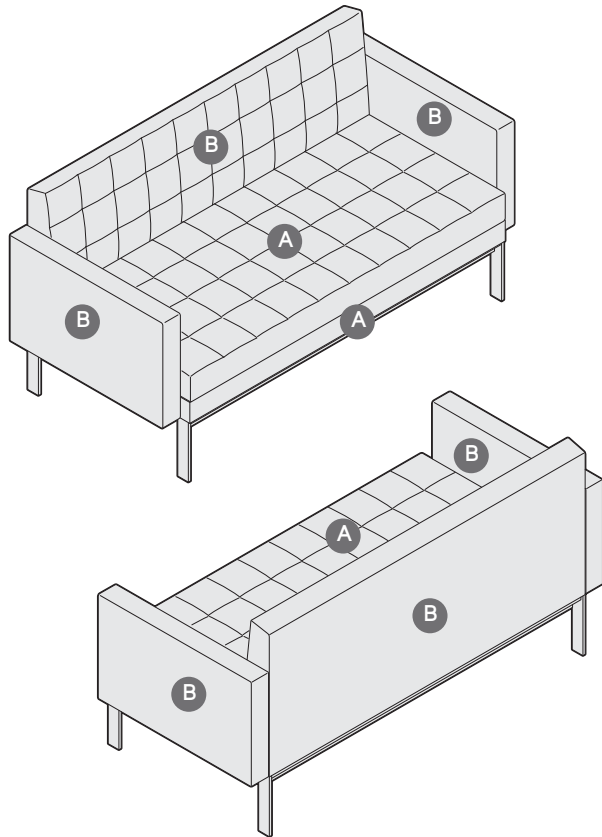

A Seat: _____

B Back and Arms: _____

Tip: Arm bolsters must be specified separately.

Coalesse

Millbrae Multi-Fabric Diagram

DESIGN COALESSE DESIGN

Passerelle Lounge

DESIGN STUDIO B DESIGN ORIGIN: UNITED STATES

Tip: Fabrics and leathers will appear loose with comfort wrinkles when upholstered.

Tip: Recommended leathers are Elmosoft Grade C and Elmorustical Grade E.

Tip: Special color match, consult customer service.

Tip: For Customer's Own Material or Leather, see necessary requirements, important processing instructions, and ordering information
 ▶ See *Coalesse Surface Materials Reference Guide*.

Standard Includes	Required to Specify
-------------------	---------------------

<ul style="list-style-type: none"> • Frame: unibody construction with finger jointed plywood • Upholstery: multiple densities of polyurethane foam and polyester fiber on seat, back, and arms • Legs: solid maple with non-adjustable glides 	<ol style="list-style-type: none"> 1 Style number 2 Number of fabrics if contrasting fabric style number is selected 3 Fabric or leather color number for upholstery on seat, back, and arms 4 Wood color number for legs 5 Options, if selected (see below) ▶ See <i>Coalesse Surface Materials Reference Guide</i> .
--	---

Options	U.S. Price	Required to Specify
---------	------------	---------------------

Surface Materials <ul style="list-style-type: none"> • Contrasting fabric <hr/> Acrylic backer <ul style="list-style-type: none"> • Chair • Loveseat • Sofa • Arm bolster 	+\$118 per fabric +\$ 33 +\$ 44 +\$ 54 +\$ 8	Add suffix K to the style number and select fabric color number. Specify with acrylic backer. Specify with acrylic backer. Specify with acrylic backer. Specify with acrylic backer. ▶ See <i>Coalesse Surface Materials Reference Guide</i> .
Attachment Straps <ul style="list-style-type: none"> • Attachment straps available on bolster pillow 	+\$ 63	Specify with attachment straps.

Specification Information																	
Style Number	U.S. Base Prices												Leather Grades:				
	Fabric Grades:												COL		C		E
COM	6	7	8	9	10	11	12	13	14								

Chair

440-WB	\$1599	\$1621	\$1660	\$1698	\$1769	\$1837	\$2015	\$2137	\$2174	\$2397	\$1789	\$3884	\$4241
COM/yds = 4, COL/sq ft = 88													

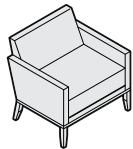

Overall: 27"D 30½"W 29"H
 Inside: 19"D 26"W 17"H
 Seat: 17½"H
 Arm: 23"H

Loveseat

440-2WB	\$2875	\$2955	\$3023	\$3067	\$3171	\$3253	\$3501	\$3679	\$3710	\$4119	\$3070	\$5983	\$6378
COM/yds = 5½, COL/sq ft = 121													

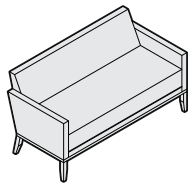

Overall: 27"D 56½"W 29"H
 Inside: 19"D 52"W 17"H
 Seat: 17½"H
 Arm: 23"H

Sofa

440-3WB	\$3195	\$3325	\$3407	\$3463	\$3591	\$3693	\$4006	\$4203	\$4262	\$4724	\$3385	\$6999	\$7429
COM/yds = 6¾, COL/sq ft = 149													

▶ Specification Information, continued on next page

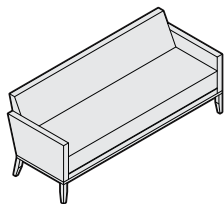

Overall: 27"D 72¾"W 29"H
 Inside: 19"D 68"W 17"H
 Seat: 17½"H
 Arm: 23"H

Passerelle Lounge

DESIGN STUDIO B DESIGN ORIGIN: UNITED STATES

► Specification Information, continued from previous page

Specification Information

Style Number	U.S. Base Prices										Leather Grades:		
	Fabric Grades:										COL	C	E
	COM	6	7	8	9	10	11	12	13	14			

Arm Bolster

440-B	\$274	\$279	\$287	\$300	\$331	\$382	\$420	\$429	\$446	\$464	\$561	\$852	\$1144
-------	-------	-------	-------	-------	-------	-------	-------	-------	-------	-------	-------	-------	--------

COM/yds = 1, COL/sq ft = 18



Overall: 17½"W 5¾"Dia



For Canadian Pricing
 Multiply U.S. Price by the
 Canadian price factor.
 ► See page 1 for details.

Passerelle Ottoman

DESIGN STUDIO B DESIGN ORIGIN: UNITED STATES

Tip: Fabrics and leathers will appear loose with comfort wrinkles when upholstered.

Tip: Recommended leathers are Elmosoft Grade C and Elmorustical Grade E.

Tip: Special color match, consult customer service.

Tip: For Customer's Own Material or Leather, see necessary requirements, important processing instructions, and ordering information
 ► See *Coalesse Surface Materials Reference Guide*.

Standard Includes	Required to Specify
-------------------	---------------------

<ul style="list-style-type: none"> • Frame: unibody construction with finger jointed plywood • Upholstery: multiple densities of polyurethane foam and polyester fiber • Legs: solid maple with non-adjustable glides 	<ol style="list-style-type: none"> 1 Style number 2 Fabric or leather color number for upholstery 3 Wood color number for legs 4 Options, if selected (see below) ► See <i>Coalesse Surface Materials Reference Guide</i> .
--	---

Options	U.S. Price	Required to Specify
---------	------------	---------------------

Surface Materials <ul style="list-style-type: none"> • Acrylic backer 	<ul style="list-style-type: none"> • 17"D x 17"W ottoman +\$ 8 • 20"D x 26"W ottoman +\$12 • 36"D x 36"W ottoman +\$24 	Specify with acrylic backer. Specify with acrylic backer. Specify with acrylic backer. ► See <i>Coalesse Surface Materials Reference Guide</i> .
---	---	---

Specification Information													
Style Number	U.S. Base Prices											Leather Grades:	
	Fabric Grades:											COL	C
COM	6	7	8	9	10	11	12	13	14				

Style Number	COM	6	7	8	9	10	11	12	13	14	COL	C	E
--------------	-----	---	---	---	---	----	----	----	----	----	-----	---	---

Ottoman

440-H1717WB	\$ 953	\$ 958	\$ 972	\$ 996	\$1021	\$1042	\$1110	\$1156	\$1168	\$1301	\$1234	\$1997	\$2257
--------------------	--------	--------	--------	--------	--------	--------	--------	--------	--------	--------	--------	--------	--------

COM/yds = 1½, COL/sq ft = 33

440-H2026WB	\$1131	\$1137	\$1163	\$1175	\$1225	\$1259	\$1339	\$1410	\$1415	\$1574	\$1393	\$2421	\$2701
--------------------	--------	--------	--------	--------	--------	--------	--------	--------	--------	--------	--------	--------	--------

COM/yds = 2, COL/sq ft = 44

440-H3636WB	\$1480	\$1489	\$1521	\$1545	\$1598	\$1642	\$1763	\$1853	\$1874	\$2080	\$1713	\$3161	\$3469
--------------------	--------	--------	--------	--------	--------	--------	--------	--------	--------	--------	--------	--------	--------

COM/yds = 2¾, COL/sq ft = 61



Overall: 17"D 17"W 17"H

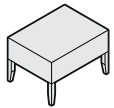

Overall: 20"D 26"W 17"H

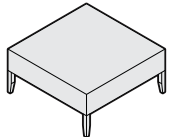

Overall: 36"D 36"W 17"H



For Canadian Pricing
 Multiply U.S. Price by the Canadian price factor.
 ► See page 1 for details.

Passerelle Benches

DESIGN STUDIO B DESIGN ORIGIN: UNITED STATES

Tip: Fabrics and leathers will appear loose with comfort wrinkles when upholstered.

Tip: For plain upholstery option or contrasting textiles, contact customer service.

Tip: Recommended leathers are Elmosoft Grade C and Elmorustical Grade E.

Tip: Special color match, consult customer service.

Tip: For Customer's Own Material or Leather, see necessary requirements, important processing instructions, and ordering information
 ▶ See *Coalesse Surface Materials Reference Guide*.

Standard Includes

- Frame: solid maple
- Upholstery: multiple densities of polyurethane foam
- Legs: solid maple with non-adjustable glides
- Button detail: tufted and double needled

Required to Specify

- 1 Style number
 - 2 Fabric or leather color number for upholstery on bench
 - 3 Wood color number for legs
 - 4 Options, if selected (see below)
- ▶ See *Coalesse Surface Materials Reference Guide*.

Options

Surface Materials	Options	U.S. Price	Required to Specify
	Acrylic backer		
	• 20"D x 60"W bench	+\$24	Specify with acrylic backer.
	• 40"D x 40"W bench	+\$33	Specify with acrylic backer.
	• 30"D x 60"W bench	+\$37	Specify with acrylic backer.

▶ See *Coalesse Surface Materials Reference Guide*.

Specification Information

Style Number	U.S. Base Prices												Leather Grades:			
	Fabric Grades:												COL	C	E	
	COM	6	7	8	9	10	11	12	13	14						

Bench

440-B3060WB	\$1949	\$1960	\$2017	\$2047	\$2120	\$2176	\$2308	\$2423	\$2470	\$2742	\$2158	\$4265	\$4645
--------------------	--------	--------	--------	--------	--------	--------	--------	--------	--------	--------	--------	--------	--------

COM/yds = 4, COL/sq ft = 88

440-B4040WB	\$1893	\$1902	\$1935	\$1974	\$2037	\$2094	\$2202	\$2311	\$2350	\$2615	\$2121	\$3956	\$4282
--------------------	--------	--------	--------	--------	--------	--------	--------	--------	--------	--------	--------	--------	--------

COM/yds = 3½, COL/sq ft = 77

440-B2060WB	\$1698	\$1705	\$1746	\$1762	\$1814	\$1865	\$1934	\$2025	\$2063	\$2302	\$1949	\$3391	\$3657
--------------------	--------	--------	--------	--------	--------	--------	--------	--------	--------	--------	--------	--------	--------

COM/yds = 2¾, COL/sq ft = 61

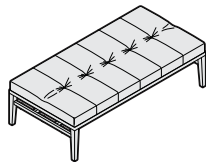

Overall: 30"D 60"W 17"H

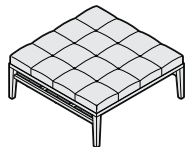

Overall: 40"D 40"W 17"H

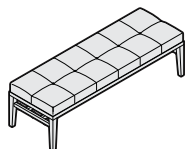

Overall: 20"D 60"W 17"H

 **For Canadian Pricing**
 Multiply U.S. Price by the Canadian price factor.
 ▶ See page 1 for details.

Ripple Benches

DESIGN LAURINDA SPEAR,FAIA DESIGN ORIGIN: UNITED STATES

Tip: Fabrics and leathers will appear loose with comfort wrinkles when upholstered.

Tip: Pricing based on highest grade textile specified.

Tip: Due to the design and construction techniques of Ripple lounge, only certain textiles can be successfully applied, therefore COM fabrics must be submitted to Coalesse for approval prior to order acceptance. Solid patterns with no repeat are recommended.

Tip: Recommended leathers are Elmosoft Grade C and Elmorustical Grade E.

Tip: Special color match, consult customer service.

Tip: For Customer's Own Material or Leather, see necessary requirements, important processing instructions, and ordering information
 ▶ See *Coalesse Surface Materials Reference Guide*.

Tip: 35" is a single seat and 96" three seat/sofa.

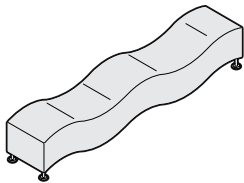

Overall: 19¼"D 97"W 19¼"H
 Dip: 14"H

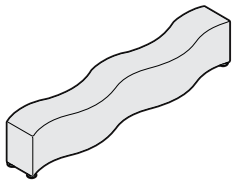

Overall: 19¼"D 97"W 19¼"H
 Seat Surface: 19"H

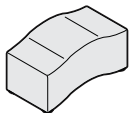

Overall: 19"D 35¾"W 19¼"H



For Canadian Pricing
 Multiply U.S. Price by the Canadian price factor.
 ▶ See page 1 for details.

Standard Includes	Required to Specify
<ul style="list-style-type: none"> • Frame: unibody construction with finger jointed plywood • Upholstery: multiple densities of laminated polyurethane foam • Glides: height adjustable with stainless steel finish leveling polyurethane glides • Double needle stitch seams 	<ol style="list-style-type: none"> 1 Style number 2 Number of fabrics if contrasting fabric style number is selected 3 Fabric or leather color number for upholstery on bench 4 Options, if selected (see below) ▶ See <i>Coalesse Surface Materials Reference Guide</i> .

Options	U.S. Price	Required to Specify
Surface Materials <ul style="list-style-type: none"> • Contrasting fabric 	+\$118 per fabric	Add suffix K to the style number and select fabric color number.
Acrylic backer <ul style="list-style-type: none"> • Wave and flat seats • Little Ripple wave and flat seats 	+\$ 67 +\$ 29	Specify with <i>acrylic backer</i> . Specify with <i>acrylic backer</i> . ▶ See <i>Coalesse Surface Materials Reference Guide</i> .

Specification Information													
Style Number	U.S. Base Prices											Leather Grades:	
	Fabric Grades:											COL	C
COM	6	7	8	9	10	11	12	13	14				

Upholstered Wave Seat

490-B96VRT	\$2087	\$2194	\$2243	\$2327	\$2582	\$2746	\$2937	\$3070	\$3305	\$3633	\$2263	\$5419	\$5987
------------	--------	--------	--------	--------	--------	--------	--------	--------	--------	--------	--------	--------	--------

COM/yds = 7½, COL/sq ft = 143

Upholstered Flat Seat

490-B96HRZ	\$2087	\$2194	\$2243	\$2327	\$2582	\$2746	\$2937	\$3070	\$3305	\$3633	\$2263	\$5419	\$5987
------------	--------	--------	--------	--------	--------	--------	--------	--------	--------	--------	--------	--------	--------

COM/yds = 7½, COL/sq ft = 143

Little Ripple Wave Seat

490-B35VRT	\$ 880	\$ 880	\$ 895	\$ 920	\$ 996	\$1046	\$1103	\$1143	\$1214	\$1312	\$1119	\$2179	\$2371
------------	--------	--------	--------	--------	--------	--------	--------	--------	--------	--------	--------	--------	--------

COM/yds = 2¼, COL/sq ft = 50

▶ Specification Information, continued on next page

Ripple Benches

DESIGN LAURINDA SPEAR,FAIA DESIGN ORIGIN: UNITED STATES

► Specification Information, continued from previous page

Specification Information

Style Number	U.S. Base Prices											Leather Grades:		
	Fabric Grades:											COL	C	E
	COM	6	7	8	9	10	11	12	13	14				

Little Ripple Flat Seat

490-B35HRZ	\$880	\$880	\$895	\$920	\$996	\$1046	\$1103	\$1143	\$1214	\$1312	\$1119	\$2179	\$2371
COM/yds = 2¼, COL/sq ft = 50													

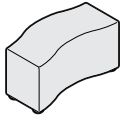

Overall: 19"D 35½"W 19"H



For Canadian Pricing
 Multiply U.S. Price by the
 Canadian price factor.
 ► See page 1 for details.

Sidewalk Lounge/Mobile

DESIGN STUDIO B DESIGN ORIGIN: UNITED STATES

Tip: Fabrics and leathers will appear loose with comfort wrinkles when upholstered.

Tip: Coordinating Sidewalk tables, ottomans, benches, and credenzas are available on pages 226, 380 and 381.

Tip: Recommended leathers are Elmosoft Grade C and Elmorustical Grade E.

Tip: Special color match, consult Customer Service.

Tip: For multi-fabric diagram, refer to page 222.

Tip: Specify tablet from facing position.

Tip: Cup holder attaches to tablet.

Tip: For Customer's Own Material or Leather, see necessary requirements, important processing instructions, and ordering information
 ► See *Coalesse Surface Materials Reference Guide*.

Tip: Extra pivoter allows tablet to be moved side to side.

Tip: Tablet can be installed on mobile models only.

Standard Includes		Required to Specify	
	<ul style="list-style-type: none"> • Frame: unibody construction with finger jointed plywood • Upholstery: multiple densities of polyurethane foam and polyester fiber on seat, back, and arms. • Lounge: <ul style="list-style-type: none"> - Legs: silver powder coat steel legs with "Go" glide • Mobile: <ul style="list-style-type: none"> - 13½" diameter tablet: laminate - Legs: Silver powder coat steel legs with casters - Casters: four non-locking 		<ol style="list-style-type: none"> 1 Style number 2 Number of fabrics if contrasting fabric style number is selected 3 Fabric or leather color number for upholstery on seat, back, and arms 4 Options, if selected (see below) ► See <i>Coalesse Surface Materials Reference Guide</i> .
Options		U.S. Price	Required to Specify
Surface Materials	<ul style="list-style-type: none"> • Contrasting fabric 	+\$118 per fabric	Add suffix K to the style number and select fabric color number.
	Acrylic backer		
	<ul style="list-style-type: none"> • Lounge chair • Lounge two-seat chair • Arm bolster 	+\$ 37 +\$ 50 +\$ 8	Specify with <i>acrylic backer</i> . Specify with <i>acrylic backer</i> . Specify with <i>acrylic backer</i> . ► See <i>Coalesse Surface Materials Reference Guide</i> .
Tablet on Mobile Models only	<ul style="list-style-type: none"> • Wood • Anodized aluminum 	+\$134 +\$220	Specify with <i>wood</i> and select wood color. Specify with <i>anodized aluminum</i> .
Cup Holder	<ul style="list-style-type: none"> • Cup holder 	+\$ 49	Specify with <i>cup holder</i> .
Tablet Side Storage	<ul style="list-style-type: none"> • Tablet side storage 	+\$ 73	Specify with <i>tablet side storage</i> and select or right-facing.
Extra Pivoter	<ul style="list-style-type: none"> • Extra pivoter 	+\$179	Specify with <i>extra pivoter</i> .
Omit Tablet	<ul style="list-style-type: none"> • Omit tablet 	-\$154	Specify with <i>omit tablet</i> .
Glides	Lounge <ul style="list-style-type: none"> • "No Go" ½" polyethylene glide 	No cost	Specify with <i>"no go"</i> .
	Mobile <ul style="list-style-type: none"> • Go glides 	No cost	Specify with <i>go glides</i> .
Casters	<ul style="list-style-type: none"> • Locking casters 	No cost	Specify with <i>locking casters</i> .
Related Products	<ul style="list-style-type: none"> • Ottomans/Benches • Sidewalk tables • Credenzas 		► See page 226 ► See page 380 ► See page 381

Specification Information

Style Number	U.S. Base Prices										Leather Grades:		
	Fabric Grades:										COL	C	E
	COM	6	7	8	9	10	11	12	13	14			

Lounge Lowback Chair

444	\$1506	\$1506	\$1532	\$1577	\$1713	\$1801	\$1902	\$1973	\$2099	\$2274	\$1701	\$3724	\$4057
-----	--------	--------	--------	--------	--------	--------	--------	--------	--------	--------	--------	--------	--------

COM/yds = 4, COL/sq ft = 88

► Specification Information, continued on next page

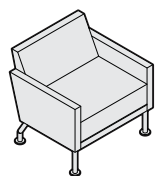

Overall: 27"D 30½"W 29"H
 Inside: 19"D 26"W 17"H
 Seat: 17½"H
 Arm: 23"H



For Canadian Pricing
 Multiply U.S. Price by the Canadian price factor.
 ► See page 1 for details.

Sidewalk Lounge/Mobile

DESIGN STUDIO B DESIGN ORIGIN: UNITED STATES

► Specification Information, continued from previous page

Specification Information

Style Number	U.S. Base Prices											Leather Grades:		
	Fabric Grades:											COL	C	E
	COM	6	7	8	9	10	11	12	13	14				

Lounge Highback Chair

446	\$1660	\$1664	\$1694	\$1744	\$1897	\$1996	\$2110	\$2190	\$2331	\$2528	\$1850	\$4012	\$4350
-----	--------	--------	--------	--------	--------	--------	--------	--------	--------	--------	--------	--------	--------

COM/yds = 4½, COL/sq ft = 99

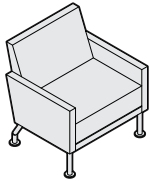

Overall: 27"D 30½"W 32"H
 Inside: 19"D 26"W 20"H
 Seat: 17½"H
 Arm: 23"H

Lounge Two-Seat

444-2	\$2343	\$2382	\$2418	\$2479	\$2666	\$2786	\$2926	\$3024	\$3197	\$3437	\$2533	\$5336	\$5711
-------	--------	--------	--------	--------	--------	--------	--------	--------	--------	--------	--------	--------	--------

COM/yds = 5½, COL/sq ft = 121

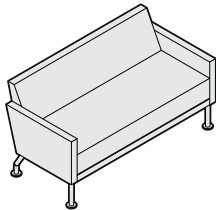

Overall: 27"D 56½"W 29"H
 Inside: 19"D 52"W 17"H
 Seat: 17½"H
 Arm: 23"H

Mobile Lowback Chair with Tablet

444M	\$2044	\$2044	\$2070	\$2115	\$2251	\$2339	\$2440	\$2511	\$2637	\$2812	\$2233	\$4256	\$4630
------	--------	--------	--------	--------	--------	--------	--------	--------	--------	--------	--------	--------	--------

COM/yds = 4, COL/sq ft = 88

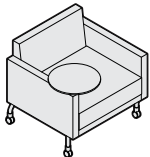

Overall: 27"D 30½"W 29"H
 Inside: 19"D 26"W 17"H
 Seat: 17½"H
 Arm: 22½"H

Mobile Highback Chair with Tablet

446M	\$2203	\$2207	\$2237	\$2287	\$2440	\$2539	\$2653	\$2733	\$2874	\$3071	\$2385	\$4669	\$5081
------	--------	--------	--------	--------	--------	--------	--------	--------	--------	--------	--------	--------	--------

COM/yds = 4½, COL/sq ft = 99

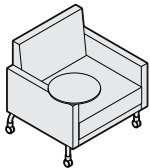

Overall: 27"D 30½"W 32"H
 Inside: 19"D 26"W 20"H
 Seat: 17½"H
 Arm: 22½"H



Overall: 17½"H 5¾" Dia

Arm Bolster

440-B	\$ 274	\$ 279	\$ 287	\$ 300	\$ 331	\$ 382	\$ 420	\$ 429	\$ 446	\$ 464	\$ 561	\$ 852	\$1144
-------	--------	--------	--------	--------	--------	--------	--------	--------	--------	--------	--------	--------	--------

COM/yds = 1, COL/sq ft = 18

 **For Canadian Pricing**
 Multiply U.S. Price by the
 Canadian price factor.
 ► See page 1 for details.

Sidewalk Multi-Fabric Diagram

DESIGN STUDIO B DESIGN ORIGIN: UNITED STATES

TO: _____

FROM: _____

DATE: _____

FAX...888.413.5161

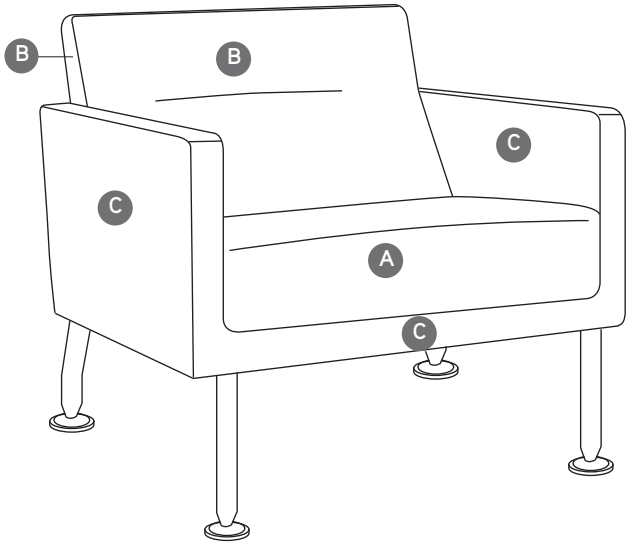

A Upholstery Selection (default for entire unit if B is not selected):

B Back: _____

C Arms: _____

Total list price upcharge for contrasting fabrics: \$_____

\$118 U.S. list per contrasting fabric specified. List price based on highest fabric grade usage.

Specify Model below:

444K Sidewalk Lowback Lounge or Mobile

446K Sidewalk Highback Lounge or Mobile

444-2K Sidewalk Two Seat Sofa

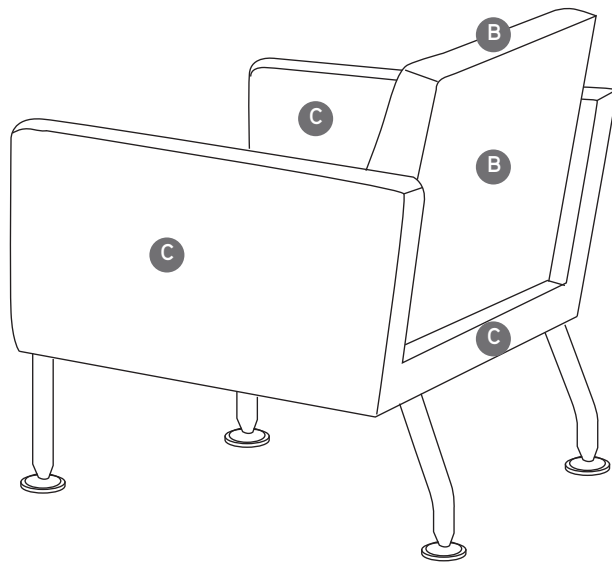

For Canadian Pricing
Multiply U.S. Price by the
Canadian price factor.
▶ See page 1 for details.

Coalesse

Sidewalk Multi-Fabric Diagram

DESIGN STUDIO B DESIGN ORIGIN: UNITED STATES

Tip: Fabrics and leathers will appear loose with comfort wrinkles when upholstered.

Tip: Recommended leathers are Elmosoft Grade C and Elmorustical Grade E.

Tip: Special color match, consult Customer Service.

Tip: For Customer's Own Material or Leather, see necessary requirements, important processing instructions, and ordering information
 ▶ See Coalesse Surface Materials Reference Guide.

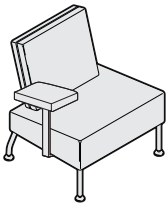

Tip: Overall width dimensions with arm options: 430: 35"W 430-2: 49"W. Overall inside width dimensions with arm options: 430: 19 1/2"W 430-2: 49"W

▶ See Sidewalk multi-fabric diagram on page 227.

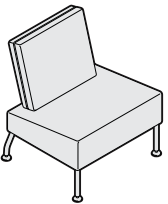

Overall: 27"D 27"W 30 1/2"H
 Inside: 17"D 27"W 18"H
 Seat: 17"H
 Arm: 21"H

Standard Includes		Required to Specify	
	<ul style="list-style-type: none"> • Frame: unibody construction with finger jointed plywood • Upholstery: multiple densities of polyurethane foam and polyester fiber on seat and back • Legs: silver powder coat steel with "Go" glides 		<ol style="list-style-type: none"> 1 Style number 2 Number of fabrics if contrasting fabric style number is selected 3 Fabric or leather color number for upholstery on seat and back 4 Options, if selected (see below) ▶ See Coalesse Surface Materials Reference Guide.
Options		U.S. Price	Required to Specify
Surface Materials	<ul style="list-style-type: none"> • Contrasting fabric 	+\$118 per fabric	Add suffix K to the style number and select fabric color number.
	Acrylic backer <ul style="list-style-type: none"> • Chair • Two-seat chair • 17"D x 17"W and 17"D x 20"W ottomans • 20"D x 26"W ottoman 	+\$ 22 +\$ 41 +\$ 12 +\$ 17	Specify with acrylic backer. Specify with acrylic backer. Specify with acrylic backer. ▶ See Coalesse Surface Materials Reference Guide.
Attachment Straps	<ul style="list-style-type: none"> • 430 model • 430-2 model 	+\$ 63 +\$126	Specify with attachment straps. Specify with attachment straps.
Arms	<ul style="list-style-type: none"> • Arms on 430 and 430-2 3/4 yard or 14 sq. ft. required for COM/COL 	+\$ 44 per arm	Specify with arms.
Glides	<ul style="list-style-type: none"> • "No Go" 1/2" polyethylene glides 	No cost	Specify with "no go" glides.

Specification Information														
Style Number	U.S. Base Prices												Leather Grades:	
	Fabric Grades:												COL	C
	COM	6	7	8	9	10	11	12	13	14				

Chair													
430	\$1411	\$1411	\$1429	\$1460	\$1553	\$1614	\$1684	\$1732	\$1819	\$1939	\$1649	\$2885	\$3206

COM/yds = 2 3/4, COL/sq ft = 77
 ▶ Specification Information, continued on next page

 **For Canadian Pricing**
 Multiply U.S. Price by the Canadian price factor.
 ▶ See page 1 for details.

► Specification Information, continued from previous page

Specification Information

Style Number	U.S. Base Prices											Leather Grades:		
	Fabric Grades:											COL	C	E
	COM	6	7	8	9	10	11	12	13	14				

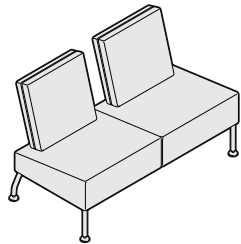

Overall: 27"D 49"W 30½"H
 Inside: 17"D 49"W 18"H
 Seat: 17"H
 Arm: 21"H

Two-Seat

430-2	\$2096	\$2096	\$2124	\$2171	\$2315	\$2409	\$2517	\$2592	\$2725	\$2911	\$2290	\$4147	\$4510
-------	--------	--------	--------	--------	--------	--------	--------	--------	--------	--------	--------	--------	--------

COM/yds = 4¼, COL/sq ft = 115

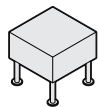

Overall: 17"D 17"W 17"H

Ottoman

430-H1717	\$ 857	\$ 857	\$ 867	\$ 884	\$ 935	\$ 968	\$1006	\$1033	\$1080	\$1145	\$1146	\$1491	\$1740
-----------	--------	--------	--------	--------	--------	--------	--------	--------	--------	--------	--------	--------	--------

COM/yds = 1½, COL/sq ft = 22½

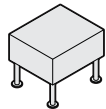

Overall: 17"D 20"W 17"H

430-H1720	\$ 857	\$ 857	\$ 867	\$ 884	\$ 935	\$ 968	\$1006	\$1033	\$1080	\$1145	\$1146	\$1491	\$1740
-----------	--------	--------	--------	--------	--------	--------	--------	--------	--------	--------	--------	--------	--------

COM/yds = 1½, COL/sq ft = 24

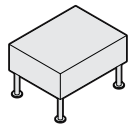

Overall: 20"D 26"W 17"H

430-H2026	\$1028	\$1028	\$1041	\$1063	\$1131	\$1175	\$1226	\$1261	\$1324	\$1411	\$1285	\$1836	\$2092
-----------	--------	--------	--------	--------	--------	--------	--------	--------	--------	--------	--------	--------	--------

COM/yds = 2, COL/sq ft = 36



For Canadian Pricing
 Multiply U.S. Price by the
 Canadian price factor.
 ► See page 1 for details.

Sidewalk Ottoman/Benches

DESIGN STUDIO B DESIGN ORIGIN: UNITED STATES

Tip: Fabrics and leathers will appear loose with comfort wrinkles when upholstered.

Tip: Recommended leathers are Elmosoft Grade C and Elmorustical Grade E.

Tip: Special color match, consult customer service.

Tip: For Customer's Own Material or Leather, see necessary requirements, important processing instructions, and ordering information
 ▶ See *Coalesse Surface Materials Reference Guide*.

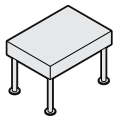

Overall: 17"D 24"W 17"H

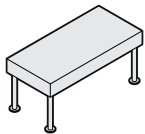

Overall: 17"D 36"W 17"H

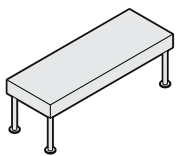

Overall: 17"D 48"W 17"H

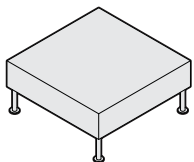

Overall: 36"D 36"W 17"H

 **For Canadian Pricing**
 Multiply U.S. Price by the Canadian price factor.
 ▶ See page 1 for details.

Standard Includes		Required to Specify	
	<ul style="list-style-type: none"> • Frame: unibody construction with finger jointed plywood. • Upholstery: multiple densities of polyurethane foam and polyester fiber on ottoman/benches • Legs: silver powder coat steel with "Go" glides 		1 Style number 2 Fabric or leather color number for upholstery on ottoman/benches 3 Options, if selected (see below) ▶ See <i>Coalesse Surface Materials Reference Guide</i> .
Options		U.S. Price	Required to Specify
Surface Material	Acrylic backer		
	• 17"D x 24"W bench	+\$12	Specify with acrylic backer.
	• 17"D x 36"W bench	+\$17	Specify with acrylic backer.
	• 17"D x 48"W bench	+\$22	Specify with acrylic backer.
	• Ottoman	+\$29	Specify with acrylic backer. ▶ See <i>Coalesse Surface Materials Reference Guide</i> .
Glides	• "No Go" 1/2" polyethylene glides	No cost	Specify with "no go" glides.

Specification Information														
Style Number	U.S. Base Prices												Leather Grades:	
	Fabric Grades:												COL	C
COM	6	7	8	9	10	11	12	13	14					

Benches

430-B1724	\$ 929	\$ 929	\$ 939	\$ 956	\$1007	\$1040	\$1078	\$1105	\$1152	\$1217	\$1217	\$1617	\$1853
-----------	--------	--------	--------	--------	--------	--------	--------	--------	--------	--------	--------	--------	--------

COM/yds = 1½, COL/sq ft = 27

430-B1736	\$1093	\$1093	\$1106	\$1128	\$1196	\$1240	\$1291	\$1326	\$1389	\$1476	\$1358	\$1910	\$2176
-----------	--------	--------	--------	--------	--------	--------	--------	--------	--------	--------	--------	--------	--------

COM/yds = 2, COL/sq ft = 36

430-B1748	\$1262	\$1262	\$1278	\$1306	\$1391	\$1446	\$1509	\$1554	\$1632	\$1741	\$1502	\$2206	\$2473
-----------	--------	--------	--------	--------	--------	--------	--------	--------	--------	--------	--------	--------	--------

COM/yds = 2½, COL/sq ft = 45

Ottoman

430-H3636	\$1276	\$1276	\$1294	\$1325	\$1418	\$1479	\$1549	\$1597	\$1684	\$1804	\$1508	\$2902	\$3199
-----------	--------	--------	--------	--------	--------	--------	--------	--------	--------	--------	--------	--------	--------

COM/yds = 2¾, COL/sq ft = 61

Sidewalk Collaborative Multi-Fabric Diagram

DESIGN STUDIO B DESIGN ORIGIN: UNITED STATES

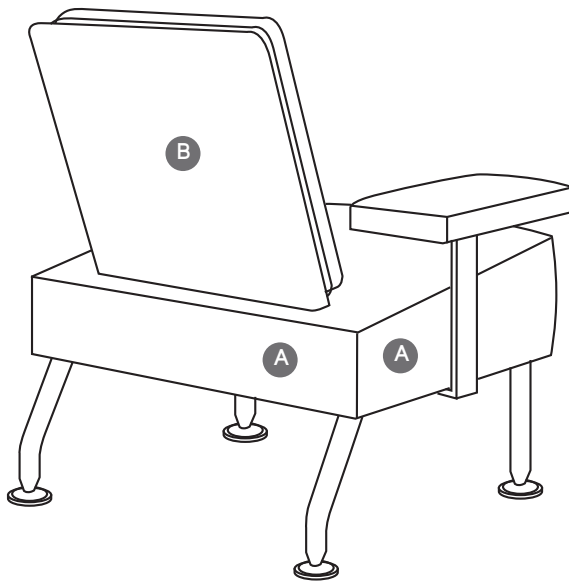
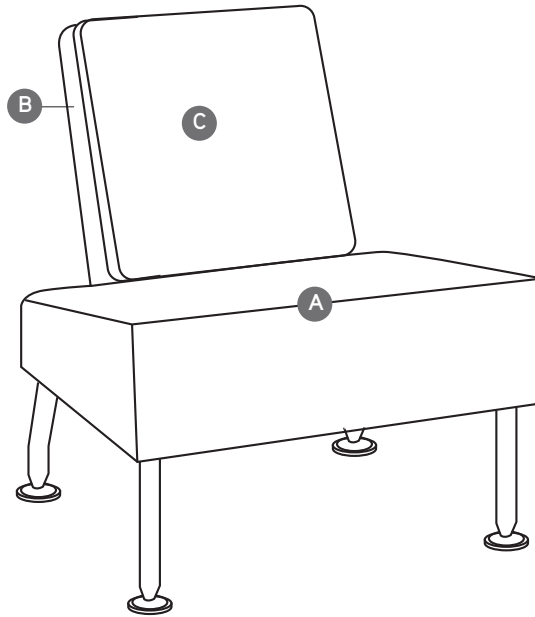

TO: _____

FROM: _____

DATE: _____

FAX...888.413.5161

A Upholstery Selection (default for entire unit if B is not selected): _____

B Back: _____

C Back Cushion: _____

Total list price upcharge for contrasting fabrics: \$ _____

\$118 U.S. list per contrasting fabric specified. List price based on highest fabric grade usage.

Lounge Seating

For Canadian Pricing
Multiply U.S. Price by the Canadian price factor.
▶ See page 1 for details.

SW_1 Collaborative Lounge Seating

DESIGN SCOTT WILSON & MINIMAL DESIGN ORIGIN: UNITED STATES



Overall: 28¼"D 32¼"W 36¾"H
 Seat: 16"H
 Arm: 23"H
 Pillow Overall: 4"D 16½"W 10½"H



Overall: 30"D 32¼"W 41¾"H
 Seat: 16"H
 Arm: 23"H
 Pillow Overall: 4"D 16½"W 10½"H



Overall: 20"D 23"W 14"H

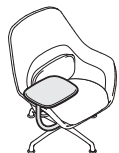

Tip: Handedness is determined while in the seated position.



For Canadian Pricing
 Multiply U.S. Price by the Canadian price factor.
 ▶ See page 1 for details.

Specification Information

Style Number	U.S. Base Prices														Leather Grades:		
	Fabric Grades:														COL	C	E
	COM	6	7	8	9	10	11	12	13	14							

Lowback Collaborative Lounge Swivel Return Chairs

COW612	\$2392	\$2392	\$2412	\$2445	\$2547	\$2613	\$2689	\$2472	\$2836	\$2967	\$2563	\$3333	\$3444
COM/yds = 3, COL/sq ft = 60													
Pillow COM/yds = 1¼, COL/sq ft = 27½													

Highback Collaborative Lounge Swivel Return Chairs

COW712	\$2736	\$2736	\$2756	\$2789	\$2891	\$2957	\$3033	\$3086	\$3180	\$3311	\$2907	\$3677	\$3788
COM/yds = 3, COL/sq ft = 60													
Pillow COM/yds = 1¼, COL/sq ft = 27½													

Ottoman

COW210	\$1088	\$1082	\$1089	\$1100	\$1134	\$1156	\$1181	\$1199	\$1230	\$1274	\$1322	\$1426	\$1467
COM/yds = 1, COL/sq ft = 22													

Specification Information

D	W	H (From Floor)	Style Number	U.S. Base Price
---	---	-------------------	--------------	-----------------

Left-Hand Tablet

15"	12"	25 ³ / ₁₆ "	COWTABL	\$670
-----	-----	-----------------------------------	----------------	-------

Right-Hand Tablet

15"	12"	25 ³ / ₁₆ "	COWTABR	\$670
-----	-----	-----------------------------------	----------------	-------

SW_1 Low Collaborative Conference Tables

DESIGN SCOTT WILSON & MINIMAL



Tip: Your specification is not complete until you add the fifth letter to the style number to define top surface.

- L - Laminate top
- V - Wood veneer top
- C - Corian top
- G - Glass top

Tip: Standard grain direction runs the width of the table (front-to back).

Tip: If grommet with wire manager is selected, the finish is not selectable, it will be the same as the substructure finish choice.

Tip: Tablets are an optional pick for the 42" and 84" square and 84"L and 120"L rectangular tables only. Tablets are available in black or milk finish.

Veneer direction



Standard Includes	Required to Specify
<ul style="list-style-type: none"> 1/2" thick top surface: <ul style="list-style-type: none"> - Laminate (Grade 1) with 3 mm edge band, if selected - Wood veneer (Grade 1) with matching 3 mm edge band, if selected - Corian, if selected: white only - Glass, if selected 1/4" thick bottom substructure: black or milk • Base, column, and cone: 8040 Polished Matte Aluminum • Glides • Ships ready-to assemble 	<p>1 Style number with appropriate top series letter indicated in the space provided. (For example: COWX_Q42 becomes COWXLQ42 for a laminate top surface):</p> <ul style="list-style-type: none"> L - Laminate top V - Wood veneer top C - Corian top G - Glass top <p>2 Laminate, wood, or glass color number for top, if selected</p> <p>3 Plastic color for edge band of laminate top, if selected</p> <p>4 Bottom substructure: 6000 Black 6052 Milk</p> <p>5 Options, if selected (see below) ▶ See <i>Coalesse Surface Materials Reference Guide</i>.</p>

	Options	U.S. Price	Required to Specify
Surface Materials	Laminate		
	• Grade 2 laminate	Prices at right	Specify with <i>Grade 2 laminate</i> and select color number.
	Wood		
	• Grade 2 wood veneer	Prices at right	Specify with <i>Grade 2 wood veneer</i> and select color number.
	• Stain-to-Match	No cost	Specify with <i>Stain-to-Match</i> .
Wood Veneer Grain Direction	• Lengthwise grain direction for tops up to 96"L	No cost	Specify with <i>lengthwise grain direction</i> .
Grommet with Wire Management	42" square and 120"L tables (center only)		
	• One grommet	+\$ 196	Specify with <i>one grommet with wire manager</i> .
	60" and 72" large round and square tables		
	• One grommet	+\$ 196	Specify with <i>one grommet with wire manager</i> .
	• Two grommets	+\$ 392	Specify with <i>two grommets with wire manager</i> .
	84" and 96" large round and square tables		
	• Two grommets	+\$ 392	Specify with <i>two grommets with wire manager</i> .
• Four grommets	+\$ 784	Specify with <i>four grommets with wire manager</i> .	
72"L, 84"L, and 96"L tables (end (V-leg) location only)	• One grommet	+\$ 196	Specify with <i>one grommet with wire manager</i> .
	72"L, 84"L, 96"L, and 120"L tables (outer ends (V-legs) location only)		
	• Two grommets	+\$ 392	Specify with <i>two grommets with wire manager</i> .
Tablets	42" square tables		
	• Two tablets: black or milk plastic	+\$ 934	Specify with <i>two tablets</i> and select plastic color number.
	• Four tablets: black or milk plastic	+\$1868	Specify with <i>four tablets</i> and select plastic color number.
	84"L rectangular tables		
	• Six tablets: black or milk plastic	+\$2802	Specify with <i>six tablets</i> and select plastic color number.
84" square table and 120"L rectangular tables	• Eight tablets: black or milk plastic	+\$3736	Specify with <i>eight tablets</i> and select plastic color number.

Related Products	• SW_1 lounge	▶ Page 228
-------------------------	---------------	------------

SW_1 Low Collaborative Conference Tables

DESIGN SCOTT WILSON & MINIMAL

Tip: Your specification is not complete until you add the fifth letter to the style number to define top surface.

- L - Laminate top
- V - Wood veneer top
- C - Corian top
- G - Glass top

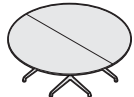
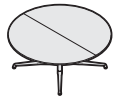

Tip: 60" and 72" round and square table base consists of four single legs. The 84" and 96" round and square table base consists of four v-legs.



Tip: Tablets are an optional pick for the 42" square tables only.

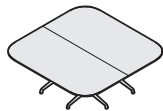
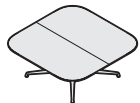

Veneer direction



For Canadian Pricing
Multiply U.S. Price by the Canadian price factor.

► See page 1 for details.

Specification Information

Dimensions			Style Number	# of (optional) Tablets	U.S. Base Prices					Corian	Glass	
L	W	H			Laminate	Veneer		Wedge Veneer Layup				
				Grade 1	Grade 2	Grade 1	Grade 2	Grade 1	Grade 2			
Large Round												
One-Piece Top												
60" dia	26"		COWX_RND60	N.A.	\$3072	\$3179	\$4306	\$4688	\$ 7276	\$ 7634	\$ 6454	\$ 7694
Two-Piece Top												
72" dia	26"		COWX_RND72	N.A.	\$3936	\$4071	\$5661	\$6162	\$ 9565	\$10,035	\$ 8267	\$ 9843
84" dia	26"		COWX_RND84	N.A.	\$4904	\$5073	\$7151	\$7787	\$12,084	\$12,694	\$11,768	\$13,487
96" dia	26"		COWX_RND96	N.A.	\$6143	\$6355	\$9055	\$9859	\$15,301	\$16,051	\$12,902	\$15,359

Square

42"	42"	26"	COWX_Q42	2 or 4	\$1980	\$2038	\$2831	\$3064	N.A.	N.A.	\$ 2948	\$ 4012
-----	-----	-----	----------	--------	--------	--------	--------	--------	------	------	---------	---------

Large Square

One-Piece Top												
60"	60"	26"	COWX_SQ60	N.A.	\$3162	\$3271	\$4425	\$4818	N.A.	N.A.	\$ 6633	\$ 8053
Two-Piece Top												
72"	72"	26"	COWX_SQ72	N.A.	\$4026	\$4166	\$5780	\$6293	N.A.	N.A.	\$ 8447	\$10,199
84"	84"	26"	COWX_SQ84	8	\$4993	\$5165	\$7272	\$7917	N.A.	N.A.	\$11,948	\$13,844
96"	96"	26"	COWX_SQ96	N.A.	\$6233	\$6448	\$9174	\$9988	N.A.	N.A.	\$13,081	\$15,716

► Specification Information, continued on next page

SW_1 Low Collaborative Conference Tables *continued*

DESIGN SCOTT WILSON & MINIMAL

► Specification Information, continued from previous page

Tip: Your specification is not complete until you add the fifth letter to the style number to define top surface.

- L - Laminate top
- V - Wood veneer top
- C - Corian top
- G - Glass top

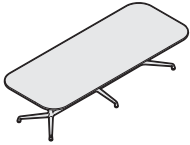

Tip: 96" L corian and glass tables require a center in-line leg as standard. The 96" L laminate and veneer tables do not require a center in-line leg for support. Refer to base matrix. ► See Coalesse Surface Materials Reference Guide.

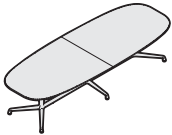

Specification Information

Dimensions			Style Number	# of (optional) Tablets	U.S. Base Prices			
L	W	H			Laminate Grade 1	Veneer Grade 1	Corian Grade 2	Glass

Rectangular

84"	42"	26"	COWX_R4284	6	\$2864	\$2980	\$3953	\$4390	\$ 6682	\$ 7862
120"	42"	26"	COWX_R4120	8	\$3988	\$4152	\$6374	\$7015	\$11,220	\$13,818

Super Elliptical

One-Piece Top

72"	40"	26"	COWX_SE4072	N.A.	\$2274	\$2367	\$3361	\$3715	\$ 6505	\$ 7686
84"	40"	26"	COWX_SE4084	N.A.	\$2924	\$3040	\$4012	\$4449	\$ 6859	\$ 8040
96"	40"	26"	COWX_SE4096	N.A.	\$3338	\$3465	\$4425	\$4949	\$ 7213	\$ 8631
120"	44"	26"	COWX_SE4120	N.A.	\$4106	\$4285	\$6493	\$7191	\$11,457	\$14,055

*Tablets are only available as an option on square tables.

Two-Piece Top

120"	44"	26"	COWX_SE4122	N.A.	\$4461	\$4640	\$6848	\$7546	\$11,810	\$14,410
------	-----	-----	-------------	------	--------	--------	--------	--------	----------	----------



For Canadian Pricing
 Multiply U.S. Price by the Canadian price factor.
 ► See page 1 for details.

SW_1 Lounge Chair & Guest Chair

DESIGN STUDIO B DESIGN ORIGIN: UNITED STATES

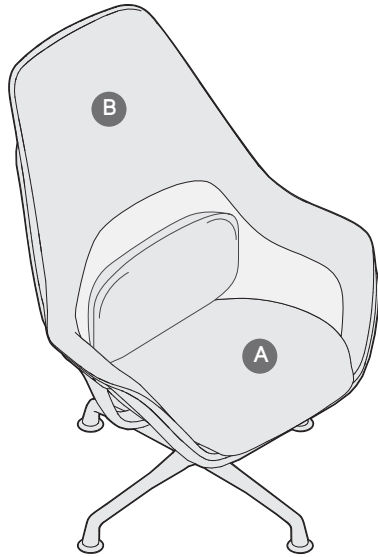

TO: _____

FROM: _____

DATE: _____

FAX....888.413.5161

A Seat: _____

B Arms/Back: _____

Contrasting fabric charges will apply. List price based on highest grade textile specified.

Specify Model below:

- COW412K Guest Chair with Glides
- COW414K Guest Chair with Casters
- COW612K Lowback Lounge Chair
- COW712K Highback Lounge Chair

Swathmore Wood Leg

DESIGN MICHAEL SHIELDS DESIGN ORIGIN: UNITED STATES

 = Available in Rapid10.

Tip: Fabrics and leathers will appear loose with comfort wrinkles when upholstered.

Tip: All cushions are attached.

Tip: Recommended leathers are Elmosoft Grade C and Elmorustical Grade E.

Tip: Special color match, consult Customer Service.

Tip: For Customer's Own Material or Leather, see necessary requirements, important processing instructions, and ordering information
 ▶ See *Coalesse Surface Materials Reference Guide*.

Standard Includes

- Frame: unibody construction with finger jointed plywood.
- Upholstery: multiple densities of polyurethane foam and polyester fiber on seat, back, and arm cushions
- Legs: solid maple
- Glides: 1½" dia. non-adjustable metal

Required to Specify

- 1 Style number
 - 2 Number of fabrics if contrasting fabric style number is selected
 - 3 Fabric or leather color number for upholstery on seat, back, and arms
 - 4 Wood color number for legs
 - 5 Options, if selected (see below)
- ▶ See *Coalesse Surface Materials Reference Guide*.

Options

Options	U.S. Price	Required to Specify
Surface Materials		
• Contrasting fabric	+\$118 per fabric	Add suffix K to the style number and select fabric color number.
• Contrasting welt	+\$134	Specify with <i>contrasting welt</i> and select fabric color number.
Acrylic backer		
• Chair	+\$ 37	Specify with <i>acrylic backer</i> .
• Two-seat sofa	+\$ 50	Specify with <i>acrylic backer</i> .
• Three-seat sofa	+\$ 76	Specify with <i>acrylic backer</i> .
		▶ See <i>Coalesse Surface Materials Reference Guide</i> .
Arm Caps		
• Wood arm caps	+\$210	Add suffix WA to the style number.

Specification Information

Style Number	U.S. Base Prices													
	Fabric Grades:											Leather Grades:		
	COM	6	7	8	9	10	11	12	13	14	COL	C	E	

Chair with Wood Legs

 240	\$1454	\$1470	\$1532	\$1591	\$1718	\$1787	\$1837	\$1933	\$1984	\$2218	\$1649	\$3019	\$3424
--	--------	--------	--------	--------	--------	--------	--------	--------	--------	--------	--------	--------	--------

COM/yds = 4, COL/sq ft = 88

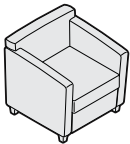

Overall: 27½"D 27"W 28½"H
 Inside: 19"D 20"W 14"H
 Seat: 17"H
 Arm: 25"H

Two-Seat Sofa with Wood Legs

 240-2	\$2463	\$2445	\$2523	\$2626	\$2770	\$2961	\$3138	\$3197	\$3280	\$3685	\$2645	\$4396	\$4899
--	--------	--------	--------	--------	--------	--------	--------	--------	--------	--------	--------	--------	--------

COM/yds = 5½, COL/sq ft = 121

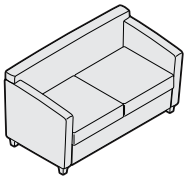

Overall: 27½"D 51"W 29"H
 Inside: 19"D 44"W 14"H
 Seat: 17"H
 Arm: 25"H

Three-Seat Sofa with Wood Legs

 240-3	\$3082	\$3115	\$3217	\$3353	\$3542	\$3771	\$4006	\$4057	\$4163	\$4679	\$3258	\$5614	\$6172
--	--------	--------	--------	--------	--------	--------	--------	--------	--------	--------	--------	--------	--------

COM/yds = 7, COL/sq ft = 154

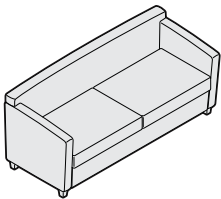

Overall: 27½"D 67"W 29½"H
 Inside: 19"D 60"W 14"H
 Seat: 17"H
 Arm: 25"H

Swathmore Louver

DESIGN MICHAEL SHIELDS DESIGN ORIGIN: UNITED STATES

Tip: Fabrics and leathers will appear loose with comfort wrinkles when upholstered.

Tip: All cushions are attached.

Tip: Recommended leathers are Elmosoft Grade C and Elmorustical Grade E.

Tip: Special color match, consult Customer Service.

Tip: For Customer's Own Material or Leather, see necessary requirements, important processing instructions, and ordering information
 ▶ See *Coalesse Surface Materials Reference Guide*.

Standard Includes		Required to Specify	
	<ul style="list-style-type: none"> • Frame: unibody construction with finger jointed plywood. • Upholstery: multiple densities of polyurethane foam and polyester fiber on seat, back, and arm cushions • Base/legs: solid maple • Glides: 1½" dia. non-adjustable metal 		<ol style="list-style-type: none"> 1 Style number 2 Number of fabrics if contrasting fabric style number is selected 3 Fabric or leather color number for upholstery on seat, back, and arms 4 Wood color number for base 5 Options, if selected (see below) ▶ See <i>Coalesse Surface Materials Reference Guide</i> .
Options		U.S. Price	Required to Specify
Surface Materials	• Contrasting fabric	+\$118 per fabric	Add suffix K to the style number and select fabric color number. Specify with <i>contrasting welt</i> and select fabric color number.
	• Contrasting welt	+\$134	
	Acrylic backer		Specify with <i>acrylic backer</i> . Specify with <i>acrylic backer</i> . Specify with <i>acrylic backer</i> . ▶ See <i>Coalesse Surface Materials Reference Guide</i> .
	• Chair	+\$ 37	
	• Two-seat sofa	+\$ 50	
	• Three-seat sofa	+\$ 76	
Arm Caps	• Wood arm caps	+\$210	Add suffix WA to the style number.

Specification Information														
Style Number	U.S. Base Prices											Leather Grades:		
	Fabric Grades:											COL	C	E
	COM	6	7	8	9	10	11	12	13	14				

Chair with Wood Louver Base

241	\$2043	\$2020	\$2089	\$2167	\$2281	\$2434	\$2573	\$2625	\$2695	\$3028	\$2232	\$3559	\$3984
-----	--------	--------	--------	--------	--------	--------	--------	--------	--------	--------	--------	--------	--------

COM/yds = 4, COL/sq ft = 88

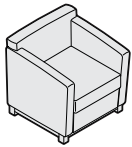

Overall: 27½"D 27"W 28½"H
 Inside: 19"D 20"W 14"H
 Seat: 17"H
 Arm: 25"H

Two-Seat Sofa with Wood Louver Base

241-2	\$3051	\$3002	\$3100	\$3199	\$3358	\$3563	\$3759	\$3810	\$3939	\$4443	\$3233	\$5124	\$5686
-------	--------	--------	--------	--------	--------	--------	--------	--------	--------	--------	--------	--------	--------

COM/yds = 5½, COL/sq ft = 121

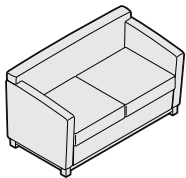

Overall: 27½"D 51"W 29"H
 Inside: 19"D 44"W 14"H
 Seat: 17"H
 Arm: 25"H

Three-Seat Sofa with Wood Louver Base

241-3	\$3932	\$3908	\$4086	\$4228	\$4494	\$4749	\$5015	\$5074	\$5227	\$5886	\$4109	\$6745	\$7325
-------	--------	--------	--------	--------	--------	--------	--------	--------	--------	--------	--------	--------	--------

COM/yds = 7, COL/sq ft = 154

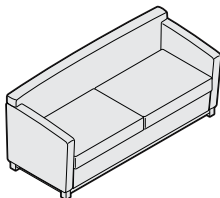

Overall: 27½"D 67"W 29½"H
 Inside: 19"D 60"W 14"H
 Seat: 17"H
 Arm: 25"H

Swathmore Grande Wood Leg

DESIGN MICHAEL SHIELDS DESIGN ORIGIN: UNITED STATES

 = Available in Rapid10.

Tip: Fabrics and leathers will appear loose with comfort wrinkles when upholstered.

Tip: All cushions are attached.

Tip: Recommended leathers are Elmosoft Grade C and Elmorustical Grade E.

Tip: Special color match, consult Customer Service.

Tip: For Customer's Own Material or Leather, see necessary requirements, important processing instructions, and ordering information
 ► See *Coalesse Surface Materials Reference Guide*.

Tip: Tablet not available on wood armcap models.

Tip: Tablet worksurface is 21⁵/₈" x 11⁵/₈".

Standard Includes	Required to Specify
<ul style="list-style-type: none"> • Frame: unibody construction with finger jointed plywood • Upholstery: multiple densities of polyurethane foam and polyester fiber on seat, back, and arm cushions • Legs: solid maple • Glides: 1¹/₈" dia. non-adjustable metal 	<ol style="list-style-type: none"> 1 Style number 2 Number of fabrics if contrasting fabric style number is selected 3 Fabric or leather color number for upholstery on seat, back, and arms 4 Wood color number for legs 5 Options, if selected (see below) ► See <i>Coalesse Surface Materials Reference Guide</i> .

Options	U.S. Price	Required to Specify
Surface Materials	<ul style="list-style-type: none"> • Contrasting fabric +\$118 per fabric • Contrasting welt +\$134 	Add suffix K to the style number and select fabric color number. Specify with <i>contrasting welt</i> and select fabric color number.
Acrylic backer		
<ul style="list-style-type: none"> • Chair +\$ 46 • Three-seat sofa +\$ 76 • 30"W bariatric chair +\$ 54 • 40"W bariatric chair +\$ 63 		Specify with <i>acrylic backer</i> . Specify with <i>acrylic backer</i> . Specify with <i>acrylic backer</i> . Specify with <i>acrylic backer</i> . ► See <i>Coalesse Surface Materials Reference Guide</i> .
Arm Caps	<ul style="list-style-type: none"> • Wood arm caps +\$210 	Add suffix WA to the style number.
Tablet (243 only)	<ul style="list-style-type: none"> • Laminate tablet +\$327 • Wood tablet +\$554 	Specify with <i>laminate tablet</i> . Specify with <i>wood tablet</i> .

Specification Information													
Style Number	U.S. Base Prices											Leather Grades:	
	Fabric Grades:											COL	C
	COM	6	7	8	9	10	11	12	13	14			

Chair with Wood Legs

 243	\$1913	\$1922	\$1993	\$2077	\$2265	\$2420	\$2572	\$2666	\$2718	\$3036	\$2090	\$3550	\$3986
--	--------	--------	--------	--------	--------	--------	--------	--------	--------	--------	--------	--------	--------

COM/yds = 5, COL/sq ft = 110

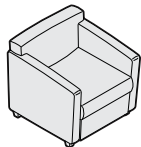

Overall: 30"D 30"W 29¹/₂"H
 Inside: 20"D 21³/₄"W 15"H
 Seat: 16³/₄"H
 Arm: 24"H

Three-Seat Sofa with Wood Legs

 243-3	\$3492	\$3558	\$3679	\$3827	\$4035	\$4309	\$4569	\$4626	\$4737	\$5321	\$3676	\$6424	\$7036
--	--------	--------	--------	--------	--------	--------	--------	--------	--------	--------	--------	--------	--------

COM/yds = 8, COL/sq ft = 176

► Specification Information, continued on next page

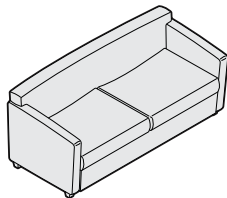

Overall: 30"D 70"W 30¹/₂"H
 Inside: 20"D 61³/₄"W 15"H
 Seat: 16³/₄"H
 Arm: 24"H

For Canadian Pricing
 Multiply U.S. Price by the Canadian price factor.
 ► See page 1 for details.

Swathmore Grande Wood Leg

DESIGN MICHAEL SHIELDS DESIGN ORIGIN: UNITED STATES

 = Available in Rapid10.

► Specification Information, continued from previous page

Specification Information

Style Number	U.S. Base Prices											Leather Grades:		
	Fabric Grades:											COL	C	E
	COM	6	7	8	9	10	11	12	13	14				

Chair with Wood Legs–Bariatric with 30" Large Scale

243B-30	\$2342	\$2402	\$2472	\$2522	\$2613	\$2707	\$2872	\$3037	\$3205	\$3592	\$2532	\$5462	\$5995
----------------	--------	--------	--------	--------	--------	--------	--------	--------	--------	--------	--------	--------	--------

COM/yds = 6, COL/sq ft = 127

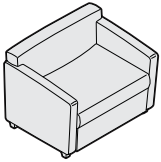

Overall: 30"D 38¼"W 29½"H
 Inside: 20"D 30"W 15"H
 Seat: 16¾"H
 Arm: 24"H

Chair with Wood Legs–Bariatric with 40" Large Scale

243B-40	\$2642	\$2722	\$2805	\$2848	\$2970	\$3057	\$3249	\$3439	\$3627	\$4066	\$2818	\$6150	\$6737
----------------	--------	--------	--------	--------	--------	--------	--------	--------	--------	--------	--------	--------	--------

COM/yds = 6½, COL/sq ft = 143

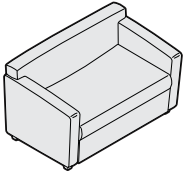

Overall: 30"D 48¼"W 29½"H
 Inside: 20"D 40"W 15"H
 Seat: 16¾"H
 Arm: 24"H

Lounge Seating

For Canadian Pricing
 Multiply U.S. Price by the
 Canadian price factor.
 ► See page 1 for details.

Swathmore Grande Louver

DESIGN MICHAEL SHIELDS DESIGN ORIGIN: UNITED STATES

Tip: Fabrics and leathers will appear loose with comfort wrinkles when upholstered.

Tip: All cushions are attached.

Tip: Recommended leathers are Elmosoft Grade C and Elmorustical Grade E.

Tip: Special color match, consult Customer Service.

Tip: For Customer's Own Material or Leather, see necessary requirements, important processing instructions, and ordering information
 ▶ See *Coalesse Surface Materials Reference Guide*.

Standard Includes

- Frame: unibody construction with finger jointed plywood
- Upholstery: multiple densities of polyurethane foam and polyester fiber on seat, back, and arm cushions
- Legs: solid maple
- Glides: 1½" dia. non-adjustable metal

Required to Specify

- 1 Style number
 - 2 Number of fabrics if contrasting fabric style number is selected
 - 3 Fabric or leather color number for upholstery on seat, back, and arms
 - 4 Wood color number for frame and legs
 - 5 Options, if selected (see below)
- ▶ See *Coalesse Surface Materials Reference Guide*.

Options

Options	U.S. Price	Required to Specify
Surface Materials		
• Contrasting fabric	+\$118 per fabric	Add suffix K to the style number and select fabric color number.
• Contrasting welt	+\$134	Specify with <i>contrasting welt</i> and select fabric color number.
Acrylic backer		
• Chair	+\$ 46	Specify with <i>acrylic backer</i> .
• Two-seat sofa	+\$ 60	Specify with <i>acrylic backer</i> .
• Three-seat sofa	+\$ 76	Specify with <i>acrylic backer</i> .
		▶ See <i>Coalesse Surface Materials Reference Guide</i> .
Arm Caps		
• Wood arm caps	+\$210	Add suffix WA to the style number.

Specification Information

Style Number	U.S. Base Prices													
	Fabric Grades:											Leather Grades:		
	COM	6	7	8	9	10	11	12	13	14	COL	C	E	

Chair with Wood Louver

244	\$2578	\$2570	\$2627	\$2726	\$2861	\$3021	\$3191	\$3249	\$3349	\$3771	\$2762	\$4342	\$4795
-----	--------	--------	--------	--------	--------	--------	--------	--------	--------	--------	--------	--------	--------

COM/yds = 5, COL/sq ft = 110

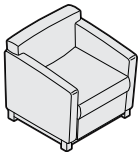

Overall: 30"D 30"W 29½"H
 Inside: 20"D 21¾"W 15"H
 Seat: 16¾"H
 Arm: 24"H

Two-Seat Sofa with Wood Louver

244-2	\$3633	\$3615	\$3713	\$3839	\$4024	\$4246	\$4480	\$4533	\$4688	\$5292	\$3822	\$6056	\$6663
-------	--------	--------	--------	--------	--------	--------	--------	--------	--------	--------	--------	--------	--------

COM/yds = 6½, COL/sq ft = 143

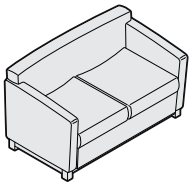

Overall: 30"D 54"W 30"H
 Inside: 20"D 45¾"W 15"H
 Seat: 16¾"H
 Arm: 24"H

Three-Seat Sofa with Wood Louver

244-3	\$4188	\$4186	\$4381	\$4546	\$4864	\$5156	\$5443	\$5526	\$5671	\$6378	\$4372	\$7437	\$8078
-------	--------	--------	--------	--------	--------	--------	--------	--------	--------	--------	--------	--------	--------

COM/yds = 8, COL/sq ft = 176

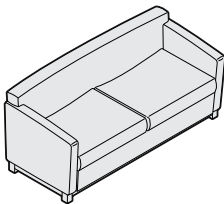

Overall: 30"D 70"W 30½"H
 Inside: 20"D 61¾"W 15"H
 Seat: 16¾"H
 Arm: 24"H

Swathmore Grande Mobile

DESIGN MICHAEL SHIELDS DESIGN ORIGIN: UNITED STATES

 = Available in Rapid10.

Tip: Fabrics and leathers will appear loose with comfort wrinkles when upholstered.

Tip: Soft casters are not available.

Tip: Wilsonart standard laminate colors.

► See *Coalesse Surface Materials Reference Guide*.

Tip: Recommended leathers are Elmosoft Grade C and Elmorustical Grade E.

Tip: Special color match, consult Customer Service.

Tip: For Customer's Own Material or Leather, see necessary requirements, important processing instructions, and ordering information

► See *Coalesse Surface Materials Reference Guide*.

Tip: Tablet worksurface is 21⁵/₈" x 11⁵/₈".

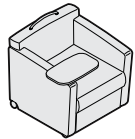

Overall: 30"D 30"W 29½"H
 Inside: 20"D 21¾"W 15"H
 Seat: 16¾"H
 Arm: 24"H

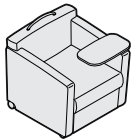

Overall: 30"D 30"W 29½"H
 Inside: 20"D 21¾"W 15"H
 Seat: 16¾"H
 Arm: 24"H



For Canadian Pricing
 Multiply U.S. Price by the Canadian price factor.
 ► See page 1 for details.

Standard Includes		Required to Specify	
	<ul style="list-style-type: none"> Frame: unibody construction with finger jointed plywood Hard casters: rear locking Steel push handle: black Pivoting worksurface tablet: laminate 		<ol style="list-style-type: none"> Style number Number of fabrics if contrasting fabric style number is selected Fabric or leather color number for upholstery on seat, back, and arms Laminate color for tablet Options, if selected (see below) ► See <i>Coalesse Surface Materials Reference Guide</i> .
Options		U.S. Price	Required to Specify
Surface Materials	• Contrasting fabric	+\$118 per fabric	Add suffix K to the style number and select fabric color number. Specify <i>with contrasting welt</i> and select fabric color number.
	• Contrasting welt	+\$134	
	Acrylic backer		
	• Backer	+\$ 46	Specify <i>with acrylic backer</i> . ► See <i>Coalesse Surface Materials Reference Guide</i> .
Tablet	• Omit tablet	-\$239	Specify <i>with omit tablet</i> .
	• Wood tablet	+\$276	Specify <i>with wood tablet</i> .
Omit Push Handle	• Omit push handle	-\$ 30	Specify <i>with omit push handle</i> .

Specification Information													
Style Number	U.S. Base Prices											Leather Grades:	
	Fabric Grades:											COL	C
	COM	6	7	8	9	10	11	12	13	14			

Chair with Tablet Left Facing

 243MTL	\$2432	\$2429	\$2492	\$2595	\$2808	\$2980	\$3159	\$3249	\$3334	\$3739	\$2614	\$4285	\$4752
COM/yds = 5, COL/sq ft = 110													

Chair with Tablet Right Facing

 243MTR	\$2432	\$2429	\$2492	\$2595	\$2808	\$2980	\$3159	\$3249	\$3334	\$3739	\$2614	\$4285	\$4752
COM/yds = 5, COL/sq ft = 110													

Switch

DESIGN EOOS DESIGN ORIGIN: GERMANY

Tip: Fabrics and leathers will appear loose with comfort wrinkles when upholstered.

Tip: Due to seat conversion arms are 4 1/2"W. Lowered arm has weight limit of 500 lb.

Tip: Recommended leathers are Elmosoft Grade C and Elmorustical Grade E.

► For multi-fabric diagram, see page 242.

Tip: Loose cushions standard.

Tip: Arm bolsters must be specified separately.

Tip: Special color match, consult Customer Service.

Tip: For Customer's Own Material or Leather, see necessary requirements, important processing instructions, and ordering information
► See Coalesse Surface Materials Reference Guide.

Tip: 391-4 two seat with extensions, when extended: Both arms = 96"W overall One arm = 84"W overall Arms not extended = 71"W overall (closed).

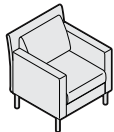

Overall: 29 1/2"D 28"W 32 1/2"H
Inside: 19"D 20"W 17"H
Seat: 17 1/2"H
Arm: 26"H

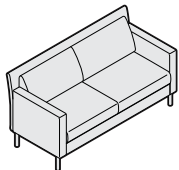

Overall: 29 1/2"D 63"W 32 1/2"H
Inside: 19"D 55"W 17"H
Seat: 17 1/2"H
Arm: 26"H



For Canadian Pricing
Multiply U.S. Price by the Canadian price factor.
► See page 1 for details.

Standard Includes

- Selected solid hardwood and wood veneer frame
- Two seat with extension: tubular steel frame with solid hardwood arms
 - Arms are 4.5" wide
- Upholstery: multiple densities of polyurethane foam and polyester fiber on seat back and arms
- Legs: matte chrome finish on steel
- Arm bolster, if selected: fabric or leather

Required to Specify

- 1 Style number
 - 2 Number of fabrics if contrasting fabric style number is selected
 - 3 Fabric or leather color number for upholstery on seat, back, and arms, or arm bolsters, if selected
 - 4 Options, if selected (see below)
- See Coalesse Surface Materials Reference Guide.

Options

Options	U.S. Price	Required to Specify
Surface Materials	• Contrasting fabric +\$118 per fabric	Add suffix K to the style number and select fabric color number.
Acrylic backer		Specify with acrylic backer.
• Chair	+\$ 41	Specify with acrylic backer.
• Two-seat chair	+\$ 72	Specify with acrylic backer.
• Three-seat chair	+\$ 76	Specify with acrylic backer.
• Two-seat chair with extensions	+\$ 91	Specify with acrylic backer.
• Arm bolster	+\$ 8	Specify with acrylic backer.
		► See Coalesse Surface Materials Reference Guide.
Attachment Straps		Specify with attachment straps.
• 391	+\$123	Specify with attachment straps.
• 391-2	+\$246	Specify with attachment straps.
• 391-3	+\$369	Specify with attachment straps.
• 391-4	+\$246	Specify with attachment straps.
• Bolster	+\$ 63	Specify with attachment straps.

Specification Information

Style Number	U.S. Base Prices														Leather Grades:		
	Fabric Grades:														COL	C	E
	COM	6	7	8	9	10	11	12	13	14							

Chair

391	\$2456	\$2460	\$2490	\$2540	\$2693	\$2792	\$2906	\$2986	\$3127	\$3324	\$2628	\$5152	\$5828
-----	--------	--------	--------	--------	--------	--------	--------	--------	--------	--------	--------	--------	--------

COM/yds = 4 1/2, COL/sq ft = 99

Two-Seat

391-2	\$3761	\$3868	\$3917	\$4001	\$4256	\$4420	\$4611	\$4744	\$4979	\$5307	\$3934	\$8042	\$9019
-------	--------	--------	--------	--------	--------	--------	--------	--------	--------	--------	--------	--------	--------

COM/yds = 7 1/2, COL/sq ft = 165

► Specification Information, continued on next page

Switch

DESIGN EOOS DESIGN ORIGIN: GERMANY

► Specification Information, continued from previous page

Specification Information

Style Number	U.S. Base Prices										Leather Grades:		
	Fabric Grades:										COL	C	E
	COM	6	7	8	9	10	11	12	13	14			

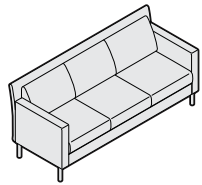

Overall: 29½"D 73½"W 32½"H
 Inside: 19"D 65½"W 17"H
 Seat: 17½"H
 Arm: 26"H

Three-Seat

391-3	\$4940	\$5064	\$5117	\$5206	\$5478	\$5653	\$5857	\$5998	\$6250	\$6599	\$5113	\$10,612	\$11,841
-------	--------	--------	--------	--------	--------	--------	--------	--------	--------	--------	--------	----------	----------

COM/yds = 8, COL/sq ft = 176

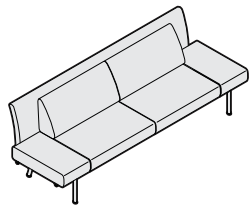

Sofa overall: 19"D 59"W 32½"H
 Overall extended: 33½"D 96"W 32½"H
 Sofa with one arm extended overall:
 19"D 77½"W 32½"H
 Seat: 17½"H
 Arm: 17½"H
 Both Arms Up: 59"
 One Arm Up: 77½"H

Two-Seat with Extensions

391-4	\$5233	\$5392	\$5451	\$5551	\$5857	\$6054	\$6283	\$6442	\$6725	\$7118	\$5406	\$11,705	\$13,078
-------	--------	--------	--------	--------	--------	--------	--------	--------	--------	--------	--------	----------	----------

COM/yds = 9, COL/sq ft = 198



Overall: 17½"D 5¾"Dia

Arm Bolster

391-B	\$ 245	\$ 239	\$ 246	\$ 257	\$ 291	\$ 313	\$ 338	\$ 356	\$ 387	\$ 431	\$ 533	\$ 797	\$ 1061
-------	--------	--------	--------	--------	--------	--------	--------	--------	--------	--------	--------	--------	---------

COM/yds = 1, COL/sq ft = 18

Lounge Seating



For Canadian Pricing
 Multiply U.S. Price by the
 Canadian price factor.
 ► See page 1 for details.

Switch Multi-Fabric Diagram

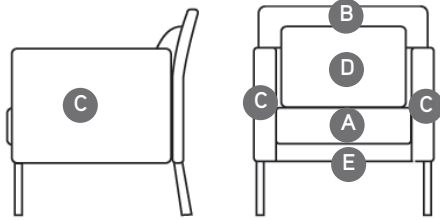

Model 391 Shown Above

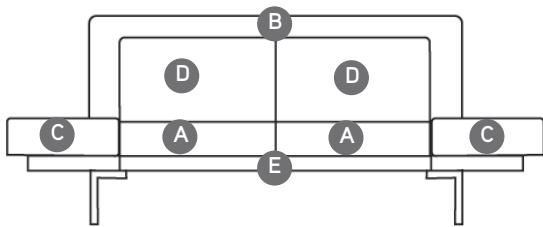

Model 391-4 Shown Above

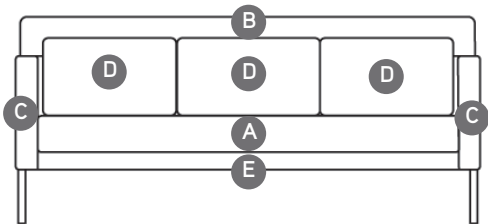

391-3 Shown Above

TO: _____

FROM: _____

DATE: _____

FAX....888.413.5161

A Seat (upholstery selections default for entire unit if B is not selected): _____

B Back: _____

C Arms: _____

D Back Cushion: _____

E Base Frame: _____

Due to soft nature of loose cushions, genuine leathers are recommended. All other textiles must be submitted for pre-approval.

Tip: Arm bolsters must be specified separately.

\$118 U.S. list per contrasting fabric specified. List price based on highest fabric grade usage.

Specify Model below:

391K Switch Chair

391-2K Switch Two Seat Sofa (not shown)

391-3K Switch Three Seat Sofa

391-4K Switch Two Seat with Extension



For Canadian Pricing
 Multiply U.S. Price by the
 Canadian price factor.
 ▶ See page 1 for details.

Coalesse

Switch Multi-Fabric Diagram

Thoughtful Lounge

DESIGN PAMELA LIGHT, FIIDA SHIELDS DESIGN ORIGIN: UNITED STATES

Tip: Fabrics and leathers will appear loose with comfort wrinkles when upholstered.

Tip: All polyurethane foam meets CAL-117 specifications.

Tip: Pricing based on highest grade textile specified.

Tip: Seats will always have some comfort wrinkles. The amount of wrinkles will vary depending on the fabric.

Tip: Welting COM yardage required = 1/2 yards or 22 square feet.

Tip: Recommended leathers are Elmosoft Grade C and Elmorustical Grade E.

Tip: Special color match, consult customer service.

Tip: For Customer's Own Material or Leather, see necessary requirements, important processing instructions, and ordering information
 ▶ See *Coalesse Surface Materials Reference Guide*.

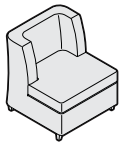

Overall: 29 3/4" D 28 3/4" W 32" H
Inside: 20" D 21 1/2" W 14 1/2" H
Seat: 17 1/2" H

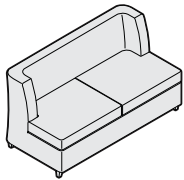

Overall: 30 1/4" D 60 3/4" W 32" H
Inside: 20 1/4" D 53 1/2" W 14 1/2" H
Seat: 17 1/2" H



For Canadian Pricing
 Multiply U.S. Price by the Canadian price factor.
 ▶ See page 1 for details.

Standard Includes

- Frame: unibody construction with finger jointed plywood
- Legs: maple or walnut wood
- Upholstery: multiple densities of polyurethane foam
- Double needle stitch on seams

Required to Specify

- 1 Style number
 - 2 Number of fabrics if contrasting fabric style number is selected
 - 3 Fabric or leather color number for upholstery on seat and back
 - 4 Wood species
 - 5 Wood color number for legs
 - 6 Options, if selected (see below)
- ▶ See *Coalesse Surface Materials Reference Guide*.

Options

Surface Materials	Options	U.S. Price	Required to Specify
	• Contrasting fabric	+\$118 per fabric	Add suffix K to the style number and select fabric color number.
	• Contrasting welt for welting around base of chair	+\$182	Specify with <i>contrasting welt</i> and select fabric color number.
	Acrylic backer		Specify with <i>acrylic backer</i> .
	• Lounge chair	+\$ 50	Specify with <i>acrylic backer</i> .
	• Small sofa	+\$ 95	Specify with <i>acrylic backer</i> .
	• Medium sofa	+\$105	Specify with <i>acrylic backer</i> .
	• Long sofa	+\$115	Specify with <i>acrylic backer</i> .
	• Ottoman	+\$ 24	Specify with <i>acrylic backer</i> .

▶ See *Coalesse Surface Materials Reference Guide*.

Specification Information

Style Number	U.S. Base Prices											Leather Grades:		
	Fabric Grades:											COL	C	E
	COM	6	7	8	9	10	11	12	13	14				

Lounge Chair

385	\$2110	\$2159	\$2221	\$2258	\$2361	\$2445	\$2679	\$2838	\$2936	\$3284	\$2286	\$5098	\$ 5599
------------	--------	--------	--------	--------	--------	--------	--------	--------	--------	--------	--------	--------	---------

COM/yds = 5 1/2, COL/sq ft = 121

Small Sofa

385-60	\$3845	\$4058	\$4180	\$4274	\$4458	\$4610	\$5069	\$5367	\$5551	\$6206	\$4022	\$9425	\$10,387
---------------	--------	--------	--------	--------	--------	--------	--------	--------	--------	--------	--------	--------	----------

COM/yds = 10 1/2, COL/sq ft = 231

▶ Specification Information, continued on next page

Thoughtful Lounge

DESIGN PAMELA LIGHT, FIIDA SHIELDS DESIGN ORIGIN: UNITED STATES

► Specification Information, continued from previous page

Specification Information

Style Number	U.S. Base Prices											Leather Grades:		
	Fabric Grades:											COL	C	E
	COM	6	7	8	9	10	11	12	13	14				

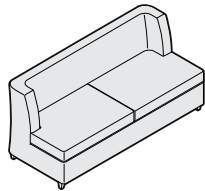

Overall: 30¾"D 70¾"W 32"H
 Inside: 20½"D 63½"W 14½"H
 Seat: 17½"H

Medium Sofa

385-70	\$5106	\$5369	\$5502	\$5598	\$5801	\$5967	\$6463	\$6807	\$7001	\$7924	\$5296	\$11,205	\$12,265
--------	--------	--------	--------	--------	--------	--------	--------	--------	--------	--------	--------	----------	----------

COM/yds = 11½, COL/sq ft = 253

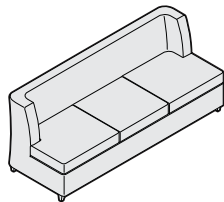

Overall: 31¼"D 80¾"W 32"H
 Inside: 20¾"D 73½"W 14½"H
 Seat: 17½"H

Long Sofa

385-80	\$5367	\$5655	\$5816	\$5922	\$6151	\$6323	\$6888	\$7264	\$7472	\$8382	\$5549	\$12,127	\$13,294
--------	--------	--------	--------	--------	--------	--------	--------	--------	--------	--------	--------	----------	----------

COM/yds = 12¾, COL/sq ft = 281

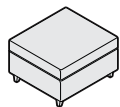

Overall: 26¼"D 28½"W 17¾"H

Ottoman

385-H	\$1549	\$1556	\$1587	\$1613	\$1660	\$1704	\$1825	\$1901	\$1944	\$2188	\$1789	\$ 3175	\$ 3423
-------	--------	--------	--------	--------	--------	--------	--------	--------	--------	--------	--------	---------	---------

COM/yds = 2¾, COL/sq ft = 61

Lounge Seating

 **For Canadian Pricing**
 Multiply U.S. Price by the
 Canadian price factor.
 ► See page 1 for details.

Thoughtful Multi-Fabric Diagram

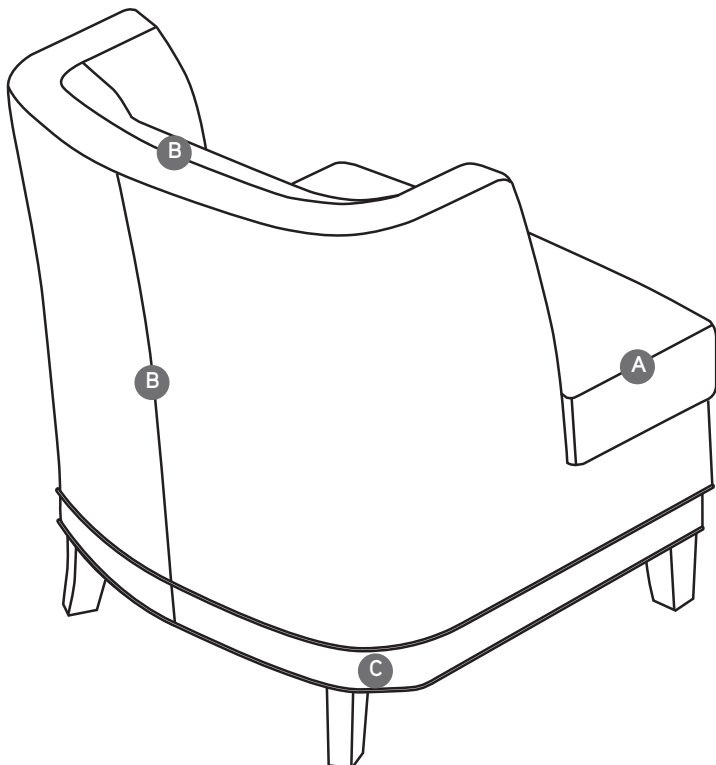
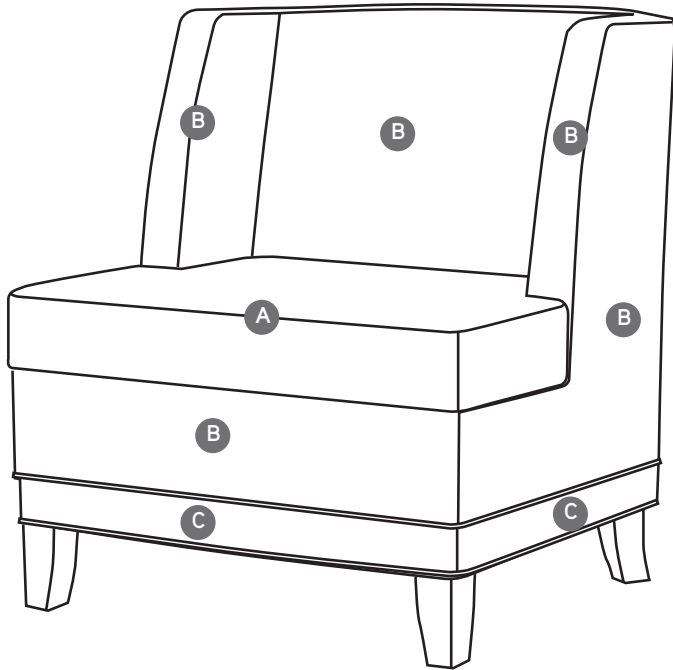

TO: _____

FROM: _____

DATE: _____

FAX...888.413.5161

A Seat (default for entire unit if B is not selected): _____

B Arms and Back: _____

C Base Frame: _____

Please indicate which model:

- 385K
- 385-60K
- 385-70K
- 385-80K

Total list price upcharge for contrasting fabrics:
\$ _____

\$118 U.S. list per contrasting fabric specified. List price based on highest fabric grade usage.

*Contrasting welt offered as a separate option \$182 upcharge.

Coalesse

Thoughtful Multi-Fabric Diagram

Together Bench by Walter Knoll

DESIGN EOOS DESIGN ORIGIN: 2004 GERMANY

Tip: Fabrics and leathers will appear loose with comfort wrinkles when upholstered.

▶ See page 254 for multi-fabric diagram.

▶ See page 255 for offset diagram.

Tip: For Customer's Own Material or Leather, see necessary requirements, important processing instructions, and ordering information
▶ See *Coalesse Surface Materials Reference Guide*.

Standard Includes	Required to Specify
-------------------	---------------------

<ul style="list-style-type: none"> Upholstery for chair: fabric or leather Glides 	<ol style="list-style-type: none"> Style number Number of fabrics if contrasting fabric style number is selected Fabric or leather color number for upholstery Options, if selected (see below) <p>▶ See <i>Coalesse Surface Materials Reference Guide</i>.</p>
---	---

Options	U.S. Price	Required to Specify
---------	------------	---------------------

Surface Materials <ul style="list-style-type: none"> Contrasting fabric <hr/> Acrylic backer <ul style="list-style-type: none"> 69³/₄"W straight bench without back 96¹/₂"W straight bench without back 26³/₄"D x 69³/₄"W benches 26³/₄"D x 96¹/₂"W benches 69³/₄"D x 96¹/₂"W benches 96¹/₂"D x 96¹/₂"W and 69³/₄"D x 123¹/₄"W benches 96¹/₂"D x 123¹/₄"W bench 	+\$118 per fabric +\$ 35 +\$ 39 +\$ 48 +\$ 58 +\$ 93 +\$105 +\$115	Add suffix K to the style number and select fabric color number. Specify with acrylic backer. Specify with acrylic backer. Specify with acrylic backer. Specify with acrylic backer. Specify with acrylic backer. Specify with acrylic backer. Specify with acrylic backer. ▶ See <i>Coalesse Surface Materials Reference Guide</i> .
Back Offset <ul style="list-style-type: none"> Back offset 	No cost	Specify with back offset.

Specification Information

Style Number	U.S. Base Prices											Leather Grades:		
	Fabric Grades:											COL	C	E
	COM	6	7	8	9	10	11	12	13	14				

Left Corner with Back, 8" Offset

COTO9669L8	\$7749	\$7933	\$7997	\$8106	\$8437	\$8651	\$8899	\$9071	\$ 9378	\$ 9804	\$7873	\$11,865	\$12,578
COM/yds = 9 ³ / ₄ , COL/sq ft = 215													

COTO9696L8	\$8349	\$8568	\$8638	\$8758	\$9123	\$9359	\$9632	\$9822	\$10,160	\$10,630	\$8473	\$12,881	\$13,667
COM/yds = 10 ³ / ₄ , COL/sq ft = 237													

▶ Specification Information, continued on next page

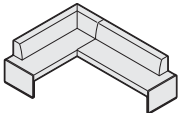

Overall: 70¹/₂"D 96¹/₂"W 31"H
Seat: 19"D 18¹/₂"H

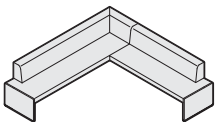

Overall: 97¹/₄"D 96¹/₂"W 31"H
Seat: 19"D 18¹/₂"H



For Canadian Pricing
Multiply U.S. Price by the Canadian price factor.
▶ See page 1 for details.

Together Bench by Walter Knoll

DESIGN EOOS DESIGN ORIGIN: 2004 GERMANY

► See page 255 for offset diagram.

► Specification Information, continued from previous page

Specification Information

Style Number	U.S. Base Prices														Leather Grades:		
	Fabric Grades:														COL	C	E
	COM	6	7	8	9	10	11	12	13	14							

Left Corner with Back, 8" Offset, continued

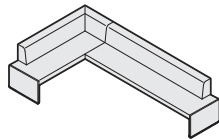

Overall: 70½"D 123¼"W 31"H
Seat: 19"D 18½"H

COT012369L8	\$8585	\$8821	\$8894	\$9020	\$ 9402	\$ 9649	\$ 9935	\$10,134	\$10,488	\$10,979	\$8709	\$13,324	\$14,146
--------------------	--------	--------	--------	--------	---------	---------	---------	----------	----------	----------	--------	----------	----------

COM/yds = 11¼, COL/sq ft = 248

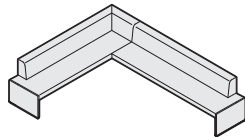

Overall: 97¼"D 123¼"W 31"H
Seat: 19"D 18½"H

COT012396L8	\$9017	\$9296	\$9378	\$9517	\$ 9942	\$10,216	\$10,534	\$10,755	\$11,148	\$11,694	\$9141	\$14,169	\$15,067
--------------------	--------	--------	--------	--------	---------	----------	----------	----------	----------	----------	--------	----------	----------

COM/yds = 12½, COL/sq ft = 270

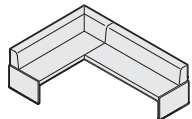

Overall: 70½"D 96½"W 31"H
Seat: 19"D 18½"H

Left Corner with Back, 1½" Offset

COT09669L15	\$7912	\$8113	\$8181	\$8295	\$ 8643	\$ 8868	\$ 9129	\$ 9310	\$ 9632	\$10,080	\$8036	\$12,236	\$12,985
--------------------	--------	--------	--------	--------	---------	---------	---------	---------	---------	----------	--------	----------	----------

COM/yds = 10¼, COL/sq ft = 226

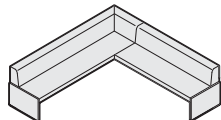

Overall: 97¼"D 96½"W 31"H
Seat: 19"D 18½"H

COT09666L15	\$8513	\$8749	\$8822	\$8948	\$ 9330	\$ 9577	\$ 9863	\$10,062	\$10,416	\$10,907	\$8637	\$13,252	\$14,074
--------------------	--------	--------	--------	--------	---------	---------	---------	----------	----------	----------	--------	----------	----------

COM/yds = 11¼, COL/sq ft = 248

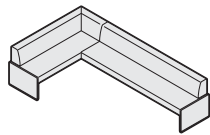

Overall: 70½"D 123¼"W 31"H
Seat: 19"D 18½"H

COT012369L15	\$8747	\$9000	\$9077	\$9208	\$ 9607	\$ 9865	\$10,164	\$10,371	\$10,741	\$11,254	\$8871	\$13,694	\$14,553
---------------------	--------	--------	--------	--------	---------	---------	----------	----------	----------	----------	--------	----------	----------

COM/yds = 11¾, COL/sq ft = 259

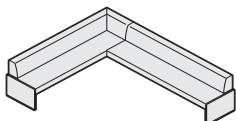

Overall: 97¼"D 123¼"W 31"H
Seat: 19"D 18½"H

COT012396L15	\$9178	\$9465	\$9549	\$9691	\$10,124	\$10,404	\$10,728	\$10,953	\$11,354	\$11,911	\$9302	\$14,538	\$15,471
---------------------	--------	--------	--------	--------	----------	----------	----------	----------	----------	----------	--------	----------	----------

COM/yds = 12¾, COL/sq ft = 281

► Specification Information, continued on next page

Together Bench by Walter Knoll *continued*

DESIGN EOOS DESIGN ORIGIN: 2004 GERMANY

Tip: For Customer's Own Material or Leather, see necessary requirements, important processing instructions, and ordering information
 ▶ See *Coalesse Surface Materials Reference Guide*.

Tip: Fabrics and leathers will appear loose with comfort wrinkles when upholstered.

▶ See page 255 for offset diagram.

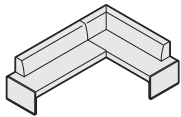

Overall: 70½"D 96½"W 31"H
 Seat: 19"D 18½"H

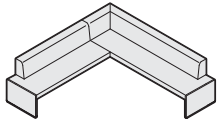

Overall: 97¼"D 96½"W 31"H
 Seat: 19"D 18½"H

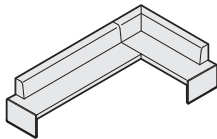

Overall: 70½"D 123¼"W 31"H
 Seat: 19"D 18½"H

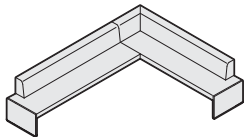

Overall: 97¼"D 123¼"W 31"H
 Seat: 19"D 18½"H

▶ Specification Information, continued from previous page

Specification Information

Style Number	U.S. Base Prices														Leather Grades:		
	Fabric Grades:														COL	C	E
	COM	6	7	8	9	10	11	12	13	14							

Right Corner with Back, 8" Offset

COTO9669R8	\$7749	\$7933	\$7997	\$8106	\$8437	\$ 8651	\$ 8899	\$ 9071	\$ 9378	\$ 9804	\$7873	\$11,865	\$12,578
COM/yds = 9¾, COL/sq ft = 215													

COTO9696R8	\$8349	\$8568	\$8638	\$8758	\$9123	\$ 9359	\$ 9632	\$ 9822	\$10,160	\$10,630	\$8473	\$12,881	\$13,667
COM/yds = 10¾, COL/sq ft = 237													

COTO12369R8	\$8585	\$8821	\$8894	\$9020	\$9402	\$ 9649	\$ 9935	\$10,134	\$10,488	\$10,979	\$8709	\$13,324	\$14,146
COM/yds = 11¼, COL/sq ft = 248													

COTO12396R8	\$9017	\$9296	\$9378	\$9517	\$9942	\$10,216	\$10,534	\$10,755	\$11,148	\$11,694	\$9141	\$14,169	\$15,067
COM/yds = 12½, COL/sq ft = 270													

▶ Specification Information, continued on next page

For Canadian Pricing
 Multiply U.S. Price by the Canadian price factor.
 ▶ See page 1 for details.

Together Bench by Walter Knoll

DESIGN EOOS DESIGN ORIGIN: 2004 GERMANY

► See page 255 for offset diagram.

► Specification Information, continued from previous page

Specification Information

Style Number	U.S. Base Prices													
	Fabric Grades:											Leather Grades:		
	COM	6	7	8	9	10	11	12	13	14	COL	C	E	

Right Corner with Back, 1½" Offset

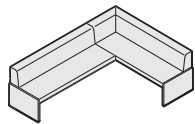

Overall: 70½"D 96½"W 31"H
Seat: 19"D 18½"H

COTO9669R15	\$7912	\$8113	\$8181	\$8295	\$ 8643	\$ 8868	\$ 9129	\$ 9310	\$ 9632	\$10,080	\$8036	\$12,236	\$12,985
--------------------	--------	--------	--------	--------	---------	---------	---------	---------	---------	----------	--------	----------	----------

COM/yds = 10¼, COL/sq ft = 226

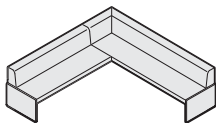

Overall: 97¼"D 96½"W 31"H
Seat: 19"D 18½"H

COTO9696R15	\$8513	\$8749	\$8822	\$8948	\$ 9330	\$ 9577	\$ 9863	\$10,062	\$10,416	\$10,907	\$8637	\$13,252	\$14,074
--------------------	--------	--------	--------	--------	---------	---------	---------	----------	----------	----------	--------	----------	----------

COM/yds = 11¼, COL/sq ft = 248

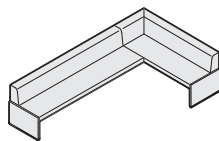

Overall: 70½"D 123¾"W 31"H
Seat: 19"D 18½"H

COTO12369R15	\$8747	\$9000	\$9077	\$9208	\$ 9607	\$ 9865	\$10,164	\$10,371	\$10,741	\$11,254	\$8871	\$13,694	\$14,553
---------------------	--------	--------	--------	--------	---------	---------	----------	----------	----------	----------	--------	----------	----------

COM/yds = 11¾, COL/sq ft = 259

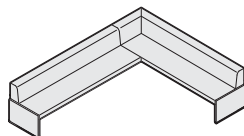

Overall: 97¼"D 123¾"W 31"H
Seat: 19"D 18½"H

COTO12396R15	\$9178	\$9465	\$9549	\$9691	\$10,124	\$10,404	\$10,728	\$10,953	\$11,354	\$11,911	\$9302	\$14,538	\$15,471
---------------------	--------	--------	--------	--------	----------	----------	----------	----------	----------	----------	--------	----------	----------

COM/yds = 12¾, COL/sq ft = 281

► Specification Information, continued on next page



For Canadian Pricing
Multiply U.S. Price by the
Canadian price factor.

► See page 1 for details.

Together Bench by Walter Knoll *continued*

DESIGN EOOS DESIGN ORIGIN: 2004 GERMANY

Tip: For Customer's Own Material or Leather, see necessary requirements, important processing instructions, and ordering information
 ▶ See *Coalesse Surface Materials Reference Guide*.

Tip: Fabrics and leathers will appear loose with comfort wrinkles when upholstered.

▶ See page 255 for offset diagram.

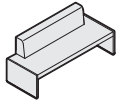

Overall: 26¾" D 69¾" W 31" H
 Seat: 19" D 18½" H

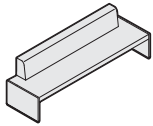

Overall: 26¾" D 96½" W 31" H
 Seat: 19" D 18½" H

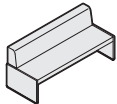

Overall: 26¾" D 69¾" W 31" H
 Seat: 19" D 18½" H

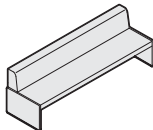

Overall: 26¾" D 96½" W 31" H
 Seat: 19" D 18½" H

For Canadian Pricing
 Multiply U.S. Price by the Canadian price factor.
 ▶ See page 1 for details.

▶ Specification Information, continued from previous page

Specification Information

Style Number	U.S. Base Prices											Leather Grades:		
	Fabric Grades:											COL	C	E
	COM	6	7	8	9	10	11	12	13	14				

Straight with Back, 8" Offset

COTO69WB8	\$3837	\$3850	\$3881	\$3934	\$4095	\$4200	\$4320	\$4404	\$4554	\$4761	\$3961	\$5879	\$6228
------------------	--------	--------	--------	--------	--------	--------	--------	--------	--------	--------	--------	--------	--------

COM/yds = 4¾, COL/sq ft = 105

COTO96WB8	\$4388	\$4452	\$4493	\$4563	\$4775	\$4912	\$5071	\$5182	\$5378	\$5651	\$4512	\$7054	\$7510
------------------	--------	--------	--------	--------	--------	--------	--------	--------	--------	--------	--------	--------	--------

COM/yds = 6¼, COL/sq ft = 138

Straight with Back, 1½" Offset

COTO69WB15	\$3998	\$4019	\$4052	\$4108	\$4278	\$4387	\$4515	\$4603	\$4760	\$4979	\$4122	\$6144	\$6510
-------------------	--------	--------	--------	--------	--------	--------	--------	--------	--------	--------	--------	--------	--------

COM/yds = 5, COL/sq ft = 110

COTO96WB15	\$4550	\$4623	\$4665	\$4738	\$4959	\$5101	\$5267	\$5382	\$5586	\$5870	\$4674	\$7318	\$7794
-------------------	--------	--------	--------	--------	--------	--------	--------	--------	--------	--------	--------	--------	--------

COM/yds = 6½, COL/sq ft = 143

▶ Specification Information, continued on next page

Together Bench by Walter Knoll

DESIGN EOOS DESIGN ORIGIN: 2004 GERMANY

► Specification Information, continued from previous page

Specification Information

Style Number	U.S. Base Prices											Leather Grades:		
	Fabric Grades:											COL	C	E
	COM	6	7	8	9	10	11	12	13	14				

Straight without Back

COT069	\$2762	\$2762	\$2788	\$2833	\$2969	\$3057	\$3158	\$3229	\$3355	\$3530	\$2899	\$4506	\$4799
---------------	--------	--------	--------	--------	--------	--------	--------	--------	--------	--------	--------	--------	--------

COM/yds = 4, COL/sq ft = 88

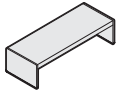

Overall: 26¾"D 69¾"W 18½"H
Seat: 18½"H

COT096	\$3150	\$3163	\$3194	\$3247	\$3408	\$3513	\$3633	\$3717	\$3867	\$4074	\$3274	\$5192	\$5541
---------------	--------	--------	--------	--------	--------	--------	--------	--------	--------	--------	--------	--------	--------

COM/yds = 4¾, COL/sq ft = 105

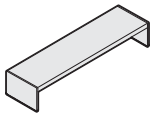

Overall: 26¾"D 96½"W 18½"H
Seat: 18½"H



For Canadian Pricing
Multiply U.S. Price by the
Canadian price factor.
► See page 1 for details.

Together Multi-Fabric Diagram

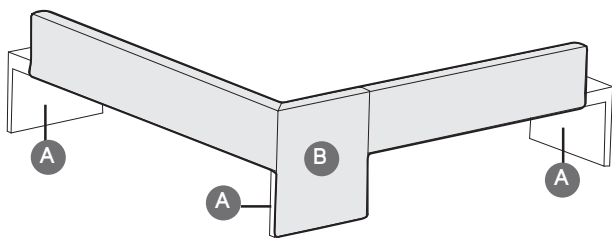
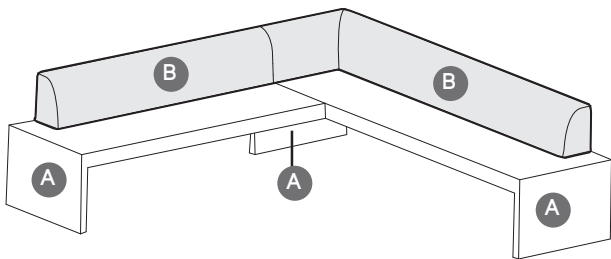
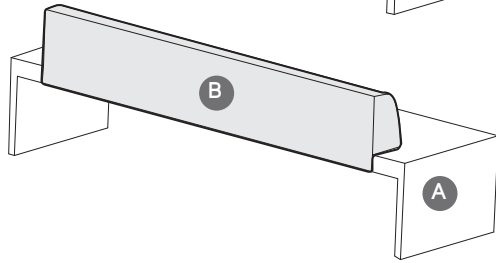
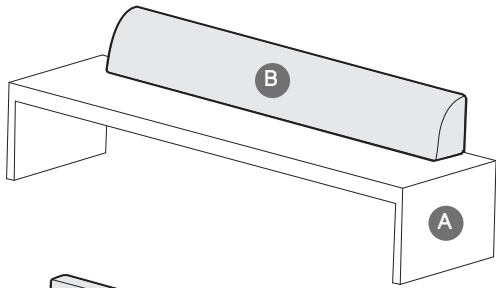

TO: _____

FROM: _____

DATE: _____

FAX....888.413.5161

Together Bench/Straight with Back

A Upholstery selections (default for entire unit if B is not selected): _____

B Back: _____

Together Bench/Corner with Back

A Upholstery selections (default for entire unit if B is not selected): _____

B Back: _____

\$118 U.S. list per contrasting fabric specified. List price based on highest fabric grade usage.



For Canadian Pricing
 Multiply U.S. Price by the
 Canadian price factor.
 ▶ See page 1 for details.

Together Offset Diagram

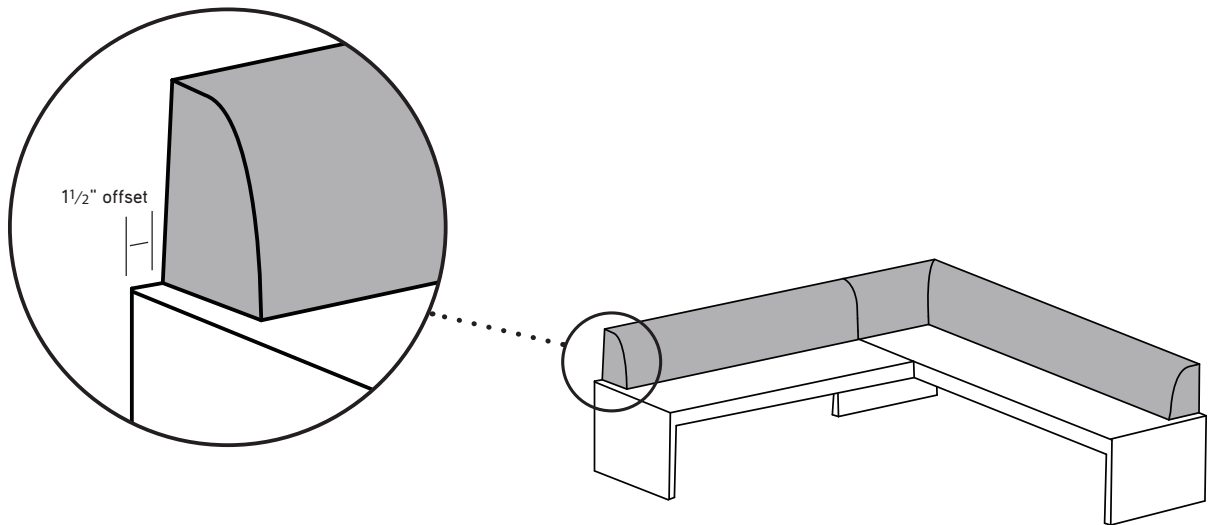
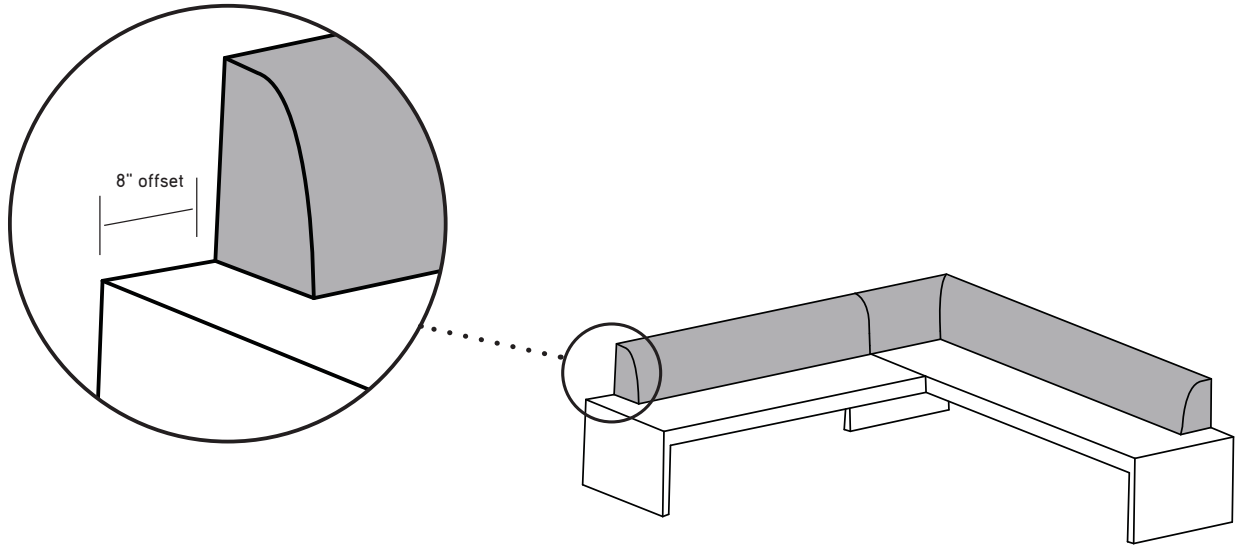

Topo

DESIGN METRO DESIGN GROUP

Topo lounge seating provides an alternative to typical lounge or guest seating for a more relaxed work posture. Topo lounge and lounge Jr. are equipped with glides.

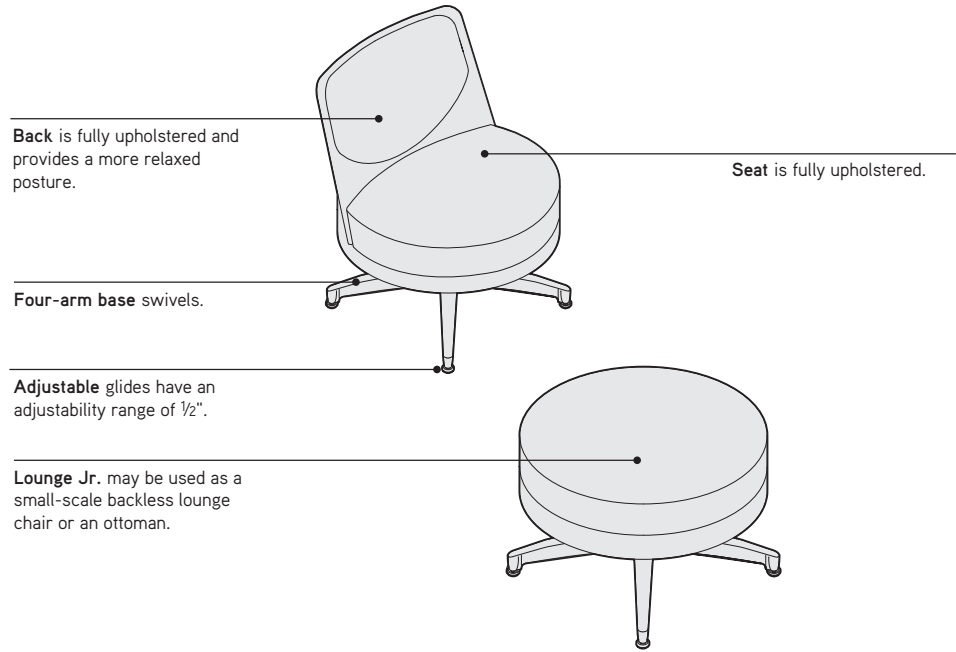

Topo mobile lounge seating features the modern geometric forms to create an alternative to conventional swivel chairs and are appropriately scaled for any lounge application. Topo mobile lounge and mobile lounge Jr. are equipped with casters.

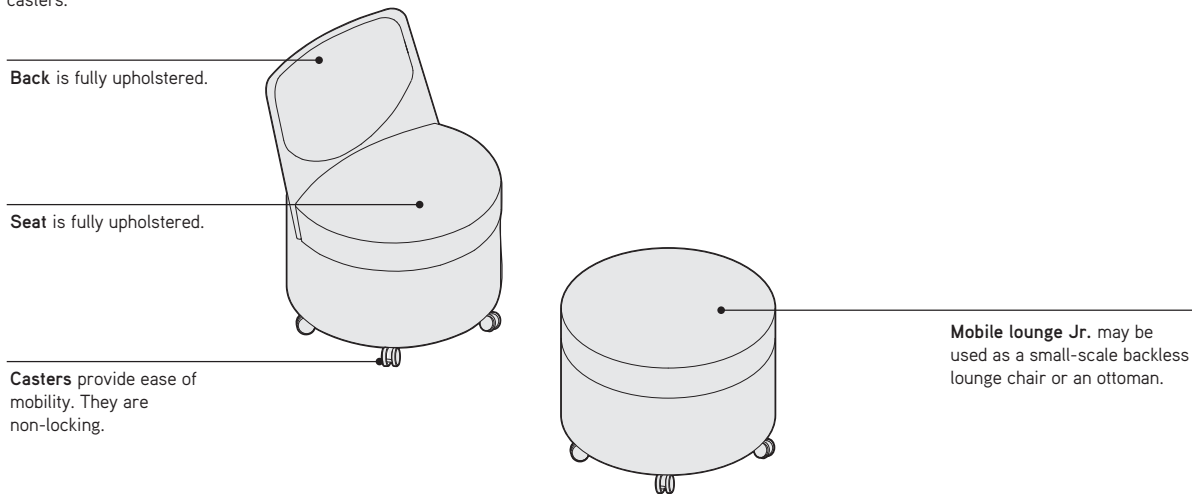

Actual Dimensions

	Overall Diameter	Height	Seat Depth	Width	Seat height from floor	Back height from seat	Footprint
Lounge	24"	31"	18"	24"	17"	15"	26" x 26"
Lounge Jr.	24"	17"	N.A.	N.A.	N.A.	N.A.	26" x 26"
Mobile lounge	24"	31"	18"	24"	17"	15"	26" x 26"
Mobile lounge Jr.	24"	17"	N.A.	N.A.	N.A.	N.A.	26" x 26"

Topo

DESIGN METRO DESIGN GROUP

Product Details

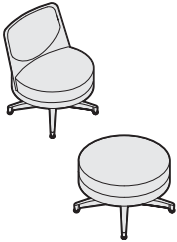

Topo lounge is scaled to fit within workstations and swivels for impromptu meetings.

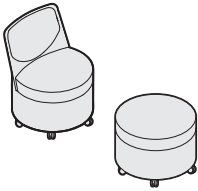

Topo mobile lounge is scaled for 27"H meeting tables or to fit within workstations.

Multiple fabrics can be specified on an individual unit for an additional fee per specified fabric. A lounge or mobile lounge can have up to three additional fabrics. A lounge Jr. or mobile lounge Jr. can have one additional fabric.

Lounge or mobile lounge

- Seat cushion (includes side of seat cushion) - no additional fee
- Base frame - additional fee
- Back cushion (inside back cushion) - additional fee
- Back frame (outside back panel) - additional fee

Lounge Jr. or Mobile lounge Jr.

- Seat cushion (including sides of seat cushion) - no additional fee
 - Base frame - additional fee
- See *Topo multi-fabric diagram and yardage request form*, page 260.

Surface Materials

Lounge:

Seat, back (inside and outside) and base frame

- Fabric

Four-arm base

- Paint

Glides

- Silver only

Mobile lounge:

Seat, back (inside and outside) and base frame

- Fabric

Casters

- Black plastic

Note: Refer to the *Coalesse Surface Materials Reference Guide* for additional surface materials information.

Programs & Services

Customer's Own

Material/Leather (COM/COL) Program is available.

► See *Coalesse Surface Materials Reference Guide* for additional information.

Designers

Metro Design Group

Topo Lounge and Lounge Jr.

DESIGN METRO DESIGN GROUP

Tip: For Customer's Own Material or Leather, see necessary requirements, important processing instructions, and ordering information
 ▶ See *Coalesse Surface Materials Reference Guide*.

Tip: When specifying fabric in different price grades, the highest price grade prevails.

Tip: Fabrics and leathers will appear loose with comfort wrinkles when upholstered.

Tip: The COM yards and COL square footage listed on this page reflect the requirements for a single fabric that are based on non-directional 54"W material applied railroaded. For multi-fabric COM requirements, please refer to multi-fabric yardage.

▶ Page 261



Standard Includes	Required to Specify
<ul style="list-style-type: none"> Need help? product details, page 256 Lounge - seat, inside back, outside back and base frame: fabric or leather Lounge Jr. - seat and base frame: fabric or leather Four-arm swivel base: paint Adjustable glides: silver only 	<ol style="list-style-type: none"> Style number Number of fabrics if contrasting fabric style number is selected Fabric or leather color number for seat, inside back, outside back, and base frame, if selected Paint color number for base Options, if selected (see below) ▶ See <i>Coalesse Surface Materials Reference Guide</i> .

Options	U.S. Price	Required to Specify
Surface Materials <ul style="list-style-type: none"> Contrasting fabric 	+\$118 per fabric	Add suffix K to the style number and select fabric color number.
Contrasting upholstery on lounge Jr. <ul style="list-style-type: none"> Contrasting fabric on base frame 	+\$118	Specify fabric color number for baseframe. ▶ See <i>Topo multi-fabric diagram and yardage request form</i> , page 260.
Acrylic backer <ul style="list-style-type: none"> Lounge Lounge jr. 	+\$ 29 +\$ 15	Specify with <i>acrylic backer</i> . Specify with <i>acrylic backer</i> . ▶ See <i>Coalesse Surface Materials Reference Guide</i> .

Specification Information

Style Number	U.S. Base Prices													
	Fabric Grades:													
	COM	6	7	8	9	10	11	12	13	14	Leather Grades:			
											COL	C	E	

Lounge

PL2431	\$1546	\$1546	\$1562	\$1590	\$1675	\$1730	\$1793	\$1838	\$1916	\$2025	\$1671	\$2624	\$2790
COM/yds = 2½, COL/sq ft = 50													

Lounge Jr.

PLJ2417	\$1103	\$1097	\$1104	\$1115	\$1149	\$1171	\$1196	\$1214	\$1245	\$1289	\$1192	\$1662	\$1728
COM/yds = 1, COL/sq ft = 20													



For Canadian Pricing
 Multiply U.S. Price by the Canadian price factor.
 ▶ See page 1 for details.

Topo Mobile Lounge and Mobile Lounge Jr.

DESIGN METRO DESIGN GROUP

Tip: For Customer's Own Material or Leather, see necessary requirements, important processing instructions, and ordering information
 ▶ See *Coalesse Surface Materials Reference Guide*.

Tip: When specifying fabric in different price grades, the highest price grade prevails.

Tip: Fabrics and leathers will appear loose with comfort wrinkles when upholstered.

Tip: The COM yards and COL square footage listed on this page reflect the requirements for a single fabric that are based on non-directional 54"W material applied railroaded. For multi-fabric COM requirements, please refer to multi-fabric yardage.
 ▶ Page 261

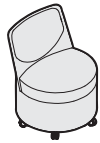

Standard Includes		Required to Specify
▶ Need help? product details, page 256	<ul style="list-style-type: none"> • Mobile lounge - seat, inside back, outside back and base frame: fabric or leather • Mobile lounge Jr. - seat and base frame: fabric or leather • Non-locking casters: black plastic 	1 Style number 2 Number of fabrics if contrasting fabric style number is selected 3 Fabric or leather color number for seat, inside back, outside back, and base frame, if selected 4 Options, if selected (see below) ▶ See <i>Coalesse Surface Materials Reference Guide</i> .

Options	U.S. Price	Required to Specify
Surface Materials		
• Contrasting fabric	+\$118 per fabric	Add suffix K to the style number and select fabric color number.
Contrasting upholstery on lounge Jr.		
• Contrasting fabric on base frame	+\$118	Specify fabric color number for baseframe. ▶ See <i>Topo multi-fabric diagram and yardage request form</i> , page 260.
Acrylic backer		
• Backer	+\$ 31	Specify with acrylic backer. ▶ See <i>Coalesse Surface Materials Reference Guide</i> .

Specification Information														
Style Number	U.S. Base Prices												Leather Grades:	
	Fabric Grades:												COL	C
	COM	6	7	8	9	10	11	12	13	14				

Mobile Lounge

PLM2431	\$1563	\$1563	\$1583	\$1616	\$1718	\$1784	\$1860	\$1913	\$2007	\$2138	\$1759	\$2813	\$3013
COM/yds = 3, COL/sq ft = 60													

Mobile Lounge Jr.

PLMJ2417	\$1166	\$1166	\$1186	\$1219	\$1321	\$1387	\$1463	\$1516	\$1610	\$1741	\$1321	\$2416	\$2616
COM/yds = 3, COL/sq ft = 60													

 **For Canadian Pricing**
 Multiply U.S. Price by the Canadian price factor.
 ▶ See page 1 for details.

Topo Multi-Fabric and Yardage Request Form

DESIGN METRO DESIGN GROUP

TO: _____

FROM: _____

DATE: _____

FAX...888.413.5161

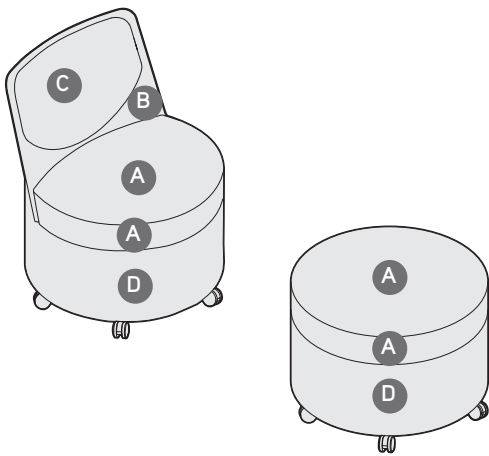

Topo Lounge

A Seat (upholstery selections default for entire unit if B is not selected): _____

B Back: _____

C Back Cushion: _____

D Base Frame: _____

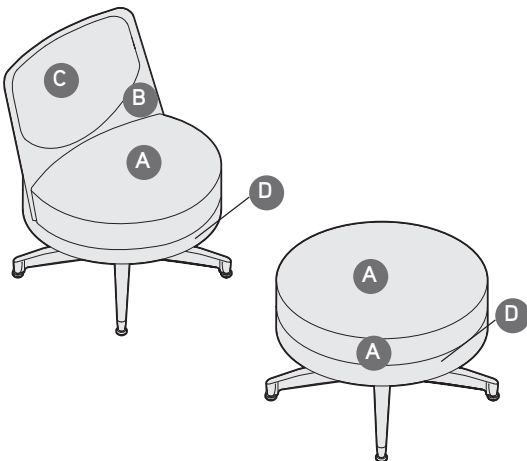

Topo Jr. Lounge

A Seat: _____

B Base Frame: _____

\$118 U.S. list per contrasting fabric specified. List price based on highest fabric grade usage.



For Canadian Pricing
Multiply U.S. Price by the
Canadian price factor.
▶ See page 1 for details.

Multi-Fabric Yardage

CHAIR MODEL	STYLE NUMBER	COM YDS*			
		SEAT CUSHION	INSIDE BACK CUSHION	OUTSIDE BACK PANEL	BASE FRAME
Lounge	PL2431	2¼	1	1	2¼
Lounge Jr.	PLJ2417	2½	N.A.	N.A.	2½
Mobile lounge	PLM2431	2½	1	1	2½
Mobile lounge Jr.	PLMJ2417	2½	N.A.	N.A.	2½

*Fabric yardage is based on non-directional/solid fabrics. Use conversion chart below for repeat/printed fabric yardage.

Non-standard fabric requirements

Yardage requirements shown are based on non-directional 54"W material applied railroaded. Coalesse will apply fabric railroaded unless instructed otherwise on the dealer's purchase order. The following conversion chart should be used to determine yardage requirements when COM has a repeat of 2" or more. Please contact Coalesse customer service for a yardage quotation if the fabric is less than 54" wide, has a repeat of more than 24", or if the fabric must be cut-right.

CONVERSION CHART

PRODUCT	REPEAT		
	2" - 8"	9" - 14"	15" - 24"
All other products	15%	25%	35%

Yardage quotations will also be provided for order of 10 or more pieces.

Cutting direction guidelines

Cutting direction is based on the fabric width and the way the fabric is cut from the roll and applied to Coalesse products. There are two cutting directions: railroaded or cut-right.

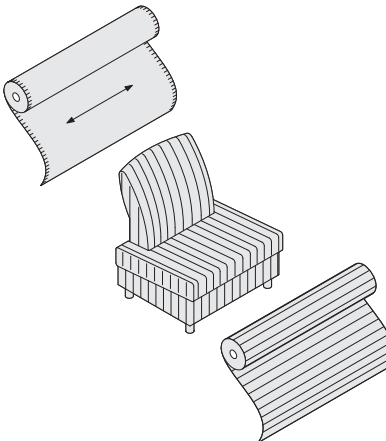

Horizontal or railroaded (across roll, warp horizontal) means fabric is cut across the roll; selvages are on the top and bottom.

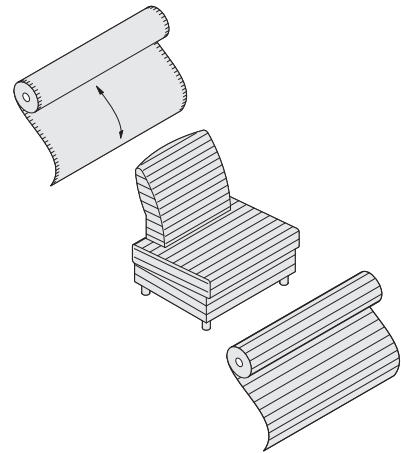

Vertical or cut-right (down roll, warp vertical) means fabric is cut in the same direction it is woven; selvages are on the left and right sides.

Coalesse reserves the right to railroad or apply fabric according to weave unless instructions specify otherwise. Fabrics are railroaded when possible to avoid seams in large upholstered areas and/or single cushion units. If a fabric is questionable, a cutting of adequate size showing full repeat (if any) should be sent to Coalesse for a fabric requirement quotation.

Visalia Lounge

DESIGN COALESSE DESIGN STUDIO

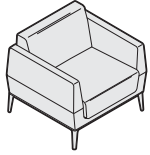

Tip: Fabrics and leathers will appear loose with comfort wrinkles when upholstered.

Tip: All cushions are attached.

Tip: Recommended leathers are Elmosoft Grade C and Elmorustical Grade E.

Tip: Special color match, consult Customer Service.

Tip: For Customer's Own Material or Leather, see necessary requirements, important processing instructions, and ordering information
 ▶ See *Coalesse Surface Materials Reference Guide*.

Standard Includes	Required to Specify
-------------------	---------------------

- Frame: unibody construction with finger jointed plywood
- Cast aluminum legs
- Upholstery: multiple densities of polyurethane foams and polyester fiber on seat and back
- Upper and lower upholstery accents with double needle top stitch, if selected
- Leg: powder coat paint

- 1 Style number
 - 2 Fabric or leather color number for seat, back, and arms
 - 3 Upholstery accent color number, if selected
 - 4 Paint color number for legs:
 - 4138 Graphite Gloss Black Matte
 - 4141 Platinum Matte
 - 4144 Black Gloss
 - 4145 Milk Gloss
 - 4148 Midnight Brown Gloss
 - 4180 Graphite Matte
 - 4193 Midnight Brown Matte
 - 4242 Milk Matte
 - 4710 Black Matte
 - 5 Options, if selected (see below)
- ▶ See *Coalesse Surface Materials Reference Guide*.

Required Selections	U.S. Price	Required to Specify
---------------------	------------	---------------------

Upholstery accent	Prices to right	Select accent upholstery.
-------------------	-----------------	---------------------------

Options	U.S. Price	Required to Specify
---------	------------	---------------------

Surface Materials

Acrylic backer

- | | | |
|--|-------|------------------------------|
| • Lounge chairs with single fabric | +\$35 | Specify with acrylic backer. |
| • Lounge chairs with two fabrics | +\$41 | Specify with acrylic backer. |
| • Two-seat chairs with single fabric | +\$46 | Specify with acrylic backer. |
| • Two-seat chairs with two fabrics | +\$52 | Specify with acrylic backer. |
| • Three-seat chairs with single fabric | +\$54 | Specify with acrylic backer. |
| • Three-seat chairs with two fabrics | +\$65 | Specify with acrylic backer. |
| • Ottomans chairs with single fabric | +\$17 | Specify with acrylic backer. |
| • Ottomans chairs with two fabrics | +\$17 | Specify with acrylic backer. |
| • Two-seat benches chairs with single fabric | +\$22 | Specify with acrylic backer. |
| • Two-seat benches chairs with two fabrics | +\$22 | Specify with acrylic backer. |
- ▶ See *Coalesse Surface Materials Reference Guide*.

Metal Legs

- | | | |
|---------|---------|-----------------------------|
| • Paint | No cost | Specify paint color number. |
|---------|---------|-----------------------------|



For Canadian Pricing
 Multiply U.S. Price by the Canadian price factor.
 ▶ See page 1 for details.

Visalia Lounge

DESIGN COALESSE DESIGN STUDIO

Specification Information

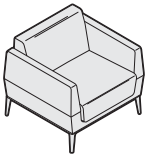
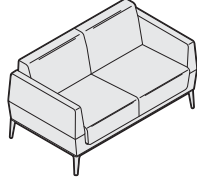
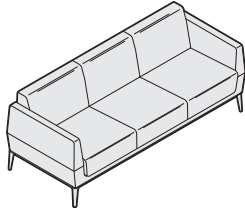
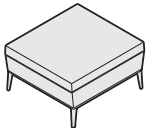
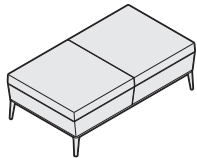
Lounge	Two-Seat	Three-Seat	Ottoman	Bench										
														
Overall: 29"D 31¾"W 28"H Seat height: 17"H Arm height to the floor: 23"H Inside: 19"D 23"W 17"H	Overall: 29"D 53¾"W 28"H Seat height: 17"H Arm height to the floor: 23"H Inside: 19"D 45"W 17"H	Overall: 29"D 73¾"W 28"H Seat height: 17"H Arm height to the floor: 23"H Inside: 19"D 65"W 17"H	Overall: 29"D 30"W 16¼"H	Overall: 29"D 52"W 16¼"H										
Style Number	Upholstery	U.S. Base Prices										Leather Grades:		
		Fabric Grades:										COL	C	E
		COM	6	7	8	9	10	11	12	13	14			

Lounge Chair with Single Fabric

COJHL100	\$2234	\$2234	\$2258	\$2300	\$2427	\$2510	\$2605	\$2671	\$2789	\$2953	\$2379	\$3344	\$3475
	COM/yds = 3¾, COL/sq ft = 83												

Lounge Chair with Accent Upholstery

COJHLC100	Standard Upholstery	\$2296	\$2296	\$2316	\$2349	\$2451	\$2517	\$2593	\$2646	\$2740	\$2871	\$2401	\$3330	\$3450
		COM/yds = 3, COL/sq ft = 66												
	Accent Upholstery	+\$ 6	No cost	+\$ 7	+\$ 18	+\$ 52	+\$ 74	+\$ 99	+\$117	+\$148	+\$192	+\$240	+\$344	+\$385
		COM/yds = 1, COL/sq ft = 22												

Two-Seat Sofa with Single Fabric

COJHL200	\$3432	\$3453	\$3486	\$3542	\$3712	\$3821	\$3949	\$4037	\$4194	\$4413	\$3556	\$4987	\$5166
	COM/yds = 5, COL/sq ft = 110												

Two-Seat Sofa with Accent Upholstery

COJHLC200	Standard Upholstery	\$3529	\$3533	\$3563	\$3613	\$3766	\$3865	\$3979	\$4059	\$4200	\$4397	\$3653	\$5071	\$5250
		COM/yds = 4½, COL/sq ft = 99												
	Accent Upholstery	No cost	No cost	+\$ 8	+\$ 22	+\$ 64	+\$ 92	+\$124	+\$146	+\$185	+\$240	+\$231	+\$434	+\$485
		COM/yds = 1¼, COL/sq ft = 27												

Three-Seat Sofa with Single Fabric

COJHL300	\$3927	\$3983	\$4022	\$4089	\$4293	\$4424	\$4577	\$4683	\$4872	\$5134	\$4051	\$5963	\$6194
	COM/yds = 6, COL/sq ft = 132												

Three-Seat Sofa with Accent Upholstery

COJHLC300	Standard Upholstery	\$4041	\$4080	\$4116	\$4177	\$4364	\$4484	\$4624	\$4722	\$4895	\$5135	\$4165	\$5984	\$6205
		COM/yds = 5½, COL/sq ft = 121												
	Accent Upholstery	No cost	No cost	+\$ 11	+\$ 31	+\$ 90	+\$129	+\$173	+\$204	+\$259	+\$336	+\$214	+\$601	+\$671
		COM/yds = 1¾, COL/sq ft = 39												

► Specification Information, continued on next page

For Canadian Pricing
 Multiply U.S. Price by the
 Canadian price factor.
 ► See page 1 for details.

Visalia Lounge *continued*

DESIGN COALESSE DESIGN STUDIO

► Specification Information, continued from previous page

Specification Information

Lounge

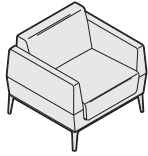

Overall: 29"D 31¾"W 28"H
 Seat height: 17"H
 Arm height to the floor: 23"H
 Inside: 19"D 23"W 17"H

Two-Seat

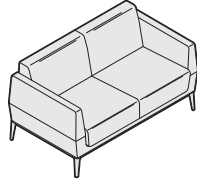

Overall: 29"D 53¾"W 28"H
 Seat height: 17"H
 Arm height to the floor: 23"H
 Inside: 19"D 45"W 17"H

Three-Seat

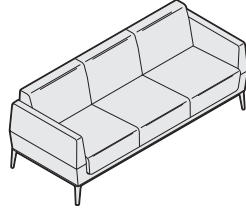

Overall: 29"D 73¾"W 28"H
 Seat height: 17"H
 Arm height to the floor: 23"H
 Inside: 19"D 65"W 17"H

Ottoman

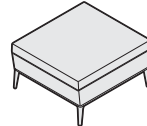

Overall: 29"D 30"W 16¼"H

Bench

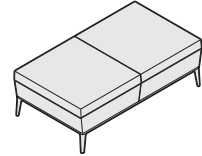

Overall: 29"D 52"W 16¼"H

Style
Number

Upholstery

U.S. Base Prices

Fabric Grades:
COM 6 7 8 9 10 11 12 13 14

Leather Grades:
COL C E

Ottoman with Single Fabric

COJHB100		\$1191	\$1191	\$1206	\$1231	\$1307	\$1357	\$1414	\$1454	\$1525	\$1623	\$1388	\$1870	\$1951
	COM/yds = 2, COL/sq ft = 44													

Ottoman with Accent Upholstery

COJHBC100	Standard Upholstery	\$1242	\$1236	\$1243	\$1254	\$1288	\$1310	\$1335	\$1353	\$1384	\$1428	\$1476	\$1580	\$1621
	COM/yds = 1, COL/sq ft = 22													
	Accent Upholstery	+\$ 6	No cost	+\$ 7	+\$ 18	+\$ 52	+\$ 74	+\$ 99	+\$117	+\$148	+\$192	+\$240	+\$344	+\$385
	COM/yds = 1, COL/sq ft = 22													

Two-Seat Bench with Single Fabric

COJHB200		\$1739	\$1739	\$1763	\$1805	\$1932	\$2015	\$2110	\$2176	\$2294	\$2458	\$1884	\$2661	\$2771
	COM/yds = 3, COL/sq ft = 50													

Two-Seat Bench with Accent Upholstery

COJHBC200	Standard Upholstery	\$1767	\$1767	\$1778	\$1798	\$1857	\$1896	\$1940	\$1971	\$2026	\$2103	\$1981	\$2369	\$2439
	COM/yds = 1¾, COL/sq ft = 39													
	Accent Upholstery	No cost	No cost	+\$ 8	+\$ 22	+\$ 64	+\$ 92	+\$124	+\$146	+\$185	+\$240	+\$231	+\$434	+\$485
	COM/yds = 1, COL/sq ft = 22													



For Canadian Pricing
 Multiply U.S. Price by the
 Canadian price factor.
 ► See page 1 for details.

Visalia Multi-Fabric Diagram

Applies to Visalia models including: Lounge, two-seat sofa, three-seat sofa, ottoman, and two-seat bench.

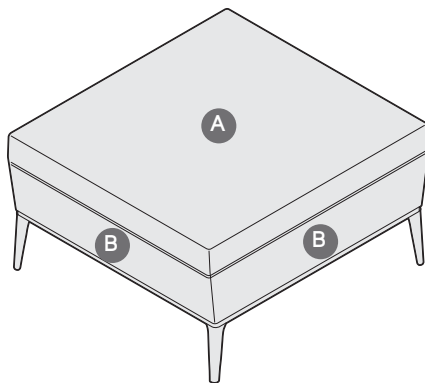
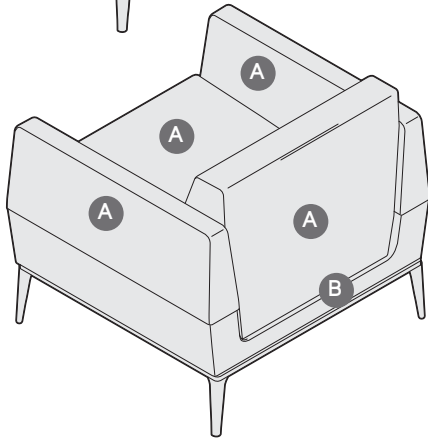
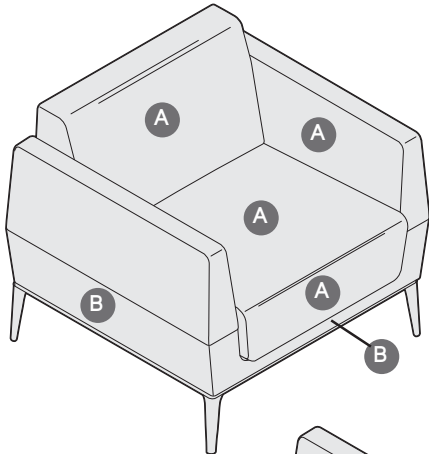

TO: _____

FROM: _____

DATE: _____

FAX...888.413.5161

A Upholstery Selection (default for entire unit if B is not selected): _____

B Accent: _____

Specify model below:

COJHLC100 Lounge

COJHLC200 Two-Seat Sofa

COJHLC300 Three-Seat Sofa

COJHBC100 Ottoman

COJHBC200 Two-Seat Bench

Guest/Side/Stack Seating

Bindu	268
Bob	269
Capa	270
CH20 Elbow Chair	271
CH24 Wishbone	272
CH53 Stool	273
CH88 Chairs	274
Enea Stacker with Arms	276
Enea Stacker without Arms	278
Enea Bar-Height Stools with Arms	280
Enea Bar-Height Stools without Arms	282
Enea Café Stools with Back	284
Enea Café Stools	286
Enea Lottus Armless Chairs	288
Enea Lottus Cantilever Arm Chairs	290
Enea Lottus Aluminum Loop Arm Chairs	292
Enea Lottus Sled Base Stools	294
Enea Lottus Post Base Stools	296
Kart	298
Kathryn	308
Last Minute	310
Lox Chairs	311
Lox Stools	312
Rocky	313
SW_1	317
Switch Guest	318
Switch Stools without Arms	320
Wrapp	321
X-Stack	322

Bindu

DESIGN BRIAN KANE DESIGN ORIGIN: 2009 UNITED STATES

Tip: Fabrics and leathers will appear loose with comfort wrinkles when upholstered.

Tip: Craft in upholstery cautions the use of stripes and patterns on Bindu. Please use fabric database when specifying.

Tip: For Customer's Own Material or Leather, see necessary requirements, important processing instructions, and ordering information
 ▶ See *Coalesse Surface Materials Reference Guide*.

Tip: For fabric with large pattern and specific pattern location is desired, contact Customer Service.



Overall: 25"D 25"W 33¾"H
 Inside: 18¾"D 18½"-19½"W 15"H
 Seat: 17¾"H
 Arm: 26¼"H



Overall: 25"D 25"W 37¾"H
 Inside: 18¾"D 18½"-19½"W 21"H
 Seat: 17¾"H
 Arm: 26¼"H

Standard Includes	Required to Specify
-------------------	---------------------

<ul style="list-style-type: none"> Bent plywood frame Chair: fabric Molded polypropylene foam Frame: 4144 Black Gloss Glides: non-marring polymer 	1 Style number 2 Fabric or leather color number for upholstery 3 Options, if selected (see below) ▶ See <i>Coalesse Surface Materials Reference Guide</i> .
--	--

Options	U.S. Price	Required to Specify
---------	------------	---------------------

Surface Materials <ul style="list-style-type: none"> Acrylic backer Backer 	+\$ 29	Specify with acrylic backer. ▶ See <i>Coalesse Surface Materials Reference Guide</i> .
Base <ul style="list-style-type: none"> Polished trivalent chrome (available on CO200G & CO300G) 	+\$147	Specify with trivalent chrome.

Specification Information

Style Number	U.S. Base Prices											Leather Grades:		
	Fabric Grades:											COL	C	E
COM	6	7	8	9	10	11	12	13	14					

Low Back Guest/Side Chair

CO200G	\$1213	\$1213	\$1233	\$1266	\$1368	\$1434	\$1510	\$1563	\$1657	\$1788	\$1384	\$2577	\$2796
--------	--------	--------	--------	--------	--------	--------	--------	--------	--------	--------	--------	--------	--------

COM/yds = 3, COL/sq ft = 66

Mid Back Guest/Side Chair

CO300G	\$1393	\$1393	\$1413	\$1446	\$1548	\$1614	\$1690	\$1743	\$1837	\$1968	\$1564	\$2757	\$2976
--------	--------	--------	--------	--------	--------	--------	--------	--------	--------	--------	--------	--------	--------

COM/yds = 3, COL/sq ft = 66



For Canadian Pricing
 Multiply U.S. Price by the Canadian price factor.
 ▶ See page 1 for details.

Bob Chair by Walter Knoll

DESIGN PEARSON LLOYD DESIGN ORIGIN: 2007 GERMANY

Tip: For Customer's Own Material or Leather, see necessary requirements, important processing instructions, and ordering information
 ▶ See *Coalesse Surface Materials Reference Guide*.

Tip: Fabrics and leathers will appear loose with comfort wrinkles when upholstered.

Standard Includes

- Base: 8040 aluminum matte polished
- Upholstery for chair: fabric or leather
- Glides

Required to Specify

- 1 Style number
 - 2 Number of fabrics if contrasting fabric style number is selected
 - 3 Fabric or leather color number for upholstery
 - 4 Options, if selected (see below)
- ▶ See *Coalesse Surface Materials Reference Guide*.

Options

Options	U.S. Price	Required to Specify
Surface Materials		
• Contrasting fabric	+\$118 per fabric	Add suffix K to the style number and select fabric color number.
Fire code seating		
• Fire code seating	+\$231	Specify with <i>fire code seating</i> . ▶ See <i>Coalesse Surface Materials Reference Guide</i> .
Acrylic backer		
• Backer for guest chair	+\$ 22	Specify with <i>acrylic backer</i> .
• Backer for ottoman	+\$ 10	Specify with <i>acrylic backer</i> . ▶ See <i>Coalesse Surface Materials Reference Guide</i> .
Glides		
• Felted glides	+\$ 16	Specify with <i>felted glides</i> .

Specification Information

Style Number	U.S. Base Prices										Leather Grades:		
	Fabric Grades:										COL	C	E
	COM	6	7	8	9	10	11	12	13	14			

Guest Swivel Chair

231	\$2374	\$2374	\$2387	\$2409	\$2477	\$2521	\$2572	\$2607	\$2670	\$2757	\$2588	\$3402	\$3551
-----	--------	--------	--------	--------	--------	--------	--------	--------	--------	--------	--------	--------	--------

COM/yds = 2, COL/sq ft = 44



Overall: 25¼"D 27¼"W 29¾"H
 Inside: 18"D 18"W 12½"H
 Seat: 18½"H
 Arm: 26½"H



Overall: 18½"D 19¾"W 15¼"H

Ottoman

221-H	\$1064	\$1058	\$1065	\$1076	\$1110	\$1132	\$1157	\$1175	\$1206	\$1250	\$1307	\$1687	\$1762
-------	--------	--------	--------	--------	--------	--------	--------	--------	--------	--------	--------	--------	--------

COM/yds = 1, COL/sq ft = 22



For Canadian Pricing
 Multiply U.S. Price by the Canadian price factor.
 ▶ See page 1 for details.

Capa Chair

DESIGN EOOS DESIGN ORIGIN: GERMANY



Overall: 24³/₄"D 23³/₄"W 31¹/₂"H
 Inside: 18"D 16¹/₂"W 15"H
 Seat: 18"H
 Arm: 28"H

Tip: Fabrics and leathers will appear loose with comfort wrinkles when upholstered.

Tip: Frame design allows back to flex to match occupant's back shape.

Tip: Due to the design and construction techniques of the Capa Chair only certain textiles can be successfully applied, therefore all COM fabrics must be submitted to Coalesse for approval prior to order acceptance.

Tip: Recommended leathers are Elmosoft Grade C and Elmorustical Grade E.

Tip: Special color match, consult customer service.

Tip: For Customer's Own Material or Leather, see necessary requirements, important processing instructions, and ordering information
 ▶ See Coalesse Surface Materials Reference Guide.

Tip: Chair stacks five high.

Standard Includes	Required to Specify
<ul style="list-style-type: none"> • Frame: hardwood plywood, steel tubing and bar stock • Arms: solid steel rod and bar stock • Upholstery: arms, back, and seat foam are molded around the frame components • Legs: trivalent matte chrome (M) or polished chrome (PC) leg finish 	1 Style number 2 Number of fabrics if contrasting fabric style number is selected 3 Fabric or leather color number for upholstery 4 Options, if selected (see below) ▶ See Coalesse Surface Materials Reference Guide.

Options	U.S. Price	Required to Specify
Surface Materials <ul style="list-style-type: none"> • Contrasting fabric 	+\$118 per fabric	Add suffix K to the style number and select fabric color number.
Acrylic backer <ul style="list-style-type: none"> • Backer 	+\$ 17	Specify with acrylic backer. ▶ See Coalesse Surface Materials Reference Guide.

Specification Information													
Style Number	U.S. Base Prices											Leather Grades:	
	Fabric Grades:											COL	C
	COM	6	7	8	9	10	11	12	13	14			

Chair

1810M	\$1113	\$1113	\$1126	\$1148	\$1216	\$1260	\$1311	\$1346	\$1409	\$1496	\$1378	\$2365	\$2546
1810PC	\$1141	\$1141	\$1154	\$1176	\$1244	\$1288	\$1339	\$1374	\$1437	\$1524	\$1406	\$2398	\$2574

COM/yds = 2, COL/sq ft = 44

Stacking Dolly

9014S	\$ 749	N.A.	N.A.	N.A.	N.A.	N.A.	N.A.	N.A.	N.A.	N.A.	N.A.	N.A.	N.A.
-------	--------	------	------	------	------	------	------	------	------	------	------	------	------



For Canadian Pricing
 Multiply U.S. Price by the Canadian price factor.
 ▶ See page 1 for details.

CH20 Elbow Chair by Carl Hansen & Son

DESIGN HANS WEGNER DESIGN ORIGIN: DENMARK, 1956

Only select finishes are available at this time.



Overall: 18½"D 21¼"W 28"H
Seat: 18"H

Standard Includes **Required to Specify**

- | | |
|---|--|
| <ul style="list-style-type: none"> Upholstered seat cushion: fabric or leather Bent ply frame | <ol style="list-style-type: none"> 1 Style number 2 Fabric or leather color number for upholstery, if selected 3 Wood species/finish number, (See matrix below) |
|---|--|

Tip: For Customer's Own Material or Leather, see necessary requirements, important processing instructions, and ordering information
▶ See *Coalesse Surface Materials Reference Guide*.

Specification Information

Style Number	U.S. Prices						Leather:			
	Fabric: COM	Group 1	Group 2	Group 3	Group 4	Group 5	COL	Loke Leather	Thor Leather	SIF Leather
CH20OAK	\$1651	\$1662	\$1680	\$1689	\$1718	\$1879	\$1794	\$1794	\$1850	\$1888
CH20BEECH	\$1463	\$1471	\$1489	\$1518	\$1527	\$1698	\$1613	\$1613	\$1671	\$1709

COM/yds = 1 yd

Wood Species/Finish Number Matrix

Finish	Wood Species Number:	
	Oak	Beech
Lacquer	3255	3475
White Oil	3265	N.A.
CHS color	N.A.	3246
Oil	3227	3753
Soap	3225	733
CHS Color	3235	3229, 3236, 3237, 3238, 3239, 3246, 3248, 3251, 3253, 3256, 3267, 3268

Guest/Slide/Stack Seating

For Canadian Pricing
Multiply U.S. Price by the Canadian price factor.
▶ See page 1 for details.

CH24 Wishbone Chair by Carl Hansen & Son

DESIGN HANS WEGNER DESIGN ORIGIN: DENMARK, 1949

Smoked Oak and Oak Walnut style numbers will be available Summer 2015. Only select finishes are available at this time.



Overall: 20"D 21½"W 29½"H
 Seat: 17½/25"H

Tip: Not all finishes offered on every wood species, see matrix below.

Tip: White papercord is only available for CHS colors.

Standard Includes

- Frame: wood
- Hand-woven papercord seat

Required to Specify

- 1 Style number
- 2 Papercord: (See prices below)
 - Black: P500
 - Natural: P501
 - White: P502
- 3 Wood species/finish number, (See matrix below)
- 4 Options, if selected (see below)

Options

Options	U.S. Price	Required to Specify
Leather Cushion	• Leather cushion +\$237	Specify with leather cushion and select color number: - 5073 Loke 7050 - 5074 Loke 7270 - 5075 Loke 7170 - 5076 Loke 7150 - 5077 Loke 7160 - 507D Loke 7100 - 507L Loke 7748

Specification Information

Style Number	U.S. Base Prices		
	Papercord:		
	Natural	Black	White
CH24SMKOAK	\$1975	\$2172	N.A.
CH24OAK	\$1879	\$2078	\$1879
CH24ASH	\$1879	\$2078	\$1879
CH24WALNUT	\$2705	\$2904	N.A.
CH24CHERRY	\$2172	\$2371	N.A.
CH24OAKWAL	\$2125	N.A.	N.A.
CH24BEECH	\$1624	\$1823	\$1624

Wood Species/Finish Number Matrix

Finish	Wood Species Number:						
	Smoked Oak	Oak	Ash	Walnut	Cherry	Oak Walnut	Beech
Lacquer	N.A.	3255	3615	3325	3407	3105	N.A.
White Oil	N.A.	3265	3645	N.A.	N.A.	N.A.	N.A.
Oil	3233	N.A.	N.A.	3335	3417	3103	N.A.
Soap	N.A.	3225	3603	N.A.	N.A.	N.A.	3733
CHS Color	N.A.	3235	3795	N.A.	N.A.	N.A.	3208, 3209, 3210, 3211, 3213, 3216, 3218, 3219, 3220, 3221, 3223, 3228, 3229, 3236, 3237, 3238, 3239, 3245, 3247, 3248, 3251, 3253, 3256, 3267, and 3268

Tip: CHS standard colors are not available when white papercord is selected.



For Canadian Pricing
 Multiply U.S. Price by the Canadian price factor.
 ▶ See page 1 for details.

CH53 Stool

DESIGN HANS WEGNER DESIGN ORIGIN: DENMARK, 1966

Beech style number will be available Summer 2015.
Only select finishes are available at this time.



Overall: 15¼"D 19¾"W 17"H

Tip: Not all finishes offered on every wood species, see matrix below.

Standard Includes

- Frame: wood
- Hand-woven papercord seat

Required to Specify

- 1 Style number
- 2 Papercord: (See prices below)
 - Black: P500
 - Natural: P501
- 3 Wood species/finish number, (See matrix below)

Specification Information

Style Number	U.S. Prices	
	Papercord:	
	Natural	Black
CH53OAK	\$1187	\$1404
CH53BEECH	\$1082	\$1301

Wood Species/Finish Number Matrix

Finish	Wood Species Number:	
	Oak	Beech
Lacquer	3255	3745
White Oil	3265	N.A.
Oil	3227	3753
Soap	3225	3733
CHS Color	3235	3229, 3236, 3237, 3238, 3239, 3248, 3251, 3253, 3256, 3267, 3268

Guest/Side/Stack Seating



For Canadian Pricing
Multiply U.S. Price by the Canadian price factor.
▶ See page 1 for details.

CH88 Chairs by Carl Hansen & Son

DESIGN HANS WEGNER DESIGN ORIGIN: DENMARK, 1949

Smoked Oak style numbers will be available Summer 2015. Only select finishes are available at this time.



Overall: 17 1/2"D 22 1/2"W 30"H

Tip: Not all finishes offered on every wood species, see matrix below.

Tip: For Customer's Own Material or Leather, see necessary requirements, important processing instructions, and ordering information
 ▶ See *Coalesse Surface Materials Reference Guide*.

Standard Includes	Required to Specify
<ul style="list-style-type: none"> Upholstered seat cushion, if selected: fabric or leather Non-upholstered seat, if selected: wood Backrest: wood Frame: black powder coat metal legs 	<ol style="list-style-type: none"> Style number Fabric or leather color number for upholstery, if selected Wood species/finish number, (See below) Options, if selected (see below) ▶ See <i>Coalesse Surface Materials Reference Guide</i> .

Options	U.S. Price	Required to Specify
Metal Leg Finish		
• Chrome	+\$ 57	Specify <i>with chrome</i> and select finish number.
• Stainless steel	+\$132	Specify <i>with stainless steel</i> and select finish number.

Specification Information

Style Number	U.S. Base Prices						Leather:			
	Fabric:						COL	Loke Leather	Thor Leather	SIF Leather
	COM	Group 1	Group 2	Group 3	Group 4	Group 5				

Upholstered Seat

CH88PSMKOAK	\$1527	\$1536	\$1583	\$1612	\$1641	\$1879	\$1680	\$1688	\$1747	\$2125
CH88POAK	\$1386	\$1386	\$1442	\$1462	\$1489	\$1727	\$1537	\$1548	\$1604	\$1984
CH88PBEECH	\$1301	\$1310	\$1357	\$1384	\$1413	\$1651	\$1442	\$1462	\$1518	\$1897

Wood Seat

CH88SMKOAK	\$1214
CH88OAK	\$1214
CH88BEECH	\$1129

Wood Species/Finish Number Matrix

Finish	Wood Species Number:		
	Smoked Oak	Oak	Beech
Lacquer	3783	3255	3745
White Oil	N.A.	3265	N.A.
Oil	3233	3227	3753
Soap	N.A.	3225	3733
CHS Color	N.A.	3235	3208, 3209, 3210, 3211, 3213, 3216, 3218, 3219, 3220, 3221, 3223, 3228, 3229, 3236, 3237, 3238, 3239, 3245, 3247, 3248, 3251, 3253, 3256, 3267, 3268



For Canadian Pricing
 Multiply U.S. Price by the Canadian price factor.
 ▶ See page 1 for details.

Coalesse

CH88 Chairs by Carl Hansen & Son

DESIGN HANS WEGNER DESIGN ORIGIN: DENMARK, 1949

Guest/Side/Stack
Seating

Enea Stacker With Arms

DESIGN JACOB LLUSCA DESIGN ORIGIN: SPAIN

 = Available in Rapid10.

Tip: Due to the design and construction techniques of the Enea Chair only certain textiles can be successfully applied, therefore all COM fabrics must be submitted to Coalesse for approval prior to order acceptance.

Tip: Fabrics and leathers will appear loose with comfort wrinkles when upholstered.

Tip: For Customer's Own Material or Leather, see necessary requirements, important processing instructions, and ordering information
 ► See *Coalesse Surface Materials Reference Guide*.

Tip: Contrasting fabric option available on model 3501 only.

Tip: CAL 133 for polypropylene is available as a special quote. Polypropylene color will change slightly when FR treatment is applied. Contact Customer Service for availability and pricing. Minimum quantity will apply.

Tip: Need sketch for ganging.

Tip: Models 3501 and 3500 in black belt leather or wood are approved for CAL 133 at no charge.

Tip: Tablet is 11"D x 9"W.

Tip: Belt leather upcharge applies to COM pricing.

Tip: Arm chairs stack nine high. Arm chair with tablet stacks six high, chairs cannot be stacked with storage rack.



Overall: 22½"D 22½"W 33¼"H
 Inside: 18"D 18"W 15¼"H
 Seat: 18"H
 Arm: 26¼"H



For Canadian Pricing
 Multiply U.S. Price by the Canadian price factor.
 ► See page 1 for details.

Standard Includes		Required to Specify	
	<ul style="list-style-type: none"> Frame: constructed of steel tubing Seat and back: molded nylon, wood, or upholstery (wood is laminated layers of hard maple veneer) 		<ol style="list-style-type: none"> Style number Fabric or leather color number for upholstery, if selected Plastic or wood finish color number for seat and back, if selected Base/frame finish: black gloss, white gloss, and silver metallic Options, if selected (see below) ► See <i>Coalesse Surface Materials Reference Guide</i> .
Options		U.S. Price	Required to Specify
Surface Materials	<ul style="list-style-type: none"> Contrasting fabric 	+\$118 per fabric	Add suffix K to the style number and select fabric color number.
	Acrylic backer <ul style="list-style-type: none"> Chair with upholstered seat and back Chair with upholstered seat and wood back 	+\$ 17 +\$ 8	Specify with <i>acrylic backer</i> . Specify with <i>acrylic backer</i> . ► See <i>Coalesse Surface Materials Reference Guide</i> .
Ganging	<ul style="list-style-type: none"> Ganging 	+\$ 64	Specify with <i>ganging</i> .
Storage Rack 	<ul style="list-style-type: none"> Storage rack 	+\$271	Specify with <i>storage rack</i> .
Tablet	<ul style="list-style-type: none"> Black powder coat 	+\$335	Specify with <i>tablet</i> and specify side as facing.
Belt Leather	<ul style="list-style-type: none"> Black belt leather available on model 3501 	-\$ 21	Specify with <i>black belt leather</i> .
	<ul style="list-style-type: none"> White leather available on model 3501 	+\$ 22	Specify with <i>white leather</i> .
Felt Glides	<ul style="list-style-type: none"> Glides 	No cost	Specify with <i>felt glides</i> .
Related Products	<ul style="list-style-type: none"> Café and conference tables 		► Page 360

Specification Information

Style Number	U.S. Base Prices														Leather Grades:		
	Fabric Grades:														COL	C	E
	COM	6	7	8	9	10	11	12	13	14							

Wood Seat and Back Stacker

3500	\$926	N.A.	N.A.	N.A.	N.A.	N.A.	N.A.	N.A.	N.A.	N.A.	N.A.	N.A.	N.A.	N.A.	N.A.	N.A.
------	-------	------	------	------	------	------	------	------	------	------	------	------	------	------	------	------

► Specification Information, continued on next page

 = Last order entry
 October 18, 2015

Enea Stacker With Arms

DESIGN JACOB LLUSCA DESIGN ORIGIN: SPAIN

 = Available in Rapid10.

► Specification Information, continued from previous page

Specification Information

Style Number	U.S. Base Prices											Leather Grades:		
	Fabric Grades:											COL	C	E
	COM	6	7	8	9	10	11	12	13	14				



Overall: 22½"D 22½"W 33¼"H
 Inside: 18"D 18"W 15¼"H
 Seat: 18"H
 Arm: 26¾"H

Upholstered Seat and Back

 3501	\$867	\$867	\$877	\$894	\$945	\$978	\$1016	\$1043	\$1090	\$1155	\$1126	\$1332	\$1462
--	-------	-------	-------	-------	-------	-------	--------	--------	--------	--------	--------	--------	--------

COM/yds = 1, COL/sq ft = 22



Overall: 22½"D 22½"W 33¼"H
 Inside: 18"D 18"W 15¼"H
 Seat: 18"H
 Arm: 26¾"H

Upholstered Seat and Wood Back

3502	\$929	\$915	\$920	\$928	\$953	\$970	\$ 989	\$1002	\$1026	\$1059	\$1199	\$1293	\$1364
------	-------	-------	-------	-------	-------	-------	--------	--------	--------	--------	--------	--------	--------

COM/yds = ¾, COL/sq ft = 17



Overall: 22½"D 22½"W 33¼"H
 Inside: 18"D 18"W 15¼"H
 Seat: 18"H
 Arm: 26¾"H

Polypropylene Seat and Back

 3503	\$535	N.A.	N.A.	N.A.	N.A.	N.A.	N.A.	N.A.	N.A.	N.A.	N.A.	N.A.	N.A.
--	-------	------	------	------	------	------	------	------	------	------	------	------	------

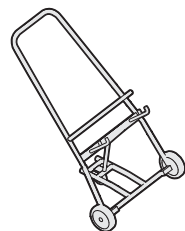

Overall: 34"D 26"W 34"H

Stacking Dolly

9014S	\$749	N.A.	N.A.	N.A.	N.A.	N.A.	N.A.	N.A.	N.A.	N.A.	N.A.	N.A.	N.A.
-------	-------	------	------	------	------	------	------	------	------	------	------	------	------



For Canadian Pricing
 Multiply U.S. Price by the
 Canadian price factor.
 ► See page 1 for details.

Enea Stacker Without Arms

DESIGN JACOB LLUSCA DESIGN ORIGIN: SPAIN

 = Available in Rapid10.

Tip: CAL 133 for polypropylene is available as a special quote. Polypropylene color will change slightly when FR treatment is applied. Contact Customer Service for availability and pricing. Minimum quantity will apply.

Tip: Due to the design and construction techniques of the Enea Chair only certain textiles can be successfully applied, therefore all COM fabrics must be submitted to Coalesse for approval prior to order acceptance.

Tip: Armless chairs stack nine high, chairs cannot be stacked with storage rack.

Tip: Fabrics and leathers will appear loose with comfort wrinkles when upholstered.

Tip: For Customer's Own Material or Leather, see necessary requirements, important processing instructions, and ordering information
 ► See *Coalesse Surface Materials Reference Guide*.

Tip: Contrasting fabric option available on model 3501S only.

Tip: Models 3501S and 3500S in black belt leather or wood are approved for CAL 133 at no charge.

Tip: Belt leather upcharge applies to COM pricing.

Tip: No tablet or ganging available on armless models.



Overall: 22½"D 18"W 33¼"H
 Inside: 18"D 18"W 15¼"H
 Seat: 18"H



For Canadian Pricing
 Multiply U.S. Price by the Canadian price factor.
 ► See page 1 for details.

Standard Includes	Required to Specify
-------------------	---------------------

- Frame: steel tubing
- Seat and back: molded nylon, wood, or upholstery (wood is laminated layers of hard maple veneer)

- 1 Style number
 - 2 Fabric or leather color number for upholstery, if selected
 - 3 Plastic or wood finish color number for seat and back, if selected
 - 4 Base/frame finish: black gloss, white gloss, and silver metallic
 - 5 Options, if selected (see below)
- See *Coalesse Surface Materials Reference Guide*.

Options	U.S. Price	Required to Specify
---------	------------	---------------------

Surface Materials	<ul style="list-style-type: none"> • Contrasting fabric 	+\$118 per fabric	Add suffix K to the style number and select fabric color number.
	Acrylic backer		
	• Chair with upholstered seat and back	+\$ 17	Specify with <i>acrylic backer</i> .
	• Chair with upholstered seat and wood back	+\$ 8	Specify with <i>acrylic backer</i> . ► See <i>Coalesse Surface Materials Reference Guide</i> .
Storage Rack 	• Storage rack	+\$271	Specify with <i>storage rack</i> .
Belt Leather	• Black belt leather available on model 3501S	-\$ 13	Specify with <i>black belt leather</i> .
	• White leather available on model 3501S	+\$ 30	Specify with <i>white leather</i> .
Felt Glides	• Glides	No cost	Specify with <i>felt glides</i> .
Related Products	• Café and conference tables		► Page 360

Specification Information														
Style Number	U.S. Base Prices												Leather Grades:	
	Fabric Grades:												COL	C
COM	6	7	8	9	10	11	12	13	14					

Wood Seat and Back

3500S	\$816	N.A.	N.A.	N.A.	N.A.	N.A.	N.A.	N.A.	N.A.	N.A.	N.A.	N.A.	N.A.
-------	-------	------	------	------	------	------	------	------	------	------	------	------	------

► Specification Information, continued on next page

 = Last order entry
 October 18, 2015

Enea Stacker Without Arms

DESIGN JACOB LLUSCA DESIGN ORIGIN: SPAIN

 = Available in Rapid10.

► Specification Information, continued from previous page

Specification Information

Style Number	U.S. Base Prices											Leather Grades:		
	Fabric Grades:											COL	C	E
	COM	6	7	8	9	10	11	12	13	14				

Upholstered Seat and Back

 3501S	\$755	\$755	\$763	\$777	\$819	\$847	\$879	\$901	\$940	\$995	\$1014	\$1232	\$1353
COM/yds = 1, COL/sq ft = 22													



Overall: 22½"D 18"W 33¼"H
Inside: 18"D 18"W 15¼"H
Seat: 18"H

Upholstered Seat and Wood Back

3502S	\$819	\$805	\$810	\$818	\$843	\$860	\$879	\$892	\$916	\$949	\$1095	\$1177	\$1254
COM/yds = ¾, COL/sq ft = 17													

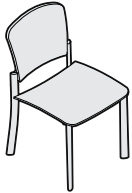

Overall: 22½"D 18"W 33¼"H
Inside: 18"D 18"W 15¼"H
Seat: 18"H

Polypropylene Seat and Back

 3503S	\$497	N.A.	N.A.	N.A.	N.A.	N.A.	N.A.	N.A.	N.A.	N.A.	N.A.	N.A.	N.A.
---	-------	------	------	------	------	------	------	------	------	------	------	------	------



Overall: 22½"D 18"W 33¼"H
Inside: 18"D 18"W 15¼"H
Seat: 18"H

Stacking Dolly

9014S	\$749	N.A.	N.A.	N.A.	N.A.	N.A.	N.A.	N.A.	N.A.	N.A.	N.A.	N.A.	N.A.
-------	-------	------	------	------	------	------	------	------	------	------	------	------	------

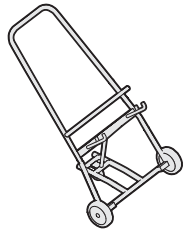

Overall: 34"D 26"W 34"H

For Canadian Pricing
Multiply U.S. Price by the
Canadian price factor.
► See page 1 for details.

Enea Bar-Height Stools with Arms

DESIGN JACOB LLUSCA DESIGN ORIGIN: SPAIN

 = Available in Rapid10.

Tip: CAL 133 for polypropylene is available as a special quote. Polypropylene color will change slightly when FR treatment is applied. Contact Customer Service for availability and pricing. Minimum quantity will apply.

Tip: Due to the design and construction techniques of the Enea Barstool only certain textiles can be successfully applied, therefore all COM fabrics must be submitted to Coalesse for approval prior to order acceptance.

Tip: Pricing based on highest grade textile specified.

Tip: Fabrics and leathers will appear loose with comfort wrinkles when upholstered.

Tip: Contrasting fabric option available on model 3511 only.

Tip: For Customer's Own Material or Leather, see necessary requirements, important processing instructions, and ordering information
▶ See *Coalesse Surface Materials Reference Guide*.

Tip: Models 3510, 3511, and 3512 are approved for CAL 133 at no charge.

Tip: Belt leather upcharge applies to COM pricing.

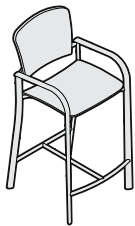

Overall: 24¾"D 22¼"W 45½"H
Inside: 18½"D 17¾"W 15¼"H
Seat: 30½"H
Arm: 39¼"H



For Canadian Pricing
Multiply U.S. Price by the Canadian price factor.
▶ See page 1 for details.

Standard Includes	Required to Specify
<ul style="list-style-type: none"> Constructed of steel tubing with cast aluminum arms Seat and back: polypropylene, wood, or upholstery (wood is laminated layers of hard maple veneer) Foot rest with leg stretchers: chrome-plated 	<ol style="list-style-type: none"> Style number Number of fabrics if contrasting fabric style number is selected Fabric or leather color number for upholstery, if selected Plastic or wood finish color number for seat and back, if selected Base/frame finish: black gloss, white gloss, and silver metallic Options, if selected (see below) <p>▶ See <i>Coalesse Surface Materials Reference Guide</i>.</p>

Options	U.S. Price	Required to Specify
Surface Materials <ul style="list-style-type: none"> Contrasting fabric 	+\$ 118 per fabric	Add suffix K to the style number and select fabric color number.
Acrylic backer <ul style="list-style-type: none"> Chair with upholstered seat and back Chair with upholstered seat and wood back 	+\$ 12 +\$ 6	Specify with <i>acrylic backer</i> . Specify with <i>acrylic backer</i> . ▶ See <i>Coalesse Surface Materials Reference Guide</i> .
Belt Leather <ul style="list-style-type: none"> Hand-stitched black belt leather seat and back available on model 3511 Hand-stitched white leather seat and back available on model 3511 	-\$ 13 +\$ 34	Specify with <i>black belt leather</i> . Specify with <i>white leather</i> .
Felt Glides <ul style="list-style-type: none"> Glides 	No cost	Specify with <i>felt glides</i> .
Related Products <ul style="list-style-type: none"> Café and conference tables 		▶ Page 360

Style Number	U.S. Base Prices												Leather Grades:		
	Fabric Grades:												COL	C	E
	COM	6	7	8	9	10	11	12	13	14					

Wood Seat and Back

3510	\$1006	N.A.	N.A.	N.A.	N.A.	N.A.	N.A.	N.A.	N.A.	N.A.	N.A.	N.A.	N.A.	N.A.
------	--------	------	------	------	------	------	------	------	------	------	------	------	------	------

▶ Specification Information, continued on next page

Enea Bar-Height Stools with Arms

DESIGN JACOB LLUSCA DESIGN ORIGIN: SPAIN

 = Available in Rapid10.

► Specification Information, continued from previous page

Specification Information

Style Number	U.S. Base Prices											Leather Grades:		
	Fabric Grades:											COL	C	E
	COM	6	7	8	9	10	11	12	13	14				

Upholstered Seat and Back

3511	\$ 947	\$ 947	\$ 957	\$ 974	\$1025	\$1058	\$1096	\$1123	\$1170	\$1235	\$1219	\$1437	\$1571
------	--------	--------	--------	--------	--------	--------	--------	--------	--------	--------	--------	--------	--------

COM/yds = 1, COL/sq ft = 22

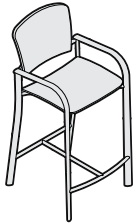

Overall: 24¾"D 22¼"W 45½"H
 Inside: 18½"D 17¾"W 15¼"H
 Seat: 30½"H
 Arm: 39¼"H

Upholstered Seat and Wood Back

3512	\$1016	\$1002	\$1007	\$1015	\$1040	\$1057	\$1076	\$1089	\$1113	\$1146	\$1294	\$1400	\$1477
------	--------	--------	--------	--------	--------	--------	--------	--------	--------	--------	--------	--------	--------

COM/yds = ¾, COL/sq ft = 17

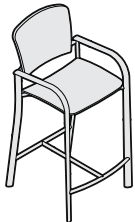

Overall: 24¾"D 22¼"W 45½"H
 Inside: 18½"D 17¾"W 15¼"H
 Seat: 30½"H
 Arm: 39¼"H

Polypropylene Seat and Back

 3513	\$ 690	N.A.	N.A.	N.A.	N.A.	N.A.	N.A.	N.A.	N.A.	N.A.	N.A.	N.A.	N.A.
--	--------	------	------	------	------	------	------	------	------	------	------	------	------

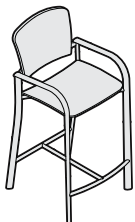

Overall: 24¾"D 22¼"W 45½"H
 Inside: 18½"D 17¾"W 15¼"H
 Seat: 30½"H
 Arm: 39¼"H

For Canadian Pricing
 Multiply U.S. Price by the
 Canadian price factor.
 ► See page 1 for details.

Enea Bar-Height Stools without Arms

DESIGN JACOB LLUSCA DESIGN ORIGIN: SPAIN

 = Available in Rapid10.

Tip: CAL 133 for polypropylene is available as a special quote. Polypropylene color will change slightly when FR treatment is applied. Contact Customer Service for availability and pricing. Minimum quantity will apply.

Tip: Due to the design and construction techniques of the Enea Barstool only certain textiles can be successfully applied, therefore all COM fabrics must be submitted to Coalesse for approval prior to order acceptance.

Tip: Pricing based on highest grade textile specified.

Tip: Fabrics and leathers will appear loose with comfort wrinkles when upholstered.

Tip: For Customer's Own Material or Leather, see necessary requirements, important processing instructions, and ordering information
 ► See *Coalesse Surface Materials Reference Guide*.

Tip: Contrasting fabric option available on model 3511S only.

Tip: Models 3510S, 3511S, and 3512S are approved for CAL 133 at no charge.

Tip: Belt leather upcharge applies to COM pricing.

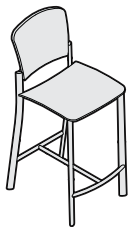

Overall: 25"D 18½"W 45¾"H
Inside: 18½"D 17¾"W 15¼"H
Seat: 30½"H



For Canadian Pricing
 Multiply U.S. Price by the Canadian price factor.
 ► See page 1 for details.

Standard Includes	Required to Specify
<ul style="list-style-type: none"> Constructed of steel tubing with cast aluminum arms Seat and back: polypropylene, wood, or upholstery (wood is laminated layers of hard maple veneer) Foot rest with leg stretchers: chrome-plated 	<ol style="list-style-type: none"> Style number Number of fabrics if contrasting fabric style number is selected Fabric or leather color number for upholstery, if selected Plastic or wood finish color number for seat and back, if selected Base/frame finish: black gloss, white gloss, and silver metallic Options, if selected (see below) ► See <i>Coalesse Surface Materials Reference Guide</i> .

Options	U.S. Price	Required to Specify
Surface Materials <ul style="list-style-type: none"> Contrasting fabric 	+\$118 per fabric	Add suffix K to the style number and select fabric color number.
Acrylic backer <ul style="list-style-type: none"> Chair with upholstered seat and back Chair with upholstered seat and wood back 	+\$ 12 +\$ 6	Specify with <i>acrylic backer</i> . Specify with <i>acrylic backer</i> . ► See <i>Coalesse Surface Materials Reference Guide</i> .
Belt Leather <ul style="list-style-type: none"> Hand-stitched black belt leather seat and back available on model 3511S Hand-stitched white leather seat and back available on model 3511S 	-\$ 13 +\$ 34	Specify with <i>black belt leather</i> . Specify with <i>white leather</i> .
Felt Glides <ul style="list-style-type: none"> Glides 	No cost	Specify with <i>felt glides</i> .
Related Products <ul style="list-style-type: none"> Café and conference tables 		► Page 360

Style Number	U.S. Base Prices												Leather Grades:			
	Fabric Grades:												COL	C	E	
	COM	6	7	8	9	10	11	12	13	14						

Wood Seat and Back

3510S	\$976	N.A.	N.A.	N.A.	N.A.	N.A.	N.A.	N.A.	N.A.	N.A.	N.A.	N.A.	N.A.	N.A.	N.A.
-------	-------	------	------	------	------	------	------	------	------	------	------	------	------	------	------

► Specification Information, continued on next page

Enea Bar-Height Stools without Arms

DESIGN JACOB LLUSCA DESIGN ORIGIN: SPAIN

 = Available in Rapid10.

► Specification Information, continued from previous page

Specification Information

Style Number	U.S. Base Prices											Leather Grades:		
	Fabric Grades:											COL	C	E
	COM	6	7	8	9	10	11	12	13	14				

Upholstered Seat and Back

3511S	\$871	\$871	\$881	\$898	\$949	\$982	\$1020	\$1047	\$1094	\$1159	\$1148	\$1367	\$1502
-------	-------	-------	-------	-------	-------	-------	--------	--------	--------	--------	--------	--------	--------

COM/yds = 1, COL/sq ft = 22

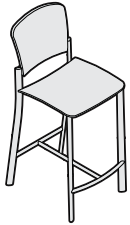

Overall: 25"D 18½"W 45¾"H
 Inside: 18½"D 17¾"W 15¼"H
 Seat: 30½"H

Upholstered Seat and Wood Back

3512S	\$936	\$922	\$927	\$935	\$960	\$977	\$ 996	\$1009	\$1033	\$1066	\$1219	\$1315	\$1390
-------	-------	-------	-------	-------	-------	-------	--------	--------	--------	--------	--------	--------	--------

COM/yds = ¾, COL/sq ft = 17

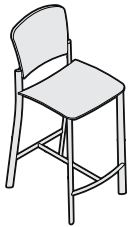

Overall: 25"D 18½"W 45¾"H
 Inside: 18½"D 17¾"W 15¼"H
 Seat: 30½"H

Polypropylene Seat and Back

 3513S	\$598	N.A.	N.A.	N.A.	N.A.	N.A.	N.A.	N.A.	N.A.	N.A.	N.A.	N.A.	N.A.
---	-------	------	------	------	------	------	------	------	------	------	------	------	------

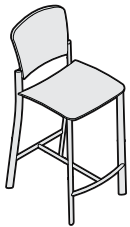

Overall: 25"D 18½"W 45¾"H
 Inside: 18½"D 17¾"W 15¼"H
 Seat: 30½"H

For Canadian Pricing
 Multiply U.S. Price by the
 Canadian price factor.
 ► See page 1 for details.

Enea Café Stools with Back

DESIGN JACOB LLUSCA DESIGN ORIGIN: SPAIN

 = Available in Rapid10.



Tip: CAL 133 for polypropylene is available as a special quote. Polypropylene color will change slightly when FR treatment is applied. Contact Customer Service for availability and pricing. Minimum quantity will apply.

Tip: For Customer's Own Material or Leather, see necessary requirements, important processing instructions, and ordering information
 ► See *Coalesse Surface Materials Reference Guide*.

Tip: Fabrics and leathers will appear loose with comfort wrinkles when upholstered.

Tip: Belt leather upcharge applies to COM pricing.

Standard Includes		Required to Specify	
	<ul style="list-style-type: none"> • Base/frame: steel tubing and base with non-skid strip • Seat and back: molded polypropylene, wood, or upholstery (wood is laminated layers of hard maple veneer) • Footrest: polished aluminum • Upholstered seat / back: Laminations of multiple density polyurethane foam and polyester fiber 		<ol style="list-style-type: none"> 1 Style number 2 Number of fabrics if contrasting fabric style number is selected 3 Fabric or leather color number for upholstery, if selected 4 Plastic or wood finish color number for seat and back, if selected 5 Base/frame finish: black gloss, white gloss, and silver metallic 6 Options, if selected (see below) ► See <i>Coalesse Surface Materials Reference Guide</i> .
Options		U.S. Price	Required to Specify
Surface Materials	<ul style="list-style-type: none"> • Contrasting fabric 	+\$118 per fabric	Add suffix K to the style number and select fabric color number.
	Acrylic backer <ul style="list-style-type: none"> • Stool with upholstered seat and back • Stool with upholstered seat and wood back 	+\$ 6 +\$ 4	Specify with <i>acrylic backer</i> . Specify with <i>acrylic backer</i> . ► See <i>Coalesse Surface Materials Reference Guide</i> .
Belt Leather	<ul style="list-style-type: none"> • Hand-stitched black belt leather seat and back available on model H351-SB2719 	+\$ 94	Specify with <i>black belt leather</i> .
	<ul style="list-style-type: none"> • Hand-stitched black belt leather seat and back available on model H351-SB3119 	+\$102	Specify with <i>black belt leather</i> .
	<ul style="list-style-type: none"> • Hand-stitched white leather seat and back available on model H351-SB2719 	+\$136	Specify with <i>white leather</i> .
	<ul style="list-style-type: none"> • Hand-stitched white leather seat and back available on model H351-SB3119 	+\$147	Specify with <i>white leather</i> .
Related Products	<ul style="list-style-type: none"> • Café and conference tables 		► Page 360



For Canadian Pricing
 Multiply U.S. Price by the Canadian price factor.
 ► See page 1 for details.

Enea Café Stools with Back

DESIGN JACOB LLUSCA DESIGN ORIGIN: SPAIN

 = Available in Rapid10.

Specification Information

Style Number	U.S. Base Prices														Leather Grades:			Wood	Poly-Propylene
	Fabric Grades:														COL	C	E		
	COM	6	7	8	9	10	11	12	13	14									

Café Counter-Height Stool, 19" Base

Upholstered Seat and Back

 H351-SB2719	\$1058	\$1044	\$1049	\$1057	\$1082	\$1099	\$1118	\$1131	\$1155	\$1188	\$1310	\$1531	\$1583	N.A.	N.A.
---	--------	--------	--------	--------	--------	--------	--------	--------	--------	--------	--------	--------	--------	------	------

COM/yds = 3/4, COL/sq ft = 13 1/2

Upholstered Seat with Wood Back

H352-SB2719	\$1115	\$1094	\$1097	\$1104	\$1122	\$1134	\$1148	\$1158	\$1175	\$1199	\$1367	\$1517	\$1552	N.A.	N.A.
-------------	--------	--------	--------	--------	--------	--------	--------	--------	--------	--------	--------	--------	--------	------	------

COM/yds = 5/8, COL/sq ft = 10

Café Bar-Height Stool, 19" Base

Upholstered Seat and Back

 H351-SB3119	\$1063	\$1049	\$1054	\$1062	\$1087	\$1104	\$1123	\$1136	\$1160	\$1193	\$1315	\$1536	\$1588	N.A.	N.A.
---	--------	--------	--------	--------	--------	--------	--------	--------	--------	--------	--------	--------	--------	------	------

COM/yds = 3/4, COL/sq ft = 13 1/2

Upholstered Seat with Wood Back

H352-SB3119	\$1121	\$1100	\$1103	\$1110	\$1128	\$1140	\$1154	\$1164	\$1181	\$1205	\$1373	\$1523	\$1564	N.A.	N.A.
-------------	--------	--------	--------	--------	--------	--------	--------	--------	--------	--------	--------	--------	--------	------	------

Café Counter-Height Stool, 19" Base

Wood Seat and Back

H350-SB2719	N.A.	N.A.	N.A.	N.A.	N.A.	N.A.	N.A.	N.A.	N.A.	N.A.	N.A.	N.A.	N.A.	\$1139	N.A.
-------------	------	------	------	------	------	------	------	------	------	------	------	------	------	--------	------

Polypropylene Seat and Back

H353-SB2719	N.A.	N.A.	N.A.	N.A.	N.A.	N.A.	N.A.	N.A.	N.A.	N.A.	N.A.	N.A.	N.A.	N.A.	\$856
-------------	------	------	------	------	------	------	------	------	------	------	------	------	------	------	-------

Café Bar-Height Stool, 19" Base

Wood Seat and Back

H350-SB3119	N.A.	N.A.	N.A.	N.A.	N.A.	N.A.	N.A.	N.A.	N.A.	N.A.	N.A.	N.A.	N.A.	\$1147	N.A.
-------------	------	------	------	------	------	------	------	------	------	------	------	------	------	--------	------

Polypropylene Seat and Back

H353-SB3119	N.A.	N.A.	N.A.	N.A.	N.A.	N.A.	N.A.	N.A.	N.A.	N.A.	N.A.	N.A.	N.A.	N.A.	\$862
-------------	------	------	------	------	------	------	------	------	------	------	------	------	------	------	-------



Overall: 19"D 19"W 38 1/4"H
Inside: 14 1/4"D 17"W 12 5/8"H
Seat: 25 5/8"H

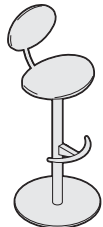

Overall: 19"D 19"W 42 1/4"H
Inside: 14 1/4"D 17"W 12 5/8"H
Seat: 29 5/8"H



Overall: 19"D 19"W 38 1/4"H
Inside: 14 1/4"D 17"W 12 5/8"H
Seat: 25 5/8"H

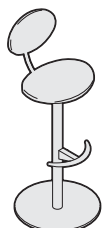

Overall: 19"D 19"W 42 1/4"H
Inside: 14 1/4"D 17"W 12 5/8"H
Seat: 29 5/8"H

 **For Canadian Pricing**
Multiply U.S. Price by the Canadian price factor.
▶ See page 1 for details.

Enea Café Stools

DESIGN JACOB LLUSCA DESIGN ORIGIN: SPAIN

Tip: CAL 133 for polypropylene is available as a special quote. Polypropylene color will change slightly when FR treatment is applied. Contact Customer Service for availability and pricing. Minimum quantity will apply.

Tip: Due to the design and construction techniques of the Enea Barstool only certain textiles can be successfully applied, therefore all COM fabrics must be submitted to Coalesse for approval prior to order acceptance.

Tip: Recommended leathers are Elmosoft Grade C and Elmorustical Grade E.

Tip: Belt leather upcharge applies to COM pricing.

Tip: Special color match, consult Customer Service.

Tip: For Customer's Own Material or Leather, see necessary requirements, important processing instructions, and ordering information
 ▶ See *Coalesse Surface Materials Reference Guide*.

Tip: Fabrics and leathers will appear loose with comfort wrinkles when upholstered.

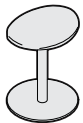

Overall: 14½"D 17"W 19¼"H
 Seat: 17⅝"H



Overall: 14½"D 17"W 27¼"H
 Seat: 25⅝"H



For Canadian Pricing
 Multiply U.S. Price by the Canadian price factor.
 ▶ See page 1 for details.

Standard Includes	Required to Specify
<ul style="list-style-type: none"> Base/Frame: steel tubing and base with non-skid strip Seat and back: molded polypropylene, wood, or upholstery (wood is laminated layers of hard maple veneer) Footrest: Polished aluminum Base/Frame Finishes: BKG = Black Gloss SM = Silver Metallic WH = White Upholstered Seat / Back: Laminations of multiple density polyurethane foam and polyester fiber 	1 Style number 2 Plastic color number for seat and back 3 Fabric or leather color number for upholstery 4 Base/frame finish: black gloss, white gloss, and silver metallic 5 Options, if selected (see below) ▶ See <i>Coalesse Surface Materials Reference Guide</i> .

Options	U.S. Price	Required to Specify
Surface Materials • Acrylic backer • Backer	+\$ 4	Specify with acrylic backer. ▶ See <i>Coalesse Surface Materials Reference Guide</i> .
Belt Leather • Hand-stitched black belt leather seat and back available on model H352-S19 • Hand-stitched black belt leather seat available on model H352-S27 and H352-S31 • Hand-stitched white belt leather seat available on model H352-S19 • Hand-stitched white belt leather seat available on model H352-S27 and HS32-S31	-\$ 7 -\$ 2 +\$39 +\$45	Specify with black belt leather. Specify with black belt leather. Specify with white leather. Specify with white leather.

Related Products • Café and conference tables ▶ Page 360

Specification Information

Style Number	U.S. Base Prices														Leather Grades:		
	Fabric Grades:														COL	C	E
	COM	6	7	8	9	10	11	12	13	14							

Low Stool with Upholstered Seat

H352-S19	\$826	\$805	\$808	\$815	\$833	\$845	\$859	\$869	\$886	\$910	\$ 966	\$1147	\$1188
COM/yds = 5/9, COL/sq ft = 10													

Café Counter-Height Stool with Upholstered Seat

H352-S27	\$860	\$839	\$842	\$849	\$867	\$879	\$893	\$903	\$920	\$944	\$1007	\$1187	\$1222
COM/yds = 5/9, COL/sq ft = 10													

▶ Specification Information, continued on next page

Enea Café Stools

DESIGN JACOB LLUSCA DESIGN ORIGIN: SPAIN

► Specification Information, continued from previous page

Specification Information

Style Number	U.S. Base Prices														Leather Grades:			Wood	Poly-Propylene
	Fabric Grades:														COL	C	E		
	COM	6	7	8	9	10	11	12	13	14									

Café Bar-Height Stool with Upholstered Seat

H352-S31	\$899	\$878	\$881	\$888	\$906	\$918	\$932	\$942	\$959	\$983	\$1039	\$1220	\$1261	N.A.	N.A.
----------	-------	-------	-------	-------	-------	-------	-------	-------	-------	-------	--------	--------	--------	------	------

COM/yds = 5%, COL/sq ft = 10

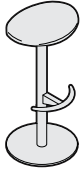

Overall: 14½"D 17"W 31¼"H
Seat: 29⅝"H

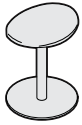

Overall: 14½"D 17"W 19¼"H
Seat: 17⅝"H

Low Stool

Wood Seat

H350-S19	N.A.	N.A.	N.A.	N.A.	N.A.	N.A.	N.A.	N.A.	N.A.	N.A.	N.A.	N.A.	N.A.	\$749	N.A.
----------	------	------	------	------	------	------	------	------	------	------	------	------	------	-------	------

Polypropylene Seat

H353-S19	N.A.	N.A.	N.A.	N.A.	N.A.	N.A.	N.A.	N.A.	N.A.	N.A.	N.A.	N.A.	N.A.	N.A.	\$588
----------	------	------	------	------	------	------	------	------	------	------	------	------	------	------	-------

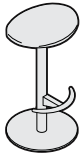

Overall: 14½"D 17"W 27¼"H
Seat: 25⅝"H

Café Counter-Height Stool

Wood Seat

H350-S27	N.A.	N.A.	N.A.	N.A.	N.A.	N.A.	N.A.	N.A.	N.A.	N.A.	N.A.	N.A.	N.A.	\$786	N.A.
----------	------	------	------	------	------	------	------	------	------	------	------	------	------	-------	------

Polypropylene Seat

H353-S27	N.A.	N.A.	N.A.	N.A.	N.A.	N.A.	N.A.	N.A.	N.A.	N.A.	N.A.	N.A.	N.A.	N.A.	\$653
----------	------	------	------	------	------	------	------	------	------	------	------	------	------	------	-------

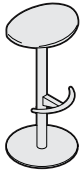

Overall: 14½"D 17"W 31¼"H
Seat: 29⅝"H

Café Bar-Height Stool

Wood Seat

H350-S31	N.A.	N.A.	N.A.	N.A.	N.A.	N.A.	N.A.	N.A.	N.A.	N.A.	N.A.	N.A.	N.A.	\$820	N.A.
----------	------	------	------	------	------	------	------	------	------	------	------	------	------	-------	------

Polypropylene Seat

H353-S31	N.A.	N.A.	N.A.	N.A.	N.A.	N.A.	N.A.	N.A.	N.A.	N.A.	N.A.	N.A.	N.A.	N.A.	\$711
----------	------	------	------	------	------	------	------	------	------	------	------	------	------	------	-------

Guest/Slider/Stack Seating

 **For Canadian Pricing**
Multiply U.S. Price by the Canadian price factor.
► See page 1 for details.

Enea Lottus Armless Chairs

DESIGN LIEVORE ALTHERR MOLINA DESIGN ORIGIN: SPAIN

Tip: For Customer's Own Material or Leather, see necessary requirements, important processing instructions, and ordering information
 ▶ See *Coalesse Surface Materials Reference Guide*.

Tip: CAL133 for polypropylene and fire code seating are available as a special quote. Polypropylene color will change slightly when FR treatment is applied. Contact customer service for availability and pricing. Minimum quantity will apply.

Standard Includes	Required to Specify
<ul style="list-style-type: none"> • Base and frame constructed of steel tubing • Seat and back: polypropylene • Insert, if selected: polypropylene or upholstery 	1 Style number 2 Plastic color number for seat and back: 003 White 0013 Sunset Orange 0014 Clover Green 0015 Sand 0016 Walnut Brown 0017 Cool Grey 0414 Anthracite Grey 0421 Blue 400 Black 409 Red 3 Fabric or leather color number for upholstery insert, if selected 4 Paint color number for base and frame: 4016 White 4017 Black 4216 Red 4217 Brown 4218 Platinum Silver 5 Options, if selected (see below) ▶ See <i>Coalesse Surface Materials Reference Guide</i> .

Options	U.S. Price	Required to Specify
Surface Materials • Acrylic backer • Backer for chair with upholstered insert	+\$6	Specify with acrylic backer. ▶ See <i>Coalesse Surface Materials Reference Guide</i> .
Felt Glides • Glides	No cost	Specify with felt glides.
Related Products • Café and conference tables		▶ Page 360

Specification Information														
Style Number	U.S. Base Prices													
	Fabric Grades:													Poly-propylene
COM	6	7	8	9	10	11	12	13	14	COL	C	E		

Armless Chair with No Insert

COEL100	\$349	N.A.	N.A.	N.A.	N.A.	N.A.	N.A.	N.A.	N.A.	N.A.	N.A.	N.A.	N.A.	N.A.
---------	-------	------	------	------	------	------	------	------	------	------	------	------	------	------

Armless Chair with Polypropylene Insert

COEL100INSERT	N.A.	N.A.	N.A.	N.A.	N.A.	N.A.	N.A.	N.A.	N.A.	N.A.	N.A.	N.A.	N.A.	N.A.	\$390
---------------	------	------	------	------	------	------	------	------	------	------	------	------	------	------	-------

▶ Specification Information, continued on next page



Overall: 20¾"D 20¾"W 30½"H
 Seat: 18"H



Overall: 20¾"D 20¾"W 30½"H
 Seat: 18"H

 **For Canadian Pricing**
 Multiply U.S. Price by the Canadian price factor.
 ▶ See page 1 for details.

Enea Lottus Armless Chairs

DESIGN LIEVORE ALTHERR MOLINA DESIGN ORIGIN: SPAIN

► Specification Information, continued from previous page

Specification Information

Style Number	U.S. Base Prices														Leather Grades:			Polypropylene
	Fabric Grades:														COL	C	E	
	COM	6	7	8	9	10	11	12	13	14								

Armless Chair with Upholstered Insert

COEL100UPH	\$523	\$509	\$514	\$522	\$547	\$564	\$583	\$596	\$620	\$653	\$743	\$755	\$784	N.A.
COM/yds = ¾, COL/sq ft = 15														



Overall: 20¾"D 20¾"W 30½"H
Seat: 18"H

Specification Information

Style Number	U.S. Price
--------------	------------

Stacking Dolly

COELDOLLY	\$735
-----------	-------

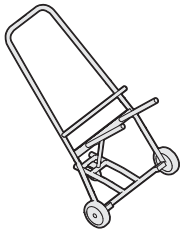

Tip: Dolly can be used with any Enea Lottus chair.

Tip: Armless chair stacks 10 high on dolly.

Tip: Cantilever arm chair stacks six high on dolly.

Tip: Loop arm chair stacks six high on dolly.

Guest/Slide/Stack Seating



For Canadian Pricing
Multiply U.S. Price by the Canadian price factor.
► See page 1 for details.

Enea Lottus Cantilever Arm Chairs

DESIGN LIEVORE ALTHERR MOLINA DESIGN ORIGIN: SPAIN

Tip: Cantilever arm can hook on table to provide storing option.

Tip: Cantilever arm stacks 6 high.

Tip: Can specify arm cap in any plastic color for Lottus.

Tip: For Customer's Own Material or Leather, see necessary requirements, important processing instructions, and ordering information
 ▶ See *Coalesse Surface Materials Reference Guide*.

Tip: CAL133 for polypropylene and fire code seating are available as a special quote. Polypropylene color will change slightly when FR treatment is applied. Contact customer service for availability and pricing. Minimum quantity will apply.

Standard Includes	Required to Specify
-------------------	---------------------

- Base and frame constructed of steel tubing
- Seat and back: polypropylene
- Arm cap: polypropylene
- Insert, if selected: polypropylene or upholstery

- 1 Style number
- 2 Plastic color number for seat, back, and arm cap:
 - 003 White
 - 0013 Sunset Orange
 - 0014 Clover Green
 - 0015 Sand
 - 0016 Walnut Brown
 - 0017 Cool Grey
 - 0414 Anthracite Grey
 - 0421 Blue
 - 400 Black
 - 409 Red
- 3 Fabric or leather color number for upholstery insert, if selected
- 4 Paint color number for base and frame:
 - 4016 White
 - 4017 Black
 - 4216 Red
 - 4217 Brown
 - 4218 Platinum Silver
- 5 Options, if selected (see below)
 ▶ See *Coalesse Surface Materials Reference Guide*.

	Options	U.S. Price	Required to Specify
--	---------	------------	---------------------

Surface Materials	Acrylic backer • Backer for chair with upholstered insert	+\$6	Specify with acrylic backer. ▶ See <i>Coalesse Surface Materials Reference Guide</i> .
Felt Glides	• Glides	No cost	Specify with felt glides.
Related Products	• Café and conference tables		▶ Page 360

Specification Information

Style Number	U.S. Base Prices														Leather Grades:			Polypropylene
	Fabric Grades:														COL	C	E	
	COM	6	7	8	9	10	11	12	13	14								

Cantilever Arm Chair with No Insert

COEL200	\$431	N.A.	N.A.	N.A.	N.A.	N.A.	N.A.	N.A.	N.A.	N.A.	N.A.	N.A.	N.A.	N.A.	N.A.
---------	-------	------	------	------	------	------	------	------	------	------	------	------	------	------	------



Overall: 20¾"D 23¾"W 30½"H
 Seat: 18"H
 Arm: 26"H

Cantilever Arm Chair with Polypropylene Insert

COEL200INSERT	N.A.	N.A.	N.A.	N.A.	N.A.	N.A.	N.A.	N.A.	N.A.	N.A.	N.A.	N.A.	N.A.	N.A.	N.A.	\$471
---------------	------	------	------	------	------	------	------	------	------	------	------	------	------	------	------	-------

▶ Specification Information, continued on next page



Overall: 20¾"D 23¾"W 30½"H
 Seat: 18"H
 Arm: 26"H

Enea Lottus Cantilever Arm Chairs

DESIGN LIEVORE ALTHERR MOLINA DESIGN ORIGIN: SPAIN

► Specification Information, continued from previous page

Specification Information

Style Number	U.S. Base Prices														Leather Grades:			Polypropylene
	Fabric Grades:														COL	C	E	
	COM	6	7	8	9	10	11	12	13	14								

Cantilever Arm Chair with Upholstered Insert

COEL200UPH	\$602	\$588	\$593	\$601	\$626	\$643	\$662	\$675	\$699	\$732	\$822	\$834	\$863	N.A.
COM/yds = ¾, COL/sq ft = 15														



Overall: 20¾"D 23¾"W 30½"H
 Seat: 18"H
 Arm: 26"H

Guest/Side/Stack Seating



For Canadian Pricing
 Multiply U.S. Price by the Canadian price factor.
 ► See page 1 for details.

Enea Lottus Aluminum Loop Arm Chairs

DESIGN LIEVORE ALTHERR MOLINA DESIGN ORIGIN: SPAIN

Tip: Arm chair stacks six high.

Tip: For Customer's Own Material or Leather, see necessary requirements, important processing instructions, and ordering information

▶ See *Coalesse Surface Materials Reference Guide*.

Tip: CAL133 for polypropylene and fire code seating are available as a special quote. Polypropylene color will change slightly when FR treatment is applied. Contact customer service for availability and pricing. Minimum quantity will apply.

Standard Includes	Required to Specify
<ul style="list-style-type: none"> • Base and frame constructed of steel tubing • Seat and back: polypropylene • Arm: aluminum • Insert, if selected: polypropylene or upholstery 	<ol style="list-style-type: none"> 1 Style number 2 Plastic color number for seat, back, and arm cap: <ul style="list-style-type: none"> 003 White 0013 Sunset Orange 0014 Clover Green 0015 Sand 0016 Walnut Brown 0017 Cool Grey 0414 Anthracite Grey 0421 Blue 400 Black 409 Red 3 Fabric or leather color number for upholstery insert, if selected 4 Paint color number for base and frame: <ul style="list-style-type: none"> 4016 White 4017 Black 4216 Red 4217 Brown 4218 Platinum Silver 5 Options, if selected (see below) <p>▶ See <i>Coalesse Surface Materials Reference Guide</i>.</p>

Options	U.S. Price	Required to Specify
Surface Materials <ul style="list-style-type: none"> • Acrylic backer • Backer for chair with upholstered insert 	+\$6	Specify with acrylic backer. ▶ See <i>Coalesse Surface Materials Reference Guide</i> .
Felt Glides <ul style="list-style-type: none"> • Glides 	No cost	Specify with felt glides.
Related Products <ul style="list-style-type: none"> • Café and conference tables 		▶ Page 360

Specification Information															
Style Number	U.S. Base Prices													Leather Grades:	Polypropylene
	Fabric Grades:														
COM	6	7	8	9	10	11	12	13	14						

Aluminum Loop Arm Chair with No Insert

COEL300	\$465	N.A.	N.A.	N.A.	N.A.	N.A.	N.A.	N.A.	N.A.	N.A.	N.A.	N.A.	N.A.	N.A.
---------	-------	------	------	------	------	------	------	------	------	------	------	------	------	------



Aluminum Loop Arm Chair with Polypropylene Insert

COEL300INSERT	N.A.	N.A.	N.A.	N.A.	N.A.	N.A.	N.A.	N.A.	N.A.	N.A.	N.A.	N.A.	N.A.	N.A.	\$505
---------------	------	------	------	------	------	------	------	------	------	------	------	------	------	------	-------

▶ Specification Information, continued on next page



 **For Canadian Pricing**
 Multiply U.S. Price by the Canadian price factor.
 ▶ See page 1 for details.

Enea Lottus Aluminum Loop Arm Chairs

DESIGN LIEVORE ALTHERR MOLINA DESIGN ORIGIN: SPAIN

► Specification Information, continued from previous page

Specification Information

Style Number	U.S. Base Prices														Leather Grades:			Polypropylene
	Fabric Grades:														COL	C	E	
	COM	6	7	8	9	10	11	12	13	14								

Aluminum Loop Arm Chair with Upholstered Insert

COEL300UPH	\$637	\$623	\$628	\$636	\$661	\$678	\$697	\$710	\$734	\$767	\$871	\$869	\$898	N.A.
------------	-------	-------	-------	-------	-------	-------	-------	-------	-------	-------	-------	-------	-------	------

COM/yds = ¾, COL/sq ft = 15



For Canadian Pricing
 Multiply U.S. Price by the
 Canadian price factor.
 ► See page 1 for details.

Enea Lottus Sled Base Stools

DESIGN LIEVORE ALTHERR MOLINA DESIGN ORIGIN: SPAIN

Tip: For Customer's Own Material or Leather, see necessary requirements, important processing instructions, and ordering information
 ▶ See *Coalesse Surface Materials Reference Guide*.

Tip: CAL133 for polypropylene and fire code seating are available as a special quote. Polypropylene color will change slightly when FR treatment is applied. Contact customer service for availability and pricing. Minimum quantity will apply.

Standard Includes	Required to Specify
-------------------	---------------------

- Base and frame constructed of steel tubing
- Seat and back: polypropylene
- Insert, if selected: Polypropylene or upholstery

- 1 Style number
 - 2 Plastic color number for seat and back:
 - 003 White
 - 0013 Sunset Orange
 - 0014 Clover Green
 - 0015 Sand
 - 0016 Walnut Brown
 - 0017 Cool Grey
 - 0414 Anthracite Grey
 - 0421 Blue
 - 400 Black
 - 409 Red
 - 3 Fabric or leather color number for upholstery insert, if selected
 - 4 Paint color number for base and frame:
 - 4016 White
 - 4017 Black
 - 4216 Red
 - 4217 Brown
 - 4218 Platinum Silver
 - 5 Options, if selected (see below)
- ▶ See *Coalesse Surface Materials Reference Guide*.

Options	U.S. Price	Required to Specify
---------	------------	---------------------

Surface Materials	Acrylic backer • Backer for chair with upholstered insert	+\$6	Specify with acrylic backer. ▶ See <i>Coalesse Surface Materials Reference Guide</i> .
Related Products	• Café and conference tables		▶ Page 360

Specification Information

Style Number	U.S. Base Prices														Leather Grades:			Polypropylene
	COM	6	7	8	9	10	11	12	13	14	COL	C	E					

Sled Base Counter-Height Stool with No Insert

COEL500	\$510	N.A.	N.A.	N.A.	N.A.	N.A.	N.A.	N.A.	N.A.	N.A.	N.A.	N.A.	N.A.	N.A.	N.A.
---------	-------	------	------	------	------	------	------	------	------	------	------	------	------	------	------



Overall: 18"D 18¼"W 34½"H
 Seat: 26¼"H

Sled Base Counter-Height Stool with Polypropylene Insert

COEL500INSERT	N.A.	N.A.	N.A.	N.A.	N.A.	N.A.	N.A.	N.A.	N.A.	N.A.	N.A.	N.A.	N.A.	N.A.	\$540
---------------	------	------	------	------	------	------	------	------	------	------	------	------	------	------	-------

▶ Specification Information, continued on next page



Overall: 18"D 18¼"W 34½"H
 Seat: 26¼"H



For Canadian Pricing
 Multiply U.S. Price by the Canadian price factor.
 ▶ See page 1 for details.

Enea Lottus Sled Base Stools

DESIGN LIEVORE ALTHERR MOLINA DESIGN ORIGIN: SPAIN

► Specification Information, continued from previous page

Specification Information

Style Number	U.S. Base Prices														Leather Grades:			Polypropylene
	Fabric Grades:														COL	C	E	
	COM	6	7	8	9	10	11	12	13	14								

Sled Base Counter-Height Stool with Upholstered Insert

COEL500UPH	\$671	\$657	\$662	\$670	\$695	\$712	\$731	\$744	\$768	\$801	\$905	\$903	\$932	N.A.
COM/yds = ¾, COL/sq ft = 15														



Overall: 18"D 18¼"W 34½"H
Seat: 26¼"H

Sled Base Bar-Height Stool with No Insert

COEL400	\$562	N.A.	N.A.	N.A.	N.A.	N.A.	N.A.	N.A.	N.A.	N.A.	N.A.	N.A.	N.A.	N.A.
---------	-------	------	------	------	------	------	------	------	------	------	------	------	------	------



Overall: 18"D 18¼"W 38½"H
Seat: 30"H

Sled Base Bar-Height Stool with Polypropylene Insert

COEL400INSERT	N.A.	N.A.	N.A.	N.A.	N.A.	N.A.	N.A.	N.A.	N.A.	N.A.	N.A.	N.A.	N.A.	\$592
---------------	------	------	------	------	------	------	------	------	------	------	------	------	------	-------



Overall: 18"D 18¼"W 38½"H
Seat: 30"H

Sled Base Bar-Height Stool with Upholstered Insert

COEL400UPH	\$723	\$709	\$714	\$722	\$747	\$764	\$783	\$796	\$820	\$853	\$957	\$955	\$984	N.A.
COM/yds = ¾, COL/sq ft = 15														



Overall: 18"D 18¼"W 38½"H
Seat: 30"H

Guest/ Side/ Stack Seating



For Canadian Pricing
Multiply U.S. Price by the Canadian price factor.
► See page 1 for details.

Enea Lottus Post Base Stools

DESIGN LIEVORE ALTHERR MOLINA DESIGN ORIGIN: SPAIN

Tip: Post stool seat swivels.

Tip: For Customer's Own Material or Leather, see necessary requirements, important processing instructions, and ordering information

► See *Coalesse Surface Materials Reference Guide*.

Tip: CAL133 for polypropylene and fire code seating are available as a special quote. Polypropylene color will change slightly when FR treatment is applied. Contact customer service for availability and pricing. Minimum quantity will apply.

Standard Includes	Required to Specify
-------------------	---------------------

- Base and frame constructed of steel tubing
- Seat and back: polypropylene
- Insert, if selected: Polypropylene or upholstery

- 1 Style number
 - 2 Plastic color number for seat and back:
 - 003 White
 - 0013 Sunset Orange
 - 0014 Clover Green
 - 0015 Sand
 - 0016 Walnut Brown
 - 0017 Cool Grey
 - 0414 Anthracite Grey
 - 0421 Blue
 - 400 Black
 - 409 Red
 - 3 Fabric or leather color number for upholstery insert, if selected
 - 4 Paint color number for base and frame:
 - 4016 White
 - 4017 Black
 - 4216 Red
 - 4217 Brown
 - 4218 Platinum Silver
 - 5 Options, if selected (see below)
- See *Coalesse Surface Materials Reference Guide*.

Options	U.S. Price	Required to Specify
---------	------------	---------------------

Surface Materials	Acrylic backer		
	• Chair with upholstered insert	+\$ 6	Specify with acrylic backer. ► See <i>Coalesse Surface Materials Reference Guide</i> .
	• Polished trivalent chrome ring	+\$60	Specify with trivalent chrome ring.
Related Products	• Café and conference tables		► Page 360

Specification Information

Style Number	U.S. Base Prices														Leather Grades:		Polypropylene
	Fabric Grades:																
COM	6	7	8	9	10	11	12	13	14	COL	C	E					

Post Base Counter-Height Stool with No Insert

COEL700	\$987	N.A.	N.A.	N.A.	N.A.	N.A.	N.A.	N.A.	N.A.	N.A.	N.A.	N.A.	N.A.	N.A.	N.A.
---------	-------	------	------	------	------	------	------	------	------	------	------	------	------	------	------

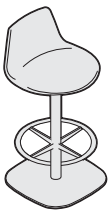

Overall: 19¾"D 19¾"W 34½"H
Seat: 26¼"H

Post Base Counter-Height Stool with Polypropylene Insert

COEL700INSERT	N.A.	N.A.	N.A.	N.A.	N.A.	N.A.	N.A.	N.A.	N.A.	N.A.	N.A.	N.A.	N.A.	N.A.	N.A.	\$1016
---------------	------	------	------	------	------	------	------	------	------	------	------	------	------	------	------	--------

► Specification Information, continued on next page

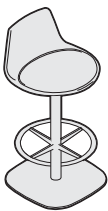

Overall: 19¾"D 19¾"W 34½"H
Seat: 26¼"H

Enea Lottus Post Base Stools

DESIGN LIEVORE ALTHERR MOLINA DESIGN ORIGIN: SPAIN

► Specification Information, continued from previous page

Specification Information

Style Number	U.S. Base Prices														Leather Grades:		Polypropylene
	Fabric Grades:														C	E	
	COM	6	7	8	9	10	11	12	13	14	COL						

Post Base Counter-Height Stool with Upholstered Insert

COEL700UPH	\$1147	\$1133	\$1138	\$1146	\$1171	\$1188	\$1207	\$1220	\$1244	\$1277	\$1381	\$1379	\$1408	N.A.
------------	--------	--------	--------	--------	--------	--------	--------	--------	--------	--------	--------	--------	--------	------

COM/yds = ¾, COL/sq ft = 15

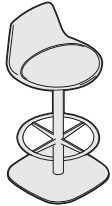

Overall: 19¾"D 19¾"W 34½"H
Seat: 26¼"H

Post Base Bar-Height Stool with No Insert

COEL600	\$ 998	N.A.	N.A.	N.A.	N.A.	N.A.	N.A.	N.A.	N.A.	N.A.	N.A.	N.A.	N.A.	N.A.
---------	--------	------	------	------	------	------	------	------	------	------	------	------	------	------

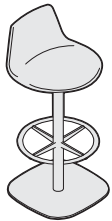

Overall: 19¾"D 19¾"W 38½"H
Seat: 30"H

Post Base Bar-Height Stool with Polypropylene Insert

COEL600INSERT	N.A.	N.A.	N.A.	N.A.	N.A.	N.A.	N.A.	N.A.	N.A.	N.A.	N.A.	N.A.	N.A.	\$1028
---------------	------	------	------	------	------	------	------	------	------	------	------	------	------	--------

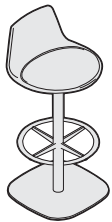

Overall: 19¾"D 19¾"W 38½"H
Seat: 30"H

Post Base Bar-Height Stool with Upholstered Insert

COEL600UPH	\$1160	\$1146	\$1151	\$1159	\$1184	\$1201	\$1220	\$1233	\$1257	\$1290	\$1394	\$1392	\$1421	N.A.
------------	--------	--------	--------	--------	--------	--------	--------	--------	--------	--------	--------	--------	--------	------

COM/yds = ¾, COL/sq ft = 15

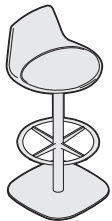

Overall: 19¾"D 19¾"W 38½"H
Seat: 30"H

Guest/ Side/ Stack Seating



For Canadian Pricing
Multiply U.S. Price by the Canadian price factor.
► See page 1 for details.

Kart Nesting Chairs

DESIGN 5D STUDIO

 = Available in Rapid10.

Tip: COM must be approved for use. Call Customer Service at 1.800.627.6770.

Tip: Fabrics and leathers will appear loose with comfort wrinkles when upholstered.

Tip: For Customer's Own Material or Leather, see necessary requirements, important processing instructions, and ordering information
 ▶ See *Coalesse Surface Materials Reference Guide*.

Standard Includes	Required to Specify
<ul style="list-style-type: none"> • Four-prong Kart nesting base with nylon base tooth: die-cast aluminum with powder coat • Rub strips: injection-molded black polypropylene • Yoke strips: injection-molded black polypropylene • Hard, dual-wheel casters for use on carpet: black plastic • Seat and back: black or gray textured contoured, injection-molded glass-filled Polyurethane • Upholstered seat or upholstered seat and back, if selected: molded urethane foam over injection-molded polypropylene inner shell(s) • Folding seat with self-aligning features • Back supports: one-piece die-cast aluminum • Arms, if selected: die-cast aluminum support bar with black, molded, self-skinning polyurethane arm cap • Pneumatic height adjustment • Tilt tension adjustment • Zero front rise • Forward back lock 	<ol style="list-style-type: none"> 1 Style number 2 Powder coat color number for base 3 Color number for seat and back: <ul style="list-style-type: none"> - 6052 Milk - 6248 Midnight Brown - 6400 Black - 6427 Grey 4 Fabric or leather color number for upholstery 5 Options, if selected (see below) ▶ See <i>Coalesse Surface Materials Reference Guide</i> .

	Options	U.S. Price	Required to Specify
Surface Materials	Acrylic backer <ul style="list-style-type: none"> • Backer 	+\$ 8	Specify with acrylic backer. ▶ See <i>Coalesse Surface Materials Reference Guide</i> .
Casters	<ul style="list-style-type: none"> • Soft, dual-wheel casters for use on hard floors 	+\$40	Specify with soft casters.
Extra Foam	<ul style="list-style-type: none"> • Extra foam 	+\$68	Specify with extra foam.
Bell Glide	<ul style="list-style-type: none"> • Bell glide 	+\$34	Specify with bell glide.
Related Products	<ul style="list-style-type: none"> • Jury base • Pouch and leash 		▶ Page 306 ▶ Page 299

Specification Information	
Style Number	U.S. Base Price

Non-Upholstered with Arms

 126101 \$836



Overall: 22½"D 24½"W 32½"-38"H
 Seat: 17¾"D 19"W 16"-21"H
 Arm: 25"-30½"H

Non-Upholstered without Arms

 126100 \$763

▶ Specification Information, continued on next page



For Canadian Pricing
 Multiply U.S. Price by the Canadian price factor.
 ▶ See page 1 for details.

Kart Nesting Chairs

DESIGN 5D STUDIO

 = Available in Rapid10.

► Specification Information, continued from previous page

Specification Information

Style Number	U.S. Base Prices											Leather Grades:		
	Fabric Grades:											COL	C	E
	COM	6	7	8	9	10	11	12	13	14				



Upholstered Seat with Arms

 126201S	\$1054	\$1044	\$1062	\$1085	\$1112	\$1136	\$1162	\$1185	\$1191	\$1254	\$1118	\$1393	\$1477
COM/yds = 1, COL/sq ft = 12													

Upholstered Seat and Back with Arms

 126201	\$1107	\$1101	\$1115	\$1138	\$1165	\$1189	\$1215	\$1238	\$1244	\$1307	\$1176	\$1567	\$1677
COM/yds = 1, COL/sq ft = 19													



Upholstered Seat without Arms

 126200S	\$ 976	\$ 966	\$ 984	\$1007	\$1034	\$1058	\$1084	\$1107	\$1113	\$1176	\$1037	\$1315	\$1399
COM/yds = 1, COL/sq ft = 12													

Upholstered Seat and Back without Arms

 126200	\$1028	\$1019	\$1036	\$1059	\$1086	\$1110	\$1136	\$1159	\$1165	\$1228	\$1095	\$1356	\$1437
COM/yds = 1, COL/sq ft = 19													

Guest/Slider/Stack Seating

Pouch and Leash for Use on Nesting Chairs



Standard Includes

- Leash to retain up to 10 nested chairs
- Pouch to store leash
- Pouch attaches to bottom of seat

Required to Specify

Style number

Specification Information

Style Number	U.S. Price
--------------	------------

 126900	\$68
--	------



For Canadian Pricing
Multiply U.S. Price by the Canadian price factor.
► See page 1 for details.

Kart Stools on Casters

DESIGN 5D STUDIO

 = Available in Rapid10.

Tip: COM must be approved for use. Call Customer Service at 1.800.627.6770.

Tip: Stools do not nest.

Tip: Fabrics and leathers will appear loose with comfort wrinkles when upholstered.

Tip: For Customer's Own Material or Leather, see necessary requirements, important processing instructions, and ordering information
 ► See *Coalesse Surface Materials Reference Guide*.

Standard Includes	Required to Specify
<ul style="list-style-type: none"> • Five-prong base with 25" span: one-piece die-cast aluminum with powder coat color • Telescoping hub cover: black plastic • Adjustable 19" diameter chrome foot ring • Hard, dual-wheel casters for use on carpet: black • Seat and back: black or gray textured contoured, injection-molded glass-filled polypropylene • Upholstered seat or upholstered seat and back, if selected: molded urethane foam over injection-molded polypropylene inner shell(s) • Back supports: one-piece die-cast aluminum • Arms, if selected: die-cast aluminum support bar with black, molded, self-skinning polyurethane arm cap • Pneumatic height adjustment • Tilt tension adjustment • Zero front rise • Forward back lock 	<ol style="list-style-type: none"> 1 Style number 2 Powder coat color number for base 3 Color number for seat and back: <ul style="list-style-type: none"> - 6052 Milk - 6248 Midnight Brown - 6400 Black - 6427 Grey 4 Fabric or leather color number for upholstery 5 Options, if selected (see below) ► See <i>Coalesse Surface Materials Reference Guide</i> .

Options	U.S. Price	Required to Specify
Surface Materials <ul style="list-style-type: none"> • Acrylic backer • Backer 	+\$ 8	Specify with acrylic backer. ► See <i>Coalesse Surface Materials Reference Guide</i> .
Casters <ul style="list-style-type: none"> • Soft, dual-wheel casters for use on hard floors 	+\$40	Specify with soft casters.
Extra Foam <ul style="list-style-type: none"> • Extra foam 	+\$68	Specify with extra foam.
Bell Glide <ul style="list-style-type: none"> • Bell glide 	+\$34	Specify with bell glide.

Specification Information	
Style Number	U.S. Base Price

Non-Upholstered with Arms

 126101ST \$988



Overall: 22½"D 24½"W 36½"-44"H
 Seat: 17¾"D 19"W 21"-28½"H
 Arm: 30½"-38"H
 Foot Ring: 8¼"-15½"

Non-Upholstered without Arms

 126100ST \$913

► Specification Information, continued on next page



For Canadian Pricing
 Multiply U.S. Price by the Canadian price factor.
 ► See page 1 for details.

Kart Stools on Casters

DESIGN 5D STUDIO

 = Available in Rapid10.

► Specification Information, continued from previous page

Specification Information

Style Number	U.S. Base Prices													
	Fabric Grades:											Leather Grades:		
	COM	6	7	8	9	10	11	12	13	14	COL	C	E	

Upholstered Seat with Arms

 126201SST	\$1205	\$1201	\$1213	\$1236	\$1263	\$1287	\$1313	\$1336	\$1342	\$1405	\$1276	\$1544	\$1628
COM/yds = 1, COL/sq ft = 12													

Upholstered Seat and Back with Arms

 126201ST	\$1258	\$1255	\$1266	\$1289	\$1316	\$1340	\$1366	\$1389	\$1395	\$1458	\$1331	\$1718	\$1828
COM/yds = 1, COL/sq ft = 19													

Upholstered Seat without Arms

 126200SST	\$1129	\$1123	\$1137	\$1160	\$1187	\$1211	\$1237	\$1260	\$1266	\$1329	\$1197	\$1468	\$1552
COM/yds = 1, COL/sq ft = 12													

Upholstered Seat and Back without Arms

 126200ST	\$1183	\$1179	\$1191	\$1214	\$1241	\$1265	\$1291	\$1314	\$1320	\$1383	\$1254	\$1643	\$1753
COM/yds = 1, COL/sq ft = 19													



For Canadian Pricing
 Multiply U.S. Price by the
 Canadian price factor.
 ► See page 1 for details.

Kart Café Four-Leg Stools with Arms

DESIGN 5D STUDIO

 = Available in Rapid10.



Overall: 25"D 22⁹/₂₅"W 46"H
Seat: 18¹/₄"D 19⁷/₁₀"W 30"H
Arm: 38⁴/₂₅"H
Foot Rest: 13¹/₄" from floor

Tip: COM must be approved for use. Call Customer Service at 1.800.627.6770.

Tip: Chairs do not stack.

Tip: Fabrics and leathers will appear loose with comfort wrinkles when upholstered.

Tip: For Customer's Own Material or Leather, see necessary requirements, important processing instructions, and ordering information
 ▶ See *Coalesse Surface Materials Reference Guide*.

Tip: Arms, glides, and back-seat connection will always be black.

Standard Includes

- Frame: 16-gauge tubular steel with powder coat color
- Flex bars: two black resilient polypropylene flexible connectors in the back frame allow the back to tilt back approximately eight degrees for added comfort
- Glides: non-marring, black polypropylene
- Seat and back: black textured contoured, injection-molded glass-filled, high-impact polypropylene
- Upholstered seat or upholstered seat and back, if selected: resilient, flame-retardant, molded urethane foam over injection-molded polypropylene inner shell(s)

Required to Specify

- 1 Style number
 - 2 Powder coat color number for base
 - 3 Color number for seat and back:
 - 6052 Milk
 - 6248 Midnight Brown
 - 6400 Black
 - 4 Fabric or leather color number for upholstery
 - 5 Options, if selected (see below)
- ▶ See *Coalesse Surface Materials Reference Guide*.

Options

Surface Materials	Options	U.S. Price	Required to Specify
	Acrylic backer		
	• Backer	+\$8	Specify with acrylic backer. ▶ See <i>Coalesse Surface Materials Reference Guide</i> .

Specification Information

Style Number	U.S. Price
--------------	------------

Non-Upholstered

 126111ST	\$526
--	-------

Specification Information

Style Number	U.S. Base Prices											Leather Grades:		
	Fabric Grades:											COL	C	E
	COM	6	7	8	9	10	11	12	13	14				

Upholstered Seat

 126211SST	\$819	\$802	\$830	\$857	\$884	\$905	\$ 932	\$ 956	\$ 964	\$1029	\$877	\$1180	\$1267
---	-------	-------	-------	-------	-------	-------	--------	--------	--------	--------	-------	--------	--------

COM/yds = 1, COL/sq ft = 12

Upholstered Seat and Back

 126211ST	\$906	\$892	\$917	\$944	\$971	\$992	\$1019	\$1043	\$1051	\$1116	\$967	\$1394	\$1510
--	-------	-------	-------	-------	-------	-------	--------	--------	--------	--------	-------	--------	--------

COM/yds = 1, COL/sq ft = 19



For Canadian Pricing
 Multiply U.S. Price by the Canadian price factor.
 ▶ See page 1 for details.

Kart Stack Stacking Chairs with Arms

DESIGN 5D STUDIO

 = Available in Rapid10.

Tip: COM must be approved for use. Call Customer Service at 1.800.627.6770.

Tip: Chairs stack six high on the floor.

Tip: Fabrics and leathers will appear loose with comfort wrinkles when upholstered.

Tip: For Customer's Own Material or Leather, see necessary requirements, important processing instructions, and ordering information
 ▶ See *Coalesse Surface Materials Reference Guide*.

Tip: Arms, glides, and back-seat connection will always be black.

Standard Includes	Required to Specify
-------------------	---------------------

<ul style="list-style-type: none"> • Frame: 16-gauge tubular steel with powder coat color • Flex bars: two black resilient polypropylene flexible connectors in the back frame allow the back to tilt back approximately eight degrees for added comfort • Glides: non-marring, black polypropylene • Seat and back: black textured contoured, injection-molded glass-filled, high-impact polypropylene • Upholstered seat or upholstered seat and back, if selected: resilient, flame-retardant, molded urethane foam over injection-molded polypropylene inner shell(s) 	1 Style number 2 Powder coat color number for base 3 Color number for seat and back: - 6052 Milk - 6248 Midnight Brown - 6400 Black 4 Fabric or leather color number for upholstery 5 Options, if selected (see below) ▶ See <i>Coalesse Surface Materials Reference Guide</i> .
--	--

Options	U.S. Price	Required to Specify
---------	------------	---------------------

Surface Materials <ul style="list-style-type: none"> • Acrylic backer • Backer 	+ \$8	Specify with acrylic backer. ▶ See <i>Coalesse Surface Materials Reference Guide</i> .
Casters <ul style="list-style-type: none"> • Hard, dual-wheel casters for use on carpet 	No cost	Add suffix C to the style number.
Related Products <ul style="list-style-type: none"> • Dolly 		▶ Page 304

Specification Information

Style Number	U.S. Price
--------------	------------

Non-Upholstered

 126111	\$434
--	-------

Specification Information

Style Number	U.S. Base Prices										Leather Grades:		
	Fabric Grades:										COL	C	E
COM	6	7	8	9	10	11	12	13	14				

Upholstered Seat

 126211S	\$711	\$692	\$726	\$754	\$783	\$809	\$836	\$864	\$872	\$ 942	\$769	\$1102	\$1196
COM/yds = 1, COL/sq ft = 12													

Upholstered Seat and Back

 126211	\$803	\$787	\$818	\$846	\$875	\$901	\$928	\$956	\$964	\$1034	\$863	\$1331	\$1456
COM/yds = 1, COL/sq ft = 19													



Overall: 22¾"D 22¼"W 32⅞"H
 Seat: 18¼"D 19¾"W 17⅞"H
 Arm: 26"H

For Canadian Pricing
 Multiply U.S. Price by the Canadian price factor.
 ▶ See page 1 for details.

Kart Stack Accessory

DESIGN 5D STUDIO

Dolly

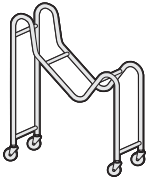

Tip: Holds 10 chairs (40"D x 25"W x 63"H non-upholstered or 68"H upholstered).

Standard Includes	Required to Specify
-------------------	---------------------

- | | |
|--|--------------|
| <ul style="list-style-type: none"> • 35"D x 14½"W x 42½"H four-wheel dolly: black | Style number |
|--|--------------|

Specification Information	
---------------------------	--

Style Number	U.S. Price
793390	\$468

For Canadian Pricing
 Multiply U.S. Price by the
 Canadian price factor.
 ▶ See page 1 for details.

Coalesse

Kart Stack *Accessory*

DESIGN 5D STUDIO

Kart Jury Bases

Tip: Standard seat height range: 16 1/2"-20 1/2"H.

Tip: Tall seat height range: 19 1/4"-23 1/4"H.

Tip: Kart seat folds up.

Tip: COM must be approved for use. Call Customer Service at 1.800.627.6770.

Tip: Fabrics and leathers will appear loose with comfort wrinkles when upholstered.

Tip: For Customer's Own Material or Leather, see necessary requirements, important processing instructions, and ordering information
 ▶ See Coalesse Surface Materials Reference Guide.

Tip: Jury bases are standard with pneumatic swivel-tilt return mechanism.



Standard Includes	Required to Specify
-------------------	---------------------

- | | |
|---|--|
| <ul style="list-style-type: none"> • Pneumatic height adjustment • Jury base with memory return and 180 degree swivel • Standard jury base, if selected, is made up of 2 1/2"-diameter column and 8" base plate: 4134 black only • Tall jury base, if selected, is made up of 2 1/2"-diameter column and 8" base plate: 4134 black only • Hardware for floor attachment not included | 1 Style number
2 Options, if selected (see below) |
|---|--|

Options	U.S. Price	Required to Specify
---------	------------	---------------------

Surface Materials • Acrylic backer • Backer	+\$ 8	Specify with acrylic backer. ▶ See Coalesse Surface Materials Reference Guide.
Extra Foam • Extra foam when upholstered	+\$68	Specify with extra foam.
Related Products • Kart		▶ Page 298

Specification Information													
Style Number	U.S. Base Prices												Leather Grades:
	Fabric Grades:												COL C E
COM	6	7	8	9	10	11	12	13	14	15	16	17	18

Kart with Arms-Standard

127101J	\$1079	N.A.	N.A.	N.A.	N.A.	N.A.	N.A.	N.A.	N.A.	N.A.	N.A.	N.A.	N.A.
127201SJ	\$1297	\$1294	\$1305	\$1328	\$1355	\$1379	\$1405	\$1428	\$1434	\$1497	\$1370	\$1636	\$1720
127201J	\$1350	\$1349	\$1358	\$1381	\$1408	\$1432	\$1458	\$1481	\$1487	\$1550	\$1424	\$1810	\$1920

Kart Armless-Standard

127100J	\$1006	N.A.	N.A.	N.A.	N.A.	N.A.	N.A.	N.A.	N.A.	N.A.	N.A.	N.A.	N.A.
127200SJ	\$1219	\$1215	\$1227	\$1250	\$1277	\$1301	\$1327	\$1350	\$1356	\$1419	\$1289	\$1558	\$1642
127200J	\$1271	\$1268	\$1279	\$1302	\$1329	\$1353	\$1379	\$1402	\$1408	\$1471	\$1343	\$1599	\$1680

▶ Specification Information, continued on next page



For Canadian Pricing
 Multiply U.S. Price by the Canadian price factor.
 ▶ See page 1 for details.

Kart Jury Bases

► Specification Information, continued from previous page

Specification Information

Style Number	U.S. Base Prices												
	Fabric Grades:											Leather Grades:	
	COM	6	7	8	9	10	11	12	13	14	COL	C	E



Kart with Arms-Tall

128101J	\$1079	N.A.	N.A.	N.A.	N.A.	N.A.	N.A.	N.A.	N.A.	N.A.	N.A.	N.A.	N.A.
128201SJ	\$1297	\$1294	\$1305	\$1328	\$1355	\$1379	\$1405	\$1428	\$1434	\$1497	\$1370	\$1636	\$1720
128201J	\$1350	\$1349	\$1358	\$1381	\$1408	\$1432	\$1458	\$1481	\$1487	\$1550	\$1424	\$1810	\$1920



Kart with Armless-Tall

128100J	\$1006	N.A.	N.A.	N.A.	N.A.	N.A.	N.A.	N.A.	N.A.	N.A.	N.A.	N.A.	N.A.
128200SJ	\$1219	\$1215	\$1227	\$1250	\$1277	\$1301	\$1327	\$1350	\$1356	\$1419	\$1289	\$1558	\$1642
128200J	\$1271	\$1268	\$1279	\$1302	\$1329	\$1353	\$1379	\$1402	\$1408	\$1471	\$1343	\$1599	\$1680

Guest/ Side/ Stack Seating



For Canadian Pricing
 Multiply U.S. Price by the
 Canadian price factor.
 ► See page 1 for details.

Kathryn

DESIGN STUDIO B DESIGN ORIGIN: UNITED STATES

Tip: Fabrics and leathers will appear loose with comfort wrinkles when upholstered.

Tip: Recommended leathers are Elmosoft Grade C and Elmorustical Grade E.

Tip: Special color match, consult Customer Service.

Tip: For Customer's Own Material or Leather, see necessary requirements, important processing instructions, and ordering information
 ▶ See *Coalesse Surface Materials Reference Guide*.

Standard Includes	Required to Specify
-------------------	---------------------

- | | |
|--|--|
| <ul style="list-style-type: none"> • Frame: European beech hardwood • Mortise and tenon joinery • Upholstery: Multiple densities of laminated polyurethane foam and polyester fiber • Glides: non-adjustable | <ol style="list-style-type: none"> 1 Style number 2 Number of fabrics if contrasting fabric style number is selected 3 Fabric or leather color number for upholstery 4 Wood color number for frame 5 Options, if selected (see below) ▶ See <i>Coalesse Surface Materials Reference Guide</i> . |
|--|--|

Options	U.S. Price	Required to Specify
---------	------------	---------------------

Surface Materials	<ul style="list-style-type: none"> • Contrasting fabric • Contrasting welt 	+\$118 per fabric +\$134	Add suffix K to the style number and select fabric color number. Specify with <i>contrasting welt</i> and select fabric color number.
	Acrylic backer		Specify with <i>acrylic backer</i> .
	<ul style="list-style-type: none"> • Chair with open back • Chair with upholstery 	+\$ 8 +\$ 12	Specify with <i>acrylic backer</i> . ▶ See <i>Coalesse Surface Materials Reference Guide</i> .

Specification Information

Style Number	U.S. Base Prices												Leather Grades:			
	Fabric Grades:												COL	C	E	
	COM	6	7	8	9	10	11	12	13	14						

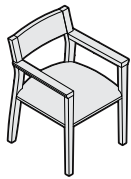

Overall: 22¾"D 22¾"W 32"H
 Inside: 19"D 18½"W 14"H
 Seat: 18"H
 Arm: 26"H

Wood with Open Back

2540-1	\$ 973	\$ 967	\$ 978	\$ 984	\$ 997	\$1010	\$1048	\$1075	\$1111	\$1183	\$1227	\$1504	\$1570
--------	--------	--------	--------	--------	--------	--------	--------	--------	--------	--------	--------	--------	--------

COM/yds = 1, COL/sq ft = 18

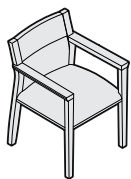

Overall: 22¾"D 22¾"W 32"H
 Inside: 19"D 18½"W 14"H
 Seat: 18"H
 Arm: 26"H

Wood/Upholstered with Panel Back

2542-1	\$1015	\$1018	\$1031	\$1044	\$1062	\$1082	\$1139	\$1202	\$1228	\$1289	\$1261	\$1700	\$1803
--------	--------	--------	--------	--------	--------	--------	--------	--------	--------	--------	--------	--------	--------

COM/yds = 1½, COL/sq ft = 27

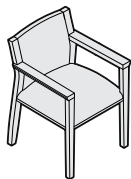

Overall: 22¾"D 22¾"W 32"H
 Inside: 19"D 18½"W 14"H
 Seat: 18"H
 Arm: 26"H

Fully Upholstered Back

2547-1	\$1144	\$1147	\$1165	\$1173	\$1191	\$1211	\$1268	\$1306	\$1366	\$1433	\$1390	\$1829	\$1932
--------	--------	--------	--------	--------	--------	--------	--------	--------	--------	--------	--------	--------	--------

COM/yds = 1½, COL/sq ft = 27

▶ Specification Information, continued on next page

Kathryn

DESIGN STUDIO B DESIGN ORIGIN: UNITED STATES

► Specification Information, continued from previous page

Specification Information

Style Number	U.S. Base Prices											Leather Grades:		
	Fabric Grades:											COL	C	E
	COM	6	7	8	9	10	11	12	13	14				

Fully Upholstered Back with Ribbed Upholstery

2547-1RIBD	\$1180	\$1183	\$1201	\$1209	\$1227	\$1247	\$1304	\$1342	\$1402	\$1469	\$1426	\$1865	\$1968
------------	--------	--------	--------	--------	--------	--------	--------	--------	--------	--------	--------	--------	--------



For Canadian Pricing
 Multiply U.S. Price by the
 Canadian price factor.
 ► See page 1 for details.

Last Minute Stool by Viccarbe

DESIGN PATRICIA URQUILOA DESIGN ORIGIN: 2003 SPAIN

Tip: Fabrics and leathers will appear loose with comfort wrinkles when upholstered.

Tip: For Customer's Own Material or Leather, see necessary requirements, important processing instructions, and ordering information
 ▶ See *Coalesse Surface Materials Reference Guide*.

Standard Includes

- Upholstery for stool: fabric or leather
- Frame: polished trivalent chrome

Required to Specify

- 1 Style number
 - 2 Fabric or leather color number for upholstery
 - 3 Options, if selected (see below)
- ▶ See *Coalesse Surface Materials Reference Guide*.

Options

Surface Materials	Options	U.S. Price	Required to Specify
	Acrylic backer		
	• Backer	+\$6	Specify with acrylic backer. ▶ See <i>Coalesse Surface Materials Reference Guide</i> .

Specification Information

Style Number	U.S. Base Prices														Leather Grades:		
	Fabric Grades:														COL	C	E
	COM	6	7	8	9	10	11	12	13	14							

Medium Stool

COLMS25	\$1125	\$1111	\$1116	\$1124	\$1149	\$1166	\$1185	\$1198	\$1222	\$1255	\$1359	\$1618	\$1672
---------	--------	--------	--------	--------	--------	--------	--------	--------	--------	--------	--------	--------	--------

COM/yds = ¾, COL/sq ft = 17

High Stool

COLMS30	\$1174	\$1160	\$1165	\$1173	\$1198	\$1215	\$1234	\$1247	\$1271	\$1304	\$1408	\$1667	\$1721
---------	--------	--------	--------	--------	--------	--------	--------	--------	--------	--------	--------	--------	--------

COM/yds = ¾, COL/sq ft = 17

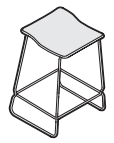

Overall: 17"D 17¼"W 26½"H
 Seat: 25½"H

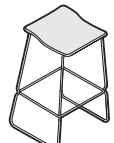

Overall: 17"D 17¼"W 31½"H
 Seat: 30½"H

 **For Canadian Pricing**
 Multiply U.S. Price by the Canadian price factor.
 ▶ See page 1 for details.

Lox Chairs

DESIGN PEARSONLLOYD DESIGN ORIGIN: ENGLAND

Tip: For Customer's Own Material or Leather, see necessary requirements, important processing instructions, and ordering information
 ▶ See *Coalesse Surface Materials Reference Guide*.

Tip: Due to the design and construction techniques of the Lox chairs only certain textiles can be successfully applied, therefore all COM fabrics must be submitted to Coalesse for approval prior to order acceptance.

Tip: Textile patterns for chair with upholstered back will require seams on the inside back of the chair. Limited solid textiles or leathers may also require seams. For specific textile information, visit the fabric database at www.coalesse.com.



Overall: 27"D 27"W 31"H
 Seat: 19"H 18"D



Overall: 27"D 27"W 32"H
 Seat: 19"H 18"D

 **For Canadian Pricing**
 Multiply U.S. Price by the Canadian price factor.
 ▶ See page 1 for details.

Standard Includes	Required to Specify
<ul style="list-style-type: none"> • Shell: plastic • Base: 8046 Polished Aluminum • Seat: fixed upholstery with polyurethane foam base • Back: fixed upholstery with polyurethane foam base, if selected • Swivel mechanism • Glides: plastic 	<ol style="list-style-type: none"> 1 Style number 2 Plastic color number for shell: 6345 Black 6346 White 3 Fabric or leather color number for upholstery 4 Options, if selected (see below) ▶ See <i>Coalesse Surface Materials Reference Guide</i> .

Options	U.S. Price	Required to Specify
Surface Materials • Acrylic backer • Chair with upholstered seat +\$ 6 • Chair with upholstered seat and back +\$10		Specify with acrylic backer. ▶ See <i>Coalesse Surface Materials Reference Guide</i> . Specify with acrylic backer.
Felt Glides • Glides	No cost	Specify with felt glides.
Related Products • Stools		▶ Page 312

Specification Information														
Style Number	U.S. Base Prices												Leather Grades:	
	Fabric Grades:												COL	C
COM	6	7	8	9	10	11	12	13	14					

Chair with Upholstered Seat

COLX100	\$1153	\$1139	\$1144	\$1152	\$1177	\$1194	\$1213	\$1226	\$1250	\$1283	\$1387	\$1235	\$1361
---------	--------	--------	--------	--------	--------	--------	--------	--------	--------	--------	--------	--------	--------

COM/yds = 3/4, COL/sq ft = 13

Chair with Upholstered Seat and Back

COLX110	\$1377	\$1377	\$1385	\$1399	\$1441	\$1469	\$1501	\$1523	\$1562	\$1617	\$1608	\$1713	\$1753
---------	--------	--------	--------	--------	--------	--------	--------	--------	--------	--------	--------	--------	--------

COM/yds = 1/4, COL/sq ft = 22

Lox Stools

DESIGN PEARSONLLOYD DESIGN ORIGIN: ENGLAND

Tip: Due to the design and construction techniques of the Lox stools only certain textiles can be successfully applied, therefore all COM fabrics must be submitted to Coalesse for approval prior to order acceptance.

Tip: For Customer's Own Material or Leather, see necessary requirements, important processing instructions, and ordering information
 ▶ See *Coalesse Surface Materials Reference Guide*.

Standard Includes	Required to Specify
-------------------	---------------------

<ul style="list-style-type: none"> • Shell: plastic • Base: 9251 Brushed Chrome • Seat: upholstered foam • Swivel mechanism • Height-adjustable button under seat • Felt glides 	1 Style number 2 Plastic color number for shell: 6347 Black Gloss 6348 White Gloss 3 Fabric or leather color number for upholstery 4 Options, if selected (see below) ▶ See <i>Coalesse Surface Materials Reference Guide</i> .
---	---

Options	U.S. Price	Required to Specify
---------	------------	---------------------

Surface Materials <ul style="list-style-type: none"> • Acrylic backer • Backer 	+\$6	Specify with acrylic backer. ▶ See <i>Coalesse Surface Materials Reference Guide</i> .
--	------	---

Related Products <ul style="list-style-type: none"> • Chairs 	▶ Page 311
---	------------

Specification Information

Style Number	U.S. Base Prices														Leather Grades:			
	Fabric Grades:														COL	C	E	
COM	6	7	8	9	10	11	12	13	14									

Counter-Height Stool

COLX200	\$1265	\$1251	\$1256	\$1264	\$1289	\$1306	\$1325	\$1338	\$1362	\$1395	\$1499	\$1449	\$1473
---------	--------	--------	--------	--------	--------	--------	--------	--------	--------	--------	--------	--------	--------

COM/yds = 3/4, COL/sq ft = 13



Overall: 17"D 17"W 28"-32"H
 Seat: 26"-30"H

Bar-Height Stool

COLX210	\$1320	\$1306	\$1311	\$1319	\$1344	\$1361	\$1380	\$1393	\$1417	\$1450	\$1554	\$1504	\$1528
---------	--------	--------	--------	--------	--------	--------	--------	--------	--------	--------	--------	--------	--------

COM/yds = 3/4, COL/sq ft = 13

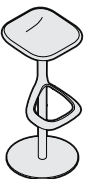

Overall: 17"D 17"W 31"-34"H
 Seat: 29"-33"H



For Canadian Pricing
 Multiply U.S. Price by the Canadian price factor.
 ▶ See page 1 for details.

Rocky Four-Star Nesting Chairs with Arms X10/15

DESIGN 5D STUDIO



Overall: 22¾"D 26"W 36"-41H
 Seat: 17¼"D 19½"W 16"-21"H
 Arms: 24½"-29½"H

Tip: COM must be approved for use. Call Customer Service at 1.800.627.6770.

Tip: Fabrics and leathers will appear loose with comfort wrinkles when upholstered.

Tip: For Customer's Own Material or Leather, see necessary requirements, important processing instructions, and ordering information
 ▶ See *Coalesse Surface Materials Reference Guide*.

Standard Includes	Required to Specify
-------------------	---------------------

- | | |
|--|---|
| <ul style="list-style-type: none"> • Four-prong Rocky nesting base: one piece, solid color glass-filled nylon in graphite only • Hip pivoting springs for lumbar support • Hard, dual-wheel casters for use on carpet: black plastic • Seat and back with molded-in arms: injection-molded solid color polypropylene with textured finish • Upholstered seat or upholstered seat and back, if selected: molded urethane foam over injection-molded polypropylene inner shell(s) • Folding seat with pneumatic self-aligning features • Pneumatic height adjustment • Zero front rise | <ol style="list-style-type: none"> 1 Style number 2 Color number for seat and back: <ul style="list-style-type: none"> - 6315 Graphite - 6316 White 3 Fabric or leather color number for upholstery 4 Options, if selected (see below) ▶ See <i>Coalesse Surface Materials Reference Guide</i> . |
|--|---|

Options	U.S. Price	Required to Specify
---------	------------	---------------------

Surface Materials <ul style="list-style-type: none"> • Acrylic backer • Backer 	+\$ 7	Specify with acrylic backer. ▶ See <i>Coalesse Surface Materials Reference Guide</i> .
Casters <ul style="list-style-type: none"> • Soft, dual-wheel casters for use on hard floors 	+\$39	Specify with soft casters.

Specification Information

Style Number	U.S. Base Price

Non-Upholstered

112101 X10/15 \$749

Specification Information

Style Number	U.S. Base Prices										Leather Grades:		
	Fabric Grades:										COL	C	E
COM	6	7	8	9	10	11	12	13	14				

Upholstered Seat

112201S X10/15	\$ 974	\$ 960	\$1007	\$1033	\$1055	\$1080	\$1102	\$1127	\$1142	\$1172	\$1061	\$1246	\$1314
COM/yds = .9, COL/sq ft = 10													

Upholstered Seat and Back

112201 X10/15	\$1019	\$1008	\$1060	\$1085	\$1112	\$1138	\$1162	\$1190	\$1212	\$1244	\$1110	\$1377	\$1465
COM/yds = .9, COL/sq ft = 14													

Guest/Slider/Stack Seating

 **For Canadian Pricing**
 Multiply U.S. Price by the Canadian price factor.
 ▶ See page 1 for details.

X10/15 = Last order entry
 October 18, 2015

Rocky Five-Star Base Chairs X10/15

DESIGN 5D STUDIO



Overall: 24½"D 26"W 36"-41"H
 Seat: 17¼"D 19½"W 16"-21"H
 Arms: 24½"-29½"H

Tip: COM must be approved for use. Call Customer Service at 1.800.627.6770.

Tip: Chairs do not nest.

Tip: Fabrics and leathers will appear loose with comfort wrinkles when upholstered.

Tip: For Customer's Own Material or Leather, see necessary requirements, important processing instructions, and ordering information
 ▶ See *Coalesse Surface Materials Reference Guide*.

Standard Includes	Required to Specify
<ul style="list-style-type: none"> • Five-prong base, 25" span: one-piece, solid color glass-filled nylon in black only • Hip pivoting springs for lumbar support • Hard, dual-wheel casters for use on carpet: black plastic • Seat and back with molded-in arms: injection-molded solid color polypropylene with textured finish • Upholstered seat or upholstered seat and back, if selected: molded urethane foam over injection-molded polypropylene inner shell(s) • Pneumatic height adjustment • Zero front rise 	1 Style number 2 Color number for seat and back: - 6315 Graphite - 6316 White 3 Fabric or leather color number for upholstery 4 Options, if selected (see below) ▶ See <i>Coalesse Surface Materials Reference Guide</i> .

Options	U.S. Price	Required to Specify
Surface Materials • Acrylic backer • Backer	+\$ 7	Specify with acrylic backer. ▶ See <i>Coalesse Surface Materials Reference Guide</i> .
Casters • Soft, dual-wheel casters for use on hard floors	+\$39	Specify with soft casters.
Related Product • Jury base		▶ Page 316

Specification Information

Style Number	U.S. Base Price

Non-Upholstered

112301 X10/15 \$722

Specification Information

Style Number	U.S. Base Prices											Leather Grades:		
	Fabric Grades:											COL	C	E
	COM	6	7	8	9	10	11	12	13	14				

Upholstered Seat

112401S X10/15 \$943 \$928 \$ 976 \$ 998 \$1024 \$1049 \$1071 \$1096 \$1111 \$1141 \$1029 \$1239 \$1315

COM/yds = .9, COL/sq ft = 10

Upholstered Seat and Back

112401 X10/15 \$989 \$975 \$1022 \$1044 \$1070 \$1095 \$1117 \$1142 \$1157 \$1187 \$1076 \$1347 \$1435

COM/yds = .9, COL/sq ft = 14



For Canadian Pricing
 Multiply U.S. Price by the Canadian price factor.
 ▶ See page 1 for details.

X10/15 = Last order entry
 October 18, 2015

Rocky Five-Star Base Stools X10/15

DESIGN 5D STUDIO



Overall: 24½"D 26"W 36½"-44H
 Seat: 17¼"D 19½"W 21"-28½"H
 Arms: 32-39½"H
 Footring: 10½"-15"H

Tip: COM must be approved for use. Call Customer Service at 1.800.627.6770.

Tip: Chairs do not nest.

Tip: Fabrics and leathers will appear loose with comfort wrinkles when upholstered.

Tip: For Customer's Own Material or Leather, see necessary requirements, important processing instructions, and ordering information
 ▶ See Coalesse Surface Materials Reference Guide.

Standard Includes	Required to Specify
<ul style="list-style-type: none"> • Five-prong base, 25" span: one-piece, solid color glass-filled nylon in black only • Adjustable 20" diameter chrome foot ring on die-cast aluminum hub • Hip pivoting springs for lumbar support • Hard, dual-wheel casters for use on carpet: black plastic • Seat and back with molded-in arms: injection-molded solid color polypropylene with textured finish • Upholstered seat or upholstered seat and back, if selected: molded urethane foam over injection-molded polypropylene inner shell(s) • Pneumatic height adjustment • Zero front rise 	<ol style="list-style-type: none"> 1 Style number 2 Color number for seat and back: <ul style="list-style-type: none"> - 6315 Graphite - 6316 White 3 Fabric or leather color number for upholstery 4 Options, if selected (see below) ▶ See Coalesse Surface Materials Reference Guide.

Options	U.S. Price	Required to Specify
Surface Materials • Acrylic backer • Backer	+\$ 7	Specify with acrylic backer. ▶ See Coalesse Surface Materials Reference Guide.
Casters • Soft, dual-wheel casters for use on hard floors	+\$39	Specify with soft casters.

Specification Information	
Style Number	U.S. Base Price

Non-Upholstered

112301ST X10/15 \$903

Style Number	U.S. Base Prices												Leather Grades:		
	Fabric Grades:												COL	C	E
	COM	6	7	8	9	10	11	12	13	14					

Upholstered Seat

112401SST X10/15 \$1128 \$1119 \$1161 \$1183 \$1209 \$1234 \$1256 \$1281 \$1296 \$1326 \$1219 \$1368 \$1430

COM/yds = .9, COL/sq ft = 10

Upholstered Seat and Back

112401ST X10/15 \$1171 \$1164 \$1204 \$1226 \$1252 \$1277 \$1299 \$1324 \$1339 \$1369 \$1263 \$1472 \$1548

COM/yds = .9, COL/sq ft = 14

Guest/Slide/Stack Seating



For Canadian Pricing
 Multiply U.S. Price by the Canadian price factor.
 ▶ See page 1 for details.

X10/15 = Last order entry
 October 18, 2015

Rocky Jury Bases **10/15**

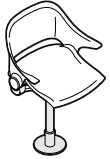

Tip: Rocky seat folds up.

Tip: COM must be approved for use. Call Customer Service at 1.800.627.6770.

Tip: Chairs do not nest.

Tip: Fabrics and leathers will appear loose with comfort wrinkles when upholstered.

Tip: For Customer's Own Material or Leather, see necessary requirements, important processing instructions, and ordering information
▶ See Coalesse Surface Materials Reference Guide.

Tip: Jury bases are standard with pneumatic swivel-tilt return mechanism.

Standard Includes	Required to Specify
<ul style="list-style-type: none"> • Seat height: 17½" (may vary slightly by product) • Jury base with memory return and 180 degree swivel • Base is made up of 2½"-diameter column and 8" base plate: 4134 black only • Hardware for floor attachment not included 	1 Style number 2 Options, if selected (see below)

Options	U.S. Price	Required to Specify
Surface Materials • Acrylic backer • Backer	+\$7	Specify with acrylic backer. ▶ See Coalesse Surface Materials Reference Guide.
Related Products • Rocky		▶ Page 313

Specification Information

Style Number	U.S. Base Prices												Leather Grades:			
	Fabric Grades:												COL	C	E	
	COM	6	7	8	9	10	11	12	13	14						

Rocky

Non-Upholstered Seat																
Style Number	U.S. Price	COM	6	7	8	9	10	11	12	13	14	COL	C	E		
112301J 10/15	\$ 987	N.A.	N.A.	N.A.	N.A.	N.A.	N.A.	N.A.	N.A.	N.A.	N.A.	N.A.	N.A.	N.A.	N.A.	N.A.
Upholstered Seat																
112401SJ 10/15	\$1208	\$1193	\$1241	\$1263	\$1289	\$1314	\$1336	\$1361	\$1376	\$1406	\$1294	\$1504	\$1580			
Upholstered Seat and Back																
112401J 10/15	\$1254	\$1240	\$1287	\$1309	\$1335	\$1360	\$1382	\$1407	\$1422	\$1452	\$1341	\$1612	\$1700			



For Canadian Pricing
 Multiply U.S. Price by the Canadian price factor.
 ▶ See page 1 for details.

10/15 = Last order entry
 October 18, 2015

SW_1 Guest Seating

DESIGN SCOTT WILSON & MINIMAL DESIGN ORIGIN: UNITED STATES

Tip: For Customer's Own Material or Leather, see necessary requirements, important processing instructions, and ordering information
 ▶ See *Coalesse Surface Materials Reference Guide*.

Standard Includes	Required to Specify
<ul style="list-style-type: none"> • Seat: fabric or leather • Back: 3D knit • Base: 8040 Aluminum Matte Polished • Frame: steel tube • Glides: aluminum with non marring plastic insert • Casters, if selected: dual wheel hard casters, black only • Swivel return mechanism on guest chair, if selected • Swivel mechanism on conference chair, if selected 	1 Style number 2 Upholstery color number for seat 3 3D Knit color number for back: 5K20 Stone 5K21 Grey 5K23 Brown 5K24 Black 5K25 Garnet 5K26 Golden 5K27 Royal 5K28 Ivory 5K29 Coal 4 Options, if selected (see below) ▶ See <i>Coalesse Surface Materials Reference Guide</i> .

	Options	U.S. Price	Required to Specify
Surface Materials	• Contrasting fabric	+\$118 per fabric	Add suffix K to the style number and select fabric color number.
	Fire code seating • Fire code seating	+\$231	Specify with <i>fire code seating</i> .
	Acrylic backer • Backer	+\$ 29	Specify with <i>acrylic backer</i> . ▶ See <i>Coalesse Surface Materials Reference Guide</i> .
Mechanism	• Swivel-only mechanism (omit return feature)	No cost	Specify with <i>swivel-only mechanism</i> .
Casters	• Black soft casters	+\$ 22	Specify with <i>soft casters</i> .
	• Hard black casters with polished aluminum body	+\$ 67	Specify with <i>hard polished aluminum casters</i> .
	• Soft black casters with polished aluminum body	+\$101	Specify with <i>soft polished aluminum casters</i> .
Related Products	• Occasional and conference tables		▶ See <i>Coalesse Conferencing and Storage Specification Guide</i> .

Specification Information														
Style Number	U.S. Base Prices											Leather Grades:		
	Fabric Grades:											COL	C	E
	COM	6	7	8	9	10	11	12	13	14				

Guest Swivel Return Chairs with Glides

COW412	\$1939	\$1939	\$1959	\$1992	\$2094	\$2160	\$2236	\$2289	\$2383	\$2514	\$2110	\$2880	\$2991
COM/yds = 3, COL/sq ft = 60													



Overall: 25¼"D 28"W 31½"H
 Seat: 18"H
 Arm: 25¼"H

Conference Swivel Chairs, Height Adjustable with Casters

COW414	\$1939	\$1939	\$1959	\$1992	\$2094	\$2160	\$2236	\$2289	\$2383	\$2514	\$2110	\$2880	\$2991
COM/yds = 3, COL/sq ft = 60													



Overall: 25¼"D 28"W 29½"H-33"H
 Seat: 16¼"H-19¾"H
 Arm: 23½"H-27"H

Guest/Slider/Stack Seating

Switch Guest

DESIGN EOOS DESIGN ORIGIN: GERMANY

Tip: Fabrics and leathers will appear loose with comfort wrinkles when upholstered.

Tip: Recommended leathers are Elmosoft Grade C and Elmorustical Grade E.

Tip: Special color match, consult customer service.

Tip: For Customer's Own Material or Leather, see necessary requirements, important processing instructions, and ordering information
 ▶ See *Coalesse Surface Materials Reference Guide*.

Tip: Pricing based on highest grade textile specified.

Tip: Steel springs allow back to flex to match occupant's back shape.

Tip: Upholstered arm caps fit firmly on arms in coordinating textiles, COM yardage required 1/4 yards, COL square feet required 5/2 (1519 and 1529 only).

Tip: Glide on sled base chair has a felt pad made for hard floors. Movement on carpet is more difficult.

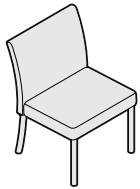

Overall: 22½"D 21½"W 33½"H
 Inside: 18½"D 19¼"W 15½"H
 Seat: 18½"H

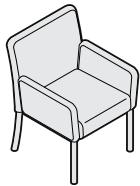

Overall: 22½"D 25¾"W 33½"H
 Inside: 18½"D 19"W 15½"H
 Arm: 26½"H

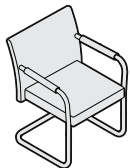

Overall: 23½"D 23¼"W 34¼"H
 Inside: 18"D 17¾"W 15½"H
 Seat: 18½"H
 Arm: 26½"H

Standard Includes	Required to Specify
-------------------	---------------------

- Frame: Constructed of steel tubing and bar stock
- Arms: solid steel rod and bar stock
- Upholstery: Back and seat are molded foam and fiber
- Legs: matte chrome (M) or polished chrome (PC) leg finish

- 1 Style number
 - 2 Number of fabrics if contrasting fabric style number is selected
 - 3 Fabric or leather color number for upholstery on seat
 - 4 Options, if selected (see below)
- ▶ See *Coalesse Surface Materials Reference Guide*.

Options	U.S. Price	Required to Specify
---------	------------	---------------------

Surface Materials	• Contrasting fabric	+\$118 per fabric	Add suffix K to the style number and select fabric color number.
	Acrylic backer		
	• Armless chair and lowback sledbase	+\$ 17	Specify with <i>acrylic backer</i> .
	• Highback sledbase	+\$ 19	Specify with <i>acrylic backer</i> .
	• Arm chair	+\$ 24	Specify with <i>acrylic backer</i> .

▶ See *Coalesse Surface Materials Reference Guide*.

Specification Information

Style Number	U.S. Base Prices												Leather Grades:			
	Fabric Grades:												COL	C	E	
	COM	6	7	8	9	10	11	12	13	14						

Armless Chair

1500M	\$1160	\$1160	\$1170	\$1187	\$1238	\$1271	\$1309	\$1336	\$1383	\$1448	\$1427	\$2129	\$2256
1500PC	\$1203	\$1203	\$1213	\$1230	\$1281	\$1314	\$1352	\$1379	\$1426	\$1491	\$1470	\$2172	\$2300

COM/yds = 1½, COL/sq ft = 33

Arm Chair

1510M	\$1328	\$1328	\$1344	\$1372	\$1457	\$1512	\$1575	\$1620	\$1698	\$1807	\$1565	\$2763	\$2978
1510PC	\$1376	\$1376	\$1392	\$1420	\$1505	\$1560	\$1623	\$1668	\$1746	\$1855	\$1613	\$2798	\$3026

COM/yds = 2½, COL/sq ft = 55

Lowback Sledbase

1519M	\$1359	\$1359	\$1372	\$1394	\$1462	\$1506	\$1557	\$1592	\$1655	\$1742	\$1613	\$2554	\$2734
1519PC	\$1388	\$1388	\$1401	\$1423	\$1491	\$1535	\$1586	\$1621	\$1684	\$1771	\$1642	\$2584	\$2763

COM/yds = 2, COL/sq ft = 44

▶ Specification Information, continued on next page

Coalesse

Switch Guest

DESIGN EOOS DESIGN ORIGIN: GERMANY

► Specification Information, continued from previous page

Specification Information

Style Number	U.S. Base Prices											Leather Grades:		
	Fabric Grades:											COL	C	E
	COM	6	7	8	9	10	11	12	13	14				

Highback Sledbase

1529M	\$1499	\$1499	\$1514	\$1539	\$1615	\$1665	\$1722	\$1762	\$1833	\$1931	\$1750	\$2819	\$3012
1529PC	\$1542	\$1542	\$1557	\$1582	\$1658	\$1708	\$1765	\$1805	\$1876	\$1974	\$1783	\$2857	\$3049

COM/yds = 2¼, COL/sq ft = 50



Overall: 23½"D 24"W 38½"H
 Inside: 17¾"D 17¾"W 15½"H
 Seat: 18½"H
 Arm: 26½"H

Guest/Side/Stack Seating



For Canadian Pricing
 Multiply U.S. Price by the
 Canadian price factor.
 ► See page 1 for details.

Switch Stools without Arms

DESIGN EOOS DESIGN ORIGIN: GERMANY

Tip: Fabrics and leathers will appear loose with comfort wrinkles when upholstered.

Tip: Recommended leathers are Elmosoft Grade C and Elmorustical Grade E.

Tip: Special color match, consult customer service.

Tip: Pricing based on highest grade textile specified.

Tip: For Customer's Own Material or Leather, see necessary requirements, important processing instructions, and ordering information
 ► See *Coalesse Surface Materials Reference Guide*.

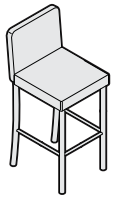

Overall: 19"D 16"W 38"H
 Inside: 15"D 15"W 11¾"H
 Seat: 27¾"H

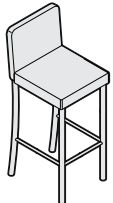

Overall: 19¾"D 16"W 41½"H
 Inside: 15"D 15"W 11¾"H
 Seat: 31¼"H

Standard Includes Required to Specify

- Frame: Constructed of steel tubing and bar stock.
- Upholstery: back foam are molded around the frame components.
- Seat foam is molded with "comfort pockets"
- Legs: matte chrome (M) or polished chrome (PC) leg finish

- 1 Style number
 - 2 Number of fabrics if contrasting fabric style number is selected
 - 3 Fabric or leather color number for upholstery
 - 4 Options, if selected (see below)
- See *Coalesse Surface Materials Reference Guide*.

Options U.S. Price Required to Specify

Surface Materials	Options	U.S. Price	Required to Specify
	• Contrasting fabric	+\$118 per fabric	Add suffix K to the style number and select fabric color number.
	Acrylic backer		
	• Backer	+\$ 10	Specify with <i>acrylic backer</i> . ► See <i>Coalesse Surface Materials Reference Guide</i> .

Specification Information

Style Number	U.S. Base Prices												Leather Grades:			
	Fabric Grades:												COL	C	E	
	COM	6	7	8	9	10	11	12	13	14						

Counter-Height Stool

1404M	\$1260	\$1260	\$1268	\$1282	\$1324	\$1352	\$1384	\$1406	\$1445	\$1500	\$1540	\$2109	\$2218
1404PC	\$1285	\$1285	\$1293	\$1307	\$1349	\$1377	\$1409	\$1431	\$1470	\$1525	\$1565	\$2134	\$2250

COM/yds = 1¼, COL/sq ft = 28

Bar-Height Stool

1405M	\$1297	\$1297	\$1305	\$1319	\$1361	\$1389	\$1421	\$1443	\$1482	\$1537	\$1572	\$2146	\$2255
1405PC	\$1333	\$1333	\$1341	\$1355	\$1397	\$1425	\$1457	\$1479	\$1518	\$1573	\$1613	\$2182	\$2291

COM/yds = 1¼, COL/sq ft = 28



For Canadian Pricing
 Multiply U.S. Price by the Canadian price factor.
 ► See page 1 for details.

Wrapp Side by Viccarbe

DESIGN MARK KRUSIN DESIGN ORIGIN: 2007 SPAIN

Tip: Fabrics and leathers will appear loose with comfort wrinkles when upholstered.

Tip: Stacking is not recommended as the frame will dent the foam on the seat on which it is being stacked.

Tip: For Customer's Own Material or Leather, see necessary requirements, important processing instructions, and ordering information
 ▶ See *Coalesse Surface Materials Reference Guide*.

Standard Includes	Required to Specify
-------------------	---------------------

- Upholstery for chair: fabric or leather
- Frame: polished trivalent chrome

- 1 Style number
 - 2 Number of fabrics if contrasting fabric style number is selected
 - 3 Fabric or leather color number for upholstery
 - 4 Options, if selected (see below)
- ▶ See *Coalesse Surface Materials Reference Guide*.

Options	U.S. Price	Required to Specify
---------	------------	---------------------

Surface Materials

- Contrasting fabric

+\$118 per fabric

Add suffix K to the style number and select fabric color number.

- Acrylic backer
- Backer

+\$ 12

Specify with *acrylic backer*.
 ▶ See *Coalesse Surface Materials Reference Guide*.

Specification Information

Style Number	U.S. Base Prices												Leather Grades:		
	Fabric Grades:												COL	C	E
	COM	6	7	8	9	10	11	12	13	14					

Four Leg Chair

COWRP4LEG	\$1221	\$1221	\$1231	\$1248	\$1299	\$1332	\$1370	\$1397	\$1444	\$1509	\$1444	\$2014	\$2123
-----------	--------	--------	--------	--------	--------	--------	--------	--------	--------	--------	--------	--------	--------

COM/yds = 1½, COL/sq ft = 33

Sled Base Chair

COWRPSLD	\$1265	\$1265	\$1275	\$1292	\$1343	\$1376	\$1414	\$1441	\$1488	\$1553	\$1488	\$2058	\$2167
----------	--------	--------	--------	--------	--------	--------	--------	--------	--------	--------	--------	--------	--------

COM/yds = 1½, COL/sq ft = 33



Overall: 21"D 25¼"W 29½"H
 Inside: 16"D 19½"W 17½"H
 Seat: 17½"H



Overall: 20¼"D 24½"W 28¾"H
 Inside: 16"D 19½"W 17½"H
 Seat: 17½"H



For Canadian Pricing
 Multiply U.S. Price by the Canadian price factor.
 ▶ See page 1 for details.

X-Stack Four-Leg Stacking Chairs **X10/15**

DESIGN JOHN KALOUSTIAN

 = Available in Rapid10.

Tip: Stacks four chairs with arms on the floor.

Tip: Stacks five chairs without arms on the floor.

Tip: Stacks three chairs with tablets on the floor.

Tip: Chairs stack with cup holder.

Tip: Add 2 2/5" to overall depth and height for each additional chair that is stacked.

Tip: All tablets are specified from the seated position.

Tip: Please contact customer service for soft caster option.

Standard Includes	Required to Specify
-------------------	---------------------

- Frame: tubular 14-gauge steel front legs and shell supports and tubular 17-gauge double lined steel back legs
- Glides, if selected: black glass-filled nylon
- Casters, if selected: hard, dual-wheel for use on carpet: black
- Shell: patented co-molded black glass-filled nylon and pliable thermoplastic polyurethane (TPU) with textured finishes
- Arms, if selected: tubular steel with arm caps in black glass-filled nylon
- Stacking bumpers under shell, a cushion and spacer for stacking: black TPU
- Cal 133 compliant: no upcharge.
- Tablet: black phenolic

- 1 Style number
- 2 Powder coat color number for frame:
 - 4142 Platinum Gloss
 - 4144 Black Gloss
- 3 TPU color number for seat and back:
 - 6328 Cloud (light grey)
 - 6329 Shadow (dark grey)
 - 6330 Sea (blue)
 - 6331 Surf (green)
- 4 Options, if selected (see below)

Options	U.S. Price	Required to Specify
---------	------------	---------------------

Cup Holder	• 2 3/4"W x 2"D, rotates around arm support to accommodate user preference: black glass-filled nylon	+\$ 19	Specify with cup holder.
Storage Rack	• Storage rack	+\$163	Specify with storage rack.
Casters	• Soft, dual-wheel casters for use on hard floors	+\$ 42	Specify with soft casters.

Specification Information

Style Number	U.S. Base Price
--------------	-----------------



Overall: 24"D x 21"W x 33"H
 Inside: 17 3/4"D x 18 1/2"W x 16 1/2"H
 Seat: 17 1/4"H

Non-Upholstered without Arms

On Glides

 X1000 **X10/15** \$399

On Casters

 X1000C **X10/15** \$399



Overall: 24"D x 26"W x 33"H
 Inside: 17 3/4"D x 18 1/2"W x 16 1/2"H
 Seat: 17 1/4"H
 Arms: 26 3/4"H

Non-Upholstered with Arms

On Glides

X2200 **X10/15** \$534

On Casters

X2200C **X10/15** \$534

► Specification Information, continued on next page



For Canadian Pricing
 Multiply U.S. Price by the Canadian price factor.
 ► See page 1 for details.

X10/15 = Last order entry
 October 18, 2015

X-Stack Four-Leg Stacking Chairs

DESIGN JOHN KALOUSTIAN

► Specification Information, continued from previous page

Specification Information

Style	U.S.
Number	Base
	Price



Overall: 28¾"D x 25"W x 33"H
 Inside: 17¾"D x 18½"W x 16½"H
 Tablet: 12"D x 16"W x 29½"H
 Seat: 17¼"H

Non-Upholstered without Arm, Right Tablet

On Glides

X1010 **10/15** \$612

On Casters

X1010C **10/15** \$612



Overall: 28¾"D x 29"W x 33"H
 Inside: 17¾"D x 18½"W x 16½"H
 Tablet: 12"D x 16"W x 29½"H
 Seat: 17¼"H

Non-Upholstered with Arm, Right Tablet

On Glides

X2210 **10/15** \$678

On Casters

X2210C **10/15** \$678



Overall: 28¾"D x 25"W x 33"H
 Inside: 17¾"D x 18½"W x 16½"H
 Tablet: 12"D x 16"W x 29½"H
 Seat: 17¼"H

Non-Upholstered without Arm, Left Tablet

On Glides

X1010L **10/15** \$612

On Casters

X1010CL **10/15** \$612



Overall: 28¾"D x 29"W x 33"H
 Inside: 17¾"D x 18½"W x 16½"H
 Tablet: 12"D x 16"W x 29½"H
 Seat: 17¼"H

Non-Upholstered with Arm, Left Tablet

On Glides

X2210L **10/15** \$678

On Casters

X2210CL **10/15** \$678

 **For Canadian Pricing**
 Multiply U.S. Price by the
 Canadian price factor.
 ► See page 1 for details.

10/15 = Last order entry
 October 18, 2015

Executive Seating

Bindu	326
Chord	328
La Costa Couture	330
La Costa Sport	332
Executive Chair Bases	334
Adjustment Feature Definitions	335
Jury Bases	
Kart	306
Rocky	316

Bindu

DESIGN BRIAN KANE DESIGN ORIGIN: 2009 UNITED STATES

Tip: Fabrics and leathers will appear loose with comfort wrinkles when upholstered.

Tip: For Customer's Own Material or Leather, see necessary requirements, important processing instructions, and ordering information
 ▶ See *Coalesse Surface Materials Reference Guide*.

Tip: Craft in upholstery cautions the use of stripes and patterns on Bindu. Please use fabric database when specifying.

Tip: For fabric with a large pattern and a specific pattern location is desired, contact Customer Service.

Standard Includes	Required to Specify
-------------------	---------------------

- Bent plywood frame
- Chair: fabric
- Molded polypropylene foam
- Frame (Guest/Side): 4144 Black Gloss
- Base (Executive): 6205 Black Resin
- Dual wheel hard casters, executive
- Glides: non-marring polymer, guest
- Back tilt lock

- 1 Style number
 - 2 Fabric or leather color number for upholstery
 - 3 Options, if selected (see below)
- ▶ See *Coalesse Surface Materials Reference Guide*.

Options	U.S. Price	Required to Specify
---------	------------	---------------------

Surface Materials	Acrylic backer		
	• Low back and mid back chair	+\$ 29	Specify with acrylic backer.
	• High back chair	+\$ 31	Specify with acrylic backer. ▶ See <i>Coalesse Surface Materials Reference Guide</i> .
Base	• Polished aluminum (available on CO300 & CO400)	+\$147	Specify with polished aluminum.
	• Polished trivalent chrome (available on CO200G & CO300G)	+\$147	Specify with trivalent chrome.
Casters	• Soft casters (available on CO300 & CO400)	+\$ 23	Specify with soft casters.

Specification Information

Style Number	U.S. Base Prices												Leather Grades:			
	Fabric Grades:												COL	C	E	
	COM	6	7	8	9	10	11	12	13	14						

Mid Back Executive/Conference Chair

CO300	\$1451	\$1451	\$1471	\$1504	\$1606	\$1672	\$1748	\$1801	\$1895	\$2026	\$1622	\$2815	\$3034
-------	--------	--------	--------	--------	--------	--------	--------	--------	--------	--------	--------	--------	--------

COM/yds = 3, COL/sq ft = 66



Overall: 25"D 25"W 35½"-40¼"H
 Inside: 18¾"D 18½"-19½"W 21"H
 Seat: 16"-20½"H
 Arm: 24¼"-29"H

High Back Executive/Conference Chair

CO400	\$1693	\$1693	\$1715	\$1751	\$1861	\$1933	\$2015	\$2073	\$2175	\$2317	\$1856	\$3152	\$3390
-------	--------	--------	--------	--------	--------	--------	--------	--------	--------	--------	--------	--------	--------

COM/yds = 3.25, COL/sq ft = 72

▶ Specification Information, continued on next page



Overall: 25"D 25"W 45½"-50¼"H
 Inside: 18¾"D 18½"-19½"W 31"H
 Seat: 16"-20½"H
 Arm: 24¼"-29"H



For Canadian Pricing
 Multiply U.S. Price by the Canadian price factor.
 ▶ See page 1 for details.

Bindu

DESIGN BRIAN KANE DESIGN ORIGIN: 2009 UNITED STATES

► Specification Information, continued from previous page

Specification Information

Style Number	U.S. Base Prices											Leather Grades:		
	Fabric Grades:											COL	C	E
	COM	6	7	8	9	10	11	12	13	14				

Low Back Guest/Side Chair

CO200G	\$1213	\$1213	\$1233	\$1266	\$1368	\$1434	\$1510	\$1563	\$1657	\$1788	\$1384	\$2577	\$2796
--------	--------	--------	--------	--------	--------	--------	--------	--------	--------	--------	--------	--------	--------

COM/yds = 3, COL/sq ft = 66



Overall: 25"D 25"W 33¼"H
 Inside: 18¾"D 18½"-19½"W 15"H
 Seat: 17¾"H
 Arm: 26¼"H

Mid Back Guest/Side Chair

CO300G	\$1393	\$1393	\$1413	\$1446	\$1548	\$1614	\$1690	\$1743	\$1837	\$1968	\$1564	\$2757	\$2976
--------	--------	--------	--------	--------	--------	--------	--------	--------	--------	--------	--------	--------	--------

COM/yds = 3, COL/sq ft = 66



Overall: 25"D 25"W 37¾"H
 Inside: 18¾"D 18½"-19½"W 21"H
 Seat: 17¾"H
 Arm: 26¼"H



For Canadian Pricing
 Multiply U.S. Price by the
 Canadian price factor.
 ► See page 1 for details.

Chord

DESIGN MICHAEL SHIELDS DESIGN ORIGIN: UNITED STATES

Tip: Fabrics and leathers will appear loose with comfort wrinkles when upholstered.

Tip: For Customer's Own Material or Leather, see necessary requirements, important processing instructions, and ordering information
 ▶ See *Coalesse Surface Materials Reference Guide*.

Tip: Arm is cast from 100% recycled material then hand buffed to a mirror finish. Arm caps are molded in black.

Tip: List price based on highest fabric grade usage.

Tip: Contrasting option available only on 798-P and 796-P.

Tip: Chord does not pass CAL 133 with urethane arms. To choose the CAL 133 option polished aluminum arms must be selected.

Standard Includes	Required to Specify
<ul style="list-style-type: none"> • Frame: hardwood plywood assembled into unibody structures utilizing interlocking finger joinery • Cushioning: <ul style="list-style-type: none"> - back: multiple laminations of high-density polyurethane foam over an elastic sheet suspension system for lumbar support - seat: closed cell, contour molded urethane foam • Upholstery: <ul style="list-style-type: none"> - seams are double needle stitched with seam binding for extended durability - unique wrap around welt detail and is cut from the same fabric as specified on chair • Arms: resilient self-skinned urethane molded around carbon steel armature, black or aluminum arm with urethane cap, if selected • Chair controls: tilt-swivel with tilt tension, pneumatic height adjustment, and tilt lockout • Bases: five star black resin • Casters: black hooded dual wheel 	<ol style="list-style-type: none"> 1 Style number 2 Number of fabrics if contrasting fabric style number is selected 3 Fabric or leather color number for upholstery on seat and back 4 Options, if selected (see below) ▶ See <i>Coalesse Surface Materials Reference Guide</i> .

Options	U.S. Price	Required to Specify
Surface Materials <ul style="list-style-type: none"> • Welt detail <ul style="list-style-type: none"> • Contrasting fabric welt +\$ 62 • Contrasting leather welt +\$ 91 • Contrasting fabric +\$118 per fabric 		Specify with <i>contrasting fabric welt</i> and select fabric color number. Specify with <i>contrasting leather welt</i> and select fabric color number. Add suffix K to the style number and select fabric color number.
<ul style="list-style-type: none"> • Acrylic backer <ul style="list-style-type: none"> • Conference, midback, and high back large chairs +\$ 19 • High back large chair +\$ 22 • Midback with pillow chairs +\$ 29 • High back with pillow chairs +\$ 31 		Specify with <i>acrylic backer</i> . Specify with <i>acrylic backer</i> . Specify with <i>acrylic backer</i> . Specify with <i>acrylic backer</i> . ▶ See <i>Coalesse Surface Materials Reference Guide</i> .
Base <ul style="list-style-type: none"> • Polished aluminum with black, hooded dual wheel casters +\$ 62 		Specify with <i>polished aluminum base</i> .
Castors <ul style="list-style-type: none"> • Soft wheel casters +\$ 48 		Specify with <i>soft casters</i> .
Control <ul style="list-style-type: none"> • Knee-tilt with pneumatic height adjustment and tilt lockout +\$153 		Specify with <i>knee-tilt</i> .

Specification Information														
Style Number	U.S. Base Prices												Leather Grades:	
	COM	6	7	8	9	10	11	12	13	14	COL	C	E	

Conference Narrow/Narrow with Urethane Arms													
795	\$1109	\$1107	\$1128	\$1148	\$1171	\$1200	\$1274	\$1331	\$1396	\$1525	\$1340	\$2055	\$2190
COM/yds = 2, COL/sq ft = 40													

Conference Narrow/Narrow with Aluminum Arms													
795AU	\$1475	\$1473	\$1494	\$1514	\$1537	\$1566	\$1640	\$1697	\$1762	\$1891	\$1706	\$2421	\$2556

▶ Specification Information, continued on next page



Overall: 26½"D 26½"W 36"-39"H
 Inside: 18"D 20"W 18½"H
 Seat: 18½"-21½"H
 Arm: 25¾"-28¾"H

Chord

DESIGN MICHAEL SHIELDS DESIGN ORIGIN: UNITED STATES

► Specification Information, continued from previous page

Specification Information

Style Number	U.S. Base Prices											Leather Grades:		
	Fabric Grades:											COL	C	E
	COM	6	7	8	9	10	11	12	13	14				



Overall: 26½"D 26½"W 38"-41"H
 Inside: 19"D 21½"W 21½"H
 Seat: 21½"H
 Arm: 25¾"-28¾"H

Midback with Urethane Arms

796	\$1242	\$1235	\$1256	\$1272	\$1297	\$1330	\$1407	\$1457	\$1529	\$1675	\$1473	\$2188	\$2316
-----	--------	--------	--------	--------	--------	--------	--------	--------	--------	--------	--------	--------	--------

COM/yds = 2, COL/sq ft = 40

Midback with Aluminum Arms

796AU	\$1608	\$1601	\$1622	\$1638	\$1663	\$1696	\$1773	\$1823	\$1895	\$2041	\$1839	\$2554	\$2682
-------	--------	--------	--------	--------	--------	--------	--------	--------	--------	--------	--------	--------	--------



Overall: 26½"D 26½"W 38"-41"H
 Inside: 18½"D 21½"W 19"H
 Seat: 19"-22"H
 Arm: 25¾"-28¾"H

Midback/Pillow Upholstery with Urethane Arms

796-P	\$1536	\$1531	\$1556	\$1578	\$1629	\$1666	\$1786	\$1863	\$1966	\$2139	\$1732	\$2829	\$3029
-------	--------	--------	--------	--------	--------	--------	--------	--------	--------	--------	--------	--------	--------

COM/yds = 3, COL/sq ft = 60

Midback/Pillow Upholstery with Aluminum Arms

796-PAU	\$1902	\$1897	\$1922	\$1944	\$1995	\$2032	\$2152	\$2229	\$2332	\$2505	\$2098	\$3195	\$3395
---------	--------	--------	--------	--------	--------	--------	--------	--------	--------	--------	--------	--------	--------



Overall: 26½"D 26½"W 44½"-47½"H
 Inside: 18"D 20"W 18½"H
 Seat: 18½"-21½"H
 Arm: 25¾"-28¾"H

High Back Narrow/Narrow with Urethane Arms

797	\$1539	\$1537	\$1563	\$1578	\$1601	\$1627	\$1704	\$1761	\$1826	\$2020	\$1770	\$2328	\$2461
-----	--------	--------	--------	--------	--------	--------	--------	--------	--------	--------	--------	--------	--------

COM/yds = 2, COL/sq ft = 44

High Back Narrow/Narrow with Aluminum Arms

797AU	\$1905	\$1903	\$1929	\$1944	\$1967	\$1993	\$2070	\$2127	\$2192	\$2386	\$2136	\$2694	\$2827
-------	--------	--------	--------	--------	--------	--------	--------	--------	--------	--------	--------	--------	--------



Overall: 26½"D 26½"W 47"-50"H
 Inside: 19"D 21½"W 18½"H
 Seat: 18½"-21½"H
 Arm: 25¾"-28¾"H

High Back/Large Scale with Urethane Arms

798	\$1560	\$1550	\$1571	\$1591	\$1614	\$1640	\$1717	\$1774	\$1839	\$2036	\$1790	\$2336	\$2469
-----	--------	--------	--------	--------	--------	--------	--------	--------	--------	--------	--------	--------	--------

COM/yds = 2¼, COL/sq ft = 44

High Back/Large Scale with Aluminum Arms

798AU	\$1926	\$1916	\$1937	\$1957	\$1980	\$2006	\$2083	\$2140	\$2205	\$2402	\$2156	\$2702	\$2835
-------	--------	--------	--------	--------	--------	--------	--------	--------	--------	--------	--------	--------	--------



Overall: 26½"D 26½"W 47"-50"H
 Inside: 19"D 21½"W 19"H
 Seat: 19"-22"H
 Arm: 26¾"-28¾"H

High Back/Large Scale with Pillow Upholstery with Urethane Arms

798-P	\$1670	\$1659	\$1685	\$1712	\$1763	\$1800	\$1914	\$1997	\$2100	\$2293	\$1866	\$2957	\$3156
-------	--------	--------	--------	--------	--------	--------	--------	--------	--------	--------	--------	--------	--------

COM/yds = 3, COL/sq ft = 66

High Back/Large Scale with Pillow Upholstery with Aluminum Arms

798-PAU	\$2036	\$2025	\$2051	\$2078	\$2129	\$2166	\$2280	\$2363	\$2466	\$2659	\$2232	\$3323	\$3522
---------	--------	--------	--------	--------	--------	--------	--------	--------	--------	--------	--------	--------	--------



Tip: Closed arm version is not available.

Tip: Due to the design and construction techniques of the La Costa Couture, only certain textiles can be successfully applied. Therefore all COM fabrics must be submitted to Coalesse for approval prior to order acceptance. A pre-approved fabric list is available, contact Customer Service.

Tip: Your specification is not complete until suffixes have been chosen.

Tip: Fabrics and leathers will appear loose with comfort wrinkles when upholstered.

Tip: For Customer's Own Material or Leather, see necessary requirements, important processing instructions, and ordering information
 ► See Coalesse Surface Materials Reference Guide.

Standard Includes	Required to Specify
<ul style="list-style-type: none"> • Frame: internal frame is constructed of a contour molded hardwood veneer shell which provides proper support of the lumbar region of the back • Upholstery: multiple laminations of high density polyurethane and polyester fiber • Arms: <ul style="list-style-type: none"> - wood: laminated maple hardwood veneers with black self-skinned urethane arm caps - self-skinned urethane arms are molded with high carbon steel substructures - arms and arm caps: black • Chair control: tilt swivel control with tilt tension adjustment available with: <ul style="list-style-type: none"> S = Standard - mechanical height adjustment, if selected P = Pneumatic - gas assisted height adjustment, if selected • Bases: <ul style="list-style-type: none"> S = S base - five arm polished aluminum with black column, black hood dual wheel casters standard W = Wood base - five arm solid maple with aluminum understructure, black column, black hood dual wheel casters, if selected 	<ol style="list-style-type: none"> 1 Style number 2 Fabric or leather color number for upholstery on seat and back 3 Powder coat or wood color number for base, if selected 4 Options, if selected (see below) ► See <i>Coalesse Surface Materials Reference Guide</i> .

	Options	U.S. Price	Required to Specify
Surface Materials	Acrylic backer <ul style="list-style-type: none"> • Conference and mid back chairs • High back chairs 	+\$ 31 +\$ 35	Specify with <i>acrylic backer</i> . Specify with <i>acrylic backer</i> . ► See <i>Coalesse Surface Materials Reference Guide</i> .
Arms	<ul style="list-style-type: none"> • Wood arms with black urethane caps • Upholstered arm caps on wood, polished aluminum, or self-skinned urethane arms (5 sq. ft. or 1/2 yard) • Polished aluminum open arms with black urethane caps 	+\$183 +\$ 60 +\$485	Specify with <i>wood arms with black urethane caps</i> . Specify with <i>upholstered arm caps</i> . Specify with <i>polished aluminum open arms black urethane caps</i> .
Base	<ul style="list-style-type: none"> • Polished aluminum base • Black powder coat with black column and casters • Resin base 	No cost No cost -\$ 30	Specify with <i>polished aluminum base</i> . Specify with <i>black powder coat</i> . Specify with <i>resin base</i> .
Control	<ul style="list-style-type: none"> • Knee-tilt with pneumatic height adjustment (available on P version style number only) 	+\$135	Specify with <i>knee-tilt</i> .
Caster	<ul style="list-style-type: none"> • Soft wheel casters 	+\$ 48	Specify with <i>soft casters</i> .



For Canadian Pricing
 Multiply U.S. Price by the Canadian price factor.
 ► See page 1 for details.

X10/15 = Last order entry
 October 18, 2015

Specification Information

Style Number	U.S. Base Prices											Leather Grades:	
	Fabric Grades:											COL	C
	COM	6	7	8	9	10	11	12	13	14			



Overall: 24¼"D 23¾"W 33"H
 Inside: 18½"D 19"W 14½"H
 Seat: 18½"-22"H
 Arm: 24¼"-27¾"H

Conference with Open Urethane Arm

996SS 10/15	\$1818	\$1853	\$1879	\$1898	\$2011	\$2146	\$2261	\$2452	\$2576	\$2746	\$2008	\$2965
996PS 10/15	\$1888	\$1937	\$1954	\$1974	\$2088	\$2234	\$2338	\$2528	\$2722	\$2913	\$2090	\$3040
996SW 10/15	\$2041	\$2082	\$2107	\$2127	\$2241	\$2376	\$2484	\$2678	\$2780	\$2968	\$2231	\$3183
996PW 10/15	\$2119	\$2160	\$2180	\$2205	\$2312	\$2460	\$2569	\$2756	\$2858	\$3046	\$2321	\$3261

COM/yds = 3, COL/sq ft = 54



Overall: 24¼"D 25¾"W 36"H
 Inside: 18½"D 21"W 17½"H
 Seat: 18½"-22"H
 Arm: 24¼"-27¾"H

Mid Back with Open Urethane Arm

997SS 10/15	\$1850	\$1891	\$1911	\$1936	\$2043	\$2178	\$2293	\$2474	\$2662	\$2852	\$2052	\$2992
997PS 10/15	\$1939	\$1966	\$2000	\$2019	\$2127	\$2267	\$2373	\$2563	\$2751	\$2941	\$2129	\$3066
997SW 10/15	\$2080	\$2121	\$2141	\$2160	\$2273	\$2408	\$2523	\$2704	\$2892	\$3082	\$2282	\$3184
997PW 10/15	\$2164	\$2191	\$2230	\$2250	\$2352	\$2492	\$2598	\$2788	\$2976	\$3166	\$2354	\$3298

COM/yds = 3¼, COL/sq ft = 59



Overall: 24¼"D 25¾"W 41"H
 Inside: 18½"D 21"W 22½"H
 Seat: 18½"-22"H
 Arm: 24¼"-27¾"H

High Back with Open Urethane Arm

998SS 10/15	\$2337	\$2386	\$2398	\$2423	\$2543	\$2678	\$2771	\$2961	\$3149	\$3339	\$2539	\$3471
998PS 10/15	\$2424	\$2465	\$2479	\$2496	\$2617	\$2752	\$2858	\$3048	\$3236	\$3426	\$2619	\$3534
998SW 10/15	\$2572	\$2607	\$2621	\$2644	\$2765	\$2900	\$3001	\$3189	\$3375	\$3563	\$2767	\$3689
998PW 10/15	\$2647	\$2696	\$2708	\$2727	\$2847	\$2982	\$3081	\$3271	\$3459	\$3649	\$2849	\$3757

COM/yds = 3¾, COL/sq ft = 68



For Canadian Pricing
 Multiply U.S. Price by the
 Canadian price factor.
 ▶ See page 1 for details.

10/15 = Last order entry
 October 18, 2015



Tip: Recommended leathers are Elmosoft Grade C and Elmorustical Grade E.

Tip: Special color match, consult customer service.

Tip: For Customer's Own Material or Leather, see necessary requirements, important processing instructions, and ordering information
▶ See Coalesse Surface Materials Reference Guide.

Tip: The first alpha character in the style number indicates the chair control and the second indicates the type of base.

Tip: Your specification is not complete until suffixes have been chosen.

Tip: Fabrics and leathers will appear loose with comfort wrinkles when upholstered.

Standard Includes **Required to Specify**

- Frame: Internal frame is constructed of a contour molded hardwood veneer shell which provides proper support of the lumbar region of the back
- Sled base models utilize the same molded veneer shell and are attached to a powder coated steel tubular base: black
- Upholstery: multiple laminations of high density polyurethane and polyester fiber
- Arms: open arms are constructed of resilient self-skinned urethane molded around a high carbon steel substructure: black
- Chair control: tilt swivel control with tilt tension adjustment available with:
S = Standard - mechanical height adjustment, if selected
P = Pneumatic - gas assisted height adjustment, if selected
- Bases:
S = S base - five arm polished aluminum with black column, black hood dual wheel casters standard
W = Wood base - five arm solid maple with aluminum understructure, black column, black hood dual wheel casters, if selected

- 1 Style number
 - 2 Fabric or leather color number for upholstery on seat and back
 - 3 Powder coat or wood color number for base, if selected
 - 4 Options, if selected (see below)
- ▶ See Coalesse Surface Materials Reference Guide.

Options **Required to Specify**

Options	U.S. Price	Required to Specify
Surface Materials <ul style="list-style-type: none"> • Acrylic backer • Sled base and conference chairs +\$ 12 • Mid back chairs +\$ 15 • High back chairs +\$ 19 		Specify with acrylic backer. Specify with acrylic backer. Specify with acrylic backer. ▶ See Coalesse Surface Materials Reference Guide.
Arms <ul style="list-style-type: none"> • Wood arms with black urethane caps +\$183 • Upholstered arm caps on wood, polished aluminum, or self-skinned urethane arms (5 sq. ft. or 1/2 yard) +\$ 60 • Polished aluminum open arms with black urethane caps +\$485 		Specify with wood arms with black urethane caps. Specify with upholstered arm caps. Specify with polished aluminum open arms black urethane caps.
Base <ul style="list-style-type: none"> • Polished aluminum base No cost • Black powder coat with black column and casters No cost • Resin base -\$ 30 		Specify with polished aluminum base. Specify with black powder coat. Specify with resin base.
Control <ul style="list-style-type: none"> • Knee-tilt with pneumatic height adjustment (available on P version style number only) +\$135 		Specify with knee-tilt.
Caster <ul style="list-style-type: none"> • Soft wheel casters +\$ 48 		Specify with soft casters.



For Canadian Pricing
Multiply U.S. Price by the Canadian price factor.
▶ See page 1 for details.

X10/15 = Last order entry
October 18, 2015

Specification Information

Style Number	U.S. Base Prices										Leather Grades:		
	Fabric Grades:										COL	C	E
	COM	6	7	8	9	10	11	12	13	14			

Sled Base with Open Urethane Arm

990 X10/15	\$1338	\$1332	\$1362	\$1388	\$1528	\$1584	\$1612	\$1699	\$1716	\$1746	\$1643	\$2134	\$2473
-------------------	--------	--------	--------	--------	--------	--------	--------	--------	--------	--------	--------	--------	--------

COM/yds = 1½, COL/sq ft = 27



Overall: 24¼"D 23¾"W 35½"H
 Inside: 17¼"D 19"W 16"H
 Seat: 19½"H
 Arm: 26¾"H

Conference with Open Urethane Arm

991SS X10/15	\$1357	\$1356	\$1381	\$1418	\$1553	\$1603	\$1647	\$1718	\$1741	\$1771	\$1669	\$2159	\$2492
991PS X10/15	\$1440	\$1434	\$1458	\$1495	\$1630	\$1686	\$1720	\$1806	\$1824	\$1860	\$1745	\$2236	\$2562
991SW X10/15	\$1593	\$1578	\$1604	\$1648	\$1783	\$1833	\$1873	\$1948	\$1967	\$2023	\$1893	\$2384	\$2710
991PW X10/15	\$1671	\$1665	\$1689	\$1721	\$1853	\$1911	\$1951	\$2032	\$2055	\$2118	\$1976	\$2455	\$2788

COM/yds = 1½, COL/sq ft = 27



Overall: 24¼"D 23¾"W 33"H
 Inside: 17¼"D 19"W 16"H
 Seat: 17"-20½"H
 Arm: 24¼"-27¾"H

Mid Back with Open Urethane Arm

992SS X10/15	\$1403	\$1388	\$1427	\$1453	\$1585	\$1656	\$1683	\$1764	\$1781	\$1817	\$1708	\$2205	\$2533
992PS X10/15	\$1479	\$1464	\$1503	\$1534	\$1669	\$1725	\$1764	\$1840	\$1863	\$1904	\$1779	\$2270	\$2609
992SW X10/15	\$1624	\$1609	\$1653	\$1679	\$1814	\$1877	\$1904	\$1990	\$2002	\$2063	\$1929	\$2420	\$2754
992PW X10/15	\$1708	\$1693	\$1726	\$1763	\$1890	\$1954	\$1993	\$2069	\$2092	\$2158	\$2008	\$2492	\$2825

COM/yds = 1¾, COL/sq ft = 32



Overall: 24¼"D 25¾"W 36"H
 Inside: 17¼"D 21"W 19"H
 Seat: 17"-20½"H
 Arm: 24¼"-27¾"H

High Back with Open Urethane Arm

993SS X10/15	\$1720	\$1714	\$1738	\$1781	\$1902	\$1966	\$2005	\$2081	\$2125	\$2187	\$2168	\$2504	\$2837
993PS X10/15	\$1803	\$1802	\$1827	\$1853	\$1993	\$2049	\$2083	\$2158	\$2208	\$2280	\$2245	\$2575	\$2915
993SW X10/15	\$1946	\$1945	\$1970	\$2007	\$2136	\$2192	\$2236	\$2307	\$2355	\$2441	\$2394	\$2723	\$3063
993PW X10/15	\$2033	\$2027	\$2051	\$2083	\$2223	\$2279	\$2307	\$2388	\$2435	\$2530	\$2475	\$2799	\$3131

COM/yds = 2, COL/sq ft = 36



Overall: 24¼"D 25¾"W 41"H
 Inside: 17¼"D 21"W 24"H
 Seat: 17"-20½"H
 Arm: 24¼"-27¾"H

 **For Canadian Pricing**
 Multiply U.S. Price by the
 Canadian price factor.
 ▶ See page 1 for details.

X10/15 = Last order entry
 October 18, 2015

Executive Chair Bases

Refer to chair style to determine available base options, wood or metal finishes.



S-Base (Polished Aluminum)



S-Base (Black Powder coat)



Wood Base



Swivel Base with Glides



Resin (Black only) Optional on most models



Chord Base: Five-arm black resin base standard.



Chord optional polished aluminum base.

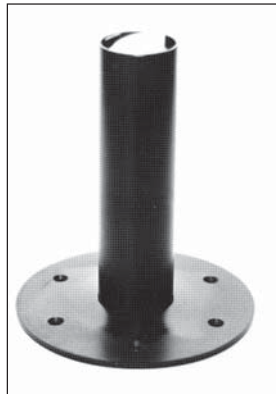

*Jury bases are available for Kart and Rocky. All other requests should be submitted through Specials.

Adjustment Feature Definitions

<p>Active mechanism (AM+) allows the seat and back angle to be adjusted independently of each other. The seat can be locked at various angles, and the back can free tilt with adjustable tension or lock in four positions.</p> <p>Arms, height adjustable allow the user to independently move each arm up and down.</p> <p>Arms, width-adjustable allows the arm rests to be adjusted in and out.</p> <p>Arms, folding allows the user to independently fold each arm up or down for total freedom of leg movement and posture accommodation.</p> <p>Back, height adjustable allows the user to raise or lower the chair back within a given range.</p> <p>Back lock, forward allows the user to lock the backrest in a full upright position or release it to recline.</p> <p>Back stop, selective allows the user to lock and unlock the backrest in any position within the tilt range.</p> <p>Back tilt tension adjustment regulates the ease of tilt movement of the back only.</p> <p>Back and seat tilt (Your Power mechanism) automatically responds to the weight and seating position of the user with an individual back resistance.</p> <p>Base, free swivel allows chair to swivel 360°.</p> <p>Base, memory-return swivel allows a chair to swivel 360°, but return to the forward-facing position when released.</p> <p>Base, nesting four-star has two front legs that are lower than the two rear legs, allowing chairs to nest for storage. A nylon tooth on the base engages a notch in the seat when folded. This engagement properly aligns the seat and base for nesting.</p> <p>Folding seat allows the seat to flip up, while the chair automatically rises for nesting and storage.</p>	<p>Knee tilt control (low front rise) minimizes the rise of the front of the seat when the chair is in a reclined position, allowing the users' feet to remain on the floor. This feature reduces pressure under the thighs, allowing for continuous blood circulation.</p> <p>Lumbar support, adjustable provides additional lower back comfort by allowing the user to move the lumbar support up or down, as well as increase or decrease the amount of support.</p> <p>Passive mechanism (PM) allows the seat and back to move in synchronization without manual adjustment.</p> <p>Pneumatic height allows the user to change the seat height assisted by a pneumatic gas cylinder.</p> <p>Seat angle adjustment allows the user to change and lock the seat angle in various positions.</p> <p>Seat depth, adjustable allows the user to slide the seat forward or back within a set range.</p> <p>Seat tilt control allows the seat and back to rotate as a unit backward one position and forward two positions.</p> <p>Seat, zero front rise allows the user to tilt back in the chair while feet remain on the floor because the seat front remains level.</p> <p>Swivel-tilt mechanism control allows the chair to swivel 360° and the fixed seat and back to tilt in unison when the user leans back.</p> <p>Synchro-tilt mechanism synchronizes the tilting movement of the seat and back in a set ratio.</p> <p>Tilt tension adjustment allows the user to vary the amount of recline resistance. Your Power mechanism allows the back and seat tilt to adjust automatically to the weight and seating position of the user.</p>	<p>Your Preference control allows the user to adjust the back tilt by selecting one of four settings: weight activated, weight activated with 20% resistance boost, mid-stop recline, and upright back lock.</p>
--	---	---

Occasional Tables

Avon	338
Await	340
Bix	341
Bob	344
Calm Tables Square	346
Calm Table Rectangle	347
CG_1	348
CH008 Sofa Table	352
CH100 Series Glass Coffee Table	353
CH327 Dining Table	354
Circa Freestanding Tables	355
Denizen Tablet Table	357
Diekman	358
Enea Tables with Single Base	360
Enea Tables with Twin Base	362
Enea Lottus Occasional Tables	365
Enea Lottus Conference Tables	366
Enea Lottus Café Counter Height Tables	367
Enea Lottus Café Bar Height Tables	368
Enea Lottus Rectangular Tables	369
Free Stand	370
Ginger	372
Holy Day Tables	374
Millbrae	375
Passerelle	376
Sebastopol	377
Sidewalk Occasional Tables	380
Sidewalk Storage	381
Soft Leaf	382
SW_1 Occasional Tables	384
Switch	386
TeamWork Satellite Table	387
Trees	390
Interport Power Module	391

Avon

DESIGN JIM BAREFOOT DESIGN ORIGIN: UNITED STATES

Tip: No frame sold separately.

Tip: Interport is not available on 192448.

► See Interport power/data module, page 391.

Tip: Interport is for center location only.

Standard Includes	Required to Specify
<ul style="list-style-type: none"> • Frame: solid maple with dowels and corner braces for structural integrity • Glides: polyethylene • Top: <ul style="list-style-type: none"> - Finesse: ¾" thick, double radius edge with Finesse applied - Wood: ¾" thick, double radius on solid maple edge with selected maple veneer applied 	1 Style number 2 Finesse or wood color number for top 3 Frame finish 4 Options, if selected (see below) ► See <i>Coalesse Surface Materials Reference Guide</i> .

Options	U.S. Price	Required to Specify
Surface Materials <ul style="list-style-type: none"> • Top • Contrasting wood top 	+\$186	Specify with <i>contrasting wood top</i> .
Interport Power/Data Module ❌10/15 <ul style="list-style-type: none"> • Available on wood or Finesse tops 	+\$321	Specify with <i>Interport</i> and select finish color number.

Specification Information						
Dimensions			Style Number	U.S. Base Prices		
D	W	H		Top Surface:		
				Finesse	Wood	
20"	20"	16½"	192020F	\$1163	N.A.	
20"	20"	16½"	192020W	N.A.	\$1431	
20"	30"	16½"	192030F	\$1229	N.A.	
36"	36"	16½"	193636F	\$1682	N.A.	
24"	48"	16½"	192448F	\$1496	N.A.	

► Specification Information, continued on next page

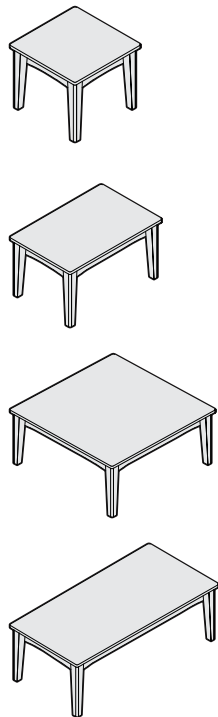

 **For Canadian Pricing**
 Multiply U.S. Price by the Canadian price factor.
 ► See page 1 for details.

❌10/15 = Last order entry
 October 18, 2015

► Specification Information, continued from previous page

Specification Information

Dimensions			Style Number	U.S. Base Prices	
D	W	H		Top Surface:	
				Finesse	Wood
20"	20"	21"	212020W	N.A.	\$1436

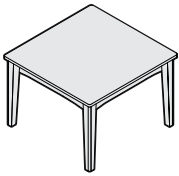
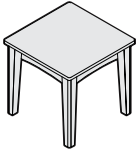

30"	30"	21"	213030F	\$1407	N.A.
-----	-----	-----	---------	--------	------



For Canadian Pricing
 Multiply U.S. Price by the
 Canadian price factor.
 ► See page 1 for details.

Await Tables

DESIGN EOOS DESIGN ORIGIN: GERMANY

 = Available in Rapid10.

Tip: Await connector tables are not recommended to be used in end-of-run applications.

Tip: Await connector tables are not made for ganging to Await mobile ottoman.

Standard Includes	Required to Specify
-------------------	---------------------

- Freestanding table frame: silver
- Connector table frame: panels are black, white, or gray
- Top: High-Pressure Laminate top with matching 3 mm edge band
- Glass top (tablet):
 - 1/2" thick
 - Radiused edges
- Ganging plate: 1/4" thick ganging plates attach to the bottom of units to the seating unit plates

- 1 Style number
 - 2 Laminate top and tablets, if selected:
 - 2595 Black
 - 2730 Arctic White
 - 2906 North Sea
 - 3 Glass color number for top, if selected
- ▶ See *Coalesse Surface Materials Reference Guide*.

Specification Information

Style Number	U.S. Prices			
	Top Surface:			
	Laminate	Clear Green/ Clear Green Frosted Glass Top	Absolute Clear/ Clear Frosted Glass Top	Colored Glass Top

Freestanding Low Round Table

 46-T1	\$1048	\$1253	\$1276	\$1444
---	--------	--------	--------	--------

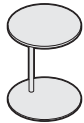

Overall: 15 3/4" Dia. 19"H

Freestanding High Round Table

 46-T2	\$1369	\$1574	\$1597	\$1765
--	--------	--------	--------	--------



Overall: 15 3/4" Dia. 25"H

Specification Information

Style Number	U.S. Prices								
	Laminate Top:			Glass Tablet:					
	No Tablet	Tablet	Tablet and Power/Data	Clear Green/ Clear Green Frosted Glass Tablet	Clear Green / Clear Green Frosted Tablet and Power/Data	Absolute Clear/ Clear Frosted Glass Tablet	Absolute Clear/ Clear Frosted Tablet and Power/Data	Colored Glass Tablet	Colored Tablet and Power/Data

Connector Tables

460-SE22	\$ 646	\$1483	N.A.	\$1542	N.A.	\$1564	N.A.	\$1725	N.A.
460-SE22PD	\$1763	N.A.	\$1763	N.A.	\$1867	N.A.	\$1888	N.A.	\$2048

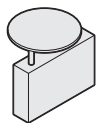

Overall: 20"D 4 1/2"W 15 3/8"H
With Tablet: 15 3/4" Dia. and 25 3/8"H

460-SE30	\$ 739	\$1576	N.A.	\$1635	N.A.	\$1662	N.A.	\$1818	N.A.
460-SE30PD	\$1861	N.A.	\$1861	N.A.	\$1965	N.A.	\$1986	N.A.	\$2146

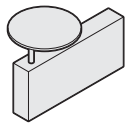

Overall: 28"D 4 1/2"W 15 3/4"H
With Tablet: 15 3/4" Dia. and 25 3/8"H

460-SE44	\$ 908	\$2582	N.A.	\$2626	N.A.	\$2671	N.A.	\$2987	N.A.
460-SE44PD	\$2858	N.A.	\$2858	N.A.	\$2996	N.A.	\$3039	N.A.	\$3361

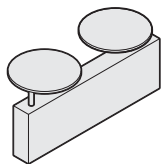

Overall: 42"D 4 1/2"W 25 3/8"H
With Tablets: 15 3/4" Dia. and 25 3/8"H

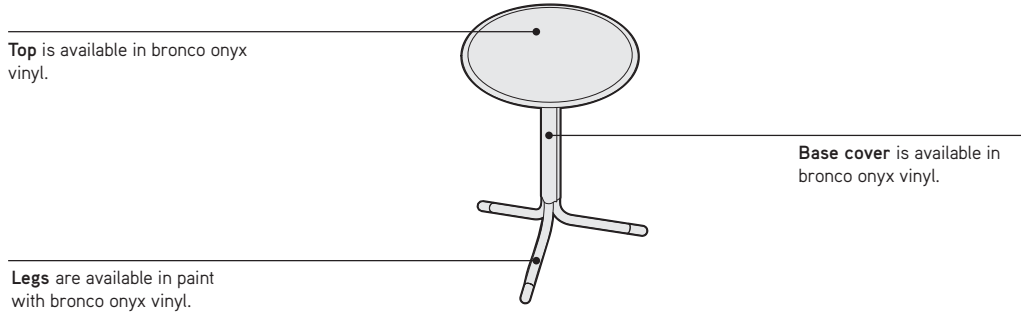

Top is available in bronco onyx vinyl.

Base cover is available in bronco onyx vinyl.

Legs are available in paint with bronco onyx vinyl.

Product Details



Side table offers a freestanding, mobile tablet surface. The tripod base allows it to be positioned close to a seating unit. The top is available in vinyl.

Surface Materials

Side table surface and base cover

- Bronco onyx vinyl

Side table base

- Paint (vinyl)

Actual Dimension

	Overall	
	Depth	Height
Side table	17" Dia.	23"

Side Table–Vinyl Version



Standard Includes		Required to Specify
▶ Need help? Product details, page 70	<ul style="list-style-type: none"> • Base: paint • Table surface and base cover: bronco onyx vinyl 	1 Style number 2 Paint color number for base ▶ See <i>Coalesse Surface Materials Reference Guide</i> .

Related Products	
Lounge chairs	▶ Page 80
Sectional seating	▶ Page 82
Podium	▶ Page 90

Specification Information			
Dimensions	H	Style Number	U.S. Price

Side Table with Vinyl Surface

16"	23"	BTS1700	\$512
-----	-----	---------	-------



For Canadian Pricing
 Multiply U.S. Price by the
 Canadian price factor.
 ▶ See page 1 for details.

Bix 18"H Occasional Tables

DESIGN METRO DESIGN GROUP

Standard Includes		Required to Specify
<p>► Need help? Product details, page 70</p>	<ul style="list-style-type: none"> • Top: <ul style="list-style-type: none"> - Laminate top (Grade 1 laminates) with matching plastic edge - Laminate top (Grade 1 Steelcase) with contrasting plastic edge - Wood top with matching flat wood edge • Base: textured paints only • Grommet, if selected: black plastic only 	<ol style="list-style-type: none"> 1 Style number 2 Laminate or wood color number for top 3 Plastic edge color number for top with Grade 1 Steelcase or Grade 2 laminate, if selected 4 Textured paint color number for base 5 Options, if selected (see below) <p>► See <i>Coalesse Surface Materials Reference Guide</i>.</p>

Options	U.S. Price	Required to Specify
<p>Surface Materials</p> <ul style="list-style-type: none"> • Wood • Custom wood finish 		► See <i>Coalesse Surface Materials Reference Guide</i> .
<p>Cable Management</p> <ul style="list-style-type: none"> • PDV module: black plastic 	+\$373 each	Specify with PDV module.
<p>Related Products</p> <ul style="list-style-type: none"> • Lounge chair • Sectional seating 		► Page 80 ► Page 82

Tip: One or two power, data, and voice modules are available on rectangular occasional tables.

Specification Information								
Dimensions				Style Number	U.S. Base Prices			
D	W	H	Diameter		Lam 1	Lam 2	Wood 1	Wood 2

Round Occasional Tables

N.A.	N.A.	18"	20"	BTC20001	\$1028	\$1080	\$1138	\$1191
N.A.	N.A.	18"	28"	BTC28001	\$1071	\$1126	\$1190	\$1304

Round Occasional Table with Grommet

N.A.	N.A.	18"	28"	BTC28001U	\$1141	\$1199	\$1260	\$1374
------	------	-----	-----	-----------	--------	--------	--------	--------

Square Occasional Table

24"	24"	18"	N.A.	BTC24241	\$1056	\$1110	\$1172	\$1244
-----	-----	-----	------	----------	--------	--------	--------	--------

Square Occasional Table with Grommet

24"	24"	18"	N.A.	BTC24241U	\$1127	\$1185	\$1243	\$1315
-----	-----	-----	------	-----------	--------	--------	--------	--------

Rectangular Table

24"	48"	18"	N.A.	BTC24481	\$1709	\$1797	\$1889	\$2036
24"	72"	18"	N.A.	BTC24721	\$1751	\$1841	\$1952	\$2168

Rectangular Occasional Tables with Grommets

24"	48"	18"	N.A.	BTC24481U	\$1849	\$1943	\$2029	\$2176
24"	72"	18"	N.A.	BTC24721U	\$1892	\$1989	\$2093	\$2309

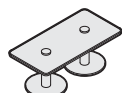
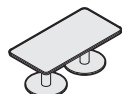

For Canadian Pricing
Multiply U.S. Price by the Canadian price factor.
► See page 1 for details.

Edge Profiles

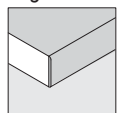

Plastic edge

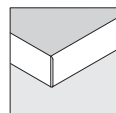

Wood edge

Bob Tables

DESIGN PEARSON LLOYD DESIGN ORIGIN: 2007 GERMANY

Tip: Glass tops are 1/2" thick, except for the absolute clear frosted glass, which is 11/16" thick. 1/32" chamfers are applied to top and bottom edges.

Standard Includes	Required to Specify
<ul style="list-style-type: none"> • Base: 8040 Aluminum Matte Polished • Top: glass • Glides 	1 Style number 2 Glass color number for top 3 Options, if selected (see below) ▶ See <i>Coalesse Surface Materials Reference Guide</i> .

Options	U.S. Price	Required to Specify
Glides <ul style="list-style-type: none"> • Felted glides 	+\$16	Specify with felted glides.

Specification Information					
Dimensions Dia H	Style Number	U.S. Base Prices			
		Top Surface: Clear Green	Clear Green Laminated/ Frosted Appearance	Absolute Clear Frosted	Absolute Clear

Round Occasional Tables

24"	15 3/4"	100-T1	\$1565	\$1712	\$1838	\$1847	\$2171
30"	15 3/4"	100-T2	\$1794	\$1940	\$2164	\$2248	\$2795
36"	15 3/4"	100-T3	\$2183	\$2358	\$2691	\$2826	\$3783
42"	15 3/4"	100-T4	\$2417	\$2666	\$3108	\$3287	\$4308

▶ Specification Information, continued on next page

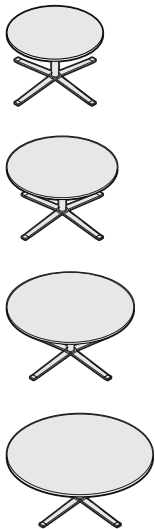

For Canadian Pricing
 Multiply U.S. Price by the
 Canadian price factor.
 ▶ See page 1 for details.

Bob Tables

DESIGN PEARSON LLOYD DESIGN ORIGIN: 2007 GERMANY

► Specification Information, continued from previous page

Specification Information

Dimensions		Style Number	U.S. Base Prices					
Dia	H		Top Surface:					
			Clear	Clear Green	Absolute Clear	Absolute Frosted	Absolute Clear	Colored Glass
			Green	Laminated/ Frosted Appearance				

Round Conference Dining Tables



24"	29"	105-T1	\$1667	\$1805	\$1934	\$1942	\$2286
-----	-----	--------	--------	--------	--------	--------	--------



30"	29"	105-T2	\$1895	\$2036	\$2258	\$2343	\$2885
-----	-----	--------	--------	--------	--------	--------	--------



36"	29"	105-T3	\$2254	\$2429	\$2762	\$2897	\$3815
-----	-----	--------	--------	--------	--------	--------	--------



42"	29"	105-T4	\$2488	\$2729	\$3173	\$3352	\$4340
-----	-----	--------	--------	--------	--------	--------	--------

 **For Canadian Pricing**
 Multiply U.S. Price by the
 Canadian price factor.
 ► See page 1 for details.

Calm Tables Square

DESIGN PAMELA LIGHT, FIIDA DESIGN ORIGIN: UNITED STATES

Tip: The Interport power/data module is not available on Calm tables.

Tip: Powder coat colors are different than other Coalesse powder coats.

Standard Includes	Required to Specify
<ul style="list-style-type: none"> • Base/frame: steel tubing and rods with decorative stainless steel cables • Cables: uncoated and located on two sides • Stretcher is located on all 4 sides • Tops: <ul style="list-style-type: none"> - Glass: 3/4" thick, green tinted with white enamel bottom surface. Translucent glass treatment does not match any existing Coalesse glass tops - Granite: 3/4" thick, available in two finishes: Black Absolute and Ubatuba (Green) • Available in Maple or Walnut veneer top with knife edge detail • Square edge detail 	<ol style="list-style-type: none"> 1 Style number 2 Top color number 3 Frame finish <ul style="list-style-type: none"> - Powder coat colors: <ul style="list-style-type: none"> - Black Gloss - Graphite Gloss - Platinum Gloss - Arctic White Gloss <p>► See <i>Coalesse Surface Materials Reference Guide</i>.</p>

Specification Information

Dimensions			Style Number	U.S. Prices				
D	W	H		Top Surface:				
				Maple	Walnut	Glass	Black Absolute Granite	Ubatuba Granite
20"	20"	17"	72-2020L	\$1498	\$1639	\$1802	\$1916	\$2191
20"	20"	22"	72-2020H	\$1530	\$1678	\$1867	\$1982	\$2266
24"	24"	17"	72-2424L	\$1604	\$1736	\$1951	\$2119	\$2397
24"	24"	22"	72-2424H	\$1675	\$1816	\$2029	\$2120	\$2400
42"	42"	17"	72-4242L	\$2417	\$2559	\$3529	\$5062	\$5341

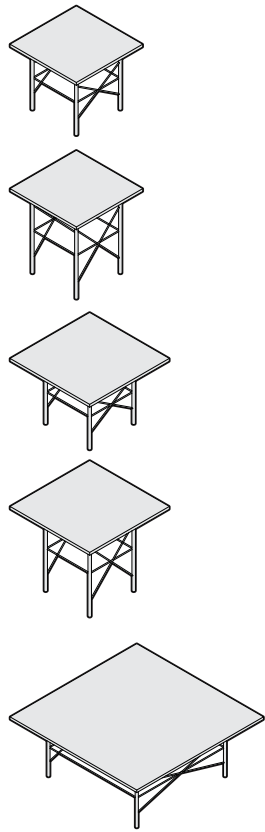

Calm Table Rectangle

DESIGN PAMELA LIGHT, FIIDA DESIGN ORIGIN: UNITED STATES

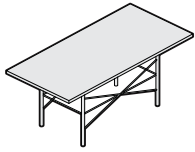

Tip: The Interport power/data module is not available on Calm tables.

Tip: Powder coat colors are different than other Coalesse powder coats.

Standard Includes	Required to Specify
-------------------	---------------------

- | | |
|--|---|
| <ul style="list-style-type: none"> • Base/frame: steel tubing and rods with decorative stainless steel cables • Cables: uncoated and located on two sides • Stretcher is located on all 4 sides • Tops: <ul style="list-style-type: none"> - Glass: 3/4" thick, green tinted with white enamel bottom surface. Translucent glass treatment does not match any existing Coalesse glass tops - Granite: 3/4" thick, available in two finishes: Black Absolute and Ubatuba (Green) • Available in Maple or Walnut veneer top with knife edge detail • Square edge detail | <ul style="list-style-type: none"> 1 Style number 2 Top color number 3 Frame finish <ul style="list-style-type: none"> - Black Gloss - Graphite Gloss - Platinum Gloss - Arctic White Gloss <p>▶ See <i>Coalesse Surface Materials Reference Guide</i>.</p> |
|--|---|

Specification Information									
---------------------------	--	--	--	--	--	--	--	--	--

Dimensions			Style Number	U.S. Prices					
D	W	H		Top Surface:					
				Maple	Walnut	Glass	Black Absolute Granite	Ubatuba Granite	
21"	42"	17"	72-2142LR	\$2130	\$2278	\$2499	\$3039	\$3319	

For Canadian Pricing
 Multiply U.S. Price by the Canadian price factor.
 ▶ See page 1 for details.

Standard Includes	Required to Specify
<ul style="list-style-type: none"> • Frame/legs: painted aluminum • Tops <ul style="list-style-type: none"> - Laminate: 1/2" thick top - Wood: veneer, oak, or walnut 1/2" thick top - Solid surface: 1/2" thick top: Glacier White only - Back painted glass: 1/2" thick top • Leg inserts: <ul style="list-style-type: none"> - Solid surface, 1/4" thick - Hardwood, 1/4" thick • Glides: non-adjustable, ships with felt option 	<ol style="list-style-type: none"> 1 Style number 2 Metal color number for frame/leg <ul style="list-style-type: none"> 4141 Platinum Matte 4180 Graphite Matte 4193 Midnight Brown Matte 4242 Milk Matte 4710 Black Matte 3 Color or finish number for top selection 4 Leg insert finish in solid surface or hardwood oak or walnut 5 Options, if selected (see below) <ul style="list-style-type: none"> ▶ See <i>Coalesse Surface Materials Reference Guide</i>.

Specification Information

Dimensions			Style Number	U.S. Prices				
D	W	H		Top Surface:				
				Laminate	Veneer Grade 1	Veneer Grade 2	White Solid Surface	Back Painted Glass

Low Square Tables

36"	36"	14"	COCGM3636L	\$1656	\$1971	\$2201	\$2533	\$2729
42"	42"	14"	COCGM4242L	\$1877	\$2236	\$2500	\$2894	\$3101
60"	60"	14"	COCGM6060L	\$2483	\$3099	\$3322	N.A.	N.A.

Low Rectangular Tables

18"	36"	14"	COCGM1836L	\$1413	\$1699	\$1914	\$2207	\$2387
18"	42"	14"	COCGM1842L	\$1490	\$1792	\$2012	\$2350	\$2518

▶ Specification Information, continued on next page

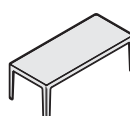
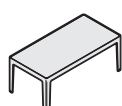
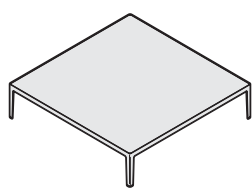
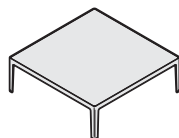
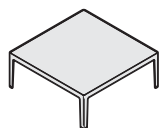

 **For Canadian Pricing**
 Multiply U.S. Price by the Canadian price factor.
 ▶ See page 1 for details.

► Specification Information, continued from previous page

Specification Information

Dimensions			Style Number	U.S. Prices				
D	W	H		Top Surface:				
				Laminate	Veneer Grade 1	Veneer Grade 2	White Solid Surface	Back Painted Glass

High Square Tables

20"	20"	19"	COCGM2020H	\$1324	\$1594	\$1794	\$2097	\$2275
-----	-----	-----	------------	--------	--------	--------	--------	--------



24"	24"	19"	COCGM2424H	\$1446	\$1739	\$1959	\$2277	\$2444
-----	-----	-----	------------	--------	--------	--------	--------	--------



High Rectangular Table

24"	36"	19"	COCGM2436H	\$1534	\$1847	\$2076	\$2447	\$2593
-----	-----	-----	------------	--------	--------	--------	--------	--------

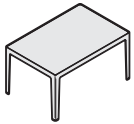

For Canadian Pricing
 Multiply U.S. Price by the
 Canadian price factor.
 ► See page 1 for details.

Standard Includes	Required to Specify
<ul style="list-style-type: none"> • Frame/legs: hardwood oak • Tops <ul style="list-style-type: none"> - Laminate: 1/2" thick top - Wood: veneer, oak, or walnut 1/2" thick top - Solid surface: 1/2" thick top: Glacier White only - Back painted glass: 1/2" thick top • Leg inserts: solid surface, 1/4" thick • Glides: non-adjustable, ships with felt option 	<ol style="list-style-type: none"> 1 Style number 2 Wood color number for frame/legs 3 Color or finish number for top selection 4 Leg insert finish: <ul style="list-style-type: none"> 2801 Glacier White 2010 Black 2011 Midnight Brown 2012 Blue 2013 Red 5 Options, if selected (see below) <p>► See <i>Coalesse Surface Materials Reference Guide</i>.</p>

Options	U.S. Price	Required to Specify
Surface Materials Frame/legs <ul style="list-style-type: none"> • Walnut 	+ \$168	Specify <i>with frame/leg in walnut</i> and select finish number.

Specification Information								
Dimensions			Style Number	U.S. Base Prices				
D	W	H		Top Surface:				
				Laminate	Veneer Grade 1	Veneer Grade 2	White Solid Surface	Back Painted Glass

Low Square Tables

36"	36"	14"	COCGW3636L	\$1822	\$2192	\$2368	\$2830	\$2941
-----	-----	-----	------------	--------	--------	--------	--------	--------

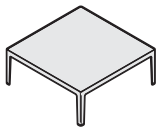

42"	42"	14"	COCGW4242L	\$1943	\$2335	\$2524	\$3052	\$3174
-----	-----	-----	------------	--------	--------	--------	--------	--------

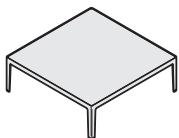

Low Rectangular Tables

18"	36"	14"	COCGW1836L	\$1601	\$1926	\$2082	\$2508	\$2587
-----	-----	-----	------------	--------	--------	--------	--------	--------

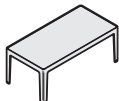

18"	42"	14"	COCGW1842L	\$1766	\$2125	\$2297	\$2774	\$2885
-----	-----	-----	------------	--------	--------	--------	--------	--------

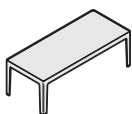

► Specification Information, continued on next page



For Canadian Pricing
 Multiply U.S. Price by the Canadian price factor.
 ► See page 1 for details.

► Specification Information, continued from previous page

Specification Information

Dimensions			Style Number	U.S. Base Prices				
D	W	H		Top Surface:				
				Laminate	Veneer Grade 1	Veneer Grade 2	White Solid Surface	Back Painted Glass

High Square Tables

20"	20"	19"	COCGW2020H	\$1436	\$1727	\$1868	\$2142	\$2298
-----	-----	-----	------------	--------	--------	--------	--------	--------

24"	24"	19"	COCGW2424H	\$1546	\$1861	\$2009	\$2302	\$2471
-----	-----	-----	------------	--------	--------	--------	--------	--------

High Rectangular Table

24"	36"	19"	COCGW2436H	\$1711	\$2057	\$2225	\$2667	\$2881
-----	-----	-----	------------	--------	--------	--------	--------	--------

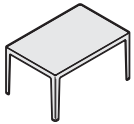

For Canadian Pricing
 Multiply U.S. Price by the Canadian price factor.
 ► See page 1 for details.

CH008 Sofa Table

DESIGN HANS WEGNER DESIGN ORIGIN: DENMARK, 1954

Beech style numbers will be available Summer 2015. Only select finishes are available at this time.

Tip: Your specification is not complete until you add the height suffix.

Standard Includes

- Table: wood

Required to Specify

- 1 Style number
- 2 Wood species/finish number, (See matrix below)
- 3 Table height:
 - 17¹/₃"H
 - 20⁸/₁₀₀"H

Specification Information

Style Number	U.S. Price
--------------	------------

30" Round Sofa Table

CH008078OAK	\$3559
CH008078WAL	\$3881
CH008078BCH	\$3066



Overall: 30"Dia. 17¹/₃"H or 20⁹/₁₀"H



Overall: 34¹/₂"Dia. 17¹/₃"H or 20⁹/₁₀"H

34¹/₂" Round Sofa Table

CH008088OAK	\$3948
CH008088WAL	\$4327
CH008088BCH	\$3368



Overall: 39¹/₄"Dia. 17¹/₃"H or 20⁹/₁₀"H

39¹/₄" Round Sofa Table

CH0080100OAK	\$4670
CH0080100WAL	\$5183
CH0080100BCH	\$3996

Wood Species/Finish Number Matrix

Finish	Wood Species Number:		
	Oak	Walnut	Beech
Lacquer	3255	3325	3745
White Oil	3265	N.A.	N.A.
Oil	3227	3335	3753
Soap	3225	N.A.	3733
CHS Color	3235	N.A.	3228, 3229, 3236, 3237, 3238, 3239, 3248, 3251, 3253, 3256, 3267, 3268, 3269



For Canadian Pricing
 Multiply U.S. Price by the Canadian price factor.
 ▶ See page 1 for details.

Coalesse

CH100 Series Glass Coffee Table

DESIGN HANS WEGNER DESIGN ORIGIN: DENMARK, 1970

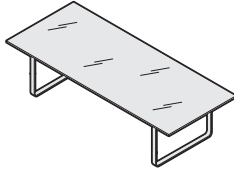

Overall: 27½"D 67"W 16½"H

Standard Includes

- Stainless steel frame and hardware
- 6513 Clear glass

Required to Specify

Style number

Specification Information

Style Number	U.S. Price
CH108	\$7194



For Canadian Pricing
Multiply U.S. Price by the
Canadian price factor.
▶ See page 1 for details.

CH327 Dining Table

DESIGN HANS WEGNER DESIGN ORIGIN: DENMARK, 1954

Beech and Oak Walnut style numbers will be available Summer 2015. Only select finishes are available at this time.

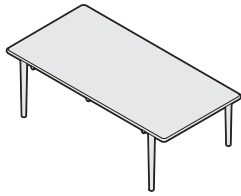

Overall: 75"L 37½"W 28½"H

Standard Includes **Required to Specify**

- Table: wood

- 1 Style number
- 2 Wood species/finish number,
(See matrix below)

Specification Information

Style Number	U.S. Price
CH327OAK	\$10,753
CH327ASH	\$10,753
CH327WALNUT	\$11,445
CH327BEECH	\$ 9243
CH32OAKWAL	\$11,151

Wood Species/Finish Number Matrix

Finish	Wood Species Number:				
	Oak	Ash	Walnut	Beech	Oak Walnut
Lacquer	3255	3615	3325	3745	3105
White Oil	3265	3645	N.A.	N.A.	N.A.
Oil	3227	3605	3335	3753	3103
Soap	3225	3603	N.A.	3733	N.A.



For Canadian Pricing
 Multiply U.S. Price by the
 Canadian price factor.
 ▶ See page 1 for details.

Circa Freestanding Tables

DESIGN ALISON SPEAR, AIA DESIGN ORIGIN: UNITED STATES

Tip: Optional steel leg has a 90° corner tapered shape.

Tip: Galvanized aluminum liner is not water tight, plastic liner recommended.

Tip: Please submit sketch for modular applications.

Tip: These colors are different than other Coalesse powder coats.

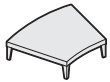

Overall: 29½"D 36⅝"W 8½"H

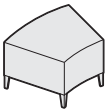

Overall: 29"D 36⅞"W 22½"H

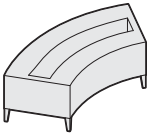

Overall: 33¼"D 70¾"W 22½"H

Standard Includes		Required to Specify
<ul style="list-style-type: none"> • Frame: hardwood veneered panels • Top and legs: hardwood maple or walnut • Planter: galvanized aluminum 		1 Style number 2 Wood color number for legs and frame 3 Options, if selected (see below) ▶ See <i>Coalesse Surface Materials Reference Guide</i> .

Options	U.S. Price	Required to Specify
Metal Legs	<ul style="list-style-type: none"> • Powder coat steel legs +\$134 per leg	Specify with <i>powder coat steel legs</i> and specify color number: Graphite Gloss, Arctic White Gloss, Platinum Gloss, Black Gloss, Midnight Brown Gloss.

Specification Information

Style Number	U.S. Base Price
--------------	-----------------

30° Freestanding Low Table with Four Legs

45-T3730L	\$1914
-----------	--------

30° Freestanding High Table with Four Legs

45-T3730H	\$2566
-----------	--------

60° Freestanding Table-Planter with Five Legs

45-T7460HP	\$5107
------------	--------



For Canadian Pricing
 Multiply U.S. Price by the Canadian price factor.
 ▶ See page 1 for details.

Circa Freestanding Tables

DESIGN ALISON SPEAR, AIA DESIGN ORIGIN: UNITED STATES

Tip: Optional steel leg has a 90° corner tapered shape.

Tip: Please submit sketch for modular applications.

Tip: These colors are different than other Coalesse powder coats.

Standard Includes	Required to Specify
-------------------	---------------------

<ul style="list-style-type: none"> • Frame: hardwood veneered panels • Top and legs: hardwood maple or walnut 	1 Style number 2 Wood color number for legs and frame 3 Options, if selected (see below) ► See <i>Coalesse Surface Materials Reference Guide</i> .
---	---

Options	U.S. Price	Required to Specify
---------	------------	---------------------

Glass Insert <ul style="list-style-type: none"> • Green tinted glass insert for round table 3/4" thick with white enamel bottom square edge detail 	+\$248	Specify with <i>glass insert</i> .
Metal Legs <ul style="list-style-type: none"> • Powder coat steel legs 	+\$134 per leg	Specify with <i>powder coat steel legs</i> and specify color number: Graphite Gloss, Arctic White Gloss, Platinum Gloss, Black Gloss, Midnight Brown Gloss.
Power/Data Module (45-T42RD only) <ul style="list-style-type: none"> • Two power/two data ports for round table only matte black or silver mica 	+\$368	Specify finish color number.

Specification Information

Style Number	U.S. Base Prices	
	Walnut or Maple	Sunburst Top

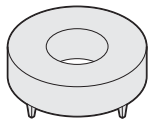

Overall: 42" dia. 15 3/4"H

Freestanding Round Table

45-T42RD	\$3464	\$3732
----------	--------	--------

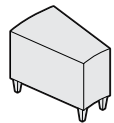

Overall: 28"D 18 1/2"W 22 1/2"H
Angle Degree: 15°

Freestanding High Wedge Table

45-T1815H	\$2073	N.A.
-----------	--------	------

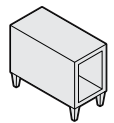

Overall: 27 1/2"D 13 1/2"W 22 1/2"H
Angle Degree: 0°

Freestanding High Straight Table

45-T1300H	\$2445	N.A.
-----------	--------	------

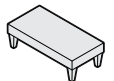

Overall: 27 1/2"D 13 1/2"W 8 1/2"H
Angle Degree: 0°

Freestanding Low Straight Table

45-T1300L	\$1602	N.A.
-----------	--------	------

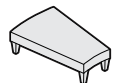

Overall: 28"D 18 1/2"W 8 1/2"H
Angle Degree: 15°

Freestanding Low Wedge Table

45-T1815L	\$1602	N.A.
-----------	--------	------



For Canadian Pricing
 Multiply U.S. Price by the Canadian price factor.
 ► See page 1 for details.

Denizen Collection Tablet Table

DESIGN WILLIAMS SOREL DESIGN ORIGIN: 2008 UNITED STATES



Tip: Ships assembled.

Standard Includes	Required to Specify
<ul style="list-style-type: none"> • Top: V3AK Rift Cut Oak veneer • Column with default painted base: paint (see below) • Glides: nylon non-marring 	<ol style="list-style-type: none"> 1 Style number 2 Wood finish for top 3 Paint finish for column 4 Options, if selected (see below) <p>► See <i>Coalesse Surface Materials Reference Guide</i>.</p>

Options	U.S. Price	Required to Specify
Surface Materials Top <ul style="list-style-type: none"> • V2AA Quarter Cut Grey Ash • V2AT Quarter Cut Teak 	Prices below Prices below	Specify <i>with grey ash</i> . Specify <i>with teak</i> .
Column <ul style="list-style-type: none"> • Brushed nickel 	+ \$116	Specify <i>with brushed nickel column</i> .

Specification Information						
Dimensions			Style Number	U.S. Base Prices		
D	W	H		Finishes:		
				Oak	Ash	Teak

Tablet Table

16"	35"	26"	CODT163526	\$1947	\$2003	\$2227
-----	-----	-----	------------	--------	--------	--------

Base Default	
Column Paint	Base Default
4138 Graphite Gloss	Graphite Metallic
4142 Platinum Gloss	Graphite Metallic
4144 Black Gloss	Graphite Metallic
4145 Milk Gloss	Gun Metal Matte
4147 Champagne Gloss	Gun Metal Matte
9238 Brushed Nickel	Gun Metal Matte



For Canadian Pricing
 Multiply U.S. Price by the Canadian price factor.
 ► See page 1 for details.

Tip: Interport power/data module is not available on Diekman.

Standard Includes	Required to Specify
<ul style="list-style-type: none"> • Frame/top: hard maple veneer • Glass top models: <ul style="list-style-type: none"> - 47-T17ELG and 47-T17RG1 models consist of two Diekman wood bases (47-T2617D and 47T2217E) with elliptical or rectangular glass tops - 1/2" thick clear glass top with radiused corners • Glides: polyethylene, non-adjustable 	1 Style number 2 Top color number 3 Frame finish ▶ See <i>Coalesse Surface Materials Reference Guide</i> .

Specification Information

Dimensions			Style Number	U.S. Prices	
D	W	H		Top Surface:	
				Glass	Wood

Wood

9 1/4"	13"	26"	47-T1326C	N.A.	\$1474
10"	16"	23"	47-T1623A	N.A.	\$1403
10"	16"	23"	47-T1623B	N.A.	\$1403
13 1/2"	15 3/4"	23"	47-T23EL	N.A.	\$1429
16"	25 3/4"	17"	47-T2617D	N.A.	\$1583
14 1/2"	22 1/4"	17"	47-T2217E	N.A.	\$1556

Wood Base, Elliptical Top

32"	40"	17 3/4"	47-T17ELG	\$3576	N.A.
-----	-----	---------	-----------	--------	------

Wood Base, Rectangle Top

32"	40"	17 3/4"	47-T17RG1	\$3593	N.A.
-----	-----	---------	-----------	--------	------

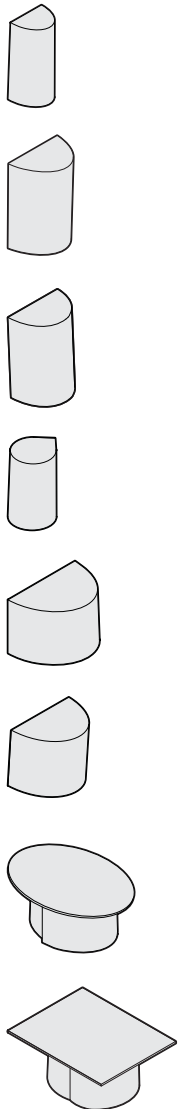

Coalesse

Diekman

DESIGN NORMAN DIEKMAN DESIGN ORIGIN: UNITED STATES

Enea Tables Single Base

DESIGN JOSEP LLUSCA DESIGN ORIGIN: SPAIN

 = Available in Rapid10.

Tip: Shipped knocked down.

Tip: Disc bases are 24" diameter for 30", 36", and 42" diameter tables. Disc bases are 31½" diameter for 54" and 60" diameter tables.

Tip: White laminate tops may exhibit slightly visible black specks inherent to the top manufacturing process.

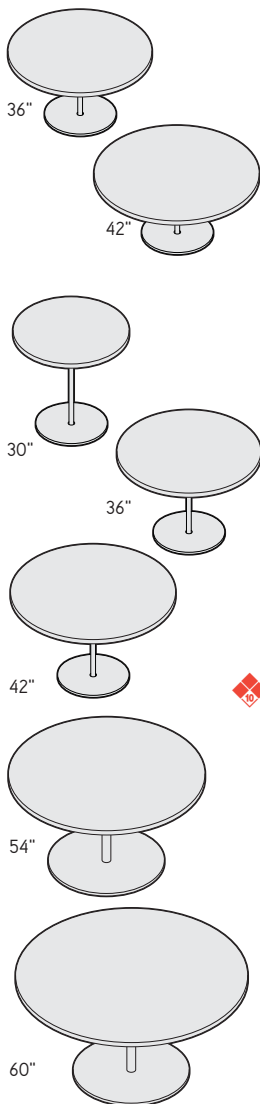

Standard Includes Required to Specify

- Laminate top: ¾" thick with T-molding color matched to base (silver metallic, black, or white)
- Wood top: ¾" thick with maple edge and maple veneer
- Base/frame: steel tubing and base
- Glides: non-skid

- 1 Style number
 - 2 Laminate or wood top color number
 - 3 Base/frame finish: black gloss, white gloss or silver metallic
- See *Coalesse Surface Materials Reference Guide*.

Specification Information

Dimensions Diameter H	Style Number	U.S. Prices	
		Laminate	Wood

Occasional

36"	18"	H35-T3618L	\$ 942	N.A.
36"	18"	H35-T3618W	N.A.	\$1304
42"	18"	H35-T4218L	\$1135	N.A.
42"	18"	H35-T4218W	N.A.	\$1864

Conference

30"	30"	H35-T3030L	\$1109	N.A.
30"	30"	H35-T3030W	N.A.	\$1728
36"	30"	H35-T3630L	\$1168	N.A.
36"	30"	H35-T3630W	N.A.	\$1923
 42"	30"	H35-T4230L	\$1343	N.A.
42"	30"	H35-T4230W	N.A.	\$2077
54"	30"	H35-T5430L	\$2135	N.A.
54"	30"	H35-T5430W	N.A.	\$3366
60"	30"	H35-T6030L	\$2138	N.A.
60"	30"	H35-T6030W	N.A.	\$3648

► Specification Information, continued on next page

 **For Canadian Pricing**
 Multiply U.S. Price by the Canadian price factor.
 ► See page 1 for details.

Enea Tables Single Base

DESIGN JOSEP LLUSCA DESIGN ORIGIN: SPAIN

 = Available in Rapid10.

► Specification Information, continued from previous page

Specification Information

Dimensions		Style Number	U.S. Prices	
Diameter	H		Top Surface: Laminate	Wood

Café/Counter Height

24"	36"	H35-T2436L	\$1071	N.A.
24"	36"	H35-T2436W	N.A.	\$1742

30"	36"	H35-T3036L	\$1171	N.A.
30"	36"	H35-T3036W	N.A.	\$1949

36"	36"	H35-T3636L	\$1213	N.A.
36"	36"	H35-T3636W	N.A.	\$2123

42"	36"	H35-T4236L	\$1400	N.A.
42"	36"	H35-T4236W	N.A.	\$2832

Café/Bar Height

24"	42"	H35-T2442L	\$1103	N.A.
24"	42"	H35-T2442W	N.A.	\$1788

 30"	42"	H35-T3042L	\$1182	N.A.
30"	42"	H35-T3042W	N.A.	\$2001

 36"	42"	H35-T3642L	\$1220	N.A.
36"	42"	H35-T3642W	N.A.	\$2175

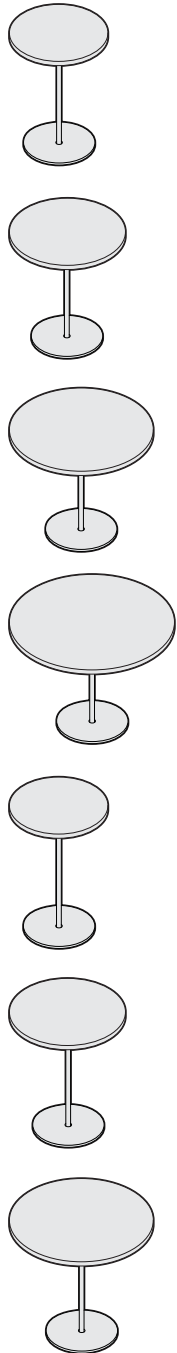

Enea Tables Twin Base

DESIGN JOSEP LLUSCA DESIGN ORIGIN: SPAIN

Tip: Shipped knocked down.

Tip: Due to weight of steel bases, please lift or move tables by bases only (do not lift by tops) with at least two people.

Tip: White laminate tops may exhibit slightly visible black specks inherent to the top manufacturing process.

Standard Includes	Required to Specify
<ul style="list-style-type: none"> • Base/frame: steel tubing and base • Glides: non-skid • Disc bases are 24" diameter • Laminate top: 3/4" thick with T-molding color matched to base (silver metallic, black, or white) • Wood top: 3/4" thick with maple edge and maple veneer 	<ol style="list-style-type: none"> 1 Style number 2 Base/frame finish: black gloss, white gloss or silver metallic 3 Laminate or wood top color number 4 Options, if selected (see below) <p>▶ See <i>Coalesse Surface Materials Reference Guide</i>.</p>

Options	U.S. Price	Required to Specify
Interport Power/Data Module <ul style="list-style-type: none"> • Mho power/data module (available in clear anodized aluminum) 	+ \$328	Specify with <i>Mho power/data module</i> .

Specification Information					
Dimensions			Style Number	U.S. Base Prices	
D	W	H		Top Surface:	
				Laminate	Wood

Rectangular

30"	72"	30"	H35-T307230GL	\$2754	N.A.
30"	72"	30"	H35-T307230GW	N.A.	\$3890
30"	72"	36"	H35-T307236GL	\$2890	N.A.
30"	72"	36"	H35-T307236GW	N.A.	\$4020
30"	72"	42"	H35-T307242GL	\$3192	N.A.
30"	72"	42"	H35-T307242GW	N.A.	\$4162

▶ Specification Information, continued on next page

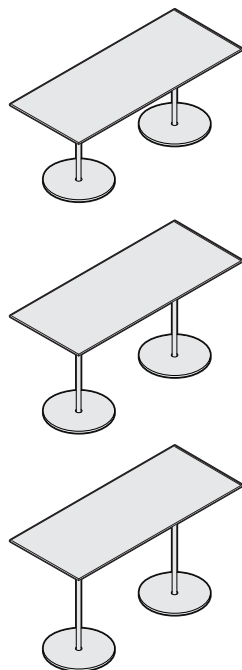

 **For Canadian Pricing**
 Multiply U.S. Price by the Canadian price factor.
 ▶ See page 1 for details.

Enea Tables Twin Base

DESIGN JOSEP LLUSCA DESIGN ORIGIN: SPAIN

► Specification Information, continued from previous page

Specification Information

Dimensions			Style Number	U.S. Base Prices	
D	W	H		Top Surface:	Wood

Oval

30"	72"	30"	H35-T307230VL	\$2748	N.A.
30"	72"	30"	H35-T307230VW	N.A.	\$4006

30"	72"	36"	H35-T307236VL	\$2770	N.A.
30"	72"	36"	H35-T307236VW	N.A.	\$4129

30"	72"	42"	H35-T307242VL	\$3025	N.A.
30"	72"	42"	H35-T307242VW	N.A.	\$4239

Conference/Racetrack

30"	72"	30"	H35-T307230KL	\$2775	N.A.
30"	72"	30"	H35-T307230KW	N.A.	\$4051

Counter/Racetrack

30"	72"	36"	H35-T307236KL	\$2896	N.A.
30"	72"	36"	H35-T307236KW	N.A.	\$4154

Café/Racetrack

30"	72"	42"	H35-T307242KL	\$3065	N.A.
30"	72"	42"	H35-T307242KW	N.A.	\$4296

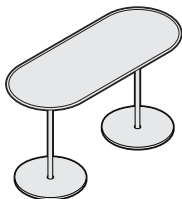
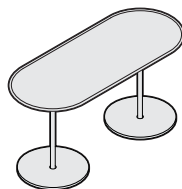
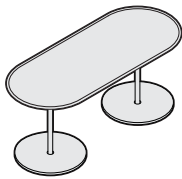
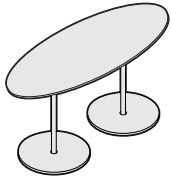
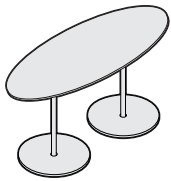
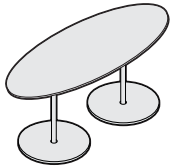

Mho Power Module for Enea Twin Base Tables

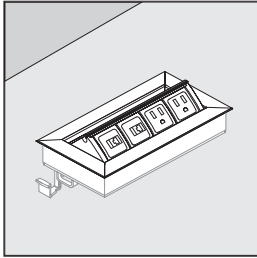
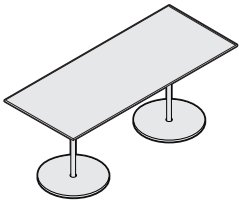

Available Models: **Options:** Available on wood, laminate and finesse covered tops only. Available in centered position only. Mho not available on Coalesse and CoalesseSpaces.models. Check grid for model availability.

Table	Model	Centered	Off Center
Enea	H35-T307230GL	Yes	No
	H35-T307230GW	Yes	No
	H35-T307236GL	Yes	No
	H35-T307236GW	Yes	No
	H35-T307242GL	Yes	No
	H35-T307242GW	Yes	No
	H35-T307230VL	Yes	No
	H35-T307230VW	Yes	No
	H35-T307236VL	Yes	No
	H35-T307236VW	Yes	No
	H35-T307242VL	Yes	No
	H35-T307242VW	Yes	No
	H35-T307230KL	Yes	No
	H35-T307230KW	Yes	No
	H35-T307236KL	Yes	No
	H35-T307236KW	Yes	No
	H35-T307242KL	Yes	No
	H35-T307242KW	Yes	No

Color:
Anodized Aluminum

Enea Lottus Occasional Tables

DESIGN LIEVORE ALTHERR MOLINA DESIGN ORIGIN: SPAIN

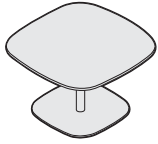

Standard Includes	Required to Specify
-------------------	---------------------

- Top: laminate or wood veneer with 1/2" thick phenolic core
- Base and frame: steel tubing and base
- Glides: non-skid

- 1 Style number
 - 2 Laminate or wood veneer color number for top
 - 3 Base/frame finish:
 - 4016 White Gloss
 - 4017 Black Gloss
 - 4217 Brown
 - 4218 Platinum Silver
- ▶ See *Coalesse Surface Materials Reference Guide*.

Specification Information						
Dimensions			Style Number	U.S. Prices		
D	W	H		Top Surface:		
				Laminate	Wood 1	Wood 2
30"	30"	18"	COEL1830	\$1240	\$1389	\$1500
36"	36"	18"	COEL1836	\$1440	\$1619	\$1754
42"	42"	18"	COEL1842	\$1755	\$1920	\$2076



For Canadian Pricing
 Multiply U.S. Price by the Canadian price factor.
 ▶ See page 1 for details.

Enea Lottus Conference Tables

DESIGN LIEVORE ALTHERR MOLINA DESIGN ORIGIN: SPAIN



Standard Includes	Required to Specify
-------------------	---------------------

- Top: laminate or wood veneer with 1/2" thick phenolic core
- Base and frame: steel tubing and base
- Glides: non-skid

- 1 Style number
 - 2 Laminate or wood veneer color number for top
 - 3 Base/frame finish:
 - 4016 White Gloss
 - 4017 Black Gloss
 - 4217 Brown
 - 4218 Platinum Silver
- See *Coalesse Surface Materials Reference Guide*.

Specification Information						
Dimensions			Style Number	U.S. Prices		
D	W	H		Top Surface:		
				Laminate	Wood 1	Wood 2
30"	30"	30"	COEL3030	\$1295	\$1444	\$1559
36"	36"	30"	COEL3036	\$1494	\$1673	\$1812
42"	42"	30"	COEL3042	\$1805	\$1974	\$2133



For Canadian Pricing
 Multiply U.S. Price by the Canadian price factor.
 ► See page 1 for details.

Enea Lottus Café Counter Height Tables

DESIGN LIEVORE ALTHERR MOLINA DESIGN ORIGIN: SPAIN

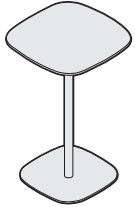

Standard Includes

- Top: laminate or wood veneer with 1/2" thick phenolic core
- Base and frame: steel tubing and base
- Glides: non-skid

Required to Specify

- 1 Style number
 - 2 Laminate or wood veneer color number for top
 - 3 Base/frame finish:
 - 4016 White Gloss
 - 4017 Black Gloss
 - 4217 Brown
 - 4218 Platinum Silver
- See *Coalesse Surface Materials Reference Guide*.

Specification Information

Dimensions			Style Number	U.S. Prices		
D	W	H		Top Surface:		
				Laminate	Wood 1	Wood 2
24"	24"	36"	COEL3624	\$1073	\$1166	\$1260
30"	30"	36"	COEL3630	\$1329	\$1481	\$1601
36"	36"	36"	COEL3636	\$1531	\$1710	\$1852
42"	42"	36"	COEL3642	\$1838	\$2007	\$2169



For Canadian Pricing
 Multiply U.S. Price by the
 Canadian price factor.
 ► See page 1 for details.

Enea Lottus Café Bar Height Tables

DESIGN LIEVORE ALTHERR MOLINA DESIGN ORIGIN: SPAIN

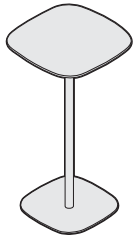

Standard Includes	Required to Specify
-------------------	---------------------

- Top: laminate or wood veneer with 1/2" thick phenolic core
- Base and frame: steel tubing and base
- Glides: non-skid

- 1 Style number
 - 2 Laminate or wood veneer color number for top
 - 3 Base/frame finish:
 - 4016 White Gloss
 - 4017 Black Gloss
 - 4217 Brown
 - 4218 Platinum Silver
- See *Coalesse Surface Materials Reference Guide*.

Specification Information						
Dimensions			Style Number	U.S. Prices		
D	W	H		Top Surface:		
				Laminate	Wood 1	Wood 2
24"	24"	42"	COEL4224	\$1103	\$1200	\$1298
30"	30"	42"	COEL4230	\$1361	\$1510	\$1631
36"	36"	42"	COEL4236	\$1559	\$1738	\$1882
42"	42"	42"	COEL4242	\$1933	\$2102	\$2272



For Canadian Pricing
 Multiply U.S. Price by the Canadian price factor.
 ► See page 1 for details.

Enea Lottus Rectangular Tables

DESIGN LIEVORE ALTHERR MOLINA DESIGN ORIGIN: SPAIN

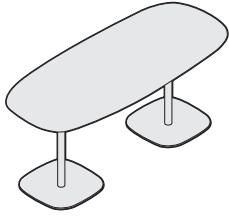

Standard Includes

- Top: laminate or wood veneer with 1/2" thick phenolic core
- Base and frame: steel tubing and base
- Glides: non-skid

Required to Specify

- 1 Style number
 - 2 Laminate or wood veneer color number for top
 - 3 Base/frame finish:
 - 4016 White Gloss
 - 4017 Black Gloss
 - 4217 Brown
 - 4218 Platinum Silver
- See *Coalesse Surface Materials Reference Guide*.

Specification Information

Dimensions			Style Number	U.S. Prices		
D	W	H		Top Surface:		
				Laminate	Wood 1	Wood 2
30"	72"	30"	COEL303072	\$2914	\$3285	\$3552
30"	72"	36"	COEL363072	\$2979	\$3350	\$3621
30"	72"	42"	COEL423072	\$3042	\$3413	\$3690



For Canadian Pricing
 Multiply U.S. Price by the
 Canadian price factor.
 ► See page 1 for details.

Free Stand

DESIGN STEPHEN COPELAND DESIGN ORIGIN: UNITED STATES



Tip: Worksurface height adjusts from 20"–27" and rotates 360°.

Tip: Free stand is 5" tall when folded/collapsed and weighs 11 pounds.

Tip: Free stand can nest. In nested position each additional unit extends 5 1/4" beyond the previous unit.

Standard Includes	Required to Specify
-------------------	---------------------

- Height-adjustable, soft-touch: 4433 Black
- Foldable/collapsible column: 4144 Black Gloss paint
- Base: 6205 Black plastic

Style number

Specification Information			
Dimensions		Style Number	U.S. Price
D	W		

22 1/4"	21 1/4"	COCFS	\$618
---------	---------	-------	-------

 **For Canadian Pricing**
 Multiply U.S. Price by the Canadian price factor.
 ▶ See page 1 for details.

Coalesse

Free Stand

DESIGN STEPHEN COPELAND DESIGN ORIGIN: UNITED STATES

Ginger

DESIGN GEORGE SIMONS, IDSA DESIGN ORIGIN: UNITED STATES

Tip: Granite is a natural material, and fissures, color, and vein patterns will be inherent.

Tip: Granite tops are crated separately for maximum protection and shipped vertically.

Tip: Bases are not sold separately.

Tip: Contrasting wood top option is available on wood models only.

Tip: Interport is not available on 37-1943EL.

Tip: Interport is for center location only.

► See *Interport power/data module*, page 391.

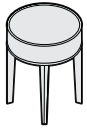

Overall: 18" Dia. 22"H



Overall: 24" Dia. 22"H

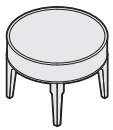

Overall: 24" Dia. 17"H

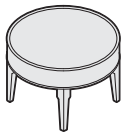

Overall: 31" Dia. 17"H



For Canadian Pricing
Multiply U.S. Price by the Canadian price factor.
► See page 1 for details.

Standard Includes	Required to Specify
<ul style="list-style-type: none"> • Frame: Solid maple and maple veneered frame • Top: <ul style="list-style-type: none"> - Glass: 3/4" thick, green tinted with white enamel bottom - Finesse: 3/4" thick, with Finesse applied - Wood: 3/4" thick, selected maple veneer - Granite: 3/4" thick, available in two finishes: Black Absolute or Ubatuba (Green) • Glides: Polyethylene 	1 Style number 2 Top color number 3 Frame finish 4 Options, if selected (see below) ► See <i>Coalesse Surface Materials Reference Guide</i> .

Options	U.S. Price	Required to Specify
Surface Materials <ul style="list-style-type: none"> • Contrasting wood top 	+\$186	Specify with <i>contrasting wood top</i> .
Interport Power/Data Module <ul style="list-style-type: none"> • Available on wood or Finesse tops only 	+\$321	Specify with <i>Interport</i> and select finish color number.

Specification Information

Style Number	U.S. Base Prices				
	Top Surface:				
	Finesse	Glass	Wood	Black Absolute Granite	Ubatuba Granite

Round

37-18RDHF	\$1538	N.A.	N.A.	N.A.	N.A.
37-18RDHGL	N.A.	\$1927	N.A.	N.A.	N.A.
37-18RDHW	N.A.	N.A.	\$1665	N.A.	N.A.
37-18RDHGR	N.A.	N.A.	N.A.	\$1967	\$1979
37-24RDHF	\$1825	N.A.	N.A.	N.A.	N.A.
37-24RDHGL	N.A.	\$2302	N.A.	N.A.	N.A.
37-24RDHW	N.A.	N.A.	\$1913	N.A.	N.A.
37-24RDHGR	N.A.	N.A.	N.A.	\$2716	\$2785
37-24RDLF	\$1786	N.A.	N.A.	N.A.	N.A.
37-24RDLGL	N.A.	\$2254	N.A.	N.A.	N.A.
37-24RDLW	N.A.	N.A.	\$1873	N.A.	N.A.
37-24RDLGR	N.A.	N.A.	N.A.	\$2672	\$2736
37-31RDLF	\$2262	N.A.	N.A.	N.A.	N.A.
37-31RDLGL	N.A.	\$2912	N.A.	N.A.	N.A.
37-31RDLW	N.A.	N.A.	\$2397	N.A.	N.A.
37-31RDLGR	N.A.	N.A.	N.A.	\$4515	\$4700

► Specification Information, continued on next page

Ginger

DESIGN GEORGE SIMONS, IDSA DESIGN ORIGIN: UNITED STATES

► Specification Information, continued from previous page

Specification Information

Style Number	U.S. Base Prices				
	Top Surface:				
	Finesse	Glass	Wood	Black Absolute Granite	Ubatuba Granite

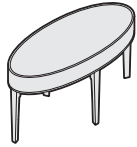

Overall: 19½" Dia. 43"W 17"H

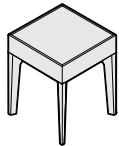

Overall: 18"D 18"W 22"H

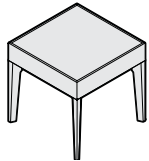

Overall: 24"D 24"W 22"H

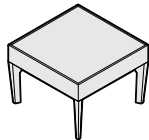

Overall: 24"D 24"W 17"H

Elliptical

37-1943ELF	\$2422	N.A.	N.A.	N.A.	N.A.
37-1943ELGL	N.A.	\$3257	N.A.	N.A.	N.A.
37-1943ELW	N.A.	N.A.	\$2663	N.A.	N.A.
37-1943ELGR	N.A.	N.A.	N.A.	\$4549	\$4702

Square

37-1818HF	\$1538	N.A.	N.A.	N.A.	N.A.
37-1818HGL	N.A.	\$1919	N.A.	N.A.	N.A.
37-1818HW	N.A.	N.A.	\$1665	N.A.	N.A.
37-1818HGR	N.A.	N.A.	N.A.	\$1967	\$1979

37-2424HF	\$1825	N.A.	N.A.	N.A.	N.A.
37-2424HGL	N.A.	\$2302	N.A.	N.A.	N.A.
37-2424HW	N.A.	N.A.	\$1913	N.A.	N.A.
37-2424HGR	N.A.	N.A.	N.A.	\$2716	\$2785

37-2424LF	\$1786	N.A.	N.A.	N.A.	N.A.
37-2424LGL	N.A.	\$2254	N.A.	N.A.	N.A.
37-2424LW	N.A.	N.A.	\$1873	N.A.	N.A.
37-2424LGR	N.A.	N.A.	N.A.	\$2672	\$2736

 **For Canadian Pricing**
 Multiply U.S. Price by the
 Canadian price factor.
 ► See page 1 for details.

Holy Day Tables

DESIGN JEAN-MARIE MASSAUD DESIGN ORIGIN: 2003 SPAIN

Tip: Glass tops are 1/2" thick. 1/32" chamfers are applied to top and bottom edges.

Standard Includes	Required to Specify
<ul style="list-style-type: none"> • Top: wood, leather, or glass • Frame: polished trivalent chrome 	<ol style="list-style-type: none"> 1 Style number 2 Wood color number for top, if selected 3 Leather color number for top, if selected 4 Glass color number for top, if selected 5 Options, if selected (see below) <p>► See <i>Coalesse Surface Materials Reference Guide</i>.</p>

Options	U.S. Price	Required to Specify
Contrasting Saddle Stitching <ul style="list-style-type: none"> • Available on leather only 	No cost	Specify with <i>saddle stitching</i> and select thread color.

Specification Information										
Style Number	U.S. Prices									
	Top Surface:						Leather Grades:		COL	C
	Clear	Green	Clear Green	Laminated/ Frosted Appearance	Absolute Clear Frosted	Absolute Clear	Colored Glass	Oak	Walnut	



Overall: 35½"D 10½"H

Round Table with Wood Top

COHD35RDW	N.A.	N.A.	N.A.	N.A.	N.A.	\$2611	\$2641	N.A.	N.A.
-----------	------	------	------	------	------	--------	--------	------	------

Round Table with Leather Top

COHD35RDL	N.A.	N.A.	N.A.	N.A.	N.A.	N.A.	N.A.	\$2223	\$2792
-----------	------	------	------	------	------	------	------	--------	--------

COL/sq ft = 22

Round Table with Glass Top

COHD35RDG	\$3214	\$3336	\$3476	\$3622	\$4379	N.A.	N.A.	N.A.	N.A.
-----------	--------	--------	--------	--------	--------	------	------	------	------

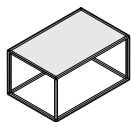

Overall: 27½"D 18"W 14"H

Rectangular Table with Wood Top

COHD30RCW	N.A.	N.A.	N.A.	N.A.	N.A.	\$2187	\$2210	N.A.	N.A.
-----------	------	------	------	------	------	--------	--------	------	------

Rectangular Table with Leather Top

COHD30RCL	N.A.	N.A.	N.A.	N.A.	N.A.	N.A.	N.A.	\$2141	\$2307
-----------	------	------	------	------	------	------	------	--------	--------

COL/sq ft = 11

Rectangular Table with Glass Top

COHD30RCG	\$2755	\$2888	\$3017	\$3163	\$3652	N.A.	N.A.	N.A.	N.A.
-----------	--------	--------	--------	--------	--------	------	------	------	------

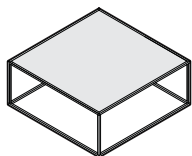

Overall: 35½"D 35½"W 10½"H

Square Table with Wood Top

COHD35SQW	N.A.	N.A.	N.A.	N.A.	N.A.	\$2532	\$2562	N.A.	N.A.
-----------	------	------	------	------	------	--------	--------	------	------

Square Table with Leather Top

COHD35SQL	N.A.	N.A.	N.A.	N.A.	N.A.	N.A.	N.A.	\$2382	\$2756
-----------	------	------	------	------	------	------	------	--------	--------

COL/sq ft = 22

Square Table with Glass Top

COHD35SQG	\$3559	\$3885	\$4171	\$4211	\$5097	N.A.	N.A.	N.A.	N.A.
-----------	--------	--------	--------	--------	--------	------	------	------	------



For Canadian Pricing
Multiply U.S. Price by the Canadian price factor.

► See page 1 for details.

Passerelle

DESIGN STUDIO B DESIGN ORIGIN: UNITED STATES

Tip: Bases are not sold separately.

Tip: Interport is not available on 44-T164830.

► See *Interport power/data module*, page 391.

Tip: Interport is for center location only.

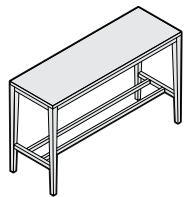
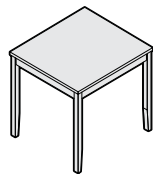
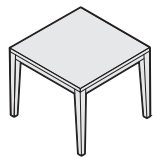

Standard Includes	Required to Specify
<ul style="list-style-type: none"> • Frame: Solid maple with mortise and tenon joinery for structural integrity • Glides: Polyethylene • Wood top: 1" thick, selected maple veneer • Ships ready-to-assemble 	1 Style number 2 Top and frame finish 3 Options, if selected (see below) ► See <i>Coalesse Surface Materials Reference Guide</i> .

Options	U.S. Price	Required to Specify
Surface Materials • Contrasting wood top	+\$186	Specify with <i>contrasting wood top</i> .
Interport Power/Data Module • Interport Power/Data Module	+\$328	Specify with <i>Interport</i> and select finish color number.

Specification Information

Dimensions			Style	U.S. Base Price
D	W	H	Number	Top Surface: Wood
24"	24"	17"	44-T242417	\$ 932
24"	24"	21"	44-T242421	\$1014
16"	48"	30"	44-T164830	\$1395

 **For Canadian Pricing**
 Multiply U.S. Price by the Canadian price factor.
 ► See page 1 for details.

Sebastopol Thought Starters

DESIGN EMILIA BORGTHORSDDOTTIR DESIGN ORIGIN: UNITED STATES

Sebastopol is a unique collection of tables with endless configuration possibilities. It comprises of 2 shapes, each shape being offered in a 16" high and 22" high version. The following are just a few thought starters.

To create these table configurations use the following pieces labeled either A or B in any combination of the two heights, or use them on their own as a stand alone piece.

Shape A:
COEB2723 L or H



Shape B:
COEB4118 L or H

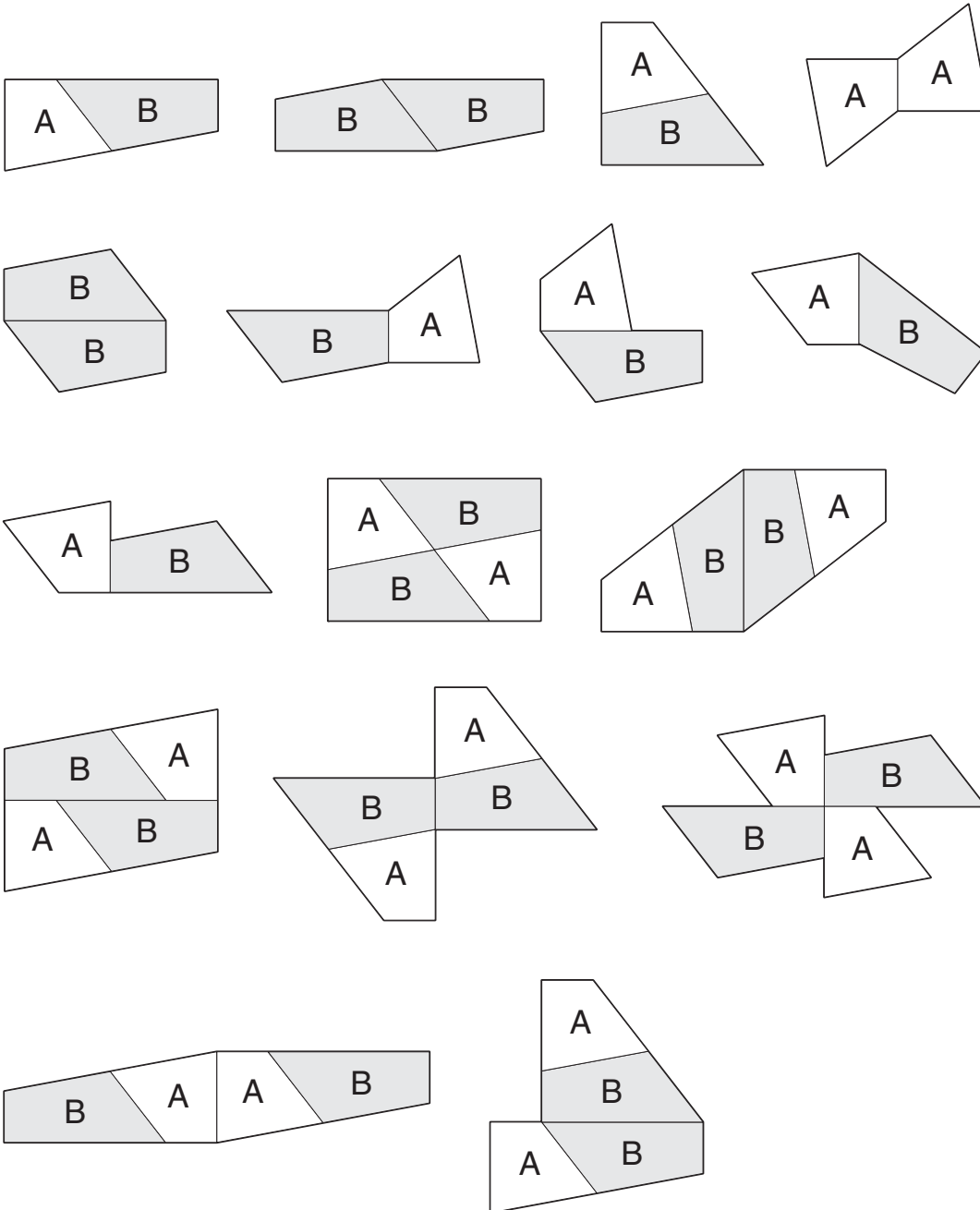
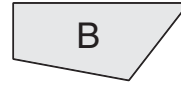

Sebastopol

DESIGN EMILIA BORGTHORSDDOTTIR DESIGN ORIGIN: UNITED STATES

Tables

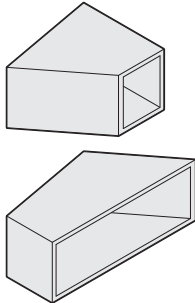

Tip: Optional grommet to accept power pod can be specified in milk white or black plastic.

Tip: If a grommet is specified with a Power Pod and the table is over a floor core, the floor core outlet cannot be flush to the floor, because the plug end will not allow the Power Pod to sit in the grommet. If the floor core is flush to the floor and the grommet and Power Pod are required, the table either cannot be set over the floor core, or a special plinth base will be required. Consult your specials representative for additional information on the plinth base.

Standard Includes	Required to Specify
<ul style="list-style-type: none"> Exterior surface: veneer grade 1, oak, or walnut Interior surface: glossy laminate Glides: concealed adjustable glide with non-marking nylon pad 	<ol style="list-style-type: none"> Style number Exterior surface wood finish number Interior surface glossy laminate: <ul style="list-style-type: none"> 2001 Smoky White 2002 Studio Gray 2003 Wrought Iron 2004 Black Pearl 2005 Liberty Red Options, if selected (see below) <p>► See <i>Coalesse Surface Materials Reference Guide</i>.</p>

Options	U.S. Price	Required to Specify
Grommet <ul style="list-style-type: none"> Grommet to accept power pod 	+\$110	Specify <i>with grommet</i> and select finish color number either in milk white or black plastic.

Specification Information					
Dimensions			Style Number	U.S. Base Prices	
D	W	H		Top Surface:	
				Wood Grade 1	Wood Grade 2

16" High Tables

23"	27"	16"	COEB2723L	\$1213	\$1312
18"	41"	16"	COEB4118L	\$1436	\$1552

22" High Tables

23"	27"	22"	COEB2723H	\$1324	\$1432
18"	41"	22"	COEB4118H	\$1546	\$1671



For Canadian Pricing
 Multiply U.S. Price by the Canadian price factor.
 ► See page 1 for details.

Sebastopol

DESIGN EMILIA BORGTHORSDDOTTIR DESIGN ORIGIN: UNITED STATES

Power Pod

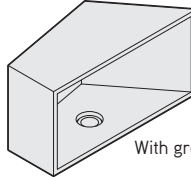
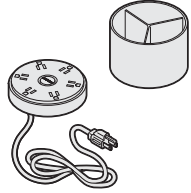

With grommet

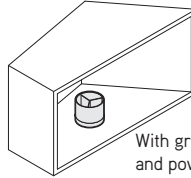

With grommet and power pod

Tip: Leveling glides can be adjusted so that the bottom surface of the table can be anywhere from 5/8" to 1" off of the floor.

Tip: The Power Pod cord will exit out the bottom of the table.

Tip: If a grommet is specified with a Power Pod and the table is over a floor core, the floor core outlet cannot be flush to the floor, because the plug end will not allow the Power Pod to sit in the grommet. If the floor core is flush to the floor and the grommet and Power Pod are required, the table either cannot be set over the floor core, or a special plinth base will be required. Consult your specials representative for additional information on the plinth base.

Standard Includes	Required to Specify
-------------------	---------------------

- Power Pod with 6' and three prong plug: silver bottom cradle and milk face
- Accessory tray: milk
- Six 15-amp power outlets
- Illuminated on/off button
- Surge suppressor

Style number

Specification Information

Dimensions		Style Number	U.S. Price
Dia	H		
6"	6"	COPP01	\$168



For Canadian Pricing
 Multiply U.S. Price by the Canadian price factor.
 ▶ See page 1 for details.

Sidewalk Occasional Tables

DESIGN STUDIO B DESIGN ORIGIN: UNITED STATES

Standard Includes	Required to Specify
<ul style="list-style-type: none"> • Frames constructed of finger jointed select hard maple, reinforced with wood substrate • Legs: silver powder coat steel with "Go" glides • Tops: <ul style="list-style-type: none"> - Wood: 1/2" thick veneered tops and quarter cut book-matched hard maple veneer - Glass: 3/16" thick glass sandblasted with white on back surface • Ships ready-to assemble 	<ol style="list-style-type: none"> 1 Style number 2 Wood color number for frame 3 Wood color number for top, if selected: 4 Options, if selected (see below) <p>► See <i>Coalesse Surface Materials Reference Guide</i>.</p>

Options	U.S. Price	Required to Specify
Glides <ul style="list-style-type: none"> • "No Go" 1/2" polyethylene glides 	No cost	Specify with "No Go" glides.

Specification Information

Dimensions			Style Number	U.S. Prices	
D	W	H		Top Surface:	
				Wood	Glass
17"	17"	17"	43-T171717	\$1502	\$1763
22"	22"	22"	43-T222222	\$1764	\$2019

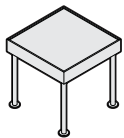
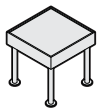

For Canadian Pricing
 Multiply U.S. Price by the
 Canadian price factor.
 ► See page 1 for details.

Sidewalk Storage

DESIGN STUDIO B DESIGN ORIGIN: UNITED STATES

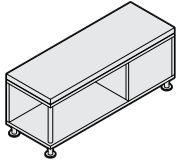

Tip: Credenza Interior dimensions:
 Open Area -
 16" D x 28 1/4" W x 13" H
 Closed Area -
 14 1/2" D x 15 3/4" W x 13" H

Standard Includes	Required to Specify
<ul style="list-style-type: none"> Credenza: hard maple veneer panels Legs: silver powder coat steel with "Go" glide Tops: wood 1/2" thick veneered tops and quarter cut book-matched hard maple veneer Hinges: European on credenza door 	1 Style number 2 Wood color number for storage 3 Options, if selected (see below) ▶ See <i>Coalesse Surface Materials Reference Guide</i> .

Options	U.S. Price	Required to Specify	
Glides	• "No go" 1/2" polyethylene glides	No cost	Specify with "no go" glides.
Credenza	• Hinges on facing door	No cost	Specify with <i>left on facing door</i> or <i>right on facing door</i> .

Specification Information			
Dimensions	Style	U.S. Price	
D W H	Number	Top Surface:	
		Wood	

Credenza				
17"	48"	20"	43-S174820	\$2636



For Canadian Pricing
 Multiply U.S. Price by the
 Canadian price factor.
 ▶ See page 1 for details.

Soft Leaf

DESIGN NORMAN DIEKMAN DESIGN ORIGIN: UNITED STATES

Tip: Glass puddle dimensions are 17" x 19", 1/2" thick.

Tip: Attached aluminum disc or puddle not available on 49-SFTH17B. Unattached only.

Tip: Fabrics and leathers will appear loose with comfort wrinkles when upholstered.

Tip: Due to the design and construction techniques of Soft Leaf tables, only certain textiles can be successfully applied, therefore COM fabrics must be submitted to Coalesse for approval prior to order acceptance.

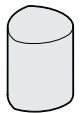

Overall: 16"D 17 1/2"W 21"H

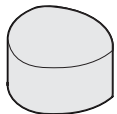

Overall: 29 1/2"D 28"W 15 1/2"H

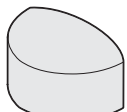

Overall: 39 1/2"D 28 1/2"W 17"H

Standard Includes	Required to Specify
<ul style="list-style-type: none"> • Frame: Unibody construction with finger jointed plywood • Upholstery: Multiple densities of laminated polyurethane • Glides: Height adjustable polyurethane leveling 	1 Style number 2 Fabric color number 3 Options, if selected (see below) ▶ See <i>Coalesse Surface Materials Reference Guide</i> .

Options	U.S. Price	Required to Specify
Surface Materials • Acrylic backer • Backer for 49-SFTH21C +\$ 17 • Backer for 49-SFTH15A and 49-SFTH17B +\$ 29		Specify with acrylic backer. Specify with acrylic backer. ▶ See <i>Coalesse Surface Materials Reference Guide</i> .
Puddle • Brushed aluminum +\$ 539 • Glass puddle +\$ 390 • 36" round glass top with unattached brush aluminum disc +\$1534 • 36" round glass top with unattached brush aluminum puddle +\$1584 • 36" round glass top with unattached glass puddle +\$1689		Specify with brushed aluminum puddle and indicate attached or unattached. Specify with glass puddle and indicate attached or unattached. Specify with brush aluminum disc. Specify with brush aluminum puddle. Specify with glass puddle.
Disc • Brushed aluminum 13 3/4" disc +\$ 341		Specify with brushed aluminum disc attached or unattached.
Glass • 36" round glass top, unattached (Model 49-SFTH15A only) +\$1195		Specify with 36" round glass top.

Specification Information

Style Number	U.S. Base Prices										Leather Grades:		
	COM	6	7	8	9	10	11	12	13	14	COL	C	E
49-SFTH21C	\$556	\$556	\$569	\$591	\$659	\$703	\$ 754	\$ 789	\$ 852	\$ 939	\$821	\$1802	\$1984
COM/yds = 2, COL/sq ft = 44													

Upholstered

49-SFTH15A	\$698	\$698	\$718	\$751	\$853	\$919	\$ 995	\$1048	\$1142	\$1273	\$929	\$2443	\$2716
COM/yds = 3, COL/sq ft = 66													
49-SFTH17B	\$750	\$750	\$770	\$803	\$905	\$971	\$1047	\$1100	\$1194	\$1325	\$981	\$2482	\$2754
COM/yds = 3, COL/sq ft = 66													



For Canadian Pricing
 Multiply U.S. Price by the Canadian price factor.
 ▶ See page 1 for details.

Coalesse

Soft Leaf

DESIGN NORMAN DIEKMAN DESIGN ORIGIN: UNITED STATES

SW_1 Occasional Tables

DESIGN SCOTT WILSON & MINIMAL



Standard Includes	Required to Specify
<ul style="list-style-type: none"> • 1/2" thick top surface: <ul style="list-style-type: none"> - Laminate (Grade 1) with 3 mm edge band, if selected - Wood veneer (Grade 1) with matching 3 mm edge band, if selected - Corian, if selected: white only - Glass, if selected • 1/4" thick bottom substructure: black or milk • Base, column, and cone: 8040 Polished Matte Aluminum • Glides • Ships ready-to assemble 	<ol style="list-style-type: none"> 1 Style number with appropriate top series letter indicated in the space provided. (For example: COWO_RND30 becomes COWOLRND30 for a laminate top surface): <ul style="list-style-type: none"> L - Laminate top V - Wood veneer top C - Corian top G - Glass top 2 Laminate, wood, or glass color number for top, if selected 3 Plastic color for edge band of laminate top, if selected 4 Bottom substructure: <ul style="list-style-type: none"> 6000 Black 6052 Milk 5 Options, if selected (see below) <ul style="list-style-type: none"> ▶ See <i>Coalesse Surface Materials Reference Guide</i>.

	Options	U.S. Price	Required to Specify
Surface Materials	Laminate		
	• Grade 2 laminate	Prices at right	Specify with <i>Grade 2 laminate</i> and select color number.
	Wood		
	• Grade 2 wood veneer	Prices at right	Specify with <i>Grade 2 wood veneer</i> and select color number.
	• Grade 1 wedge layup veneer	Prices at right	Specify with <i>Grade 1 wedge veneer layup</i> and select color number.
	• Grade 2 wedge layup veneer	Prices at right	Specify with <i>Grade 2 wedge veneer layup</i> and select color number.
	• Stain-to-Match	No cost	Specify with <i>Stain-to-Match</i> . ▶ See <i>Coalesse Surface Materials Reference Guide</i> .
Grommet	42" and 48" round, 42" square and 45 1/2" super-square tables		
	• One grommet (center only)	+\$118	Specify with <i>one grommet</i> .
	• One grommet	+\$118	Specify with <i>one grommet</i> .
	60" large round and large square tables		
	• Two grommets	+\$236	Specify with <i>two grommets</i> .
Related Products	• Power Pod		▶ Page 379
	• SW_1 lounge		▶ Page 229

Tip: If grommet is selected, the finish is not selectable, it will be the same as the substructure finish choice.

Tip: There is no vertical wire manager with grommet selection.

Veneer direction



For Canadian Pricing
Multiply U.S. Price by the Canadian price factor.
▶ See page 1 for details.

SW_1 Occasional Tables

DESIGN SCOTT WILSON & MINIMAL

Tip: Your specification is not complete until you add the fifth letter to the style number to define top surface.

- L - Laminate top
- V - Wood veneer top
- C - Corian top
- G - Glass top

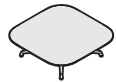

Specification Information

Dimensions			Style Number	U.S. Base Prices				Wedge Veneer Layout		Corian	Glass
L	W	H		Laminate		Veneer		Grade 1	Grade 2		
				Grade 1	Grade 2	Grade 1	Grade 2	Grade 1	Grade 2		
Round											
30" diameter	15"		COWO_RND30	\$1743	\$1773	\$2441	\$2557	N.A.	N.A.	\$2595	\$3125
36" diameter	15"		COWO_RND36	\$1802	\$1843	\$2521	\$2695	\$3918	\$4093	\$2712	\$3421
42" diameter	15"		COWO_RND42	\$1861	\$1919	\$2605	\$2838	\$4410	\$4643	\$2831	\$3716
48" diameter	15"		COWO_RND48	\$1980	\$2056	\$2772	\$3034	\$4751	\$5014	\$2948	\$4012
Large Round											
60" diameter	15"		COWO_RND60	\$3013	\$3120	\$4246	\$4628	\$7216	\$7574	\$6395	\$7636
Square											
30"	30"	15"	COWO_SQ30	\$1802	\$1832	\$2521	\$2637	N.A.	N.A.	\$2712	\$3421
36"	36"	15"	COWO_SQ36	\$1861	\$1902	\$2605	\$2779	N.A.	N.A.	\$2831	\$3716
42"	42"	15"	COWO_SQ42	\$1980	\$2038	\$2772	\$3005	N.A.	N.A.	\$2948	\$4012
Large Square											
60"	60"	15"	COWO_SQ60	\$3102	\$3211	\$4366	\$4759	N.A.	N.A.	\$6574	\$7993
Super-Square											
45½"	45½"	15"	COWO_SSQ45	\$2068	\$2144	\$2889	\$3151	\$4868	\$5113	\$3125	\$4307

 **For Canadian Pricing**
 Multiply U.S. Price by the Canadian price factor.
 ▶ See page 1 for details.

Switch

DESIGN EOOS DESIGN ORIGIN: GERMANY

Tip: Interport power/data module is not available on Switch.

Standard Includes	Required to Specify
-------------------	---------------------

- Base: satin silver plated tubing
- Trivalent satin chrome finish
- Glass top: 5/8" thick, green tinted glass tops have radiused corners
- Adjustable glides

Style number

Specification Information

Dimensions			Style	U.S. Price
D	W	H	Number	Top Surface: Glass

Square

24 3/8"	24 3/8"	15"	39-2424	\$1843
---------	---------	-----	---------	--------

Rectangle

24 3/8"	43 1/4"	15"	39-2442	\$2269
---------	---------	-----	---------	--------

Square

36"	36"	15"	39-3636	\$2444
-----	-----	-----	---------	--------

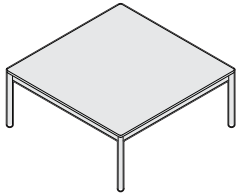
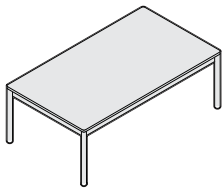
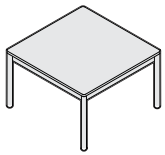

For Canadian Pricing
 Multiply U.S. Price by the
 Canadian price factor.
 ▶ See page 1 for details.

TeamWork Satellite Table

Satellite table provides a personal worksurface adjacent to seating and primary or nesting-height worksurfaces.

Top has a laminate or wood veneer surface with a matching edge.

Legs are finished with paint.

Glides are black.

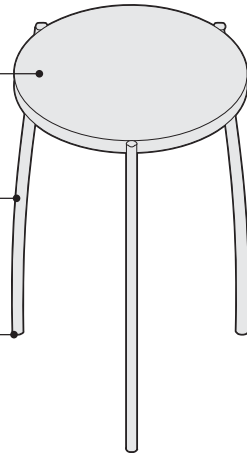

Product Details

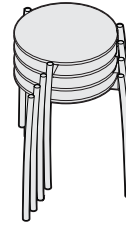

Tables stack up to four high.

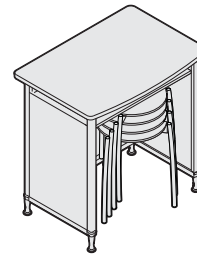

Height of table allows it to stow beneath other worksurfaces or Detour station garage.

Connections

Satellite table is fully assembled.

Surface Materials

Top and edge

- Laminate (Grade 1 or Grade 2)
- Wood veneer
- Custom wood finish (option on wood)

Legs

- Paint

Glides

- Black plastic only

Designer

Metro Design Group | San Francisco and Brian Kenneth Graham with the Gensler Product Design Group

Actual Dimensions

Top diameter	17"
Width of base	19"
Height	25"
Thickness	1/2"

TeamWork Satellite Table



Standard Includes		Required to Specify
<ul style="list-style-type: none"> ▶ Need help? Product details, page 387 	<ul style="list-style-type: none"> • Top: laminate (Grade 1) or wood veneer • Legs: paint • Glides: black plastic only 	<ol style="list-style-type: none"> 1 Style number 2 Laminate or wood color number for top 3 Paint color number for legs 4 Options, if selected (see below) <ul style="list-style-type: none"> ▶ See <i>Coalesse Surface Materials Reference Guide</i>.

Options	U.S. Price	Required to Specify
Surface Materials <ul style="list-style-type: none"> • Custom wood finish 	Wood	<ul style="list-style-type: none"> ▶ See <i>Coalesse Surface Materials Reference Guide</i>.

Specification Information						
Dimensions		Style Number	U.S. Prices			
Dia.	H		Lam 1	Lam 2	Wood 1	Wood 2
17"	25"	TW19004	\$675	\$705	\$819	\$1000



For Canadian Pricing
 Multiply U.S. Price by the Canadian price factor.
 ▶ See page 1 for details.

Coalesse

TeamWork

Satellite Table

Trees

DESIGN NORMAN DIEKMAN DESIGN ORIGIN: UNITED STATES

Tip: Interport power/data module is not available on Trees.

Tip: Tops come in the same wood and finish but with smooth surface.

Standard Includes	Required to Specify
<ul style="list-style-type: none"> Stainless steel is constructed of parts that are laser-cut and all seams are welded using jigs and fixtures to ensure precision <ul style="list-style-type: none"> - Base: powder coated carbon steel - Adjustable glides for leveling - Units are sanded and polished smooth to a standard metal finish - No top coat is used or needed - Glides: height adjustable Embossed Wood is created under high pressure to add dimensionality and texture on all sides of the table <ul style="list-style-type: none"> - Interior frame is constructed from a combination of engineered lumber and hardwood veneers - Embossed hardwood veneer is applied to all vertical and slanted surfaces Hand Polished, High Gloss Paint: Hard maple veneer is applied to form the face of the frame and top <ul style="list-style-type: none"> - All exposed wood surfaces are inspected and thoroughly hand sanded prior to the application of finish material - Coating is a tough, pigmented, two-component polyurethane. Once cured, coating is hand-polished to a high gloss. Specify blue or yellow. SensiTile is a terrazzo material with a matrix of fiber optic "lightpipes" <ul style="list-style-type: none"> - Changes in light and shadow are transmitted through the optics to create a responsive, shimmering light effect - Surface will require periodic care, and blemishes are natural occurrences in terrazzo - Unit is coated in wax: Black 	<ol style="list-style-type: none"> Style number Top color number Frame finish Options, if selected (see below) <p>► See <i>Coalesse Surface Materials Reference Guide</i>.</p>

Options	U.S. Price	Required to Specify
Surface Materials <ul style="list-style-type: none"> Bevel high embossed wood (Model 70-C-TPM) available in medium brown Bevel medium embossed wood (Model 70-D-TPM) available in medium brown 	+\$69 +\$69	Specify with <i>medium brown</i> . Specify with <i>medium brown</i> .

Specification Information

Dimensions	Style	U.S.
D W H	Number	Base Price

Curve High–Stainless Steel

15½"	14"	23"	70-A-SMM	\$3043
------	-----	-----	----------	--------

Bevel High–Embossed Wood

15½"	14"	23"	70-C-TPM	\$2326
------	-----	-----	----------	--------

Bevel Medium–Embossed Wood

15½"	14"	19¾"	70-D-TPM	\$2265
------	-----	------	----------	--------

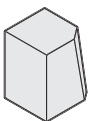
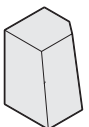
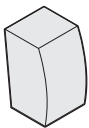

Interport Power Module for Occasional Tables

New York City Approved.
Calendar #43897

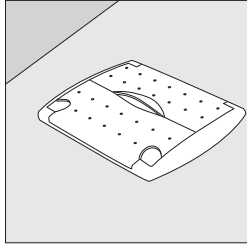

Closed: Power and data ports and cords are neatly hidden away but ready to be accessed with an easy flip of the top.

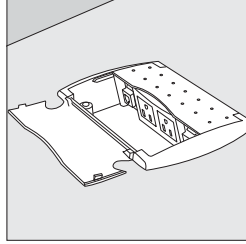

Half Open: Exposes power and data ports. Power available. Data available. Overall dimensions are: 7W x 5D x 2H opened.

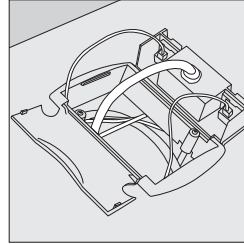

Completely Open / Inside: Reveals coiled power and data cords contained within caddy.

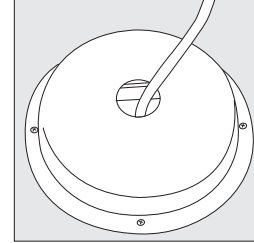

Bottom: Power and data cords exit through hole in the bottom of the caddy.

Available Models: Options: Interport is not available on all Coalesse models. Check grid for model availability.

Table	Model	Centered
Avon	192020F	Yes
	192020W	Yes
	192030F	Yes
	193636F	Yes
	192448F	N.A.
	212020W	Yes
	213030F	Yes
Ginger	37-1818H	Yes
	37-18RDH	Yes
	37-1943EL	N.A.
	37-2424H	Yes
	37-2424L	Yes
	37-24RDH	Yes
	37-24RDL	Yes
	37-31RDL	Yes
Passerelle	440-T242417	Yes
	440-T242421	Yes
	440-T164830	N.A.

Specify color: Silver Mica
Matte Black Nickel Mica
Charcoal Mica Translucent

®Trademark of Byrne Electrical, Rockford, Michigan

Indoor/Outdoor Seating



Emu Advanced Collection

Product Weights	394
Emu Heaven	396
Emu Ivy	402
Emu Pattern	405
Emu Re-Trouvé	408
Emu Round	410
Emu Dolly	413

Emu Advanced Collection Product Weights

Product Weights		Style Number	Product Weights Per Item (Pounds)
Emu Heaven Seating			
CO2485	16	CO2472	44
CO2486	18 ³ / ₄	CO2471	48 ¹ / ₂
CO2487	25	CO2473	60
CO2495	8	CO2470	50 ³ / ₄
CO2495V	6 ¹ / ₂	CO2474	92 ¹ / ₄
CO2498	45	CO2475	51 ³ / ₄
CO2497	51 ¹ / ₄	CO2477	25 ³ / ₄
Emu Heaven Tables			
CO2493	16		
CO2494	29		
CO2499	29		
CO2496	17		
CO2493V	16 ¹ / ₂		
CO2494V	49 ¹ / ₂		
CO2499V	58 ¹ / ₄		
Emu Ivy Seating			
CO2581	14 ¹ / ₄		
CO2582	16 ¹ / ₄		
CO2585	35 ³ / ₄		
CO2586	55 ¹ / ₂		
CO2595	18 ¹ / ₄		
Emu Ivy Tables			
CO2589	31 ¹ / ₄		
CO2591	83 ³ / ₄		
CO2592	172		
CO2593	159 ¹ / ₄		
CO2596	46 ¹ / ₄		
CO2597	63 ³ / ₄		
Emu Pattern Seating			
CO2510	16		
CO2511	17 ¹ / ₂		
CO2512	27 ³ / ₄		
Emu Pattern Tables			
CO2518	31 ¹ / ₄		
CO2519	41 ³ / ₄		
CO2520	52 ¹ / ₂		
Emu Re-Trouvé Seating			
CO2565MB	16		
CO2566HB	19 ¹ / ₂		
CO2575	11		
CO2578	16 ¹ / ₄		
CO2577	20 ³ / ₄		
CO2580	33		
Emu Round Seating			
CO2467	14 ¹ / ₂		
CO2465	12 ¹ / ₂		
CO2466	15 ¹ / ₄		
CO2469	20 ³ / ₄		

Coalesse

Emu Advanced Collection

Product Weights

Indoor/Outdoor Seating

Emu Advanced Collection Emu Heaven – Seating

DESIGN JEAN-MARIE MASSAUD

Tip: All chairs can stack four high.

Tip: COM outdoor fabric must be an approved outdoor fabric.

Standard Includes	Required to Specify
-------------------	---------------------

- Frame: hand crafted woven steel mesh
- Finish: outdoor grade powder coat paint
- Glides: nylon
- Cushions: fabric

- 1 Style number
 - 2 Powder coat color for frame
 - 3 Fabric color number for upholstery on cushions, if selected
 - 4 Options, if selected (see below)
- ▶ See *Coalesse Surface Materials Reference Guide*.

Options	U.S. Price	Required to Specify
---------	------------	---------------------

Surface Materials	Acrylic backer <ul style="list-style-type: none"> • Indoor chair cushions +\$12 • Indoor chair back cushions +\$10 • Indoor lounge back cushions +\$22 • Indoor pouf and pillow cushions +\$ 6 	
--------------------------	---	--

Specify with acrylic backer.
Specify with acrylic backer.
Specify with acrylic backer.
Specify with acrylic backer.
▶ See *Coalesse Surface Materials Reference Guide*.

Specification Information					
Dimensions			Style Number	Quantity	U.S. Base Price
D	W	H			

Chair

23¼"	24½"	31"	CO2485	2	\$1181
------	------	-----	--------	---	--------



Seat height: 17¾"
Seat depth: 16⅞"

Arm Chair

24"	27¼"	31"	CO2486	2	\$1355
-----	------	-----	--------	---	--------



Seat height: 17¾"
Seat depth: 16⅞"
Arm height: 26¾"

Lounge Chair

30¾"	37"	27¼"	CO2487	2	\$2271
------	-----	------	--------	---	--------

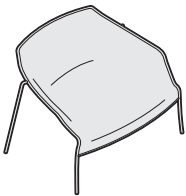

Seat height: 13¾"
Seat depth: 18½"
Arm height: 20½"

▶ Specification Information, continued on next page



For Canadian Pricing
Multiply U.S. Price by the Canadian price factor.
▶ See page 1 for details.

Emu Advanced Collection Emu Heaven – Seating

DESIGN JEAN-MARIE MASSAUD

Tip: All cushions come in quantity of one.

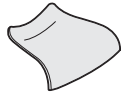

20¾" D x 14½" W x 19" W x ¾" H



20¾" D x 23¾" W x ¾" H



Overall: ¾" D x 22" W x 15½" H

Tip: If a back cushion is specified, a seat cushion must also be specified. The back cushion is not functional without the seat cushion.

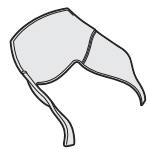

Overall: ¾" D x 28" W x 17½" H

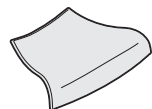

Overall: ¾" D x 34" W x 25" H

Tip: If a back cushion is specified, a seat cushion must also be specified. The back cushion is not functional without the seat cushion.

► Specification Information, continued from previous page

Specification Information

Style Number	U.S. Base Prices											Leather Grades:		
	Fabric Grades:											COL	C	E
	COM	6	7	8	9	10	11	12	13	14				

Chair Cushions

Outdoor Cushion

CO2485C	\$266	\$252	N.A.	N.A.	\$290	N.A.	N.A.	N.A.	N.A.	N.A.	N.A.	N.A.	N.A.
---------	-------	-------	------	------	-------	------	------	------	------	------	------	------	------

Indoor Cushion

CO2485B	\$266	\$252	\$257	\$265	\$290	\$307	\$326	\$339	\$363	\$396	\$383	\$ 601	\$ 647
---------	-------	-------	-------	-------	-------	-------	-------	-------	-------	-------	-------	--------	--------

COM/yds = ¾, COL/sq ft = 14

Arm Chair Cushions

Outdoor Cushion

CO2486C	\$272	\$266	N.A.	N.A.	\$318	N.A.	N.A.	N.A.	N.A.	N.A.	N.A.	N.A.	N.A.
---------	-------	-------	------	------	-------	------	------	------	------	------	------	------	------

Indoor Cushion

CO2486B	\$272	\$266	\$273	\$284	\$318	\$340	\$365	\$383	\$414	\$458	\$389	\$ 682	\$ 742
---------	-------	-------	-------	-------	-------	-------	-------	-------	-------	-------	-------	--------	--------

COM/yds = 1, COL/sq ft = 18

Chair Back Cushions

Outdoor Cushion

CO2480C	\$337	\$337	N.A.	N.A.	\$401	N.A.	N.A.	N.A.	N.A.	N.A.	N.A.	N.A.	N.A.
---------	-------	-------	------	------	-------	------	------	------	------	------	------	------	------

Indoor Cushion

CO2480B	\$337	\$337	\$345	\$359	\$401	\$429	\$461	\$483	\$522	\$577	\$451	\$ 924	\$1016
---------	-------	-------	-------	-------	-------	-------	-------	-------	-------	-------	-------	--------	--------

COM/yds = 1¼, COL/sq ft = 28

Arm Chair Back Cushions

Outdoor Cushion

CO2481C	\$350	\$350	N.A.	N.A.	\$428	N.A.	N.A.	N.A.	N.A.	N.A.	N.A.	N.A.	N.A.
---------	-------	-------	------	------	-------	------	------	------	------	------	------	------	------

Indoor Cushion

CO2481B	\$350	\$350	\$360	\$377	\$428	\$461	\$499	\$526	\$573	\$638	\$456	\$1032	\$1142
---------	-------	-------	-------	-------	-------	-------	-------	-------	-------	-------	-------	--------	--------

COM/yds = 1½, COL/sq ft = 33

Lounge Cushions

Outdoor Cushion

CO2487C	\$355	\$355	N.A.	N.A.	\$433	N.A.	N.A.	N.A.	N.A.	N.A.	N.A.	N.A.	N.A.
---------	-------	-------	------	------	-------	------	------	------	------	------	------	------	------

Indoor Cushion

CO2487B	\$355	\$355	\$365	\$382	\$433	\$466	\$504	\$531	\$578	\$643	\$461	\$1037	\$1147
---------	-------	-------	-------	-------	-------	-------	-------	-------	-------	-------	-------	--------	--------

COM/yds = 1½, COL/sq ft = 33

► Specification Information, continued on next page

Emu Advanced Collection Emu Heaven – Seating *continued*

DESIGN JEAN-MARIE MASSAUD

► Specification Information, continued from previous page

Specification Information

Style Number	U.S. Base Prices											Leather Grades:		
	Fabric Grades:											COL	C	E
COM	6	7	8	9	10	11	12	13	14					

Lounge Back Cushions

Outdoor Cushion

CO2489C	\$464	\$464	N.A.	N.A.	\$593	N.A.	N.A.	N.A.	N.A.	N.A.	N.A.	N.A.	N.A.
---------	-------	-------	------	------	-------	------	------	------	------	------	------	------	------

Indoor Cushion

CO2489B	\$464	\$464	\$480	\$508	\$593	\$648	\$711	\$756	\$834	\$943	\$535	\$1526	\$1708
---------	-------	-------	-------	-------	-------	-------	-------	-------	-------	-------	-------	--------	--------

COM/yds = 2½, COL/sq ft = 55

Lounge Pillows

Outdoor Pillow

CO2488C	\$201	\$187	N.A.	N.A.	\$225	N.A.	N.A.	N.A.	N.A.	N.A.	N.A.	N.A.	N.A.
---------	-------	-------	------	------	-------	------	------	------	------	------	------	------	------

Indoor Pillow

CO2488B	\$201	\$187	\$192	\$200	\$225	\$242	\$261	\$274	\$298	\$331	\$318	\$583	\$638
---------	-------	-------	-------	-------	-------	-------	-------	-------	-------	-------	-------	-------	-------

COM/yds = ¾, COL/sq ft = 17

Specification Information

Dimensions	Style	Quantity	U.S.
Dia.	H	Number	Base Price

Pouf/Side Table Base

17¾"	18½"	CO2495	1	\$509
------	------	--------	---	-------

Glass Top for use with Pouf

17¾"	CO2495V	1	\$237
------	---------	---	-------

Specification Information

Style Number	U.S. Base Prices											Leather Grades:		
	Fabric Grades:											COL	C	E
COM	6	7	8	9	10	11	12	13	14					

Pouf Cushions

Outdoor Cushion

CO2495C	\$195	\$181	N.A.	N.A.	\$219	N.A.	N.A.	N.A.	N.A.	N.A.	N.A.	N.A.	N.A.
---------	-------	-------	------	------	-------	------	------	------	------	------	------	------	------

Indoor Cushion

CO2495B	\$195	\$181	\$186	\$194	\$219	\$236	\$255	\$268	\$292	\$325	\$312	\$577	\$632
---------	-------	-------	-------	-------	-------	-------	-------	-------	-------	-------	-------	-------	-------

COM/yds = ¾, COL/sq ft = 14

► Specification Information, continued on next page

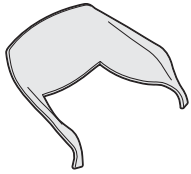

Overall: ¾"D x 34"W x 17½"H



Overall: 4¼"D x 17¼"W x 10½"H

Tip: Lounge pillow is for use with Heaven and Round Lounge chairs.



Tip: CO2495 pouf must be ordered with glass or cushion top, specified separately.

Tip: Cushions come in quantity of one.



18"Dia. x 2"H



For Canadian Pricing
Multiply U.S. Price by the Canadian price factor.
► See page 1 for details.

Emu Advanced Collection Emu Heaven – Seating

DESIGN JEAN-MARIE MASSAUD

► Specification Information, continued from previous page

Vases

Planter insert dimensions:
 Low: 36"H x 13½"Dia
 High: 33"H x 13½"Dia

Standard Includes	Required to Specify
-------------------	---------------------

- Vase: handcrafted woven steel mesh
- Finish: 4254 White outdoor grade powder coat paint
- Planter insert: white plastic

Style number

Specification Information			
---------------------------	--	--	--

Dimensions	Style	U.S.	
Dia.	H	Number	Price

Low Vase

23½"	40½"	CO2498	\$1650
------	------	--------	--------

High Vase

26¾"	64¼"	CO2497	\$2325
------	------	--------	--------

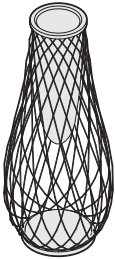
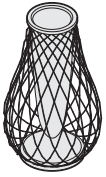

For Canadian Pricing
 Multiply U.S. Price by the
 Canadian price factor.
 ► See page 1 for details.

Emu Advanced Collection Emu Heaven – Tables

DESIGN JEAN-MARIE MASSAUD

Tip: Tables require glass top, specified separately.

Standard Includes	Required to Specify
<ul style="list-style-type: none"> • Frame: interwoven steel rods • Finish: outdoor grade powder coat paint • Glides: nylon • Top: tempered glass 	<ol style="list-style-type: none"> 1 Style number 2 Powder coat color for base 3 Glass top color number for glass top <p>▶ See <i>Coalesse Surface Materials Reference Guide</i>.</p>

Specification Information

Dimensions	Style	U.S.
Dia. H	Number	Price

Round Table Bases

For use with 31½" CO2493V Glass Top Below

27½"	29½"	CO2493	\$1115
------	------	--------	--------

For use with 47¼" CO2494V Glass Top Below

43⅓"	29½"	CO2494	\$2301
------	------	--------	--------

For use with 51" CO2499V Glass Top Below

43⅓"	29½"	CO2499	\$2589
------	------	--------	--------

Low Table Base

43⅓"	15¼"	CO2496	\$1729
------	------	--------	--------

Glass Tops

For use with 27½" CO2493 Round Table Base

31½"	¼"	CO2493V	\$ 430
------	----	---------	--------

For use with 43⅓" CO2494 Round or CO2496 Low Table Base

47¼"	¼"	CO2494V	\$ 653
------	----	---------	--------

For use with 43⅓" CO2499 Round Base

51"	¼"	CO2499V	\$ 825
-----	----	---------	--------



Top of base: 27½" Diameter
Bottom of base: 17¾" Diameter

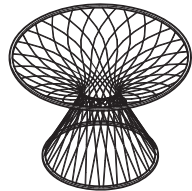

Top of base: 43⅓" Diameter
Bottom of base: 27½" Diameter

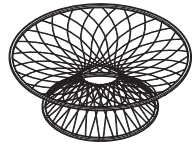

Top of base: 43⅓" Diameter
Bottom of base: 27½" Diameter

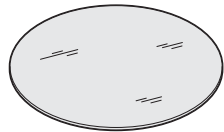
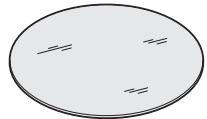

For Canadian Pricing
Multiply U.S. Price by the
Canadian price factor.
▶ See page 1 for details.

Coalesse

Emu Advanced Collection

Emu Heaven – Tables

DESIGN JEAN-MARIE MASSAUD

Emu Advanced Collection Emu Ivy – Seating

DESIGN PAOLA NAVONE

Tip: COM outdoor fabric must be an approved outdoor fabric.

Tip: Cushions must be specified separately.

Tip: Side chair without arms stacks ten high. Side chair with arms stacks eight high.

Standard Includes	Required to Specify
-------------------	---------------------

- Frame: steel mesh and rod
- Finish: outdoor grade powder coat paint
- Glides: nylon
- Cushions: fabric

- 1 Style number
 - 2 Fabric color number for upholstery on cushions, if selected
 - 3 Options, if selected (see below)
- ▶ See *Coalesse Surface Materials Reference Guide*.

Surface Materials	Options	U.S. Price	Required to Specify
-------------------	---------	------------	---------------------

- | | | | |
|-------------------|--------------------------------------|------|--|
| Surface Materials | Acrylic backer | | |
| | • Indoor arm chair and side cushions | +\$6 | |
| | • Indoor sofa cushions | +\$8 | |

Specify with acrylic backer.

Specify with acrylic backer.

▶ See *Coalesse Surface Materials Reference Guide*.

Specification Information					
Dimensions			Style	Quantity	U.S. Base Price
D	W	H	Number		

Side Chair without Arms

22½"	20½"	31"	C02581	4	\$1875
------	------	-----	--------	---	--------



Seat height: 17¾"

Side Chair with Arms

22½"	22¾"	31"	C02582	4	\$2057
------	------	-----	--------	---	--------



Seat height: 17¾"
Arm height: 26"

Arm Chair

35½"	43¼"	26"	C02585	1	\$2909
------	------	-----	--------	---	--------

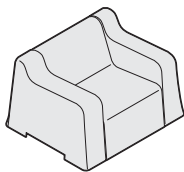

Seat height: 14½"
Seat depth: 21¼"
Arm height: 22½"

Sofa

35½"	75½"	26"	C02586	1	\$4608
------	------	-----	--------	---	--------

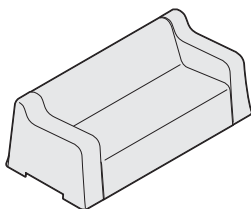

Seat height: 14½"
Seat depth: 21¼"
Arm height: 22½"

▶ Specification Information, continued on next page

Emu Advanced Collection Emu Ivy – Seating

DESIGN PAOLA NAVONE

► Specification Information, continued from previous page

Specification Information

Dimensions			Style Number	Quantity	U.S. Base Price
D	W	H			

Pouf

20¾" Dia.	15¾"	CO2595	1	\$1020
-----------	------	--------	---	--------



Tip: Pouf has solid sheet metal top with a photovoltaic panel filled with five LED lights. LED lights collect and store solar energy to illuminate the under structure at night.

Tip: Pouf handle is always orange.

Tip: Cushions come in quantity of one.

Specification Information

Style Number	U.S. Base Prices											Leather Grades:		
	Fabric Grades:											COL	C	E
COM	6	7	8	9	10	11	12	13	14					

Arm Chair Cushions

Outdoor Cushion

CO2585C	\$ 475	\$ 475	N.A.	N.A.	\$ 565	N.A.	N.A.	N.A.	N.A.	N.A.	N.A.	N.A.	N.A.
---------	--------	--------	------	------	--------	------	------	------	------	------	------	------	------

Indoor Cushion

CO2585B	\$ 475	\$ 475	\$ 486	\$ 506	\$ 565	\$ 604	\$ 648	\$ 679	\$ 734	\$ 811	\$ 572	\$1356	\$1502
---------	--------	--------	--------	--------	--------	--------	--------	--------	--------	--------	--------	--------	--------

COM/yds = 1¾, COL/sq ft = 32

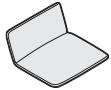

21"D x 24¼"W x 12½"H

Sofa Cushions

Outdoor Cushion

CO2586C	\$1002	\$1002	N.A.	N.A.	\$1144	N.A.	N.A.	N.A.	N.A.	N.A.	N.A.	N.A.	N.A.
---------	--------	--------	------	------	--------	------	------	------	------	------	------	------	------

Indoor Cushion

CO2586B	\$1002	\$1002	\$1020	\$1051	\$1144	\$1205	\$1275	\$1323	\$1410	\$1530	\$1065	\$3093	\$3459
---------	--------	--------	--------	--------	--------	--------	--------	--------	--------	--------	--------	--------	--------

COM/yds = 2¾, COL/sq ft = 50

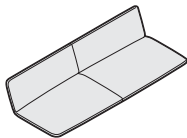

21"D x 56"W x 12½"H

Tip: Sofa cushion is two pieces.

Side Chair Cushions

Outdoor Cushion

CO2581C	\$ 288	\$ 282	N.A.	N.A.	\$ 334	N.A.	N.A.	N.A.	N.A.	N.A.	N.A.	N.A.	N.A.
---------	--------	--------	------	------	--------	------	------	------	------	------	------	------	------

Indoor Cushion

CO2581B	\$ 288	\$ 282	\$ 289	\$ 300	\$ 334	\$ 356	\$ 381	\$ 399	\$ 430	\$ 474	\$ 405	\$ 623	\$ 669
---------	--------	--------	--------	--------	--------	--------	--------	--------	--------	--------	--------	--------	--------



15"D x 15"W x ¾"H



For Canadian Pricing
Multiply U.S. Price by the Canadian price factor.

► See page 1 for details.

Emu Advanced Collection Emu Ivy – Tables

DESIGN PAOLA NAVONE

Tip: Tiles ship unattached. Six of the thirty-two tiles have design specified to allow for table top customization.

Tip: CO2592 contains a steel tube across the underneath of the top, ensuring top stability and structure.

Standard Includes	Required to Specify
-------------------	---------------------

<ul style="list-style-type: none"> Top: solid sheet metal Rectangle and square side tables finish: outdoor grade powder coat paint, if selected Rectangular and square table finish: outdoor grade white powder coat paint, if selected Legs: steel mesh and rod Glides: nylon 	<ul style="list-style-type: none"> 1 Style number 2 Powder coat color for side tables, if selected 3 Options, if selected (see below) <p>▶ See <i>Coalesse Surface Materials Reference Guide</i>.</p>
---	--

Options	U.S. Price	Required to Specify
---------	------------	---------------------

Surface Materials <ul style="list-style-type: none"> Blue fish tile White bug tile 	<ul style="list-style-type: none"> +\$916 +\$916 	<ul style="list-style-type: none"> Specify with fish tile. Specify with bug tile.
---	--	---

Specification Information				
Dimensions			Style	U.S.
D	W	H	Number	Base Price

Rectangular Side Table

29¼"	53¼"	11¾"	CO2589	\$1791
------	------	------	--------	--------

Square Side Table

47¼"	47¼"	12½"	CO2591	\$2870
------	------	------	--------	--------

Rectangular Metal Top Table

44¾"	107¾"	29½"	CO2592	\$3984
------	-------	------	--------	--------

Rectangular Teak Top Table

44¾"	107¾"	29½"	CO2593	\$6191
------	-------	------	--------	--------

Square Tables

23½"	23½"	29½"	CO2596	\$1093
------	------	------	--------	--------

31½"	31½"	29½"	CO2597	\$1214
------	------	------	--------	--------

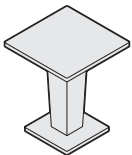
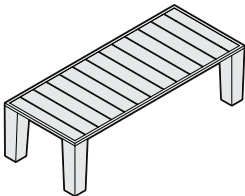
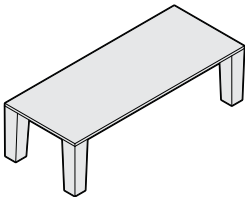
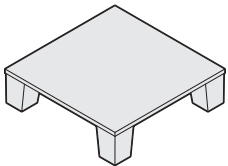
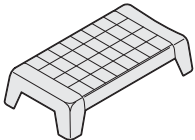

For Canadian Pricing
 Multiply U.S. Price by the Canadian price factor.
 ▶ See page 1 for details.

Emu Advanced Collection Emu Pattern – Seating

DESIGN ARIK LEVY

Tip: Legs will match frame finish.

Tip: Side chair stacks two high.

Standard Includes	Required to Specify
-------------------	---------------------

- Painted frames: single sheet of molded steel
- Painted steel legs: painted aluminum base, to match frame
- Finish: outdoor grade powder coat paint
- Glides: nylon

- 1 Style number
- 2 Powder coat color number for frame
- ▶ See *Coalesse Surface Materials Reference Guide*.

Specification Information					
---------------------------	--	--	--	--	--

Dimensions			Style Number	Quantity	U.S. Price
D	W	H			

Arm Chair

22"	24"	33½"	CO2511	2	\$1116
-----	-----	------	--------	---	--------



Seat height: 18"
Seat depth: 16½"

Armless Chair

22"	24"	33½"	CO2510	2	\$1026
-----	-----	------	--------	---	--------



Seat height: 18"
Seat depth: 16½"

57"W Rectangular Bench

15¾"	57½"	17¾"	CO2512	1	\$1027
------	------	------	--------	---	--------

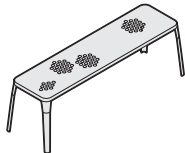

For Canadian Pricing
Multiply U.S. Price by the Canadian price factor.
▶ See page 1 for details.

Emu Advanced Collection Emu Pattern – Tables

DESIGN ARIK LEVY

Tip: Legs will be painted to match table.

Standard Includes	Required to Specify
<ul style="list-style-type: none"> • Painted table: single sheet of molded steel • Painted steel legs: painted to match table • Finish: outdoor grade powder coat paint • Glides: nylon 	1 Style number 2 Powder coat color number for table ▶ See <i>Coalesse Surface Materials Reference Guide</i> .

Specification Information

Dimensions	Style	U.S.
Dia. H	Number	Price

Small Round Table			
31½"	29½"	C02518	\$ 829

Large Round Table			
46"	29½"	C02520	\$1284

Specification Information

Dimensions			Style	U.S.
D	W	H	Number	Price

Square Table				
34¼"	34¼"	29½"	C02519	\$1171

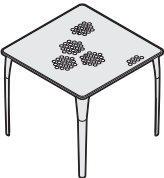
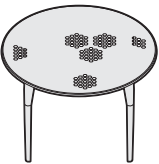

For Canadian Pricing
 Multiply U.S. Price by the
 Canadian price factor.
 ▶ See page 1 for details.

Coalesse

Emu Advanced Collection

Emu Pattern – Tables

DESIGN ARIK LEVY

Indoor/Outdoor Seating

Emu Advanced Collection Emu Re-Trouvé – Seating

DESIGN PATRICIA URQUIOLA

Tip: COM outdoor fabric must be an approved outdoor fabric.

Tip: Cushions must be specified separately.

Standard Includes	Required to Specify
<ul style="list-style-type: none"> • Frame: hot-dipped steel rod, hand welded • Finish: outdoor grade powder coat paint • Seat: steel tube and ironed sheet metal • Glides: PVC • Cushions: fabric 	<ol style="list-style-type: none"> 1 Style number 2 Powder coat color for frame 3 Fabric color number for upholstery on cushions, if selected 4 Options, if selected (see below) <p>▶ See <i>Coalesse Surface Materials Reference Guide</i>.</p>

Options	U.S. Price	Required to Specify
Surface Materials Acrylic backer <ul style="list-style-type: none"> • Indoor chair seat and pouf cushions • Chair seat and back indoor cushions 	+\$ 8 +\$12	Specify with acrylic backer. Specify with acrylic backer. ▶ See <i>Coalesse Surface Materials Reference Guide</i> .

Specification Information

Dimensions			Style	U.S.
D	W	H	Number	Base Price

Midback Chair				
23½"	26"	30¾"	CO2565MB	\$1253



Seat height: 17¾"

Highback Chair				
24"	30"	41¼"	CO2566HB	\$1481



Seat height: 17¾"

Pouf			
17¾" dia.	17¾"	CO2575	\$ 811



Tip: Cushions fit all chairs. Pouf requires seat cushion only.

Tip: Cushions come in quantity of one.

Specification Information

Style Number	U.S. Base Prices													Leather Grades:		
	Fabric Grades:													COL	C	E
COM	6	7	8	9	10	11	12	13	14							

Chair Seat and Pouf Cushions

Outdoor Cushion													
CO2575C	\$235	\$229	N.A.	N.A.	\$281	N.A.	N.A.	N.A.	N.A.	N.A.	N.A.	N.A.	N.A.
Indoor Cushion													
CO2575B	\$235	\$229	\$236	\$247	\$281	\$303	\$328	\$346	\$377	\$421	\$352	\$721	\$794

COM/yds = 1, COL/sq ft = 18
 ▶ Specification Information, continued on next page



18½" Dia. x 2¼"H



For Canadian Pricing
 Multiply U.S. Price by the Canadian price factor.
 ▶ See page 1 for details.

Emu Advanced Collection Emu Re-Trouvé – Seating

DESIGN PATRICIA URQUIOLA

► Specification Information, continued from previous page

Specification Information

Style Number	U.S. Base Prices											Leather Grades:		
	Fabric Grades:											COL	C	E
COM	6	7	8	9	10	11	12	13	14					



20"D x 20½"W x 10"H

Chair Seat and Back Cushions

Outdoor Cushion

CO2566C	\$423	\$423	N.A.	N.A.	\$487	N.A.	N.A.	N.A.	N.A.	N.A.	N.A.	N.A.	N.A.
---------	-------	-------	------	------	-------	------	------	------	------	------	------	------	------

Indoor Cushion

CO2566B	\$423	\$423	\$431	\$445	\$487	\$515	\$547	\$569	\$608	\$663	\$537	\$1217	\$1345
---------	-------	-------	-------	-------	-------	-------	-------	-------	-------	-------	-------	--------	--------

COM/yds = 1¼, COL/sq ft = 27

Vase Frames and Vase Insert

Standard Includes

- Frame: hot-dipped steel rod, hand welded
- Finish: outdoor grade white powder coat paint only
- Vase insert, if selected: white ceramic

Required to Specify

Style number

Specification Information

Dimensions	Style	U.S.
Dia. H	Number	Price

Low Vase Frame

25½"	28"	CO2578	\$1611
------	-----	--------	--------

High Vase Frame

28¾"	41¼"	CO2577	\$2007
------	------	--------	--------

Vase Insert

24½"	14½"	CO2580	\$ 506
------	------	--------	--------

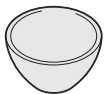

For Canadian Pricing
 Multiply U.S. Price by the
 Canadian price factor.
 ► See page 1 for details.

Emu Advanced Collection Emu Round – Seating

DESIGN CHRISTOPHE PILLET

Tip: Stool and lounge stacks four high. Chair stacks eight high.

Standard Includes	Required to Specify
<ul style="list-style-type: none"> • Frame: metal mesh seat, crafted using a deep drawing technique, welded to a tubular steel frame • Finish: outdoor grade powder coat paint • Glides: nylon 	1 Style number 2 Powder coat color for frame 3 Options, if selected (see below) ▶ See <i>Coalesse Surface Materials Reference Guide</i> .

Options	U.S. Price	Required to Specify
Surface Materials Acrylic backer <ul style="list-style-type: none"> • Backer for indoor stool cushions only • Backer for indoor chair cushions only • Backer for indoor lounge cushions only • Backer for indoor pillow cushions only 	+\$10 +\$12 +\$22 +\$ 6	Specify with acrylic backer. Specify with acrylic backer. Specify with acrylic backer. Specify with acrylic backer. ▶ See <i>Coalesse Surface Materials Reference Guide</i> .

Specification Information					
Dimensions			Style Number	Quantity	U.S. Base Price
D	W	H			

Stool					
20½"	22¾"	39¼"	CO2467	2	\$1209

Chair					
23¼"	24¾"	32"	CO2465	4	\$1545

Arm Chair					
23¼"	24¾"	32"	CO2466	4	\$1694

▶ Specification Information, continued on next page



Seat height: 28"



Seat height: 17¾"



Seat height: 17¾"
Arm height: 26"



For Canadian Pricing
 Multiply U.S. Price by the Canadian price factor.
 ▶ See page 1 for details.

Emu Advanced Collection Emu Round – Seating

DESIGN CHRISTOPHE PILLET

Tip: All cushions come in quantity of one.

Tip: Cushions are one piece with a slit to allow for water drainage.



Seat height: 15"
Seat depth: 22¹/₆"



Overall: 3¹/₄"D x 22"W x 28"H



Overall: 3¹/₄"D x 18"W x 22¹/₂"H

Tip: Chair cushion for use on chair and arm chair.

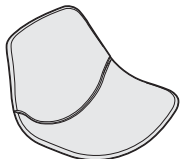

Overall: 3¹/₄"D x 34"W x 40"H



Overall: 4¹/₄"D x 17¹/₄"W x 10¹/₂"H

Tip: Lounge pillow is for use with Heaven and Round Lounge chairs.



For Canadian Pricing
Multiply U.S. Price by the Canadian price factor.

► See page 1 for details.

► Specification Information, continued from previous page

Specification Information

Dimensions			Style Number	Quantity	U.S. Base Price
D	W	H			

Lounge

34 ¹ / ₄ "	36 ¹ / ₄ "	33"	CO2469	2	\$1649
----------------------------------	----------------------------------	-----	--------	---	--------

Specification Information

Style Number	U.S. Prices												Leather Grades:		
	Fabric Grades:												COL	C	E
COM	6	7	8	9	10	11	12	13	14						

Stool Cushions

Outdoor Cushion

CO2467C	\$320	\$320	N.A.	N.A.	\$384	N.A.	N.A.	N.A.	N.A.	N.A.	N.A.	N.A.	N.A.	N.A.
---------	-------	-------	------	------	-------	------	------	------	------	------	------	------	------	------

Indoor Cushion

CO2467B	\$320	\$320	\$328	\$342	\$384	\$412	\$444	\$466	\$505	\$560	\$434	\$ 907	\$ 999
---------	-------	-------	-------	-------	-------	-------	-------	-------	-------	-------	-------	--------	--------

COM/yds = 1¹/₄, COL/sq ft = 28

Chair Cushions

Outdoor Cushion

CO2465C	\$333	\$333	N.A.	N.A.	\$411	N.A.	N.A.	N.A.	N.A.	N.A.	N.A.	N.A.	N.A.
---------	-------	-------	------	------	-------	------	------	------	------	------	------	------	------

Indoor Cushion

CO2465B	\$333	\$333	\$343	\$360	\$411	\$444	\$482	\$509	\$556	\$621	\$439	\$1015	\$1125
---------	-------	-------	-------	-------	-------	-------	-------	-------	-------	-------	-------	--------	--------

COM/yds = 1¹/₂, COL/sq ft = 33

Lounge Cushions and Pillows

Outdoor Cushion

CO2469C	\$460	\$460	N.A.	N.A.	\$589	N.A.	N.A.	N.A.	N.A.	N.A.	N.A.	N.A.	N.A.
---------	-------	-------	------	------	-------	------	------	------	------	------	------	------	------

Indoor Cushion

CO2469B	\$460	\$460	\$476	\$504	\$589	\$644	\$707	\$752	\$830	\$939	\$531	\$1522	\$1704
---------	-------	-------	-------	-------	-------	-------	-------	-------	-------	-------	-------	--------	--------

COM/yds = 2¹/₂, COL/sq ft = 55

Outdoor Pillow

CO2488C	\$201	\$187	N.A.	N.A.	\$225	N.A.	N.A.	N.A.	N.A.	N.A.	N.A.	N.A.	N.A.
---------	-------	-------	------	------	-------	------	------	------	------	------	------	------	------

Indoor Pillow

CO2488B	\$201	\$187	\$192	\$200	\$225	\$242	\$261	\$274	\$298	\$331	\$318	\$ 583	\$ 638
---------	-------	-------	-------	-------	-------	-------	-------	-------	-------	-------	-------	--------	--------

COM/yds = 3¹/₄, COL/sq ft = 17

Emu Advanced Collection Emu Round – Tables

DESIGN CHRISTOPHE PILLET

Standard Includes	Required to Specify
<ul style="list-style-type: none"> • Frame: table top and base are sheet metal with tubular steel mountings • Finish: outdoor grade powder coat paint • Glides: nylon 	1 Style number 2 Powder coat color for frame ▶ See <i>Coalesse Surface Materials Reference Guide</i> .

Specification Information

Dimensions			Style Number	U.S. Price
D	W	H		

Square Tables

23½"	23½"	29½"	CO2472	\$ 635
27½"	27½"	29½"	CO2471	\$ 749
31½"	31½"	29½"	CO2473	\$ 795

Round Table

35½" dia.		29½"	CO2470	\$ 849
-----------	--	------	--------	--------

Rectangle Table

31½"	47½"	29½"	CO2474	\$1239
------	------	------	--------	--------

Counter Table

23½"	23½"	41¼"	CO2475	\$ 766
------	------	------	--------	--------

Side Tables

31½"	31½"	16½"	CO2477	\$ 550
27½"	39¼"	16½"	CO2478	\$ 604

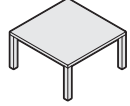
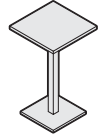
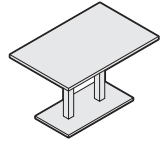
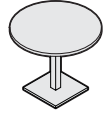
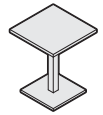

 **For Canadian Pricing**
 Multiply U.S. Price by the
 Canadian price factor.
 ▶ See page 1 for details.

Emu Advanced Collection Emu Dolly

DESIGN CHRISTOPHE PILLET

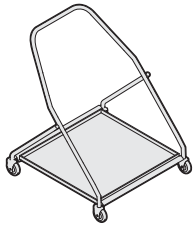

Tip: Dolly can be used with all styles of Emu stacking chairs.

Tip: Same quantity of chairs can be stacked on Dolly and floor. See individual product pages for stacking information.

Standard Includes	Required to Specify
-------------------	---------------------

- Dolly: steel

Style number

Specification Information				
Dimensions			Style	U.S.
D	W	H	Number	Price

29½"	34¼"	39¼"	CODOLLY017	\$900
------	------	------	------------	-------



For Canadian Pricing
 Multiply U.S. Price by the
 Canadian price factor.
 ▶ See page 1 for details.

Coalesse

Emu Advanced Collection

Resources

Style Number Index

416

Style Number Index

Style Number	Page	Description	Style Number	Page	Description
100-T1	344	Bob Round Occasional Table	126200S	299	Kart Nesting Chair
100-T2	344	Bob Round Occasional Table	126200SST	301	Kart Stool on Casters
100-T3	344	Bob Round Occasional Table	126200ST	301	Kart Stool on Casters
100-T4	344	Bob Round Occasional Table	126201	299	Kart Nesting Chair
105-T1	345	Bob Table	126201S	299	Kart Nesting Chair
105-T2	345	Bob Table	126201SST	301	Kart Stool on Casters
105-T3	345	Bob Table	126201ST	301	Kart Stool on Casters
105-T4	345	Bob Table	126211	303	Kart Stacking Chair w/Arms
1100TAL	139	Detour Lounge Chair	126211S	303	Kart Stacking Chair w/Arms
1100TAR	139	Detour Lounge Chair	126211SST	302	Kart Café Four-Leg Stool w/Arms
1101C	136	Detour Lounge Chair	126211ST	302	Kart Café Four-Leg Stool w/Arms
1101CAA	137	Detour Lounge Chair	126900	299	Kart Accessory
1101CAX	136	Detour Lounge Chair	127100J	306	Jury Base
1101CXA	137	Detour Lounge Chair	127101J	306	Jury Base
1101G	136	Detour Lounge Chair	127200J	306	Jury Base
1101GAA	137	Detour Lounge Chair	127200SJ	306	Jury Base
1101GAX	136	Detour Lounge Chair	127201J	306	Jury Base
1101GXA	137	Detour Lounge Chair	127201SJ	306	Jury Base
1102C	137	Detour Lounge Chair	128100J	307	Jury Base
1102CAA	137	Detour Lounge Chair	128101J	307	Jury Base
1102CAX	137	Detour Lounge Chair	128200J	307	Jury Base
1102CXA	137	Detour Lounge Chair	128200SJ	307	Jury Base
1102G	137	Detour Lounge Chair	128201J	307	Jury Base
1102GAA	137	Detour Lounge Chair	128201SJ	307	Jury Base
1102GAX	137	Detour Lounge Chair	14-20	144	Evaneau Two-Seat Sofa
1102GXA	137	Detour Lounge Chair	14-30	145	Evaneau Three-Seat Sofa
1103C	138	Detour Lounge Chair	14-6	145	Evaneau Round Back Cushion
1103CAA	138	Detour Lounge Chair	14-7	145	Evaneau Round Back Cushion
1103CAX	138	Detour Lounge Chair	14-A	145	Evaneau Arm Pillow
1103CXA	138	Detour Lounge Chair	14-B	145	Evaneau Arm Bolster
1103G	138	Detour Lounge Chair	14-C	144	Evaneau Chair
1103GAA	138	Detour Lounge Chair	14-HHR	145	Evaneau Ottoman
1103GAX	138	Detour Lounge Chair	14-HLR	145	Evaneau Ottoman
1103GXA	138	Detour Lounge Chair	1404M	320	Switch Counter-Height Stool
1104C	140	Detour Ottoman	1404PC	320	Switch Counter-Height Stool
1104G	140	Detour Ottoman	1405M	320	Switch Bar-Height Stool
112101	313	Rocky Four-Star Nesting Chair with Arms	1405PC	320	Switch Bar-Height Stool
112201	313	Rocky Four-Star Nesting Chair with Arms	1500M	318	Switch Guest Armless Chair
112201S	313	Rocky Four-Star Nesting Chair with Arms	1500PC	318	Switch Guest Armless Chair
112301	314	Rocky Five-Star Base Chair	1510M	318	Switch Guest Arm Chair
112301J	316	Jury Base	1510PC	318	Switch Guest Arm Chair
112301ST	315	Rocky Five-Star Base Stool	1519M	318	Switch Guest Lowback Sledbase
112401	314	Rocky Five-Star Base Chair	1519PC	318	Switch Guest Lowback Sledbase
112401J	316	Jury Base	1529M	319	Switch Guest Highback Sledbase
112401S	314	Rocky Five-Star Base Chair	1529PC	319	Switch Guest Highback Sledbase
112401SJ	316	Jury Base	1810M	270	Capa Chair
112401SST	315	Rocky Five-Star Base Stool	1810PC	270	Capa Chair
112401ST	315	Rocky Five-Star Base Stool	192020F	338	Avon Table
126100	298	Kart Nesting Chair	192020W	338	Avon Table
126100ST	300	Kart Stools on Casters	192030F	338	Avon Table
126101	298	Kart Nesting Chair	192448F	338	Avon Table
126101ST	300	Kart Stool on Casters	193636F	338	Avon Table
126111	303	Kart Stacking Chair w/Arms	212020W	339	Avon Table
126111ST	302	Kart Café Four-Leg Stool w/Arms	213030F	339	Avon Table
126200	299	Kart Nesting Chair	216	101	Bob Lounge Swivel Chair

Style Number Index

Style Number	Page	Description	Style Number	Page	Description
221	101	Bob Lounge Chair w/Headrest	37-2424LF	373	Ginger Square
221-H	101, 269	Bob Ottoman	37-2424LGL	373	Ginger Square
231	269	Bob Guest Chair	37-2424LGR	373	Ginger Square
240	234	Swathmore Chair Wood Leg	37-2424LW	373	Ginger Square
240-2	234	Swathmore 2 St Sofa Wood Leg	37-24RDHF	372	Ginger Round
240-3	234	Swathmore 3 St Sofa Wood Leg	37-24RDHGL	372	Ginger Round
241	235	Swathmore Chair Wood Base	37-24RDHGR	372	Ginger Round
241-2	235	Swathmore 2 St Sofa Wood Base	37-24RDHW	372	Ginger Round
241-3	235	Swathmore 3 St Sofa Wood Base	37-24RDLF	372	Ginger Round
243	236	Swathmore Grande Chair Wd Leg	37-24RDLGL	372	Ginger Round
243-3	236	Swathmore Grande 3 St Wd Leg	37-24RDLGR	372	Ginger Round
243B-30	237	Swathmore Grande Bariatric Chair	37-24RDLW	372	Ginger Round
243B-40	237	Swathmore Grande Bariatric Chair	37-31RDLF	372	Ginger Round
243MTL	239	Swathmore Grande Mobile	37-31RDLGL	372	Ginger Round
243MTR	239	Swathmore Grande Mobile	37-31RDLGR	372	Ginger Round
244	238	Swathmore Grande Wd Base	37-31RDLW	372	Ginger Round
244-2	238	Swathmore Grande 2 St Wd Base	385	244	Thoughtful Lounge Chair
244-3	238	Swathmore Grande 3 St Wd Base	385-60	244	Thoughtful Small Sofa
2540-1	308	Kathryn Wood with Open Back	385-70	245	Thoughtful Medium Sofa
2542-1	308	Kathryn Wood/Uph with Panel Back	385-80	245	Thoughtful Long Sofa
2547-1	308	Kathryn Fully Uphol Back	385-H	245	Thoughtful Ottoman
2547-1RIBD	309	Kathryn Fully Uphol Back w/Ribbed uph	39-2424	386	Switch Square
318	62	Astor Chair	39-2442	386	Switch Rectangle
3500	276	Enea Arm Chair	39-3636	386	Switch Square
3500S	278	Enea Armless	391	240	Switch Chair
3501	277	Enea Arm Chair	391-2	240	Switch Two-Seat
3501S	279	Enea Armless	391-3	241	Switch Three-Seat
3502	277	Enea Arm Chair	391-4	241	Switch Two-Seat w/Extensions
3502S	279	Enea Armless	391-B	241	Switch Arm Bolster
3503	277	Enea Arm Chair	43-S174820	381	Sidewalk Credenza
3503S	279	Enea Armless	43-T171717	380	Sidewalk Table
3510	280	Enea Bar-Height Stool w/Arms	43-T222222	380	Sidewalk Table
3510S	282	Enea Armless Bar-Height Stool	430	224	Sidewalk Collaborative Chair
3511	281	Enea Bar-Height Stool w/Arms	430-2	225	Sidewalk Collaborative Two-Seat
3511S	283	Enea Armless Bar-Height Stool	430-B1724	226	Sidewalk Bench
3512	281	Enea Bar-Height Stool w/Arms	430-B1736	226	Sidewalk Bench
3512S	283	Enea Armless Bar-Height Stool	430-B1748	226	Sidewalk Bench
3513	281	Enea Bar-Height Stool w/Arms	430-H1717	225	Sidewalk Collaborative Ottoman
3513S	283	Enea Armless Bar-Height Stool	430-H1720	225	Sidewalk Collaborative Ottoman
37-1818HF	373	Ginger Square	430-H2026	225	Sidewalk Collaborative Ottoman
37-1818HGL	373	Ginger Square	430-H3636	226	Sidewalk Ottoman
37-1818HGR	373	Ginger Square	44-T164830	376	Passerelle
37-1818HW	373	Ginger Square	44-T242417	376	Passerelle Table
37-18RDHF	372	Ginger Round	44-T242421	376	Passerelle Table
37-18RDHGL	372	Ginger Round	440-2WB	214	Passerelle Loveseat
37-18RDHGR	372	Ginger Round	440-3WB	214	Passerelle Sofa
37-18RDHW	372	Ginger Round	440-B	215	Passerelle Arm Bolster
37-1943ELF	373	Ginger Elliptical	440-B2060WB	217	Passerelle Bench
37-1943ELGL	373	Ginger Elliptical	440-B3060WB	217	Passerelle Bench
37-1943ELGR	373	Ginger Elliptical	440-B4040WB	217	Passerelle Bench
37-1943ELW	373	Ginger Elliptical	440-H1717WB	216	Passerelle Ottoman
37-2424HF	373	Ginger Square	440-H2026WB	216	Passerelle Ottoman
37-2424HGL	373	Ginger Square	440-H3636WB	216	Passerelle Ottoman
37-2424HGR	373	Ginger Square	440-WB	214	Passerelle Chair
37-2424HW	373	Ginger Square	444	220	Sidewalk Lowback Chair

Style Number Index *continued*

Style Number	Page	Description	Style Number	Page	Description
444-2	221	Sidewalk Two-Seat	460-SE22	67, 340	Await Connector Table
444M	221	Sidewalk Lowback Chair w/Tablet	460-SE22PD	67, 340	Await Connector Table
446	221	Sidewalk Highback Chair	460-SE30	67, 340	Await Connector Table
446M	221	Sidewalk Mobile Highback Chair w/Tablet	460-SE30PD	67, 340	Await Connector Table
45-T1300H	119, 356	Circa Freestanding Table	460-SE44	67, 340	Await Connector Table
45-T1300HER	120	Circa Ganging Table	460-SE44PD	67, 340	Await Connector Table
45-T1300HG	120	Circa Ganging Table	461-1B	66	Await Connector Bench
45-T1300L	119, 356	Circa Freestanding Table	461-2B	66	Await Connector Bench
45-T1300LER	121	Circa Ganging Table	461-3B	66	Await Connector Bench
45-T1300LG	121	Circa Ganging Table	47-T1326C	358	Diekman
45-T1815H	119, 356	Circa Freestanding Table	47-T1623A	358	Diekman
45-T1815HER	121	Circa Ganging Table	47-T1623B	358	Diekman Wood
45-T1815HG	120	Circa Ganging Table	47-T17ELG	358	Diekman
45-T1815L	119, 356	Circa Freestanding Table	47-T17RG1	358	Diekman
45-T1815LER	120	Circa Ganging Table	47-T2217E	358	Diekman
45-T1815LG	120	Circa Ganging Table	47-T23EL	358	Diekman
45-T28HER	121	Circa Ganging Table	47-T2617D	358	Diekman
45-T3730H	118, 355	Circa Freestanding Table	470	124	Coupe Chair
45-T3730HER	122	Circa Ganging Table	470-2	124	Coupe Loveseat
45-T3730HG	122	Circa Ganging Table	470-3	125	Coupe Sofa
45-T3730L	118, 355	Circa Freestanding Table	470-H	125	Coupe Ottoman
45-T3730LER	121	Circa Ganging Table	473MAPLE	128	Coupe Chair
45-T3730LG	121	Circa Ganging Table	473WALNUT	128	Coupe Chair
45-T42RD	119, 356	Circa Freestanding Table	476	127	Coupe Grande Chair
45-T7460HP	118, 355	Circa Freestanding Table	476-2	127	Coupe Grande Loveseat
45-T7460HPER	122	Circa Ganging Table	476-3	127	Coupe Grande Sofa
45-T7460HPG	122	Circa Ganging Table	476M	127	Coupe Grande Chair
451-2500	112	Circa Straight Seat Chair	49-SFTH15A	382	Soft Leaf
451-3730FI	110	Circa 30° Inside Wedge Armless Seat	49-SFTH17B	382	Soft Leaf
451-3730FO	110	Circa 30° Outside Wedge Seat	49-SFTH21C	382	Soft Leaf
451-5000	112	Circa Straight Loveseat	490-B35HRZ	219	Ripple Bench
451-7460FI	111	Circa 60° Inside Wedge Loveseat	490-B35VRT	218	Little Ripple Wave Bench
451-7460FO	111	Circa 60° Outside Wedge Loveseat	490-B96HRZ	218	Ripple Flat Seat Bench
451-A1800ER	114	Circa Straight Armrest	490-B96VRT	218	Ripple Wave Bench
451-A1800G	114	Circa Straight Armrest	70-A-SMM	390	Tree
451-A1815FIER	114	Circa 15° Inside Armrest	70-C-TPM	390	Tree
451-A1815FIG	114	Circa 15° Inside Armrest	70-D-TPM	390	Tree
451-A1815FOER	115	Circa 15° Outside Armrest	72-2020H	346	Calm Table Sq Top
451-A1815FOG	115	Circa 15° Outside Armrest	72-2020L	346	Calm Table Sq Top
451-A3730FIER	116	Circa 30° Inside Armrest	72-2142LR	347	Calm Table Rect Top
451-A3730FIG	116	Circa 30° Inside Armrest	72-2424H	346	Calm Table Sq Top
451-A3730FOER	117	Circa 30° Outside Armrest	72-2424L	346	Calm Table Sq Top
451-A3730FOG	116	Circa 30° Outside Armrest	72-4242L	346	Calm Table Sq Top
451-B42RD	117	Circa Round Ottoman	793390	304	Kart Stack Dolly
451-B5000	112	Circa Straight Bench	795	328	Chord Conference Chair
451-B7460FI	111	Circa 60° Inside Wedge Bench	795AU	328	Chord Conference Chair
451-B7460FO	111	Circa 60° Outside Wedge Bench	796	329	Chord Midback Chair
451-GANGPKG	112, 115	Circa Ganging Kit	796-P	329	Chord Midback Chair
46-T1	67, 340	Await Freestanding Table	796-PAU	329	Chord Midback Chair
46-T2	67, 340	Await Freestanding Table	796AU	329	Chord Midback Chair
460-3	65	Await Modular Three-Seat Sofa	797	329	Chord High Back Chair
460-4	65	Await Modular Four-Seat Sofa	797AU	329	Chord Midback Chair
460-4B	65	Await Modular Four-Seat Bench	798	329	Chord High Back Chair
460-GANGPKG	66	Ganging Kit	798-P	329	Chord High Back Chair
460-H	65	Await Modular Ottoman	798-PAU	329	Chord Midback Chair

Style Number Index

Style Number	Page	Description	Style Number	Page	Description
798AU	329	Chord Midback Chair	BLD26XX	81	Bix Sled Lounge
9014S	270, 277, 279	Stacking Dolly	BP72TX	90	Bix Podium
910C	56	Archipelago Lounge Chair	BP72XT	91	Bix Podium
910EAL	57	Archipelago Lounge Chair	BPP72TX	91	Bix Podium
910EAR	57	Archipelago Lounge Chair	BPP72XT	91	Bix Podium
910G	56	Archipelago Lounge Chair	BSC30LA	82	Bix Sectional Seating
910IA	57	Archipelago Lounge Chair	BSC30LB	82	Bix Sectional Seating
910LC	57	Archipelago Lounge Chair	BSC30RA	83	Bix Sectional Seating
910LG	57	Archipelago Lounge Chair	BSC30RB	83	Bix Sectional Seating
910RC	57	Archipelago Lounge Chair	BSCB30LA	83	Bix Sectional Seating
910RG	57	Archipelago Lounge Chair	BSCB30LB	83	Bix Sectional Seating
910TAL	58	Archipelago Tablet Arm	BSCB30RA	83	Bix Sectional Seating
910TAR	58	Archipelago Tablet Arm	BSCB30RB	83	Bix Sectional Seating
910UEAL	58	Archipelago Lounge Chair	BSE54LA	84	Bix Sectional Seating
910UEAR	58	Archipelago Upholstered Arm	BSE54LX	84	Bix Sectional Seating
910UIA	58	Archipelago Lounge Chair	BSE54RA	84	Bix Sectional Seating
910XC	57	Archipelago Lounge Chair	BSE54RX	84	Bix Sectional Seating
910XG	57	Archipelago Lounge Chair	BSEB54LA	84	Bix Sectional Seating
911	58	Archipelago Ottoman	BSEB54LX	84	Bix Sectional Seating
990	333	LaCosta Sport Sled Base	BSEB54RA	84	Bix Sectional Seating
991PS	333	La Costa Sport Conference Chair	BSEB54RX	84	Bix Sectional Seating
991PW	333	La Costa Sport Conference Chair	BSS48AA	85	Bix Sectional Seating
991SS	333	La Costa Sport Conference Chair	BSS48AX	85	Bix Sectional Seating
991SW	333	La Costa Sport Conference Chair	BSS48XA	85	Bix Sectional Seating
992PS	333	La Costa Sport Mid Back Chair	BSS48XX	85	Bix Sectional Seating
992PW	333	La Costa Sport Mid Back Chair	BSS72AA	86	Bix Sectional seating
992SS	333	La Costa Sport Mid Back Chair	BSS72AX	86	Bix Sectional seating
992SW	333	La Costa Sport Mid Back Chair	BSS72XA	86	Bix Sectional seating
993PS	333	La Costa Sport High Back Chair	BSS72XX	86	Bix Sectional seating
993PW	333	La Costa Sport High Back Chair	BSSB48AX	85	Bix Sectional Seating
993SS	333	La Costa Sport High Back Chair	BSSB48XA	85	Bix Sectional Seating
993SW	333	La Costa Sport High Back Chair	BSSB48XX	85	Bix Sectional Seating
996PS	331	La Costa Couture Conf Chair	BSSB72AX	86	Bix Sectional seating
996PW	331	La Costa Couture Conf Chair	BSSB72XA	86	Bix Sectional seating
996SS	331	La Costa Couture Conf Chair	BSSB72XX	86	Bix Sectional seating
996SW	331	La Costa Couture Conf Chair	BTB2226	96	Bix Bridge Table
997PS	331	La Costa Couture Mid Back Chair	BTB2226U	96	Bix Bridge Table
997PW	331	La Costa Couture Mid Back Chair	BTB2626	97	Bix Bridge Table
997SS	331	La Costa Couture Mid Back Chair	BTB2626U	97	Bix Bridge Table
997SW	331	La Costa Couture Mid Back Chair	BTBS2226	97	Bix Bridge Table
998PS	331	La Costa Couture High Back Chair	BTBS2226U	97	Bix Bridge Table
998PW	331	La Costa Couture High Back Chair	BTBS2626	97	Bix Bridge Table
998SS	331	La Costa Couture High Back Chair	BTBS2626U	97	Bix Bridge Table
998SW	331	La Costa Couture High Back Chair	BTC20001	98, 343	Bix Occasional Table
BATRAY	95	Bix Service Tray	BTC24241	98, 343	Bix Occasional Table
BB48	88	Bix Bench	BTC24241U	98, 343	Bix Occasional Table
BB72	88	Bix Bench	BTC24481	98, 343	Bix Occasional Table
BBS48	88	Bix Bench	BTC24481U	98, 343	Bix Occasional Table
BBS72	88	Bix Bench	BTC24721	98, 343	Bix Occasional Table
BL26AA	80	Bix Lounge Chair with Arms	BTC24721U	98, 343	Bix Occasional Table
BL26XX	80	Bix Lounge Chair	BTC28001	98, 343	Bix Occasional Table
BLB26XX	80	Bix Lounge Chair with Screen	BTC28001U	98, 343	Bix Occasional Table
BLD26AA	81	Bix Sled Lounge with Arms	BTS1700	100, 342	Bix Side Table
BLD26TX	81	Bix Sled Lounge Tablet Arm	BTW20003	99	Bix Work-Booth Table
BLD26XT	81	Bix Sled Lounge Tablet Arm	BTW28003	99	Bix Work-Booth Table

Style Number Index *continued*

Style Number	Page	Description	Style Number	Page	Description
BTW28003U	99	Bix Work-Booth Table	CO2467	410	Emu Round Stool
BTW36483	99	Bix Work-Booth Table	CO2467B	411	Emu Round Stool Cushion
BTW36483U	99	Bix Work-Booth Table	CO2467C	411	Emu Round Stool Cushion
BTW36723	99	Bix Work-Booth Table	CO2469	411	Emu Round Lounge
BTW36723U	99	Bix Work-Booth Table	CO2469B	411	Emu Round Lounge Cushion
CH0080100BCH	352	CH008 Sofa Table	CO2469C	411	Emu Round Lounge Cushion
CH0080100OAK	352	CH008 Sofa Table	CO2470	412	Emu Round Table
CH0080100WAL	352	CH008 Sofa Table	CO2471	412	Emu Square Table
CH008078BCH	352	CH008 Sofa Table	CO2472	412	Emu Square Table
CH008078OAK	352	CH008 Sofa Table	CO2473	412	Emu Square Table
CH008078WAL	352	CH008 Sofa Table	CO2474	412	Emu Rectangle Table
CH008088OAK	352	CH008 Sofa Table	CO2475	412	Emu Counter Table
CH008088WAL	352	CH008 Sofa Table	CO2477	412	Emu Side Table
CH00888BCH	352	CH008 Sofa Table	CO2478	412	Emu Side Table
CH07BEECH	102	CH07 Shell Chair	CO2480B	397	Emu Heaven Chair Back Cushion
CH07OAK	102	CH07 Shell Chair	CO2480C	397	Emu Heaven Chair Back Cushion
CH07SMKOAK	102	CH07 Shell Chair	CO2481B	397	Emu Heaven Arm Chair Back Cushion
CH07WALNUT	102	CH07 Shell Chair	CO2481C	397	Emu Heaven Arm Chair Back Cushion
CH101L	105	CH100 Series Chair	CO2485	396	Emu Heaven Chair
CH103L	105	CH100 Series Sofa	CO2485B	397	Emu Heaven Indoor Cushion
CH108	353	CH100 Series Table	CO2485C	397	Emu Heaven Outdoor Cushion
CH20BEECH	271	CH20 Elbow Chair	CO2486	396	Emu Heaven Arm Chair
CH20OAK	271	CH20 Elbow Chair	CO2486B	397	Emu Heaven Indoor Cushion
CH24ASH	272	CH24 Wishbone Chair	CO2486C	397	Emu Heaven Outdoor Cushion
CH24BEECH	272	CH24 Wishbone Chair	CO2487	396	Emu Heaven Lounge Chair
CH24CHERRY	272	CH24 Wishbone Chair	CO2487B	397	Emu Heaven Lounge Cushion
CH24OAK	272	CH24 Wishbone Chair	CO2487C	397	Emu Heaven Lounge Cushion
CH24OAKWAL	272	CH24 Wishbone Chair	CO2488B	398, 411	Emu Heaven Lounge Pillow
CH24SMKOAK	272	CH24 Wishbone Chair	CO2488C	398, 411	Emu Heaven Lounge Pillow
CH24WALNUT	272	CH24 Wishbone Chair	CO2489B	398	Emu Heaven Lounge Back Cushion
CH25OAK	103	CH25 Paddle Chair	CO2489C	398	Emu Heaven Lounge Back Cushion
CH25SMKOAK	103	CH25 Paddle Chair	CO2493	400	Emu Heaven Round Table
CH327ASH	354	CH327 Dining Table	CO2493V	400	Emu Heaven Glass Top
CH327BEECH	354	CH327 Dining Table	CO2494	400	Emu Heaven Round Table
CH327OAK	354	CH327 Dining Table	CO2494V	400	Emu Heaven Glass Top
CH327WALNUT	354	CH327 Dining Table	CO2495	398	Emu Heaven Pouf
CH32OAKWAL	354	CH327 Dining Table	CO2495B	398	Emu Heaven Indoor Cushion
CH401	106	CH401 Airport Chair	CO2495C	398	Emu Heaven Outdoor Cushion
CH445	107	CH445 Wing Chair	CO2495V	398	Emu Heaven Glass Top
CH446	107	CH445 Ottoman	CO2496	400	Emu Heaven Side Table
CH44OAK	104	CH44 Ladderback Chair	CO2497	399	Emu Heaven High Vase
CH468	108	CH468 Oculus Chair	CO2498	399	Emu Heaven Low Vase
CH53BEECH	273	CH53 Stool	CO2499	400	Emu Heaven Round Table Base
CH53OAK	273	CH53 Stool	CO2499V	400	Emu Heaven Glass Top
CH88BEECH	274	CH88 Chairs	CO2510	405	Emu Pattern Armless Chair
CH88OAK	274	CH88 Chairs	CO2511	405	Emu Pattern Arm Chair
CH88PBEECH	274	CH88 Chairs	CO2512	405	Emu Pattern 57"W Rectangular Bench
CH88POAK	274	CH88 Chairs	CO2518	406	Emu Pattern Small Round Table
CH88PSMKOAK	274	CH88 Chairs	CO2519	406	Emu Pattern Square Table
CH88SMKOAK	274	CH88 Chairs	CO2520	406	Emu Pattern Large Round Table
CO200G	268, 327	Bindu Low Back Guest/Side Chair	CO2565MB	408	Emu Re-Trouvé Midback Chair
CO2465	410	Emu Round Chair	CO2566B	409	Emu Re-Trouvé Indoor Cushion
CO2465B	411	Emu Round Stool Cushion	CO2566C	409	Emu Re-Trouvé Outdoor Cushion
CO2465C	411	Emu Round Chair Cushion	CO2566HB	408	Emu Re-Trouvé Highback Chair
CO2466	410	Emu Round Arm Chair	CO2575	408	Emu Re-Trouvé Pouf

Style Number Index

Style Number	Page	Description	Style Number	Page	Description
CO2575B	408	Emu Re-Trouvé Indoor Cushion	COEL1836	365	Enea Lottus Occasional Table
CO2575C	408	Emu Re-Trouvé Outdoor Cushion	COEL1842	365	Enea Lottus Occasional Table
CO2577	409	Emu Re-Trouvé High Vase Frame	COEL200	290	Enea Lottus Cantilever Arm Chair
CO2578	409	Emu Re-Trouvé Low Vase Frame	COEL200INSERT	290	Enea Lottus Cantilever Arm Chair
CO2580	409	Emu Re-Trouvé Vase Insert	COEL200UPH	291	Enea Lottus Cantilever Arm Chair
CO2581	402	Emu Ivy Side Chair	COEL300	292	Enea Lottus Aluminum Loop Arm Chair
CO2581B	403	Emu Ivy Side Chair Cushion	COEL300INSERT	292	Enea Lottus Aluminum Loop Arm Chair
CO2581C	403	Emu Ivy Side Chair Cushion	COEL300UPH	293	Enea Lottus Aluminum Loop Arm Chair
CO2582	402	Emu Ivy Side Arm Chair	COEL3030	366	Enea Lottus Conference Table
CO2585	402	Emu Ivy Arm Chair	COEL303072	369	Enea Lottus Rectangular Table
CO2585B	403	Emu Ivy Indoor Cushion	COEL3036	366	Enea Lottus Conference Table
CO2585C	403	Emu Ivy Outdoor Cushion	COEL3042	366	Enea Lottus Conference Table
CO2586	402	Emu Ivy Sofa	COEL3624	367	Enea Lottus Café Counter Height Table
CO2586B	403	Emu Ivy Sofa Cushion	COEL3630	367	Enea Lottus Café Counter Height Table
CO2586C	403	Emu Ivy Sofa Cushion	COEL363072	369	Enea Lottus Rectangular Table
CO2589	404	Emu Ivy Rectangle Side Table	COEL3636	367	Enea Lottus Café Counter Height Table
CO2591	404	Emu Ivy Square Side Table	COEL3642	367	Enea Lottus Café Counter Height Table
CO2592	404	Emu Ivy Rectangular Metal Top Table	COEL400	295	Enea Lottus Sled Base Stool
CO2593	404	Emu Ivy Rectangular Teak Top Table	COEL400INSERT	295	Enea Lottus Sled Base Stool
CO2595	403	Emu Ivy Pouf	COEL400UPH	295	Enea Lottus Sled Base Stool
CO2596	404	Emu Ivy Square Table	COEL4224	368	Enea Lottus Café Bar Height Table
CO2597	404	Emu Ivy Square Table	COEL4230	368	Enea Lottus Café Bar Height Table
CO300	326	Bindu Mid Back Executive Chair	COEL423072	369	Enea Lottus Rectangular Table
CO300G	268, 327	Bindu Mid Back Guest/Side Chair	COEL4236	368	Enea Lottus Café Bar Height Table
CO400	326	Bindu Mid Back High Back Executive Chair	COEL4242	368	Enea Lottus Café Bar Height Table
COCF5	370	Free Stand	COEL500	294	Enea Lottus Sled Base Stool
COCGM1836L	348	CG_1 Metal Low Rectangular Table	COEL500INSERT	294	Enea Lottus Sled Base Stool
COCGM1842L	348	CG_1 Metal Low Rectangular Table	COEL500UPH	295	Enea Lottus Sled Base Stool
COCGM2020H	349	CG_1 Metal High Square Table	COEL600	297	Enea Lottus Post Base Stool
COCGM2424H	349	CG_1 Metal High Square Table	COEL600INSERT	297	Enea Lottus Post Base Stool
COCGM2436H	349	CG_1 Metal High Rectangular Table	COEL600UPH	297	Enea Lottus Post Base Stool
COCGM3636L	348	CG_1 Metal Low Square Table	COEL700	296	Enea Lottus Post Base Stool
COCGM4242L	348	CG_1 Metal Low Square Table	COEL700INSERT	296	Enea Lottus Post Base Stool
COCGM6060L	348	CG_1 Metal Low Square Table	COEL700UPH	297	Enea Lottus Post Base Stool
COCGW1836L	350	CG_1 Low Rectangular Table	COELDOLLY	289	Enea Lottus Stacking Dolly
COCGW1842L	350	CG_1 Low Rectangular Table	COHD	147	Holy Day Lounge Chair
COCGW2020H	351	CG_1 High Square Table	COHD30RCG	374	Holy Day Table
COCGW2424H	351	CG_1 High Square Table	COHD30RCL	374	Holy Day Table
COCGW2436H	351	CG_1 High Rectangular Table	COHD30RCW	374	Holy Day Table
COCGW3636L	350	CG_1 Low Square Table	COHD35RDG	374	Holy Day Table
COCGW4242L	350	CG_1 Low Square Table	COHD35RDL	374	Holy Day Table
CODAV	129	Davos Chair	COHD35RDW	374	Holy Day Table
CODAV16	129	Davos Small Bench	COHD35SQG	374	Holy Day Table
CODAV38	129	Davos Medium Bench	COHD35SQL	374	Holy Day Table
CODAV60	129	Davos Large Bench	COHD35SQW	374	Holy Day Table
CODOLLY017	413	Emu Dolly	COHDL	147	Holy Day Lounge Chair
CODT163526	357	Denizen Tablet	COJHB100	264	Visalia Lounge
COEB2723H	378	Sebastopol 22" High Table	COJHB200	264	Visalia Lounge
COEB2723L	378	Sebastopol 16" High Table	COJHBC100	264	Visalia Lounge
COEB4118H	378	Sebastopol 22" High Table	COJHBC200	264	Visalia Lounge
COEB4118L	378	Sebastopol 16" High Table	COJHL100	263	Visalia Lounge
COEL100	288	Enea Lottus Armless Chair	COJHL200	263	Visalia Lounge
COEL100INSERT	288	Enea Lottus Armless Chair	COJHL300	263	Visalia Lounge
COEL100UPH	289	Enea Lottus Armless Chair	COJHLC100	263	Visalia Lounge
COEL1830	365	Enea Lottus Occasional Table	COJHLC200	263	Visalia Lounge

Style Number Index *continued*

Style Number	Page	Description	Style Number	Page	Description
COJHLC300	263	Visalia Lounge	COMOTL4848	210, 375	Millbrae Square Table
COLAGB1	195	Lagunitas One-Seat Bench	COMSL1	205	Millbrae Lounge
COLAGB2	195	Lagunitas Two-Seat Bench	COMSL2	205	Millbrae Two-Seat
COLAGB3	195	Lagunitas Three-Seat Bench	COMSL3	205	Millbrae Three-Seat
COLAGCH2	191	Lagunitas Two-Seat Chaise	COPP01	379	Power Pod
COLAGCH3	193	Lagunitas Three-Seat Chaise	COTO12369L15	249	Together Bench
COLAGCI	196	Alignment Connector	COTO12369L8	249	Together Bench
COLAGCL2	191	Lagunitas Two-Seat Chaise	COTO12369R15	251	Together Bench
COLAGCL3	193	Lagunitas Three-Seat Chaise	COTO12369R8	250	Together Bench
COLAGLH1	176	Lagunitas One-Seat Lounge	COTO12396L15	249	Together Bench
COLAGLH2	181-183	Lagunitas Two-Seat Lounge	COTO12396L8	249	Together Bench
COLAGLH3	187-189	Lagunitas Three-Seat Lounge	COTO12396R15	251	Together Bench
COLAGLL1	175	Lagunitas One-Seat Lounge	COTO12396R8	250	Together Bench
COLAGLL2	179-181	Lagunitas Two-Seat Lounge	COTO69	253	Together Bench
COLAGLL3	185-187	Lagunitas Three-Seat Lounge	COTO69WB15	252	Together Bench
COLAGTO	198	Lagunitas Occasional Table	COTO69WB8	252	Together Bench
COLAGTP	199	Lagunitas Personal Table	COTO96	253	Together Bench
COLAGTRECT	197	Lagunitas Work Table	COTO9669L15	249	Together Bench
COLMS25	310	Last Minute Stool	COTO9669L8	248	Together Bench
COLMS30	310	Last Minute Stool	COTO9669R15	251	Together Bench
COLX100	311	Lox Chair	COTO9669R8	250	Together Bench
COLX110	311	Lox Chair	COTO9696L15	249	Together Bench
COLX200	312	Lox Stool	COTO9696L8	248	Together Bench
COLX210	312	Lox Stool	COTO9696R15	251	Together Bench
COMCLG	200	Massaud Lounge Chair	COTO9696R8	250	Together Bench
COMCOT	201	Massaud Ottoman	COTO96WB15	252	Together Bench
COMCWL	200	Massaud Work Lounge Chair	COTO96WB8	252	Together Bench
COMF1	209	Millbrae Ganging Kit	COURQL	149	Hosu Lounge w/Attached Lumbar
COMFL1	205	Millbrae Lounge	COURQLO	149	Hosu Lounge w/Otto and Attached Lumbar
COMFL2	206	Millbrae Lounge	COURQS	149	Hosu Two-Seat Sofar
COMFL3	207	Millbrae Three-Seat Sofa	COW210	229	SW_1 Ottoman
COMFL4	208	Millbrae Four-Seat Sofa	COW412	317	SW_1 Guest Chair
COMFLA1	205	Millbrae Lounge	COW414	317	SW_1 Guest Chair
COMFLA2	206	Millbrae Two-Seat Sofa	COW612	229	SW_1 Lowback Lounge Swivel Return Chair
COMFLA3	207	Millbrae Three-Seat Sofa	COW712	229	SW_1 Highback Lounge Swivel Return Chair
COMFLA4	208	Millbrae Four-Seat Sofa	COWK100	151	Joel Lounge
COMFLB1	209	Millbrae One-Seat Bench	COWO_RND30	385	SW_1 Round Occasional Table
COMFLB2	209	Millbrae Two-Seat Bench	COWO_RND36	385	SW_1 Round Occasional Table
COMFLB3	209	Millbrae Three-Seat Bench	COWO_RND42	385	SW_1 Round Occasional Table
COMFLB4	209	Millbrae Four-Seat Bench	COWO_RND48	385	SW_1 Round Occasional Table
COMFLLA1	205	Millbrae Lounge	COWO_RND60	385	SW_1 Occasional Table
COMFLLA2	206	Millbrae Two-Seat Sofa	COWO_SQ30	385	SW_1 Square Occasional Table
COMFLLA3	207	Millbrae Three-Seat Sofa	COWO_SQ36	385	SW_1 Square Occasional Table
COMFLLA4	208	Millbrae Four-Seat Sofa	COWO_SQ42	385	SW_1 Square Occasional Table
COMFLRA1	205	Millbrae Lounge	COWO_SQ60	385	SW_1 Occasional Table
COMFLRA2	206	Millbrae Two-Seat Sofa	COWO_SSQ45	385	SW_1 Super-Square Occasional Table
COMFLRA3	207	Millbrae Three-Seat Sofa	COWRP4LEG	321	Wrapp Side Chair
COMFLRA4	208	Millbrae Four-Seat Sofa	COWRPSLD	321	Wrapp Side Chair
COMLPRND	209	Millbrae Round Arm Bolster	COWTABL	229	SW_1 Collaborative Lounge Seating
COMLPSQR	209	Millbrae Square Arm Bolster	COWTABR	229	SW_1 Collaborative Lounge Seating
COMOTL2020	210, 375	Millbrae Side Table	COWX_Q42	231	SW_1 Square Low Coll Conf Tbl
COMOTL2054	210, 375	Millbrae Rectangular Table	COWX_R4120	232	SW_1 Rectangular Low Coll Conf Tbl
COMOTL3030	210, 375	Millbrae Square Table	COWX_R4284	232	SW_1 Rectangular Low Coll Conf Tbl
COMOTL3060	210, 375	Millbrae Rectangular Table	COWX_RND60	231	SW_1 Low Collaborative Conference Table
COMOTL3636	210, 375	Millbrae Square Table	COWX_RND72	231	SW_1 Low Collaborative Conference Table

Style Number Index

Style Number	Page	Description	Style Number	Page	Description
COWX_RND84	231	SW_1 Low Collaborative Conference Table	H35-T6030L	360	Enea Table Single Base
COWX_RND96	231	SW_1 Low Collaborative Conference Table	H35-T6030W	360	Enea Table Single Base
COWX_SE4072	232	SW_1 Super Elliptical Low Coll Conf Tbl	H350-S19	287	Enea Café Low Stool
COWX_SE4084	232	SW_1 Super Elliptical Low Coll Conf Tbl	H350-S27	287	Enea Café Counter-Height Stool
COWX_SE4096	232	SW_1 Super Elliptical Low Coll Conf Tbl	H350-S31	287	Enea Café Bar-Height Stool
COWX_SE4120	232	SW_1 Super Elliptical Low Coll Conf Tbl	H350-SB2719	285	Enea Café Stool with Back
COWX_SE4122	232	SW_1 Super Elliptical Low Coll Conf Tbl	H350-SB3119	285	Enea Café Stool with Back
COWX_SQ60	231	SW_1 Low Collaborative Conference Table	H351-SB2719	285	Enea Café Stool with Back
COWX_SQ72	231	SW_1 Low Collaborative Conference Table	H351-SB3119	285	Enea Café Stool with Back
COWX_SQ84	231	SW_1 Low Collaborative Conference Table	H352-S19	286	Enea Café Low Stool
COWX_SQ96	231	SW_1 Low Collaborative Conference Table	H352-S27	286	Enea Café Counter-Height Stool
H35-T2436L	361	Enea Table Single Base	H352-S31	287	Enea Café Bar-Height Stool
H35-T2436W	361	Enea Table Single Base	H352-SB2719	285	Enea Café Stool with Back
H35-T2442L	361	Enea Table Single Base	H352-SB3119	285	Enea Café Stool with Back
H35-T2442W	361	Enea Table Single Base	H353-S19	287	Enea Café Low Stool
H35-T3030L	360	Enea Table Single Base	H353-S27	287	Enea Café Counter-Height Stool
H35-T3030W	360	Enea Table Single Base	H353-S31	287	Enea Café Bar-Height Stool
H35-T3036L	361	Enea Table Single Base	H353-SB2719	285	Enea Café Stool with Back
H35-T3036W	361	Enea Table Single Base	H353-SB3119	285	Enea Café Stool with Back
H35-T3042L	361	Enea Table Single Base	PL2431	258	Topo Lounge
H35-T3042W	361	Enea Table Single Base	PLJ2417	258	Topo Lounge
H35-T307230GL	362	Enea Table Twin Base	PLM2431	259	Topo Mobile
H35-T307230GW	362	Enea Table Twin Base	PLMJ2417	259	Topo Mobile Jr.
H35-T307230KL	363	Enea Table Twin Base	TW19004	388	TeamWork Satellite Table
H35-T307230KW	363	Enea Table Twin Base	X1000	322	X-Stack Chair
H35-T307230VL	363	Enea Table Twin Base	X1000C	322	X-Stack Chair
H35-T307230VW	363	Enea Table Twin Base	X1010	323	X-Stack Chair
H35-T307236GL	362	Enea Table Twin Base	X1010C	323	X-Stack Chair
H35-T307236GW	362	Enea Table Twin Base	X1010CL	323	X-Stack Chair
H35-T307236KL	363	Enea Table Twin Base	X1010L	323	X-Stack Chair
H35-T307236KW	363	Enea Table Twin Base	X2200	322	X-Stack Chair
H35-T307236VL	363	Enea Table Twin Base	X2200C	322	X-Stack Chair
H35-T307236VW	363	Enea Table Twin Base	X2210	323	X-Stack Chair
H35-T307242GL	362	Enea Table Twin Base	X2210C	323	X-Stack Chair
H35-T307242GW	362	Enea Table Twin Base	X2210CL	323	X-Stack Chair
H35-T307242KL	363	Enea Table Twin Base	X2210L	323	X-Stack Chair
H35-T307242KW	363	Enea Table Twin Base			
H35-T307242VL	363	Enea Table Twin Base			
H35-T307242VW	363	Enea Table Twin Base			
H35-T3618L	360	Enea Table Single Base			
H35-T3618W	360	Enea Table Single Base			
H35-T3630L	360	Enea Table Single Base			
H35-T3630W	360	Enea Table Single Base			
H35-T3636L	361	Enea Table Single Base			
H35-T3636W	361	Enea Table Single Base			
H35-T3642L	361	Enea Table Single Base			
H35-T3642W	361	Enea Table Single Base			
H35-T4218L	360	Enea Table Single Base			
H35-T4218W	360	Enea Table Single Base			
H35-T4230L	360	Enea Table Single Base			
H35-T4230W	360	Enea Table Single Base			
H35-T4236L	361	Enea Table Single Base			
H35-T4236W	361	Enea Table Single Base			
H35-T5430L	360	Enea Table Single Base			
H35-T5430W	360	Enea Table Single Base			

Trademark List

- ® The following are registered trademarks for products of Steelcase Inc. or one of its related corporate entities: 4 o'clock, 900 Series, à la carte, Airtouch, Ally, Amia, Answer, Archipelago, Avenir, Ballet, Bix, Brayton International, Cachet, Canopy, Canto, Chancellor, Coalesse, Confidante, Context, Convene, CopyCam, Criterion, Crushed Can, Currency, dash, Designtex, Details, Detour, Drive, Elective Elements, Ellipse, Ember Chrome, Emerge, E-Table 2, FYI, Garland, Gentry, Ginkgo Biloba, Groupwork, Ideo, Jacket, Jenny, Jersey, Kart, Kick, LaCosta, Leap, Let's B, LiveBack, Max-Stacker, media:scape, Metro, Migrations, Mitra, Montage, Nurture, Oriana, Parade, Pathways, PCT, Permiso, Player, PolyVision, Portal, Power Pincher, Progeny, Protégé, R2, Rally, Relevant, Reply, Rizzi Arc, Sensor, Series 9000, Siento, Sieste, Sine, Softcare, Springboard, Steelcase, Steelcase Design Partnership, Stella, Stow Davis, Swathmore, TeamWork, Technique, Texpress, Think, Thunder, Topo, Train, Turnstone, Underline, Unison, Vecta, Viridian, Walden, Werndl, and X-Stack.
- ® The following registered trademarks are under license from AWI Licensing Company, Dover, DE: SoundScapes, DuraBrite, BioBlock, and Armstrong.
- ® The following registered trademarks are under license from Byrne Electrical, Rockford, MI: Interport, Mini-Port, Axil Z, and Ellora.
- ® The following is a registered trademark of DuPont, Wilmington, DE: Corian.
- ® The following is a registered trademark of Genlyte Thomas Company, Louisville, KY: Lightolier.
- ® The following is a registered trademark of Hilti Corporation, FL-9494 Schaan, Principality of Liechtenstein: Hilti.
- ® The following is a registered trademark of Leviton Manufacturing Company, Little Neck, NY: Decora.
- ® The following is a registered trademark of Mechanical Plastics Corp, Elmsford, NY: Toggler.
- ® The following is a registered trademark of Microsoft Corporation, Redmond, WA: Microsoft.
- ® The following is a registered trademark of Panduit Corporation, Lockport, IL: Panduit.
- ® The following is a registered trademark of Trav (Press), Cuneo, Italy: Assisa.
- ® The following is a registered trademark of Virtual Ink, Boston, MA: mimioActive.
- ® The following registered trademarks are under license from Wilkhahn Furniture Products: Avera, Senzo, Versal, and Wilkhahn FS.
- ® The following is a registered trademark of Wilsonart International, Temple, TX: Chemsurf.

- ® The following is a registered trademark of Wiremold, West Hartford, CT: Wiremold.
- ® The following is a registered trademark of EMU Group S.P.A., Perugia, Italy: Emu.
- ™ The following are trademarks for products of Steelcase Inc. or one of its related corporate entities: Access, Active/Passive Shelf, Ainsley, Akira, Alcove, Alerion, aLight, Amaris, American Elect, American Tradition, ap40, Arbor, Arriva, Asana, Ascot, Aspekt, Astor, Await, Bira, Bivi, Bottomline, Brook, Buoy, Burton, c:scape, Calla, Calm, Camber, Campfire, Capa, Cappuccino, Cesar, Chester, Chord, Circa, Clarendon, Classic Rectangular, cobi, Collaboration, Community, Company, Convey, Cortex, Coupe, Crea, Crew, Cura, Cypress, Davenport, Dearborn, Deck, Déjà, Denizen, Denska, Derby, Divisio, Donovan, Dune, Duo, e³, e³ ceramicsteel, e³ environmental ceramicsteel, Echo, Edge, Elsna, Empath, Empress, Enea, ēno, EnSync, Enviro, Escapade, Exchange, Exponents, Field, Flat Top, FlexFrame, Flip Top, Flute, Folio, FrameOne, FreeFlow, Frontier, Galilei, Gesture, Ginger, Ginkgo, Go Wall, Grip, Groove, Hatchback, Hawthorne, Hitch, Host Collection, Hosu, Huddleboard, i2i, Impact, Indy, InfoLink, IOS, I-Solve, Jack, Jarrah, Jetty, Juice, Kami, Kast, Kathryn, Lagunitas, Lark, L'Attitude, LearnLab, Leela, Lincoln, Linden, LiveSeat, Loria, Lyric, Malibu, Malibu Too, Mansfield, Marathon, Martini, Mason, Masque, Millbrae, Mineral, Mingle, Mystic, Mystic Metal, Mystic Wood, Montreal, Move, Nadia, Neighbor, nesso, Nickel, Nikko, Nod, Node, Norfolk, Ontrak, Oom, Opus, Orchid, Outlook Collection, Ovation, Paloma, Paperflo, Parliament, Pasio, Passerelle, Patriarch, Payback, Peek, Pile File, Pisa, Pool, PUCK, QiVi, Quba, Rave, Reed, Regard, Relay, Reunion, Ripple, Riser, Rocco, Rocky, RoomWizard, Runner, Satellite, Sawyer, ScapeSeries, Senti, Sentinel, Senza, Sequoia, Session, ShareLink, Shield, Shortcut, Sidewalk, Skylar, Slumber, Smoke, Snug, Soft Leaf, Sonata, Sorrel, SOTO, Stationkits, Stiletto, Surprise!, Switch, Symphony, Sync, TagWizard, Tava, TeamStudio, TeamTheater, Tenaro, Terrazzo, Theorem, Thread, Topaz, Touchdown, Tour, Tower Too, Trees, Trillium, Trolley, tX2, U-Free, Uno, V.I.A., Verb, Verge, Victor2, Visalia, Waldorf, Woodruff, Workspring, and X-tenz.
- ™ The following is a trademark of Microsoft Corporation, Redmond, WA: Windows.
- ™ The following is a trademark of Rodman Industries, Inc., Oconomowoc, WI: ResinCore1.
- ™ The following is a trademark of Ultrafabrics, LLC, Elmsford, NY: Ultraleather.
- ™ The following trademarks are under license from Wilkhahn Furniture products: Cana, Linus, Logon, Picto, Range, Stitz, Thema, Timetable, and Tubis.
- ™ The following is a trademark of MBDC, Charlottesville, VA: Cradle to Cradle and C2C.

- ™ The following trademarks are under license from Walter Knoll: Andoo, Bob, Lazlo, Lox, Ribbon, and Together.
 - ™ The following trademarks are under license from PP Möbler: Bar and Flag Halyard.
 - ™ The following trademarks are under license from Viccarbe: Davos, Holy Day, Last Minute, RS, and Wrapp.
 - ™ The following trademarks are under license from Carl Hansen: Elbow, Paddle, Shell, Wing, and Wishbone.
 - ™ The following trademarks are under license from Cambridge Sound Management, LLC, Cambridge, MA: QtPro Soundmasking, Qt Quiet Technology, and Sonet Qt.
 - ™ The following is a trademark of Electri-Cable Assemblies, Shelton, CT: Interact.
- Trademarks used here in are the property of Steelcase, Inc. or of their respective owners.*