

---



# Wood Seating Specification Guide

## Availability

**Electronic price list updated** with release 180.F (U.S.) and 146.F (Canada), dated February 16, 2015.

Spec News is available on [village.steelcase.com](http://village.steelcase.com). Search AdStock and download the current release's Spec News.

View or download Steelcase Specification Guides at <http://www.steelcase.com/en/resources/design/spec-guides/pages/specguides.aspx>.

Transitional products in this specification guide are **maintained for existing customers only** and are likely to be phased out over time. These products are indicated with a . Products that are scheduled to be culled are indicated with an , followed by the last order entry date.

## Working With This Specification Guide

Statement of Line	2
Guidelines for Selecting Appropriate Ergonomic Seating	6
Basics of Ergonomic Seating	7
Basics of Adjustability	8
Additional Resources	9

## Product Information

Executive Seating	11
General-Use Seating	27
Guest Seating	35
Stackable Seating	83

## Surface Materials

## Resources

► For a list of all trademarks, refer to the last page of this specification guide.  
© 2015 Steelcase Inc.



### For Canadian Pricing

Calculate in the following order to avoid rounding errors:

- Multiply the base price and each option by 1.09.
- Round each to the nearest dollar.
- Add base and options for total list price.

# Statement of Line

## Wood Seating

### Executive Seating

#### Siento

Understanding  
▶ Page 12  
Specifying  
▶ Pages 14–17



High-Back  
Desk Chair with  
Fixed T-Arms



High-Back  
Desk Chair with  
Enclosed Arms



High-Back  
Desk Chair with  
Adjustable T-Arms



Mid-Back  
Desk Chair with  
Fixed T-Arms



Mid-Back  
Desk Chair with  
Enclosed Arms



Mid-Back  
Desk Chair with  
Adjustable T-Arms

#### Mansfield

Understanding  
▶ Page 18  
Specifying  
▶ Page 20



High-Back  
Desk Chair



Mid-Back  
Desk Chair

#### Theorem

Understanding  
▶ Page 22  
Specifying  
▶ Page 24

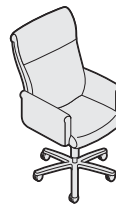

High-Back  
Desk Chair with  
Enclosed Arms



Mid-Back  
Desk Chair with  
Enclosed Arms

### General-Use Seating

#### Gentry

Understanding  
▶ Page 28  
Specifying  
▶ Pages 30–33



High-Back  
Desk Chair with  
Enclosed Arms



High-Back  
Desk Chair with  
Open Arms



Low-Back  
Desk Chair with  
Enclosed Arms



Low-Back  
Desk Chair with  
Open Wood Arms



Low-Back  
Desk Chair with  
Open Thermoplastic Arms

## Guest Seating

### Alcove

- Understanding
- ▶ Page 36
- Specifying
- ▶ Page 38



Guest Chair with Open Arms

### Collaboration

- Understanding
- ▶ Page 40
- Specifying
- ▶ Page 42

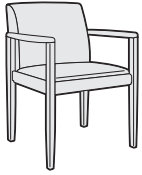

Open



Arcade

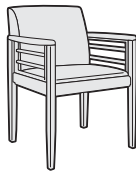

Ladder

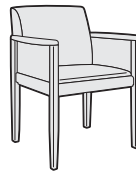

Upholstered Insert

*Tip: All Collaboration guest chairs are available with plain wood arms.*

### England

- Understanding
- ▶ Page 44
- Specifying
- ▶ Page 46

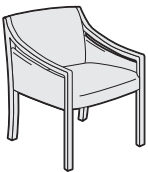

Guest Chair with Enclosed Arms

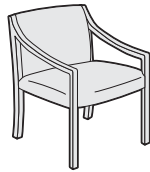

Guest Chair with Open Arms

### Escapade

- Understanding
- ▶ Page 48
- Specifying
- ▶ Page 50



Guest Chair with Wood Slat Back



Guest Chair with Upholstered Back

**Guest Seating, continued**

**Gentry**

- Understanding
- ▶ Page 52
- Specifying
- ▶ Page 54



Low-Back  
Guest Chair

**Mansfield**

- Understanding
- ▶ Page 56
- Specifying
- ▶ Page 58

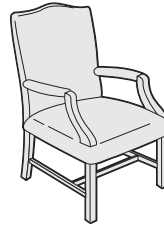

Upholstered  
Guest Chair

**Mingle**

- Understanding
- ▶ Page 60
- Specifying
- ▶ Page 62



Guest Chair

**Oriana**

- Understanding
- ▶ Page 64
- Specifying
- ▶ Page 66



Vertical  
Slat-Back  
Guest Chair



Horizontal  
Slat-Back  
Guest Chair

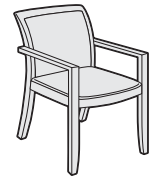

Fully Upholstered  
Back Guest Chair

**Sawyer**

- Understanding
- ▶ Page 68
- Specifying
- ▶ Page 70



Guest Chair

**Snodgrass 474 Series**

- Understanding
- ▶ Page 72
- Specifying
- ▶ Page 74



Guest Chair with  
Open Back and  
Open Arms

### Guest Seating, continued

#### Terrazzo

- Understanding
- ▶ Page 76
- Specifying
- ▶ Page 78



Guest Chair with Square Lattice Back



Guest Chair with Macintosh Lattice Back



Guest Chair with Horizontal Lattice Back

#### Topaz

- Understanding
- ▶ Page 80
- Specifying
- ▶ Page 82



Guest Chair with Closed Back



Guest Chair with Open Back

### Stackable Seating

#### Deck

- Understanding
- ▶ Page 84
- Specifying
- ▶ Pages 86–88

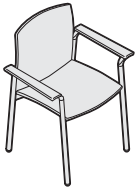

Stacking Guest Chair with Arms

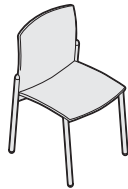

Stacking Guest Chair without Arms



Stool

# Guidelines for Selecting Appropriate Ergonomic Seating

<b>General-Use</b>	<div style="display: flex; flex-direction: column; align-items: center;"> <div style="writing-mode: vertical-rl; transform: rotate(180deg);">High</div> <div style="border: 1px solid black; padding: 10px; width: 100%; text-align: center;"> <p><b>General-Use Seating</b></p> <div style="display: flex; justify-content: space-around;"> <div style="text-align: left;">Group Communicating</div> <div style="text-align: left;">Group Collaborating</div> </div> </div> <div style="writing-mode: vertical-rl; transform: rotate(180deg);">Interaction</div> </div>	<ul style="list-style-type: none"> <li>• Short periods of sitting</li> <li>• Moderate computer use</li> <li>• In some cases, a general-use chair can be used for short-term, individual analyzing/creating.</li> </ul>
<b>High-Performance</b>	<div style="display: flex; flex-direction: column; align-items: center;"> <div style="writing-mode: vertical-rl; transform: rotate(180deg);">Low</div> <div style="border: 1px solid black; padding: 10px; width: 100%; text-align: center;"> <p><b>High-Performance Seating</b></p> <div style="display: flex; justify-content: space-around;"> <div style="text-align: left;">Individual Processing (task intensive)</div> <div style="text-align: left;">Individual Analyzing/Creating (multi-task)</div> </div> </div> <div style="writing-mode: vertical-rl; transform: rotate(180deg);">Low</div> </div>	<ul style="list-style-type: none"> <li>• Long periods of sitting</li> <li>• Heavy computer use</li> <li>• The more repetitive the task (individual processing work), the more critical it is to have a high-performance chair with full adjustability.</li> </ul>
<b>Executive</b>	<p style="text-align: center;"><b>Executive Seating</b></p> <p>Today's executive is an active participant, not just a delegator. Image is very important in the executive suite, but time at the computer must also be a consideration. Whether image or ergonomics drive the choice, this range of seating is diverse to provide the perfect chair for any executive work setting.</p>	<ul style="list-style-type: none"> <li>• Design that acknowledges image</li> <li>• Aesthetics and detailing that suit the setting</li> <li>• Ergonomic features matched to the kinds of work</li> </ul>
<b>Guest</b>	<p style="text-align: center;"><b>Guest Seating</b></p> <p>Guest seating must be adaptable to many roles: as side chairs, pulled up to the conference table, in the learning center, in the private office, or in high-traffic areas where long use-life is essential. Guest seating is not intended for long periods of seated work, but must provide short-term comfort and have a welcoming, comfortable look.</p>	<ul style="list-style-type: none"> <li>• A style in harmony with the other furniture</li> <li>• A scale that suits the environment</li> <li>• A durability that fits the intended use</li> </ul>
<b>Stackable</b>	<p style="text-align: center;"><b>Stackable Seating</b></p> <p>Stackable seating is used when occasional, transportable, easy-to-store seating is needed. Whether used as side chairs, meeting chairs, in classrooms, or cafeterias, the challenge is to maintain an excellent aesthetic combined with great strength even though the chairs are light in scale for portability.</p>	<ul style="list-style-type: none"> <li>• Durability for high-volume, high-traffic use</li> <li>• Light weight for easy stacking and moving</li> <li>• Extra features if needed, such as tablet arms, bookracks, glides, transport and storage dollies, and ganging or alignment devices.</li> </ul>
<b>Lounge</b>	<p style="text-align: center;"><b>Lounge Seating</b></p> <p>Lounge seating is often multiple and is found throughout the organization from reception areas to executive offices. Lounge seating is the "first impression seating," critical to an organization's image.</p>	<ul style="list-style-type: none"> <li>• Durability related to level of use</li> <li>• A design that looks right in multiples</li> <li>• Size, scale, and appearance that suits the environment</li> </ul>

# Basics of Ergonomic Seating

**Proper ergonomic seating** can help workers perform more efficiently and avoid muscle and eye strain.

**Neck** is straight or slightly forward.

**Shoulders** are relaxed so arms hang naturally.

**Back** has full contact with the backrest (sit all the way back in your chair).

**Elbows and forearms** can rest comfortably on the arms of your chair, or on worksurfaces that are used for writing, paperwork, and other tasks.

**Lower back** fits into curved lumbar support.

**Tension** is adjusted so backrest tilts easily, yet provides smooth, even support.

**If worksurfaces and keyboard support** are not height-adjustable, raise your chair's seat height to achieve the appropriate relationship to your tasks. If this leaves your feet dangling above the floor, use a Details footrest.

**Call Details,** 1.800.833.0411, or your Steelcase dealer, for additional information or price list.

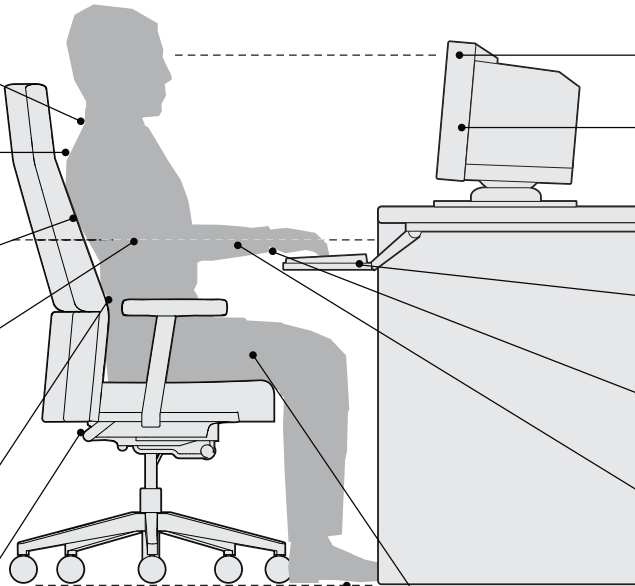
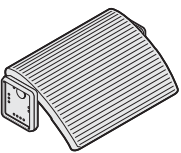

**Top of monitor** should be at eye level.

**Screen** is 20 to 30 inches from the eyes.

**Screen** is at eye level or slightly lower and directly in front of worker so head is not turned.

**Keyboard** is at elbow height.

**Wrists** should be straight when keying or mousing, not bent up or down.

**When keying or mousing,** forearms are parallel to the floor.

**Thighs** are parallel to the floor.

**Feet** are flat on the floor or on a footrest.

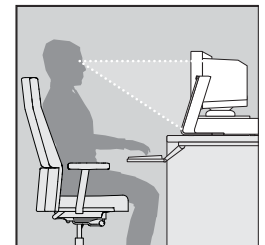

**Keep frequently viewed objects,** such as a VDT or source document, at or below the horizontal line of sight. Arrange display screen and documents to be equidistant from your eyes.

**ANSI/HFES** is the American National Standards Institute/Human Factors & Ergonomics Society. This organization's 1988 guidelines cover the ergonomic needs of task workers. These guidelines are currently under revision.

**ANSI/BIFMA** is the American National Standards Institute/Business and Institutional Furniture Manufacturer's Association. All Steelcase furniture meets or exceeds ANSI/ BIFMA standards for structural quality.

# Basics of Adjustability

**Steelcase chairs** offer varying levels of adjustability to meet the needs of many types of users. Adjustable chairs may offer one or more of these features:

## Mechanisms



**Swivel** feature allows the user to rotate the seat 360 degrees in either direction. (All)

**Synchro-tilt** feature means the chair back and seat are synchronized to move in a 2:1 ratio. When the user leans back, the seat rises only half as much, allowing the user's feet to remain flat on the floor. (Siento, Theorem)

## Seat Adjustments



**Pneumatic-height** adjustment allows the user to remain seated while adjusting the seat height by way of a control button or lever. (All)



**Swivel-tilt** feature means the chair back and seat are fixed together and move in unison. When the user leans back, the seat rises so that the back-to-seat angle remains constant. (Gentry)



**Passive seat edge angle** allows front edge of seat to drop down while seat angle remains unchanged. (Siento)



**Knee-tilt (low front rise)** minimizes the rise of the front of the seat when the chair is in a reclined position, allowing the user's feet to remain on the floor. This feature reduces pressure under the thighs, allowing for continuous blood circulation. (Mansfield)

## Back Adjustments



**Back-tension** adjustment allows the user to control the amount of resistance felt when leaning back in the chair. (All)



**Variable back stop** allows the user to lock the back upright and to preset their range of recline. (Theorem)



**Upright back lock** allows the user to lock the backrest in a full upright position or release it for full tilt motion. (Mansfield, Siento)

## Arm Adjustments



**Arm height** adjustment allows the user to move the arms up or down independently. (Siento)



**Arm width** adjustment allows the user to move the arms in or out independently. (Siento)



**Arm pivot** adjustments allows the user to position arm rests as appropriate for the task being performed. (Siento)



**Arm depth** adjustment allows users to get closer to their work by chair arms moving out of the way. (Siento)



## Wood seating products

are supported with an array of informational materials, tools, and software to help you plan an installation efficiently.

## Product brochures and planning tools

can be ordered through your Steelcase area office by calling 1.800.784.0358 or through the AdStock web site at [village.steelcase.com](http://village.steelcase.com).

## Product Brochures

The following publications focus on wood seating in greater detail:

**Seating Overview**  
Form number 06-0000890

**Alcove**  
Form number S3012

**Collaboration**  
Form number S11078

**Deck**  
Form number S11198

**England**  
Form number S3007

**Escapade**  
Form number S11074

**Gentry**  
Form number S11076

**Mingle**  
Form number S10880

**Oriana**  
Form number S11079

**Siento**  
Form number 06-0001282

**Terrazzo**  
Form number S10886

**Topaz**  
Form number S11077

## Steelcase Inc. Corporate Capabilities Brochure

This publication offers a concise overview of Steelcase including insights into the attitudes and commitments that make the corporation unique. In addition, the brochure provides an illustrated listing of all the products and services offered and international activities are described.

## Printed Materials

### Surface Materials Reference Manual

This publication provides:

- An explanation of the surface materials and their categories
- “Available on” matrices
- Vertical surface fabric and seating upholstery selection listing
- Technical data for surface materials
- Surface material care and cleaning instructions

## Planning Tools

### Quick Ship Guide

This handbook describes all Steelcase, Turnstone, Details, and Coalesse products that are available for Rapid2 (ships in 2 days), Rapid5 (ships in 5-7 days), or Coalesse Rapid10 (ships in 10 days).

### Casegoods and Seating Delivered in 12 Days

A comprehensive collection of “wood” casegoods and seating products available for 12-day delivery.

Form number S3461

## Computer Tools

### Electronic Catalog

Accurate sales quotations and purchase orders for Steelcase products are created with specification software that uses Steelcase Electronic Catalog data. Use the data to specify and price style numbers and options for every Steelcase product. The data is updated bimonthly by Steelcase and provided to software programs including: the Hedberg Business System, SmartTools–Steelcase’s design and specification software (for more information on SmartTools, please email [SmartTools@steelcase.com](mailto:SmartTools@steelcase.com)), the ProjectMatrix ProjectSysmols libraries, as well as 20-20 CAP Studio.

### Furniture Symbol Graphic Data

Steelcase creates 2D and 3D furniture symbols (with attributes) for planning and initially specifying Steelcase products. This data is incorporated into several add-on software packages that work in either a Microstation or an AutoCAD drafting environment.

For more information about these and other software tools to help you plan effective work environments, please email [fsl@steelcase.com](mailto:fsl@steelcase.com).



### Digital Publications

If your device has a bar code reader App, scan this QR code for a direct link to the online digital publications. Utilizing this QR code allows you to search across multiple specification guides, share across social media, or print out pages. You can also access these digital publications at [www.steelcase.com](http://www.steelcase.com) or [village.steelcase.com](http://village.steelcase.com).

## Support

### Steelcase Capabilities

Steelcase products are distributed, installed, and serviced through a network of more than 600 dealers worldwide. Steelcase is also represented with offices and corporate showrooms in 26 U.S. cities, 4 Canadian cities, and in France, Germany, Great Britain, and Japan. Every Steelcase product meets our exceptionally high standards of quality and durability and comes with the Steelcase assurance of excellence in service.

**For assistance**, please call your local dealer, the Steelcase Solutions Resource Team, or the Steelcase Solutions Fulfillment Team at 1.888.STEELCASE (1.888.783.3522) or send an e-mail to [lineone@steelcase.com](mailto:lineone@steelcase.com).

Call the Steelcase Solutions Resource Team prior to placing an order, when working on a bid, or when you need information about product applications and specifications.

Call the Steelcase Solutions Fulfillment Team if you have submitted an order to Steelcase and you need to speak to your Solutions Fulfillment Team Representative about the order. Also call if you have any post-shipment quality or warranty concerns or service parts questions.

Outside the U.S.A., Canada, Mexico, Puerto Rico, and the U.S. Virgin Islands, call 1.616.247.2500.

For information about Steelcase, the name of your nearest Steelcase dealer, or for product literature, call 1.800.333.9939 or visit our Web site: [www.steelcase.com](http://www.steelcase.com).



---

# Executive Seating

<b>Siento</b>	<b>12</b>
<b>Mansfield</b>	<b>18</b>
<b>Theorem</b>	<b>22</b>

# Siento

**Siento desk chairs**, designed in collaboration with Jorge Pensi, merge remarkable ergonomic comfort with a slim and sophisticated executive form.

**Outer back** is fully upholstered.

**Patented LiveBack technology** (found in Steelcase Leap chair) is embedded in the back to change shape and mimic the user's spine.

**Arms** are available as either T-arms or enclosed. T-arms are available fixed or adjustable (height, width, pivot and depth).

**Arm uprights** are available in polished aluminum, platinum, or black.

**Five-arm base** is available in polished aluminum, platinum, or black.

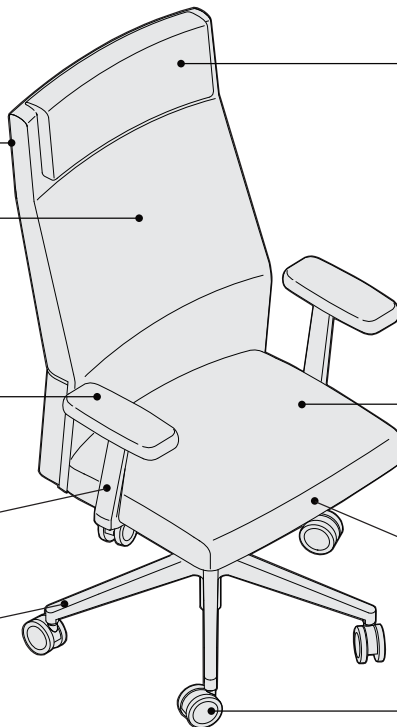

**Headrest option** provides additional head and neck support.

**Seat height** adjusts from 16" to 21" and is standard with pneumatic adjustment mechanism. Fixed-height option is also available.

**Front seat edge** flexes naturally to relieve pressure under the user's thighs.

**3" hard dual-wheel casters** are provided for use on carpet. Soft dual-wheel casters are available for use on hard floors or chair mats.

## Product Details



**High-back and mid-back desk chairs** are available.



**Arms** are available as T-arms or enclosed. T-arms are available as fixed or adjustable. Fixed T-arms are available in urethane or fully upholstered. Adjustable T-arms are available in urethane only. Enclosed arms are always fully upholstered.

**All Siento chairs** comply with ANSI/HFS and BIFMA standards.

## Adjustment Features

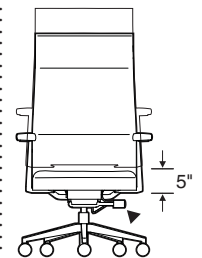

**Seat height** adjusts pneumatically. To lower, hold handle up while seated. To raise, hold handle up and keep your weight off the chair. Standard range of adjustability is 5" from 16"H to 21"H.

## Actual Dimensions

	High-Back Desk Chairs with Headrest	High-Back Desk Chairs without Headrest	Mid-Back Desk Chairs
Overall depth	26"	26"	26"
Overall width—outside of T-arms	27½"	27½"	27½"
Overall width—outside of enclosed arms	29½"	29½"	29½"
Overall height	46¾"—51¾"	46"—51"	40"—45"
Seat depth	17½"	17½"	17½"
Seat width	21"	21"	21"
Back height from seat	31½"	30"	24"
Width between arms	20½"	20½"	20½"
Arm height from seat	8"	8"	8"

## Adjustability Features

- Pneumatic seat-height
- Upright back lock
- Back tension control
- Synchro-tilt mechanism

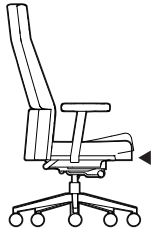

**Seat edge** flexes, relieving pressure under the user's thighs.



**Upright back lock.** Flick switch forward to lock; flick switch back to tilt.

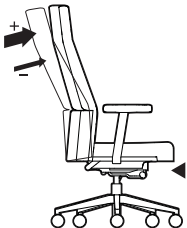

**Back tension control** adjusts by turning knob. Turn knob forward to increase rate of tension, backward to decrease.

**Synchro-tilt mechanism** provides synchronized back movement while feet remain flat on the floor.

**Height-, width-, pivot-, and depth-adjustable arms** are available on select models of chairs.

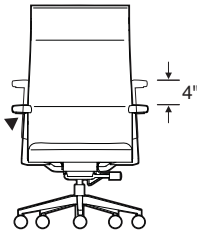

**Arm height** adjusts independently within a range of 4" (7"-11" from the seat). Push button on outside and under arm cap in while moving arms up or down. Releasing buttons locks arms in position.

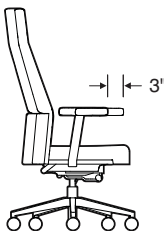

**Arm depth** adjusts by sliding arm caps back 3". Friction-fit mechanism keeps arms in position.

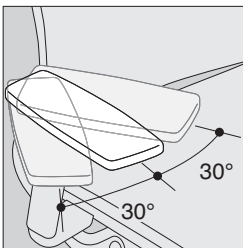

**Arms pivot** independently, 30° inward and outward.

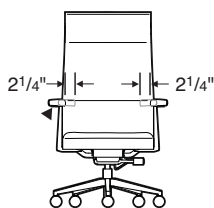

**Arm width** can be adjusted 2 1/4" each, 4 1/2" overall. Grasp arm cap and move in or out.

**Surface Materials**

**Upholstery**

- Fabric
- Fabric with soil-retardant treatment (option)
- Standard Steelcase
- Elmosoft leather
- COM
- COL

**Arms**

- Fixed T-arms or adjustable T-arms: Black urethane
- Fixed T-arms or adjustable T-arms: upholstered
- Enclosed arms: fully upholstered

**Column**

- Black only

**Base**

- 0835 Black
- 4799 Platinum
- 8046 Polished Aluminum

**Casters**

- Black wheels with black body on black or platinum base
- Black wheels with polished aluminum body on polished aluminum base

**All Steelcase seating with standard upholstery fabrics** complies with requirements of the State of California Technical Bulletin 117. All standard seating is labeled to be in compliance with California 117.

**Programs & Services**

► See the *Surface Materials Reference Manual* for further detail about programs and services offered for seating.

**The Customer's Own Material (COM & COL) Program**

offers the opportunity for customers to select fabrics and leather that are not offered through the standard Steelcase surface materials program for use on Steelcase products. Avoid pattern fabrics and heavily grained leathers. Through the COM & COL program, Steelcase will test your materials for application on Steelcase products. Once approved, you can place your order. Steelcase will facilitate the entire ordering process and give you a production schedule. Steelcase will order the COM & COL fabric and leather directly from the textile manufacturer. For up-to-date information regarding fabric test results for all COM & COL fabrics and details regarding yardage requirements for most Seating lines, visit the COM Web site. To locate the COM Web site:

- Visit [www.steelcase.com](http://www.steelcase.com)

**Soil retardants** are treatments that provide long-term soil and stain resistance to a fabric without affecting the shade or the integrity of the fabric. The following Steelcase Textiles are available pre-treated with soil retardant. (You do not need to select the soil-retardant option for these fabrics and incur the upcharge.)

- Jacks
- Link
- Spyder

For information on soil retardant fabrics on Select Surfaces, please refer to the *Surface Materials Reference Manual*.

Soil-retardant treatment is available on all other seating fabrics at an additional upcharge per seating unit. To order this option, please select "Soil-Retardant Treatment" under "Optional Accessories."

For soil-retardant treatment on COMs, please select "Soil-Retardant Treatment" under "Optional Accessories." Minimums or additional yardage may be required. Please contact the vendor directly for specific information.

Extended lead times may be necessary for this service.

Contact your Steelcase Solutions Fulfillment Team Representative at 1.888.STEELCASE (1.888.783.3522) or send an e-mail to [lineone@steelcase.com](mailto:lineone@steelcase.com).

**Local codes** may have special requirements for upholstery.

**Resources**

**Siento Brochure**  
Form number 06-0001282

# Siento Design Package High-Back Executive Chair



*Tip: This design package allows you to obtain the pre-selected features at a lower price than if specifying as a standard model number.*

*Tip: Options or substitutions are not available on this design package.*

Standard Includes		Required to Specify
<ul style="list-style-type: none"> <li>▶ Need help? Product details, page 12</li> </ul>	<ul style="list-style-type: none"> <li>• Back tension control</li> <li>• 5" pneumatic seat-height adjustment</li> <li>• Upright back lock</li> <li>• Fully upholstered outer back</li> <li>• Front seat edge flex</li> <li>• LiveBack technology</li> <li>• T-arms: upholstered</li> <li>• Headrest</li> <li>• Upholstery: Elmosoft leather</li> <li>• Five-arm base and arm uprights: 8046 Polished Aluminum</li> <li>• Column: black only</li> <li>• 3"-diameter, hard composition, dual-wheel casters: black wheels with polished aluminum body</li> </ul>	<ul style="list-style-type: none"> <li>1 Style number</li> <li>2 Elmosoft leather color number</li> <li>▶ See <i>Surface Materials</i>, page 90.</li> </ul>

Specification Information	
Style Number	U.S. Price
499SIENTO	\$3028



**For Canadian Pricing**  
 Multiply U.S. Price by the Canadian price factor.  
 ▶ See page 1 for details.



# Siento Executive Desk Chairs



*Tip: When a black or platinum painted base is specified, the casters will be black. When a polished aluminum base is specified, the casters will have black wheels with polished aluminum body.*

*Tip: When the standard polished aluminum base is specified along with adjustable T-arms, you must specify the finish for arm uprights in either 6205 Black or 6249 Platinum.*

*Tip: When base and adjustable T-arms are specified in 4799 Platinum, the arm upright will be in 4799 Platinum and the lower section of the arm will be in 6205 Black.*

*Tip: Always add suffixes in alphabetical order when specifying options to Siento seating.*

Standard Includes	Required to Specify
<ul style="list-style-type: none"> <li>▶ Need help? Product details, page 12</li> <li>• Back tension control</li> <li>• 5" pneumatic seat-height adjustment</li> <li>• Upright back lock</li> <li>• Front seat edge flex</li> <li>• LiveBack technology</li> <li>• Fully upholstered outer back</li> <li>• Fixed T-arms, if selected: soft black urethane</li> <li>• Adjustable T-arms, if selected: soft black urethane</li> <li>• Enclosed arms, if selected: fully upholstered</li> <li>• Upholstery: fabric price group 1</li> <li>• Five-arm base: paint or Polished Aluminum</li> <li>• Column: black only</li> <li>• 3"-diameter, hard-composition, dual-wheel casters: black</li> </ul>	<ul style="list-style-type: none"> <li>1 Style number</li> <li>2 Paint color number for base and arm supports</li> <li>3 Fabric color number for upholstery</li> <li>4 Options, if selected (see below)</li> <li>▶ See <i>Surface Materials</i>, page 90.</li> </ul>



Options	U.S. Price	Required to Specify
<p><b>Surface Materials</b></p>		
<p><b>Upholstery</b></p> <ul style="list-style-type: none"> <li>• Fabric price group 1</li> <li>• Fabric price group 2</li> <li>• Fabric price group 3</li> <li>• Fabric price group 4</li> <li>• Fabric price group 5</li> <li>• Fabric price group 6</li> <li>• Fabric price group 7</li> <li>• Fabric price group 8</li> <li>• Fabric price group 9</li> <li>• Fabric price group 10</li> <li>• Customer's Own Material (COM)</li> <li>• Steelcase leather upholstery</li> <li>• Customer's Own Leather (COL)</li> <li>• Elmosoft Leather</li> <li>• Sewn upholstery</li> <li>• Soil-retardant treatment applied to upholstery fabric</li> </ul>	<ul style="list-style-type: none"> <li>No cost</li> <li>+\$ 24</li> <li>+\$ 46</li> <li>+\$ 64</li> <li>+\$ 81</li> <li>+\$100</li> <li>+\$115</li> <li>+\$145</li> <li>+\$179</li> <li>+\$203</li> <li>+\$ 35</li> <li>+\$563</li> <li>+\$ 35</li> <li>+\$788</li> <li>No cost</li> <li>+\$ 23</li> </ul>	<ul style="list-style-type: none"> <li>Specify fabric color number.</li> <li>Specify fabric color number.</li> <li>Specify fabric color number.</li> <li>Specify fabric color number.</li> <li>Specify fabric color number.</li> <li>Specify fabric color number.</li> <li>Specify fabric color number.</li> <li>Specify fabric color number.</li> <li>Specify fabric color number.</li> <li>Specify fabric color number.</li> <li>▶ See <i>Surface Materials Reference Manual</i>.</li> <li>Add suffix <b>S</b> to the style number and specify leather color number.</li> <li>Add suffix <b>S</b> to the style number and specify COL.</li> <li>Add suffix <b>S</b> to the style number and specify Elmosoft leather color number.</li> <li>Add suffix <b>S</b> to the style number.</li> <li>▶ See <i>Surface Materials</i>, page 90.</li> <li>Specify <i>with soil-retardant treatment</i>.</li> </ul>
<p><b>T-arms</b></p> <ul style="list-style-type: none"> <li>• Fully upholstered T-arms</li> </ul>	<ul style="list-style-type: none"> <li>+\$ 87</li> </ul>	<ul style="list-style-type: none"> <li>Specify <i>with fully upholstered T-arms</i>.</li> </ul>
<p><b>Base and casters</b></p> <ul style="list-style-type: none"> <li>• 0835 Black base and black casters</li> <li>• 4799 Platinum base and black casters</li> </ul>	<ul style="list-style-type: none"> <li>No cost</li> <li>+\$ 82</li> </ul>	<ul style="list-style-type: none"> <li>Specify <i>with 0835 Black base</i>.</li> <li>Specify <i>with 4799 Platinum base</i>.</li> </ul>
<p><b>Seat Height</b></p> <ul style="list-style-type: none"> <li>• 18" fixed seat height</li> </ul>	<ul style="list-style-type: none"> <li>No cost</li> </ul>	<ul style="list-style-type: none"> <li>Specify <i>with fixed seat height</i>.</li> </ul>
<p><b>Headrest</b></p> <ul style="list-style-type: none"> <li>• Headrest on high-back chairs only</li> </ul>	<ul style="list-style-type: none"> <li>+\$112</li> </ul>	<ul style="list-style-type: none"> <li>Specify <i>with headrest</i>.</li> </ul>
<p><b>Casters</b></p> <ul style="list-style-type: none"> <li>• Soft, dual-wheel casters for use on hard floors</li> </ul>	<ul style="list-style-type: none"> <li>+\$ 23</li> </ul>	<ul style="list-style-type: none"> <li>Specify <i>with soft casters</i>.</li> </ul>



**For Canadian Pricing**  
 Multiply U.S. Price by the Canadian price factor.  
 ▶ See page 1 for details.





**Specification Information**

	Fixed T-Arms		Enclosed Upholstered Arms		Adjustable T-Arms	
						
• Description	• Style Number	• U.S. Base Price	• Style Number	• U.S. Base Price	• Style Number	• U.S. Base Price

**High-Back Chairs**

Painted Base	<b>499211</b>	\$1754	<b>499212</b>	\$1984	<b>499213</b>	\$2025
Polished Aluminum Base	<b>499221</b>	\$2100	<b>499222</b>	\$2330	<b>499223</b>	\$2371

	Fixed T-Arms		Enclosed Upholstered Arms		Adjustable T-Arms	
						
• Description	• Style Number	• U.S. Base Price	• Style Number	• U.S. Base Price	• Style Number	• U.S. Base Price

**Mid-Back Chairs**

Painted Base	<b>499111</b>	\$1639	<b>499112</b>	\$1869	<b>499113</b>	\$1910
Polished Aluminum Base	<b>499121</b>	\$1985	<b>499122</b>	\$2215	<b>499123</b>	\$2256



**For Canadian Pricing**  
 Multiply U.S. Price by the Canadian price factor.  
 ▶ See page 1 for details.

# Mansfield

## Desk Chairs

**Mansfield** desk seating is a cost-effective, traditional collection with Chippendale aesthetics. Mansfield desk chairs complement Norfolk wood casegoods.  
 ▶ See Mansfield guest chair, page 56.

**Brass tack accenting** is optional.

**Seat height adjusts** from 18½"H to 21½"H. Pneumatic adjustment mechanism is standard.

**Five-arm base** with maple base caps is standard.

**Antique brass-hooded ball casters** are standard.

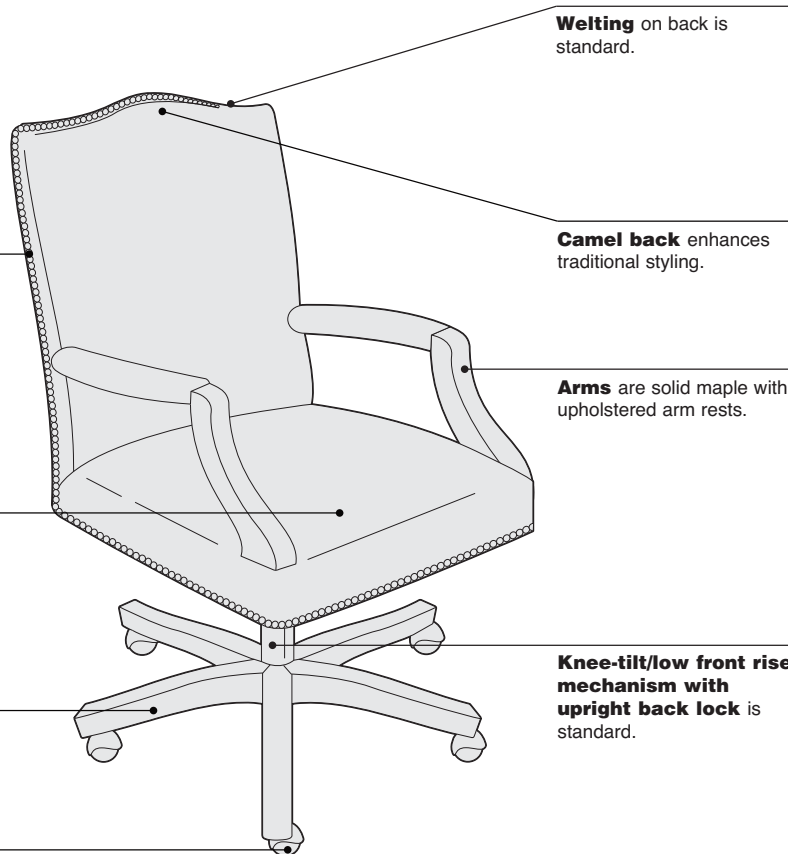

**Welting** on back is standard.

**Camel back** enhances traditional styling.

**Arms** are solid maple with upholstered arm rests.

**Knee-tilt/low front rise mechanism with upright back lock** is standard.

### Product Details



**Mid- and high-back desk chairs** are available.

**Five-arm base** provides optimum balance. It is standard with maple base caps that are stained in the selected wood color.

### Actual Dimensions

	High-Back Desk Chairs	Mid-Back Desk Chairs
Overall depth	30½"	28½"
Overall width	24½"	24½"
Overall height	43⅞"–46⅜"	38¾"–41¼"
Seat depth	19½"	19½"
Seat width	19"	19"
Back width	21"	21"
Back height from seat	27½"	22½"
Width between arms	19"	19"
Seat to floor height	18½"–21½"	18½"–21½"
Arm height from floor	25⅜"–27⅞"	25⅜"–27⅞"

### Adjustability Features

- Pneumatic height
- Knee-tilt mechanism
- Upright back lock
- Back tension

## Adjustment Features

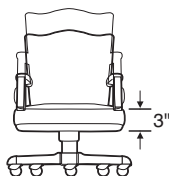

**Pneumatic-height adjustment,** standard on all desk chair models, allows seat height adjustment from 18½"H to 21½"H with fingertip pneumatic lever. To lower, hold handle up while seated. To raise, hold handle up and lift your weight off the chair.

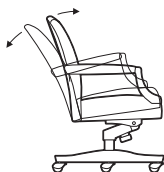

**Knee-tilt (low front rise)** minimizes the rise of the front of the seat when the chair is in a reclined position, allowing the user's feet to remain on the floor. This feature reduces pressure under the thighs, allowing for continuous blood circulation.



**Back tension control** varies reclining back support from light to firm and adjusts by turning knob. Turn knob clockwise to decrease tension, counterclockwise to increase.

*Tip: Be sure to unlock (release) the variable back stop before adjusting the back tension.*

**Upright back lock.** To lock back upright, push lever down while sitting upright. To release back lock, pull lever up while sitting upright.

## Surface Materials

### Upholstery

- Vinyl
- Fabric
- Fabric with soil-retardant treatment (option)
- Leather
- COM
- COL

### Arms

- Wood with upholstered arm caps

### Base and column

- Wood base caps and black column

### Frame

- Wood

*Tip: Arms and base caps are constructed of solid maple. Finishes applied to maple will match the color of stains applied to oak, walnut, or cherry, but will not show the same natural grain.*

- Customiz stain on wood (option)

### Casters

- Antique brass only

### Wood touch-up kits

- Available in specific finishes for field repairs
- ▶ Page 98

**All Steelcase seating with standard upholstery fabrics** complies with requirements of the State of California Technical Bulletin 117. All standard seating is labeled to be in compliance with California 117.

## Programs & Services

▶ See the *Surface Materials Reference Manual* for further detail about programs and services offered for seating.

### The Customer's Own Material (COM & COL)

**Program** offers the opportunity for customers to select fabrics and leather that are not offered through the standard Steelcase surface materials program for use on Steelcase products. Avoid pattern fabrics and heavily grained leathers. Through the COM & COL program, Steelcase will test your materials for application on Steelcase products. Once approved, you can place your order. Steelcase will facilitate the entire ordering process and give you a production schedule. Steelcase will order the COM & COL fabric and leather directly from the textile manufacturer. For up-to-date information regarding fabric test results for all COM & COL fabrics and details regarding yardage requirements for most Seating lines, visit the COM Web site. To locate the COM Web site:

- Visit [www.steelcase.com](http://www.steelcase.com)

**Soil retardants** are treatments that provide long-term soil and stain resistance to a fabric without affecting the shade or the integrity of the fabric. The following Steelcase Textiles are available pre-treated with soil retardant. (You do not need to select the soil-retardant option for these fabrics and incur the upcharge.)

- Jacks
- Link
- Spyder

For information on soil retardant fabrics on Select Surfaces, please refer to the *Surface Materials Reference Manual*.

Soil-retardant treatment is available on all other seating fabrics at an additional upcharge per seating unit. To order this option, please select "Soil-Retardant Treatment" under "Optional Accessories."

For soil-retardant treatment on COMs, please select "Soil-Retardant Treatment" under "Optional Accessories." Minimums or additional yardage may be required. Please contact the vendor directly for specific information.

Extended lead times may be necessary for this service.

Contact your Steelcase Solutions Fulfillment Team Representative at 1.888.STEELCASE (1.888.783.3522) or send an e-mail to [lineone@steelcase.com](mailto:lineone@steelcase.com).

## Resources

**Traditional Brochure**  
Form number S11196

**Chairs for People at Work**  
Form number S11347

**Quick Ship Guide**

**Casegoods and Seating Delivered in 12 Days**

Form number S3461

# Mansfield Desk Chairs

	Standard Includes	Required to Specify
▶ Need help? Product details, page 18	<ul style="list-style-type: none"> <li>• Back tension control</li> <li>• Knee-tilt mechanism</li> <li>• Upright back lock</li> <li>• Upholstery: fabric price group 1</li> <li>• Five-arm base: maple base caps</li> <li>• Column: black only</li> <li>• Antique brass-hooded hard-composition ball casters</li> </ul>	<ol style="list-style-type: none"> <li>1 Style number</li> <li>2 Wood color number for base caps and arms</li> <li>3 Fabric color number for upholstery</li> <li>4 Options, if selected (see below)</li> </ol> <p>▶ See <i>Surface Materials</i>, page 90.</p>

	Options	U.S. Price	Required to Specify
<b>Surface Materials</b>	<b>Upholstery</b>		
	• Fabric price group 1	No cost	Specify fabric color number.
	• Fabric price group 2	+\$ 35	Specify fabric color number.
	• Fabric price group 3	+\$114	Specify fabric color number.
	• Fabric price group 4	+\$143	Specify fabric color number.
	• Fabric price group 5	+\$197	Specify fabric color number.
	• Fabric price group 6	+\$250	Specify fabric color number.
	• Fabric price group 7	+\$297	Specify fabric color number.
	• Fabric price group 8	+\$434	Specify fabric color number.
	• Fabric price group 9	+\$556	Specify fabric color number.
• Fabric price group 10	+\$679	Specify fabric color number.	
• Leather price group	+\$967	Specify leather color number.	
• Customer's Own Material (COM)	+\$ 52	▶ See <i>Surface Materials Reference Manual</i> .	
• Customer's Own Leather (COL)	+\$ 52	▶ See <i>Surface Materials Reference Manual</i> .	
• Soil-retardant treatment applied to upholstery fabric	+\$ 23	Specify with <i>soil-retardant treatment</i> .	
	<b>Brass tacks</b>	+\$ 50	Add suffix <b>B</b> to the style number.
	<b>Frame</b>		
	• Customiz stain on wood	No cost	Specify with <i>Customiz stain</i> . ▶ See <i>Surface Materials Reference Manual</i> .

## Specification Information

High-Back Desk Chair



Mid-Back Desk Chair



Description	High-Back Desk Chair		Mid-Back Desk Chair	
	Style Number	U.S. Base Price	Style Number	U.S. Base Price
Pneumatic-height adjustment	140	\$1286	141	\$1143



**For Canadian Pricing**  
Multiply U.S. Price by the Canadian price factor.  
▶ See page 1 for details.



# Theorem

**Theorem** desk chairs, a Lisa Smith design, have a neutral, rectilinear design that is appropriate in contemporary or transitional settings. This chair line offers numerous ergonomic support features.

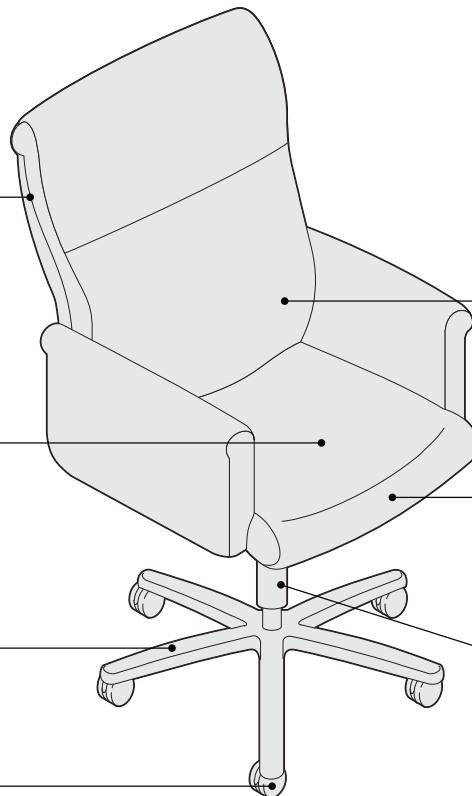

**Double stitching** accents the back and seat.

**Seat height adjusts** from 16"H to 21"H and is available with pneumatic adjustment mechanism.

**Five-arm base** is standard in black aluminum. Solid maple base caps are optional.

**Hard dual-wheel casters** are provided for use on carpet. Soft dual-wheel casters are available for use on hard floors or chair mats.

**Lumbar contours** provide lower back support.

**Waterfall front edge** eases pressure under user's legs and enhances circulation.

**Synchro-tilt mechanism**

## Product Details



**High- and mid-back desk chairs** are available.



**Enclosed arms** are upholstered.

**Extended-depth seat option**, at 17½", adds 1½" to accommodate longer legs.

**All Theorem desk chairs** comply with ANSI/HFS and BIFMA standards.

*Exception: The extended seat option exceeds ANSI/HFS seat depth restrictions.*

## Actual Dimensions

	High-Back Desk Chairs	Mid-Back Desk Chairs
Overall depth	25"	25"
Overall width	28"	28"
Overall height	46"–51"	41"–46"
Seat depth	16"	16"
Seat width	20½"	20½"
Back width	20½"	20½"
Back height	30"	25"
Width between arms	20½"	20½"
Seat to floor height	16"–21"	16"–21"
Arm height from floor	24¾"–30¼"	24¾"–30¼"

## Adjustability Features

- Pneumatic height
- Variable back stop
- Back tension control
- Synchro-tilt mechanism

## Adjustment Features

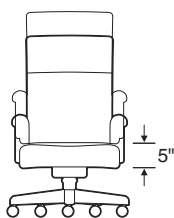

**Pneumatic-height adjustment** is available to allow push-button control from 16"H to 21"H. To lower, pull lever on right side while seated. To raise, pull lever and lift your weight off the chair.

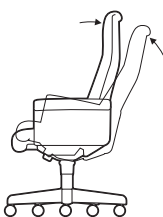

**Variable back stop** allows the back to stop at various tilt angles, including fully upright. Flick switch forward for full range of back angles. To limit back angle, recline to the desired position and flick switch back. *Tip: To lock in upright position, remove weight from back and flick switch back.*

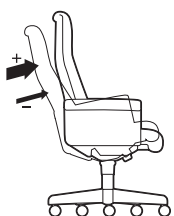

**Back tension control** varies reclining back support from light to firm and adjusts by turning knob. Turn knob clockwise to decrease tension, counterclockwise to increase. *Tip: Be sure to unlock (release) the variable back stop before adjusting the back tension.*

**Synchro-tilt mechanism** provides synchro-tilted back movement while feet remain flat on floor.

## Surface Materials

### Upholstery

- Vinyl
- Fabric
- Fabric with soil-retardant treatment (option)
- Leather
- COM
- COL

### Arms

- Enclosed upholstered arms

### Column

- Black only

### Base

- Black aluminum (standard)
- Polished aluminum (option)
- Wood base caps (option)
- Customiz stain on wood (option)

### Casters

- Black only

### Wood touch-up kits

- Available in specific finishes for field repairs
- ▶ Page 98

**All Steelcase seating with standard upholstery fabrics** complies with requirements of the State of California Technical Bulletin 117. All standard seating is labeled to be in compliance with California 117.

## Programs & Services

▶ See the *Surface Materials Reference Manual* for further detail about programs and services offered for seating.

### The Customer's Own Material (COM & COL)

**Program** offers the opportunity for customers to select fabrics and leather that are not offered through the standard Steelcase surface materials program for use on Steelcase products. Avoid pattern fabrics and heavily grained leathers. Through the COM & COL program, Steelcase will test your materials for application on Steelcase products. Once approved, you can place your order. Steelcase will facilitate the entire ordering process and give you a production schedule. Steelcase will order the COM & COL fabric and leather directly from the textile manufacturer. For up-to-date information regarding fabric test results for all COM & COL fabrics and details regarding yardage requirements for most Seating lines, visit the COM Web site. To locate the COM Web site:

- Visit [www.steelcase.com](http://www.steelcase.com)

**Soil retardants** are treatments that provide long-term soil and stain resistance to a fabric without affecting the shade or the integrity of the fabric. The following Steelcase Textiles are available pre-treated with soil retardant. (You do not need to select the soil-retardant option for these fabrics and incur the upcharge.)

- Jacks
- Link
- Spyder

For information on soil retardant fabrics on Select Surfaces, please refer to the *Surface Materials Reference Manual*.

Soil-retardant treatment is available on all other seating fabrics at an additional upcharge per seating unit. To order this option, please select "Soil-Retardant Treatment" under "Optional Accessories."

For soil-retardant treatment on COMs, please select "Soil-Retardant Treatment" under "Optional Accessories." Minimums or additional yardage may be required. Please contact the vendor directly for specific information.

Extended lead times may be necessary for this service.

Contact your Steelcase Solutions Fulfillment Team Representative at 1.888.STEELCASE (1.888.783.3522) or send an e-mail to [lineone@steelcase.com](mailto:lineone@steelcase.com).

## Resources

### Seating Overview

Form number 06-0000890

### Chairs for People at Work

Form number S11347

### Quick Ship Guide

### Casegoods and Seating Delivered in 12 Days

Form number S3461

# Theorem Desk Chairs **X4/15**



Standard Includes		Required to Specify	
<ul style="list-style-type: none"> <li>▶ Need help? Product details, page 22</li> </ul>	<ul style="list-style-type: none"> <li>• Back tension control</li> <li>• Upholstery: fabric price group 1</li> <li>• Five-arm base: black aluminum</li> <li>• Column: black only</li> <li>• 2"-diameter, hard-composition, dual-wheel casters: black only</li> </ul>	<ol style="list-style-type: none"> <li>1 Style number</li> <li>2 Fabric color number for upholstery</li> <li>3 Options, if selected (see below)</li> </ol>	<ul style="list-style-type: none"> <li>▶ See <i>Surface Materials</i>, page 90.</li> </ul>

Options	U.S. Price	Required to Specify	
<b>Surface Materials</b>	<b>Upholstery</b>		
	<ul style="list-style-type: none"> <li>• Fabric price group 1 No cost</li> <li>• Fabric price group 2 +\$ 46</li> <li>• Fabric price group 3 +\$152</li> <li>• Fabric price group 4 +\$191</li> <li>• Fabric price group 5 +\$261</li> <li>• Fabric price group 6 +\$334</li> <li>• Fabric price group 7 +\$394</li> <li>• Fabric price group 8 +\$580</li> <li>• Fabric price group 9 +\$742</li> <li>• Fabric price group 10 +\$903</li> <li>• Leather price group +\$967</li> <li>• Customer's Own Material (COM) +\$ 64</li> <li>• Customer's Own Leather (COL) +\$ 64</li> <li>• Soil-retardant treatment applied to upholstery fabric +\$ 23</li> </ul>	<ul style="list-style-type: none"> <li>Specify fabric color number.</li> <li>Specify fabric color number.</li> <li>Specify fabric color number.</li> <li>Specify fabric color number.</li> <li>Specify fabric color number.</li> <li>Specify fabric color number.</li> <li>Specify fabric color number.</li> <li>Specify fabric color number.</li> <li>Specify fabric color number.</li> <li>Specify fabric color number.</li> <li>Specify leather color number.</li> <li>▶ See <i>Surface Materials Reference Manual</i>.</li> <li>▶ See <i>Surface Materials Reference Manual</i>.</li> <li>Specify with soil-retardant treatment.</li> </ul>	
	<b>Base</b>		
	<ul style="list-style-type: none"> <li>• Maple wood base +\$113</li> <li>• Customiz stain on wood base No cost</li> </ul>	<ul style="list-style-type: none"> <li>Specify with wood base and select wood color number.</li> <li>Specify with Customiz stain.</li> <li>▶ See <i>Surface Materials Reference Manual</i>.</li> </ul>	
<b>Casters</b>	<ul style="list-style-type: none"> <li>• 2"-diameter, soft, dual-wheel +\$ 23</li> </ul>	<ul style="list-style-type: none"> <li>Specify with soft casters.</li> </ul>	



**For Canadian Pricing**  
 Multiply U.S. Price by the Canadian price factor.  
 ▶ See page 1 for details.

**X4/15** = Last order entry  
 April 19, 2015



**Specification Information**

**Enclosed Upholstered Arms**

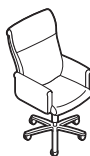

Description	Style Number	U.S. Base Price
-------------	--------------	-----------------

**High-Back**

Pneumatic-height adjustment	<b>711N</b> <del>4/15</del>	\$1827
with variable back stop	<b>711NS</b> <del>4/15</del>	\$1925
with extended seat	<b>711NX</b> <del>4/15</del>	\$1925
with variable back stop and extended seat	<b>711NSX</b> <del>4/15</del>	\$2023

**Enclosed Upholstered Arms**



Description	Style Number	U.S. Base Price
-------------	--------------	-----------------

**Mid-Back**

Pneumatic-height adjustment	<b>721N</b> <del>4/15</del>	\$1681
with variable back stop	<b>721NS</b> <del>4/15</del>	\$1779
with extended seat	<b>721NX</b> <del>4/15</del>	\$1779
with variable back stop and extended seat	<b>721NSX</b> <del>4/15</del>	\$1877



**For Canadian Pricing**  
 Multiply U.S. Price by the Canadian price factor.  
 ▶ See page 1 for details.

~~4/15~~ = Last order entry  
 April 19, 2015



---

# General-Use Seating

**Gentry**

**28**

General-Use

# Gentry

## Desk Chairs

**Gentry** chairs, designed by Arnie Dammermann, provide contemporary styling with a distinctive design that features clean, simple lines and natural contours.

▶ See *Gentry Guest Chair*, page 52.



**Back** provides solid ergonomic support.

**Seat height adjusts** from 16"H to 20½"H.

**Waterfall seat edge** relieves pressure behind user's legs and enhances circulation.

**Five-arm base** is black metal with black plastic base caps or maple base caps.

**Hard dual-wheel casters** are provided for use on carpet. Soft dual-wheel casters are available for use on hard floors or chair mats.

### Actual Dimensions

	High-Back Desk Chairs		Low-Back Desk Chairs	
	Open arms	Enclosed arms	Open arms	Enclosed arms
Overall depth	26"	26"	26"	26"
Overall width	25"	25"	25"	25"
Overall height	38¼"–42¾"	38¼"–42¾"	33¼"–37¾"	33¼"–37¾"
Seat depth	16½"	16½"	16½"	16½"
Seat width	20½"	20½"	20½"	20½"
Back width	21"	21"	21"	21"
Back height	24"	24"	19"	19"
Width between arms	20"	20"	20"	20"
Seat to floor height	16"–20½"	16"–20½"	16"–20½"	16"–20½"
Arm height from floor	22½"–27"	22½"–27"	22½"–27"	22½"–27"

### Adjustability Features

- Pneumatic height
- Swivel-tilt control
- Back tension control

## Product Details

**Wood and thermoplastic models** are available with high and low backs.



**Guest chair** is available with a maple frame only.  
▶ Page 52

**Arms on wood desk models** are either enclosed upholstered or open maple with upholstered arm caps.

**Arms on thermoplastic models** are enclosed upholstered on high backs and low backs. Low backs also have available open thermoplastic that are black plastic colored.

## Adjustment Features

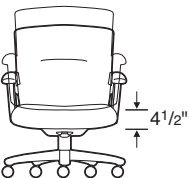

**Pneumatic-height adjustment**, available on swivel-tilt base models, allows seat height adjustment from 16"H to 20½"H with fingertip pneumatic lever. To lower, hold handle up while seated. To raise, hold handle up and lift your weight off the chair.

**Back tension** varies reclining back support from light to firm and adjusts by turning knob. Turn knob clockwise to decrease tension, counterclockwise to increase.

*Tip: Be sure to unlock (release) the variable back stop before adjusting the back tension.*

## Surface Materials

### Seat and back

- Vinyl
- Fabric
- Fabric with soil-retardant treatment (option)
- Leather
- COM
- COL

### Arms

- Enclosed upholstered arms
- Open wood arms with upholstered arm caps
- Open black plastic arms

### Column

- Black metal only

### Base

- Wood models have black metal base with solid maple base caps
- Thermoplastic models have black metal base with black plastic base caps
- Customiz stain on wood (option)

### Casters

- Black only

### Wood touch-up kits

- Available in specific finishes for field repairs
- ▶ Page 98

**All Steelcase seating with standard upholstery fabrics** complies with requirements of the State of California Technical Bulletin 117. All standard seating is labeled to be in compliance with California 117.

## Programs & Services

▶ See the *Surface Materials Reference Manual* for further detail about programs and services offered for seating.

### The Customer's Own Material (COM & COL) Program

offers the opportunity for customers to select fabrics and leather that are not offered through the standard Steelcase surface materials program for use on Steelcase products. Avoid pattern fabrics and heavily grained leathers. Through the COM & COL program, Steelcase will test your materials for application on Steelcase products. Once approved, you can place your order. Steelcase will facilitate the entire ordering process and give you a production schedule. Steelcase will order the COM & COL fabric and leather directly from the textile manufacturer. For up-to-date information regarding fabric test results for all COM & COL fabrics and details regarding yardage requirements for most Seating lines, visit the COM Web site. To locate the COM Web site:

- Visit [www.steelcase.com](http://www.steelcase.com)

**Soil retardants** are treatments that provide long-term soil and stain resistance to a fabric without affecting the shade or the integrity of the fabric. The following Steelcase Textiles are available pre-treated with soil retardant. (You do not need to select the soil-retardant option for these fabrics and incur the upcharge.)

- Jacks
- Link
- Spyder

For information on soil retardant fabrics on Select Surfaces, please refer to the *Surface Materials Reference Manual*.

Soil-retardant treatment is available on all other seating fabrics at an additional upcharge per seating unit. To order this option, please select "Soil-Retardant Treatment" under "Optional Accessories."

For soil-retardant treatment on COMs, please select "Soil-Retardant Treatment" under "Optional Accessories." Minimums or additional yardage may be required. Please contact the vendor directly for specific information.

Extended lead times may be necessary for this service.

Contact your Steelcase Solutions Fulfillment Team Representative at 1.888.STEELCASE (1.888.783.3522) or send an e-mail to [lineone@steelcase.com](mailto:lineone@steelcase.com).

## Resources

**Gentry Brochure**  
Form number S11076

**Chairs for People at Work**  
Form number S11347

### Quick Ship Guide

**Casegoods and Seating Delivered in 12 Days**  
Form number S3461

# Gentry Desk Chairs X4/15

Wood Models



Standard Includes		Required to Specify	
<ul style="list-style-type: none"> <li>▶ Need help? Product details, page 28</li> </ul>	<ul style="list-style-type: none"> <li>• Back tension control</li> <li>• Swivel-tilt control</li> <li>• Upholstery: fabric price group 1</li> <li>• Five-arm base: black metal with maple base caps</li> <li>• Column: black only</li> <li>• 2"-diameter, hard-composition, dual-wheel casters: black only</li> </ul>	<ol style="list-style-type: none"> <li>1 Style number</li> <li>2 Fabric color number for upholstery</li> <li>3 Wood color number for base and arms, if applicable</li> <li>4 Options, if selected (see below)</li> </ol>	<ul style="list-style-type: none"> <li>▶ See <i>Surface Materials</i>, page 90.</li> </ul>

Options	U.S. Price	Required to Specify	
<b>Surface Materials</b> <b>Upholstery</b> <ul style="list-style-type: none"> <li>• Fabric price group 1</li> <li>• Fabric price group 2</li> <li>• Fabric price group 3</li> <li>• Fabric price group 4</li> <li>• Fabric price group 5</li> <li>• Fabric price group 6</li> <li>• Fabric price group 7</li> <li>• Fabric price group 8</li> <li>• Fabric price group 9</li> <li>• Fabric price group 10</li> <li>• Leather price group</li> <li>• Customer's Own Material (COM)</li> <li>• Customer's Own Leather (COL)</li> <li>• Soil-retardant treatment applied to upholstery fabric</li> </ul>	<ul style="list-style-type: none"> <li>No cost</li> <li>+\$ 35</li> <li>+\$114</li> <li>+\$143</li> <li>+\$197</li> <li>+\$250</li> <li>+\$297</li> <li>+\$434</li> <li>+\$556</li> <li>+\$679</li> <li>+\$654</li> <li>+\$ 52</li> <li>+\$ 52</li> <li>+\$ 23</li> </ul>	<ul style="list-style-type: none"> <li>Specify fabric color number.</li> <li>Specify fabric color number.</li> <li>Specify fabric color number.</li> <li>Specify fabric color number.</li> <li>Specify fabric color number.</li> <li>Specify fabric color number.</li> <li>Specify fabric color number.</li> <li>Specify fabric color number.</li> <li>Specify fabric color number.</li> <li>Specify fabric color number.</li> <li>Specify leather color number.</li> </ul>	<ul style="list-style-type: none"> <li>▶ See <i>Surface Materials Reference Manual</i>.</li> <li>▶ See <i>Surface Materials Reference Manual</i>.</li> </ul> <p>Specify with soil-retardant treatment.</p>
<b>Base</b> <ul style="list-style-type: none"> <li>• Customiz stain on wood</li> </ul>	<ul style="list-style-type: none"> <li>No cost</li> </ul>	<ul style="list-style-type: none"> <li>Specify with Customiz stain.</li> </ul>	<ul style="list-style-type: none"> <li>▶ See <i>Surface Materials Reference Manual</i>.</li> </ul>
<b>Casters</b> <ul style="list-style-type: none"> <li>• 2"-diameter, soft, dual-wheel</li> </ul>	<ul style="list-style-type: none"> <li>+\$ 23</li> </ul>	<ul style="list-style-type: none"> <li>Specify with soft casters.</li> </ul>	



## For Canadian Pricing

Multiply U.S. Price by the Canadian price factor.

▶ See page 1 for details.

X4/15 = Last order entry  
April 19, 2015

**Specification Information**

**Enclosed Upholstered Arms**



**Open Wood Arms with Upholstered Arm Caps**



Description	Style Number	U.S. Base Price	Style Number	U.S. Base Price
-------------	--------------	-----------------	--------------	-----------------

**High-Back**

Pneumatic-height adjustment	<b>0644WN</b> X4/15	\$1701	<b>0643WN</b> X4/15	\$1589
-----------------------------	---------------------	--------	---------------------	--------

**Enclosed Upholstered Arms**



**Open Wood Arms with Upholstered Arm Caps**



Description	Style Number	U.S. Base Price	Style Number	U.S. Base Price
-------------	--------------	-----------------	--------------	-----------------

**Low-Back**

Pneumatic-height adjustment	<b>0634WN</b> X4/15	\$1611	<b>0633WN</b> X4/15	\$1502
-----------------------------	---------------------	--------	---------------------	--------

General-Use

**Additional guest chairs** that match Gentry wood desk chairs are available.  
▶ See page 52



 **For Canadian Pricing**  
Multiply U.S. Price by the Canadian price factor.  
▶ See page 1 for details.

X4/15 = Last order entry  
April 19, 2015

# Gentry Desk Chairs X4/15

Thermoplastic Models



Standard Includes		Required to Specify	
<ul style="list-style-type: none"> <li>▶ Need help? Product details, page 28</li> </ul>	<ul style="list-style-type: none"> <li>• Back tension control</li> <li>• Swivel-tilt control</li> <li>• Upholstery: fabric price group 1</li> <li>• Five-arm base: black metal with black plastic base caps</li> <li>• Column: black only</li> <li>• 2"-diameter, hard-composition, dual-wheel casters: black only</li> </ul>	<ul style="list-style-type: none"> <li>1 Style number</li> <li>2 Fabric color number for upholstery</li> <li>3 Options, if selected (see below)</li> </ul>	<ul style="list-style-type: none"> <li>▶ See <i>Surface Materials</i>, page 90.</li> </ul>

	Options	U.S. Price	Required to Specify
<b>Surface Materials</b>	<b>Upholstery</b>		
	• Fabric price group 1	No cost	Specify fabric color number.
	• Fabric price group 2	+\$ 35	Specify fabric color number.
	• Fabric price group 3	+\$114	Specify fabric color number.
	• Fabric price group 4	+\$143	Specify fabric color number.
	• Fabric price group 5	+\$197	Specify fabric color number.
	• Fabric price group 6	+\$250	Specify fabric color number.
	• Fabric price group 7	+\$297	Specify fabric color number.
	• Fabric price group 8	+\$434	Specify fabric color number.
	• Fabric price group 9	+\$556	Specify fabric color number.
• Fabric price group 10	+\$679	Specify fabric color number.	
• Leather price group	+\$654	Specify leather color number.	
• Customer's Own Material (COM)	+\$ 52	▶ See <i>Surface Materials Reference Manual</i> .	
• Customer's Own Leather (COL)	+\$ 52	▶ See <i>Surface Materials Reference Manual</i> .	
• Soil-retardant treatment applied to upholstery fabric	+\$ 23	Specify <i>with soil-retardant treatment</i> .	
<b>Castors</b>	• 2"-diameter, soft, dual-wheel	+\$ 23	Specify <i>with soft castors</i> .



### For Canadian Pricing

Multiply U.S. Price by the Canadian price factor.

▶ See page 1 for details.

X4/15 = Last order entry  
April 19, 2015



**Specification Information**

**Enclosed Upholstered Arms**



Description	Style Number	U.S. Base Price

**High-Back**

Pneumatic-height adjustment	<b>0644BN</b> <span style="color: red;">X4/15</span>	\$1580
-----------------------------	--	--------

**Enclosed Upholstered Arms**



Description	Style Number	U.S. Base Price

**Open Thermoplastic Arms**



Description	Style Number	U.S. Base Price

**Low-Back**

Pneumatic-height adjustment	<b>0634BN</b> <span style="color: red;">X4/15</span>	\$1490	<b>0632BN</b> <span style="color: red;">X4/15</span>	\$1194
-----------------------------	--	--------	--	--------

General-Use



**For Canadian Pricing**  
 Multiply U.S. Price by the Canadian price factor.  
 ▶ See page 1 for details.

X4/15 = Last order entry  
 April 19, 2015



---

# Guest Seating

<b>Alcove</b>	<b>36</b>
<b>Collaboration</b>	<b>40</b>
<b>England</b>	<b>44</b>
<b>Escapade</b>	<b>48</b>
<b>Gentry</b>	<b>52</b>
<b>Mansfield</b>	<b>56</b>
<b>Mingle</b>	<b>60</b>
<b>Oriana</b>	<b>64</b>
<b>Sawyer</b>	<b>68</b>
<b>Snodgrass</b>	<b>72</b>
<b>Terrazzo</b>	<b>76</b>
<b>Topaz</b>	<b>80</b>

# Alcove

**Alcove** is a contemporary guest chair with upholstered seat and back.

**Frame** is European beech wood.

**Back and seat** are fully upholstered.

**Arms** are one-piece solid wood construction and form a gentle curve to provide comfortable seating.

**Upholstered seat** features a webbed panel construction.

**Stretcher rails** provide additional support.

**Legs** are solid wood.

**Glides** are 1/2" in diameter.

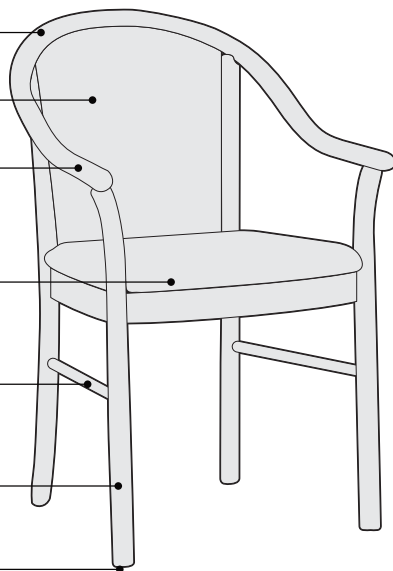

## Actual Dimensions

Overall depth	22"
Overall width	22 1/2"
Overall height	34"
Seat depth	16 1/4"
Seat width	16"
Back width	15 1/2"
Back height	17"
Width between arms	16 1/2"
Seat to floor height	18"
Arm height from floor	25"

## Surface Materials

### Upholstery

- Fabric
- Fabric with soil-retardant treatment (option)
- Leather
- COM
- COL

### Frame

- European Beech
- Tip: Wood finishes applied to beech will match the color of stains applied to oak, walnut, or cherry but will not have the same natural grain.*

### Glides

- Stainless steel only

### Wood touch-up kits

- Available in specific finishes for field repairs
- ▶ Page 98

**All Steelcase seating with standard upholstery fabrics** complies with requirements of the State of California Technical Bulletin 117. All standard seating is labeled to be in compliance with California 117.

## Programs & Services

▶ See the *Surface Materials Reference Manual* for further detail about programs and services offered for seating.

### The Customer's Own Material (COM & COL)

**Program** offers the opportunity for customers to select fabrics and leather that are not offered through the standard Steelcase surface materials program for use on Steelcase products. Avoid pattern fabrics and heavily grained leathers. Through the COM & COL program, Steelcase will test your materials for application on Steelcase products. Once approved, you can place your order. Steelcase will facilitate the entire ordering process and give you a production schedule. Steelcase will order the COM & COL fabric and leather directly from the textile manufacturer. For up-to-date information regarding fabric test results for all COM & COL fabrics and details regarding yardage requirements for most Seating lines, visit the COM Web site. To locate the COM Web site:

- Visit [www.steelcase.com](http://www.steelcase.com)

**Soil retardants** are treatments that provide long-term soil and stain resistance to a fabric without affecting the shade or the integrity of the fabric. The following Steelcase Textiles are available pre-treated with soil retardant. (You do not need to select the soil-retardant option for these fabrics and incur the upcharge.)

- Jacks
- Link
- Spyder

For information on soil retardant fabrics on Select Surfaces, please refer to the *Surface Materials Reference Manual*.

Soil-retardant treatment is available on all other seating fabrics at an additional upcharge per seating unit. To order this option, please select "Soil-Retardant Treatment" under "Optional Accessories."

For soil-retardant treatment on COMs, please select "Soil-Retardant Treatment" under "Optional Accessories." Minimums or additional yardage may be required. Please contact the vendor directly for specific information.

Extended lead times may be necessary for this service.

Contact your Steelcase Solutions Fulfillment Team Representative at 1.888.STEELCASE (1.888.783.3522) or send an e-mail to [lineone@steelcase.com](mailto:lineone@steelcase.com).

**Alcove Brochure**  
*Form number S3012*

**Resources**

**Quick Ship Guide**

**Casegoods and Seating Delivered in 12 Days**  
*Form number S3461*

# Alcove Guest Chair



Standard Includes		Required to Specify
<ul style="list-style-type: none"> <li>▶ Need help? Product details, page 36</li> </ul>	<ul style="list-style-type: none"> <li>• Frame: European Beech</li> <li>• Upholstery: fabric price group 1</li> <li>• 1/2"-diameter glides: stainless steel only</li> </ul>	<ol style="list-style-type: none"> <li>1 Style number</li> <li>2 Wood color number for frame</li> <li>3 Fabric color number for upholstery</li> <li>4 Options, if selected (see below)</li> </ol> <ul style="list-style-type: none"> <li>▶ See <i>Surface Materials</i>, page 90.</li> </ul>

Options	U.S. Price	Required to Specify
<b>Surface Materials</b>		
<b>Upholstery</b>		
• Fabric price group 1	No cost	Specify fabric color number.
• Fabric price group 2	+\$ 24	Specify fabric color number.
• Fabric price group 3	+\$ 52	Specify fabric color number.
• Fabric price group 4	+\$ 81	Specify fabric color number.
• Fabric price group 5	+\$100	Specify fabric color number.
• Fabric price group 6	+\$115	Specify fabric color number.
• Fabric price group 7	+\$145	Specify fabric color number.
• Fabric price group 8	+\$186	Specify fabric color number.
• Fabric price group 9	+\$231	Specify fabric color number.
• Fabric price group 10	+\$302	Specify fabric color number.
• Leather price group	+\$434	Specify leather color number.
• Customer's Own Material (COM)	+\$ 16	▶ See <i>Surface Materials Reference Manual</i> .
• Customer's Own Leather (COL)	+\$ 16	▶ See <i>Surface Materials Reference Manual</i> .
• Soil-retardant treatment applied to upholstery fabric	+\$ 23	Specify <i>with soil-retardant treatment</i> .
<b>Wood</b>		
• Customiz stain on wood	No cost	Specify <i>with Customiz stain</i> . ▶ See <i>Surface Materials Reference Manual</i> .

Specification Information	
• Style Number	• U.S. Base Price
G20	\$685



**For Canadian Pricing**  
 Multiply U.S. Price by the Canadian price factor.  
 ▶ See page 1 for details.



# Collaboration

**Collaboration** guest chairs, designed by Dennie Pimental and John Duffy, have a classic design that is ideal for conference room, reception area, and dining room seating, or as guest seating in a workstation. Several arm inserts are available to create different visual details.

**Inserts** can match or contrast with frame color.

**Back and seat** are fully upholstered.

**Upholstered seat** features a webbed panel construction.

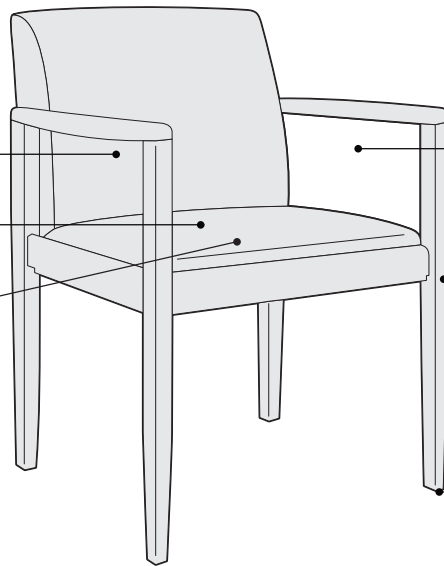

**Arms** may be enclosed with upholstery or European Beech inserts, or left open.

**Frame** is European Beech.

**Glides** are 1/2" diameter.

## Actual Dimensions

Overall depth	24 <sup>1</sup> / <sub>4</sub> "
Overall width	22 <sup>1</sup> / <sub>2</sub> "
Overall height	31 <sup>1</sup> / <sub>2</sub> "
Seat depth	17"
Seat width	18 <sup>3</sup> / <sub>4</sub> "
Back width	18 <sup>3</sup> / <sub>4</sub> "
Back height	13 <sup>3</sup> / <sub>4</sub> "
Width between arms	18 <sup>3</sup> / <sub>4</sub> "
Seat to floor height	18"
Arm height from floor	25 <sup>1</sup> / <sub>2</sub> "



**Product Details**

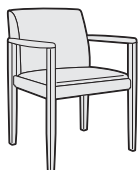

**Open-arm chair** is the simplest variation in the Collaboration family.

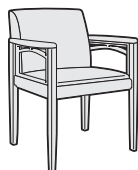

**Arcade chair** inserts introduce an arched motif.

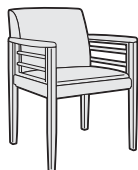

**Ladder chair** inserts establish a strong horizontal direction.

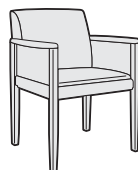

**Upholstered** inserts enclose the arms with fabric-covered panels.

**All inserts** are factory-installed.

**All chairs** are available with plain hardwood arms.

**Surface Materials**

**Upholstery**

- Fabric
- Fabric with soil-retardant treatment (option)
- Leather
- COM
- COL

**Frame**

- European Beech
- Tip: Wood finishes applied to European Beech will match the color of stains applied to oak, walnut, or cherry but will not show the same natural grain.*
- Customiz stain (option)

**Inserts**

- Upholstery
- European Beech
- Customiz stain (option)

**Glides**

- Stainless steel only

**Wood touch-up kits**

- Available in specific finishes for field repairs
- ▶ Page 98

**All Steelcase seating with standard upholstery fabrics** complies with requirements of the State of California Technical Bulletin 117. All standard seating is labeled to be in compliance with California 117.

**Programs & Services**

▶ See the *Surface Materials Reference Manual* for further detail about programs and services offered for seating.

**The Customer's Own Material (COM & COL) Program**

offers the opportunity for customers to select fabrics and leather that are not offered through the standard Steelcase surface materials program for use on Steelcase products. Avoid pattern fabrics and heavily grained leathers. Through the COM & COL program, Steelcase will test your materials for application on Steelcase products. Once approved, you can place your order. Steelcase will facilitate the entire ordering process and give you a production schedule. Steelcase will order the COM & COL fabric and leather directly from the textile manufacturer. For up-to-date information regarding fabric test results for all COM & COL fabrics and details regarding yardage requirements for most Seating lines, visit the COM Web site. To locate the COM Web site:

- Visit [www.steelcase.com](http://www.steelcase.com)

**Soil retardants** are treatments that provide long-term soil and stain resistance to a fabric without affecting the shade or the integrity of the fabric. The following Steelcase Textiles are available pre-treated with soil retardant. (You do not need to select the soil-retardant option for these fabrics and incur the upcharge.)

- Jacks
- Link
- Spyder

For information on soil retardant fabrics on Select Surfaces, please refer to the *Surface Materials Reference Manual*.

Soil-retardant treatment is available on all other seating fabrics at an additional upcharge per seating unit. To order this option, please select "Soil-Retardant Treatment" under "Optional Accessories."

For soil-retardant treatment on COMs, please select "Soil-Retardant Treatment" under "Optional Accessories." Minimums or additional yardage may be required. Please contact the vendor directly for specific information.

Extended lead times may be necessary for this service.

Contact your Steelcase Solutions Fulfillment Team Representative at 1.888.STEELCASE (1.888.783.3522) or send an e-mail to [lineone@steelcase.com](mailto:lineone@steelcase.com).

**Resources**

**Collaboration Brochure**  
Form number S11078

**Chairs for People at Work**  
Form number S11347

**Quick Ship Guide**

**Casegoods and Seating Delivered in 12 Days**

Form number S3461

# Collaboration Guest Chairs



	Standard Includes	Required to Specify
<ul style="list-style-type: none"> <li>▶ Need help? Product details, page 40</li> </ul>	<ul style="list-style-type: none"> <li>• Frame: European Beech</li> <li>• Upholstery on seat and back: fabric price group 1</li> <li>• Inserts, if selected: upholstery or European Beech</li> <li>• Glides: stainless steel only</li> </ul>	<ol style="list-style-type: none"> <li>1 Style number</li> <li>2 Fabric color number for upholstery</li> <li>3 Wood color number for frame</li> <li>4 Wood color number for inserts, if selected</li> <li>5 Options, if selected (see below)</li> </ol> <ul style="list-style-type: none"> <li>▶ See <i>Surface Materials</i>, page 90.</li> </ul>

	Options	U.S. Price	Required to Specify
<b>Surface Materials</b>	<b>Upholstery</b>		
	• Fabric price group 1	No cost	Specify fabric color number.
	• Fabric price group 2	+\$ 24	Specify fabric color number.
	• Fabric price group 3	+\$ 52	Specify fabric color number.
	• Fabric price group 4	+\$ 81	Specify fabric color number.
	• Fabric price group 5	+\$115	Specify fabric color number.
	• Fabric price group 6	+\$167	Specify fabric color number.
	• Fabric price group 7	+\$197	Specify fabric color number.
	• Fabric price group 8	+\$290	Specify fabric color number.
	• Fabric price group 9	+\$371	Specify fabric color number.
	• Fabric price group 10	+\$453	Specify fabric color number.
	• Leather price group	+\$434	Specify leather color number.
	• Customer's Own Material (COM)	+\$ 31	▶ See <i>Surface Materials Reference Manual</i> .
• Customer's Own Leather (COL)	+\$ 31	▶ See <i>Surface Materials Reference Manual</i> .	
• Soil-retardant treatment applied to upholstery fabric	+\$ 23	Specify <i>with soil-retardant treatment</i> .	
	<b>Frame</b>		
	• Customiz stain on wood	No cost	Specify <i>with Customiz stain</i> . ▶ See <i>Surface Materials Reference Manual</i> .



## For Canadian Pricing

Multiply U.S. Price by the Canadian price factor.

▶ See page 1 for details.

**Specification Information**

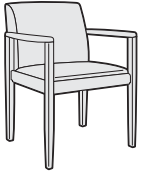

**Open**



Description	Style Number	U.S. Base Price
Wood arms	<b>120</b>	\$880

**Arcade Insert**



Description	Style Number	U.S. Base Price
Wood arms	<b>120D</b>	\$976

**Ladder Insert**



Description	Style Number	U.S. Base Price
Wood arms	<b>120L</b>	\$976

**Upholstered Insert**



Description	Style Number	U.S. Base Price
Wood arms	<b>120U</b>	\$976



**For Canadian Pricing**  
 Multiply U.S. Price by the Canadian price factor.  
 ▶ See page 1 for details.

# England

**England** chair, designed by Burt England, is lightweight, comfortable, and durable. The flowing lines of the chair provide an aesthetically pleasing appearance for transitional and contemporary settings.

**Back and seat** are fully upholstered.

**Arms** may be enclosed with upholstery or left open.

**Upholstered seat** features a webbed panel construction.

**Arms and front legs** are formed by a continuous ribbon of maple.

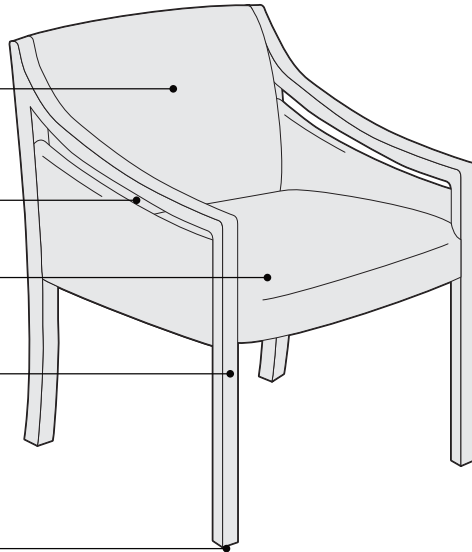

**Glides** are 1/2" diameter.

## Actual Dimensions

	Open arms	Enclosed arms
Overall depth	24 1/4"	24 1/4"
Overall width	22 1/4"	22 1/4"
Overall height	32 1/2"	32 1/2"
Seat depth	18 1/2"	18 1/2"
Seat width	20 3/4"	19 3/4"
Back width	20 3/4"	19 3/4"
Back height	15 3/4"	15 3/4"
Width between arms	19 3/4"	19 3/4"
Seat to floor height	18 1/2"	18 1/2"
Arm height from floor	24 3/4"	24 3/4"

## Surface Materials

### Upholstery

- Vinyl
- Fabric
- Fabric with soil-retardant treatment (option)
- Leather
- COM
- COL

### Frame

- Maple

*Tip: Wood finishes applied to maple will match the color of stains applied to oak, walnut, or cherry but will not show the same natural grain.*

- Customiz stain on wood (option)

### Glides

- Stainless steel only

### Wood touch-up kits

- Available in specific finishes for field repairs
- ▶ Page 98

**All Steelcase seating with standard upholstery fabrics** complies with requirements of the State of California Technical Bulletin 117. All standard seating is labeled to be in compliance with California 117.

## Programs & Services

▶ See the *Surface Materials Reference Manual* for further detail about programs and services offered for seating.

### The Customer's Own Material (COM & COL)

**Program** offers the opportunity for customers to select fabrics and leather that are not offered through the standard Steelcase surface materials program for use on Steelcase products. Avoid pattern fabrics and heavily grained leathers. Through the COM & COL program, Steelcase will test your materials for application on Steelcase products. Once approved, you can place your order. Steelcase will facilitate the entire ordering process and give you a production schedule. Steelcase will order the COM & COL fabric and leather directly from the textile manufacturer. For up-to-date information regarding fabric test results for all COM & COL fabrics and details regarding yardage requirements for most Seating lines, visit the COM Web site. To locate the COM Web site:

- Visit [www.steelcase.com](http://www.steelcase.com)

**Soil retardants** are treatments that provide long-term soil and stain resistance to a fabric without affecting the shade or the integrity of the fabric. The following Steelcase Textiles are available pre-treated with soil retardant. (You do not need to select the soil-retardant option for these fabrics and incur the upcharge.)

- Jacks
- Link
- Spyder

For information on soil retardant fabrics on Select Surfaces, please refer to the *Surface Materials Reference Manual*.

Soil-retardant treatment is available on all other seating fabrics at an additional upcharge per seating unit. To order this option, please select "Soil-Retardant Treatment" under "Optional Accessories."

For soil-retardant treatment on COMs, please select "Soil-Retardant Treatment" under "Optional Accessories." Minimums or additional yardage may be required. Please contact the vendor directly for specific information.

Extended lead times may be necessary for this service.

Contact your Steelcase Solutions Fulfillment Team Representative at 1.888.STEELCASE (1.888.783.3522) or send an e-mail to lineone@steelcase.com.

**Resources**

**England Brochure**

*Form number S3007*

**Quick Ship Guide**



**Casegoods and Seating Delivered in 12 Days**

*Form number S3461*

# England Guest Chairs

Standard Includes	Required to Specify
<ul style="list-style-type: none"> <li>▶ Need help? Product details, page 44</li> <li>• Frame: maple</li> <li>• Upholstery: fabric price group 1</li> <li>• Glides: stainless steel only</li> </ul>	<ol style="list-style-type: none"> <li>1 Style number</li> <li>2 Fabric color number for upholstery</li> <li>3 Wood color number for frame</li> <li>4 Options, if selected (see below)</li> </ol> <ul style="list-style-type: none"> <li>▶ See <i>Surface Materials</i>, page 90.</li> </ul>

Options	U.S. Price	Required to Specify
<p><b>Surface Materials</b></p> <p><b>Upholstery</b></p> <ul style="list-style-type: none"> <li>• Fabric price group 1</li> <li>• Fabric price group 2</li> <li>• Fabric price group 3</li> <li>• Fabric price group 4</li> <li>• Fabric price group 5</li> <li>• Fabric price group 6</li> <li>• Fabric price group 7</li> <li>• Fabric price group 8</li> <li>• Fabric price group 9</li> <li>• Fabric price group 10</li> <li>• Leather price group for open-arm chairs</li> <li>• Leather price group for enclosed-arm chairs</li> <li>• Customer's Own Material (COM)</li> <li>• Customer's Own Leather (COL)</li> <li>• Soil-retardant treatment applied to upholstery fabric</li> </ul>	<ul style="list-style-type: none"> <li>No cost</li> <li>+\$ 24</li> <li>+\$ 52</li> <li>+\$ 81</li> <li>+\$115</li> <li>+\$167</li> <li>+\$197</li> <li>+\$290</li> <li>+\$371</li> <li>+\$453</li> <li>+\$434</li> <li>+\$654</li> <li>+\$ 31</li> <li>+\$ 31</li> <li>+\$ 23</li> </ul>	<ul style="list-style-type: none"> <li>Specify fabric color number.</li> <li>Specify fabric color number.</li> <li>Specify fabric color number.</li> <li>Specify fabric color number.</li> <li>Specify fabric color number.</li> <li>Specify fabric color number.</li> <li>Specify fabric color number.</li> <li>Specify fabric color number.</li> <li>Specify fabric color number.</li> <li>Specify fabric color number.</li> <li>Specify leather color number.</li> <li>Specify leather color number.</li> </ul> <ul style="list-style-type: none"> <li>▶ See <i>Surface Materials Reference Manual</i>.</li> <li>▶ See <i>Surface Materials Reference Manual</i>.</li> </ul> <p>Specify with soil-retardant treatment.</p>
<p><b>Frame</b></p> <ul style="list-style-type: none"> <li>• Customiz stain on wood</li> </ul>	<ul style="list-style-type: none"> <li>No cost</li> </ul>	<ul style="list-style-type: none"> <li>Specify with Customiz stain.</li> <li>▶ See <i>Surface Materials Reference Manual</i>.</li> </ul>

Specification Information			
Open Arms		Enclosed Arms	
			
• Style Number	• U.S. Base Price	• Style Number	• U.S. Base Price
0114	\$1238	0113	\$1340

 **For Canadian Pricing**  
 Multiply U.S. Price by the Canadian price factor.  
 ▶ See page 1 for details.



# Escapade

**Escapade** contemporary guest chairs are available with upholstered or wood slat backs.

**Frame** is European beech wood.

**Back** is fully upholstered front and back or with vertical wood slats.

**Stretcher rails** provide additional support.

**Legs** are solid wood.

**Glides** are 1/2" in diameter.

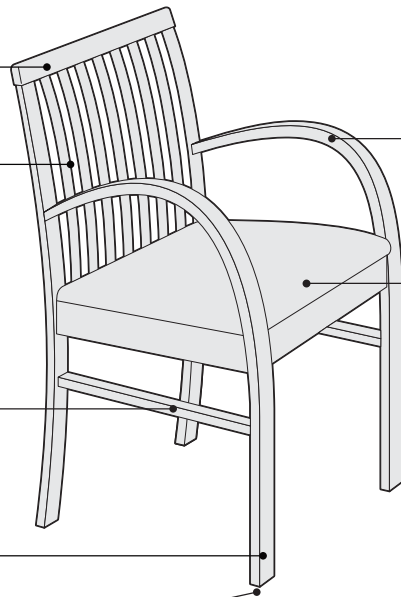

**Arms** have an open arch that flows into the front legs. Finger joint is used in construction.

**Upholstered seat** features a webbed panel construction.

## Product Details



**Two models** are available—upholstered back or vertical-slat wood back.

## Surface Materials

### Upholstery

- Fabric
- Fabric with soil-retardant treatment (option)
- Leather
- COM
- COL

### Frame

- European Beech
- Tip: Wood finishes applied to beech will match the color of stains applied to oak, walnut, or cherry but will not have the same natural grain.*

### Glides

- Stainless steel only

### Wood touch-up kits

- Available in specific finishes for field repairs
- ▶ Page 98

**All Steelcase seating with standard upholstery fabrics** complies with requirements of the State of California Technical Bulletin 117. All standard seating is labeled to be in compliance with California 117.

## Actual Dimensions

Overall depth 22 1/2"

Overall width 23 1/2"

Overall height 35"

Seat depth 17 1/2"

Seat width 21 1/2"

Back width 20 1/4"

Back height 16 3/4"

Width between arms 19"

Seat to floor height 18 1/4"

Arm height from floor 28 1/2"



## Programs & Services

► See the *Surface Materials Reference Manual* for further detail about programs and services offered for seating.

### The Customer's Own Material (COM & COL) Program

offers the opportunity for customers to select fabrics and leather that are not offered through the standard Steelcase surface materials program for use on Steelcase products. Avoid pattern fabrics and heavily grained leathers. Through the COM & COL program, Steelcase will test your materials for application on Steelcase products. Once approved, you can place your order. Steelcase will facilitate the entire ordering process and give you a production schedule. Steelcase will order the COM & COL fabric and leather directly from the textile manufacturer. For up-to-date information regarding fabric test results for all COM & COL fabrics and details regarding yardage requirements for most Seating lines, visit the COM Web site. To locate the COM Web site:

- Visit [www.steelcase.com](http://www.steelcase.com)

**Soil retardants** are treatments that provide long-term soil and stain resistance to a fabric without affecting the shade or the integrity of the fabric. The following Steelcase Textiles are available pre-treated with soil retardant. (You do not need to select the soil-retardant option for these fabrics and incur the upcharge.)

- Jacks
- Link
- Spyder

For information on soil retardant fabrics on Select Surfaces, please refer to the *Surface Materials Reference Manual*.

Soil-retardant treatment is available on all other seating fabrics at an additional upcharge per seating unit. To order this option, please select "Soil-Retardant Treatment" under "Optional Accessories."

For soil-retardant treatment on COMs, please select "Soil-Retardant Treatment" under "Optional Accessories." Minimums or additional yardage may be required. Please contact the vendor directly for specific information.

Extended lead times may be necessary for this service.

Contact your Steelcase Solutions Fulfillment Team Representative at 1.888.STEELCASE (1.888.783.3522) or send an e-mail to [lineone@steelcase.com](mailto:lineone@steelcase.com).

## Resources

### Escapade Brochure

Form number S11074

### Chairs for People at Work

Form number S11347

### Quick Ship Guide



### Casegoods and Seating Delivered in 12 Days

Form number S3461

# Escapade Guest Chairs

Standard Includes		Required to Specify
<ul style="list-style-type: none"> <li>▶ Need help? Product details, page 48</li> </ul>	<ul style="list-style-type: none"> <li>• Frame: European Beech</li> <li>• Slat back, if selected: European Beech</li> <li>• Upholstery for seat and cushioned back, if selected: fabric price group 1</li> <li>• 1/2"-diameter glides: stainless steel only</li> </ul>	<ol style="list-style-type: none"> <li>1 Style number</li> <li>2 Wood color number for frame</li> <li>3 Fabric color number for upholstery</li> <li>4 Options, if selected (see below)</li> </ol> <ul style="list-style-type: none"> <li>▶ See <i>Surface Materials</i>, page 90.</li> </ul>

	Options	U.S. Price	Required to Specify
<b>Surface Materials</b>	<b>Upholstery</b>		
	• Fabric price group 1	No cost	Specify fabric color number.
	• Fabric price group 2	+\$ 24	Specify fabric color number.
	• Fabric price group 3	+\$ 52	Specify fabric color number.
	• Fabric price group 4	+\$ 81	Specify fabric color number.
	• Fabric price group 5	+\$115	Specify fabric color number.
	• Fabric price group 6	+\$167	Specify fabric color number.
	• Fabric price group 7	+\$197	Specify fabric color number.
	• Fabric price group 8	+\$290	Specify fabric color number.
	• Fabric price group 9	+\$371	Specify fabric color number.
	• Fabric price group 10	+\$453	Specify fabric color number.
	• Leather price group for slat-back chair	+\$231	Specify leather color number.
	• Leather price group for upholstered-back chair	+\$434	Specify leather color number.
• Customer's Own Material (COM)	+\$ 31	▶ See <i>Surface Materials Reference Manual</i> .	
• Customer's Own Leather (COL)	+\$ 31	▶ See <i>Surface Materials Reference Manual</i> .	
• Soil-retardant treatment applied to upholstery fabric	+\$ 23	Specify with soil-retardant treatment.	
	<b>Wood</b>		
	• Customiz stain on wood	No cost	Specify with Customiz stain. ▶ See <i>Surface Materials Reference Manual</i> .

Specification Information			
Chair with Wood Slat Back		Chair with Upholstered Cushioned Back	
			
• Style Number	• U.S. Base Price	• Style Number	• U.S. Base Price
G23	\$1061	G22	\$1003



**For Canadian Pricing**  
 Multiply U.S. Price by the Canadian price factor.  
 ▶ See page 1 for details.



# Gentry

## Guest Chair

**Gentry** chairs, designed by Arnie Dammermann, provide contemporary styling with a distinctive design that features clean, simple lines and natural contours.  
 ▶ See *Gentry Desk Chairs*, page 28.

**Back** is fully upholstered.

**Arms** are one-piece, solid maple construction; open style arms curve gently for comfortable seating.

**Upholstered seat** features a webbed panel construction.

**Legs** are maple.

**Glides** are 1/2" diameter.

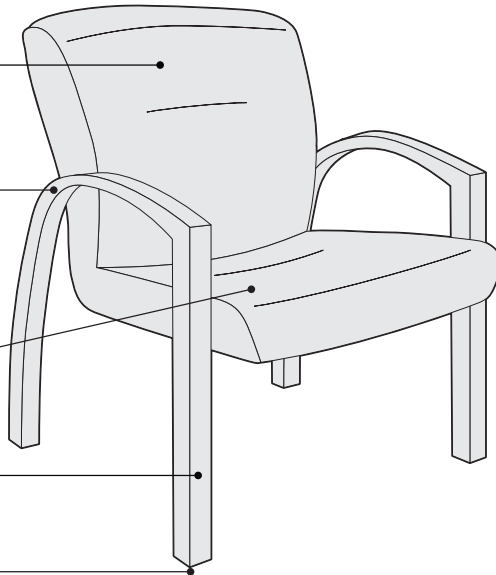

### Surface Materials

#### Seat and back

- Vinyl
- Fabric
- Fabric with soil-retardant treatment (option)
- Leather
- COM
- COL

#### Frame

- Maple
- Customiz stain on wood (option)

*Tip: Finishes applied to maple will match the color of stains applied to oak, walnut, or cherry but will not show the same natural grain.*

#### Glides

- Stainless steel only

#### Wood touch-up kits

- Available in specific finishes for field repairs
- ▶ Page 98

**All Steelcase seating with standard upholstery fabrics** complies with requirements of the State of California Technical Bulletin 117. All standard seating is labeled to be in compliance with California 117.

### Actual Dimensions

Overall depth	27½"
Overall width	24"
Overall height	33¾"
Seat depth	16½"
Seat width	20"
Back width	21"
Back height	19"
Width between arms	19½"
Seat to floor height	18"
Arm height from floor	24½"

## Programs & Services

► See the *Surface Materials Reference Manual* for further detail about programs and services offered for seating.

### The Customer's Own Material (COM & COL) Program

offers the opportunity for customers to select fabrics and leather that are not offered through the standard Steelcase surface materials program for use on Steelcase products. Avoid pattern fabrics and heavily grained leathers. Through the COM & COL program, Steelcase will test your materials for application on Steelcase products. Once approved, you can place your order. Steelcase will facilitate the entire ordering process and give you a production schedule. Steelcase will order the COM & COL fabric and leather directly from the textile manufacturer. For up-to-date information regarding fabric test results for all COM & COL fabrics and details regarding yardage requirements for most Seating lines, visit the COM Web site. To locate the COM Web site:

- Visit [www.steelcase.com](http://www.steelcase.com)

**Soil retardants** are treatments that provide long-term soil and stain resistance to a fabric without affecting the shade or the integrity of the fabric. The following Steelcase Textiles are available pre-treated with soil retardant. (You do not need to select the soil-retardant option for these fabrics and incur the upcharge.)

- Jacks
- Link
- Spyder

For information on soil retardant fabrics on Select Surfaces, please refer to the *Surface Materials Reference Manual*.

Soil-retardant treatment is available on all other seating fabrics at an additional upcharge per seating unit. To order this option, please select "Soil-Retardant Treatment" under "Optional Accessories."

For soil-retardant treatment on COMs, please select "Soil-Retardant Treatment" under "Optional Accessories." Minimums or additional yardage may be required. Please contact the vendor directly for specific information.

Extended lead times may be necessary for this service.

Contact your Steelcase Solutions Fulfillment Team Representative at 1.888.STEELCASE (1.888.783.3522) or send an e-mail to [lineone@steelcase.com](mailto:lineone@steelcase.com).

## Resources

### Gentry Brochure

Form number S11076

### Chairs for People at Work

Form number S11347

### Quick Ship Guide

### Casegoods and Seating Delivered in 12 Days

Form number S3461

# Gentry Guest Chair X4/15

Wood Frame



Standard Includes		Required to Specify
<ul style="list-style-type: none"> <li>▶ Need help? Product details, page 52</li> </ul>	<ul style="list-style-type: none"> <li>• Frame: maple</li> <li>• Upholstery: fabric price group 1</li> <li>• Glides: stainless steel only</li> </ul>	<ol style="list-style-type: none"> <li>1 Style number</li> <li>2 Fabric color number for upholstery</li> <li>3 Wood color number for frame</li> <li>4 Options, if selected (see below)</li> </ol> <ul style="list-style-type: none"> <li>▶ See <i>Surface Materials</i>, page 90.</li> </ul>

Options	U.S. Price	Required to Specify
<b>Surface Materials</b>		
<b>Upholstery</b> <ul style="list-style-type: none"> <li>• Fabric price group 1</li> <li>• Fabric price group 2</li> <li>• Fabric price group 3</li> <li>• Fabric price group 4</li> <li>• Fabric price group 5</li> <li>• Fabric price group 6</li> <li>• Fabric price group 7</li> <li>• Fabric price group 8</li> <li>• Fabric price group 9</li> <li>• Fabric price group 10</li> <li>• Leather price group</li> <li>• Customer's Own Material (COM)</li> <li>• Customer's Own Leather (COL)</li> <li>• Soil-retardant treatment applied to upholstery fabric</li> </ul>	<ul style="list-style-type: none"> <li>No cost</li> <li>+\$ 24</li> <li>+\$ 52</li> <li>+\$ 81</li> <li>+\$115</li> <li>+\$167</li> <li>+\$197</li> <li>+\$290</li> <li>+\$371</li> <li>+\$453</li> <li>+\$431</li> <li>+\$ 31</li> <li>+\$ 31</li> <li>+\$ 23</li> </ul>	<ul style="list-style-type: none"> <li>Specify fabric color number.</li> <li>Specify fabric color number.</li> <li>Specify fabric color number.</li> <li>Specify fabric color number.</li> <li>Specify fabric color number.</li> <li>Specify fabric color number.</li> <li>Specify fabric color number.</li> <li>Specify fabric color number.</li> <li>Specify fabric color number.</li> <li>Specify fabric color number.</li> <li>Specify leather color number.</li> <li>▶ See <i>Surface Materials Reference Manual</i>.</li> <li>▶ See <i>Surface Materials Reference Manual</i>.</li> <li>Specify <i>with soil-retardant treatment</i>.</li> </ul>
<b>Frame</b> <ul style="list-style-type: none"> <li>• Customiz stain on wood</li> </ul>	<ul style="list-style-type: none"> <li>No cost</li> </ul>	<ul style="list-style-type: none"> <li>Specify <i>with Customiz stain</i>.</li> <li>▶ See <i>Surface Materials Reference Manual</i>.</li> </ul>

Specification Information		
Description	Style Number	U.S. Base Price
Open wood arms	0612W X4/15	\$1041

 **For Canadian Pricing**  
 Multiply U.S. Price by the Canadian price factor.  
 ▶ See page 1 for details.

X4/15 = Last order entry  
 April 19, 2015



# Mansfield

**Mansfield** guest chairs provide a cost-effective solution for conference or reception seating where traditional Chippendale styling is desired. ▶ See Mansfield desk chairs, page 18.

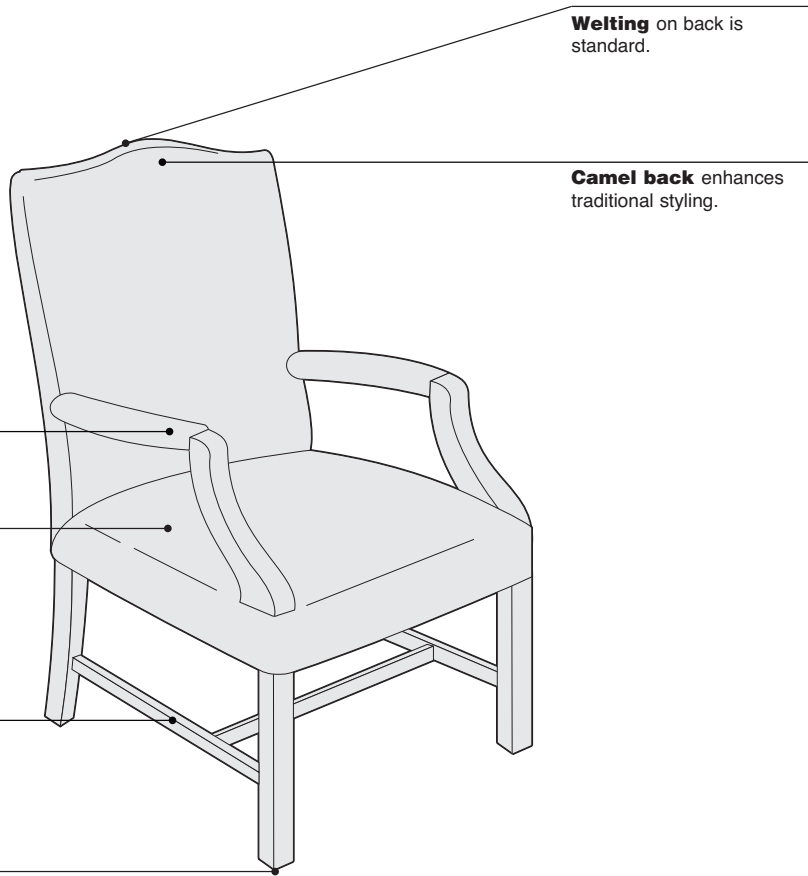

**Welting** on back is standard.

**Camel back** enhances traditional styling.

**Arms** are maple with upholstered arm rests.

**Upholstered seat** features a webbed panel construction.

**Stretcher rails** provide additional support.

**Glides** are 1/2" diameter.

## Product Details

**Brass tack accenting** is optional on chairs with upholstered seat and back.

## Surface Materials

### Upholstery

- Vinyl
- Fabric
- Fabric with soil-retardant treatment (option)
- Leather
- COM
- COL

### Frame

- Maple
- Tip: Finishes applied to maple will match the color of stains applied to oak, walnut, or cherry, but will not show the same natural grain.*
- Customiz stain on wood (option)

### Glides

- Stainless steel only

### Wood touch-up kits

- Available in specific finishes for field repairs
- ▶ Page 98

**All Steelcase seating with standard upholstery fabrics** complies with requirements of the State of California Technical Bulletin 117. All standard seating is labeled to be in compliance with California 117.

## Actual Dimensions

### Upholstered Guest Chairs

Overall depth	27"
Overall width	24 1/2"
Overall height	37 1/2"
Seat depth	19 1/2"
Seat width	19"
Back width	21"
Back height from seat	22 1/2"
Width between arms	19"
Seat to floor height	19"
Arm height from floor	24 1/2"



**Programs & Services**

▶ See the *Surface Materials Reference Manual* for further detail about programs and services offered for seating.

**The Customer's Own Material (COM & COL) Program**

offers the opportunity for customers to select fabrics and leather that are not offered through the standard Steelcase surface materials program for use on Steelcase products. Avoid pattern fabrics and heavily grained leathers. Through the COM & COL program, Steelcase will test your materials for application on Steelcase products. Once approved, you can place your order. Steelcase will facilitate the entire ordering process and give you a production schedule. Steelcase will order the COM & COL fabric and leather directly from the textile manufacturer. For up-to-date information regarding fabric test results for all COM & COL fabrics and details regarding yardage requirements for most Seating lines, visit the COM Web site. To locate the COM Web site:

- Visit [www.steelcase.com](http://www.steelcase.com)

**Soil retardants** are treatments that provide long-term soil and stain resistance to a fabric without affecting the shade or the integrity of the fabric. The following Steelcase Textiles are available pre-treated with soil retardant. (You do not need to select the soil-retardant option for these fabrics and incur the upcharge.)

- Jacks
- Link
- Spyder

For information on soil retardant fabrics on Select Surfaces, please refer to the *Surface Materials Reference Manual*.

Soil-retardant treatment is available on all other seating fabrics at an additional upcharge per seating unit. To order this option, please select "Soil-Retardant Treatment" under "Optional Accessories."

For soil-retardant treatment on COMs, please select "Soil-Retardant Treatment" under "Optional Accessories." Minimums or additional yardage may be required. Please contact the vendor directly for specific information.

Extended lead times may be necessary for this service.

Contact your Steelcase Solutions Fulfillment Team Representative at 1.888.STEELCASE (1.888.783.3522) or send an e-mail to [lineone@steelcase.com](mailto:lineone@steelcase.com).

**Resources**

**Mansfield Brochure**  
Form number S10485

# Mansfield Guest Chair

Upholstered Chair

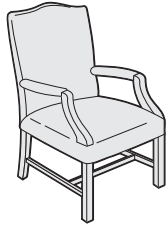

Standard Includes		Required to Specify
<ul style="list-style-type: none"> <li>▶ Need help? Product details, page 56</li> </ul>	<ul style="list-style-type: none"> <li>• Frame: maple</li> <li>• Upholstery: fabric price group 1</li> <li>• Glides: stainless steel only</li> </ul>	<ol style="list-style-type: none"> <li>1 Style number</li> <li>2 Fabric color number for upholstery</li> <li>3 Wood color number for frame</li> <li>4 Options, if selected (see below)</li> </ol> <ul style="list-style-type: none"> <li>▶ See <i>Surface Materials</i>, page 90.</li> </ul>

	Options	U.S. Price	Required to Specify
<b>Surface Materials</b>	<b>Upholstery</b>		
	• Fabric price group 1	No cost	Specify fabric color number.
	• Fabric price group 2	+\$ 35	Specify fabric color number.
	• Fabric price group 3	+\$114	Specify fabric color number.
	• Fabric price group 4	+\$143	Specify fabric color number.
	• Fabric price group 5	+\$197	Specify fabric color number.
	• Fabric price group 6	+\$250	Specify fabric color number.
	• Fabric price group 7	+\$297	Specify fabric color number.
	• Fabric price group 8	+\$434	Specify fabric color number.
	• Fabric price group 9	+\$556	Specify fabric color number.
• Fabric price group 10	+\$679	Specify fabric color number.	
• Leather price group	+\$967	Specify leather color number.	
• Customer's Own Material (COM)	+\$ 52	▶ See <i>Surface Materials Reference Manual</i> .	
• Customer's Own Leather (COL)	+\$ 52	▶ See <i>Surface Materials Reference Manual</i> .	
• Soil-retardant treatment applied to upholstery fabric	+\$ 23	Specify with soil-retardant treatment.	
	<b>Brass tacks</b>		
	• Brass tack accenting	+\$ 50	Add suffix <b>B</b> to the style number.
	<b>Frame</b>		
	• Customiz stain	No cost	Specify with <i>Customiz stain</i> . ▶ See <i>Surface Materials Reference Manual</i> .

Specification Information	
• Style Number	• U.S. Base Price
142	\$906
.	.
.	.



## For Canadian Pricing

Multiply U.S. Price by the Canadian price factor.

▶ See page 1 for details.



# Mingle

**Mingle guest chairs**, designed by Bill Schacht and Lynda Chesser, have a tailored appearance that is sophisticated and pure in design, yet simple in scale. Mingle's design addresses a broad set of applications from an open plan systems environment to a closed office setting.

**Exposed maple plywood back panel** provides enhanced lumbar support to achieve a high level of comfort.

**Upholstered seat** features a webbed-panel construction.

**Back legs and seat frame** are metal for additional strength and durability. Legs are standard in black. Nickel powdercoat is available as an option.

**Foot cap** is standard with nickel finish.

**Arms** taper to flow into front legs.

**Glides** are 1/2" diameter on front legs and 1" diameter on back legs.

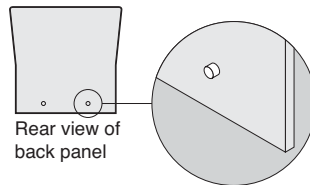
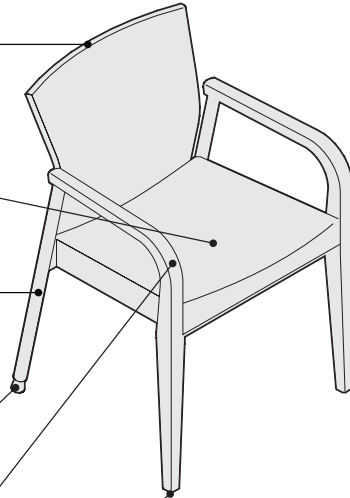

**Metal button fasteners** located at bottom of back panel secure seat and back attachment while providing an additional element of design.

## Surface Materials

### Seat

- Fabric
- Fabric with soil-retardant treatment (option)
- Leather
- COM
- COL

### Back legs

- Black
- Nickel (option)

### Back, arms, and front legs

- Maple plywood
- Customiz stain (option)

### Metal button fasteners

- Nickel color only

### Foot caps on back legs

- Nickel color only

### Glides

- Stainless steel on front legs
- Nylon on back legs

### Wood touch-up kits

- Available in specific finishes for field repairs
- ▶ Page 98

**All Steelcase seating with standard upholstery fabrics** complies with requirements of the State of California Technical Bulletin 117. All standard seating is labeled to be in compliance with California 117.

## Actual Dimensions

Overall depth	22 1/8"
Overall width	22 1/4"
Overall height	32"
Seat depth	17 1/2"
Seat width	17 7/8"
Back width	17 1/4"
Back height	14"
Width between arms	19"
Seat to floor height	17 1/2"
Arm height from floor	25 1/2"

**Programs & Services**

▶ See the *Surface Materials Reference Manual* for further detail about programs and services offered for seating.

**The Customer's Own Material (COM & COL) Program**

offers the opportunity for customers to select fabrics and leather that are not offered through the standard Steelcase surface materials program for use on Steelcase products. Avoid pattern fabrics and heavily grained leathers. Through the COM & COL program, Steelcase will test your materials for application on Steelcase products. Once approved, you can place your order. Steelcase will facilitate the entire ordering process and give you a production schedule. Steelcase will order the COM & COL fabric and leather directly from the textile manufacturer. For up-to-date information regarding fabric test results for all COM & COL fabrics and details regarding yardage requirements for most Seating lines, visit the COM Web site. To locate the COM Web site:

- Visit [www.steelcase.com](http://www.steelcase.com)

**Soil retardants** are treatments that provide long-term soil and stain resistance to a fabric without affecting the shade or the integrity of the fabric. The following Steelcase Textiles are available pre-treated with soil retardant. (You do not need to select the soil-retardant option for these fabrics and incur the upcharge.)

- Jacks
- Link
- Spyder

For information on soil retardant fabrics on Select Surfaces, please refer to the *Surface Materials Reference Manual*.

Soil-retardant treatment is available on all other seating fabrics at an additional upcharge per seating unit. To order this option, please select "Soil-Retardant Treatment" under "Optional Accessories."

For soil-retardant treatment on COMs, please select "Soil-Retardant Treatment" under "Optional Accessories." Minimums or additional yardage may be required. Please contact the vendor directly for specific information.

Extended lead times may be necessary for this service.

Contact your Steelcase Solutions Fulfillment Team Representative at 1.888.STEELCASE (1.888.783.3522) or send an e-mail to [lineone@steelcase.com](mailto:lineone@steelcase.com).

**Resources**

**Mingle Brochure**  
*Form number S10880*

# Mingle Guest Chair



Standard Includes		Required to Specify
<ul style="list-style-type: none"> <li>▶ Need help? Product details, page 60</li> </ul>	<ul style="list-style-type: none"> <li>• Back, arms, and front legs: maple</li> <li>• Back legs: black</li> <li>• Upholstery: fabric price group 1</li> <li>• Glides: stainless steel on front legs, nylon on back legs</li> </ul>	<ol style="list-style-type: none"> <li>1 Style number</li> <li>2 Wood color number for frame</li> <li>3 Fabric color number for upholstery</li> <li>4 Options, if selected (see below)</li> </ol> <ul style="list-style-type: none"> <li>▶ See <i>Surface Materials</i>, page 90.</li> </ul>

	Options	U.S. Price	Required to Specify
<b>Surface Materials</b>	<b>Upholstery</b>		
	• Fabric price group 1	No cost	Specify fabric color number.
	• Fabric price group 2	+\$ 24	Specify fabric color number.
	• Fabric price group 3	+\$ 52	Specify fabric color number.
	• Fabric price group 4	+\$ 81	Specify fabric color number.
	• Fabric price group 5	+\$100	Specify fabric color number.
	• Fabric price group 6	+\$115	Specify fabric color number.
	• Fabric price group 7	+\$145	Specify fabric color number.
	• Fabric price group 8	+\$186	Specify fabric color number.
	• Fabric price group 9	+\$231	Specify fabric color number.
	• Fabric price group 10	+\$302	Specify fabric color number.
	• Leather price group	+\$231	Specify leather color number.
	• Customer's Own Material (COM)	+\$ 16	▶ See <i>Surface Materials Reference Manual</i> .
• Customer's Own Leather (COL)	+\$ 16	▶ See <i>Surface Materials Reference Manual</i> .	
• Soil-retardant treatment applied to upholstery fabric	+\$ 23	Specify with soil-retardant treatment.	
	<b>Frame</b>		
	• Customiz stain on wood	No cost	Specify with <i>Customiz stain</i> . ▶ See <i>Surface Materials Reference Manual</i> .
	<b>Legs</b>		
	• Nickel	+\$ 28	Specify with <i>7026 Nickel</i> .

Specification Information	
• Style Number	• U.S. Base Price
MNGLB	\$1008
.	.
.	.



**For Canadian Pricing**  
 Multiply U.S. Price by the Canadian price factor.  
 ▶ See page 1 for details.



# Oriana

**Oriana**, designed by David Jenkins, is an interpretation of early ladder-back and slat-back seating designs. Its classic styling is suitable for both transitional and contemporary interiors.

**Back** is available in three design variations.

**Arms** are open.

**Frame** is European Beech.

**Upholstered seat** features a webbed panel construction.

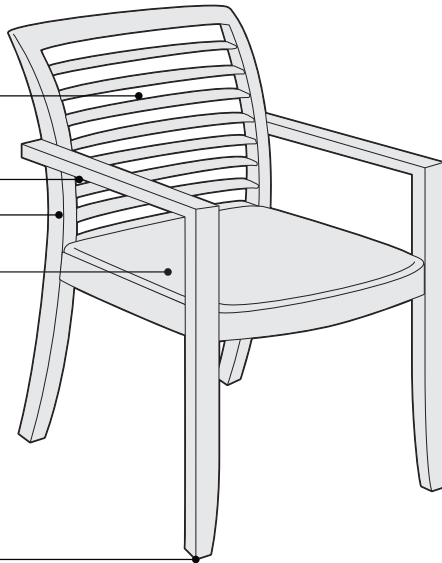

**Glides** are 1/2" diameter.

## Product Details

**Back** is available with horizontal slats, vertical slats, or closed upholstered construction.

## Surface Materials

### Upholstery

- Fabric
- Fabric with soil-retardant treatment (option)
- Leather
- COM
- COL

### Frame

- European Beech
- Tip: Wood finishes applied to European Beech will match the color of stains applied to oak, walnut, or cherry but will not show the same natural grain.*
- Customiz stain (option)

### Glides

- Stainless steel only

### Wood touch-up kits

- Available in specific finishes for field repairs
- ▶ Page 98

**All Steelcase seating with standard upholstery fabrics** complies with requirements of the State of California Technical Bulletin 117. All standard seating is labeled to be in compliance with California 117.

## Actual Dimensions

Overall depth	23 <sup>7</sup> / <sub>8</sub> "
Overall width	23 <sup>1</sup> / <sub>4</sub> "
Overall height	34 <sup>3</sup> / <sub>8</sub> "
Seat depth	17 <sup>7</sup> / <sub>8</sub> "
Seat width	20"
Back width	18"
Back height	15 <sup>5</sup> / <sub>8</sub> "
Width between arms	19"
Seat to floor height	18 <sup>3</sup> / <sub>4</sub> "
Arm height from floor	25 <sup>3</sup> / <sub>8</sub> "



**Programs & Services**

▶ See the *Surface Materials Reference Manual* for further detail about programs and services offered for seating.

**The Customer's Own Material (COM & COL) Program**

offers the opportunity for customers to select fabrics and leather that are not offered through the standard Steelcase surface materials program for use on Steelcase products. Avoid pattern fabrics and heavily grained leathers. Through the COM & COL program, Steelcase will test your materials for application on Steelcase products. Once approved, you can place your order. Steelcase will facilitate the entire ordering process and give you a production schedule. Steelcase will order the COM & COL fabric and leather directly from the textile manufacturer. For up-to-date information regarding fabric test results for all COM & COL fabrics and details regarding yardage requirements for most Seating lines, visit the COM Web site. To locate the COM Web site:

- Visit [www.steelcase.com](http://www.steelcase.com)

**Soil retardants** are treatments that provide long-term soil and stain resistance to a fabric with-out affecting the shade or the integrity of the fabric. The following Steelcase Textiles are available pre-treated with soil retardant. (You do not need to select the soil-retardant option for these fabrics and incur the upcharge.)

- Jacks
- Link
- Spyder

For information on soil retardant fabrics on Select Surfaces, please refer to the *Surface Materials Reference Manual*.

Soil-retardant treatment is available on all other seating fabrics at an additional upcharge per seating unit. To order this option, please select "Soil-Retardant Treatment" under "Optional Accessories."

For soil-retardant treatment on COMs, please select "Soil-Retardant Treatment" under "Optional Accessories." Minimums or additional yardage may be required. Please contact the vendor directly for specific information.

Extended lead times may be necessary for this service.

Contact your Steelcase Solutions Fulfillment Team Representative at 1.888.STEELCASE (1.888.783.3522) or send an e-mail to [lineone@steelcase.com](mailto:lineone@steelcase.com).

**Resources**



**Oriana Brochure**  
Form number S11079

# Oriana Guest Chairs

Standard Includes	Required to Specify
<ul style="list-style-type: none"> <li>▶ Need help? Product details, page 64</li> <li>• Frame: European Beech</li> <li>• Upholstery: fabric price group 1</li> <li>• Glides: stainless steel only</li> </ul>	<ol style="list-style-type: none"> <li>1 Style number</li> <li>2 Fabric color number for upholstery</li> <li>3 Wood color number for frame</li> <li>4 Options, if selected (see below)</li> </ol> <ul style="list-style-type: none"> <li>▶ See <i>Surface Materials</i>, page 90.</li> </ul>

Surface Materials	Options	U.S. Price	Required to Specify
	<b>Upholstery</b> <ul style="list-style-type: none"> <li>• Fabric price group 1</li> <li>• Fabric price group 2</li> <li>• Fabric price group 3</li> <li>• Fabric price group 4</li> <li>• Fabric price group 5</li> <li>• Fabric price group 6</li> <li>• Fabric price group 7</li> <li>• Fabric price group 8</li> <li>• Fabric price group 9</li> <li>• Fabric price group 10</li> <li>• Leather price group for slat-back chair</li> <li>• Leather price group for upholstered-back chair</li> <li>• Customer's Own Material (COM)</li> <li>• Customer's Own Leather (COL)</li> <li>• Soil-retardant treatment applied to upholstery fabric</li> </ul>	No cost +\$ 24 +\$ 52 +\$ 81 +\$115 +\$167 +\$197 +\$290 +\$371 +\$453 +\$231 +\$434 +\$ 31 +\$ 31 +\$ 23	Specify fabric color number. Specify fabric color number. Specify fabric color number. Specify fabric color number. Specify fabric color number. Specify fabric color number. Specify fabric color number. Specify fabric color number. Specify fabric color number. Specify fabric color number. Specify leather color number. Specify leather color number. ▶ See <i>Surface Materials Reference Manual</i> . ▶ See <i>Surface Materials Reference Manual</i> . Specify with soil-retardant treatment.
	<b>Frame</b> <ul style="list-style-type: none"> <li>• Customiz stain on wood</li> </ul>	No cost	Specify with Customiz stain. ▶ See <i>Surface Materials Reference Manual</i> .

## Specification Information

Vertical Slat Back		Horizontal Slat Back		Fully Upholstered Back	
					
• <b>Style Number</b>	• <b>U.S. Base Price</b>	• <b>Style Number</b>	• <b>U.S. Base Price</b>	• <b>Style Number</b>	• <b>U.S. Base Price</b>
0202	\$1358	0204	\$1358	0205	\$1307

 **For Canadian Pricing**  
 Multiply U.S. Price by the Canadian price factor.  
 ▶ See page 1 for details.



# Sawyer

**Sawyer**, clean lines and simple forms create this solid wood guest chair. Contemporary, durable, and perfect for private offices and public spaces.

**Back** has horizontal wood slots.

**Frame** is European beech wood.

**Upholstered seat** features a webbed panel construction.

**Glides** are 1/2" diameter.

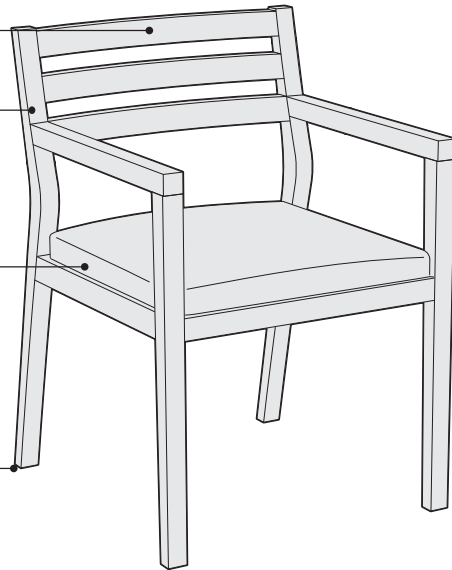

## Surface Materials

### Upholstery

- Fabric
- Fabric with soil-retardant treatment (option)
- Leather
- COM
- COL

### Frame

- European Beech  
*Tip: Wood finishes applied to beech will match the color of stains applied to oak, walnut, or cherry but will not show the same natural grain.*

### Glides

- Stainless steel only

### Wood touch-up kits

- Available in specific finishes for field repairs
- ▶ Page 98

**All Steelcase seating with standard upholstery fabrics** complies with requirements of the State of California Technical Bulletin 117. All standard seating is labeled to be in compliance with California 117.

## Actual Dimensions

Overall depth	22½"
Overall width	22½"
Overall height	32½"
Seat depth	18"
Seat width	19⅜"
Back width	22¼"
Back height	15⅜"
Back lumbar height	7"
Width between arms	19½"
Seat-to-floor height	18⅝"
Arm height from floor	26½"

## Programs & Services

► See the *Surface Materials Reference Manual* for further detail about programs and services offered for seating.

### The Customer's Own Material (COM & COL)

**Program** offers the opportunity for customers to select fabrics and leather that are not offered through the standard Steelcase surface materials program for use on Steelcase products. Avoid pattern fabrics and heavily grained leathers. Through the COM and COL program, Steelcase will test your materials for application on Steelcase products. Once approved, you can place your order. Steelcase will facilitate the entire ordering process and give you a production schedule. Steelcase will order the COM and COL fabric and leather directly from the textile manufacturer. For up-to-date information regarding fabric test results for all COM and COL fabrics and details regarding yardage requirements for most Seating lines, visit the COM Web site. To locate the COM Web site:

- Visit [www.steelcase.com](http://www.steelcase.com)

**Soil retardants** are treatments that provide longterm soil and stain resistance to a fabric without affecting the shade or the integrity of the fabric. The following Steelcase Textiles are available pre-treated with soil retardant. (You do not need to select the soil retardant option for these fabrics and incur the upcharge.)

- Jacks
- Link
- Spyder

For information on soil retardant fabrics on Select Surfaces, please refer to the *Surface Materials Reference Manual*.

Soil-retardant treatment is available on all other seating fabrics at an additional upcharge per seating unit. To order this option, please select "Soil-Retardant Treatment" under "Optional Accessories."

For soil-retardant treatment on COMs, please select "Soil-Retardant Treatment" under "Optional Accessories." Minimums or additional yardage may be required. Please contact the vendor directly for specific information.

Extended lead times may be necessary for this service.

Contact your Steelcase Solutions Fulfillment Team Representative at 1.888.STEELCASE (1.888.783.3522) or send an e-mail to [lineone@steelcase.com](mailto:lineone@steelcase.com).

# Sawyer Wood Guest Chairs



*Tip: Due to natural variations in wood, finished products may vary in color texture and grain.*

*Tip: Wood color 3522 Clear is a clear coat. Therefore, the natural variations in European beech will be visible.*

*Tip: 3522 Clear coordinates with Marbled Maple laminate.*

Standard Includes		Required to Specify
<ul style="list-style-type: none"> <li>▶ Need help? Product details, page 68</li> </ul>	<ul style="list-style-type: none"> <li>• Upholstered seat: fabric price group 1</li> <li>• Webbed panel construction seat for added comfort</li> <li>• Frame: wood (European beech)</li> <li>• Back with horizontal slats</li> <li>• Glides</li> </ul>	<ol style="list-style-type: none"> <li>1 Style number</li> <li>2 Fabric color number for upholstery</li> <li>3 Wood color number for frame</li> <li>4 Options, if selected (see below)</li> </ol> <ul style="list-style-type: none"> <li>▶ See <i>Surface Materials</i>, page 90.</li> </ul>

Options	U.S. Price	Required to Specify
<b>Surface Materials</b>		
<b>Upholstery</b>		
<ul style="list-style-type: none"> <li>• Fabric price group 1</li> <li>• Fabric price group 2</li> <li>• Fabric price group 3</li> <li>• Fabric price group 4</li> <li>• Fabric price group 5</li> <li>• Fabric price group 6</li> <li>• Fabric price group 7</li> <li>• Fabric price group 8</li> <li>• Fabric price group 9</li> <li>• Fabric price group 10</li> <li>• Customer's Own Material (COM)</li> <li>• Leather price group</li> <li>• Customer's Own Leather (COL)</li> </ul>	<ul style="list-style-type: none"> <li>No cost</li> <li>+\$ 10</li> <li>+\$ 24</li> <li>+\$ 33</li> <li>+\$ 40</li> <li>+\$ 49</li> <li>+\$ 59</li> <li>+\$ 73</li> <li>+\$ 90</li> <li>+\$103</li> <li>+\$ 35</li> <li>+\$274</li> <li>+\$ 34</li> </ul>	<ul style="list-style-type: none"> <li>Specify fabric color number.</li> <li>Specify fabric color number.</li> <li>Specify fabric color number.</li> <li>Specify fabric color number.</li> <li>Specify fabric color number.</li> <li>Specify fabric color number.</li> <li>Specify fabric color number.</li> <li>Specify fabric color number.</li> <li>Specify fabric color number.</li> <li>Specify fabric color number.</li> <li>Specify fabric color number.</li> <li>▶ See <i>Surface Materials Reference Manual</i>.</li> <li>Add suffix <b>L</b> to style number and specify leather color number.</li> <li>Add suffix <b>L</b> to style number and specify leather color number.</li> <li>▶ See <i>Surface Materials Reference Manual</i>.</li> </ul>

Specification Information	
•Style Number	•U.S. Base Price
TS37602	\$572



**For Canadian Pricing**  
 Multiply U.S. Price by the Canadian price factor.  
 ▶ See page 1 for details.



# Snodgrass 474 Series

**Snodgrass**, designed by Warren Snodgrass, offers guest and occasional seating of classic simplicity. Snodgrass has enduring design that is always in style.

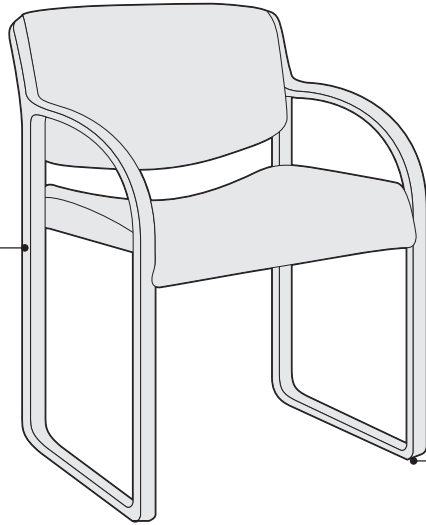

**Frame** is available in wood veneer.

**Glides** are clear plastic.

## Actual Dimensions

Overall depth	23½"
Overall width	22¾"
Overall height	31½"
Seat depth	21"
Functional seat depth	17½"
Seat width	20"
Back width	20"
Back height	14¼"
Back lumbar height	7"
Width between arms	20"
Seat-to-floor height	18¼"
Arm height from floor	25¼"
Arm height from seat	7"
Seat pan angle	5°
Angle between seat and back	103°

## Product Details

**One back shape** is available, open back.

**One arm style**—open is available.

## Surface Materials

▶ See surface materials on page 90 for specific availability or refer to the *Surface Materials Reference Manual* for further information.

### Upholstery

- Fabric
- Fabric with soil retardant treatment (option)
- Vinyl
- Leather
- COM
- COL

### Frame

- 9201 Polished Chrome
- Wood

*Tip: Frames are constructed of solid maple. Finishes applied to maple will match the color of stains applied to oak, walnut, or cherry, but will not show the same natural grain.*

### Glides

- Clear plastic

### Wood touch-up kits

- Available in specific finishes for field repairs
- ▶ Page 98

**All Steelcase seating with standard upholstery fabrics** complies with requirements of the State of California Technical Bulletin 117. All standard seating is labeled to be in compliance with California 117.



**Programs & Services**

▶ See the *Surface Materials Reference Manual* for further detail about programs and services offered for seating.

**The Customer's Own Material (COM & COL) Program**

offers the opportunity for customers to select fabrics and leather that are not offered through the standard Steelcase surface materials program for use on Steelcase products. Avoid pattern fabrics and heavily grained leathers. Through the COM & COL program, Steelcase will test your materials for application on Steelcase products. Once approved, you can place your order. Steelcase will facilitate the entire ordering process and give you a production schedule. Steelcase will order the COM & COL fabric and leather directly from the textile manufacturer. For up-to-date information regarding fabric test results for all COM & COL fabrics and details regarding yardage requirements for most Seating lines, visit the COM Web site. To locate the COM Web site:

- Visit [www.steelcase.com](http://www.steelcase.com)

**Soil retardants** are treatments that provide long-term soil and stain resistance to a fabric without affecting the shade or the integrity of the fabric. The following Steelcase Textiles are available pre-treated with soil retardant. (You do not need to select the soil-retardant option for these fabrics and incur the upcharge.)

- Jacks
- Link
- Spyder

For information on soil retardant fabrics on Select Surfaces, please refer to the *Surface Materials Reference Manual*.

Soil-retardant treatment is available on all other seating fabrics at an additional upcharge per seating unit. To order this option, please select "Soil-Retardant Treatment" under "Optional Accessories."

For soil-retardant treatment on COMs, please select "Soil-Retardant Treatment" under "Optional Accessories." Minimums or additional yardage may be required. Please contact the vendor directly for specific information.

Extended lead times may be necessary for this service.

Contact your Steelcase Solutions Fulfillment Team Representative at 1.888.STEELCASE (1.888.783.3522) or send an e-mail to [lineone@steelcase.com](mailto:lineone@steelcase.com).

**Resources**

**Snodgrass Brochure**  
Form number (S11006)

# Snodgrass 474 Series Guest Chair



Standard Includes		Required to Specify
<ul style="list-style-type: none"> <li>▶ Need help? Product details, page 72</li> </ul>	<ul style="list-style-type: none"> <li>• Frame and arms: wood veneer</li> <li>• Upholstery: fabric price group 1</li> <li>• Glides: clear plastic</li> </ul>	<ol style="list-style-type: none"> <li>1 Style number</li> <li>2 Fabric color number for upholstery</li> <li>3 Wood veneer color number for frame</li> <li>4 Options, if selected (see below)</li> </ol> <ul style="list-style-type: none"> <li>▶ See <i>Surface Materials</i>, page 90.</li> </ul>

Options	U.S. Price	Required to Specify
<b>Surface Materials</b> <b>Upholstery</b> <ul style="list-style-type: none"> <li>• Fabric price group 1</li> <li>• Fabric price group 2</li> <li>• Fabric price group 3</li> <li>• Fabric price group 4</li> <li>• Fabric price group 5</li> <li>• Fabric price group 6</li> <li>• Fabric price group 7</li> <li>• Fabric price group 8</li> <li>• Fabric price group 9</li> <li>• Fabric price group 10</li> <li>• Leather price group</li> <li>• Elmosoft leather price group</li> <li>• Customer's Own Material (COM)</li> <li>• Customer's Own Leather (COL)</li> <li>• Soil-retardant treatment applied to upholstery fabric</li> </ul>	<ul style="list-style-type: none"> <li>No cost</li> <li>+\$ 24</li> <li>+\$ 46</li> <li>+\$ 64</li> <li>+\$ 81</li> <li>+\$100</li> <li>+\$115</li> <li>+\$145</li> <li>+\$179</li> <li>+\$203</li> <li>+\$522</li> <li>+\$603</li> <li>+\$ 35</li> <li>+\$ 35</li> <li>+\$ 23</li> </ul>	<ul style="list-style-type: none"> <li>Specify fabric color number.</li> <li>Specify fabric color number.</li> <li>Specify fabric color number.</li> <li>Specify fabric color number.</li> <li>Specify fabric color number.</li> <li>Specify fabric color number.</li> <li>Specify fabric color number.</li> <li>Specify fabric color number.</li> <li>Specify fabric color number.</li> <li>Specify fabric color number.</li> <li>Specify leather color number.</li> <li>Specify Elmosoft leather color number.</li> <li>▶ See <i>Surface Materials Reference Manual</i>.</li> <li>▶ See <i>Surface Materials Reference Manual</i>.</li> <li>Specify with soil-retardant treatment.</li> </ul>
<b>Frame</b> <ul style="list-style-type: none"> <li>• Customiz stain on wood</li> </ul>	<ul style="list-style-type: none"> <li>No cost</li> </ul>	<ul style="list-style-type: none"> <li>Specify with Customiz stain.</li> <li>▶ See <i>Surface Materials Reference Manual</i>.</li> </ul>

Specification Information	
• Style Number	• U.S. Base Price
:	:
:	:
:	:

Open Loop Arms with Open Back - Wood	
474419W	\$1108
:	:
:	:

 **For Canadian Pricing**  
 Multiply U.S. Price by the Canadian price factor.  
 ▶ See page 1 for details.



# Terrazzo

**Terrazzo guest chairs**, designed by Brian Kane, have a classic and simple styling appropriate for a broad range of applications. A family of factory-installed back designs are available to create a variety of visual statements.

**Lattice inserts** are available in three designs. Slats are bowed to provide enhanced lumbar support.

**Frame** is European Beech.

**Arms** are arched to correspond with the curvature of the chair's back and are gently raised at the front to assist in entering and rising from the chair.

**Seat** is fully upholstered and features a webbed-panel construction.

**Glides** are 1/2" diameter.

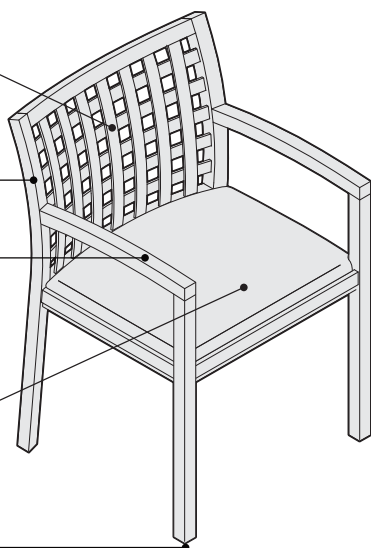

## Product Details



**Square lattice back** creates a strong grid-like pattern.



**Macintosh lattice back** introduces a distinctive vertical space.



**Horizontal lattice back** divides the space with horizontal elements.

## Surface Materials

### Seat

- Vinyl
- Fabric
- Fabric with soil-retardant treatment (option)
- Leather
- COM
- COL

### Frame and back slats

- European Beech
- Tip: Wood finishes applied to beech will match the color of stains applied to oak, walnut, or cherry but will not show the same natural grain.*
- Customiz stain (option)

### Glides

- Stainless steel only

### Wood touch-up kits

- Available in specific finishes for field repairs
- ▶ Page 98

**All Steelcase seating with standard upholstery fabrics** complies with requirements of the State of California Technical Bulletin 117. All standard seating is labeled to be in compliance with California 117.

## Actual Dimensions

Overall depth	21¾"
Overall width	21¼"
Overall height	32¼"
Seat depth	17⅞"
Seat width	20"
Back width	21¼"
Back height	14"
Width between arms	18¾"
Seat to floor height	18¼"
Arm height from floor	25¼"

## Programs & Services

► See the *Surface Materials Reference Manual* for further detail about programs and services offered for seating.

### The Customer's Own Material (COM & COL)

**Program** offers the opportunity for customers to select fabrics and leather that are not offered through the standard Steelcase surface materials program for use on Steelcase products. Avoid pattern fabrics and heavily grained leathers. Through the COM & COL program, Steelcase will test your materials for application on Steelcase products. Once approved, you can place your order. Steelcase will facilitate the entire ordering process and give you a production schedule. Steelcase will order the COM & COL fabric and leather directly from the textile manufacturer. For up-to-date information regarding fabric test results for all COM & COL fabrics and details regarding yardage requirements for most Seating lines, visit the COM Web site. To locate the COM Web site:

- Visit [www.steelcase.com](http://www.steelcase.com)

**Soil retardants** are treatments that provide long-term soil and stain resistance to a fabric without affecting the shade or the integrity of the fabric. The following Steelcase Textiles are available pre-treated with soil retardant. (You do not need to select the soil-retardant option for these fabrics and incur the upcharge.)

- Jacks
- Link
- Spyder

For information on soil retardant fabrics on Select Surfaces, please refer to the *Surface Materials Reference Manual*.

Soil-retardant treatment is available on all other seating fabrics at an additional upcharge per seating unit. To order this option, please select "Soil-Retardant Treatment" under "Optional Accessories."

For soil-retardant treatment on COMs, please select "Soil-Retardant Treatment" under "Optional Accessories." Minimums or additional yardage may be required. Please contact the vendor directly for specific information.

Extended lead times may be necessary for this service.

Contact your Steelcase Solutions Fulfillment Team Representative at 1.888.STEELCASE (1.888.783.3522) or send an e-mail to [lineone@steelcase.com](mailto:lineone@steelcase.com).

## Resources

### Terrazzo Brochure

Form number S10886

### Chairs for People at Work

Form number S11347

# Terrazzo Guest Chairs

Standard Includes		Required to Specify
<ul style="list-style-type: none"> <li>▶ Need help? Product details, page 76</li> </ul>	<ul style="list-style-type: none"> <li>• Upholstery on seat: fabric price group 1</li> <li>• Frame: European Beech</li> <li>• Lattice slats: European Beech</li> <li>• Glides: stainless steel only</li> </ul>	<ol style="list-style-type: none"> <li>1 Style number</li> <li>2 Fabric color number for upholstery</li> <li>3 Wood color number for frame</li> <li>4 Options, if selected (see below)</li> </ol> <ul style="list-style-type: none"> <li>▶ See <i>Surface Materials</i>, page 90.</li> </ul>

	Options	U.S. Price	Required to Specify
<b>Surface Materials</b>	<b>Upholstery</b>		
	• Fabric price group 1	No cost	Specify fabric color number.
	• Fabric price group 2	+\$ 24	Specify fabric color number.
	• Fabric price group 3	+\$ 52	Specify fabric color number.
	• Fabric price group 4	+\$ 81	Specify fabric color number.
	• Fabric price group 5	+\$100	Specify fabric color number.
	• Fabric price group 6	+\$115	Specify fabric color number.
	• Fabric price group 7	+\$145	Specify fabric color number.
	• Fabric price group 8	+\$186	Specify fabric color number.
	• Fabric price group 9	+\$231	Specify fabric color number.
	• Fabric price group 10	+\$302	Specify fabric color number.
	• Leather price group	+\$231	Specify fabric color number.
	• Customer's Own Material (COM)	+\$ 16	Specify leather color number. ▶ See <i>Surface Materials Reference Manual</i> .
• Customer's Own Leather (COL)	+\$ 16	▶ See <i>Surface Materials Reference Manual</i> .	
• Soil-retardant treatment applied to upholstery fabric	+\$ 23	Specify with soil-retardant treatment.	
	<b>Frame</b>		
	• Customiz stain on wood	No cost	Specify with <i>Customiz stain</i> . ▶ See <i>Surface Materials Reference Manual</i> .

## Specification Information

### Square Lattice Back



• **Style Number**  
.....  
.....

• **U.S. Base Price**  
.....  
.....

**TERR1**      \$1023

### Macintosh Lattice Back



• **Style Number**  
.....  
.....

• **U.S. Base Price**  
.....  
.....

**TERR2**      \$1023

### Horizontal Lattice Back



• **Style Number**  
.....  
.....

• **U.S. Base Price**  
.....  
.....

**TERR3**      \$1023



### For Canadian Pricing

Multiply U.S. Price by the Canadian price factor.

▶ See page 1 for details.



# Topaz

**Topaz** offers two chair styles to complement traditional and transitional office environments.

**Frame** is European Beech.

**Back** is upholstered and framed in wood. It is available either open or closed.

**Arms** are open. They are available with either a rectilinear or curvilinear design. Finger joint is used in construction.

**Upholstered seat** features a webbed panel construction.

**Legs** are solid wood. Front legs on open back model are carved for traditional detail.

**Glides** are 1/2" in diameter.

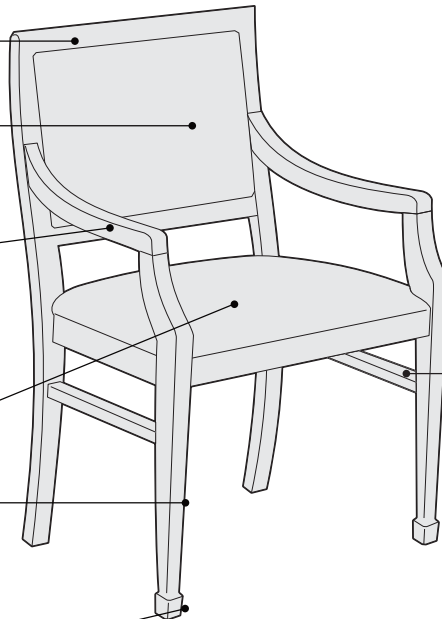

**Stretcher rails** on open back model provide added support.

## Product Details

**Two models** are available—open back or closed back.



**Open-back models** have rectilinear arms, carved detail on the front legs, and stretcher rails.



**Closed-back models** have curvilinear arms that flow into the front legs.

## Surface Materials

### Upholstery

- Vinyl
- Fabric
- Fabric with soil-retardant treatment (option)
- Leather
- COM
- COL

### Frame

- European Beech
- Tip: Wood finishes applied to beech will match the color of stains applied to oak, walnut, or cherry but will not have the same natural grain.*

### Glides

- Stainless steel only

### Wood touch-up kits

- Available in specific finishes for field repairs
- ▶ Page 98

**All Steelcase seating with standard upholstery fabrics** complies with requirements of the State of California Technical Bulletin 117. All standard seating is labeled to be in compliance with California 117.

## Actual Dimensions

	Closed Back	Open Back
Overall depth	21"	23 <sup>3</sup> / <sub>4</sub> "
Overall width	22 <sup>1</sup> / <sub>4</sub> "	23 <sup>1</sup> / <sub>4</sub> "
Overall height	32 <sup>1</sup> / <sub>2</sub> "	35 <sup>1</sup> / <sub>2</sub> "
Seat depth	16"	18"
Seat width	21"	21"
Back width	20 <sup>1</sup> / <sub>2</sub> "	19 <sup>1</sup> / <sub>2</sub> "
Back height	14 <sup>1</sup> / <sub>2</sub> "	17 <sup>3</sup> / <sub>4</sub> "
Width between arms	19 <sup>1</sup> / <sub>2</sub> "	19 <sup>1</sup> / <sub>2</sub> "
Seat to floor height	18 <sup>1</sup> / <sub>4</sub> "	18 <sup>1</sup> / <sub>4</sub> "
Arm height from floor	25 <sup>1</sup> / <sub>4</sub> "	25 <sup>1</sup> / <sub>2</sub> "



**Programs & Services**

► See the *Surface Materials Reference Manual* for further detail about programs and services offered for seating.

**The Customer's Own Material (COM & COL) Program**

offers the opportunity for customers to select fabrics and leather that are not offered through the standard Steelcase surface materials program for use on Steelcase products. Avoid pattern fabrics and heavily grained leathers. Through the COM & COL program, Steelcase will test your materials for application on Steelcase products. Once approved, you can place your order. Steelcase will facilitate the entire ordering process and give you a production schedule. Steelcase will order the COM & COL fabric and leather directly from the textile manufacturer. For up-to-date information regarding fabric test results for all COM & COL fabrics and details regarding yardage requirements for most Seating lines, visit the COM Web site. To locate the COM Web site:

- Visit [www.steelcase.com](http://www.steelcase.com)

**Soil retardants** are treatments that provide long-term soil and stain resistance to a fabric without affecting the shade or the integrity of the fabric. The following Steelcase Textiles are available pre-treated with soil retardant. (You do not need to select the soil-retardant option for these fabrics and incur the upcharge.)

- Jacks
- Link
- Spyder

For information on soil retardant fabrics on Select Surfaces, please refer to the *Surface Materials Reference Manual*.

Soil-retardant treatment is available on all other seating fabrics at an additional upcharge per seating unit. To order this option, please select "Soil-Retardant Treatment" under "Optional Accessories."

For soil-retardant treatment on COMs, please select "Soil-Retardant Treatment" under "Optional Accessories." Minimums or additional yardage may be required. Please contact the vendor directly for specific information.

Extended lead times may be necessary for this service.

Contact your Steelcase Solutions Fulfillment Team Representative at 1.888.STEELCASE (1.888.783.3522) or send an e-mail to [lineone@steelcase.com](mailto:lineone@steelcase.com).

**Resources**

**Topaz Brochure**  
*Form number S11077*

**Chairs for People at Work**  
*Form number S11347*



**Quick Ship Guide**

**Casegoods and Seating Delivered in 12 Days**  
*Form number S3461*

# Topaz Guest Chairs

Standard Includes		Required to Specify
<ul style="list-style-type: none"> <li>▶ Need help? Product details, page 80</li> </ul>	<ul style="list-style-type: none"> <li>• Frame: European Beech</li> <li>• Upholstery: fabric price group 1</li> <li>• 1/2"-diameter glides: stainless steel only</li> </ul>	<ol style="list-style-type: none"> <li>1 Style number</li> <li>2 Wood color number for frame</li> <li>3 Fabric color number for upholstery</li> <li>4 Options, if selected (see below)</li> </ol> <ul style="list-style-type: none"> <li>▶ See <i>Surface Materials</i>, page 90.</li> </ul>

	Options	U.S. Price	Required to Specify
<b>Surface Materials</b>	<b>Upholstery</b>		
	• Fabric price group 1	No cost	Specify fabric color number.
	• Fabric price group 2	+\$ 24	Specify fabric color number.
	• Fabric price group 3	+\$ 52	Specify fabric color number.
	• Fabric price group 4	+\$ 81	Specify fabric color number.
	• Fabric price group 5	+\$100	Specify fabric color number.
	• Fabric price group 6	+\$115	Specify fabric color number.
	• Fabric price group 7	+\$145	Specify fabric color number.
	• Fabric price group 8	+\$186	Specify fabric color number.
	• Fabric price group 9	+\$231	Specify fabric color number.
	• Fabric price group 10	+\$302	Specify fabric color number.
	• Leather price group	+\$434	Specify fabric color number.
	• Customer's Own Material (COM)	+\$ 16	Specify leather color number.
• Customer's Own Leather (COL)	+\$ 16	▶ See <i>Surface Materials Reference Manual</i> .	
• Soil-retardant treatment applied to upholstery fabric	+\$ 23	Specify with soil-retardant treatment.	
	<b>Wood</b>		
	• Customiz stain on wood	No cost	Specify with <i>Customiz stain</i> .
			▶ See <i>Surface Materials Reference Manual</i> .

Specification Information			
Chair with Open Back		Chair with Closed Back	
			
• Style Number	• U.S. Base Price	• Style Number	• U.S. Base Price
.....	.....	.....	.....
<b>G24</b>	\$875	<b>G26</b>	\$816
.....	.....	.....	.....



**For Canadian Pricing**  
 Multiply U.S. Price by the Canadian price factor.  
 ▶ See page 1 for details.

---

# Stackable Seating

**Deck**

**84**

Stackable

# Deck

**Deck**, stackable wood guest chairs designed by Brian Kane, combine function with a tailored aesthetic that is bound to become a modern classic.

**Back and seat** are available fully upholstered, with wood back and upholstered seat or with wood back and wood seat.

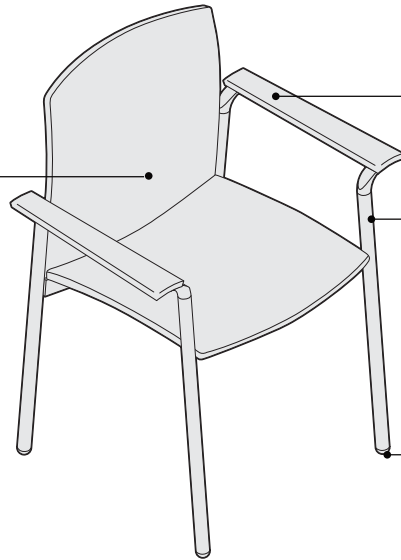

**Arms** are available as wood or black expanded urethane.

**Legs** are standard in black textured paint and available as an option in sterling paint.

**Glides** are 1/2" diameter.

## Product Details

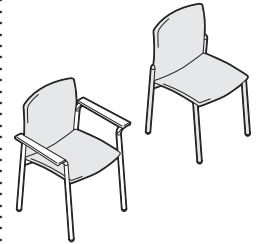

**Fully upholstered back and seat**

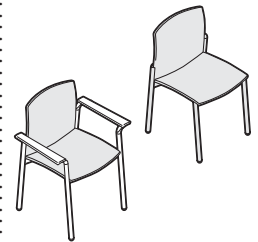

**Wood back and seat**

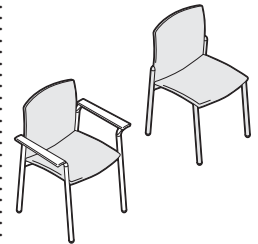

**Wood back and upholstered seat**

### Deck stackable chairs with and without arms

are available in three styles—fully upholstered back and seat, wood back and seat, and wood back with upholstered seat.

**Chairs** stack five high.



**Fully upholstered back and seat**

## Actual Dimensions

	Guest chair with arms	Guest chair without arms	Stool
Overall depth	21"	21 <sup>5</sup> / <sub>8</sub> "	20 <sup>1</sup> / <sub>2</sub> "
Overall width	26 <sup>1</sup> / <sub>4</sub> "	20"	17"
Overall height	32 <sup>3</sup> / <sub>4</sub> "	32 <sup>3</sup> / <sub>4</sub> "	43 <sup>1</sup> / <sub>4</sub> "
Seat depth	17 <sup>13</sup> / <sub>16</sub> "	17 <sup>13</sup> / <sub>16</sub> "	15 <sup>7</sup> / <sub>8</sub> "
Seat width	17 <sup>13</sup> / <sub>16</sub> "	17 <sup>13</sup> / <sub>16</sub> "	17 <sup>7</sup> / <sub>8</sub> "
Back width	17 <sup>13</sup> / <sub>16</sub> "	17 <sup>13</sup> / <sub>16</sub> "	15"
Back height	17 <sup>15</sup> / <sub>16</sub> "	17 <sup>13</sup> / <sub>16</sub> "	16"
Width between arms	20 <sup>3</sup> / <sub>8</sub> "	N.A.	N.A.
Seat to floor height	18"	17 <sup>3</sup> / <sub>4</sub> "	30 <sup>1</sup> / <sub>4</sub> "
Arm height from floor	25"	N.A.	N.A.

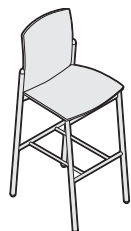

**Wood back and seat**

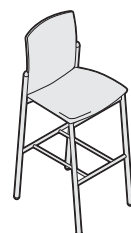

**Wood back and upholstered seat**

**Stools** are available fully upholstered, with wood back and seat, or with wood back and upholstered seat.

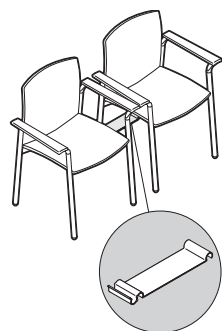

**Ganging device** is available to link chairs in the field for evenly spaced rows. Spacing between seats of chairs linked with ganging device is 9". Spacing between front of chair arms is 1/2" and spacing between back of chair arms is 2".

## Surface Materials

### Upholstery

- Vinyl
- Fabric
- Fabric with soil-retardant treatment (option)
- Leather
- COM
- COL

### Legs

- 4798 Sterling (option)
- 7207 Black

### Arms

- Expanded urethane
- Wood

### Seat

- Wood or upholstered

### Back

- Wood or upholstered
- Tip: Wood finishes applied to maple will match the color of stains applied to oak, walnut, or cherry but will not show the same natural grain.*

- Customiz stain (option)

### Ganging device

- Black plastic only

### Glides

- Plastic to match legs

### Wood touch-up kits

- Available in specific finishes for field repairs
- ▶ Page 98

**All Steelcase seating with standard upholstery fabrics** complies with requirements of the State of California Technical Bulletin 117. All standard seating is labeled to be in compliance with California 117.

## Programs & Services

▶ See the *Surface Materials Reference Manual* for further detail about programs and services offered for seating.

## The Customer's Own Material (COM & COL)

**Program** offers the opportunity for customers to select fabrics and leather that are not offered through the standard Steelcase surface materials program for use on Steelcase products. Avoid pattern fabrics and heavily grained leathers. Through the COM & COL program, Steelcase will test your materials for application on Steelcase products. Once approved, you can place your order. Steelcase will facilitate the entire ordering process and give you a production schedule. Steelcase will order the COM & COL fabric and leather directly from the textile manufacturer. For up-to-date information regarding fabric test results for all COM & COL fabrics and details regarding yardage requirements for most Seating lines, visit the COM Web site. To locate the COM Web site:

- Visit [www.steelcase.com](http://www.steelcase.com)

**Soil retardants** are treatments that provide long-term soil and stain resistance to a fabric without affecting the shade or the integrity of the fabric. The following Steelcase Textiles are available pre-treated with soil retardant. (You do not need to select the soil-retardant option for these fabrics and incur the upcharge.)

- Jacks
- Link
- Spyder

For information on soil retardant fabrics on Select Surfaces, please refer to the *Surface Materials Reference Manual*.

Soil-retardant treatment is available on all other seating fabrics at an additional upcharge per seating unit. To order this option, please select "Soil-Retardant Treatment" under "Optional Accessories."

For soil-retardant treatment on COMs, please select "Soil-Retardant Treatment" under "Optional Accessories." Minimums or additional yardage may be required. Please contact the vendor directly for specific information.

Extended lead times may be necessary for this service.

Contact your Steelcase Solutions Fulfillment Team Representative at 1.888.STEELCASE (1.888.783.3522) or send an e-mail to [lineone@steelcase.com](mailto:lineone@steelcase.com).

## Resources

### Deck Brochure

Form number S11198

### Chairs for People at Work

Form number S11347

# Deck Stackable Guest Chairs

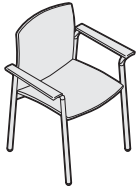

Standard Includes	Required to Specify
<ul style="list-style-type: none"> <li>▶ Need help? Product details, page 84</li> <li>• Back and seat: fabric price group 1 or maple</li> <li>• Arms, if selected: maple or black urethane</li> <li>• Legs: 7207 Black</li> <li>• Glides: plastic to match legs</li> </ul>	<ol style="list-style-type: none"> <li>1 Style number</li> <li>2 Fabric color number for upholstery, if selected</li> <li>3 Wood color number for back and seat and/or arms, if selected</li> <li>4 Options, if selected (see below)</li> </ol> <p>▶ See <i>Surface Materials</i>, page 90.</p>

Options	U.S. Price	Required to Specify
<b>Surface Materials</b>	<b>Upholstery</b>	
	<ul style="list-style-type: none"> <li>• Fabric price group 1 No cost</li> <li>• Fabric price group 2 +\$ 24</li> <li>• Fabric price group 3 +\$ 52</li> <li>• Fabric price group 4 +\$ 81</li> <li>• Fabric price group 5 +\$100</li> <li>• Fabric price group 6 +\$115</li> <li>• Fabric price group 7 +\$145</li> <li>• Fabric price group 8 +\$186</li> <li>• Fabric price group 9 +\$231</li> <li>• Fabric price group 10 +\$302</li> <li>• Leather price group +\$434</li> <li>• Customer's Own Material (COM) +\$ 16</li> <li>• Customer's Own Leather (COL) +\$ 16</li> <li>• Soil-retardant treatment applied to upholstery fabric +\$ 23</li> </ul>	<ul style="list-style-type: none"> <li>Specify fabric color number.</li> <li>Specify fabric color number.</li> <li>Specify fabric color number.</li> <li>Specify fabric color number.</li> <li>Specify fabric color number.</li> <li>Specify fabric color number.</li> <li>Specify fabric color number.</li> <li>Specify fabric color number.</li> <li>Specify fabric color number.</li> <li>Specify fabric color number.</li> <li>Specify leather color number.</li> </ul> <p>▶ See <i>Surface Materials Reference Manual</i>.</p> <p>▶ See <i>Surface Materials Reference Manual</i>.</p> <p>Specify with soil-retardant treatment.</p>
	<b>Back and seat and/or arms</b>	
	<ul style="list-style-type: none"> <li>• Customiz stain on wood No cost</li> </ul>	<ul style="list-style-type: none"> <li>Specify with <i>Customiz stain</i>.</li> </ul> <p>▶ See <i>Surface Materials Reference Manual</i>.</p>
	<b>Legs</b>	
	<ul style="list-style-type: none"> <li>• Sterling +\$ 28</li> </ul>	<ul style="list-style-type: none"> <li>Specify with <i>4798 Sterling legs</i>.</li> </ul>
<b>Ganging Device</b>	<ul style="list-style-type: none"> <li>• Removable ganging device to link adjacent chairs: black plastic only +\$ 17</li> </ul>	<ul style="list-style-type: none"> <li>Add suffix <b>G</b> to the style number.</li> </ul>



**For Canadian Pricing**  
 Multiply U.S. Price by the Canadian price factor.  
 ▶ See page 1 for details.

### Specification Information

#### Upholstered Back and Seat



• Style Number  
• U.S. Base Price

#### Wood Back and Upholstered Seat



• Style Number  
• U.S. Base Price

#### Wood Back and Seat



• Style Number  
• U.S. Base Price

#### With Wood Arms

DECKC34 \$658

DECKC24 \$709

DECKC14 \$730

#### With Urethane Arms

DECKC35 \$625

DECKC25 \$677

DECKC15 \$697

#### Upholstered Back and Seat



• Style Number  
• U.S. Base Price

#### Wood Back and Upholstered Seat



• Style Number  
• U.S. Base Price

#### Wood Back and Seat



• Style Number  
• U.S. Base Price

#### Without Arms

DECKA3 \$590

DECKA2 \$645

DECKA1 \$665

 **For Canadian Pricing**  
Multiply U.S. Price by the Canadian price factor.  
▶ See page 1 for details.

# Deck Stools

Standard Includes	Required to Specify
<ul style="list-style-type: none"> <li>▶ Need help? Product details, page 85</li> <li>• Back and seat: fabric price group 1 or maple</li> <li>• Legs: 7207 Black metal</li> <li>• Glides: plastic to match legs</li> </ul>	<ul style="list-style-type: none"> <li>1 Style number</li> <li>2 Fabric and/or wood color number for back and seat</li> <li>3 Options, if selected (see below)</li> <li>▶ See <i>Surface Materials</i>, page 90.</li> </ul>

Options	U.S. Price	Required to Specify
<b>Surface Materials</b>	<b>Upholstery</b> <ul style="list-style-type: none"> <li>• Fabric price group 1</li> <li>• Fabric price group 2</li> <li>• Fabric price group 3</li> <li>• Fabric price group 4</li> <li>• Fabric price group 5</li> <li>• Fabric price group 6</li> <li>• Fabric price group 7</li> <li>• Fabric price group 8</li> <li>• Fabric price group 9</li> <li>• Fabric price group 10</li> <li>• Leather price group</li> <li>• Customer's Own Material (COM)</li> <li>• Customer's Own Leather (COL)</li> <li>• Soil-retardant treatment applied to upholstery fabric</li> </ul>	<ul style="list-style-type: none"> <li>No cost</li> <li>+\$ 24</li> <li>+\$ 52</li> <li>+\$ 81</li> <li>+\$100</li> <li>+\$115</li> <li>+\$145</li> <li>+\$186</li> <li>+\$231</li> <li>+\$302</li> <li>+\$434</li> <li>+\$ 16</li> <li>+\$ 16</li> <li>+\$ 23</li> </ul>
		<ul style="list-style-type: none"> <li>Specify fabric color number.</li> <li>Specify fabric color number.</li> <li>Specify fabric color number.</li> <li>Specify fabric color number.</li> <li>Specify fabric color number.</li> <li>Specify fabric color number.</li> <li>Specify fabric color number.</li> <li>Specify fabric color number.</li> <li>Specify fabric color number.</li> <li>Specify fabric color number.</li> <li>Specify leather color number.</li> <li>▶ See <i>Surface Materials Reference Manual</i>.</li> <li>▶ See <i>Surface Materials Reference Manual</i>.</li> <li>Specify with soil-retardant treatment.</li> </ul>
	<b>Back and seat</b> <ul style="list-style-type: none"> <li>• Customiz stain on wood</li> </ul>	<ul style="list-style-type: none"> <li>No cost</li> </ul> <ul style="list-style-type: none"> <li>Specify with Customiz stain.</li> <li>▶ See <i>Surface Materials Reference Manual</i>.</li> </ul>
	<b>Legs</b> <ul style="list-style-type: none"> <li>• Sterling</li> </ul>	<ul style="list-style-type: none"> <li>+\$ 28</li> </ul> <ul style="list-style-type: none"> <li>Specify with 4798 Sterling legs.</li> </ul>

## Specification Information

### Wood Back and Seat



• Style Number  
• U.S. Base Price

DECKS1 \$765

### Wood Back and Upholstered Seat



• Style Number  
• U.S. Base Price

DECKS2 \$743

### Upholstered Back and Seat



• Style Number  
• U.S. Base Price

DECKS3 \$691



### For Canadian Pricing

Multiply U.S. Price by the Canadian price factor.

▶ See page 1 for details.



---

# Surface Materials

<b>Surface Materials</b>	<b>90</b>
<b>Wood Seating Upholstery Matrix</b>	<b>93</b>
<b>Wood Color Availability Matrix</b>	<b>94</b>
<b>Guidelines for Directional Fabrics</b>	<b>95</b>

# Surface Materials

This listing includes all the surface material choices that are available for the products in this specification guide.

## Resources

For more information about surface materials, refer to the following resources:

**Additional surface materials specification tools** are available to assist you in the specification process—the Surface Materials Binders.

**The global surface materials palette** is a core collection of finishes that is available across multiple geographies (Americas/EMEA – Europe, Middle East, and Africa/APAC – Asia Pacific) and on global product lines, where applicable. For a list of finishes included in the offering, see the *Surface Materials Reference Manual*. Additional details, like product approvals by geography and finish number conversions, can also be found in the *Surface Materials Reference Manual* or see [steelcase.com/surfacematerials](http://steelcase.com/surfacematerials).

## Surface Materials Binders

- Surface Materials Reference Manual
- A complete set of swatch cards for hard surfaces, vertical surface fabrics, and seating upholstery

## Metal

### Steelcase Surfaces

4798	Sterling Metallic
7026	Nickel
7207	Black
8046	Polished Aluminum
9201	Polished Chrome

## Paint

### Steelcase Surfaces

0835	Black
4799	Platinum Metallic
7207	Black

## Wood

► See *Wood Color Availability Matrix* on page 94 for color availability by product line and wood species.

*Tip: The wood used in the construction of chairs is either maple or European beech. Wood finishes applied to maple or beech will match the color of stains applied to oak, walnut, or cherry, but will not have the same natural grain. Composite color finishes will match the color of composites on veneered surfaces, but will not have the same grain pattern.*

## Steelcase Surfaces

### Wood Seating color choices

3062	Graphite Walnut
3402	Clear Cherry (Aged)
3412	Natural Cherry <b>E</b>
3422	Medium Cherry
3522	Clear Maple*
3572	Amber on Maple <b>E</b>
3592	Blonde on Maple
3602	Desert Oak
3612	Warm Oak <b>E</b>
3692	Espresso Oak
3702	Clear Walnut
3712	Natural Walnut
3722	Dark Mahogany on Walnut
3752	Medium Walnut
3762	Dark Walnut
3772	Medium Mahogany on Walnut

3JDX	Oak Composite**
3JFX	Maple Composite**
3JHX	Cherry Composite**
3JJX	Walnut Composite**

*\*To ensure an understanding of the color ranges and characteristic variations of natural veneer, a sign-off sheet is required prior to orders being accepted for this clear-coat finish. The sign-off sheet is available through Steelcase advertising stock. Form number 05-0001370*

*\*\*To ensure an understanding of the color ranges and characteristics of composite veneer, a sign-off sheet is required prior to orders being accepted for composite veneer. The composite sign-off sheet is available through Steelcase advertising stock. Form number 14-0000141.*

## Custom Surfaces

**Customiz stain** is a service that allows you to create your own stain colors and finishes on standard veneer. Customiz stain color is available on all product lines that offer wood veneer.

A \$425 stain-matching fee applies on CUSTOMIZ requests (Exception: The \$425 fee does not apply on matches to Coalesse standard finishes or for a low-gloss finish request on a standard color). The \$425 fee covers the cost of formulating the Customiz color finish and applies regardless of whether or not an order for product is placed.

In addition, an approval form must be signed to indicate customer acceptance of Customiz match. A \$5,000 initiation fee will be charged prior to first order entry. This initiation fee activates the finish for unlimited use on any Steelcase product for an 18 month time period. After the 18 month time period has lapsed, the Customiz finish may be reactivated for another 18 months for a \$1,000 fee at any point within five years after the \$5,000 initiation fee was paid. If the finish is not reactivated within five years after the \$5,000 initiation fee was paid, the finish will be culled and the customer will need to pay the \$5,000 initiation fee again. All style number related Customiz charges products are no cost as of April 2014. The matching and initiation fees are not discountable.

Customiz stain takes 10 days to formulate. Consult the *Surface Materials Reference Manual* for more information. Custom veneers are also available and must be quoted by Steelcase specials group. Customiz stain on custom veneers takes 2 to 4 weeks to formulate.

Requirements and information on ordering a Customiz stain color are found in the *Surface Materials Reference Manual*.

## Upholstery

### Steelcase Surfaces

#### Price Group 1

##### Buzz2

5F01	Camel <b>E</b>
5F03	Tomato
5F04	Red <b>E</b>
5F05	Burgundy
5F06	Sky <b>E</b>
5F07	Blue
5F08	Navy
5F10	Grape <b>E</b>
5F11	Eggplant <b>E</b>
5F15	Stone
5F16	Grey
5F17	Black
5G50	Dunegrass
5G51	Sable
5G52	Barley
5G53	Sunrise
5G54	Carrot
5G55	Pumpkin
5G56	Timber
5G57	Rogue
5G58	Chocolate
5G59	Meadow
5G60	Ivy
5G61	Cyan
5G62	Atlantic
5G63	Crocus
5G64	Alpine
5G65	Tornado

##### Jacks

5B61	Taupe
5B63	Camel
5B64	Pewter
5B66	Plum
5B70	Midnight

##### Link

5A20	Burgundy
5A23	Green
5A24	Blue
5A25	Navy
5A26	Purple
5A27	Black
5A28	Ocean
5A30	Chamois

##### Playground

5F28	Claret
5F29	Chile
5F30	Amber
5F31	Nut
5F32	Blade
5F33	Stone
5F34	Sky
5F35	Navy
5F36	Huckleberry
5F37	Charcoal

**E** = Established

**Price Group 2****Chainmail**

5550	Cotton
5551	Space
5552	Silver Dollar
5553	Volcano
5554	Orange Crush
5555	Tricycle
5556	Geranium
5557	Banana
5558	Margarita
5559	Lagoon

**Cogent: Connect**

5S15	Coconut
5S16	Turmeric
5S17	Tangerine
5S18	Scarlet
5S19	Concord
5S20	Maya Blue
5S21	Blue Jay
5S23	Wasabi
5S24	Nickel
5S25	Graphite
5S26	Licorice
5S27	Malt
5S28	Root Beer
5S93	Blueprint
5S94	Lizard
5S95	Sailor
5S96	Quicksilver
5S97	Nugget
5S98	Canary
5S99	Lipstick
5SD0	Royal Blue

**Cogent: Geode Seating E**

5S47	Coal
5S48	Smoke
5S49	Cobalt
5S50	Ink
5S55	Sunset
5S57	Thunder

**Cogent: Geode Vertical E**

5S32	Canyon
5S35	Slate
5S36	Cement
5S37	Rock
5S38	Oyster
5S40	Toast
5S41	Sesame
5S42	Ecru

**Cogent: Trails**

5S29	Bronzite
5S30	Amethyst
5S84	Jasper
5S85	Agate
5S86	Lapis
5S87	Malachite
5S88	Quartz
5S89	Carnelian
5S90	Tiger Eye
5S91	Travertine
5S92	Topaz

E = Established

**Cricket E**

5A84	Plum
5A85	Camel
5A86	Charcoal
5A87	Black
5A90	Currant
5A91	Spearmint
5A92	Sky
5A93	Midnight
5A95	Ocean
5A96	Forest

**Crosswalk**

5F48	Beech
5F49	Moon
5F50	Berry
5F51	Admiral Blue
5F52	Moss
5F53	Persimmon
5F54	Bittersweet
5F55	Midnight
5F56	Poppy

**Nitelights**

5F58	Hazelnut
5F59	Burgundy
5F60	Cherry
5F61	Earth
5F62	Shore
5F63	Moss
5F64	Sea
5F65	Regal Blue
5F66	Stone
5F67	Moon

**Seating Vinyl E**

5801	Topaz
5805	Foggy Night
5809	Black
5810	Forest
5812	Navy
5813	Currant
5814	Leaf
5815	Seaside
5817	Pebble
5818	Spice
5819	Thistle
5820	Coffee
5822	Iris

**Spyder**

5B00	Orchid E
5B01	Foggy Night E
5B04	Peri E
5B06	Dove E
5B07	Sage E
5B09	Topaz E

**Stand In**

5621	Sleet
5622	Lunar
5623	Cyclone
5624	Eclipse
5625	Powder
5626	Chardonnay
5627	Graham
5628	Sediment
5629	Allspice
5630	Apple
5631	Lava
5632	Cayenne
5633	Plantain
5634	Parsley
5635	Scallion
5636	Atlantis
5691	Orca

**Zoe2**

5C90	Eggplant
5C91	Aloe
5C92	Fiddle
5C93	Patina
5C94	Peacock
5C95	Rain
5C96	Grey Flannel
5C97	Pebble
5C98	Cymbal
5C99	Fiesta

**Price Group 3****Gaja - C2C**

5W40	Black
5W41	Pepper
5W42	Pearl Grey
5W43	Crimson
5W44	Ink
5W45	Night Blue
5W46	Petrol
5W47	Greige
5W48	Sepia
5W49	Umber
5W50	Java
5W51	Camellia Red
5W52	Emerald
5W53	Snow Pea
5W54	Olive
5W55	Light Blue
5W56	Maroon
5W57	Black Raspberry
5W58	Spruce
5W59	Apple Green
5W60	Deep Blue
5W61	Chili Pepper
5W62	Daffodil

**Imperma**

TM01	Toffee
TM02	Pigeon
TM03	Fossil
TM04	Poppyseed
TM05	Auburn
TM06	Cumin
TM07	Marble
TM08	Cliff
TM09	Tarragon
TM10	Pesto
TM11	Wave
TM12	Niagara
TM13	Tuscan
TM14	Peppercorn

**Redeem**

TM50	Brick
TM51	Yolk
TM52	Cinnamon
TM53	Daisy
TM54	Pine
TM55	Water
TM56	Dill
TM57	Lavender
TM58	Mallard
TM59	Caramel
TM60	Greyhound
TM61	Mocha
TM62	Iceberg
TM63	Chestnut
TM64	Granite
TM65	Cashmere
TM66	Barnwood

**Retrieve**

TM30	Kelly
TM31	Lake
TM32	Gala
TM33	Papaya
TM34	Dandelion
TM35	Curry
TM36	Lilac
TM37	Submarine
TM38	Driftwood
TM39	Bistro
TM40	Quarry
TM41	Mohair
TM42	Shadow
TM43	Seal
TM44	Chalk

**Texel**

TM20	Angora
TM21	Grist
TM22	Galaxy
TM23	Terracotta
TM24	Nude
TM25	Field
TM26	Haze

**Price Group 5****Bo Peep**

5G66	Pita
5G67	Bone
5G68	Safari
5G69	Brown Sugar
5G70	Chocolate Chip
5G71	Candlelight
5G72	Honey Mustard
5G73	Marmalade
5G74	Picnic
5G75	Pinot
5G76	Bloom
5G77	Grapevine
5G78	Firefly
5G79	Artichoke
5G80	Serpent
5G81	Carolina
5G82	Blue Bonnet
5G83	Nautical
5G84	Gravel
5G85	Sharkskin
5G86	Kohl

**Remix**

RE01	Rust
RE02	Pumpkin
RE03	Pebble
RE04	Dark Chocolate
RE05	Beige
RE06	Linen Beige
RE07	Hazelnut
RE08	Concrete Grey
RE09	Sky Blue
RE10	Blue Jean
RE11	Ivy Green
RE12	Primavera Yellow
RE13	Night Blue

**Price Group 6****Brisa**

BR01	Black Onyx
BR04	Truffle
BR06	Ash
BR07	Sage
BR08	Celery
BR09	Sterling Blue
BR10	Night Navy
BR11	Cambridge Blue
BR12	Abyss
BR13	Canyon
BR14	Pompeian Red
BR15	Salsa
BR16	Cinnabar
BR17	Aztec
BR18	New Sand
BR19	Cream
BR20	White
BR21	Moccasin
BR22	Buckskin
BR23	Prairie

**Price Group 7**

**Steelcut Trio**

- TR01 Mist Grey
- TR02 Stone Grey
- TR03 Cassonade Beige
- TR04 Nutmeg Beige
- TR05 Chocolate Blue
- TR06 Licorice Black
- TR07 Mustard Yellow
- TR08 Red Currant
- TR09 Raspberry Pink
- TR10 Myrtille Brown
- TR11 Ice Blue
- TR12 Electric Blue
- TR13 Peppermint Green
- TR14 Blue Jay Mix
- TR15 Brown Frost
- TR16 Lime Green

**Leather Price Group**

**Steelcase Leather**

- L107 Black
- L207 Mahogany
- L220 Soapstone
- L221 Rocky
- L500 Camel
- L503 Navy

**Elmosoft Leather Price Group**

**Elmosoft Leather**

- L110 Maritime Blue
- L111 Midnight Blue
- L112 Ebony
- L113 Gunmetal
- L114 Mica
- L115 Dove Grey
- L116 Plum Pleasure
- L122 Truffle
- L128 Red Birch
- L132 Violet
- L133 Espresso
- L134 Ruby
- L135 Scarlet
- L136 Claret
- L137 Cabernet
- L138 Bourbon
- L139 Cinder
- L140 Garnet
- L143 Pecan
- L144 Chamois
- L145 Palomino
- L146 Russet
- L147 Saddle
- L148 Goldstone
- L150 Ivory
- L151 White
- L709 Sugar
- L710 Lava
- L711 Parchment
- L712 Buff
- L713 Sand
- L714 Maize
- L715 Camel
- L716 Khaki
- L717 Cameo
- L718 Mushroom
- L719 Taupe
- L720 Fawn
- L721 Rock
- L722 Desert
- L723 Storm
- L724 Mist
- L725 Teal
- L726 Celadon
- L727 Egyptian Blue
- L728 Bright Blue
- L729 Aquarium
- L730 Hunter
- L731 Fern
- L732 Edamame
- L733 Moss
- L734 Key Lime
- L735 Creamsicle
- L736 Lemon
- L737 Sunshine
- L738 Drama
- L739 Byzantium
- L740 Dazzle
- L741 Fuchsia
- L742 Flamingo

**Select Surfaces**

**For information on products within Select Surfaces,** including accent paints and fabrics from Designtex, Gabriel, Kvadrat, and Pollack, please refer to the *Surface Materials Reference Manual* or visit [Steelcase.com/selectsurfaces](http://Steelcase.com/selectsurfaces).

**Custom Surfaces**

**Price Group COM (Customer's Own Material)**

**Fabric Approval and Yardage**

To confirm whether a particular COM material has already been tested for use on a specific Steelcase product or to determine actual yardage requirements:

- Visit [www.steelcase.com](http://www.steelcase.com)

**For additional information regarding Customer's Own Material,** call 1.888.STEELCASE.

# Wood Seating Upholstery Matrix

Not every fabric is available on every chair. This matrix gives an overview of the upholstery fabrics that can be specified on each seating product line.

### Legend

- = Not available
- = Available
- = Available with exceptions
- Ⓜ = Established
- 🌐 = This pattern is part of the global surface materials palette. Geographical differences, by color and product line may apply.
- ▶ See specification guide for details.

	Price Group	Alcove	Collaboration	Deck	England	Escapade	Gentry	Mansfield	Mingle	Mobile Pad Cushion Top - EE, Lateral Tops/2 Seam	Mobile Pad Cushion Top - EE, Lateral Tops/4 Seam	Oriana	Sawyer	Siento	Snodgrass	Terrazzo	Theorem	Topaz
<b>Bo Peep</b>	5	■	■	■	■	■	■	■	■	■	•	■	■	■	■	■	■	■
<b>Brisa</b>	6	■	■	■	■	■	■	■	■	•	■	■	■	■	■	■	■	■
<b>Buzz2</b> 🌐	1	■	■	■	■	■	■	■	■	•	■	■	■	■	■	■	■	■
<b>Chainmail</b>	2	■	■	■	■	■	■	■	■	•	■	■	■	■	■	■	■	■
<b>Cogent: Connect</b> 🌐	2	■	■	■	■	■	■	■	■	•	■	■	■	■	■	■	■	■
<b>Cogent: Geode Seating</b> Ⓜ	2	■	■	■	■	■	■	■	■	•	■	■	•	■	■	■	■	■
<b>Cogent: Geode Vertical</b> Ⓜ	2	■	■	■	■	■	■	■	■	•	■	■	•	■	■	■	■	■
<b>Cogent: Trails</b>	2	■	■	■	■	■	■	■	■	•	■	■	■	■	■	■	■	■
<b>Cricket</b> Ⓜ	2	■	■	■	■	■	■	■	■	•	■	■	■	■	■	■	■	■
<b>Crosswalk</b>	2	■	■	■	■	■	■	■	■	•	■	■	•	■	■	■	■	■
<b>Elmosoft Leather</b> 🌐	EL	•	•	•	•	•	•	•	•	■	•	•	■	■	•	•	•	•
<b>Hampstead</b>	3	■	■	■	■	■	■	■	■	•	■	■	■	■	■	■	■	■
<b>Imperma</b>	3	■	■	■	■	■	■	■	■	•	■	■	■	■	■	■	■	■
<b>Jacks</b>	1	■	■	■	■	■	■	■	■	•	■	■	■	■	■	■	■	■
<b>Steelcase Leather</b>	L	■	■	■	■	■	■	■	■	•	■	■	■	■	■	■	■	■
<b>Link</b>	1	■	■	■	■	■	■	■	■	•	■	■	■	■	■	■	■	■
<b>Nitelights</b>	2	■	■	■	■	■	■	■	■	•	■	■	■	■	■	■	■	■
<b>Playground</b>	1	■	■	■	■	■	■	■	■	•	■	■	■	■	■	■	■	■
<b>Redeem</b>	3	■	■	■	■	■	■	■	■	•	■	■	■	■	■	■	■	■
<b>Remix</b> 🌐	5	■	■	■	■	■	■	■	■	•	■	■	■	■	■	■	■	■
<b>Retrieve</b>	3	■	■	■	■	■	■	■	■	•	■	■	■	■	■	■	■	■
<b>Seating Vinyl</b> Ⓜ	2	•	•	■	•	■	•	•	■	•	■	•	■	■	■	■	■	•
<b>Spyder</b> Ⓜ	2	■	■	■	■	■	■	■	■	•	■	■	•	■	■	■	■	■
<b>Stand In</b>	2	•	•	■	•	■	•	•	■	•	■	•	■	■	■	■	■	•
<b>Steelcut Trio</b> 🌐	7	■	■	■	■	■	■	■	■	•	■	■	•	■	■	■	■	■
<b>Texel</b>	3	■	■	■	■	■	■	■	■	•	■	■	■	■	■	■	■	■
<b>Zoe2</b>	2	■	■	■	■	■	■	■	■	•	■	■	■	■	■	■	■	■

Surface Materials

**Note: Certain fabrics and leathers appear loose with comfort wrinkles when upholstered.**

# Wood Color Availability Matrix

Not every wood color is available on every seating component. This matrix gives an overview of which wood colors can be specified for each seating component.

			Species or type of wood																				
			3062 Graphite Walnut	3402 Clear Cherry (Aged) <sup>E</sup>	3412 Natural Cherry	3422 Medium Cherry	3522 Clear Maple**	3572 Amber on Maple <sup>E</sup>	3592 Blonde on Maple	3602 Desert Oak	3612 Warm Oak <sup>E</sup>	3692 Espresso Oak	3702 Clear Walnut	3712 Natural Walnut	3722 Dark Mahogany on Walnut	3752 Medium Walnut	3762 Dark Walnut	3772 Medium Mahogany on Walnut	3JDX Oak Composite***	3JFX Maple Composite***	3JHX Cherry Composite***	3JJX Walnut Composite***	
<b>Alcove</b>	Frame	European Beech	■	■	■	■	•	■	■	■	■	■	■	■	■	■	■	■	■	■	■	■	■
<b>Collaboration</b>	Frame and inserts	European Beech	■	■	■	■	■	■	■	■	■	■	■	■	■	■	■	■	■	■	■	■	■
<b>Deck</b>	Frame	Maple	■	■	■	■	■	■	■	■	■	■	■	■	■	■	■	■	■	■	■	■	■
<b>England</b>	Frame	Maple	■	■	■	■	■	■	■	■	■	■	■	■	■	■	■	■	■	■	■	■	■
<b>Escapade</b>	Frame	European Beech	■	■	■	■	•	■	■	■	■	■	■	■	■	■	■	■	■	■	■	■	■
<b>Gentry</b>	Base, arms, and frame	Maple	■	■	■	■	■	■	■	■	■	■	■	■	■	■	■	■	■	■	■	■	■
<b>Mansfield</b>	Frame, back, and arms	Maple	■	■	■	■	■	■	■	■	■	■	■	■	■	■	■	■	■	■	■	■	■
<b>Mingle</b>	Legs, back, and arms	Maple	■	■	■	■	■	■	■	■	■	■	■	■	■	■	■	■	■	■	■	■	■
<b>Oriana</b>	Frame	European Beech	■	■	■	■	■	■	■	■	■	■	■	■	■	■	■	■	■	■	■	■	■
<b>Sawyer</b>	Frame	European Beech	■	■	■	■	■	■	■	■	■	■	■	■	■	■	■	■	■	■	■	■	■
<b>Snodgrass</b>	Frame and arms	Maple	■	■	■	■	■	■	■	■	■	■	■	■	■	■	■	■	■	■	■	■	■
<b>Terrazzo</b>	Frame and back slats	European Beech	■	■	■	■	•	■	■	■	■	■	■	■	■	■	■	■	■	■	■	■	■
<b>Theorum</b>	Base	Maple	■	■	■	■	■	■	■	■	■	■	■	■	■	■	■	■	■	■	■	■	■
<b>Topaz</b>	Frame and arms	European Beech	■	■	■	■	•	■	■	■	■	■	■	■	■	■	■	■	■	■	■	■	■

*Tip: The wood used in the construction of chairs is either maple or European beech. Wood finishes applied to maple or beech will match the color of stains applied to oak, walnut, or cherry, but will not have the same natural grain. Composite color finishes will match the color of composites on veneered surfaces, but will not have the same grain pattern.*

*\*\*To ensure an understanding of the color ranges and characteristic variations of natural veneer, a sign-off sheet is required prior to orders being accepted for this clear-coat finish. The sign-off sheet is available through Steelcase advertising stock. Form number 05-0001370*

*Note: Wood color 3522 is a clear coat. Therefore, the natural variations in wood (maple or European beech) will be visible.*

*Note: Due to natural variations in wood, finish products may vary in color, texture and grain.*

*\*\*\*To ensure an understanding of the color ranges and characteristics of composite veneer, a sign-off sheet is required prior to orders being accepted for composite veneer. The composite sign-off sheet is available through Steelcase advertising stock. Form number 14-0000141.*

## Legend

- = Not available
- = Available
- = Available with exceptions
- <sup>E</sup> = Established
- ▶ See specification guide for details.

## What is the issue?

Some textiles are plain and look the same regardless of which direction the fabric is applied to the product. But many customers prefer fabrics that have patterns that give a clear direction to the textile. Because there are limits to how directional fabrics can be applied to panels and chairs, it is important to understand directional fabrics to avoid being disappointed.

## Talking about direction

Fabrics come on rolls. The long threads that run parallel to the length of the roll are called the warp. The perpendicular threads that run parallel to the width of the roll are called the filling.

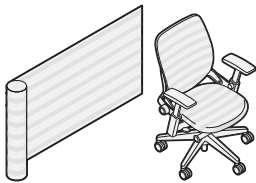

**Railroaded** means the height dimension of the product is perpendicular to the warp of the fabric; *warp horizontal* and *across roll* are other terms for running the fabric in this direction. All Steelcase standard fabrics are railroaded. The yardage requirements for railroaded cutting are calculated using the width of the fabric, quantity ordered, style of chair(s), and pattern repeat.

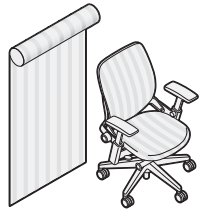

**Woven way** means the height dimension of the product is parallel to the warp of the fabric; *warp vertical* and *down roll* are other terms for running the fabric in this direction. The yardage requirements for woven way cutting are calculated using the width of the fabric, quantity ordered, and style of chair(s).

## What determines fabric direction?

The width of the roll of fabric and the techniques that are used to apply it to the product can both determine the direction. Standard default direction for seating products with Steelcase standard fabrics is railroaded. No exceptions are possible. COM fabrics are standard woven way. You may specify a COM fabric to be cut in a specific direction if the product allows it to be applied. The purchase order must clearly state the cutting direction if it is other than standard.

*Tip: If you are changing the cutting direction of fabric, yardage requirements may increase, resulting in an additional upcharge. This upcharge will be applied to the purchase order.*

▶ See *Yardage Requirements* in the *Surface Materials Reference Manual* for specific information.

**If you have any questions** regarding cutting direction guidelines, please call the Steelcase Solutions Resource Team at 1.888.STEELCASE or 1.888.783.3522. You can also find this information on our Web site:

- Visit [www.steelcase.com](http://www.steelcase.com)

## COM pattern exceptions

Sometimes COM fabrics have patterns that look awkward or inappropriate if they are applied in the standard direction (woven way). Those cases are addressed with these two pattern exception rules.



Incorrect



Correct



Incorrect



Correct

### 1

Fabrics with stripes or flame stitch will be applied so that the patterns are vertical.



Incorrect



Correct



Incorrect



Correct

### 2

Fabrics with patterns of people, vines, or flower arrangements will be applied so that the pattern is vertical.





---

# Resources

<b>Wood Touch-Up Kits</b>	<b>98</b>
<b>Style Number Index</b>	<b>100</b>

---

# Wood Touch-Up Kits

## How to Order Wood Touch-Up Kits

Order wood finish touch-up kits from J. Kaltz Co. Specify the desired Steelcase finish code (i.e. 3422). Each kit, priced at \$9.98, contains one brush tip marker and one fil-stick. A minimum order of \$15 is required. Shipping, estimated at approximately \$5 per kit, is extra. Dealer will be charged directly. No additional discounts apply.

Place orders as follows:

- Phone: 616.942.6070
- Web: <http://jkaltzco.com>
- Email: [susan.bothwell@jkaltzco.com](mailto:susan.bothwell@jkaltzco.com)

Orders placed before noon Eastern Standard Time will ship the same day via standard ground shipping and will arrive in three to five days. Express shipment is not available due to the combustible nature of the materials.



# Style Number Index

Style Number	Page	Description
<b>0113</b>	46	England Guest Chair
<b>0114</b>	46	England Guest Chair
<b>0202</b>	66	Oriana Guest Chair
<b>0204</b>	66	Oriana Guest Chair
<b>0205</b>	66	Oriana Guest Chair
<b>0612W</b>	54	Gentry Guest Chair
<b>0632BN</b>	33	Gentry LowBk Desk Chair
<b>0633WN</b>	31	Gentry LowBk Desk Chair
<b>0634BN</b>	33	Gentry LowBk Desk Chair
<b>0634WN</b>	31	Gentry LowBk Desk Chair
<b>0643WN</b>	31	Gentry HiBk Desk Chair
<b>0644BN</b>	33	Gentry HiBk Desk Chair
<b>0644WN</b>	31	Gentry HiBk Desk Chair
<b>120</b>	43	Collaboration Guest Chair
<b>120D</b>	43	Collaboration Guest Chair
<b>120L</b>	43	Collaboration Guest Chair
<b>120U</b>	43	Collaboration Guest Chair
<b>140</b>	20	Mansfield Desk Chair
<b>141</b>	20	Mansfield Desk Chair
<b>142</b>	58	Mansfield Guest Chair
<b>474419W</b>	74	Snodgrass 474 Guest Chair
<b>499111</b>	17	Siento Mid-Back Desk Chair
<b>499112</b>	17	Siento Mid-Back Desk Chair
<b>499113</b>	17	Siento Mid-Back Desk Chair
<b>499121</b>	17	Siento Mid-Back Desk Chair
<b>499122</b>	17	Siento Mid-Back Desk Chair
<b>499123</b>	17	Siento Mid-Back Desk Chair
<b>499211</b>	17	Siento High-Back Desk Chair
<b>499212</b>	17	Siento High-Back Desk Chair
<b>499213</b>	17	Siento High-Back Desk Chair
<b>499221</b>	17	Siento High-Back Desk Chair
<b>499222</b>	17	Siento High-Back Desk Chair
<b>499223</b>	17	Siento High-Back Desk Chair
<b>499SIENTO</b>	14	Siento Design Pkg High-Back Chair
<b>711N</b>	25	Theorem HiBk Desk Chair
<b>711NS</b>	25	Theorem HiBk Desk Chair
<b>711NSX</b>	25	Theorem HiBk Desk Chair
<b>711NX</b>	25	Theorem HiBk Desk Chair
<b>721N</b>	25	Theorem MidBk Desk Chair
<b>721NS</b>	25	Theorem MidBk Desk Chair
<b>721NSX</b>	25	Theorem MidBk Desk Chair
<b>721NX</b>	25	Theorem MidBk Desk Chair
<b>DECKA1</b>	87	Deck Guest Chair
<b>DECKA2</b>	87	Deck Guest Chair
<b>DECKA3</b>	87	Deck Guest Chair
<b>DECKC14</b>	87	Deck Guest Chair
<b>DECKC15</b>	87	Deck Guest Chair
<b>DECKC24</b>	87	Deck Guest Chair
<b>DECKC25</b>	87	Deck Guest Chair
<b>DECKC34</b>	87	Deck Guest Chair
<b>DECKC35</b>	87	Deck Guest Chair
<b>DECKS1</b>	88	Deck Stool
<b>DECKS2</b>	88	Deck Stool
<b>DECKS3</b>	88	Deck Stool
<b>G20</b>	38	Alcove Guest Chair

Style Number	Page	Description
<b>G22</b>	50	Escapade Guest Chair
<b>G23</b>	50	Escapade Guest Chair
<b>G24</b>	82	Topaz Guest Chair
<b>G26</b>	82	Topaz Guest Chair
<b>MNGLB</b>	62	Mingle Guest Chair
<b>TERR1</b>	78	Terrazzo Guest Chair
<b>TERR2</b>	78	Terrazzo Guest Chair
<b>TERR3</b>	78	Terrazzo Guest Chair
<b>TS37602</b>	70	Sawyer Chair



# Trademark List

® The following are registered trademarks for products of Steelcase Inc. or one of its related corporate entities: 4 o'clock, 900 Series, à la carte, Airtouch, Ally, Amia, Answer, Archipelago, Avenir, Ballet, Bix, Brayton International, Cachet, Canopy, Canto, Chancellor, Coalesse, Confidante, Context, Convene, CopyCam, Criterion, Crushed Can, Currency, dash, Designtex, Details, Detour, Drive, Elective Elements, Ellipse, Ember Chrome, Emerge, E-Table 2, FYI, Garland, Gentry, Ginkgo Biloba, Groupwork, Ideo, Jacket, Jenny, Jersey, Kart, Kick, LaCosta, Leap, Let's B, LiveBack, Max-Stacker, media:scape, Metro, Migrations, Mitra, Montage, Nurture, Oriana, Parade, Pathways, PCT, Permiso, Player, PolyVision, Portal, Power Pincher, Progeny, Protégé, R2, Rally, Relevant, Reply, Rizzi Arc, Sensor, Series 9000, Siento, Sieste, Sine, Softcare, Springboard, Steelcase, Steelcase Design Partnership, Stella, Stow Davis, Swathmore, TeamWork, Technique, Texpress, Think, Thunder, Topo, Train, Turnstone, Underline, Unison, Vecta, Viridian, Walden, Werndl, and X-Stack.

® The following registered trademarks are under license from AWI Licensing Company, Dover, DE: SoundScapes, DuraBrite, BioBlock, and Armstrong.

® The following registered trademarks are under license from Byrne Electrical, Rockford, MI: Interport, Mini-Port, Axil Z, and Ellora.

® The following is a registered trademark of DuPont, Wilmington, DE: Corian.

® The following is a registered trademark of Genlyte Thomas Company, Louisville, KY: Lightolier.

® The following is a registered trademark of Hilti Corporation, FL-9494 Schaan, Principality of Liechtenstein: Hilti.

® The following is a registered trademark of Leviton Manufacturing Company, Little Neck, NY: Decora.

® The following is a registered trademark of Mechanical Plastics Corp, Elmsford, NY: Toggler.

® The following is a registered trademark of Microsoft Corporation, Redmond, WA: Microsoft.

® The following is a registered trademark of Panduit Corporation, Lockport, IL: Panduit.

® The following is a registered trademark of Trav (Press), Cuneo, Italy: Assisa.

® The following is a registered trademark of Virtual Ink, Boston, MA: mimioActive.

® The following registered trademarks are under license from Wilkhahn Furniture Products: Avera, Senzo, Versal, and Wilkhahn FS.

® The following is a registered trademark of Wilsonart International, Temple, TX: Chemsurf.

® The following is a registered trademark of Wiremold, West Hartford, CT: Wiremold.

® The following is a registered trademark of EMU Group S.P.A., Perugia, Italy: Emu.

™ The following are trademarks for products of Steelcase Inc. or one of its related corporate entities: Access, Active/Passive Shelf, Ainsley, Akira, Alcove, Alerion, aLight, Amaris, American Elect, American Tradition, ap40, Arbor, Arriva, Asana, Ascot, Aspekt, Astor, Await, Bira, Bivi, Bottomline, Brook, Buoy, Burton, c:scape, Calla, Calm, Camber, Campfire, Capa, Cappuccino, Cesar, Chester, Chord, Circa, Clarendon, Classic Rectangular, cobi, Collaboration, Community, Company, Convey, Cortex, Coupe, Crea, Crew, Cura, Cypress, Davenport, Dearborn, Deck, Déjà, Denizen, Denska, Derby, Divisio, Donovan, Dune, Duo, e<sup>3</sup>, e<sup>3</sup> ceramicsteel, e<sup>3</sup> environmental ceramicsteel, Echo, Edge, Elsna, Empath, Empress, Enea, ēno, EnSync, Enviro, Escapade, Exchange, Exponents, Field, Flat Top, FlexFrame, Flip Top, Flute, Folio, FrameOne, FreeFlow, Frontier, Galilei, Gesture, Ginger, Ginkgo, Go Wall, Grip, Groove, Hatchback, Hawthorne, Hitch, Host Collection, Hosu, Huddleboard, i2i, Impact, Indy, InfoLink, IOS, I-Solve, Jack, Jarrah, Jetty, Juice, Kami, Kast, Kathryn, Lagunitas, Lark, L'Attitude, LearnLab, Leela, Lincoln, Linden, LiveSeat, Loria, Lyric, Malibu, Malibu Too, Mansfield, Marathon, Martini, Mason, Masque, Millbrae, Mineral, Mingle, Mystic, Mystic Metal, Mystic Wood, Montreal, Move, Nadia, Neighbor, nesso, Nickel, Nikko, Nod, Node, Norfolk, Ontrak, Oom, Opus, Orchid, Outlook Collection, Ovation, Paloma, Paperflo, Parliament, Pasio, Passerelle, Patriarch, Payback, Peek, Pile File, Pisa, Pool, PUCK, QiVi, Quba, Rave, Reed, Regard, Relay, Reunion, Ripple, Riser, Rocco, Rocky, RoomWizard, Runner, Satellite, Sawyer, ScapeSeries, Senti, Sentinel, Senza, Sequoia, Session, ShareLink, Shield, Shortcut, Sidewalk, Skylar, Slumber, Smoke, Snug, Soft Leaf, Sonata, Sorrel, SOTO, Stationkits, Stiletto, Surprise!, Switch, Symphony, Sync, TagWizard, Tava, TeamStudio, TeamTheater, Tenaro, Terrazzo, Theorem, Thread, Topaz, Touchdown, Tour, Tower Too, Trees, Trillium, Trolley, tX2, U-Free, Uno, V.I.A., Verb, Verge, Victor2, Visalia, Waldorf, Woodruff, Workspring, and X-tenz.

™ The following is a trademark of Microsoft Corporation, Redmond, WA: Windows.

™ The following is a trademark of Rodman Industries, Inc., Oconomowoc, WI: ResinCore1.

™ The following is a trademark of Ultrafabrics, LLC, Elmsford, NY: Ultraleather.

™ The following trademarks are under license from Wilkhahn Furniture products: Cana, Linus, Logon, Picto, Range, Stitz, Thema, Timetable, and Tubis.

™ The following is a trademark of MBDC, Charlottesville, VA: Cradle to Cradle and C2C.

™ The following trademarks are under license from Walter Knoll: Andoo, Bob, Lazlo, Lox, Ribbon, and Together.

™ The following trademarks are under license from PP Möbler: Bar and Flag Halyard.

™ The following trademarks are under license from Viccarbe: Davos, Holy Day, Last Minute, RS, and Wrapp.

™ The following trademarks are under license from Carl Hansen: Elbow, Paddle, Shell, Wing, and Wishbone.

™ The following trademarks are under license from Cambridge Sound Management, LLC, Cambridge, MA: QtPro Soundmasking, Qt Quiet Technology, and Sonet Qt.

™ The following is a trademark of Electri-Cable Assemblies, Shelton, CT: Interact.

*Trademarks used here in are the property of Steelcase, Inc. or of their respective owners.*