

# Denizen Collection Benches

DESIGN WILLIAMS SOREL DESIGN ORIGIN: 2009 UNITED STATES

**Benches** create a primary platform to support storage, and a secondary surface for piling, book storage and/or printer storage.

**Monitor shelf** allows for large scale display with integrated cable slots at back.

**Bench** is available in wood veneer.

**Legs and frame** come in powder coat paint or brushed nickel. Legs have adjustable glides.

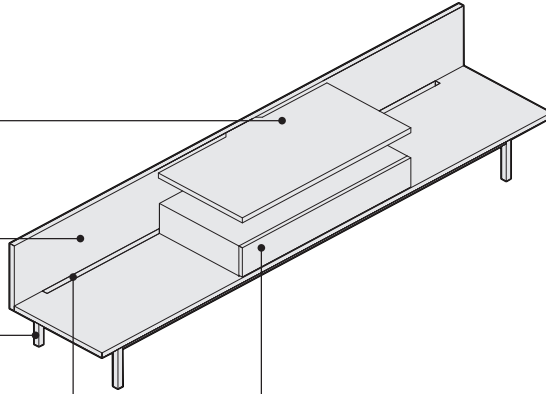

**Drawers** for miscellaneous media storage are available on monitor shelf versions.

**Full length wire management slot at back** allows for routing of cables and cords from displays and storage components.

## Product Details

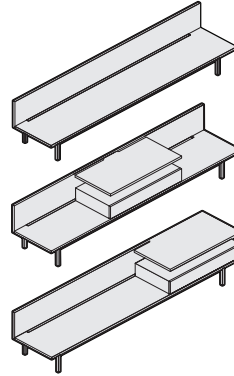

**Benches** are available with or without monitor support shelf with integrated media or general storage drawer in two widths 72" and 96".

**Benches** leverage the perimeter of enclosed spaces for more efficient use.

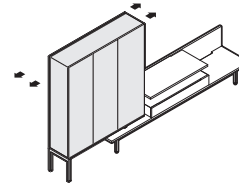

**Benches** enable slip-fit with storage elements for wall-to-wall application and reconfigurability.

**Glides** adjust 3/4".

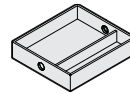

**Optional bento box** is available for drawer.

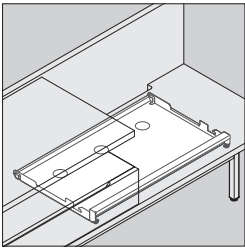
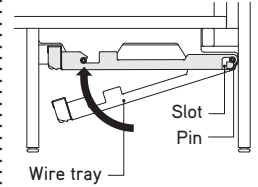

**Drop down wire management tray** manages cord and cables, keeping them off the floor and hiding unsightly clutter.

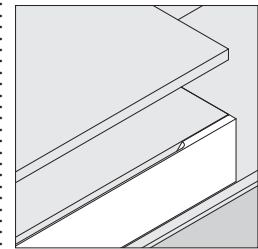

**Integrated pulls** allow for clean uninterrupted aesthetic.

**Self-close drawers** are standard with undermount slides.

**Drawer interiors** are Birch, dovetail construction.

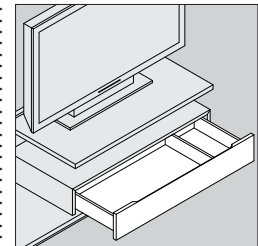

**Media/general storage drawer** to store miscellaneous items and bento boxes.

## Actual Interior Dimensions

	Drawer Inside Large Section	Drawer Inside Small Section
Depth	15 1/4"	15 1/4"
Width	25 1/2"	10 1/2"
Height	4 3/4"	4 3/4"

*Note: Bench height is 11 1/2"H from floor and back panel adds an additional 12"H. Monitor shelf with drawer below is 40"W.*

# Denizen Collection Benches

DESIGN WILLIAMS SOREL DESIGN ORIGIN: 2009 UNITED STATES

## Wire Management

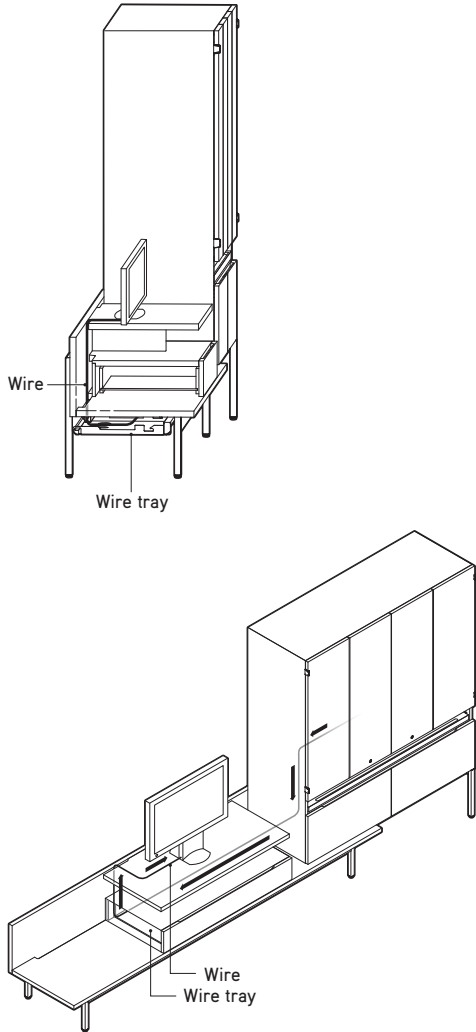

**Wire management** can be done in back of unit, cables and cords are managed from wall to furniture or displays.

## Slip Fit Rules

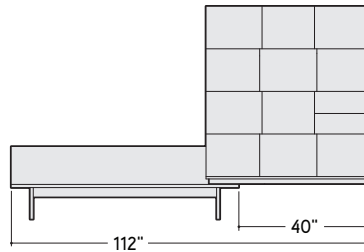
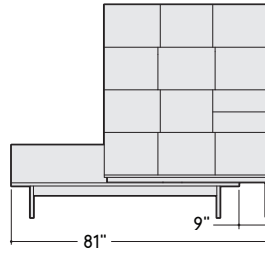

72" bench with 52"W storage (bandwidth is 81"-112")

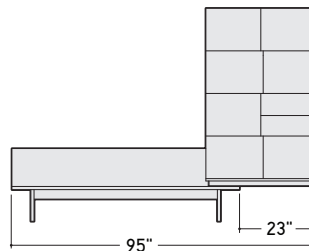
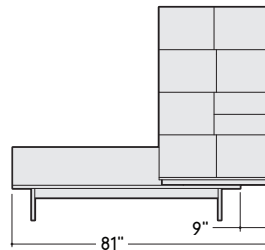

72" bench with 35"W storage (bandwidth is 81"-95")

# Denizen Collection Benches *continued*

DESIGN WILLIAMS SOREL DESIGN ORIGIN: 2009 UNITED STATES

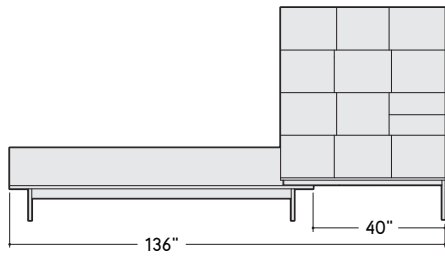
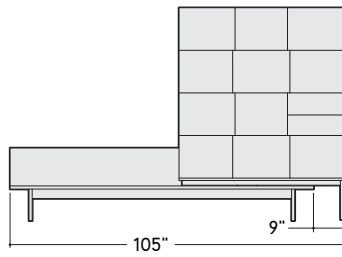

96" bench with 52"W storage (bandwidth is 105"-136")

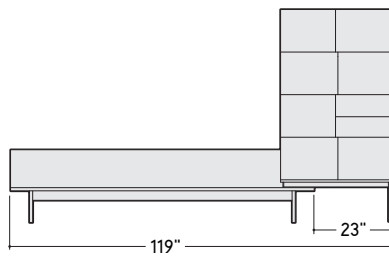
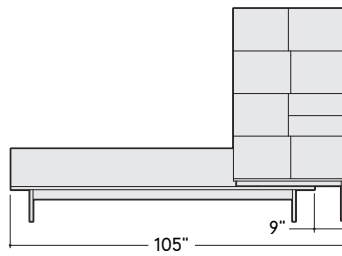

96" bench with 35"W storage (bandwidth is 105"-119")

### Surface Materials

#### Wood

- V3AK Rift Cut Oak
- V2AA Quarter Cut Grey Ash
- V2AT Quarter Cut Teak

#### Paint

Standard specifiable powder coat options:

- 4138 Graphite Gloss
- 4142 Platinum Gloss
- 4144 Black Gloss
- 4147 Champagne Gloss
- 9238 Brushed Nickel

# Denizen Collection Open Benches

DESIGN WILLIAMS SOREL DESIGN ORIGIN: 2009 UNITED STATES

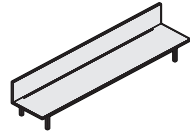

Tip: Ships assembled.

Tip: Glides have 3/4" adjustment.

Tip: Power strip is ordered separately.

Standard Includes	Required to Specify
-------------------	---------------------

<p>► Need help? Product details, page 50</p> <ul style="list-style-type: none"> <li>• Wood base and back panel: V3AK Rift Cut Oak veneer</li> <li>• Metal legs and frame: paint</li> <li>• Full length wire management slot along back of base</li> <li>• Drop down wire management tray under base: black matte paint only</li> <li>• Leveling glides</li> </ul>	<ol style="list-style-type: none"> <li>1 Style number</li> <li>2 Wood finish for bench</li> <li>3 Paint finish for legs and frame</li> <li>4 Options, if selected (see below)</li> </ol> <p>► See <i>Surface Materials</i>, page 410.</p>
---	---

Options	U.S. Price	Required to Specify
---------	------------	---------------------

<p><b>Surface Materials</b></p> <p><b>Top</b></p> <ul style="list-style-type: none"> <li>• V2AA Quarter Cut Grey Ash</li> <li>• V2AT Quarter Cut Teak</li> </ul> <p><b>Legs/Frame</b></p> <ul style="list-style-type: none"> <li>• Brushed nickel</li> </ul>	<p>Prices below</p> <p>Prices below</p> <p>+ \$650</p>	<p>Specify with <i>grey ash</i>.</p> <p>Specify with <i>teak</i>.</p> <p>Specify with <i>brushed nickel legs/frame</i>.</p>
--	--	---

<p><b>Related Products</b></p> <ul style="list-style-type: none"> <li>• Power strip</li> </ul>	<p>► See page 72</p>
--	----------------------

Specification Information						
---------------------------	--	--	--	--	--	--

Dimensions			Style Number	U.S. Base Prices		
D	W	H		Finishes:		
				Oak	Ash	Teak

## Open Benches

21 1/4"	72"	23 3/8"	<b>CODB7223</b>	\$1900	\$1957	\$2375
21 1/4"	96"	23 3/8"	<b>CODB9623</b>	\$2400	\$2472	\$3000



**For Canadian Pricing**  
 Multiply U.S. Price by the Canadian price factor.  
 ► See page 1 for details.

# Denizen Collection Benches with Shelf and Drawer

DESIGN WILLIAMS SOREL DESIGN ORIGIN: 2009 UNITED STATES

Tip: Ships assembled.

Tip: Glides have 3/4" adjustment.

Standard Includes		Required to Specify
<ul style="list-style-type: none"> <li>▶ Need help? Product details, page 50</li> </ul>	<ul style="list-style-type: none"> <li>• Wood base and back panel: V3AK Rift Cut Oak veneer</li> <li>• Metal legs and frame: paint</li> <li>• Full length wire management slot along back of base</li> <li>• Drop down wire management tray under base: black matte paint only</li> <li>• Monitor support shelf with integrated media/general storage drawer</li> <li>• Integrated pull on drawer</li> <li>• Self-close slides</li> <li>• Birch dovetail drawer interiors</li> <li>• Leveling glides</li> </ul>	<ol style="list-style-type: none"> <li>1 Style number</li> <li>2 Wood finish for bench</li> <li>3 Paint finish for legs and frame</li> <li>4 Options, if selected (see below)</li> </ol> <p>▶ See <i>Surface Materials</i>, page 410.</p>

	Options	U.S. Price	Required to Specify
<b>Surface Materials</b>	<b>Top</b>		
	<ul style="list-style-type: none"> <li>• V2AA Quarter Cut Grey Ash</li> <li>• V2AT Quarter Cut Teak</li> </ul>	Prices below Prices below	Specify with <i>grey ash</i> . Specify with <i>teak</i> .
<b>Storage</b>	<b>Legs/Frame</b>		
	<ul style="list-style-type: none"> <li>• Brushed nickel</li> </ul>	+\$650	Specify with <i>brushed nickel legs/frame</i> .
<b>Lock</b>	<ul style="list-style-type: none"> <li>• Bento box</li> </ul>	+\$195	Specify with <i>bento box</i> .
<b>Lock</b>	<ul style="list-style-type: none"> <li>• Lock in drawer, nickel</li> <li>• Lock in drawer, ember chrome</li> </ul>	+\$125 +\$125	Specify with <i>9211 Nickel lock</i> . Specify with <i>9250 Ember Chrome lock</i> .
	<b>Keying</b>	<ul style="list-style-type: none"> <li>• Factory- and field-installed keying units</li> </ul>	▶ See page 394
<b>Related Products</b>	<ul style="list-style-type: none"> <li>• Power strip</li> </ul>		▶ See page 72

Tip: Power strip is ordered separately.

Specification Information							
Dimensions	Style Number	U.S. Base Prices					
		D	W	H	Finishes:		
					Oak	Ash	Teak

## Bench with Shelf and Drawer, Center

21 1/4"	96"	23 3/8"	CODBS9623C	\$3400	\$3502	\$4250
---------	-----	---------	------------	--------	--------	--------

## Bench with Shelf and Drawer, Left

21 1/4"	96"	23 3/8"	CODBS9623L	\$3400	\$3502	\$4250
---------	-----	---------	------------	--------	--------	--------

## Bench with Shelf and Drawer, Right

21 1/4"	96"	23 3/8"	CODBS9623R	\$3400	\$3502	\$4250
---------	-----	---------	------------	--------	--------	--------

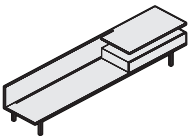
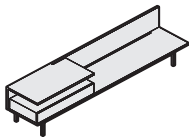
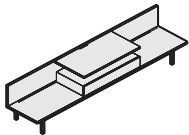

**For Canadian Pricing**  
Multiply U.S. Price by the Canadian price factor.  
▶ See page 1 for details.

# Denizen Collection Overheads

DESIGN WILLIAMS SOREL DESIGN ORIGIN: 2009 UNITED STATES

**Wall-mounted overhead storage** is available with a range of cubby storage with dimensional relationship to bench elements and freestanding storage.

**Wall-mount overheads** come in left- and right-hand styles and varied widths.

**Doors** are standard with soft close hinges.

**Open display area** are for personalized items or books.

**Paper cubby shelf area** for additional stacking.

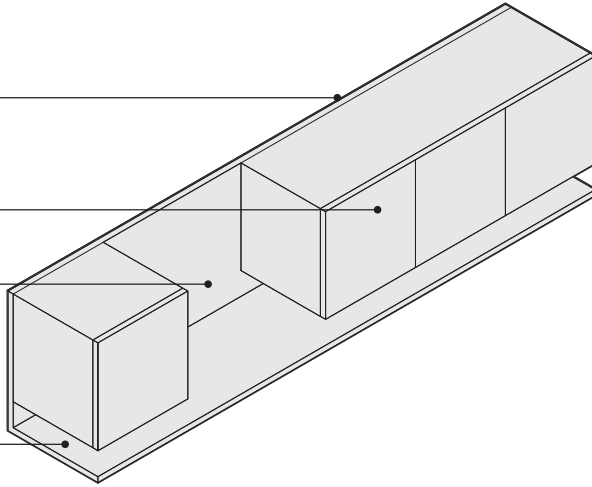

## Dimensions

### Inside Clearance - single door

11¼"D x 11½"W x 12⅞"H

Hinges take an additional ½" from width dimension

### Inside Clearance - double door

11¼"D x 24½"W x 12⅞"H

Hinges take an additional ½" from width dimension

### Open Display Cubby

52"W = 12¼"D x 12¾"W x 16¾"H

72"W = 12¼"D x 19¾"W x 16¾"H

96"W = 12¼"D x 17½"W x 16¾"H

## Product Details

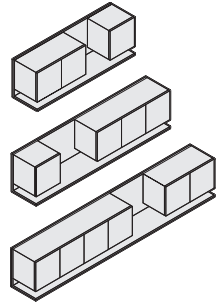

**Three widths and configurations**, left- and right-handed are available which leverage vertical wall space.

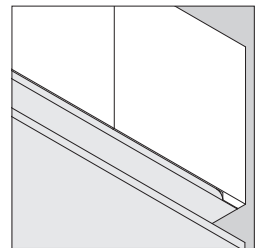
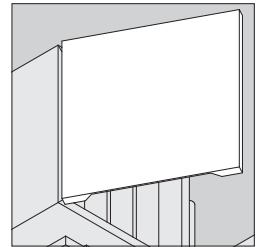

**Integrated pulls** allow for clean uninterrupted aesthetic. Doors are standard with soft-close hinges.

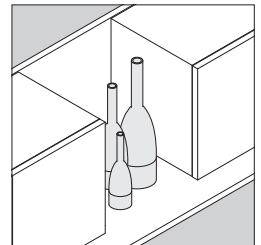

**Open display cubby** creates areas for personalization.

# Denizen Collection *Overheads continued*

DESIGN WILLIAMS SOREL DESIGN ORIGIN: 2009 UNITED STATES

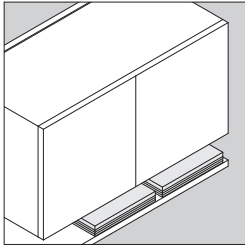

**Paper cubby shelf** accommodates additional stacking surfaces for reduced clutter of individual work process. Cubby storage area is 3 1/8" H x 12 1/8" D.

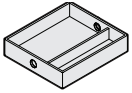

**Optional bento boxes** fit in cubby area.

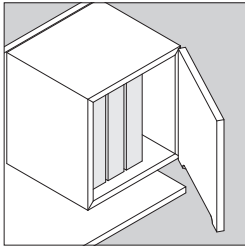

**Storage behind doors** reduces visual clutter for storage of books, binders, or other miscellaneous items.

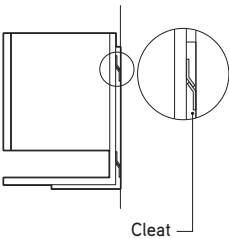
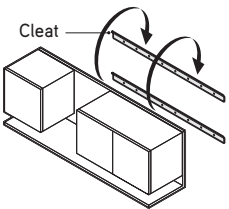

**Wall mount frame support**

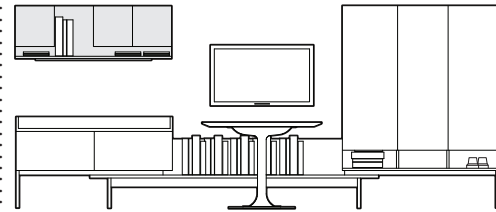
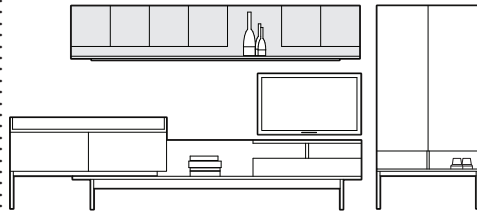
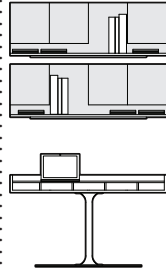

**Flexibility** in supporting a range of applications, mounting where space allows on the wall independently or within a configuration.

## Surface Materials

### Wood

- V3AK Rift Cut Oak
- V2AA Quarter Cut Grey Ash
- V2AT Quarter Cut Teak

# Denizen Collection Left-Hand Overheads

DESIGN WILLIAMS SOREL DESIGN ORIGIN: 2009 UNITED STATES

*Tip: Ships assembled.*

Standard Includes		Required to Specify
<ul style="list-style-type: none"> <li>▶ Need help? Product details, page 55</li> </ul>	<ul style="list-style-type: none"> <li>Overhead with doors, open display, and paper cubby: V3AK Rift Cut Oak veneer</li> <li>Metal support frame: black matte paint</li> <li>Integrated pulls on doors</li> <li>Soft-close hinges</li> <li>Wall mount hardware</li> </ul>	<ol style="list-style-type: none"> <li>Style number</li> <li>Wood finish for overhead</li> <li>Options, if selected (see below)</li> </ol> <p>▶ See <i>Surface Materials</i>, page 410.</p>

	Options	U.S. Price	Required to Specify
<b>Surface Materials</b>	<b>Top</b> <ul style="list-style-type: none"> <li>V2AA Quarter Cut Grey Ash</li> <li>V2AT Quarter Cut Teak</li> </ul>	Prices below Prices below	Specify with <i>grey ash</i> . Specify with <i>teak</i> .
<b>Locks</b>	<b>52"W only</b> <ul style="list-style-type: none"> <li>Two locks in doors, nickel</li> <li>Two locks in doors, ember chrome</li> </ul>	+\$250 +\$250	Specify with <i>two 9211 Nickel locks</i> . Specify with <i>two 9250 Ember Chrome locks</i> .
	<b>72"W and 96"W only</b> <ul style="list-style-type: none"> <li>Three locks in doors, nickel</li> <li>Three locks in doors, ember chrome</li> </ul>	+\$375 +\$375	Specify with <i>three 9211 Nickel locks</i> . Specify with <i>three 9250 Ember Chrome locks</i> .
	<b>Keying</b> <ul style="list-style-type: none"> <li>Factory- and field-installed keying units</li> </ul>		▶ See page 394

Specification Information						
Dimensions			Style Number	U.S. Base Prices		
D	W	H		Finishes:		
				Oak	Ash	Teak

## Left-Hand Overheads

13½"	52"	18"	CODWM52L	\$3300	\$3399	\$4125
------	-----	-----	----------	--------	--------	--------

13½"	72"	18"	CODWM72L	\$3800	\$3914	\$4750
------	-----	-----	----------	--------	--------	--------

13½"	96"	18"	CODWM96L	\$4500	\$4635	\$5625
------	-----	-----	----------	--------	--------	--------

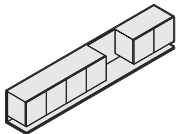
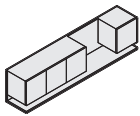
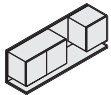

**For Canadian Pricing**  
Multiply U.S. Price by the Canadian price factor.  
▶ See page 1 for details.

# Denizen Collection Right-Hand Overheads

DESIGN WILLIAMS SOREL DESIGN ORIGIN: 2009 UNITED STATES

*Tip: Ships assembled.*

	Standard Includes	Required to Specify
► Need help? Product details, page 55	<ul style="list-style-type: none"> <li>Overhead with doors, open display, and paper cubby: V3AK Rift Cut Oak veneer</li> <li>Metal support frame: black matte paint</li> <li>Integrated pulls on doors</li> <li>Soft-close hinges</li> <li>Wall mount hardware</li> </ul>	1 Style number 2 Wood finish for overhead 3 Options, if selected (see below) ► See <i>Surface Materials</i> , page 410.

	Options	U.S. Price	Required to Specify
<b>Surface Materials</b>	<b>Top</b> <ul style="list-style-type: none"> <li>V2AA Quarter Cut Grey Ash</li> <li>V2AT Quarter Cut Teak</li> </ul>	Prices below Prices below	Specify with <i>grey ash</i> . Specify with <i>teak</i> .
<b>Locks</b>	<b>52"W only</b> <ul style="list-style-type: none"> <li>Two locks in doors, nickel</li> <li>Two locks in doors, ember chrome</li> </ul>	+\$250 +\$250	Specify with <i>two 9211 Nickel locks</i> . Specify with <i>two 9250 Ember Chrome locks</i> .
	<b>72"W and 96"W only</b> <ul style="list-style-type: none"> <li>Three locks in doors, nickel</li> <li>Three locks in doors, ember chrome</li> </ul>	+\$375 +\$375	Specify with <i>three 9211 Nickel locks</i> . Specify with <i>three 9250 Ember Chrome locks</i> .
	<b>Keying</b> <ul style="list-style-type: none"> <li>Factory- and field-installed keying units</li> </ul>		► See page 394

Specification Information						
Dimensions			Style Number	U.S. Base Prices		
D	W	H		Finishes:		
				Oak	Ash	Teak

## Right-Hand Overheads

13½"	52"	18"	CODWM52R	\$3300	\$3399	\$4125
------	-----	-----	----------	--------	--------	--------

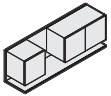

13½"	72"	18"	CODWM72R	\$3800	\$3914	\$4750
------	-----	-----	----------	--------	--------	--------

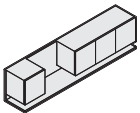

13½"	96"	18"	CODWM96R	\$4500	\$4635	\$5625
------	-----	-----	----------	--------	--------	--------

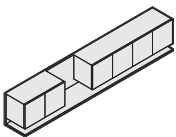

**For Canadian Pricing**  
 Multiply U.S. Price by the Canadian price factor.  
 ► See page 1 for details.

# Denizen Collection Displays

DESIGN WILLIAMS SOREL DESIGN ORIGIN: 2009 UNITED STATES

Displays allow flexibility in supporting a range of applications, mounting where space allows on the wall independently or within a configuration.

Markerboard surface is white glass.

Tray is integrated for dry-erase markers and erasers.

Corkboard surface comes in two types of cork patterns.

Integrated tray allows storage of push pins or other items.

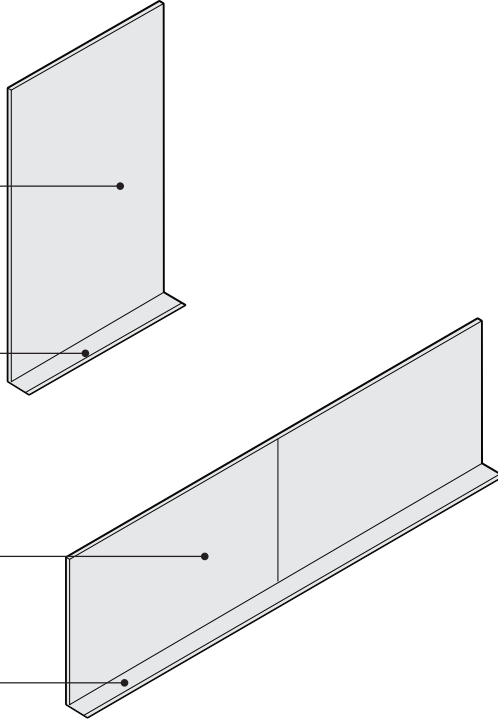

## Product Details

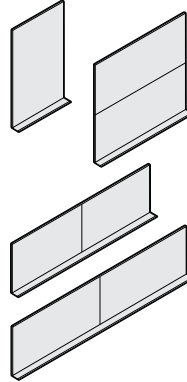

Wall-mounted display surfaces have dimensional relationship to storage components and support work in progress. They leverage vertical wall space.

Visual displays can be used by individuals or shared in group settings.

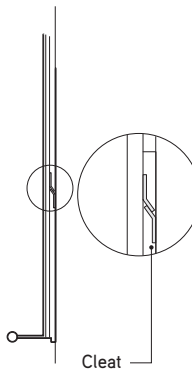
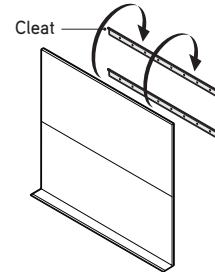

Wall-mount frame

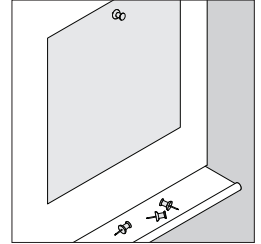

Corkboard comes in four sizes with integrated tray for push pins or pens.

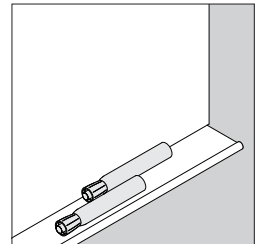

Glass markerboard comes in one size with integrated tray for dry-erase markers.

# Denizen Collection Displays *continued*

DESIGN WILLIAMS SOREL DESIGN ORIGIN: 2009 UNITED STATES

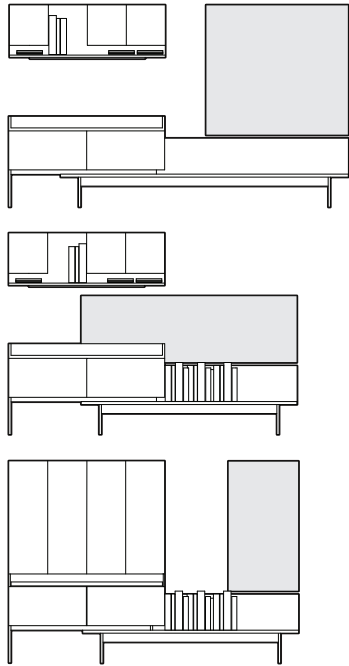

Flexibility in supporting a range of applications.

## Surface Materials

### Corkboard

- COR1 Natural
- COR2 Dark Patterned

### Glass (glass markerboard only)

- ACM Moonlight

### Tray

- Anodized aluminum

# Denizen Collection Display Components

DESIGN WILLIAMS SOREL DESIGN ORIGIN: 2009 UNITED STATES

*Tip: Ships assembled.*

Standard Includes	Required to Specify
<ul style="list-style-type: none"> <li>▶ Need help? Product details, page 59</li> <li>• Corkboard display: cork                             <ul style="list-style-type: none"> <li>- Integrated tray: anodized aluminum</li> </ul> </li> <li>• Markerboard display: ACM Moonlight Glass                             <ul style="list-style-type: none"> <li>- Integrated tray: anodized aluminum</li> </ul> </li> <li>• Wall mount frame support and hardware</li> </ul>	<ul style="list-style-type: none"> <li>1 Style number</li> <li>2 Cork finish for display, if specified</li> <li>▶ See <i>Surface Materials</i>, page 410.</li> </ul>

**Specification Information**

Dimensions			Style	U.S.
D	W	H	Number	Price

### Corkboards

3 <sup>5</sup> / <sub>16</sub> "	24"	42"	CODCB2442	\$ 950
----------------------------------	-----	-----	-----------	--------

3 <sup>5</sup> / <sub>16</sub> "	48"	42"	CODCB4842	\$1450
----------------------------------	-----	-----	-----------	--------

3 <sup>5</sup> / <sub>16</sub> "	72"	23 <sup>1</sup> / <sub>2</sub> "	CODCB7224	\$1300
----------------------------------	-----	----------------------------------	-----------	--------

3 <sup>5</sup> / <sub>16</sub> "	96"	23 <sup>1</sup> / <sub>2</sub> "	CODCB9624	\$1375
----------------------------------	-----	----------------------------------	-----------	--------

### Glass Markerboard

3 <sup>5</sup> / <sub>16</sub> "	24"	42"	CODGM2442	\$1150
----------------------------------	-----	-----	-----------	--------

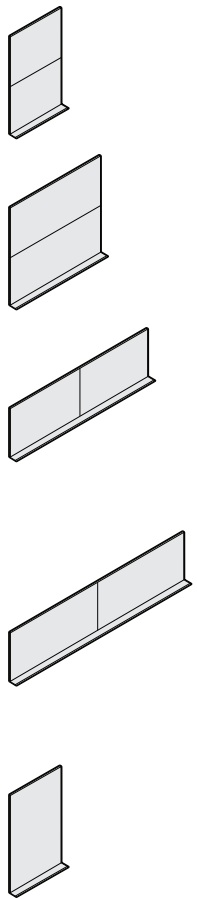

**For Canadian Pricing**  
 Multiply U.S. Price by the Canadian price factor.  
 ▶ See page 1 for details.

# Denizen Collection Wardrobe Storage and Towers

DESIGN WILLIAMS SOREL DESIGN ORIGIN: 2009 UNITED STATES

**A range of residentially** inspired storage elements that support conventional storage requirements and personal display are available.

**Doors** are standard with soft-close hinges and accommodates books, binders or other miscellaneous items.

**Box drawers** accommodate miscellaneous items and bento boxes.

**File drawer** accommodates letter-size filing.

**Legs** can be assembled for freestanding application (two set of legs) or can be assembled for slip-fit applications with the bench (one set of legs). Legs are non-handed.

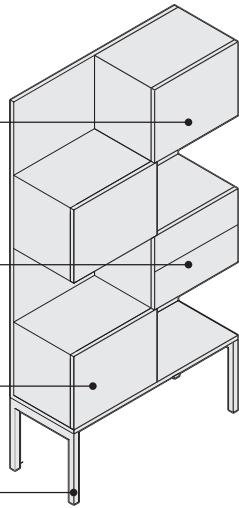

**Wardrobe area** for storage of coats, boots, and other miscellaneous items.

**Legs and frame** come in powder coat paint or brushed nickel. Legs have adjustable glides.

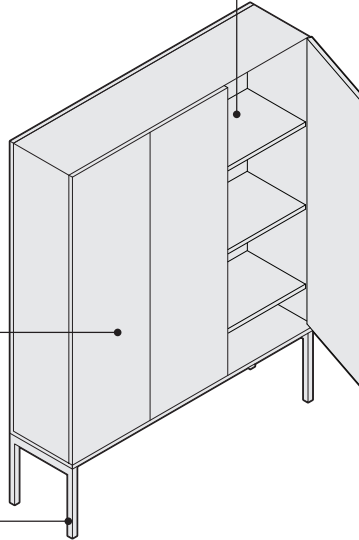

**Storage area on 52"W wardrobe cabinet** is standard with adjustable shelves.

## Product Details

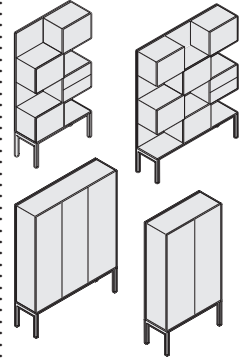

**Storage and towers** provide supplementary freestanding storage capacity when needed.

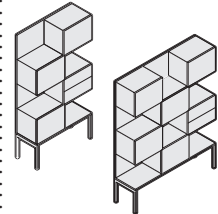

**Towers** come in four and six cube designs.

**Towers** are standard with one set of box drawers and one bottom file drawer. All other openings on cube towers are doors.

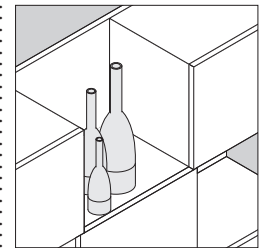

**Towers** provide display for personalization.

## Dimensions

### Wardrobe Cabinet

Coat rod area behind fascia is 9 1/4"D

Coat rod fascia is inset 1 3/4"

### Storage Cabinet

Standard with three (3/4"H) adjustable shelves

20 holes on 2" centers

First hole from bottom starts at 6 3/4"

First hole from top starts at 8 1/2"

11 1/8"D x 33 3/4"W x 53 1/4"H interior dimension

### Cube open space

12"D x 17"W x 13 3/8"H (outer)

12"D x 16 1/4"W x 13 3/8"H (inner)

### Cube door interior

12"D x 16 3/8"W x 12"H

# Denizen Collection Wardrobe Storage and Towers

DESIGN WILLIAMS SOREL DESIGN ORIGIN: 2009 UNITED STATES

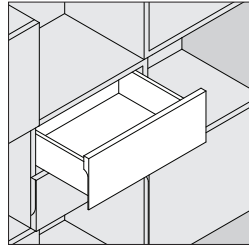

**Self-close drawers** are standard with undermount slides. Drawer interiors are birch, dovetail construction.

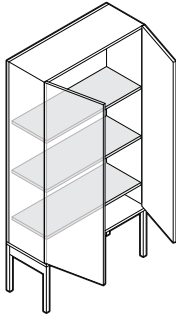

**Wardrobe cabinet** with optional storage cabinet shelving is available in two widths (35"W and 53"W). Lock is optional. Storage cabinet comes with three adjustable shelves.

## Surface Materials

### Wood

- V2AA Quarter Cut Grey Ash
- V2AT Quarter Cut Teak
- V3AK Rift Cut Oak

### Paint

Standard specifiable powder coat options:

- 4138 Graphite gloss
- 4142 Platinum gloss
- 4144 Black gloss
- 4147 Champagne gloss
- 9238 Brushed nickel

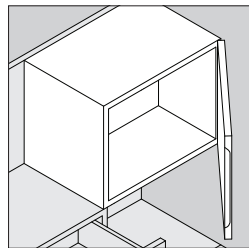

**Integrated pulls** allow for clean uninterrupted aesthetic. Doors are standard with soft-close hinges.

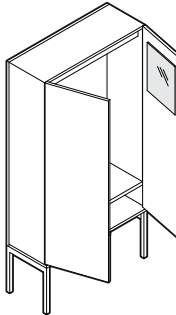

**Mirror** provided in an aluminum frame with 8" X 12" X 5/8" thick. Optional interior mirror is for wardrobe cabinet only.

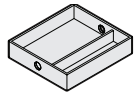

**Optional bento boxes** fit in box drawers or can sit on display shelves.

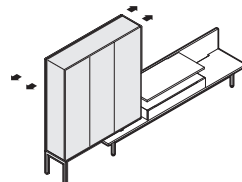

**Non-handed, slip-fit leg design** comes with hardware to attach to bench or free-standing for wall-to wall applications and reconfigurability.

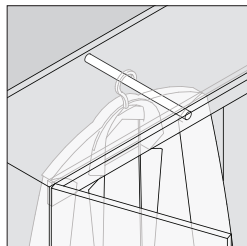

**Wardrobe cabinet** is standard with a hanger rod. 52"W wardrobe is a wardrobe behind the left two doors and has shelves behind right door.

# Denizen Collection Cube Towers

DESIGN WILLIAMS SOREL    DESIGN ORIGIN: 2009 UNITED STATES

*Tip: Ships ready-to-assemble (legs). Legs come unassembled and are shipped folded at bottom.*

*Tip: Glides have 3/4" adjustment.*

*Tip: Bento box may be ordered separately.*

*Tip: If the application is free-standing, the slip-fit hardware kit will not be used. If the application is to adjoin to the bench for slip-fitting, one set of legs will not be used. In both cases, keep the unused piece for future reconfigurations.*

Standard Includes	Required to Specify
<ul style="list-style-type: none"> <li>▶ Need help? Product details, page 62</li> <li>• Tower with doors, open display and box drawers: V3AK Rift Cut Oak veneer</li> <li>• Non-handed metal legs and frame: paint</li> <li>• One standard placement of box drawers and file drawer for 4-cube and 6-cube tower</li> <li>• Integrated pull on doors and drawers</li> <li>• Undermount self-close slides on drawers</li> <li>• Birch dovetail box drawer interiors</li> <li>• Soft-close hinges on doors</li> <li>• Slip-fit hardware connection to bench</li> <li>• 2 box drawers and 1 file drawer at bottom</li> <li>• Leveling glides</li> </ul>	<ul style="list-style-type: none"> <li>1 Style number</li> <li>2 Wood finish for tower</li> <li>3 Paint finish for legs and frame</li> <li>4 Options, if selected (see below)</li> <li>▶ See <i>Surface Materials</i>, page 410.</li> </ul>

Options	U.S. Price	Required to Specify
<b>Surface Materials</b> <ul style="list-style-type: none"> <li>• <b>Top</b></li> <li>• V2AA Quarter Cut Grey Ash</li> <li>• V2AT Quarter Cut Teak</li> </ul>	Prices below Prices below	Specify <i>with grey ash</i> . Specify <i>with teak</i> .
<ul style="list-style-type: none"> <li>• <b>Legs/frame</b></li> <li>• Brushed nickel</li> </ul>	+\$400	Specify <i>with brushed nickel legs/frame</i> .
<b>Storage</b> <ul style="list-style-type: none"> <li>• Bento box</li> </ul>	+\$195	Specify <i>with bento box</i> .
<b>Lock</b> <ul style="list-style-type: none"> <li>• <b>Four Cubes</b></li> <li>• Four locks in door/drawers, nickel</li> <li>• Four locks in door/drawers, ember chrome</li> </ul>	+\$500 +\$500	Specify <i>with four 9211 Nickel locks</i> . Specify <i>with four 9250 Ember Chrome locks</i> .
<ul style="list-style-type: none"> <li>• <b>Six Cubes</b></li> <li>• Six locks in door/drawers, nickel</li> <li>• Six locks in door/drawers, ember chrome</li> </ul>	+\$750 +\$750	Specify <i>with six 9211 Nickel locks</i> . Specify <i>with six 9250 Ember Chrome locks</i> .
<ul style="list-style-type: none"> <li>• <b>Keying</b></li> <li>• Factory- and field-installed keying units</li> </ul>		▶ See page 394

### Specification Information

Dimensions			Style Number	U.S. Base Prices		
D	W	H		Finishes:		
				Oak	Ash	Teak

### Cube Towers

13½"	35"	67¾"	<b>COD4T3568</b>	\$5700	\$5871	\$7125
------	-----	------	------------------	--------	--------	--------

13½"	52"	67¾"	<b>COD6T5268</b>	\$6800	\$7004	\$8500
------	-----	------	------------------	--------	--------	--------

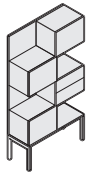

# Denizen Collection Wardrobe Storage Towers

DESIGN WILLIAMS SOREL DESIGN ORIGIN: 2009 UNITED STATES

*Tip: Ships ready-to-assemble (legs). Legs come unassembled and are shipped folded at bottom.*

*Tip: Glides have 3/4" adjustment.*

*Tip: If the application is free-standing, the slip-fit hardware kit will not be used. If the application is to adjoin to the bench for slip-fitting, one set of legs will not be used. In both cases, keep the unused piece for future reconfigurations.*

Standard Includes		Required to Specify
<ul style="list-style-type: none"> <li>▶ Need help? Product details, page 62</li> </ul>	<ul style="list-style-type: none"> <li>• Wardrobe with doors: V3AK Rift Cut Oak veneer</li> <li>• Non-handed metal legs and frame: paint</li> <li>• 52"W wardrobe version, coat rod behind double doors at left, shelves behind single door at right</li> <li>• 35"W wardrobe version, coat rod behind double doors</li> <li>• Integrated pull on doors</li> <li>• Soft-close hinges</li> <li>• Slip-fit hardware connection to bench</li> <li>• Leveling glides</li> </ul>	<ol style="list-style-type: none"> <li>1 Style number</li> <li>2 Wood finish for tower</li> <li>3 Paint finish for legs and frame</li> <li>4 Options, if selected (see below)</li> </ol> <p>▶ See <i>Surface Materials</i>, page 410.</p>

	Options	U.S. Price	Required to Specify
<b>Surface Materials</b>	<b>Top</b>		
	<ul style="list-style-type: none"> <li>• V2AA Quarter Cut Grey Ash</li> <li>• V2AT Quarter Cut Teak</li> </ul>	Prices below Prices below	Specify with <i>grey ash</i> . Specify with <i>teak</i> .
<b>Storage</b>	<b>Legs/frame</b>		
	<ul style="list-style-type: none"> <li>• Brushed nickel</li> </ul>	+\$400	Specify with <i>brushed nickel legs/frame</i> .
	<b>Wardrobe cabinet configuration only</b>		
	<ul style="list-style-type: none"> <li>• Interior wardrobe door mirror</li> </ul>	+\$250	Specify with <i>door mirror</i> .
	<b>Storage cabinet configuration only</b>		
	<ul style="list-style-type: none"> <li>• Storage shelves in place of 35"W wardrobe</li> <li>• Storage shelves in place of 52"W wardrobe</li> </ul>	+\$300 +\$400	Specify with <i>storage shelves</i> . Specify with <i>storage shelves</i> .
<b>Locks</b>	<b>35"W Door</b>		
	<ul style="list-style-type: none"> <li>• One lock in door, nickel</li> <li>• One lock in door, ember chrome</li> </ul>	+\$125 +\$125	Specify with <i>one 9211 Nickel lock</i> . Specify with <i>one 9250 Ember Chrome lock</i> .
	<b>52"W Door</b>		
	<ul style="list-style-type: none"> <li>• Two locks in door, nickel</li> <li>• Two locks in door, ember chrome</li> </ul>	+\$250 +\$250	Specify with <i>two 9211 Nickel locks</i> . Specify with <i>two 9250 Ember Chrome locks</i> .
	<b>Keying</b>		
	<ul style="list-style-type: none"> <li>• Factory- and field-installed keying units</li> </ul>		▶ See page 394

### Specification Information

Dimensions			Style Number	U.S. Base Prices		
D	W	H		Finishes:		
				Oak	Ash	Teak

### Wardrobe Storage Towers

13½"	35"	67¾"	CODWS3568	\$4100	\$4223	\$5125
13½"	52"	67¾"	CODWS5268	\$5100	\$5253	\$6375

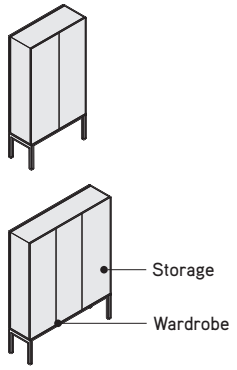

 **For Canadian Pricing**  
Multiply U.S. Price by the Canadian price factor.  
▶ See page 1 for details.

# Denizen Collection Secretaries and Credenzas

DESIGN WILLIAMS SOREL DESIGN ORIGIN: 2009 UNITED STATES

Range of residentially inspired storage elements that support conventional storage requirements and personal display.

Integrated removable wire covers are standard in all secretaries.

Legs and frame are standard in powder coat paint, and brushed nickel.

Adjustable glides have 3/4" adjustment.

Bifold doors are self closing which discreetly hide personal clutter when doors are closed.

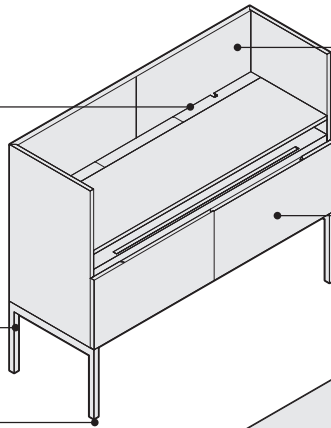

Cork panel is standard on back panel and is offered in two patterns.

File drawers are standard with self-closing feature.

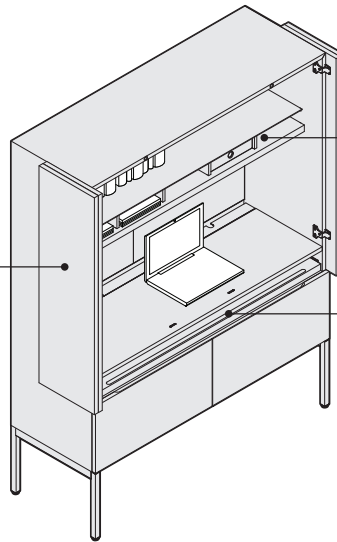

Optional cubby/lighting shelf for bento boxes and/or paper filing.

Pull-out keyboard shelf is standard with self-closing feature.

## Product Details

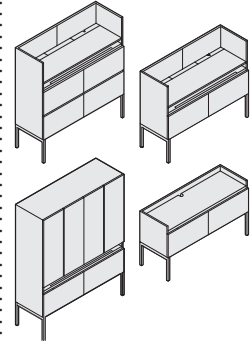

Secretaries in three heights and differing configurations are available. Credenza is standard in one height.

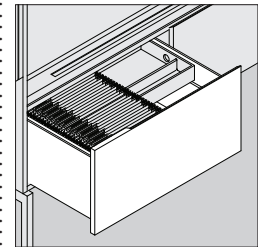

Self close drawers are standard with undermount slides. Drawers are birch and have dovetail drawer interiors.

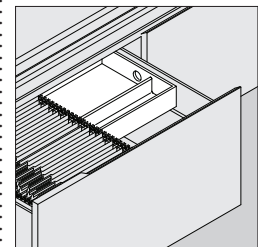

File drawers can file legal (side-to-side), letter (front-to-back), and can store on the right side utilizing wire clips, a bento box.

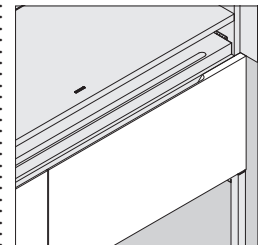

Integrated pulls allow for clean uninterrupted aesthetic.

## Dimensions

### Secretaries

Pull-out shelf is 12 7/8" deep

23 7/8" H clearance above pull-out shelf

### 68" H Secretary

Top section clearance with lighting is 11 1/2" H x 13 3/8" D x 50 1/2" W

Lighting section is 4 1/2" thick that has 4 dividers, which work with bento boxes

Interior dimensions with cork panel option: 20 1/4" H x 16 1/8" D x 50 1/2" W

Interior dimensions no cork panel option: 20 1/4" H x 17 1/8" D x 50 1/2" W

Cork panel hides wire from shelf lighting and other cords

Pull-out shelf is 26 5/8" H from floor to underside of shelf

Pull-out shelf is 27 3/4" to pull-out surface

Tip: Legs come unassembled and are shipped folded at bottom.

### 56" H Secretary

Top open work section: 12" H x 17 1/8" D x 50 1/2" W

Pull-out shelf is 39 3/4" H from floor to underside of shelf.

Pull-out shelf is 40 7/8" to pull-out surface

### 42" H Secretary

Top open work section: 3" H x 17 1/8" D x 50 1/2" W

Pull-out shelf is 26 5/8" H from floor to underside of shelf

Pull-out shelf is 27 3/4" to pull-out surface

### Secretaries/Credenza

Drawer interior: 23" W x 15 1/4" D x 9 3/8" H (with overhead 11 1/2" H)

Divider is 1/2" thick

# Denizen Collection Secretaries and Credenzas

DESIGN WILLIAMS SOREL DESIGN ORIGIN: 2009 UNITED STATES

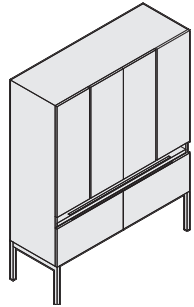

Personal clutter can be discreetly contained behind the enclosed door.

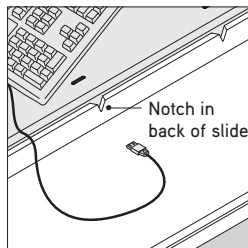
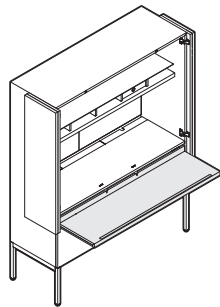

Pull-out keyboard tray provides additional surface and is standard with a self-closing feature.

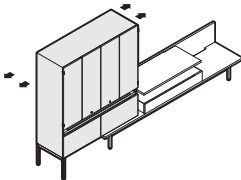

Non-handed, slip-fit leg design comes with hardware to attach to bench or free-standing for wall-to-wall applications and reconfigurability.

Glides adjust 1/4".

## Wire Management

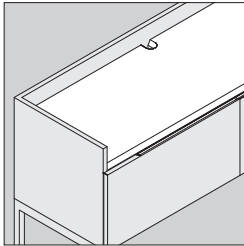

Credenza grommet cutout.

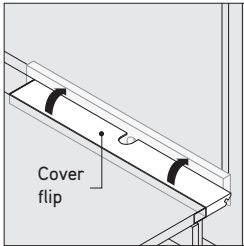
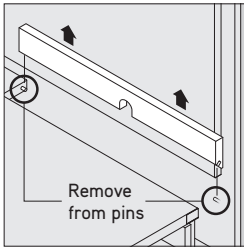

Secretaries are standard with integrated removable wire management covers for easy access to cable management.

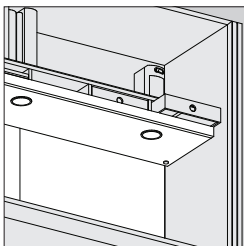

Optional cork panel with cubby shelf with lighting. Three halogen dimmable lights are available under the optional shelf. Lights are operated by "touch" button located at back of shelf.

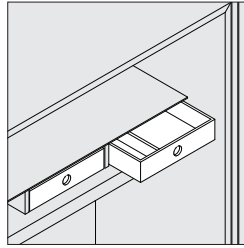

Optional bento boxes can be used with cubby/lighting shelf.

## Clearances

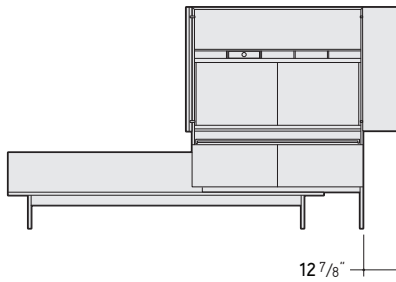

Door swing on secretary is 13" for clearance against a wall.

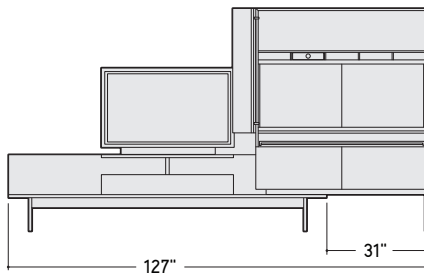

Door swings on secretary is 13" for clearance with 42" monitor on center shelf, clearance depends on position of monitor and size.

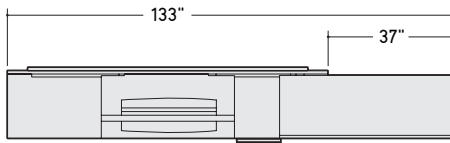

## Surface Materials

### Secretaries:

- Wood**
- V2AA Quarter Cut Grey Ash
  - V2AT Quarter Cut Teak
  - V3AK Rift Cut Oak

### Paint

- Standard specifiable powder coat options:
- 4138 Graphite Gloss
  - 4142 Platinum Gloss
  - 4144 Black Gloss
  - 4147 Champagne Gloss
  - 9238 Brushed Nickel

### Corkboard

- COR1 Natural
- COR2 Dark patterned

### Credenzas:

- Wood**
- V2AA Quarter Cut Grey Ash
  - V2AT Quarter Cut Teak
  - V3AK Rift Cut Oak

### Paint

- Standard specifiable powder coat options:
- 4138 Graphite Gloss
  - 4142 Platinum Gloss
  - 4144 Black Gloss
  - 4147 Champagne Gloss
  - 9238 Brushed Nickel

# Denizen Collection 68"H Secretary

DESIGN WILLIAMS SOREL DESIGN ORIGIN: 2009 UNITED STATES

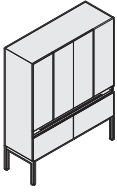

*Tip: Ships ready-to-assemble (legs). Legs come unassembled and are shipped folded at bottom.*

*Tip: Glides have 3/4" adjustment.*

*Tip: If the application is free-standing, the slip-fit hardware kit will not be used. If the application is to adjoin to the bench for slip-fitting, one set of legs will not be used. In both cases, keep the unused piece for future reconfigurations.*

*Tip: Bento box may be ordered separately.*

*Tip: Power strip is ordered separately.*

	Standard Includes	Required to Specify
▶ Need help? Product details, page 66	<ul style="list-style-type: none"> <li>• 68"H secretary, two drawers, bi-fold doors, keyboard tray, interior shelf, and wireway: V3AK Rift Cut Oak veneer</li> <li>- Bi-fold doors have a self-opening feature</li> <li>• Integrated removable wire management covers: wood veneer</li> <li>• Retractable keyboard tray for laptops above drawers</li> <li>• Non-handed metal legs and frame: paint</li> <li>• Letter (front-to-back) and legal- filing (side-to-side)</li> <li>• Integrated pull on drawers</li> <li>• Undermount self-close slides on drawers and keyboard tray</li> <li>• Birch dovetail box drawer interiors</li> <li>• Slip-fit hardware connection to bench</li> <li>• Wire holder in drawer for bento box</li> <li>• Leveling glides</li> </ul>	<ol style="list-style-type: none"> <li>1 Style number</li> <li>2 Wood finish for secretary</li> <li>3 Paint finish for legs and frame</li> <li>4 Cork panel finish for secretary, if selected</li> <li>5 Options, if selected (see below)</li> </ol> <p>▶ See <i>Surface Materials</i>, page 410.</p>

	Options	U.S. Price	Required to Specify
<b>Surface Materials</b>	<b>Top</b>		
	<ul style="list-style-type: none"> <li>• V2AA Quarter Cut Grey Ash</li> <li>• V2AT Quarter Cut Teak</li> </ul>	Prices below Prices below	Specify with <i>grey ash</i> . Specify with <i>teak</i> .
	<b>Legs/frame</b>		
	<ul style="list-style-type: none"> <li>• Brushed nickel</li> </ul>	+\$ 400	Specify with <i>brushed nickel legs/frame</i> .
<b>Storage</b>	<ul style="list-style-type: none"> <li>• Bento box</li> </ul>	+\$ 195	Specify with <i>bento box</i> .
<b>Lock</b>	<ul style="list-style-type: none"> <li>• Three locks in doors and drawers, nickel</li> </ul>	+\$ 375	Specify with <i>three 9211 Nickel locks</i> .
	<ul style="list-style-type: none"> <li>• Three locks in doors and drawers, ember chrome</li> </ul>	+\$ 375	Specify with <i>three 9250 Ember Chrome locks</i> .
	<b>Keying</b>		
	<ul style="list-style-type: none"> <li>• Factory- and field-installed keying units</li> </ul>		▶ See page 394
<b>Interior</b>	<ul style="list-style-type: none"> <li>• Cork panel, interior back</li> </ul>	+\$ 750	Specify with <i>cork panel</i> and select cork color number.
<b>Lighting</b>	<ul style="list-style-type: none"> <li>• Shelf with cubby storage, lighting, and cork panel, interior back</li> </ul>	+\$1000	Specify with <i>storage, lighting, and cork panel</i> and select cork color number.
<b>Related Products</b>	<ul style="list-style-type: none"> <li>• Power strip</li> </ul>		▶ See page 72

Specification Information						
Dimensions			Style Number	U.S. Base Prices		
D	W	H		Finishes:		
				Oak	Ash	Teak

Secretary						
19"	52"	68"	CODS5268	\$7950	\$8189	\$9938



**For Canadian Pricing**  
Multiply U.S. Price by the Canadian price factor.  
▶ See page 1 for details.

# Denizen Collection 56"H Secretary

DESIGN WILLIAMS SOREL DESIGN ORIGIN: 2009 UNITED STATES

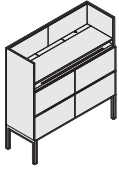

*Tip: Ships ready-to-assemble (legs). Legs come unassembled and are shipped folded at bottom.*

*Tip: Glides have 3/4" adjustment.*

*Tip: If the application is free-standing, the slip-fit hardware kit will not be used. If the application is to adjoin to the bench for slip-fitting, one set of legs will not be used. In both cases, keep the unused piece for future reconfigurations.*

*Tip: Bento box may be ordered separately.*

*Tip: Power strip is ordered separately.*

Standard Includes	Required to Specify
-------------------	---------------------

- |   |  |  |
|---|--|--|
| <ul style="list-style-type: none"> <li>▶ Need help? Product details, page 66</li> </ul> | <ul style="list-style-type: none"> <li>• 56"H secretary, four drawers, keyboard tray and wireway at back: V3AK Rift Cut Oak veneer                             <ul style="list-style-type: none"> <li>- Cork panel back splash: cork</li> </ul> </li> <li>• Integrated removable wire management covers: wood veneer</li> <li>• Retractable keyboard tray for laptops above drawers</li> <li>• Non-handed metal legs and frame: paint</li> <li>• Letter (front-to-back) and legal- filing (side-to-side)</li> <li>• Integrated pull on drawers</li> <li>• Undermount self-close slides on drawers and keyboard tray</li> <li>• Birch dovetail box drawer interiors</li> <li>• Slip-fit hardware connection to bench</li> <li>• Wire holder in drawer for bento box</li> <li>• Leveling glides</li> </ul> | <ol style="list-style-type: none"> <li>1 Style number</li> <li>2 Wood finish for secretary</li> <li>3 Paint finish for legs and frame</li> <li>4 Cork panel finish for secretary</li> <li>5 Options, if selected (see below)</li> </ol> <p>▶ See <i>Surface Materials</i>, page 410.</p> |
|---|--|--|

Options	U.S. Price	Required to Specify
---------	------------	---------------------

<b>Surface Materials</b>	<b>Top</b> <ul style="list-style-type: none"> <li>• V2AA Quarter Cut Grey Ash</li> <li>• V2AT Quarter Cut Teak</li> </ul> <hr/> <b>Legs/frame</b> <ul style="list-style-type: none"> <li>• Brushed nickel</li> </ul>	Prices below Prices below +\$400	Specify with <i>grey ash</i> . Specify with <i>teak</i> . Specify with <i>brushed nickel legs/frame</i> .
<b>Storage</b>	<ul style="list-style-type: none"> <li>• Bento box</li> </ul>	+\$195	Specify with <i>bento box</i> .
<b>Lock</b>	<ul style="list-style-type: none"> <li>• Two locks in drawers, nickel</li> <li>• Two locks in drawers, ember chrome</li> </ul>	+\$250 +\$250	Specify with <i>two 9211 Nickel locks</i> . Specify with <i>two 9250 Ember Chrome locks</i> .
<b>Related Products</b>	<ul style="list-style-type: none"> <li>• Power strip</li> </ul>		▶ See page 394 ▶ See page 72
<b>Keying</b>	<ul style="list-style-type: none"> <li>• Factory- and field-installed keying units</li> </ul>		▶ See page 394

### Specification Information

Dimensions			Style Number	U.S. Base Prices		
D	W	H		Finishes:		
				Oak	Ash	Teak

## Secretary

19"	52"	56"	CODS05256	\$6500	\$6695	\$8125
-----	-----	-----	-----------	--------	--------	--------

**For Canadian Pricing**  
 Multiply U.S. Price by the Canadian price factor.  
 ▶ See page 1 for details.

# Denizen Collection 42"H Secretary

DESIGN WILLIAMS SOREL DESIGN ORIGIN: 2009 UNITED STATES

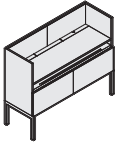

*Tip: Ships ready-to-assemble (legs). Legs come unassembled and are shipped folded at bottom.*

*Tip: Glides have 3/4" adjustment.*

*Tip: If the application is free-standing, the slip-fit hardware kit will not be used. If the application is to adjoin to the bench for slip-fitting, one set of legs will not be used. In both cases, keep the unused piece for future reconfigurations.*

*Tip: Bento box may be ordered separately.*

*Tip: Power strip is ordered separately.*

Standard Includes	Required to Specify
-------------------	---------------------

- |   |  |  |
|---|--|--|
| <ul style="list-style-type: none"> <li>▶ Need help? Product details, page 66</li> </ul> | <ul style="list-style-type: none"> <li>• 42"H secretary, two drawers, keyboard tray and wireway at back: V3AK Rift Cut Oak veneer                             <ul style="list-style-type: none"> <li>- Cork panel back splash: cork</li> </ul> </li> <li>• Integrated removable wire management covers: wood veneer</li> <li>• Retractable keyboard tray for laptops above drawers</li> <li>• Non-handed metal legs and frame: paint</li> <li>• Letter (front-to-back) and legal- filing (side-to-side)</li> <li>• Integrated pull on drawers</li> <li>• Self-close slides on drawers and keyboard tray</li> <li>• Birch dovetail box drawer interiors</li> <li>• Slip-fit hardware connection to bench</li> <li>• Wire holder in drawer for bento box</li> <li>• Leveling glides</li> </ul> | <ol style="list-style-type: none"> <li>1 Style number</li> <li>2 Wood finish for secretary</li> <li>3 Paint finish for legs and frame</li> <li>4 Cork panel finish for secretary</li> <li>5 Options, if selected (see below)</li> </ol> <p>▶ See <i>Surface Materials</i>, page 410.</p> |
|---|--|--|

Options	U.S. Price	Required to Specify
---------	------------	---------------------

<b>Surface Materials</b>	<b>Top</b> <ul style="list-style-type: none"> <li>• V2AA Quarter Cut Grey Ash</li> <li>• V2AT Quarter Cut Teak</li> </ul>	Prices below Prices below	Specify with <i>grey ash</i> . Specify with <i>teak</i> .
	<b>Legs/frame</b> <ul style="list-style-type: none"> <li>• Brushed nickel</li> </ul>	+\$400	Specify with <i>brushed nickel legs/frame</i> .
<b>Storage</b>	<ul style="list-style-type: none"> <li>• Bento box</li> </ul>	+\$195	Specify with <i>bento box</i> .
<b>Lock</b>	<ul style="list-style-type: none"> <li>• One lock in drawer, nickel</li> <li>• One lock in drawer, ember chrome</li> </ul>	+\$125 +\$125	Specify with <i>one 9211 Nickel lock</i> . Specify with <i>one 9250 Ember Chrome lock</i> .
	<b>Keying</b> <ul style="list-style-type: none"> <li>• Factory- and field-installed keying units</li> </ul>		▶ See page 394
<b>Related Products</b>	<ul style="list-style-type: none"> <li>• Power strip</li> </ul>		▶ See page 72

### Specification Information

Dimensions			Style Number	U.S. Base Prices		
D	W	H		Finishes:		
				Oak	Ash	Teak

## Secretary

19"	52"	42"	CODSO5242	\$5000	\$5150	\$6250
-----	-----	-----	-----------	--------	--------	--------



**For Canadian Pricing**  
 Multiply U.S. Price by the Canadian price factor.  
 ▶ See page 1 for details.

# Denizen Collection Credenza

DESIGN WILLIAMS SOREL DESIGN ORIGIN: 2009 UNITED STATES

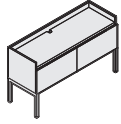

*Tip: Ships ready-to-assemble (legs). Legs come unassembled and are shipped folded at bottom.*

*Tip: Glides have 3/4" adjustment.*

*Tip: If the application is free-standing, the slip-fit hardware kit will not be used. If the application is to adjoin to the bench for slip-fitting, one set of legs will not be used. In both cases, keep the unused piece for future reconfigurations.*

*Tip: Bento box may be ordered separately.*

Standard Includes	Required to Specify
-------------------	---------------------

- |   |  |  |
|---|--|--|
| <ul style="list-style-type: none"> <li>▶ Need help? Product details, page 66</li> </ul> | <ul style="list-style-type: none"> <li>• Credenza, two drawers, wireway grommet at back and top piling surface with backsplash V3AK Rift Cut Oak veneer</li> <li>• Non-handed metal legs and frame: paint</li> <li>• Letter (front-to-back) and legal- filing (side-to-side)</li> <li>• Integrated pull on drawers</li> <li>• Undermount self-close slides on drawers</li> <li>• Birch dovetail box drawer interiors</li> <li>• Slip-fit hardware connection to bench</li> <li>• Wire holder in drawer for bento box</li> <li>• Leveling glides</li> </ul> | <ol style="list-style-type: none"> <li>1 Style number</li> <li>2 Wood finish for credenza</li> <li>3 Paint finish for legs and frame</li> <li>4 Options, if selected (see below)</li> </ol> <p>▶ See <i>Surface Materials</i>, page 410.</p> |
|---|--|--|

Options	U.S. Price	Required to Specify
---------	------------	---------------------

<b>Surface Materials</b>	<b>Top</b> <ul style="list-style-type: none"> <li>• V2AA Quarter Cut Grey Ash</li> <li>• V2AT Quarter Cut Teak</li> </ul>	Prices below Prices below	Specify with <i>grey ash</i> . Specify with <i>teak</i> .
	<b>Legs/frame</b> <ul style="list-style-type: none"> <li>• Brushed nickel</li> </ul>	+\$400	Specify with <i>brushed nickel legs/frame</i> .
<b>Storage</b>	<ul style="list-style-type: none"> <li>• Bento box</li> </ul>	+\$195	Specify with <i>bento box</i> .
<b>Lock</b>	<ul style="list-style-type: none"> <li>• One lock in drawer, nickel</li> <li>• One lock in drawer, ember chrome</li> </ul>	+\$125 +\$125	Specify with <i>one 9211 Nickel lock</i> . Specify with <i>one 9250 Ember Chrome lock</i> .
	<b>Keying</b> <ul style="list-style-type: none"> <li>• Factory- and field-installed keying units</li> </ul>		▶ See page 394

### Specification Information

Dimensions			Style Number	U.S. Base Prices		
D	W	H		Finishes:		
				Oak	Ash	Teak

## Credenza

19"	52"	30"	CODC5230	\$3900	\$4017	\$4875
-----	-----	-----	----------	--------	--------	--------



**For Canadian Pricing**  
 Multiply U.S. Price by the Canadian price factor.  
 ▶ See page 1 for details.

# Denizen Collection Accessories

DESIGN WILLIAMS SOREL DESIGN ORIGIN: 2009 UNITED STATES

Standard Includes	Required to Specify
-------------------	---------------------

- |  |  |
|--|--|
| <ul style="list-style-type: none"> <li>• Bento box: white solid with red leather lining                             <ul style="list-style-type: none"> <li>- Fits in file drawers, cubby shelves, and overhead cubby area</li> </ul> </li> <li>• Power block, 3 power outlets: black plastic                             <ul style="list-style-type: none"> <li>- Metal bracket attachment hardware: black matte paint</li> </ul> </li> <li>• 6' power cord</li> <li>• Data block, 3 data ports: black plastic                             <ul style="list-style-type: none"> <li>- Metal bracket attachment hardware: black matte paint</li> </ul> </li> <li>• Power strip, 6 power outlets with a 15' cord and 3 prong plug: metal</li> <li>• Replacement light bulbs, 2-pack</li> </ul> | Style number<br>▶ See <i>Surface Materials</i> , page 410. |
|--|--|

Specification Information				
---------------------------	--	--	--	--

Dimensions	Style	U.S.		
D    W    H	Number	Price		

### Bento Box

11"	9 <sup>5</sup> / <sub>8</sub> "	2 <sup>1</sup> / <sub>4</sub> "	CODBENTO	\$195
-----	---------------------------------	---------------------------------	----------	-------

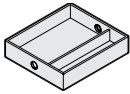

### Power Block

Three Power Outlets

			CODPWR	\$185
--	--	--	--------	-------

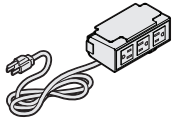

### Data Block

Three Data Ports

			CODDATA	\$125
--	--	--	---------	-------



### Power Strip

Six Power Outlets

			793330	\$192
--	--	--	--------	-------

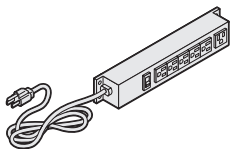

### Light Bulbs

Replacement Pack of Two Bulbs

			CODBULB2	\$ 10
--	--	--	----------	-------



**For Canadian Pricing**  
 Multiply U.S. Price by the  
 Canadian price factor.  
 ▶ See page 1 for details.